

PHILIPS

HD9257

User manual

TABLE OF CONTENTS

Important	3
Introduction	6
General description	6
Before first use	8
Preparing for use	8
Using the appliance	8
Food table	8
Airfrying	10
Choosing the keep warm mode	13
Cooking with a preset	14
Changing to another preset	16
Making home-made fries	17
Cleaning	18
Cleaning table	19
Storage	20
Recycling	20
Warranty and support	20
Troubleshooting	20

Important

Read this important information carefully before you use the appliance and save it for future reference.



Danger

- Do not place the appliance on or near a hot gas stove or all kinds of electric stove and electric cooking plates, or in a heated oven.
- Always put the ingredients to be fried in the basket, to prevent them from coming into contact with the heating elements.
- Do not cover the air inlet and the air outlet openings while the appliance is operating.
- Do not fill the pan with oil as this may cause a fire hazard.
- Never immerse the appliance in water or any other liquid, nor rinse it under the tap.
- Do not let any water or other liquid enter the appliance to prevent electric shock.
- Never put any amount of food that exceeds the maximum level indicated in the basket.
- Never touch the inside of the appliance while it is operating.
- Always make sure the heater is free and no food is stuck in heater.
- Do not use the appliance if the plug, the mains cord or the appliance itself is damaged.

Warning

- If the supply cord is damaged, it must be replaced by Philips, its service agent or similarly qualified persons in order to avoid a hazard.
- Only connect the appliance to an earthed wall socket. Always make sure that the plug is inserted into the wall socket properly.
- This appliance is not intended to be operated by means of an external timer or a separate remote-control system.
- The accessible surfaces may become hot during use.
- Children should be supervised to ensure that they do not play with the appliance.
- This appliance is not intended for use by persons (including children) with reduced physical, sensory or mental capabilities, or lack of experience and knowledge, unless they have been given supervision or instruction concerning use of the appliance by a person responsible for their safety.
- Cleaning and user maintenance shall not be made by children without supervision.
- Do not place the appliance against a wall or against other appliances. Leave at least 10 cm free space at the back, on both sides and above the appliance. Do not place anything on top of the appliance.



- During hot air frying, hot steam is released through the air outlet openings. Keep your hands and face at a safe distance from the steam and from the air outlet openings. Also, be careful of hot steam and air when you remove the pan from the appliance.
- Never use light ingredients or baking paper in the appliance.
- Storage of potatoes: The temperature shall be appropriate to the potato variety stored and it shall be above 6 °C to minimize the risk of acrylamide exposure in the prepared foodstuff.
- Never fill the pan with oil.
- This appliance is designed to be used at ambient temperatures between 5°C and 40°C.
- Check if the voltage indicated on the appliance corresponds to the local mains voltage before you connect the appliance.
- Keep the mains cord away from hot surfaces.
- Do not place the appliance on or near combustible materials such as a tablecloth or curtain.
- Do not use the appliance for any other purpose than described in this manual and use only original Philips-accessories.
- Do not let the appliance operate unattended.
- The pan, basket and fat reducer becomes hot during and after use of the appliance, always handle carefully.
- Thoroughly clean the parts that come into contact with food before you use the appliance for the first time. Refer to the instructions in the manual.

Caution

- This appliance is intended for normal household use only. It is not intended for use in environments such as staff kitchens of shops, offices, farms or other work environments. Nor is it intended to be used by clients in hotels, motels, bed and breakfasts and other residential environments.
- Always return the appliance to a service centre authorised by Philips for examination or repair. Do not attempt to repair the appliance yourself, otherwise the guarantee becomes invalid.
- If the appliance is used improperly or for professional or semi-professional purposes or if it is not used according to the instructions in the user manual, the guarantee becomes invalid and Philips refuses any liability for damage caused.
- Always place and use the appliance on a dry, stable, level and horizontal surface.
- Always unplug the appliance after use.
- Let the appliance cool down for approx. 30 minutes before you handle or clean it.
- Make sure the ingredients prepared in this appliance come out golden-yellow instead of dark or brown. Remove burnt remnants. Do not fry fresh potatoes at a temperature above 180°C (to minimise the production of acrylamide).

- Be careful when cleaning the upper area of the cooking chamber: Hot heating element, edge of Metal parts.
- Always make sure that the food is fully cooked in the Airfryer.
- Always make sure that you have the control over your Airfryer.
- When cooking fatty food, the Airfryer could emit smoke.

Electromagnetic fields (EMF)

This appliance complies with the applicable standards and regulations regarding exposure to electromagnetic fields.

Automatic shut-off

This appliance is equipped with an automatic shut-off function. If you do not press a button within 20 minutes, the appliance switches off automatically. To switch off the appliance manually, press the power On/off button.

Introduction

Congratulations on your purchase and welcome to Philips!
To fully benefit from the support that Philips offers, register your product at www.philips.com/welcome.

Philips Airfryer is the only Airfryer with unique Rapid Air technology to fry your favorite foods with little or no added oil and up to 90% less fat.

Philips Rapid Air technology cooks food all around as well as our starfish design for perfect results from your first bite to your last. You can now enjoy perfectly cooked fried food—crispy on the outside tender on the inside—Fry, grill, roast and bake to prepare a variety of tasty dishes in a healthy, fast and easy way.

For more inspiration, recipes and information about the Airfryer, visit www.philips.com/kitchen or download the free NutriU App* for IOS® or Android™.

*The NutriU app may not be available in your country.

In this case please access your local Philips website for inspiration.

General description

- 1 Control panel
 - A Temperature down button
 - B Temperature up button
 - C Menu button
 - D Light button
 - E Start/pause button
 - F On/off button
 - G Time decrease button
 - H Time increase button
- 2 See-through window
- 3 Basket
- 4 Basket release button
- 5 Basket handle
- 6 Pan
- 7 Air inlet
- 8 Air outlets
- 9 Power cord

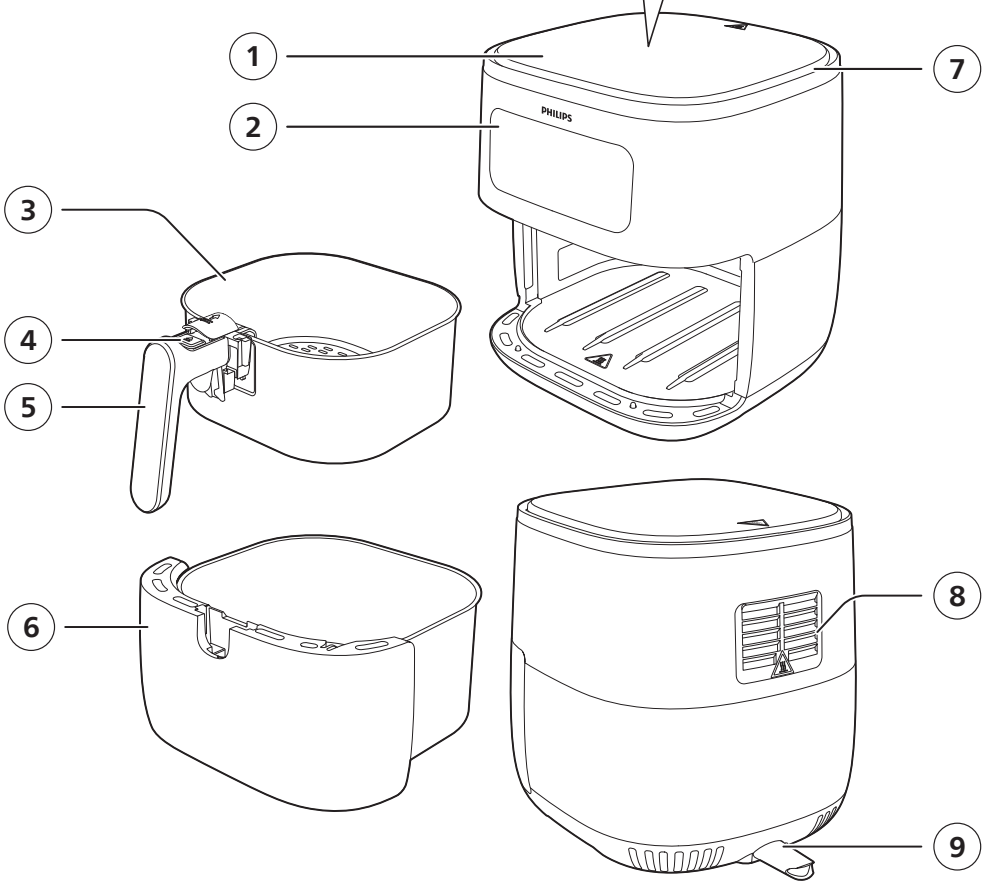
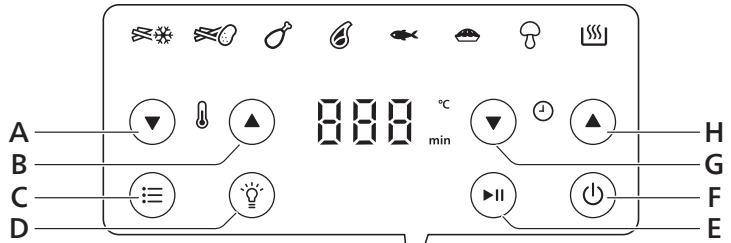

Before first use

- 1 Remove all packing material.
- 2 Remove any stickers or labels (if available) from the appliance.
- 3 Thoroughly clean the appliance before first use, as indicated in the cleaning chapter.

Preparing for use

- 1 Place the appliance on a stable, horizontal, level and heat-resistant surface.

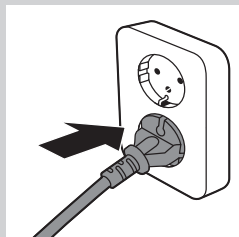

Note

- Do not put anything on top or on the sides of the appliance. This could disrupt the airflow and affect the frying result.
- Do not place the operating appliance near or underneath objects that could be damaged by steam, such as walls and cupboard.
- Leave the rubber plug in the pan. Do not remove it before cooking.

Using the appliance

Food table

The table below helps you select the basic settings for the types of food you want to prepare.

Note

- Keep in mind that these settings are suggestions. As ingredients differ in origin, size, shape as well as brand, we cannot guarantee the best setting for your ingredients.
- When preparing larger amount of food (e.g. fries, prawns, drumsticks, frozen snacks), shake, turn, or stir the ingredients in the basket 2 to 3 times in order to achieve a consistent result.

Ingredients	Min.– max. amount	Time (min)	Temperature	Note
Thin frozen fries (7x7 mm/0.3x0.3 in)	200-800 g / 7-28 oz	17-38	180°C/350°F	• Shake, turn or stir 2-3 times in between
Homemade fries (10x10 mm/0.4x0.4 in thick)	200-800 g / 7-28 oz	25-45	180°C/350°F	• Shake, turn or stir 2-3 times in between
Frozen chicken nuggets	200-600 g / 7-21 oz	9-23	200°C/400°F	• Shake, turn or stir halfway

Ingredients	Min.– max. amount	Time (min)	Temperature	Note
Frozen spring rolls	200-600 g / 7-21 oz	9-23	200°C/400°F	• Shake, turn or stir halfway
Hamburger (around 150 g/5 oz)	1-5 patties	16-21	200°C/400°F	
Meat loaf	1000 g / 35 oz	65-70	150°C/300°F	• Use the baking accessory
Meat chops without bone (around 150 g/5 oz)	1-4 chops	15-20	200°C/400°F	• Shake, turn or stir halfway
Thin sausages (around 50 g/1.8 oz)	2-10 pieces	11-15	200°C/400°F	• Shake, turn or stir halfway
Chicken drumsticks (around 125 g/4.5 oz)	2-8 pieces	20-27	180°C/350°F	• Shake, turn or stir halfway
Chicken breast (around 160 g/6 oz)	1-5 pieces	15-25	180°C/350°F	
Whole chicken	1000 g/35 oz	60-70	180°C/350°F	
Whole fish (around 300-400 g/11-14 oz)	1-2 fish	20-25	200°C/400°F	
Fish filet (around 200 g/7 oz)	1-5 (1 layer)	25-32	160°C / 325°F	
Mixed vegetables (roughly chopped)	200-800 g/7-28 oz	14-23	180°C/350°F	• Set the cooking time according to your own taste • Shake, turn or stir halfway
Muffins (around 50 g/1.8 oz)	1-9	13-15	180°C/350°F	• Use the Muffin cups
Cake	500 g/18 oz	40-45	160°C/325°F	• Use a cake pan
Pre-baked bread/rolls (around 60 g/ 2 oz)	1-6 pieces	6-8	200°C/400°F	
Homemade bread	800 g / 28 oz	45-55	150°C/300°F	• Use the baking accessory • The shape should be as flat as possible to avoid that the bread touches the heating element when rising.

Airfrying

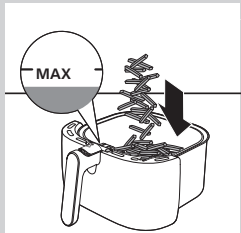
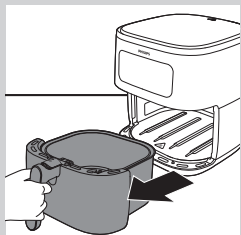
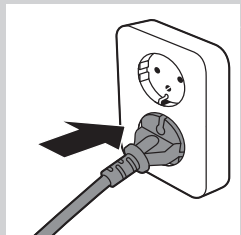
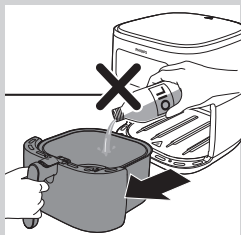

! Caution

- This is an Airfryer that works on hot air. Do not fill the pan with oil, frying fat or any other liquid.
- Do not touch hot surfaces. Use handles or knobs. Handle the hot pan with oven-safe gloves.
- This appliance is for household use only.
- This appliance may produce some smoke when you use it for the first time. This is normal.
- Preheating of the appliance is not necessary.

1 Put the plug in the wall outlet.

2 Remove the pan with the basket from the appliance by pulling the handle.

3 Put the ingredients in the basket.

≡ Note

- The Airfryer can prepare a large range of ingredients. Consult the 'Food table' for the right quantities and approximate cooking times.
- Do not exceed the amount indicated in the 'Food table' section or overfill the basket beyond the 'MAX' indication as this could affect the quality of the end result.
- If you want to prepare different ingredients at the same time, make sure you check the suggested cooking time required for the different ingredients before you start to cook them simultaneously.

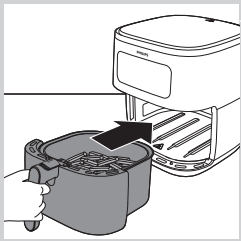

4 Put the pan with the basket back into the Airfryer.



Caution

- Never use the pan without the basket in it.
- Do not touch the pan or the basket during and for some time after use, as they get very hot.

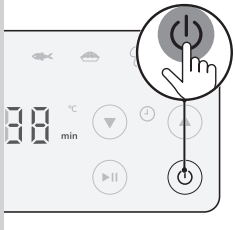

5 Press the power On/off button to switch on the appliance.

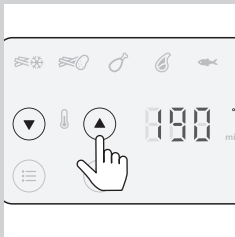

6 Press the temperature up or down button to choose the needed temperature.

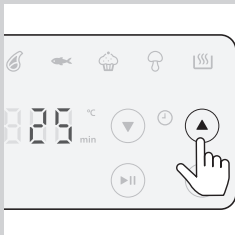

7 Press the time up button to choose the needed time.

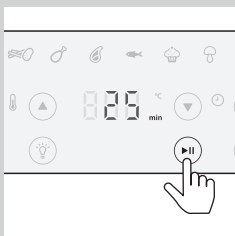

8 Press the start/pause button to start the cooking process.



Note

- During cooking the temperature and time are shown alternately.
- The last cooking minute counts down in seconds.
- Refer to the food table with basic cooking settings for different types of food.
- After the cooking process starts, the light inside the device turns on automatically. The light turns off after a few minutes. You can turn it on again during cooking by pressing the light button.

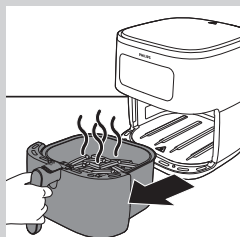
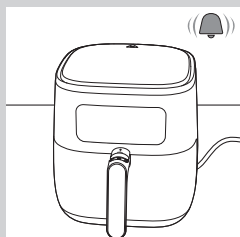
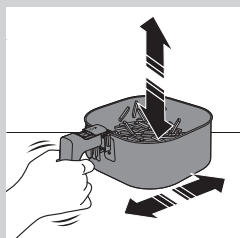

Tip

- During cooking, if you want to change the cooking time or temperature, press the corresponding up or down button at any time to do so.
- To pause the cooking process, press the start/pause button. To resume the cooking process, press the start/pause button again to continue the cooking process.
- The device is automatically in pause mode when you pull out the pan and the basket. The cooking process continues when the pan and the basket are put in the appliance again.

Note

- If you do not set the required cooking time within 30 minutes, the appliance automatically shuts off for safety reasons.
- Some ingredients require shaking or turning halfway through the cooking time (see 'Food table'). To shake the ingredients, pull out the pan with the basket, place it on a heat resistant work top, slide the lid and press the basket release button to remove the basket and shake the basket over the sink. Then put the basket into the pan, and slide them back into the appliance.
- If you set the timer to the half of the cooking time and you hear the timer bell it is time to shake or turn the ingredients. Be sure to reset the timer to the remaining cooking time.

9 When you hear the timer bell, the cooking time has elapsed.

Note

- You can stop the cooking process manually. To do this, press the start/pause button.
- When the cooking process is finished, the light inside the device turns on automatically.

10 Pull out the pan and check if the ingredients are ready.

Caution

- **The Airfryer pan is hot after the cooking process. Always place it on a heat resistant work top (eg. trivet, etc.) when you remove the pan from the device.**

Note

- If the ingredients are not ready yet, simply slide the pan back into the Airfryer by the handle and add a few extra minutes to the set time.

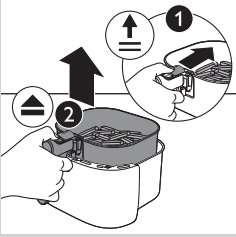

11 To remove small ingredients (e.g. fries), lift the basket out of the pan by sliding the lid first, and then pressing the basket release button.

! Caution

- After the cooking process, the pan, the basket, the interior housing and the ingredients are hot. Depending on the type of ingredients in the Airfryer, steam may escape from the pan.

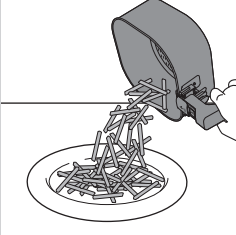

12 Empty the basket contents into a bowl or onto a plate. Always remove the basket from the pan to empty contents as hot oil may be in the bottom of the pan.

≡ Note

- To remove large or fragile ingredients, use a pair of tongs to lift out the ingredients.
- Excess oil or rendered fat from the ingredients is collected on the bottom of the pan.
- Depending on the type of ingredients cooking, you may want to carefully pour off any excess oil or rendered fat from the pan after each batch or before shaking or replacing the basket in the pan. Place the basket on a heat-resistant surface. Wear oven-safe gloves to pour off excess oil or rendered fat. Return the basket into the pan.

When a batch of ingredients is ready, the Airfryer is instantly ready for preparing another batch.

≡ Note

- Repeat steps 3 to 12 if you want to prepare another batch.

Choosing the keep warm mode

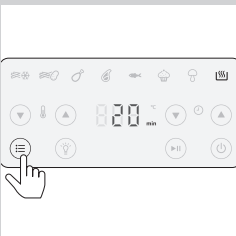

1 Press the menu button as often as the keep warm icon is blinking.

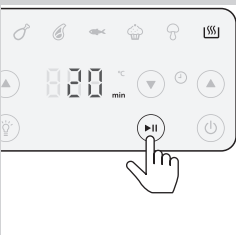

2 Press the start/pause button to start the keep warm mode.

Note

- The keep warm timer is set to 30 minutes. To change the keep warm time (1-60 minutes), press the time up or down button. The time will be confirmed automatically.
- The temperature cannot be changed in keep warm mode.

3 To pause the keep warm mode, press the start/pause button. To resume the keep warm mode, press the start/pause button again.

4 To exit the keep warm mode, press the On/off button.

Tip

- If food like French fries loses too much crispness during the keep warm mode, either shorten the keep warm time by switching off the appliance earlier or crisp them up for 2-3 minutes at the temperature of 180°C/350°F.

Note

- During the keep warm mode, the fan and heater inside of the appliance turn on from time to time.
- The keep warm mode is designed to keep your food warm immediately after it is cooked in the Airfryer. It is not meant for reheating.

Cooking with a preset







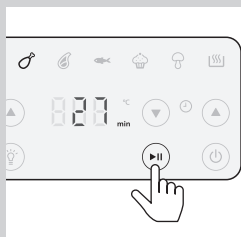

- 1 Follow steps 1 to 5 in chapter "Airfrying".
- 2 Press the Menu button. The frozen snacks icon is blinking. Press the Menu button as often as your needed preset is blinking.

- 3 Start the cooking process by pressing the start/pause button.

Note

- In the following table you can find more information about the presets.



Preset	Preset time (min)	Preset temperature	Weight (Max.)	Information
 Frozen potato based snacks	38	180°C/ 350°F	800 g/28 oz	<ul style="list-style-type: none"> • Potato based frozen snacks like frozen French fries, potato wedges, criss-cross fries etc. • Shake, turn or stir 2-3 times in between
 Fresh fries	45	180°C/ 350°F	800 g/28 oz	<ul style="list-style-type: none"> • Use mealy potatoes • 10x10mm / 0.4x0.4 in thick cut • Soak 30 minutes in water, dry then add ¼ to 1 tbsp of oil • Shake, turn or stir 2-3 times in between
 Chicken drumsticks	27	180°C/ 350°F	1000 g/35 oz	<ul style="list-style-type: none"> • Up to 8 chicken drumsticks • Shake, turn or stir in between
 Whole fish around 300 g/11 oz	25	200°C/ 400°F	600 g/21 oz	
 Cake	45	160°C/ 325°F	500 g/18 oz	<ul style="list-style-type: none"> • Use the XL baking accessory (199 x 189 x 80 mm)
 Meat chops	25	200°C/ 400°F	600 g/21 oz	<ul style="list-style-type: none"> • Up to 4 meat chops without bone
 Mixed vegetables	23	180°C/ 350°F	800 g/28 oz	<ul style="list-style-type: none"> • Roughly chopped • Use the XL baking accessory
 Keep warm	30	80°C/ 175°F	N/A	<ul style="list-style-type: none"> • Temperature cannot be adjusted

Changing to another preset

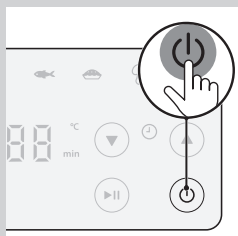

- 1 During the cooking process short press the power On/off button to stop the cooking process. The device is then in stand-by mode.

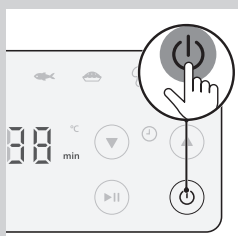

- 2 Press the On/off button again to turn on the device.



- 3 Press the menu button as often as your needed preset is blinking.



- 4 Press the start/pause button to start the cooking process.



Tip

- To switch to manual mode while in a preset, press the menu button repeatedly until you are in the manual mode.

Making home-made fries

To make great home-made fries in the Airfryer:

- Choose a potato variety suitable for making fries, e.g. fresh, (slightly) floury potatoes.
- It is best to air fry the fries in portions of up to 800 g/28 oz for an even result. Larger fries tend to be less crispy than smaller fries.

- 1 Peel the potatoes and cut into sticks (10 x 10 mm/0.4 x 0.4 in thick).**
- 2 Soak the potato sticks in a bowl of water for at least 30 minutes.**
- 3 Empty the bowl and dry the potato sticks with a dish towel or paper towel.**
- 4 Pour one tablespoon of cooking oil into the bowl, put the sticks in the bowl and mix until the sticks are coated with oil.**
- 5 Remove the sticks from the bowl with your fingers or a slotted kitchen utensil so excess oil remains in the bowl.**



Note

- Do not tilt the bowl to pour all the sticks in the basket at once to prevent excess oil from going into the pan.

- 6 Put the sticks into the basket.**
- 7 Fry the potato sticks and shake the basket 2-3 times during cooking.**

Cleaning

Warning

- Let the basket, the pan, and the inside of the appliance cool down completely before you start cleaning.
- The pan, the basket, and the inside of the appliance have a non-stick coating. Do not use metal kitchen utensils or abrasive cleaning materials as this may damage the non-stick coating.

Clean the appliance after every use. Remove oil and fat from the bottom of the pan and on the see-through window after every use.

- 1 Press the power On/off button to switch off the appliance, remove the plug from the wall outlet and let the appliance cool down.

Tip

- Remove the pan and the basket to let the Airfryer cool down more quickly.

- 2 Dispose of rendered fat or oil from the bottom of the pan.
- 3 Clean the pan and the basket in a dishwasher. You can also clean them with hot water, dishwashing liquid and a non-abrasive sponge (see 'Cleaning table').

Note

- Put the pan with the rubber plug in the dishwasher. Do not remove the rubber plug before cleaning.

Tip

- If food residues stuck to the pan or the basket, you can soak them in hot water and dishwashing liquid for 10–15 minutes. Soaking loosens the food residues and makes it easier to remove. Make sure you use a dishwashing liquid that can dissolve oil and grease. If there are grease stains on the pan or the basket and you have not been able to remove them with hot water and dishwashing liquid, use a liquid degreaser.
- If necessary, food residues stuck to the heating element can be removed with a soft to medium bristle brush. Do not use a steel wire brush or a hard bristle brush, as this might damage the coating on the heating element.

- 4 Wipe the outside of the appliance with a moist cloth.

Note

- Make sure no moisture remains on the control panel. Dry the control panel with a cloth after you have cleaned it.

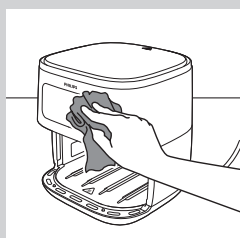
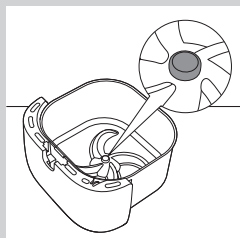

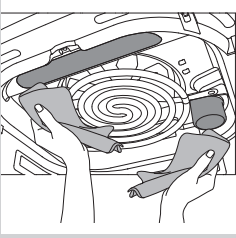

5 After the appliance has cooled down, clean the inside of the see-through window and lamp with a moist cloth after every use.

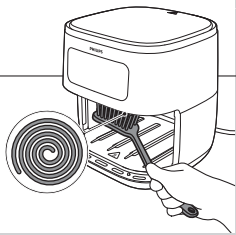



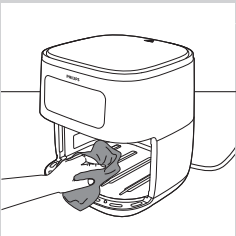



6 Clean the heating element with a cleaning brush to remove any food residues.



7 Clean the inside of the appliance with hot water and a non-abrasive sponge.

Cleaning table

				
	✓	✓	✗	✓
	✓	✓	✗	✓
	✗	✗	✗	✓

Storage

- 1 Unplug the appliance and let it cool down.
- 2 Make sure all parts are clean and dry before storing.

Note

- Always hold the Airfryer horizontally when you carry it. Make sure that you also hold the pan on the front part of the appliance as the pan with the basket can slide out of the appliance if accidentally tilted downwards. This can lead to damaging of these parts.
- Always make sure that the removable parts of the Airfryer are fixed before you carry and/or store it.

Recycling

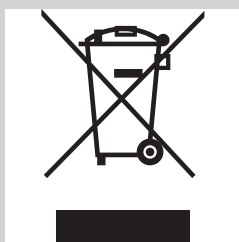

- This symbol means that this product shall not be disposed of with normal household waste (2012/19/EU).
- Follow your country's rules for the separate collection of electrical and electronic products. Correct disposal helps prevent negative consequences for the environment and human health.

Warranty and support

Versuni offers a two-year warranty after purchase on this product. This warranty is not valid if a defect is due to incorrect use or poor maintenance. Our warranty does not affect your rights under law as a consumer. For more information or for invoking the warranty, please visit our website www.philips.com/support.

Troubleshooting

This chapter summarizes the most common problems you could encounter with the appliance. If you are unable to solve the problem with the information below, visit www.philips.com/support for a list of frequently asked questions or contact the Consumer Care Center in your country.

Problem	Possible cause	Solution
The outside of the appliance becomes hot during use.	The heat inside radiates to the outside walls.	This is normal. All handles and knobs that you need to touch during use stay cool enough to touch.

Problem	Possible cause	Solution
		<p>The pan, the basket, and the inside of the appliance always become hot when the appliance is switched on to ensure the food is properly cooked. These parts are always too hot to touch.</p>
		<p>If you leave the appliance switched on for a longer time, some areas get too hot to touch. These areas are marked on the appliance with the following icon:</p>  <p>As long as you are aware of the hot areas and avoid touching them, the appliance is completely safe to use.</p>
<p>My home-made fries do not turn out as I expected.</p>	<p>You did not use the right potato type.</p>	<p>To get the best results, use fresh floury potatoes. If you need to store the potatoes, do not store them in a cold environment like in a fridge. Choose potatoes whose package states that they are suitable for frying.</p>
	<p>The amount of ingredients in the basket is too big.</p>	<p>Follow the instructions in this user manual to prepare home-made fries on page 17.</p>
	<p>Certain types of ingredients need to be shaken halfway through the cooking time.</p>	<p>Follow the instructions in this user manual to prepare home-made fries on page 17.</p>
<p>The Airfryer does not switch on.</p>	<p>The appliance is not plugged in.</p>	<p>Check if the plug is inserted in the wall outlet properly.</p>
	<p>Several appliances are connected to one outlet.</p>	<p>The Airfryer has a high wattage. Try a different outlet and check the fuses.</p>
<p>I see some peeling off spots inside my Airfryer.</p>	<p>Some small spots can appear inside the pan of the Airfryer due to the incidental touching or scratching of the coating (e.g. during cleaning with harsh cleaning tools and/or while inserting the basket).</p>	<p>You can prevent damage by lowering the basket into the pan properly. If you insert the basket at an angle, its side may knock against the wall of the pan, causing small pieces of coating to chip off. If this occurs, please be informed that this is not harmful as all materials used are food-safe.</p>
<p>White smoke comes out of the appliance.</p>	<p>You are cooking fatty ingredients.</p>	<p>Carefully pour off any excess oil or fat from the pan and then continue cooking.</p>

22 ENGLISH

Problem	Possible cause	Solution
	The pan still contains greasy residues from previous use.	White smoke is caused by greasy residues heating up in the pan. Always clean the pan and the basket thoroughly after every use.
	Breading or coating did not adhere properly to the food.	Tiny pieces of airborne breading can cause white smoke. Firmly press breading or coating to food to ensure it sticks.
	Marinade, liquid or meat juices are splattering in the rendered fat or grease.	Pat food dry before placing it in the basket.
The screen on the Airfryer shows "E1".	The device is broken/defect.	Call the Philips service hot line or contact the Consumer Care Center in your country.
	Your Airfryer might be stored in a place where it is too cold.	If your device was stored at a low ambient temperature, let it warm up to room temperature for at least 15 minutes before you plug it in again. If your display still shows "E1", call the Philips service hot line or contact the Consumer Care Center in your country.



PHILIPS and the Philips Shield Emblem are registered trademarks of Koninklijke Philips N.V. and are used under license.

This product has been manufactured by and is sold under the responsibility of Versuni Holding B.V., and Versuni Holding B.V. is the warrantor in relation to this product.

2023 © Versuni Holding B.V.