

# Quick Installation Guide

## Wireless Access Point

**Setup with videos**  
Visit <https://www.tp-link.com/support/setup-video/?type=smb> or scan the QR code to search for the setup video of your product model.

Note: EAP650 is used as an example throughout the Guide. Images may differ from your actual product.  
©2024 TP-Link 7106511257 REV1.5.2

## 1 Hardware Overview

### Front Panel

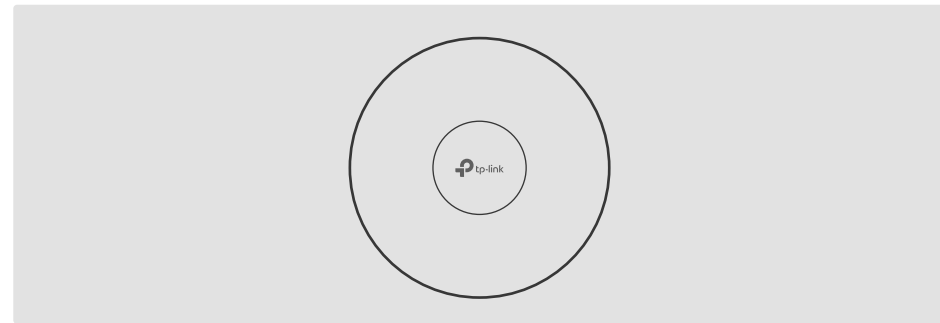

### LED Indicator

**Blue On:** Working normally/initializing. For EAPs with dual-color LED: Normal power supply

**Orange On:** For EAPs with dual-color LED: Low power supply

**Off:** Working abnormally/Power off/LED is turned off.

**Flash:**

- **Flash twice:** Initialization is completed.
- **Flash quickly:** The EAP is resetting, or the Omada controller is locating the device\*.
- **Flash once per second:** The EAP is upgrading.
- **Flash Slowly:** The EAP is in the isolated state.

\* When the Locate feature is activated in the Omada controller, the LED flashes quickly to locate and identify the device. The LED will flash for 10 minutes. You can disable the feature manually to stop it from flashing.

### Rear Panel

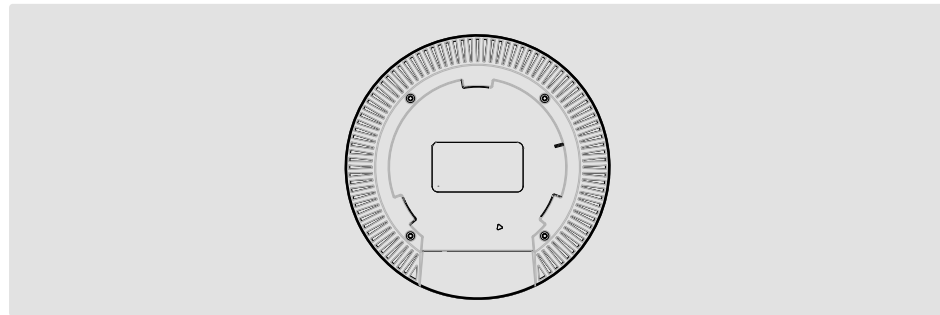

### RESET

With the device powered on, press and hold the button for about 5 seconds until the LED flashes quickly. Then release the button. The device will restore to factory default settings.

### Ethernet Port: ETH (PoE)

The port is used to connect to a router or a switch to transmit data, or to a PSE (Power Sourcing Equipment), such as a PoE switch, for both data transmission and Power over Ethernet (PoE) through Ethernet cable.

Note: For EAPs with 10Gbps port, if you use a CAT5E cable, the 10Gbps link of the Ethernet port is less than 55m. To achieve a longer transmission distance, use a shielded CAT6A cable.

### Power Port

Plug one end of the power adapter to this port and the other end to a standard electrical wall outlet to power the EAP.

Note: Power adapter is not included in the package contents of certain models. For details, refer to the product specifications or datasheet. For power supply specifications, refer to the product label.

## 2 Hardware Installation

The EAP can be mounted to the ceiling, the wall, or in a junction box, using the screws in the package. Choose the appropriate mounting and installation steps below.

Note: This product requires heat dissipation through the metal bracket during use, please be careful not to touch the metal bracket in the heat dissipation.

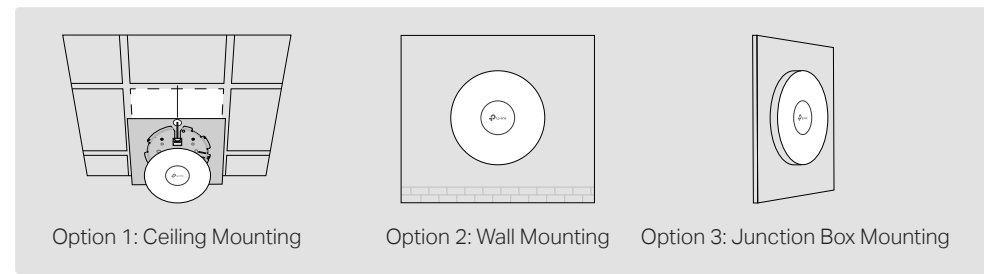

### Option 1: Ceiling Mounting

Note: Make sure that the ceiling tile is larger than the EAP.

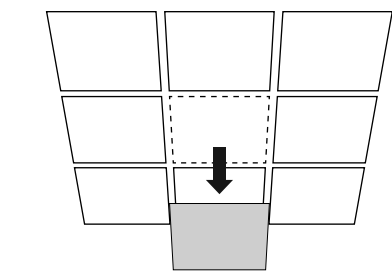
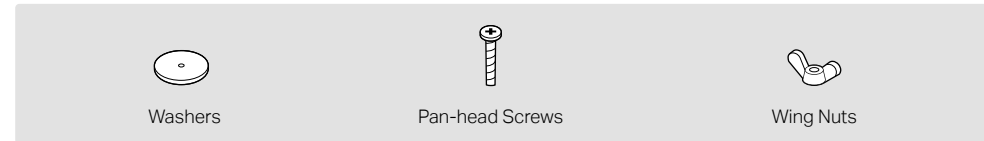

1 Remove the ceiling tile.

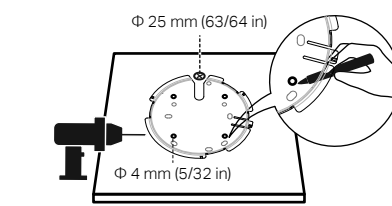

2 Place the mounting bracket in the center of the ceiling tile. Mark positions for the screw holes and a location for the Ethernet cable hole. Drill holes for the screws and a hole for the Ethernet cable at the marked positions.

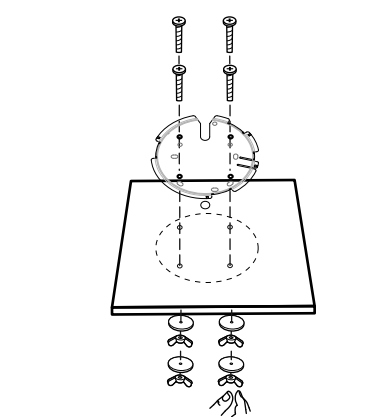

3 Secure the mounting bracket to the ceiling tile using pan-head screws, washers, and wing nuts, as shown on the left.

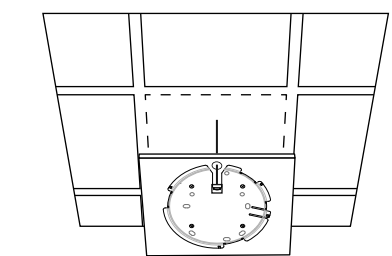

4 Feed the Ethernet cable through the hole and set the ceiling tile back into place.

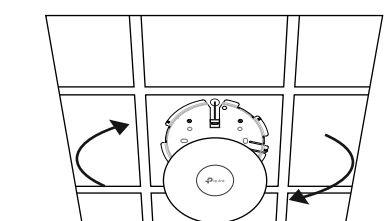

5 Connect the Ethernet cable to the Ethernet port. Please pay attention to the triangle sign. Attach the EAP to the mounting bracket, then rotate it until it locks into place, as shown on the left.

### Option 2: Wall Mounting

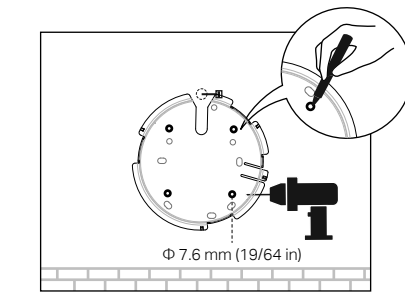
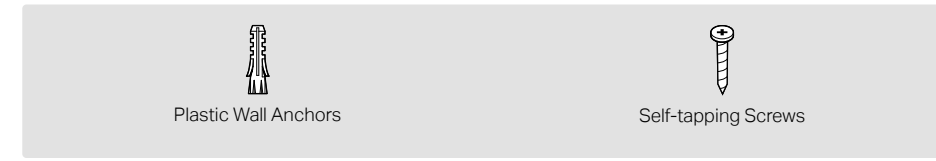

1 If your Ethernet cable feeds through the wall, position the mounting bracket below the cable hole. Mark positions for the screw holes and drill holes at the marked positions.

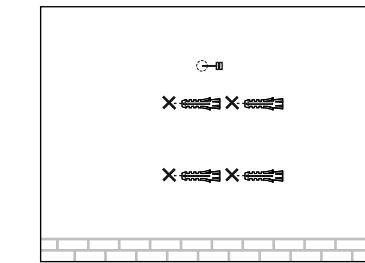

2 Insert the plastic wall anchors into the holes.

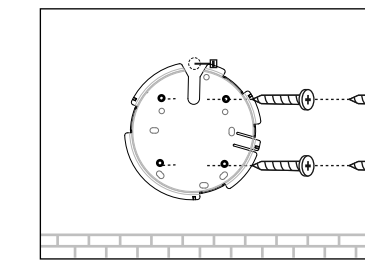

3 Secure the mounting bracket to the wall by driving the self-tapping screws into the anchors. Make sure that the shoulders of the mounting bracket are on the outside.

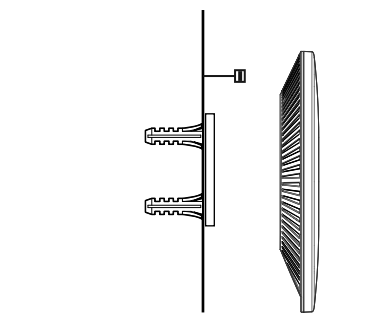

4 Connect the Ethernet cable to the Ethernet port on the EAP.

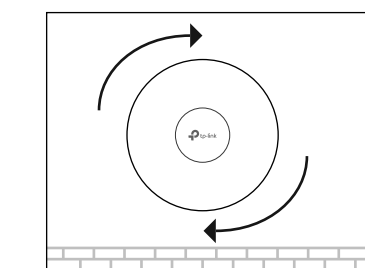

5 Attach the EAP to the mounting bracket by rotating it until it locks into place, as shown on the left.

### Option 3: Junction Box Mounting

Prepare the cables and the junction box in advance. Ensure that the mounting holes align to your junction box.

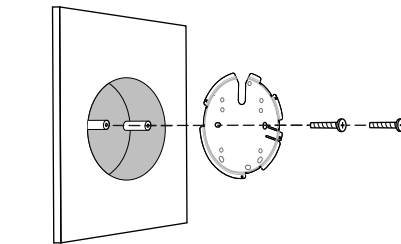
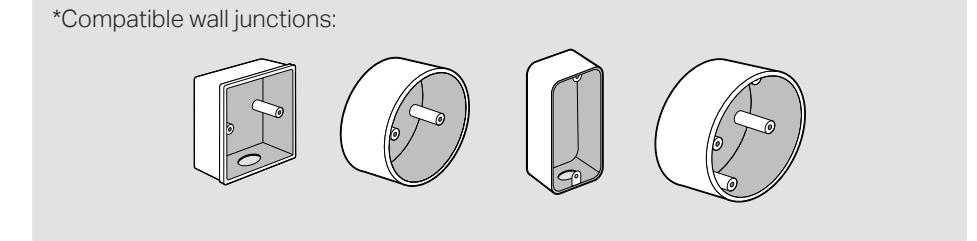

1 Route the cables through the square cable hole on the mounting bracket, and secure the mounting bracket to the junction box using screws.

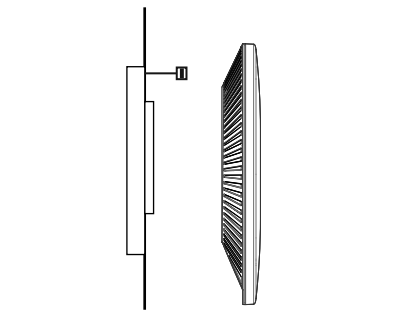

2 Connect the Ethernet cable to the Ethernet port on the EAP.

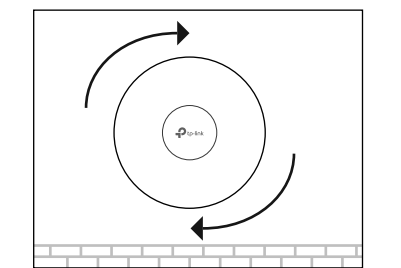

3 Attach the EAP to the mounting bracket by rotating it until it locks into place, as shown on the left.

## 3 Power Supply

The EAP can be powered via a power adapter or a PSE device (such as a PoE switch) which complies with Power Source Class 2 (PS2) or Limited Power Source (LPS) of IEC 62368-1.

### Option 1: Via PoE Switch

Connect an Ethernet cable from the PoE switch to the Ethernet port.

Note: For PoE power supply specifications, refer to the product label.

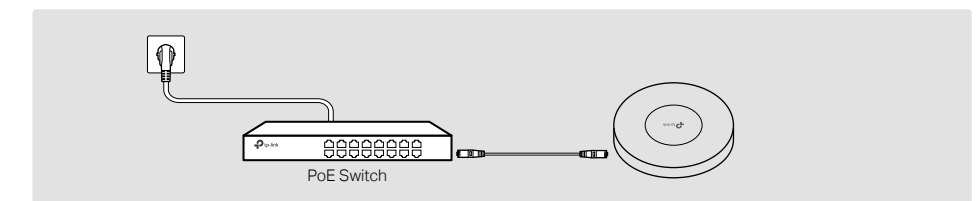

### Option 2: Via Power Adapter

Plug one end of the power adapter into the power port of the EAP and the other end to a standard electrical wall outlet.

Note: Power adapter is not included in the package contents of certain models. For details, refer to the product specifications or datasheet. For power supply specifications, refer to the product label.

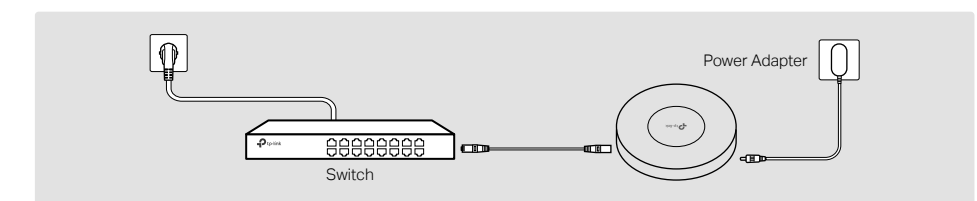

## 4 Software Configuration

Choose from the following methods to set up your EAPs:

- **Method 1: Standalone Mode**  
To configure and manage EAPs separately (Convenient for a small network with only a few devices)
- **Method 2: Controller Mode**  
To configure and manage EAPs in batches on a central platform, namely **Omada Controller**.

### Method 1: Standalone Mode

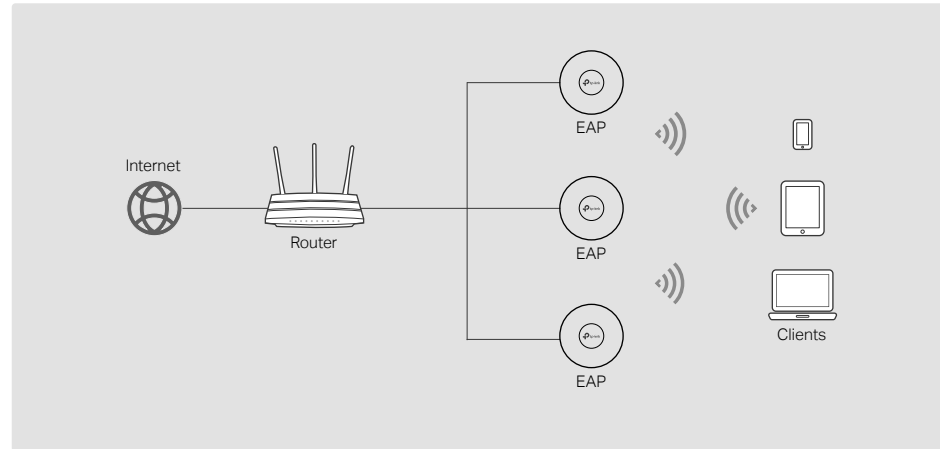

- Note:**
- Before you start, be sure to **power up** and **connect** your devices according to the topology figure.
  - A DHCP server (typically a router with DHCP function enabled) is required to assign IP addresses to the EAPs and clients in your local network.

#### Via Omada App

1. Download and install the TP-Link Omada App from App Store or Google Play.



2. Connect your mobile device to the EAP by using the default SSIDs printed on the label at the bottom of the product.
3. Open the Omada App, go to the **Standalone Devices > APs** page, and wait for the EAP to appear. Tap on the EAP to configure it.

The Omada App is designed to help you quickly configure common settings. If you want to configure advanced settings, use the web page of your EAP or use Controller Mode.

#### Via Web Browser

1. Connect your device to the EAP by using the default SSIDs printed on the label at the bottom of the product.
2. Launch a web browser and enter <http://tplinkeap.net> in the address bar. Use **admin** for both Username and Password to log in.
3. Set up a new Username and Password for secure management purpose. Then you can configure the AP.

To configure other EAPs, connect your device to each EAP by the corresponding default SSID and repeat the steps above. You can configure some basic functions in Standalone Mode. If you want to configure advanced functions, use Controller Mode.

For detailed configurations, refer to the User Guide of the controller and EAPs. The guides can be found on the download center of our official website:  
<https://www.tp-link.com/support/download/?type=smb>

To ask questions, find answers, and communicate with TP-Link users or engineers, please visit <https://community.tp-link.com/business> to join TP-Link Community.

For technical support, the user guide and other information, please visit <https://www.tp-link.com/support/?type=smb>, or simply scan the QR code.

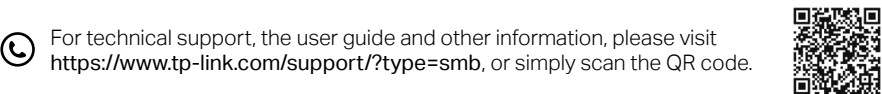

### Method 2: Controller Mode

Choose a type of Omada Controller:

- **Type 1: Omada Cloud-Based Controller**

Omada Cloud-Based Controller is a good alternative without the need to install the software controller on a PC or purchasing the hardware controller.

Licenses need to be purchased additionally.

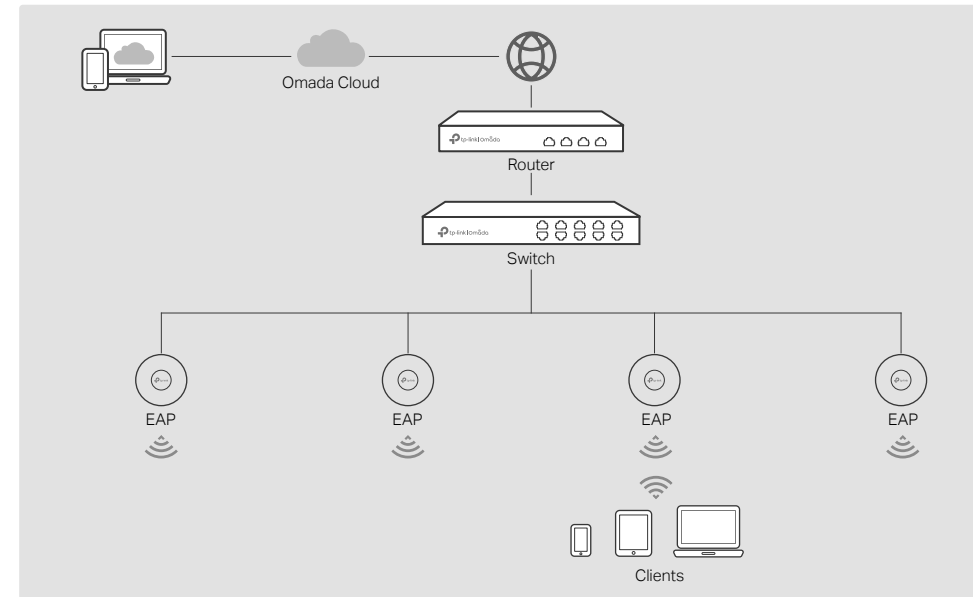

- Note:**
- Before you start, be sure to **power up** and **connect** your devices according to the topology figure.
  - A DHCP server (typically a router with DHCP function enabled) is required to assign IP addresses to the EAPs and clients in your local network.

#### Web Configuration

1. Contact the sales staff to grant the Omada Cloud-Based Controller permission.
2. Launch a web browser and enter <https://omada.tplinkcloud.com> in the address bar. Log in with your TP-Link ID.

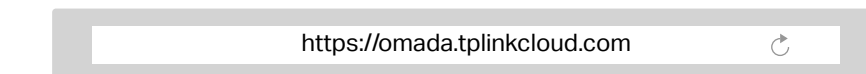

3. Click **+ Add Controller** and add a Cloud-Based Controller. Then you can launch the controller to adopt and manage devices.

#### \* Management via Omada App

After adding a Cloud-Based Controller, you can also manage it via the Omada App.

1. Download and install the TP-Link Omada App from App Store or Google Play.



2. Launch the Omada App and log in with your TP-Link ID. Then go to **Cloud Access**. A list of controllers that have been bound with your TP-Link ID will appear. Then you can launch the controller to adopt and manage devices.

#### Safety Information

- Keep the device away from water, fire, humidity or hot environments.
- Do not attempt to disassemble, repair, or modify the device. If you need service, please contact us.
- Do not use the device where wireless devices are not allowed.
- Do not use damaged charger or USB cable to charge the device.
- Do not use any other chargers than those recommended.
- Adapter shall be installed near the equipment and shall be easily accessible.



#### EU Declaration of Conformity

For EAPs with adapters:  
TP-Link hereby declares that the device is in compliance with the essential requirements and other relevant provisions of directives 2014/53/EU, 2009/125/EC, 2011/65/EU and (EU) 2015/863.  
The original EU Declaration of Conformity may be found at <https://www.tp-link.com/en/support/ce/>  
For EAPs without adapters:  
TP-Link hereby declares that the device is in compliance with the essential requirements and other relevant provisions of directives 2014/53/EU, 2011/65/EU and (EU) 2015/863.  
The original EU Declaration of Conformity may be found at <https://www.tp-link.com/en/support/ce/>

#### UK Declaration of Conformity

TP-Link hereby declares that the device is in compliance with the essential requirements and other relevant provisions of the Radio Equipment Regulations 2017.  
The original UK Declaration of Conformity may be found at <https://www.tp-link.com/support/ukca/>

- **Type 2: Omada Software Controller**

On a PC with Windows OS or Linux OS, download the software controller from <https://www.tp-link.com/support/download/omada-software-controller/>. Then run the file and follow the wizard to install and launch the controller.

To manage your devices, the software controller needs to keep running on your computer.

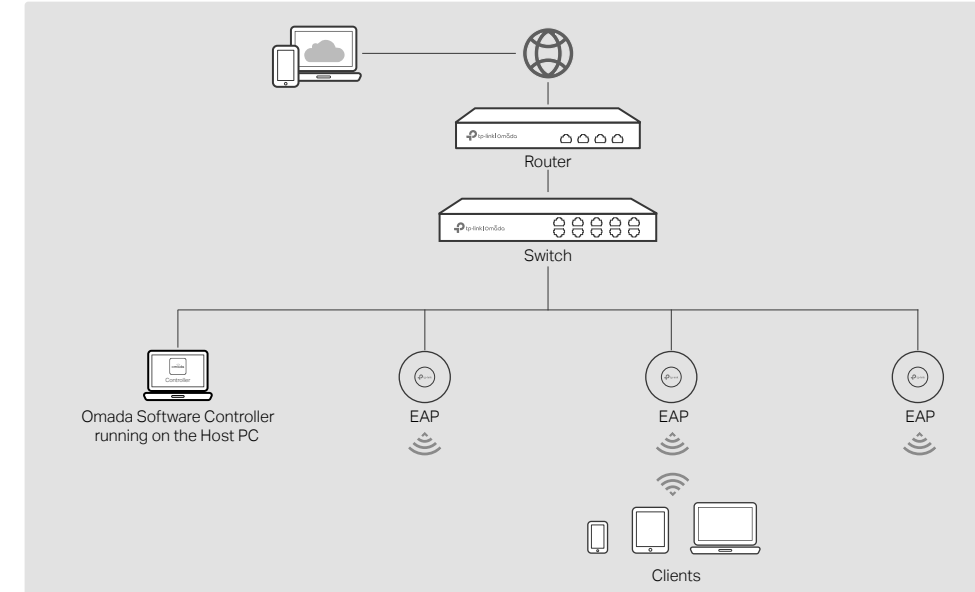

#### Note:

- Before you start, be sure to **power up** and **connect** your devices according to the topology figure.
- A DHCP server (typically a router with DHCP function enabled) is required to assign IP addresses to the EAPs and clients in your local network.
- Omada Controller must have network access to your Omada devices (the router, switch, and EAPs) in order to find, adopt, and manage them.

#### Via Omada App

1. Download and install the TP-Link Omada App from App Store or Google Play.



2. Launch your Omada App and configure the controller at a local site or remote site.

#### • Local Management

- a. Connect your mobile device to the EAP by using the default SSIDs printed on the label at the bottom of the product.
- b. Launch the Omada App and go to **Local Access**, tap the **+** button on the upper-right corner to add the controller. Then you can launch the controller to adopt and manage devices.

#### • Remote Management

- Note:** Before you start, make sure that both your controller and mobile device can access the internet.
- a. Make sure that **Cloud Access** is enabled on your controller and your controller has been bound with your TP-Link ID.
  - b. Launch Omada App and log in with your TP-Link ID. Then go to **Cloud Access**. A list of controllers that have been bound with your TP-Link ID will appear. Then you can launch the controller to adopt and manage devices.

#### Via Web Browser

1. Open the controller's web page.

Launch the software controller on your PC. After the initiation process, the controller automatically opens its web page. If not, click **Launch a Browser to Manage the Network**.

2. On the controller's web page, follow the wizard to complete the quick setup. Then you can launch the controller to adopt and manage devices.
3. (For Remote Management) You can remotely access and manage your controller via Omada Cloud Service.

**Note:** Before you start, make sure that both your controller and PC can access the internet.

- a. Make sure that **Cloud Access** is enabled on your controller and your controller has been bound with your TP-Link ID. On the controller's web page, go to **Settings > Cloud Access** to enable Cloud Access and bind your TP-Link ID. If you have set it up in the quick setup, skip this step.
- b. Launch a web browser and enter <https://omada.tplinkcloud.com> in the address bar. Enter your TP-Link ID and password to log in. A list of controllers that have been bound with your TP-Link ID will appear. Then you can launch the controller to adopt and manage devices.

- **Type 3: Omada Hardware Controller**

If you have no spare PC to keep running the software controller in the network, you can purchase the hardware controller.

For more details, refer to the Installation Guide of your hardware controller.

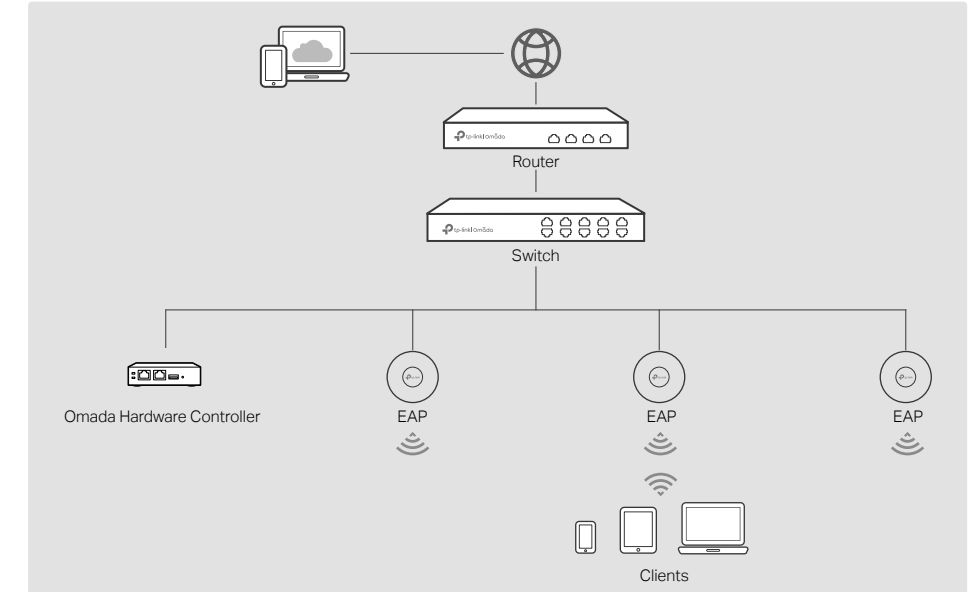

#### Note:

- Before you start, be sure to **power up** and **connect** your devices according to the topology figure.
- A DHCP server (typically a router with DHCP function enabled) is required to assign IP addresses to the EAPs and clients in your local network.
- Omada Controller must have network access to your Omada devices (the router, switch, and EAPs) in order to find, adopt, and manage them.

#### Via Omada App

1. Download and install the TP-Link Omada App from App Store or Google Play.

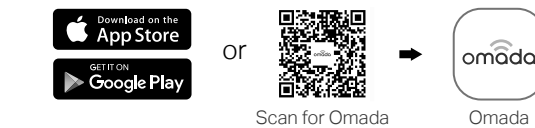

2. Launch your Omada App and configure the controller at a local site or remote site.

#### • Local Management

- a. Connect your mobile device to the EAP by using the default SSIDs printed on the label at the bottom of the product.
- b. Launch the Omada App and go to **Local Access**, tap the **+** button on the upper-right corner to add the controller. Then you can launch the controller to adopt and manage devices.

#### • Remote Management

- Note:** Before you start, make sure that both your controller and mobile device can access the internet.
- a. Make sure that **Cloud Access** is enabled on your controller. By default, **Cloud Access** is enabled. Make sure that the Cloud LED is flashing slowly.
  - b. Launch Omada App and log in with your TP-Link ID. Then go to **Cloud Access**. Tap the **+** button on the upper-right to add your controller. Then you can launch the controller to adopt and manage devices.

#### Via Web Browser

1. Open the controller's web page.

Find the IP address of the controller on the gateway router's DHCP client list. Enter the IP address in the address bar to open its web page.

2. On the controller's web page, follow the wizard to complete the quick setup. Then you can launch the controller to adopt and manage devices.
3. (For Remote Management) You can remotely access and manage your controller via Omada Cloud Service.

**Note:** Before you start, make sure that both your controller and PC can access the internet.

- a. Make sure that **Cloud Access** is enabled on your controller. By default, **Cloud Access** is enabled. Make sure that the Cloud LED is flashing slowly.
- b. Launch a web browser and enter <https://omada.tplinkcloud.com> in the address bar. Enter your TP-Link ID and password to log in. Click **+ Add Controller** and choose **Hardware Controller** to add your controller. Then you can further configure the controller.