

Latitude 5455

Owner's Manual

Notes, cautions, and warnings

 **NOTE:** A NOTE indicates important information that helps you make better use of your product.

 **CAUTION:** A CAUTION indicates either potential damage to hardware or loss of data and tells you how to avoid the problem.

 **WARNING:** A WARNING indicates a potential for property damage, personal injury, or death.

Chapter 1: Views of Latitude 5455.....	6
Right.....	6
Left.....	6
Top.....	7
Front.....	8
Bottom.....	9
Locate the Service Tag or Express Service Code label of your computer.....	9
Battery charge and status light	10
Chapter 2: Set up your Latitude 5455.....	11
Chapter 3: Specifications of Latitude 5455.....	13
Dimensions and weight.....	13
Processor.....	13
Chipset.....	14
Operating system.....	14
Memory.....	15
External ports.....	15
Internal slots.....	16
Wireless module.....	16
Audio.....	16
Storage.....	17
Media-card reader.....	17
Keyboard.....	18
Keyboard function keys of Latitude 5455.....	18
Camera.....	20
Touchpad.....	20
Power adapter.....	21
Power adapter requirements of Latitude 5455.....	21
Battery.....	22
Fingerprint reader.....	23
Display.....	23
GPU—Integrated.....	24
External display support.....	24
Sensor	24
Hardware security.....	25
Operating and storage environment.....	25
Dell support policy.....	25
Using the privacy shutter.....	25
Dell Optimizer.....	26
Chapter 4: Working inside your computer.....	27
Safety instructions.....	27
Before working inside your computer.....	27

Safety precautions.....	28
Electrostatic discharge—ESD protection.....	28
ESD Field Service kit	29
Transporting sensitive components.....	30
After working inside your computer.....	30
BitLocker.....	30
Recommended tools.....	30
Screw list.....	30
Major components of Latitude 5455	31

Chapter 5: Removing and installing Customer Replaceable Units (CRUs)..... 34

Base cover.....	34
Removing the base cover.....	34
Installing the base cover.....	37
Solid state drive (SSD).....	39
Removing the SSD.....	39
Installing the SSD.....	41
Speakers.....	43
Removing the speakers.....	43
Installing the speakers.....	44
Fan.....	46
Removing the fan	46
Installing the fan	46

Chapter 6: Removing and installing Field Replaceable Units (FRUs)..... 48

Battery.....	48
Rechargeable Li-ion battery precautions.....	48
Removing the battery.....	48
Installing the battery.....	49
Battery cable.....	50
Removing the battery cable	50
Installing the battery cable	52
Heat sink.....	53
Removing the heat sink.....	53
Installing the heat sink.....	54
Coin-cell battery.....	55
Removing the coin-cell battery.....	55
Installing the coin-cell battery.....	56
I/O-board cable.....	57
Removing the I/O-board cable	57
Installing the I/O-board cable	59
WLAN-antenna module.....	60
Removing the WLAN-antenna module	60
Installing the WLAN-antenna module	62
Display assembly.....	65
Removing the display assembly	65
Installing the display assembly	67
I/O board.....	69
Removing the I/O board	69

Installing the I/O-board	69
Touchpad assembly.....	70
Removing the touchpad assembly.....	70
Installing the touchpad assembly.....	71
Power button.....	72
Removing the power button	72
Installing the power button	74
System board.....	76
Removing the system board.....	76
Installing the system board.....	79
Palm-rest and keyboard assembly.....	82
Removing the palm-rest and keyboard assembly	82
Installing the palm-rest and keyboard assembly	83
Chapter 7: Software.....	85
Operating system.....	85
Drivers and downloads.....	85
Chapter 8: BIOS Setup.....	86
Entering BIOS Setup program.....	86
Navigation keys.....	86
F12 One Time Boot menu.....	86
View Advanced Setup options.....	87
System setup options.....	87
Updating the BIOS.....	97
Updating the BIOS in Windows.....	97
Updating the BIOS using the USB drive in Windows.....	97
Updating the BIOS from the One-Time boot menu.....	98
System and setup password.....	98
Assigning a System Setup password.....	99
Deleting or changing an existing system password or setup password.....	99
Clearing CMOS settings.....	100
Clearing BIOS (System Setup) and System passwords.....	100
Clearing chassis intrusion alert.....	100
Chapter 9: Troubleshooting.....	103
Handling swollen rechargeable Li-ion batteries.....	103
Locating the Service Tag or Express Service Code of your Dell computer	103
Dell SupportAssist Pre-boot System Performance Check diagnostics.....	104
Running the SupportAssist Pre-Boot System Performance Check.....	104
Built-in self-test (BIST).....	104
LCD Built-in Self-Test (BIST).....	104
LCD Power rail test (L-BIST).....	105
System-diagnostic lights.....	105
Backup media and recovery options.....	105
Wi-Fi power cycle.....	105
Drain residual flea power (perform hard reset).....	106
Chapter 10: Getting help and contacting Dell.....	107

Views of Latitude 5455

Right



Figure 1. Right view

1. **USB 3.2 Gen 1 port**

Connect devices such as external storage devices and printers. It provides data transfer speeds up to 5 Gbps.

2. **Global headset audio jack**

Connect headphones or a headset (headphone and microphone combo).

Left



Figure 2. Left view

1. **USB4 40 Gbps Type-C ports with Power Delivery and DisplayPort (2)**

Connect devices such as external storage devices, printers, and external displays.

Provides data transfer rate of up to 40 Gbps. Supports Power Delivery that enables two-way power supply between devices. Supports DisplayPort 1.4a that enables you to connect to an external display using a display adapter.

NOTE: You can connect a Dell docking station to one of the two USB Type-C ports. If your docking station has two cables, do not connect both cables to the two USB Type-C ports simultaneously. You may encounter issues with the charging circuits when this method of connection is used. For more information, search in the Knowledge Base Resource at the [Dell Support site](#).

NOTE: A 40 Gbps-certified cable is required to achieve the maximum performance of 40 Gbps.

NOTE: A USB Type-C to DisplayPort adapter (sold separately) is required to connect to a DisplayPort device.

NOTE: The USB4 Type-C port is backward compatible with USB 3.2 and USB 2.0.

2. Battery-status light

Indicates the battery-charge status. When the battery charge is low, the status light shows a solid yellow.

Indicates the system-diagnostic light codes. For more information, see [System-diagnostic lights](#).

3. MicroSD-card slot

Reads from and writes to the microSD card.

Top

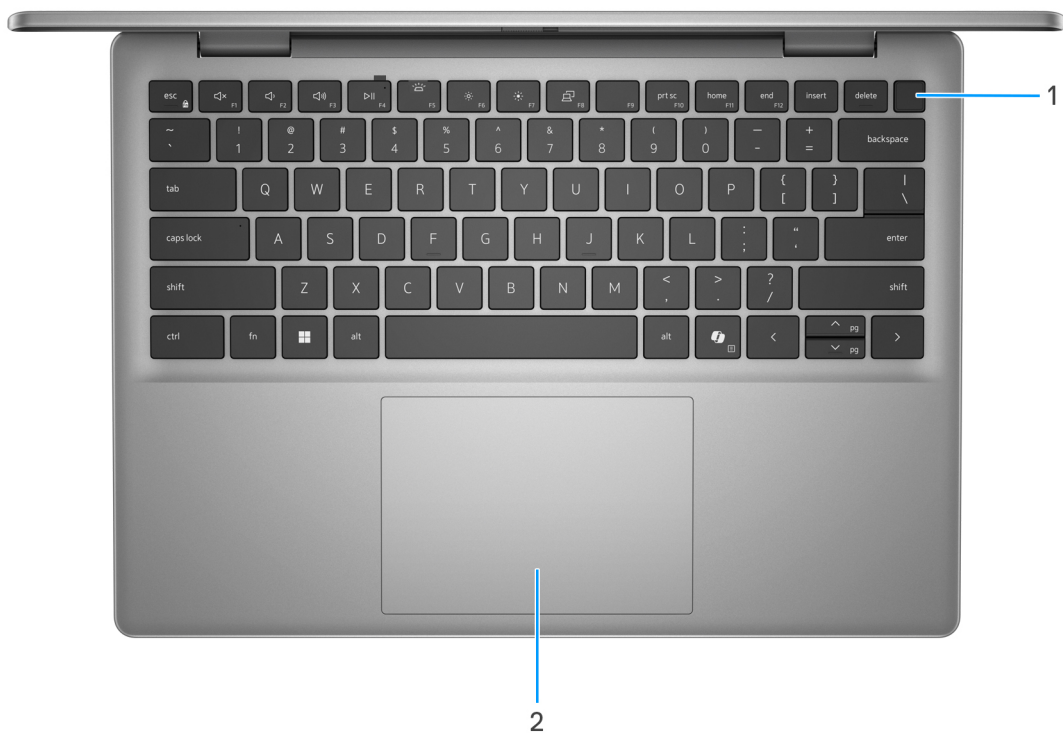

Figure 3. Top view

1. Power button with optional fingerprint reader

Press to turn on the computer if it is turned off, in sleep state, or in a hibernating state.

When the computer is turned on, press the power button to put the computer into sleep state; press and hold the power button for 10 seconds to force shut-down the computer.

If the power button has a fingerprint reader, place your finger on the power button steadily to log in.

NOTE: You can customize the power-button behavior in Windows.

2. Touchpad

Move your finger on the touchpad to move the mouse pointer. Tap to left-click and two fingers tap to right-click.

Front



Figure 4. Front view

1. Left microphone

Provides digital sound input for audio recording and voice calls.

2. Infrared camera

Enhances security when paired with Windows Hello face authentication.

3. Infrared-status light

Turns on when the infrared camera is in use, which enables the infrared camera to sense and track motion.

4. Privacy shutter

Slide the privacy shutter to cover the camera lens and protect your privacy when the camera is not in use.

5. RGB camera

Enables you to video chat, capture photos, and record videos.

6. Camera-status light

Turns on when the camera is in use.

7. Right microphone

Provides digital sound input for audio recording and voice calls.

8. Ambient-light sensor

The sensor detects the ambient light and automatically adjusts the display brightness.

Bottom

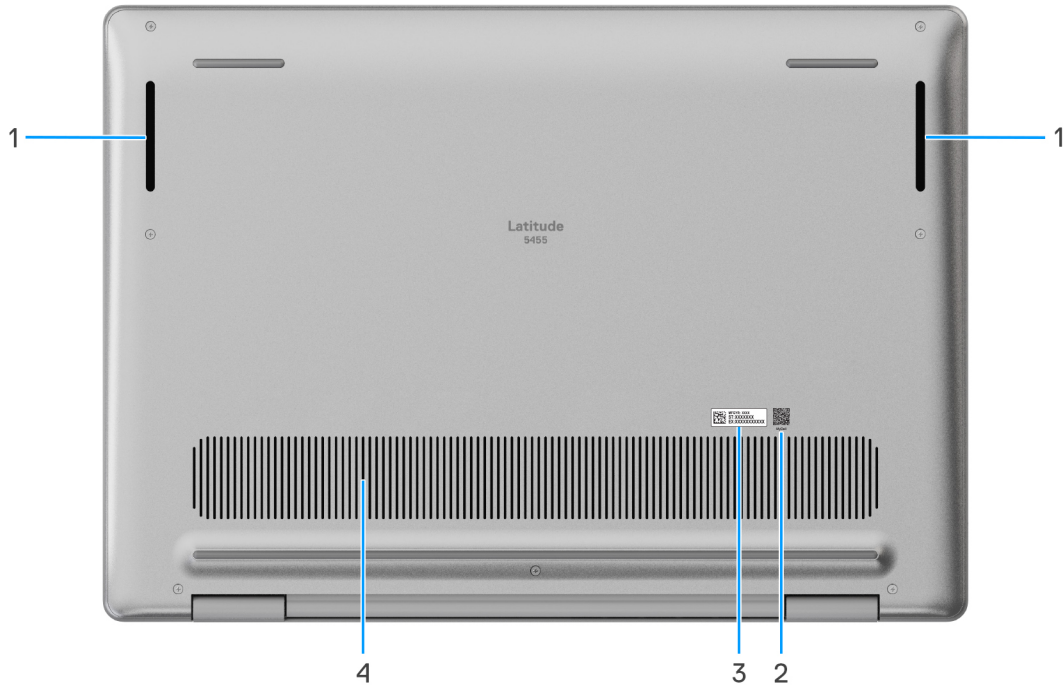

Figure 5. Bottom view

1. Speakers

Provide audio output.

2. MyDell QR code

MyDell is your hub for content personalized to your Latitude 5455, including videos, articles, manuals, and access to support.

3. Service Tag/Express Service Code label

The Service Tag is a unique alphanumeric identifier that enables Dell service technicians to identify the hardware components in your computer and access warranty information. The Express Service Code is a numeric version of the Service Tag.

4. Air vents

Air vents provide ventilation for your computer. Clogged air vents can cause overheating and can affect your computer's performance and potentially cause hardware issues. Keep the air vents clear of obstructions and clean them regularly to prevent the build-up of dust and dirt. For more information about cleaning air vents, search for articles in the Knowledge Base Resource at the [Dell Support site](#).

Locate the Service Tag or Express Service Code label of your computer

The service tag is a unique alphanumeric identifier that allows Dell service technicians to identify the hardware components in your computer and access warranty information. The Express Service Code is a numeric version of the Service Tag. For more information about how to find the Service Tag on your computer, search in the Knowledge Base Resource at the [Dell Support site](#).

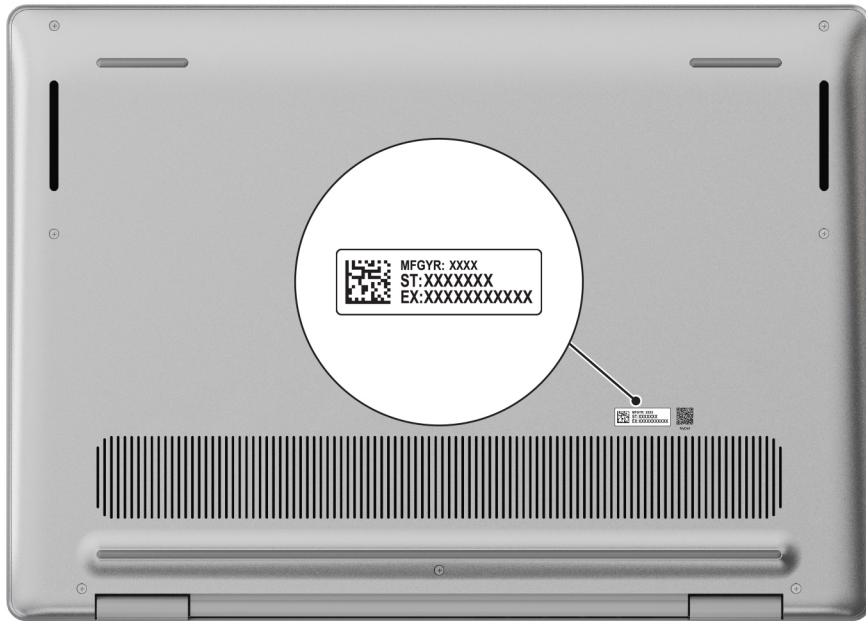

Figure 6. Service Tag/Express Service Code location

Battery charge and status light

The following table lists the battery charge and status light behavior of your Latitude 5455.

Table 1. Battery charge and status light behavior

Power Source	LED Behavior	System Power State	Battery Charge Level
AC Adapter	Off	S0 - S5	Fully Charged
AC Adapter	Solid White	S0 - S5	< Fully Charged
Battery	Off	S0 - S5	11-100%
Battery	Solid Amber (590+/-3 nm)	S0 - S5	<=10%

- S0 (ON) - The computer is turned on.
- S4 (Hibernate) - The computer consumes the least power compared to all other sleep states. The computer is almost in an OFF state. The context data is written to a storage device so that you can resume everything from where you left, once the computer is turned on.
- S5 (OFF) - The computer is in a shutdown state.

Set up your Latitude 5455

About this task

NOTE: The images in this document may differ from your computer depending on the configuration you ordered.

Steps

1. Connect the power adapter and press the power button.



Figure 7. Connect the power adapter and press the power button

NOTE: The battery may go into power-saving mode during shipment to conserve charge on the battery. Ensure that the power adapter is connected to your computer when it is turned on for the first time.

2. Finish the operating system setup.

Follow the on-screen instructions to complete the setup. When setting up, Dell Technologies recommends that you:

- Connect to a network for Windows updates.

NOTE: If connecting to a secured wireless network, enter the password for the wireless network access when prompted.

- If connected to the Internet, sign in with or create a Microsoft account.

3. Locate and use Dell apps from the Windows Start menu—Recommended.

Table 2. Locate Dell apps





Resources	Description
	<p>Dell Product Registration Register your computer with Dell.</p>

Table 2. Locate Dell apps (continued)

Resources	Description
	<p>Dell Help & Support</p> <p>Access help and support for your computer.</p>
	<p>SupportAssist</p> <p>SupportAssist is the smart technology that keeps your computer running at its best by optimizing settings, detecting issues, removing viruses and notifies when you must make computer updates. SupportAssist proactively checks the health of your computer hardware and software. When an issue is detected, the necessary system state information is sent to Dell to begin troubleshooting. SupportAssist is preinstalled on most of the Dell devices running the Windows operating system. For more information, see <i>SupportAssist for Business PCs Manuals and Documents</i> at Support Assist for Business PCs.</p> <p>NOTE: In SupportAssist, click the warranty expiry date to renew or upgrade your warranty.</p>
	<p>Dell Digital Delivery</p> <p>Download software applications, which are purchased but not preinstalled on your computer. For more information about using Dell Digital Delivery, search in the Knowledge Base Resource at Dell Support Site.</p>

Specifications of Latitude 5455

Dimensions and weight

The following table lists the height, width, depth, and weight of your Latitude 5455.

Table 3. Dimensions and weight

Description	Values
Height:	
Front height	15.14 mm (0.60 in.)
Rear height	16.00 mm (0.63 in.)
Maximum height	17.90 mm (0.70 in.)
Width	314 mm (12.36 in.)
Depth	223.75 mm (8.81 in.)
Weight  NOTE: The weight of your computer depends on the configuration that is offered.	1.53 kg (3.37 lb) - minimum

Processor

The following table lists the details of the processors that are supported for your Latitude 5455.

Table 4. Processor

Description	Option one	Option two
Processor type	Qualcomm Snapdragon X Plus X1P-42-100	Qualcomm Snapdragon X Plus X1P-64-100
Processor wattage	15 W	15 W
Processor total core count	8	10
Performance-cores	8	6
Efficient-cores	Not applicable	4
Processor total thread count	8	10
Processor speed	3.24 GHz–3.42 GHz	Up to 3.40 GHz
Frequency—Performance cores		
Processor base frequency	3.24 GHz	Up to 3.40 GHz
Maximum turbo frequency	Up to 3.42 GHz	Up to 3.40 GHz

Table 4. Processor (continued)

Description		Option one	Option two
Frequency—Efficient cores			
	Processor base frequency	Not applicable	3.40 GHz
	Maximum turbo frequency	Not applicable	3.40 GHz
Thermal Mode/Thermal Design Power (TDP)			
	Cool	13 W	13 W
	Optimized	15 W	15 W
	Quiet	12 W	12 W
	Ultra performance	21 W	21 W
		 NOTE: Processor clock speed and thermal design power differ according to the thermal mode selected in the Dell Optimizer App on your computer.	
	Processor cache	30 MB	42 MB
	Neural Processing Unit (performance)	Up to 45 TOPS	Up to 45 TOPS
	Integrated graphics	Qualcomm Adreno Graphics	Qualcomm Adreno Graphics

Chipset

The following table lists the details of the chipset that is supported in your Latitude 5455.

Table 5. Chipset

Description	Values
Chipset	Integrated in the processor
Processor	Qualcomm Snapdragon X Plus
DRAM bus width	128-bit
Flash EPROM	64 MB
PCIe bus	Up to Gen 4

Operating system

Your Latitude 5455 supports the following operating systems:

- Windows 11 Home, ARM
- Windows 11 Pro, ARM

Memory

The following table lists the memory specifications of your Latitude 5455.

Table 6. Memory specifications

Description	Values
Memory slots	Onboard memory <i>i</i> NOTE: The memory is integrated on the system board and is not upgradeable.
Memory type	LPDDR5x
Memory speed	8448 MT/s
Maximum memory configuration	32 GB
Minimum memory configuration	16 GB
Memory configurations supported	<ul style="list-style-type: none"> 16 GB: LPDDR5x, 8448 MT/s (onboard) 32 GB: LPDDR5x, 8448 MT/s (onboard)

External ports

The following table lists the external ports of your Latitude 5455.

Table 7. External ports

Description	Values
USB ports	<ul style="list-style-type: none"> One USB 3.2 Gen 1 port Two USB4 40 Gbps Type-C ports with Power Delivery and DisplayPort <i>i</i> NOTE: You can connect a USB Type-C power adapter or a Dell docking station to one of the two USB Type-C ports. If your docking station has two cables, do not connect both cables to the two USB Type-C ports simultaneously. You may encounter issues with the charging circuits when this method of connection is used. For more information, search in the Knowledge Base Resource at the Dell Support site .
Audio port	One Global headset audio jack
Video port	Two USB4 40 Gbps Type-C ports with Power Delivery and DisplayPort
Media-card reader	One microSD-card slot
Power-adapter port	Supported through the USB4 40 Gbps Type-C ports with Power Delivery and DisplayPort. <i>i</i> NOTE: You can connect a USB Type-C power adapter or a Dell docking station to one of the two USB Type-C ports. If your docking station has two cables, do not connect both cables to the two USB Type-C ports simultaneously. You may encounter issues with the charging circuits when this method of connection is used.

Table 7. External ports (continued)

Description	Values
	For more information, search in the Knowledge Base Resource at the Dell Support site .
SIM-card slot	Not supported

Internal slots

The following table lists the internal slots of your Latitude 5455.

Table 8. Internal slots

Description	Values
M.2	One M.2 2230 slot for solid state drive  NOTE: To learn more about the features of different types of M.2 cards, search in the Knowledge Base Resource at Dell Support Site .

Wireless module

The following table lists the Wireless Local Area Network (WLAN) module that is supported on your Latitude 5455.

Table 9. Wireless module specifications

Description	Values
Model number	Qualcomm FastConnect 7800 DBS
Transfer rate	Up to 5760 Mbps
Frequency bands supported	2.4 GHz/5 GHz/6 GHz
Wireless standards	<ul style="list-style-type: none"> • WiFi 802.11a/b/g • Wi-Fi 4 (WiFi 802.11n) • Wi-Fi 5 (WiFi 802.11ac) • Wi-Fi 6E (WiFi 802.11ax) • Wi-Fi 7 (WiFi 802.11be)
Encryption	<ul style="list-style-type: none"> • 64-bit/128-bit WEP • AES-CCMP • TKIP
Bluetooth wireless card	Bluetooth 5.4 wireless card

Audio

The following table lists the audio specifications of your Latitude 5455.

Table 10. Audio specifications

Description	Values
Audio controller	Qualcomm WCD9385

Table 10. Audio specifications (continued)

Description		Values
Stereo conversion		Supported
Internal audio interface		SoundWire
External audio interface		Global headset audio jack
Number of speakers		2
Internal-speaker amplifier		Supported
External volume controls		Keyboard shortcut controls
Speaker output:		
	Average	2 W x 2
	Peak	2.5 W x 2
Microphone		Dual-array microphones

Storage

This section lists the storage options on your Latitude 5455.
Your Latitude 5455 supports one M.2 2230 solid state drive.

Table 11. Storage specifications

Storage type	Interface type	Capacity
M.2 2230 solid state drive	PCIe Gen4 NVMe, up to 64 Gbps	Up to 1 TB

Media-card reader

The following table provides the specification of media cards supported by your Latitude 5455.

Table 12. Media-card reader specifications

Description	Values
Media-card slot type	One microSD-card slot
Media-cards supported	<ul style="list-style-type: none"> • Micro Secure Digital (mSD) • Micro Secure Digital High Capacity (mSDHC) • Micro Secure Digital Extended Capacity (mSDXC)
 NOTE: The maximum capacity that is supported by the media-card reader varies depending on the standard of the media card that is installed on your computer.	

Keyboard

The following table lists the keyboard specifications of your Latitude 5455.

Table 13. Keyboard specifications

Description	Values
Keyboard type	Standard backlit keyboard with Copilot key
Keyboard layout	QWERTY
Number of keys	<ul style="list-style-type: none"> • Arabic, Canada (Bilingual) MUI, Chinese (Traditional), English International, English US, Hebrew, Ukrainian: 79 keys • Belgian, Czech & Slovakian (MUI), English UK, French (European), German, Hungarian, Italian, Nordic (MUI), Portuguese Iberian, Spanish (Castillian), Spanish (Latin America), Swiss European (MUI), Turkish: 80 keys • Japanese: 83 keys
Keyboard size	X=19.05 mm key pitch Y=18.05 mm key pitch
Keyboard shortcuts	<p>Some keys on your keyboard have two symbols on them. These keys can be used to type alternate characters or to perform secondary functions. To type the alternate character, press Shift and the desired key. To perform secondary functions, press fn and the desired key.</p> <p>i NOTE: You can define the primary behavior of the function keys (F1–F12) changing Fn Lock Options in the BIOS setup program.</p> <p>i NOTE: If Copilot in Windows is not available on your computer, the Copilot key launches Recall. If both Recall and Copilot in Windows are not available on your computer, the Copilot key launches Windows Search. For more information about Copilot in Windows and Recall, search in the Knowledge Base Resource at the Dell Support Site.</p>

Keyboard function keys of Latitude 5455

i **NOTE:** Keyboard characters may differ depending on the keyboard language configuration. Keys that are used for shortcuts remain the same across all language configurations.

Some keys on your keyboard have two symbols on them. These keys can be used to type alternate characters or to perform secondary functions. The symbol that is shown on the lower part of the key refers to the character that is typed out when the key is pressed. If you press shift and the key, the symbol that is shown on the upper part of the key is typed out. For example, if you press 2, **2** is typed out; if you press Shift + 2, **@** is typed out.

The keys F1-F12 at the top row of the keyboard are function keys for multimedia control indicated by the icon at the bottom of the key. Press the function key to invoke the task represented by the icon. For example, pressing F1 mutes the audio (refer to the table below).

However, if the function keys F1-F12 are needed for specific software applications, multimedia functionality can be disabled by pressing **fn + esc**. Later, multimedia control can be invoked by pressing **fn** and the respective function key. For example, mute audio by pressing **fn + F1**.

Table 14. List of keyboard shortcuts

Key	Primary behavior
F1	Mute or unmute audio.
F2	Decrease audio volume.
F3	Increase audio volume.
F4	Play or pause the media file.
F5	Keyboard backlight <i>i</i> NOTE: Toggle to cycle the keyboard backlight status through off, low-backlight, and high-backlight.
F6	Decrease the screen brightness.
F7	Increase the screen brightness.
F8	Switch to the external display.
F10	Print screen
F11	Home
F12	End
Copilot	Launch Copilot in Windows. <i>i</i> NOTE: If Copilot in Windows is not available on your computer, the Copilot key launches Recall. If both Recall and Copilot in Windows are not available on your computer, the Copilot key launches Windows Search. For more information about Copilot in Windows and Recall, search in the Knowledge Base Resource at the Dell Support Site .

The **fn** key is also used with selected keys on the keyboard to invoke other secondary functions.

i **NOTE:** Keyboard characters may differ depending on the keyboard language configuration. Keys that are used for tasks remain the same, regardless of the keyboard language.

Table 15. Secondary behavior

Function key	Secondary behavior
fn + F1	Operating system and application-specific F1 behavior
fn + F2	Operating system and application-specific F2 behavior
fn + F3	Operating system and application-specific F3 behavior
fn + F4	Operating system and application-specific F4 behavior
fn + F5	Operating system and application-specific F5 behavior
fn + F6	Operating system and application-specific F6 behavior
fn + F8	Operating system and application-specific F8 behavior
fn + F9	Operating system and application-specific F9 behavior
fn + F10	Operating system and application-specific F10 behavior
fn + F11	Operating system and application-specific F11 behavior
fn + F12	Operating system and application-specific F12 behavior
fn + B	Pause or break.
fn + S	Toggle scroll lock.
fn + R	System request.
fn + Copilot	Open the application menu.

Table 15. Secondary behavior (continued)

Function key	Secondary behavior
fn + esc	Toggles the function key on and off.
fn + pg up arrow	Scroll up the document or page.
fn + pg down arrow	Scroll down the document or page.
fn + left arrow	Home (move to the beginning of the document).
fn + right arrow	End (move to the end of the document).

Camera

The following table lists the camera specifications of your Latitude 5455.

Table 16. Camera specifications

Description	Values
Number of cameras	Two
Camera type	<ul style="list-style-type: none"> FHD RGB camera IR camera
Camera location	Front camera
Camera sensor type	CMOS sensor technology
Camera resolution:	
Still image	2.07 megapixel
Video	1920 x 1080 (FHD) at 30 fps
Infrared camera resolution:	
Still image	0.92 megapixel
Video	1280 x 720 at 30 fps
Diagonal viewing angle:	
Camera	80.20 degrees
Infrared camera	86.60 degrees

Touchpad

The following table lists the touchpad specifications of your Latitude 5455.

Table 17. Touchpad specifications

Description	Values
Touchpad resolution:	>300 dpi
Touchpad dimensions:	
Horizontal	115.00 mm (4.53 in.)

Table 17. Touchpad specifications (continued)

Description		Values
	Vertical	80.00 mm (3.15 in.)
Touchpad gestures		For more information about the touchpad gestures available on Windows, see the Microsoft Knowledge Base article at Microsoft Support Site .

Power adapter

The following table lists the power adapter specifications of your Latitude 5455.

Table 18. Power-adapter specifications

Description		Values
Type		65 W AC adapter, USB Type-C
Power-adapter dimensions:		
	Height	28.00 mm (1.10 in.)
	Width	51.00 mm (2.01 in.)
	Depth	112.00 mm (4.41 in.)
Input voltage		100 VAC–240 VAC
Input frequency		50 Hz–60 Hz
Input current (maximum)		1.70 A
Output current (continuous)		<ul style="list-style-type: none"> • 20 V/3.25 A • 15 V/3 A • 9 V/3 A • 5 V/3 A
Rated output voltage		<ul style="list-style-type: none"> • 20 VDC • 15 VDC • 9 VDC • 5 VDC
Temperature range:		
	Operating	0°C to 40°C (32°F to 104°F)
	Storage	-40°C to 70°C (-40°F to 158°F)
 CAUTION: Operating and storage temperature ranges may differ among components, so operating or storing the device outside these ranges may impact the performance of specific components.		

Power adapter requirements of Latitude 5455

 **NOTE:** If you did not purchase the Dell-branded power adapter that is recommended for your computer, ensure that the power adapter you use meets the following requirements.

The following table lists the power adapter requirements for your Latitude 5455.

Table 19. Power adapter requirements

Description	Value
Power that is required from a power adapter to achieve optimal performance.	65 W
Power that charges the computer at a slower speed. i NOTE: A warning message may appear informing you about the use of a lower-powered adapter and slower charging speed.	Less than 60 W
Minimum power that is required from a power adapter to operate the computer and charge the battery. i NOTE: A warning message appears informing you about the use of a lower-powered adapter and slower charging speed.	27 W
USB Power Delivery (PD) fast charging.	Supported
ExpressCharge mode	Supported i NOTE: Ensure that the computer is connected to a 65 W power adapter for this feature to be supported. i NOTE: ExpressCharge mode must also be enabled in the BIOS Setup screen. Select Power > Battery Configuration > ExpressCharge , then press Enter .

Battery

The following table lists the battery specifications of your Latitude 5455.

Table 20. Battery specifications

Description	Values	
Battery type	3-cell, 54 Wh, lithium-ion (polymer), ExpressCharge	
Battery voltage	11.40 VDC	
Battery weight (maximum)	0.22 kg (0.49 lb)	
Battery dimensions:		
	Height	5.73 mm (0.23 in.)
	Width	263.00 mm (10.35 in.)
	Depth	68.90 mm (2.71 in.)
Temperature range:		
	Operating	<ul style="list-style-type: none"> Charge: 0°C to 45°C (32°F to 113°F) Discharge: 0°C to 70°C (32°F to 158°F)
	Storage	-20°C to 65°C (-4°F to 149°F)
Battery operating time	Varies depending on operating conditions and can significantly reduce under certain power-intensive conditions.	
Battery charging time (approximate) i NOTE: You can control the charging time, duration, start and end time, and so on, using the Dell Power Manager application. For more information about	<ul style="list-style-type: none"> ExpressCharge Method: 0% to 80% battery capacity in 1 hour 	

Table 20. Battery specifications (continued)

Description	Values
Dell Power Manager, search in the Knowledge Base Resource at Dell Support Site .	0% to full battery capacity in 2 hours <ul style="list-style-type: none"> • Standard Charge Method: 0% to full battery capacity in 3 hours
Coin-cell battery	CR2032
<p>CAUTION: Operating and storage temperature ranges may differ among components, so operating or storing the device outside these ranges may impact the performance of specific components.</p> <p>CAUTION: Dell Technologies recommends that you charge the battery regularly for optimal power consumption.</p>	

Fingerprint reader

The following table lists the fingerprint-reader specifications of your Latitude 5455.

NOTE: The fingerprint reader is on the power button.

Table 21. Fingerprint reader specifications

Description	Values
Sensor technology	Capacitive
Sensor resolution	500 dpi
Sensor pixel size	108 x 88

Display

The following table lists the display specifications of your Latitude 5455.

Table 22. Display specifications

Description	Values
Display type	14-inch, Full High-Definition plus (FHD+)
Touch options	No
Display-panel technology	In-Plane Switching (IPS)
Display-panel dimensions (active area):	
Height	188.50 mm (7.42 in.)
Width	301.59 mm (11.87 in.)
Diagonal	355.65 mm (14.00 in.)
Display-panel native resolution	1920 x 1200
Luminance (typical)	300 nits

Table 22. Display specifications (continued)

Description	Values
Megapixels	2.3
Color gamut	45% NTSC
Pixels Per Inch (PPI)	162
Contrast ratio (minimum)	600:1
Response time (maximum)	30 typ./35 max milliseconds
Refresh rate	60 Hz/48 Hz
Horizontal view angle	+/- 85 degrees typ.
Vertical view angle	+/- 85 degrees typ.
Pixel pitch	0.15708 x 0.15708 mm
Power consumption (maximum)	3.68 W at mosaic pattern
Anti-glare vs glossy finish	Anti-glare

GPU—Integrated

The following table lists the specifications of the integrated Graphics Processing Unit (GPU) supported by your Latitude 5455.

Table 23. GPU—Integrated

Controller	Memory size	Processor
Qualcomm Adreno Graphics	Shared system memory	<ul style="list-style-type: none"> Qualcomm Snapdragon X Plus X1P-42-100 Qualcomm Snapdragon X Plus X1P-64-100

External display support

The following table lists the external display support for your Latitude 5455.

Table 24. External display support

Graphics card	Supported external displays with laptop display enabled	Supported external displays with laptop display disabled
Qualcomm Adreno Graphics (iGPU only)	3	3

Sensor

The following table lists the sensor of your Latitude 5455.

Table 25. Sensor

Sensor support
Ambient Light Sensor

Table 25. Sensor (continued)

Sensor support
Wake/Power on with lid open
Hall sensor

Hardware security

The following table lists the hardware security of your Latitude 5455.

Table 26. Hardware security

Hardware security
Trusted Platform Module (TPM) 2.0 discrete
FIPS 140-2 certification for TPM
TCG Certification for TPM (Trusted Computing Group)
Fingerprint reader in the power button (for computers shipped with fingerprint reader)

Operating and storage environment

This table lists the operating and storage specifications of your Latitude 5455.

Airborne contaminant level: G1 as defined by ISA-S71.04-1985

Table 27. Computer environment

Description	Operating	Storage
Temperature range	0°C to 35°C (32°F to 95°F)	-30°C to 65°C (-22°F to 149°F)
Relative humidity (maximum)	10% to 90% (non-condensing)	0% to 95% (non-condensing)
Vibration (maximum)*	0.66 GRMS	1.30 GRMS
Shock (maximum)	110 G†	160 G†
Altitude range	-15.2 m to 3048 m (-49.87 ft to 10,000 ft)	-15.2 m to 10,668 m (-49.87 ft to 35,000 ft)

 **CAUTION: Operating and storage temperature ranges may differ among components, so operating or storing the device outside these ranges may impact the performance of specific components.**

* Measured using a random vibration spectrum that simulates the user environment.

† Measured using a 2 ms half-sine pulse.

Dell support policy

For information about Dell support policy, search in the Knowledge Base Resource at [Dell Support Site](#).

Using the privacy shutter

1. Slide the privacy shutter to the left to unblock the camera lens.
2. Slide the privacy shutter to the right to cover the camera lens.



Figure 8. Using the privacy shutter

Dell Optimizer

This section details the Dell Optimizer specifications of your Latitude 5455.

Dell Optimizer is a software application that dynamically updates the foreground application by changing the priority of system settings to optimize the performance of your applications.

On the Latitude 5455 with Dell Optimizer, the following features are supported:









- Improved user experience through application optimization.
- Quick application launch and seamless application transition.
- Options of thermal mode settings that enhance the performance of your computer.
- Get information about the battery that is connected to your computer.

For more information about configuring and using these features, search for the *Dell Optimizer User 's Guide* at the [Dell Support site](#).

Working inside your computer

Safety instructions

Use the following safety guidelines to protect your computer from potential damage and to ensure your personal safety. Unless otherwise noted, each procedure in this document assumes that you have read the safety information that shipped with your computer.



-  **WARNING:** Before working inside your computer, read the safety information that is shipped with your computer. For more safety best practices, see [Dell Regulatory Compliance Home Page](#).
-  **WARNING:** Disconnect your computer from all power sources before opening the computer cover or panels. After you finish working inside the computer, replace all covers, panels, and screws before connecting your computer to an electrical outlet.
-  **CAUTION:** To avoid damaging the computer, ensure that the work surface is flat, dry, and clean.
-  **CAUTION:** You should only perform troubleshooting and repairs as authorized or directed by the Dell technical support team. Damage due to servicing that is not authorized by Dell is not covered by your warranty. See the safety instructions that is shipped with the product or at [Dell Regulatory Compliance Home Page](#).
-  **CAUTION:** Before touching anything inside your computer, ground yourself by touching an unpainted metal surface, such as the metal at the back of the computer. While you work, periodically touch an unpainted metal surface to dissipate static electricity which could harm internal components.
-  **CAUTION:** To avoid damaging the components and cards, handle them by their edges, and avoid touching the pins and the contacts.
-  **CAUTION:** When you disconnect a cable, pull it by its connector or its pull tab, not the cable itself. Some cables have connectors with locking tabs or thumbscrews that you must disengage before disconnecting the cable. When disconnecting cables, keep them evenly aligned to avoid bending the connector pins. When connecting cables, ensure that the connector on the cable is correctly oriented and aligned with the port.
-  **CAUTION:** Press and eject any installed card from the media-card reader.
-  **CAUTION:** Exercise caution when handling rechargeable Li-ion batteries in laptops. Swollen batteries should not be used and should be replaced and disposed properly.

Before working inside your computer

About this task

 **NOTE:** The images in this document may differ from your computer depending on the configuration you ordered.

Steps

1. Save and close all open files and exit all open applications.
2. Shut down your computer. For Windows operating system, click **Start** >  **Power** > **Shut down**.
 -  **NOTE:** If you are using a different operating system, see the documentation of your operating system for shut-down instructions.
3. Turn off all the attached peripherals.
4. Disconnect your computer and all attached devices from their electrical outlets.

5. Disconnect all attached network devices and peripherals, such as keyboard, mouse, and monitor from your computer.

 **CAUTION: To disconnect a network cable, unplug the cable from your computer.**

6. Remove any media card and optical disc from your computer, if applicable.

Safety precautions

This section details the primary steps to be followed before performing any disassembly instructions.

Observe the following safety precautions before you perform any installation or break-fix procedures involving disassembly or reassembly:

- Turn off the computer and all attached peripherals.
- Disconnect the computer from AC power.
- Disconnect all network cables and peripherals from the computer.
- Use an ESD field service kit when working inside any to avoid electrostatic discharge (ESD) damage.
- Place the removed component on an anti-static mat after removing it from the computer.
- Wear shoes with nonconductive rubber soles to reduce the chance of getting electrocuted.
- Unplugging, pressing, and holding the power button for 15 seconds should discharge residual power in the system board.

Standby power

Dell products with standby power must be unplugged before you open the back cover. Systems that are equipped with standby power are powered while turned off. The internal power enables the computer to be remotely turned on (Wake-on-LAN) and suspended into a sleep mode and has other advanced power management features.

Bonding

Bonding is a method for connecting two or more grounding conductors to the same electrical potential. This is done by using a field service electrostatic discharge (ESD) kit. When connecting a bonding wire, ensure that it is connected to bare metal and never to a painted or nonmetal surface. Ensure that the wrist strap is secure and in full contact with your skin. Remove all jewelry, watches, bracelets, or rings before grounding yourself and the equipment.

Electrostatic discharge—ESD protection

ESD is a major concern when you handle electronic components, especially sensitive components such as expansion cards, processors, memory modules, and system boards. A slight charge can damage circuits in ways that may not be obvious, such as intermittent problems or a shortened product life span. As the industry pushes for lower power requirements and increased density, ESD protection is an increasing concern.

Due to the increased density of semiconductors used in recent Dell products, the sensitivity to static damage is now higher than in previous Dell products. For this reason, some previously approved methods of handling parts are no longer applicable.

Two recognized types of ESD damage are catastrophic and intermittent failures.

- **Catastrophic** – Catastrophic failures represent approximately 20 percent of ESD-related failures. The damage causes an immediate and complete loss of device functionality. An example of catastrophic failure is a memory module that has received a static shock and immediately generates a "No POST/No Video" symptom with a beep code that is emitted for missing or nonfunctional memory.
- **Intermittent** – Intermittent failures represent approximately 80 percent of ESD-related failures. The high rate of intermittent failures means that most of the time when damage occurs, it is not immediately recognizable. The memory module receives a static shock, but the tracing is merely weakened and does not immediately produce outward symptoms that are related to the damage. The weakened trace may take weeks or months to melt, and in the meantime may cause degradation of memory integrity, intermittent memory errors, and so on.

Intermittent failures that are also called latent or "walking wounded" are difficult to detect and troubleshoot.

Perform the following steps to prevent ESD damage:

- Use a wired ESD wrist strap that is properly grounded. Wireless anti-static straps do not provide adequate protection. Touching the chassis before handling parts does not ensure adequate ESD protection on parts with increased sensitivity to ESD damage.

- Handle all static-sensitive components in a static-safe area. If possible, use anti-static floor pads and workbench pads.
- When unpacking a static-sensitive component from its shipping carton, do not remove the component from the anti-static packing material until you are ready to install the component. Before unwrapping the anti-static packaging, use the anti-static wrist strap to discharge the static electricity from your body. For more information about the wrist strap and ESD wrist strap tester, see [Components of an ESD Field Service Kit](#).
- Before transporting a static-sensitive component, place it in an anti-static container or packaging.

ESD Field Service kit

The unmonitored field service kit is the most commonly used service kit. Each Field Service kit includes three main components: anti-static mat, wrist strap, and bonding wire.

 **CAUTION: It is critical to keep ESD-sensitive devices away from internal parts that are insulated and often highly charged, such as plastic heat sink casings.**

Working Environment

Before deploying the ESD Field Service kit, assess the situation at the customer location. For example, deploying the kit for a server environment is different than for a desktop or laptop environment. Servers are typically installed in a rack within a data center; desktops or laptops are typically placed on office desks or cubicles. Always look for a large open flat work area that is free of clutter and large enough to deploy the ESD kit with additional space to accommodate the type of computer that is being repaired. The workspace should also be free of insulators that can cause an ESD event. On the work area, insulators such as styrofoam and other plastics should always be moved at least 12 inches or 30 centimeters away from sensitive parts before physically handling any hardware components.

ESD Packaging

All ESD-sensitive devices must be shipped and received in static-safe packaging. Metal, static-shielded bags are preferred. However, you should always return the damaged component using the same ESD bag and packaging that the new part arrived in. The ESD bag should be folded over and taped shut and all the same foam packing material should be used in the original box that the new part arrived in. ESD-sensitive devices should be removed from packaging only at an ESD-protected work surface, and parts should never be placed on top of the ESD bag because only the inside of the bag is shielded. Always place parts in your hand, on the anti-static mat, in the computer, or inside an ESD bag.

Components of an ESD Field Service kit

The components of an ESD Field Service kit are:

- **Anti-Static Mat** – The anti-static mat is dissipative and parts can be placed on it during service procedures. When using an anti-static mat, your wrist strap should be snug and the bonding wire should be connected to the anti-static mat and to any bare metal on the computer being worked on. Once deployed properly, service parts can be removed from the ESD bag and placed directly on the anti-static mat. ESD-sensitive items are safe in your hand, on the anti-static mat, in the computer, or inside an ESD bag.
- **Wrist Strap and Bonding Wire** – The wrist strap and bonding wire can be either directly connected between your wrist and bare metal on the hardware if the anti-static mat is not required, or connect to the anti-static mat to protect hardware that is temporarily placed on the mat. The physical connection of the wrist strap and bonding wire between your skin, the anti-static mat, and the hardware is known as bonding. Use only Field Service kits with a wrist strap, anti-static mat, and bonding wire. Never use wireless wrist straps. Always be cautious that the internal wires of a wrist strap are prone to damage from normal wear and tear, and must be checked regularly with a wrist strap tester in order to avoid accidental ESD hardware damage. It is recommended to test the wrist strap and bonding wire at least once per week.
- **ESD Wrist Strap Tester** – The wires inside an ESD strap are prone to damage over time. When using an unmonitored kit, it is a best practice to regularly test the strap prior to each service, and at a minimum, test once per week. A wrist strap tester is the best method for doing this test. To perform the test, plug the bonding-wire of the wrist-strap into the tester while it is strapped to your wrist and push the button to test. A green LED is lit if the test is successful; a red LED is lit and an alarm sounds if the test fails.

 **NOTE:** It is recommended to always use the traditional wired ESD grounding wrist strap and protective anti-static mat when servicing Dell products. In addition, it is critical to keep sensitive parts separate from all insulator parts while servicing the computer.

Transporting sensitive components

When transporting ESD sensitive components such as replacement parts or parts to be returned to Dell, it is critical to place these parts in anti-static bags for safe transport.

After working inside your computer

About this task

 **CAUTION:** Leaving stray or loose screws inside your computer may severely damage your computer.

Steps

1. Replace all screws and ensure that no stray screws remain inside your computer.
2. Connect any external devices, peripherals, or cables you removed before working on your computer.
3. Replace any media cards, discs, or any other components that you removed before working on your computer.
4. Connect your computer and all attached devices to their electrical outlets.
5. Turn on your computer.

BitLocker

 **CAUTION:** If BitLocker is not suspended before updating the BIOS, the BitLocker key is not recognized the next time you reboot the computer. You will then be prompted to enter the recovery key to progress, and the system displays a prompt for the recovery key on each reboot. If the recovery key is not known, this can result in data loss or an operating system reinstall. For more information, see Knowledge Article: [updating the BIOS on Dell systems with BitLocker enabled](#).

The installation of the following components triggers BitLocker:

- Hard disk drive or solid-state drive
- System board

Recommended tools

The procedures in this document may require the following tools:

- Phillips screwdriver #0
- Plastic scribe

Screw list















-  **NOTE:** When removing screws from a component, it is recommended to note the screw type and the quantity of screws, and then place them in a screw storage box. This is to ensure that the correct number of screws and correct screw type is restored when the component is replaced.
-  **NOTE:** Some computers have magnetic surfaces. Ensure that the screws are not left attached to such surfaces when replacing a component.
-  **NOTE:** Screw color may vary depending on the configuration ordered.

Table 28. Screw list

Component	Screw type	Quantity	Screw image
Base cover	M2x7.9 (captive)	2	
Base cover	M2x5.5	5	
Battery	M2x4.5 (captive)	5	
Fan	M2x2.5	3	
Solid state drive (SSD) thermal shield	M2x2.5	1	
Display hinges	M2.5x4.5	4	
WLAN-antenna module	M2x2.5	1	
WLAN-thermal shield	M2x2.5	1	
Heat sink	M2x2.5	4	
System board	M1.6x1.8	2	
Touchpad assembly	M1.6x1.8	9	
I/O board	M2x2.5	2	

Major components of Latitude 5455

The following image shows the major components of the Latitude 5455.

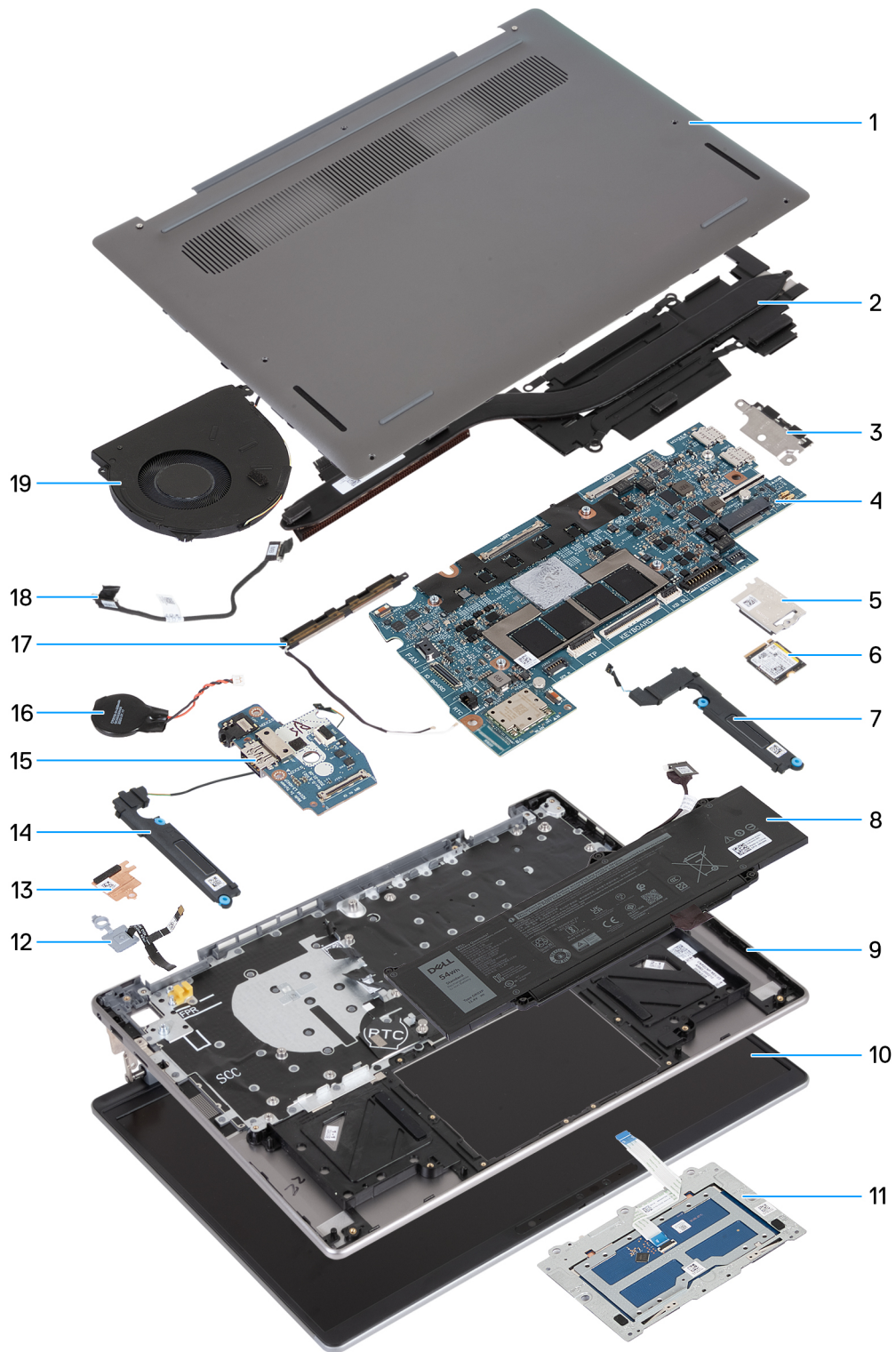



Figure 9. Major components of Latitude 5455

1. Base cover
2. Heat sink
3. USB Type-C bracket

NOTE: The USB Type-C bracket is bundled with the system board. DO NOT remove the USB Type-C bracket from the system board.

4. System board

5. Solid state drive (SSD) thermal shield
6. Solid state drive (SSD)
7. Left speaker
8. Battery
9. Palm-rest and keyboard assembly
10. Display assembly
11. Touchpad assembly
12. Power button with fingerprint reader (optional)

 **NOTE:** The power button on your computer may vary depending on the configuration that you have ordered.

13. WLAN thermal shield
14. Right speaker
15. I/O board
16. Coin-cell battery

 **NOTE:** The coin-cell battery is bundled with the system board.

17. WLAN-antenna module
18. I/O-board cable
19. Fan

 **NOTE:** Dell provides a list of components and their part numbers for the original computer configuration purchased. These parts are available according to warranty coverage purchased by the customer. Contact your Dell sales representative for purchase options.

Removing and installing Customer Replaceable Units (CRUs)

The replaceable components in this chapter are Customer Replaceable Units (CRUs).

 **CAUTION:** Customers can replace only the Customer Replaceable Units (CRUs) following the safety precautions and replacement procedures.

 **NOTE:** The images in this document may differ from your computer depending on the configuration you ordered.

Base cover

Removing the base cover

Prerequisites

1. Follow the procedure in [Before working inside your computer](#).

About this task

The following images indicate the location of the base cover and provide a visual representation of the removal procedure.

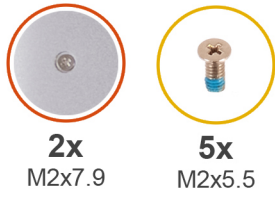

Figure 10. Removing the base cover

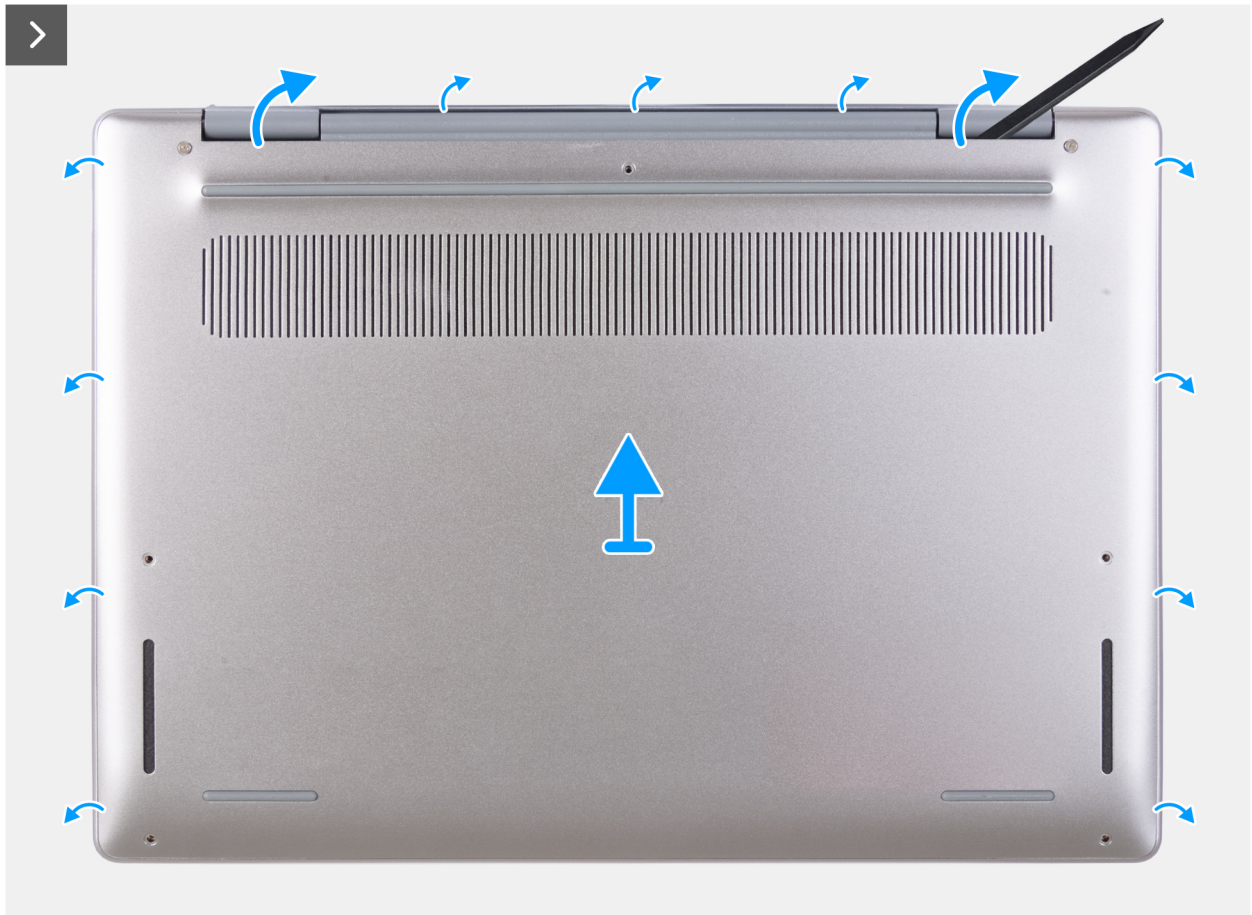

Figure 11. Removing the base cover

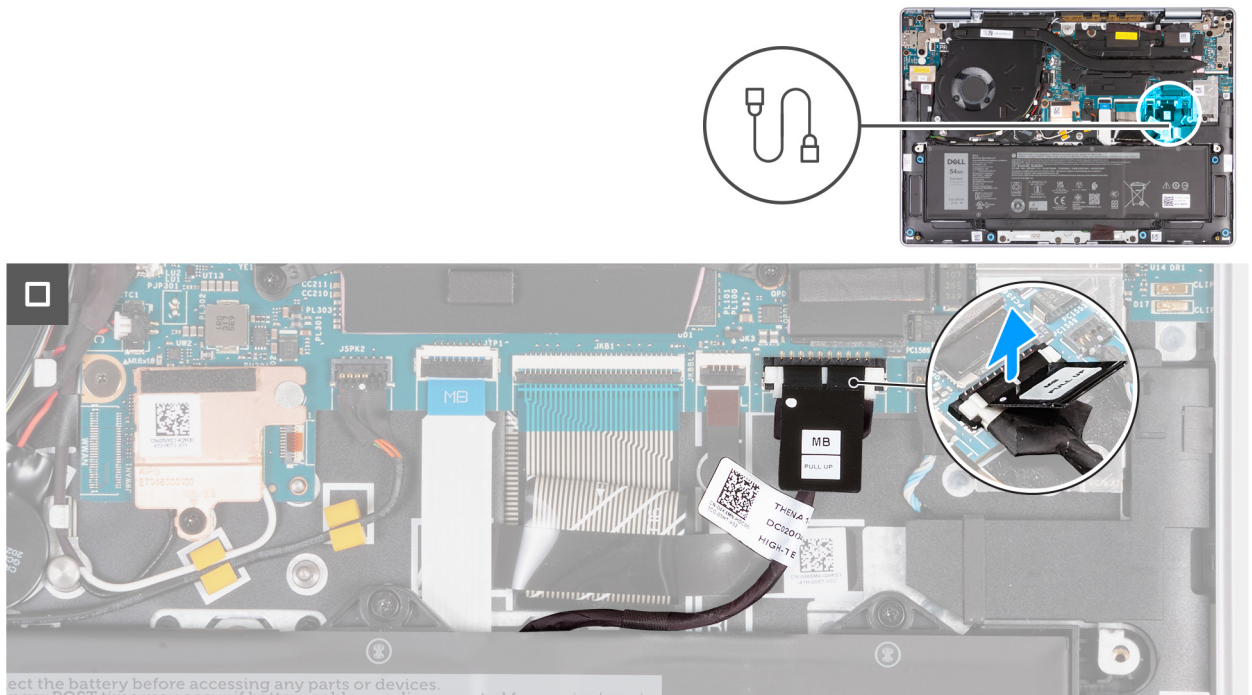

Figure 12. Disconnecting the battery cable

Steps

1. Remove the five screws (M2x5.5) that secure the base cover to the palm-rest and keyboard assembly.
NOTE: Ensure that you remove the five non-captive screws first to create the gap for prying the base cover off the palm-rest and keyboard assembly.
2. Loosen the two captive screws (M2x7.9) that secure the base cover to the palm-rest and keyboard assembly.
3. Using the plastic scribe, pry open the base cover from the recesses that are located near the display hinges.
4. Lift the base cover off the palm-rest and keyboard assembly.
5. Using the pull tab, lift the battery cable to disconnect the cable from the connector (JBATT1) on the system board.
6. Press and hold the power button for five seconds to ground the computer and drain the flea power.

Installing the base cover

Prerequisites

If you are replacing a component, remove the existing component before performing the installation procedure.

About this task

The following images indicate the location of the base cover and provide a visual representation of the installation procedure.

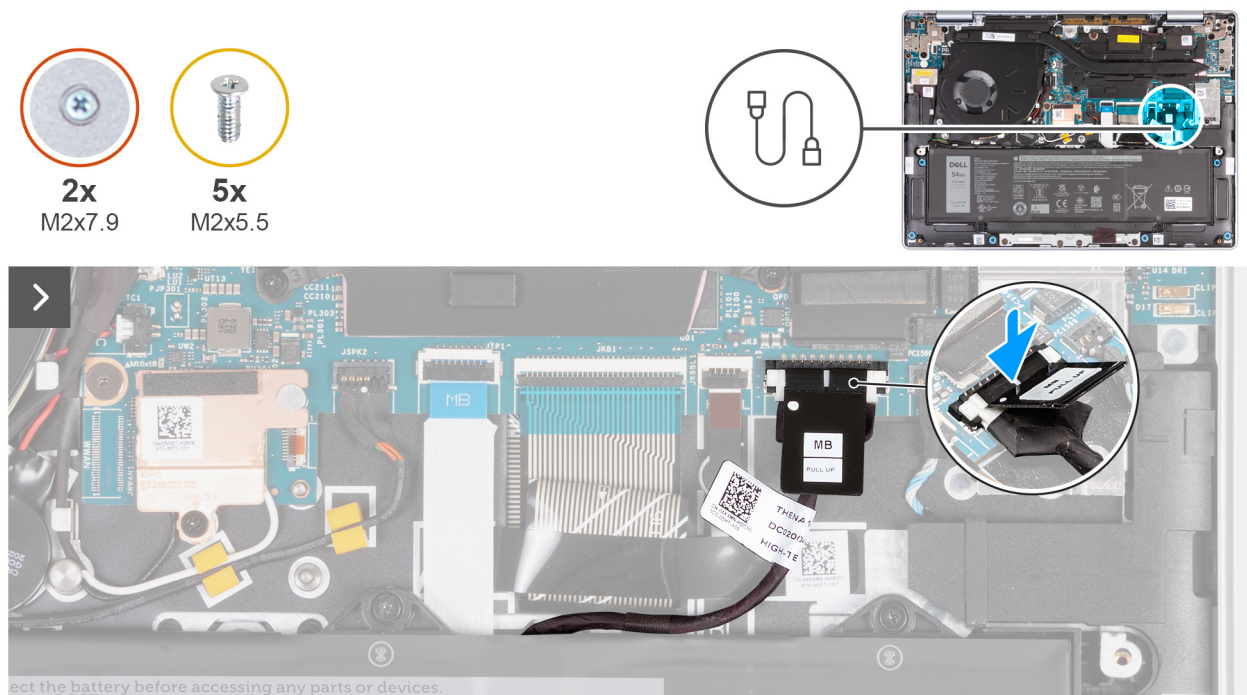

Figure 13. Connecting the battery cable

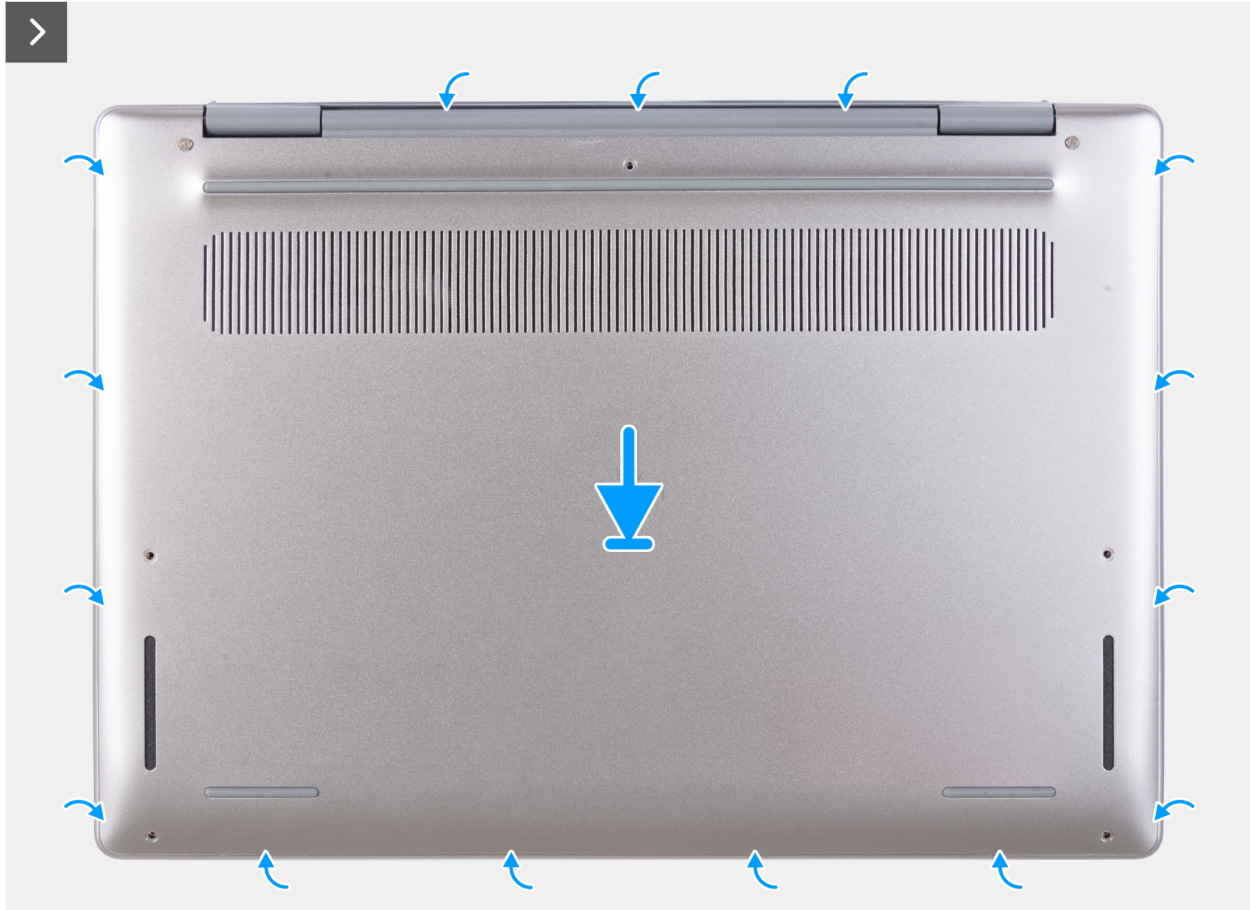
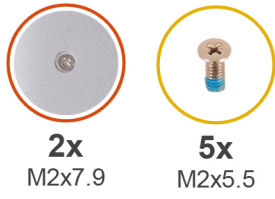

Figure 14. Installing the base cover



Figure 15. Tightening and replacing the screws

NOTE: If the battery is not a pre-requisite and if you have disconnected the battery cable, ensure that you connect the battery cable. To connect the battery cable, follow step 1 and step 2 in the procedure.

Steps

1. Connect and press down the battery-cable connector to connector (JBATT1) on the system board.
2. Align the screw holes on the base cover with the screw holes on the palm-rest and keyboard assembly, and then snap the base cover into place.
3. Tighten the two captive screws (M2x7.9) that secure the base cover to the palm-rest and keyboard assembly.
4. Replace the five screws (M2x5.5) that secure the base cover to the palm-rest and keyboard assembly.

Next steps

1. Follow the procedure in [After working inside your computer](#).

Solid state drive (SSD)

Removing the SSD

Prerequisites

1. Follow the procedure in [Before working inside your computer](#).
2. Remove the [base cover](#).

About this task

The following images indicate the location of the SSD and provide a visual representation of the removal procedure.

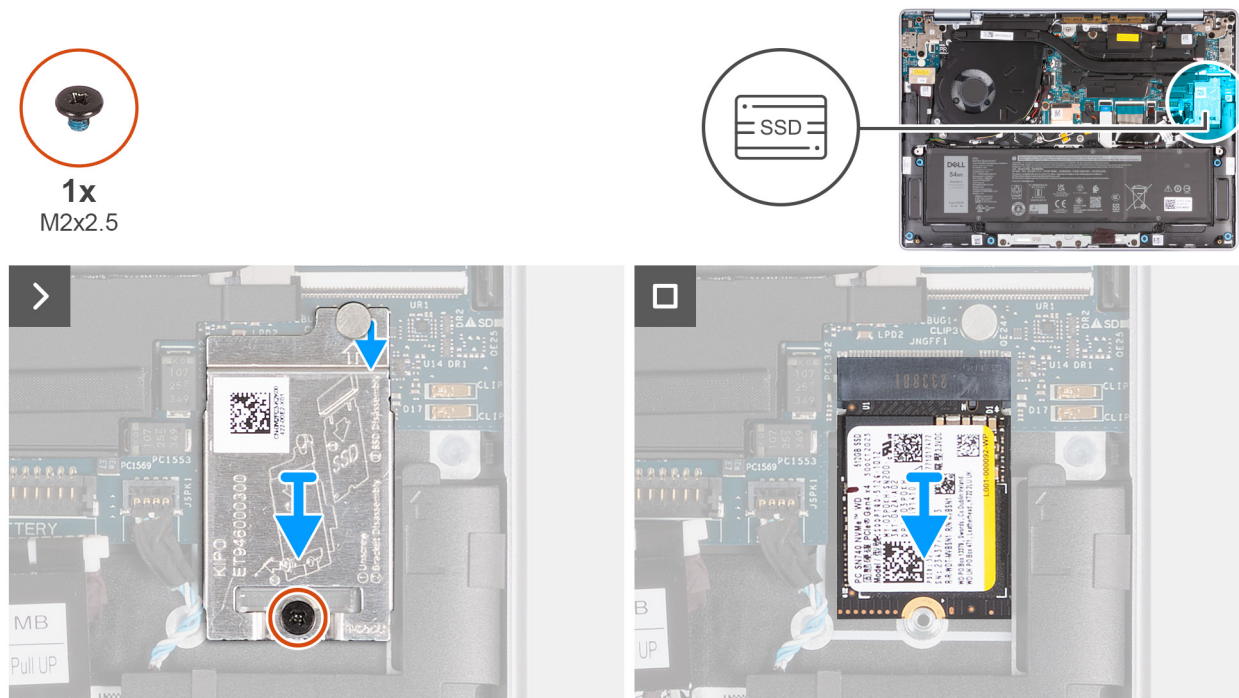

Figure 16. Removing the SSD

Steps

1. Remove the screw (M2x2.5) that secures the SSD thermal shield to the palm-rest and keyboard assembly.
2. Slide the SSD thermal shield downwards and lift the thermal shield off the computer.
 - i** **NOTE:** The SSD thermal shield includes a thermal pad that is attached to the bottom of the shield. Ensure that you adhere the thermal pad back to its location if it is displaced during the removal procedure.

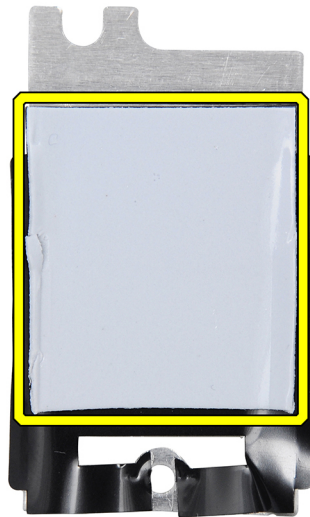

Figure 17. Thermal pad under the SSD thermal shield

3. Slide and lift the SSD out from the SSD slot.

Installing the SSD

Prerequisites

If you are replacing a component, remove the existing component before performing the installation procedure.

About this task

The following images indicate the location of the SSD and provide a visual representation of the installation procedure.

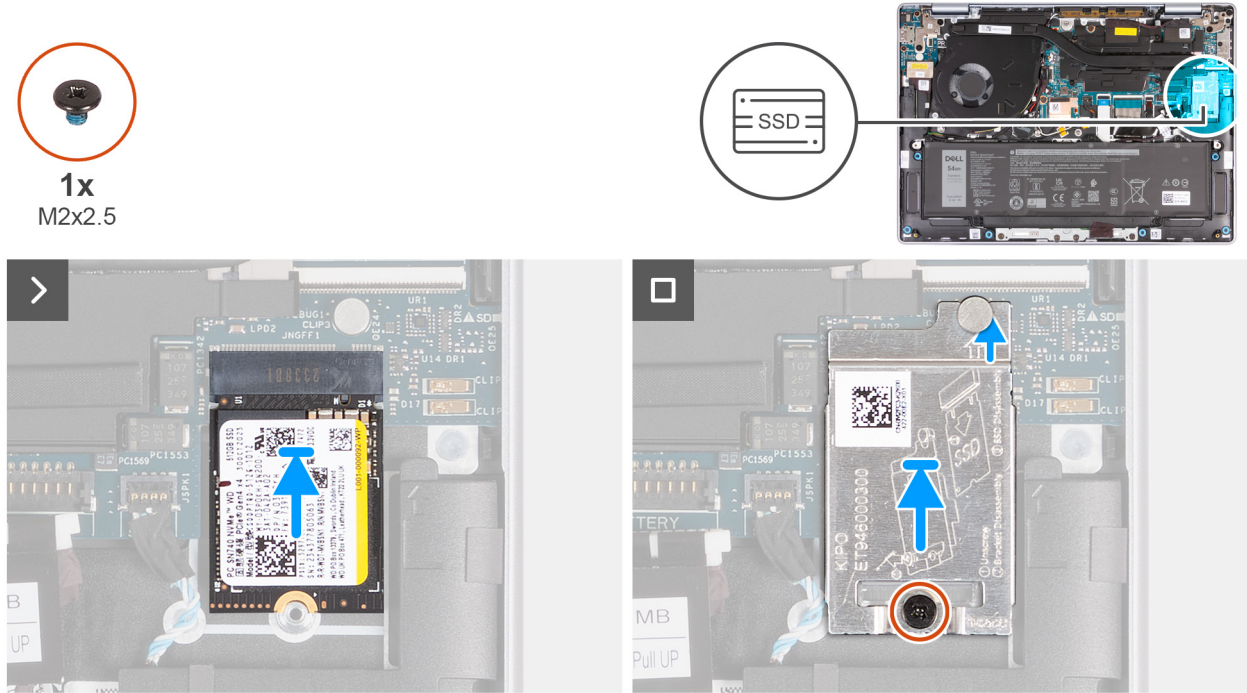

Figure 18. Installing the SSD

Steps

1. Align the notch on the SSD with the tab on the SSD slot on the system board.
2. Slide the SSD into the SSD slot on the computer.
3. Align the notch on the SSD thermal shield with the tab on the system board.

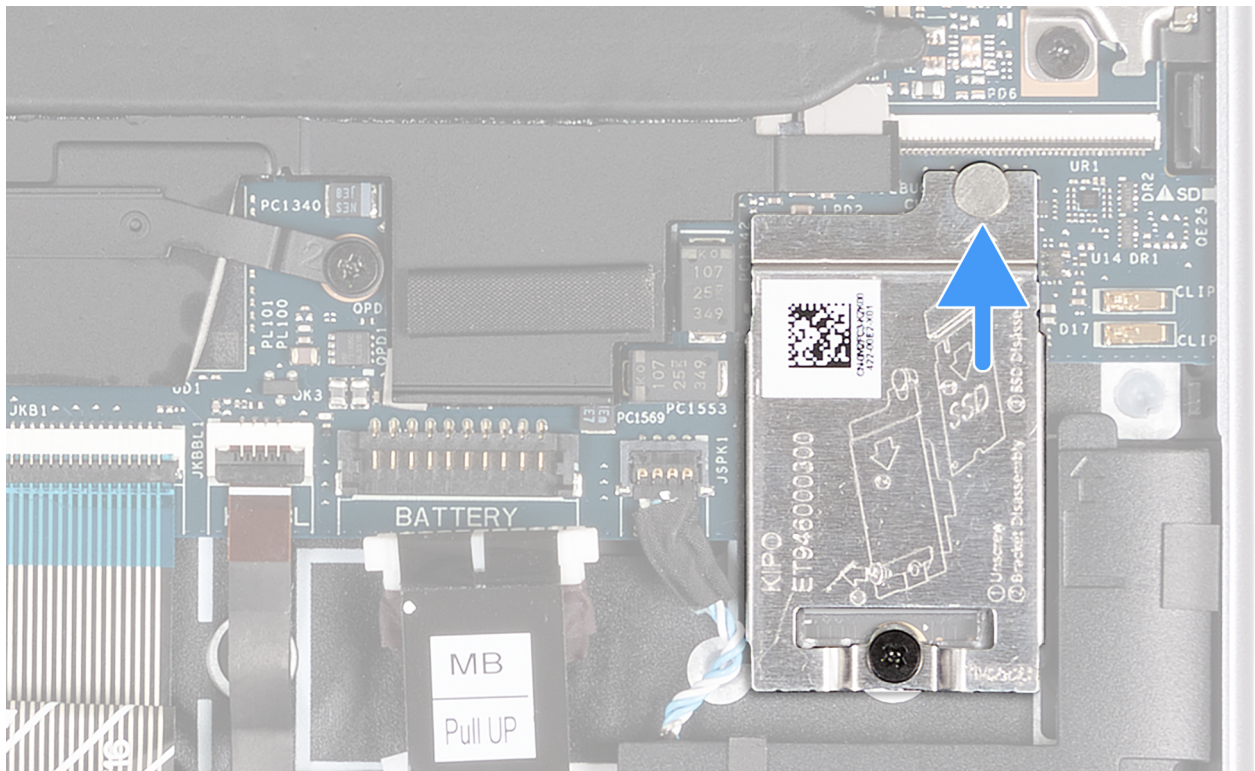

Figure 19. Installing the SSD thermal shield

NOTE: The SSD thermal shield includes a thermal pad that is attached to the bottom of the shield. Ensure that you adhere the thermal pad back to its location if it is displaced during the removal procedure.

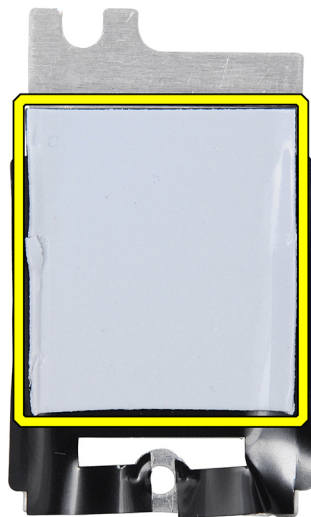

Figure 20. Thermal pad under the SSD thermal shield

4. Align the screw hole on the SSD thermal shield with the screw hole on the system board.
5. Replace the screw (M2x2.5) that secures the SSD thermal shield to the palm-rest and keyboard assembly.

Next steps

1. Install the [base cover](#).
2. Follow the procedure in [After working inside your computer](#).

Speakers

Removing the speakers

Prerequisites

1. Follow the procedure in [Before working inside your computer](#).
2. Remove the [base cover](#).

About this task

The following images indicate the location of the speakers and provide a visual representation of the removal procedure.

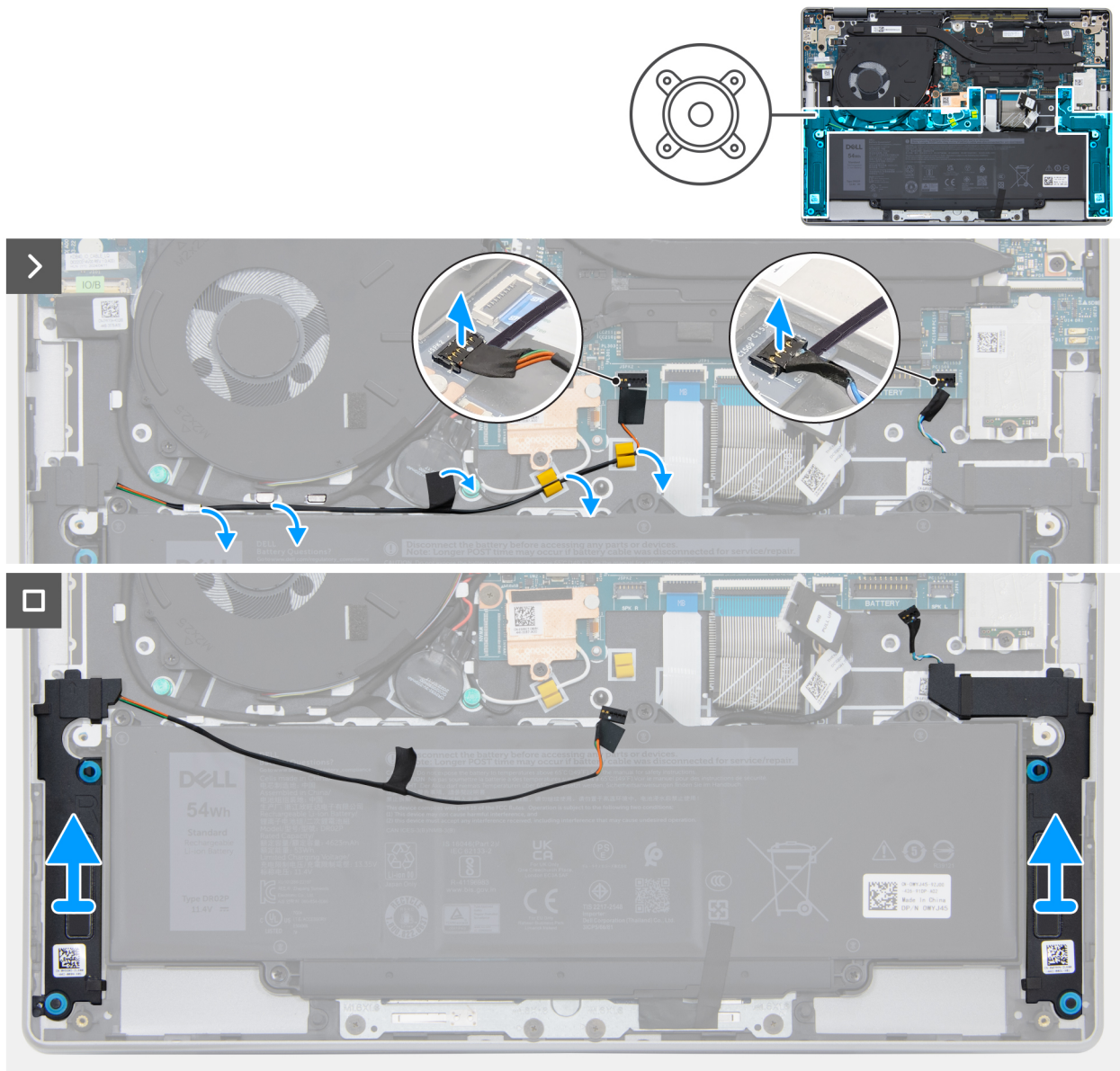

Figure 21. Removing the speakers

Steps

1. Disconnect the right-speaker cable from the connector (JSPK2) on the system board.

NOTE: DO NOT pull the speaker cable downwards to disconnect the cable from the system board. Instead, use a plastic scribe to pry up the bottom of the head of the cable connector first, and then lift it away from the connector.

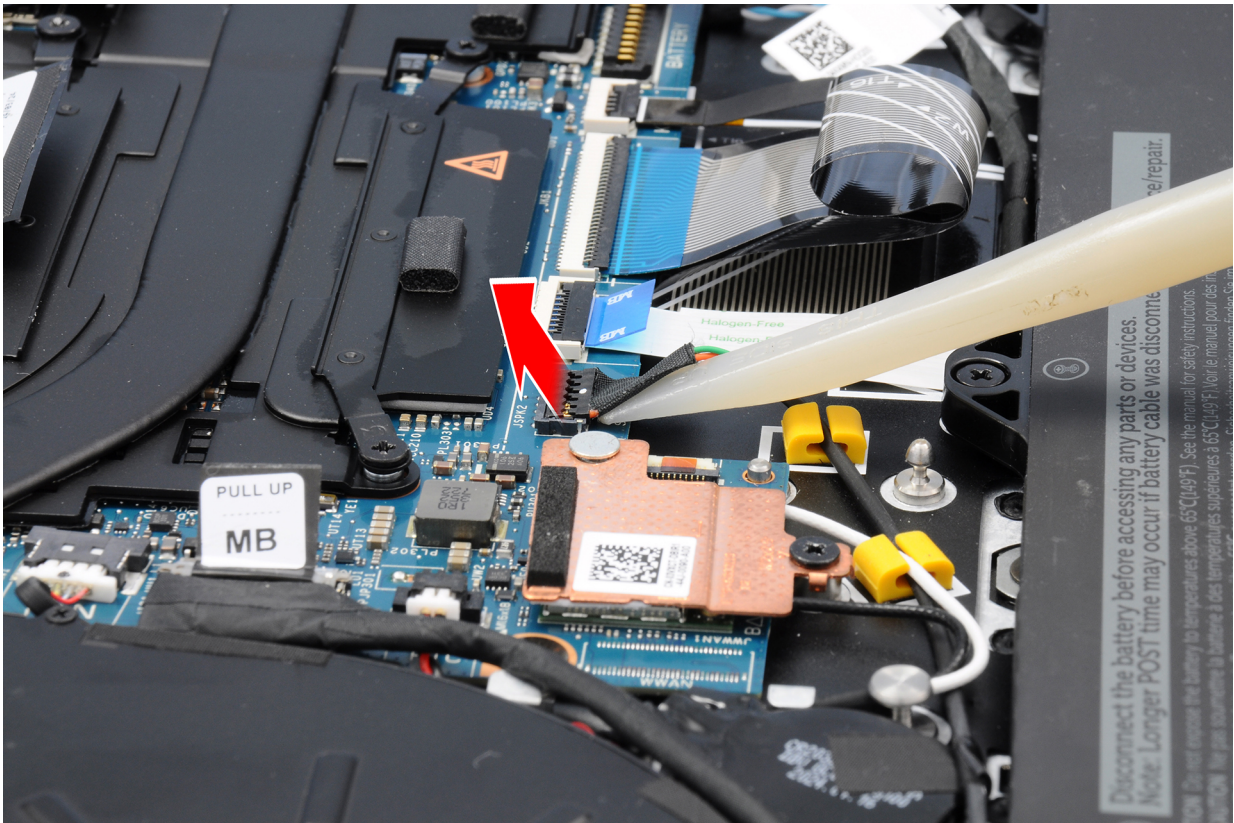

Figure 22. Prying the speaker cable from the connector

2. Peel the tape that adheres the speaker cable to the coin-cell battery.
3. Remove the speaker cable from the routing guides on the palm-rest and keyboard assembly.
4. Disconnect the left-speaker cable from the connector (JSPK1) on the system board.
5. Lift the speakers along with the cables off the palm-rest and keyboard assembly.

Installing the speakers

Prerequisites

If you are replacing a component, remove the existing component before performing the installation procedure.

About this task

The following images indicate the location of the speakers and provide a visual representation of the installation procedure.

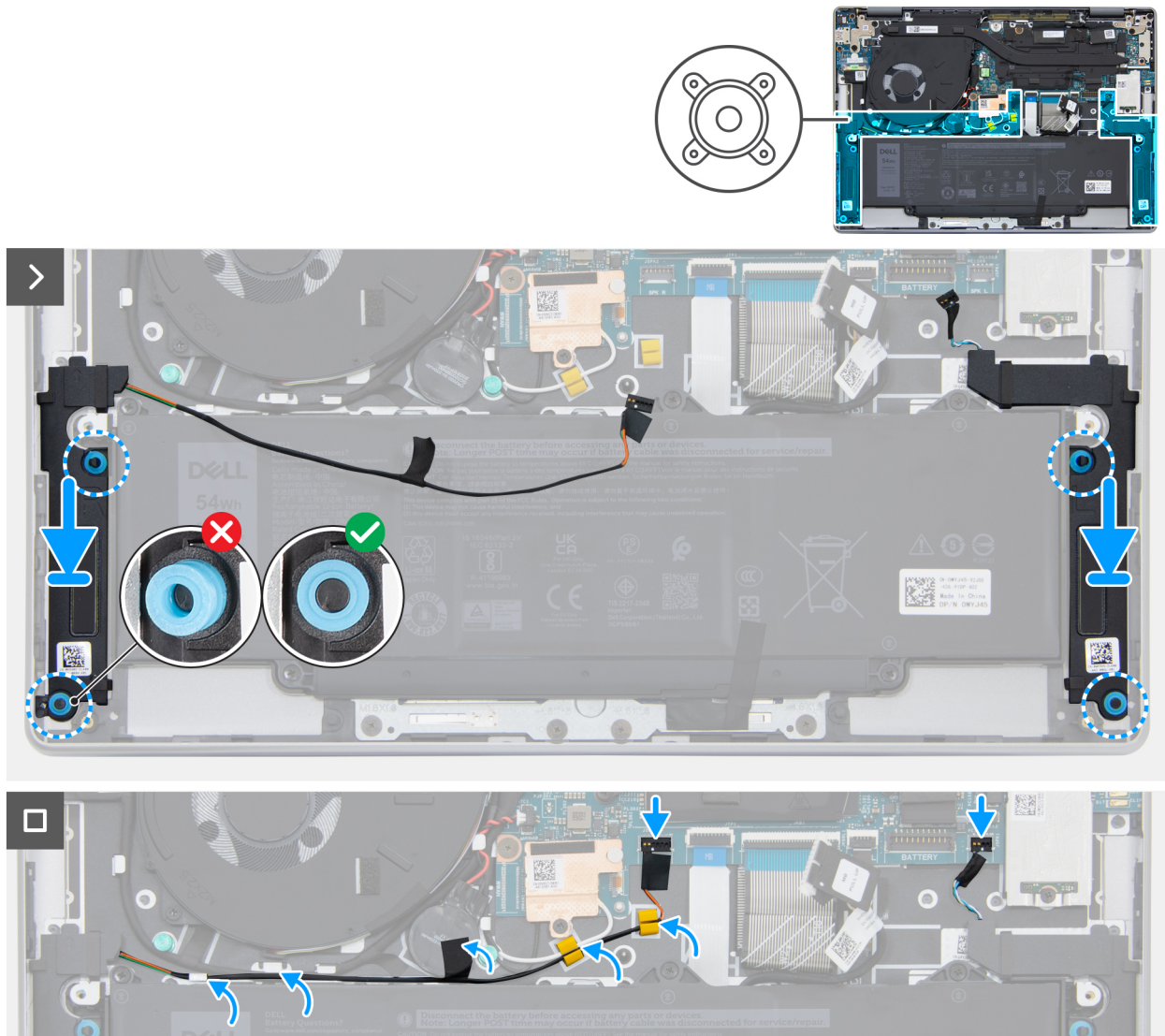

Figure 23. Installing the speakers

Steps

1. Using the alignment posts, place the right and left speakers into their slots on the palm-rest and keyboard assembly.

NOTE: Ensure that the rubber grommets are seated into the slot and installed on the speakers properly.



Figure 24. Installation of rubber grommets

2. Route the right-speaker cable through the routing guides on the palm-rest and keyboard assembly.
3. Adhere the tape on the speaker cable to the coin-cell battery.
4. Connect the right-speaker cable to the connector (JSPK2) on the system board.

5. Connect the left-speaker cable to the connector (JSPK1) on the system board.

Next steps

1. Install the [base cover](#).
2. Follow the procedure in [After working inside your computer](#).

Fan

Removing the fan

Prerequisites

1. Follow the procedure in [Before working inside your computer](#).
2. Remove the [base cover](#).

About this task

The following images indicate the location of the fan and provide a visual representation of the removal procedure.

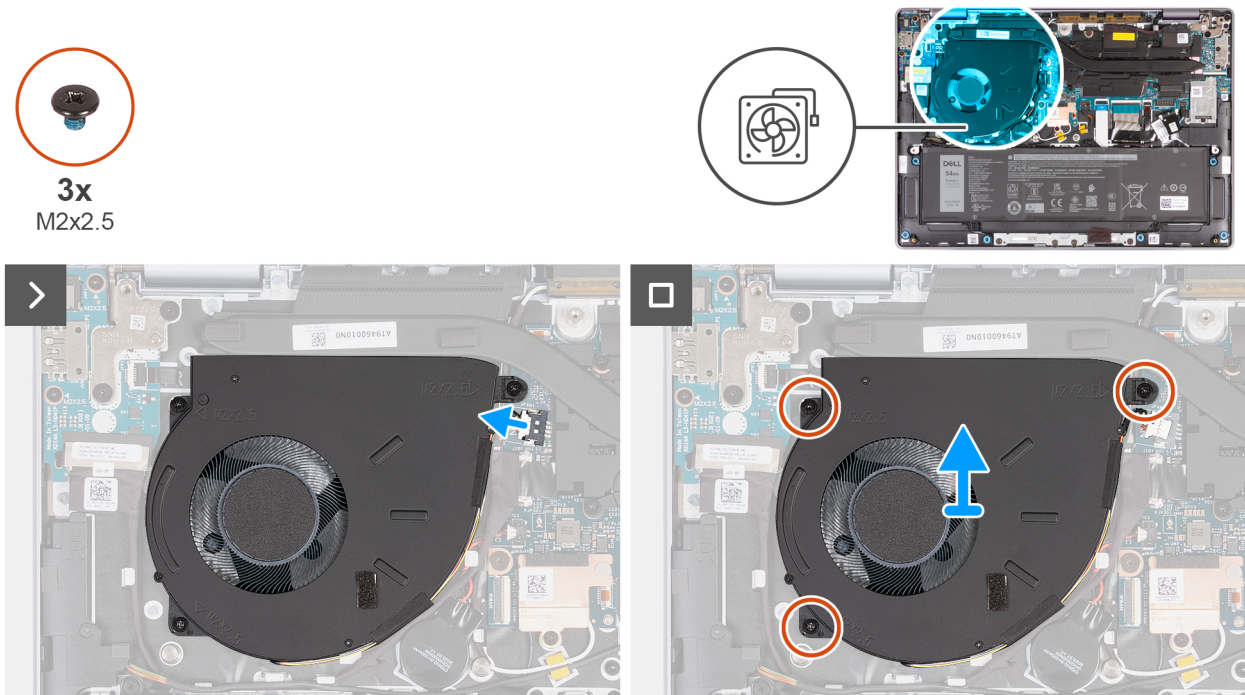

Figure 25. Removing the fan

Steps

1. Disconnect the fan cable from the connector (JFAN1) on the system board.
2. Remove the three screws (M2x2.5) that secure the fan to the palm-rest and keyboard assembly.
3. Lift the fan off the palm-rest and keyboard assembly.

Installing the fan

Prerequisites

If you are replacing a component, remove the existing component before performing the installation procedure.

About this task

The following images indicate the location of the fan and provide a visual representation of the installation procedure.

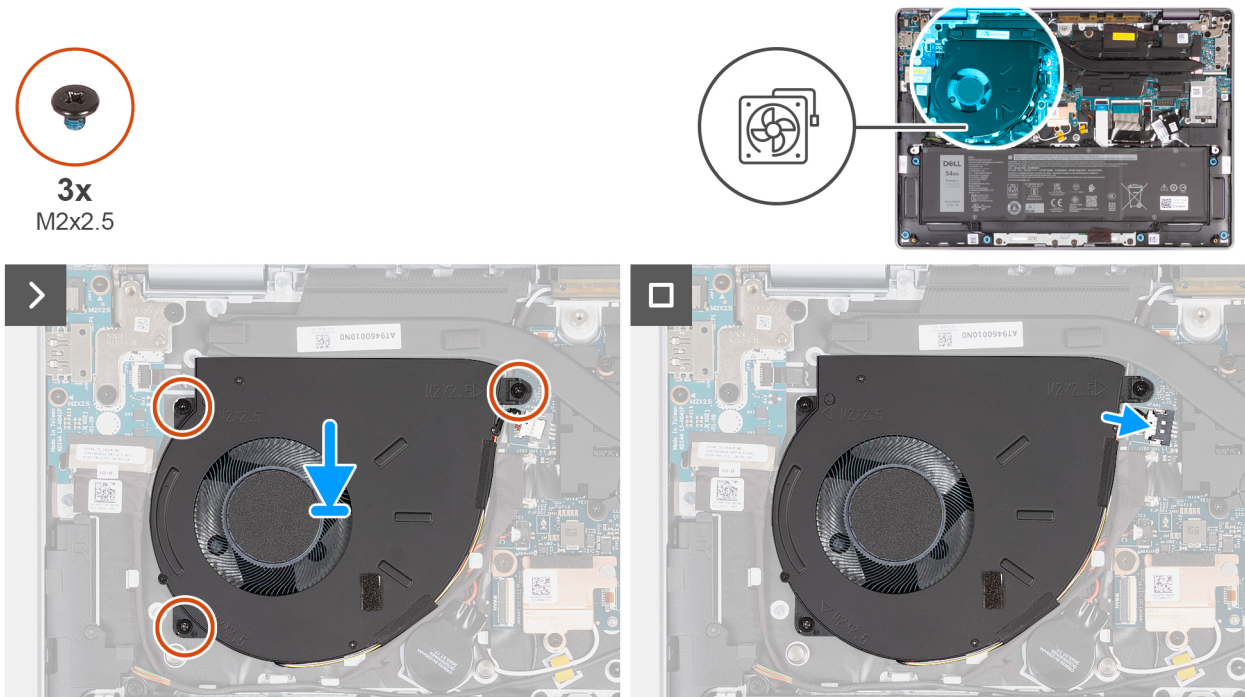

Figure 26. Installing the fan

Steps

1. Place and align the fan, along with the fan cable, in the slot on the palm-rest and keyboard assembly.

CAUTION: Avoid touching the fan blades to prevent damage.

2. Align the screw holes on the fan with the screw holes on the palm-rest and keyboard assembly.
3. Replace the three screws (M2x2.5) that secure the fan to the palm-rest and keyboard assembly.
4. Connect the fan cable to the connector (JFAN1) on the system board.

Next steps

1. Install the [base cover](#).
2. Follow the procedure in [After working inside your computer](#).

Removing and installing Field Replaceable Units (FRUs)

The replaceable components in this chapter are Field Replaceable Units (FRUs).

CAUTION: The information in this section is intended for authorized service technicians only.

CAUTION: To avoid any potential damage to the component or loss of data, ensure that an authorized service technician replaces the Field Replaceable Units (FRUs).

CAUTION: Dell Technologies recommends that this set of repairs, if needed, to be conducted by trained technical repair specialists.

CAUTION: As a reminder, your warranty does not cover damages that may occur during FRU repairs that are not authorized by Dell Technologies.

NOTE: The images in this document may differ from your computer depending on the configuration you ordered.

Battery

Rechargeable Li-ion battery precautions

CAUTION:

- Exercise caution when handling rechargeable Li-ion batteries.
- Discharge the battery completely before removing it. Disconnect the AC power adapter from the computer and operate the computer solely on battery power—the battery is fully discharged when the computer no longer turns on when the power button is pressed.
- Do not crush, drop, mutilate, or penetrate the battery with foreign objects.
- Do not expose the battery to high temperatures, or disassemble battery packs and cells.
- Do not apply pressure to the surface of the battery.
- Do not bend the battery.
- Do not use tools of any kind to pry on or against the battery.
- Ensure any screws during the servicing of this product are not lost or misplaced, to prevent accidental puncture or damage to the battery and other computer components.
- If the battery gets stuck inside your computer as a result of swelling, do not try to release it as puncturing, bending, or crushing a rechargeable Li-ion battery can be dangerous. In such an instance, contact Dell technical support for assistance. See [Contact Support at Dell Support Site](#).
- Always purchase genuine batteries from [Dell Site](#) or authorized Dell partners and resellers.
- Swollen batteries should not be used and should be replaced and disposed properly. For guidelines on how to handle and replace swollen rechargeable Li-ion batteries, see [Handling swollen rechargeable Li-ion batteries](#).

Removing the battery

CAUTION: The information in this removal section is intended for authorized service technicians only.

Prerequisites

1. Follow the procedure in [Before working inside your computer](#).
2. Remove the [base cover](#).

About this task

CAUTION: Removing the battery resets the BIOS setup settings to default. It is recommended that you note the BIOS setup settings before removing the battery.

The following images indicate the location of the battery and provide a visual representation of the removal procedure.

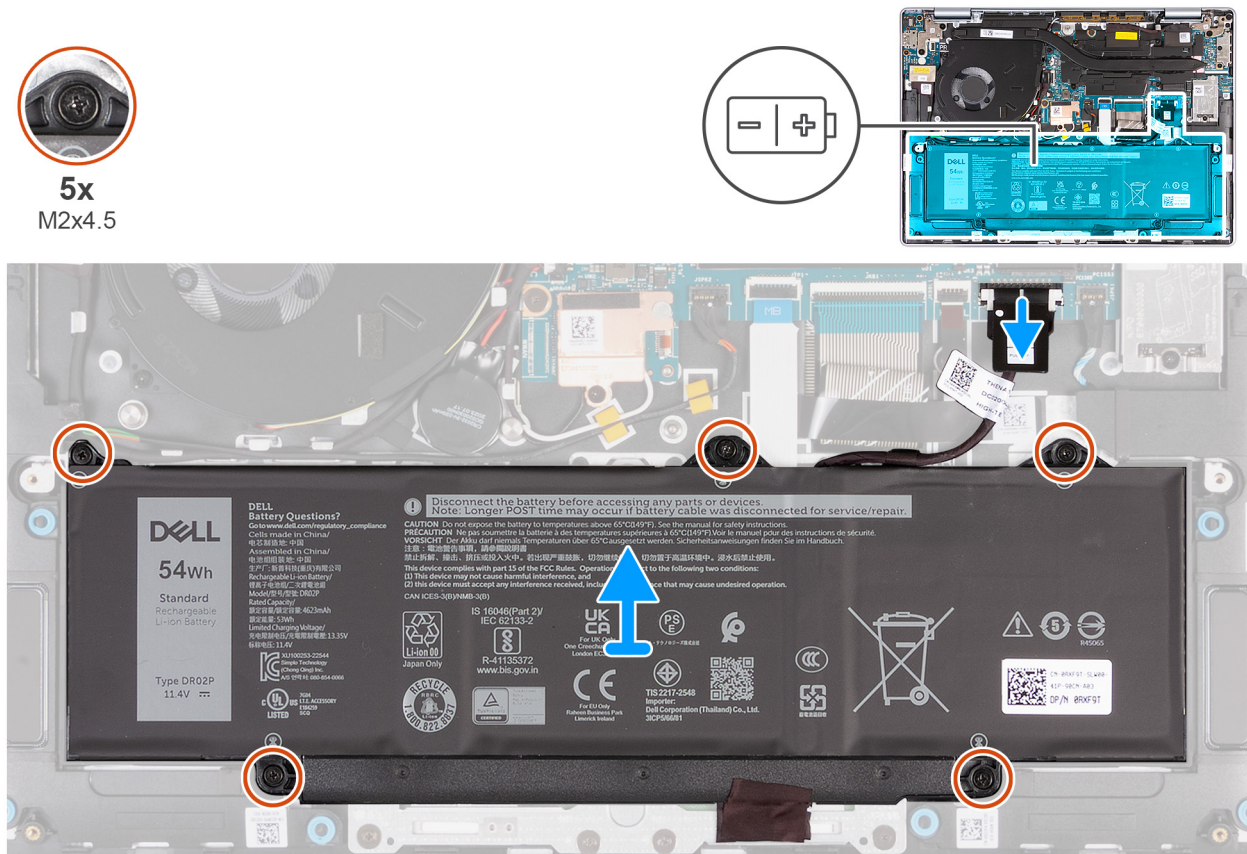

Figure 27. Removing the battery

Steps

1. Disconnect the battery cable from the connector (JBATT1) on the system board (if not disconnected earlier).
2. Loosen the five captive screws that secure the battery to the palm-rest and keyboard assembly.
3. Lift the battery off the palm-rest and keyboard assembly.

Installing the battery

CAUTION: The information in this installation section is intended for authorized service technicians only.

Prerequisites

If you are replacing a component, remove the existing component before performing the installation procedure.

About this task

The following images indicate the location of the battery and provide a visual representation of the installation procedure.



5x
M2x4.5

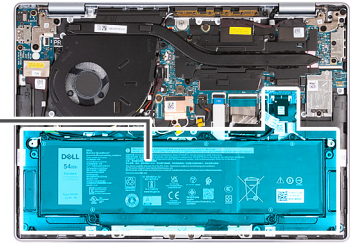
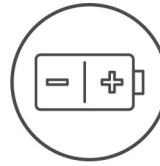

Figure 28. Installing the battery

Steps

1. Align the screw holes on the battery with the screw holes on the palm-rest and keyboard assembly.
2. Tighten the five captive screws that secure the battery to the palm-rest and keyboard assembly.
3. Connect the battery cable to the connector (JBATT1) on the system board.

Next steps

1. Install the [base cover](#).
2. Follow the procedure in [After working inside your computer](#).

Battery cable

Removing the battery cable

CAUTION: The information in this removal section is intended for authorized service technicians only.

Prerequisites

1. Follow the procedure in [Before working inside your computer](#).
2. Remove the [base cover](#).
3. Remove the [battery](#).

About this task

The following images indicate the location of the battery cable and provide a visual representation of the removal procedure.

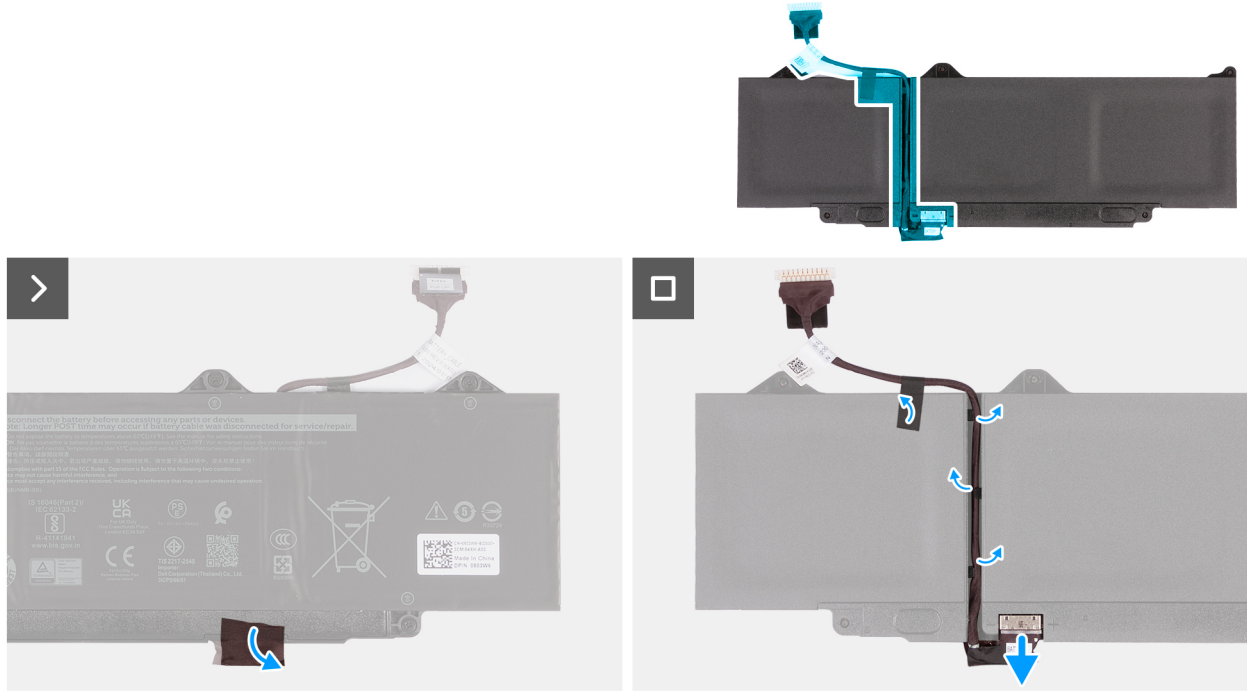

Figure 29. Removing the battery cable

Steps

1. Remove the Mylar that adheres the connector to the battery.
2. Turn the battery over and remove the Mylar that adheres the battery cable to the battery.
3. Disconnect the battery cable from the connector on the battery.
4. Remove the battery cable from the routing guides on the battery.

CAUTION: DO NOT pull the battery cable upwards to disconnect it from the battery. This action can damage the battery or battery cable.

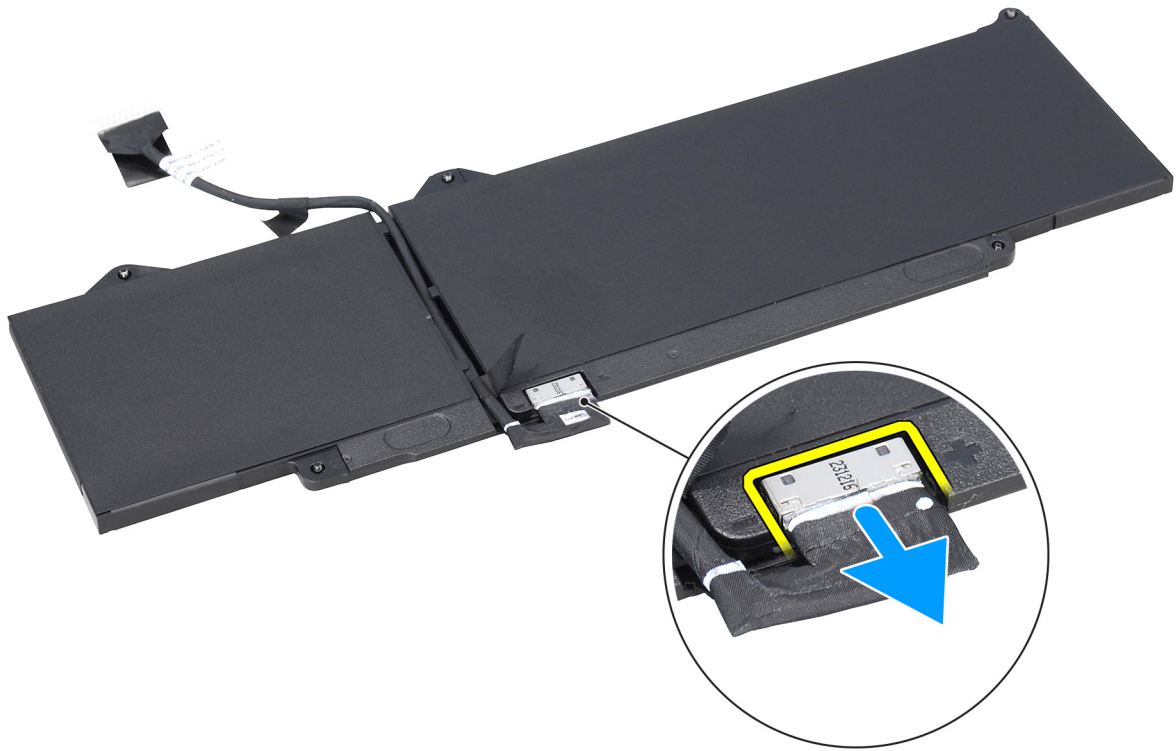

Figure 30. Disconnecting the battery cable

Installing the battery cable

CAUTION: The information in this installation section is intended for authorized service technicians only.

Prerequisites

If you are replacing a component, remove the existing component before performing the installation procedure.

About this task

The following images indicate the location of the battery cable and provide a visual representation of the installation procedure.

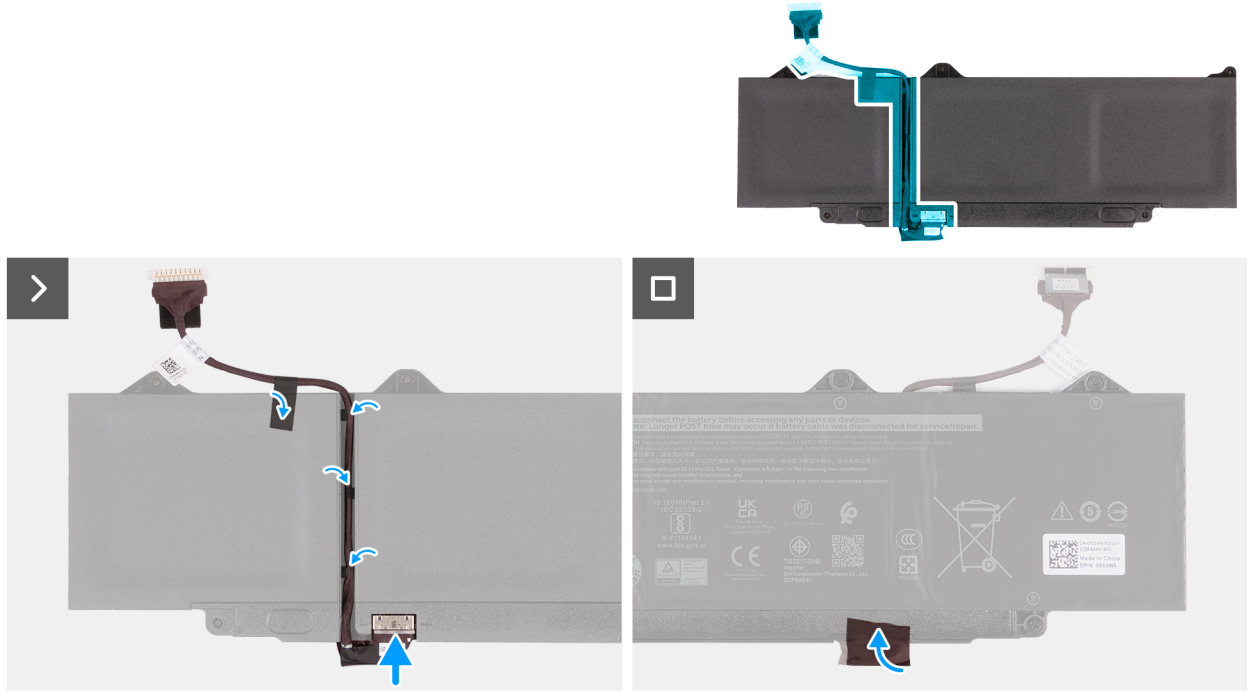

Figure 31. Installing the battery cable

Steps

1. Route the battery cable through the routing guides at the back of the battery.
2. Connect the battery cable to the connector on the battery.
3. Adhere the Mylar to secure the battery cable to the battery.
4. Turn the battery over and adhere the Mylar to secure the connector to the battery.

Next steps

1. Install the [battery](#).
2. Install the [base cover](#).
3. Follow the procedure in [After working inside your computer](#).

Heat sink

Removing the heat sink

CAUTION: The information in this removal section is intended for authorized service technicians only.

Prerequisites

1. Follow the procedure in [Before working inside your computer](#).
2. Remove the [base cover](#).

About this task

- NOTE:** The heat sink may become hot during normal operation. Allow sufficient time for the heat sink to cool before you touch it.
- NOTE:** For maximum cooling of the processor, do not touch the heat-transfer areas on the heat sink. The oils in your skin can reduce the heat-transfer capability of the thermal grease.

The following image indicates the location of the heat sink and provide a visual representation of the removal procedure.

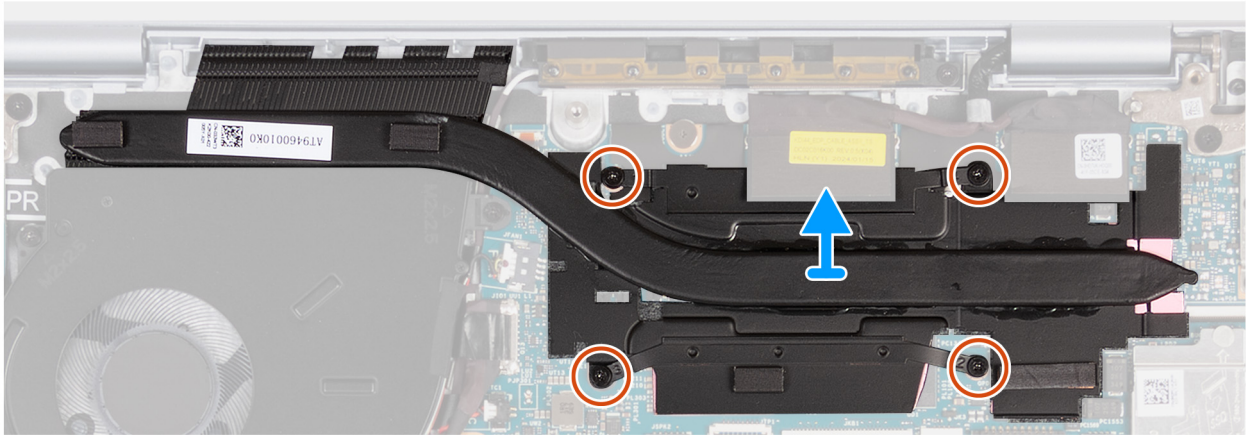
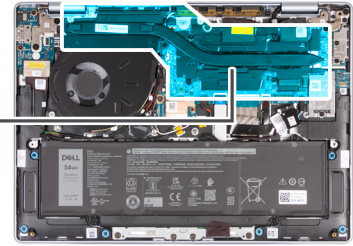

Figure 32. Removing the heat sink

Steps

1. In reverse sequential order (4 > 3 > 2 > 1), remove the four screws (M2x2.5) that secure the heat sink to the system board.
2. Lift the heat sink off the system board.

Installing the heat sink

CAUTION: The information in this installation section is intended for authorized service technicians only.

Prerequisites

If you are replacing a component, remove the existing component before performing the installation procedure.

About this task

NOTE: If either the system board or the heat sink is replaced, use the thermal grease that is provided in the kit to ensure that the thermal conductivity is achieved.

The following image indicates the location of the heat sink and provide a visual representation of the installation procedure.

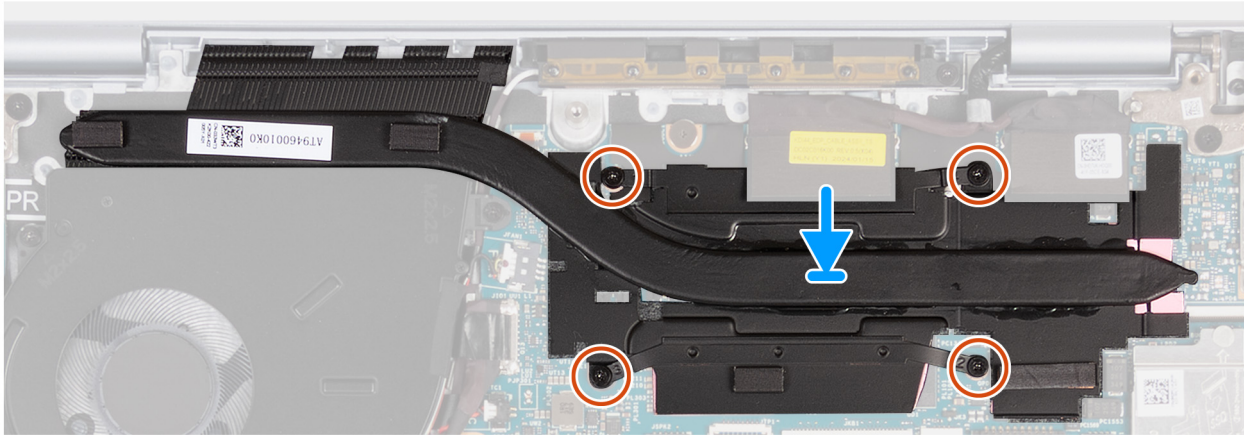
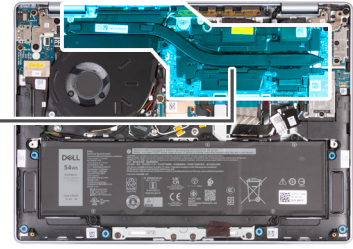

Figure 33. Installing the heat sink

Steps

1. Align the screw holes on the heat sink with the screw holes on the system board.
2. In sequential order (1 > 2 > 3 > 4), replace the four screws (M2x2.5) that secure the heat sink to the system board.

Next steps

1. Install the [base cover](#).
2. Follow the procedure in [After working inside your computer](#).

Coin-cell battery

Removing the coin-cell battery

CAUTION: The information in this removal section is intended for authorized service technicians only.

CAUTION: Removing the coin-cell battery clears the CMOS and also resets the settings of the BIOS setup program to default. It is recommended that you note the settings of the BIOS setup program before removing the coin-cell battery.

Prerequisites

1. Follow the procedure in [Before working inside your computer](#).
2. Remove the [base cover](#).

About this task

The following images indicate the location of the coin-cell battery and provide a visual representation of the removal procedure.

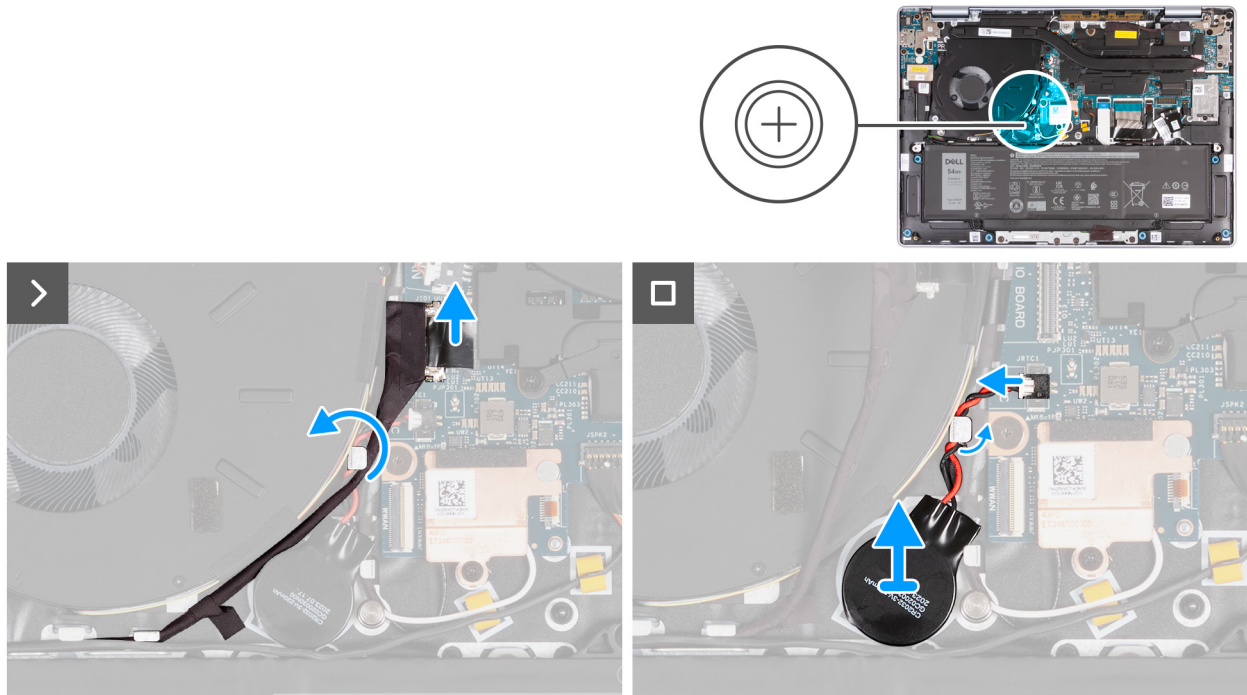

Figure 34. Removing the coin-cell battery

Steps

1. Disconnect the I/O-board cable from the connector (JIO1) on the system board.
2. Remove the I/O-board cable from the routing guide on the palm-rest and keyboard assembly.
3. Disconnect the coin-cell battery cable from the connector (JRTC1) on the system board.
4. Remove the coin-cell battery cable from the routing guides on the palm-rest and keyboard assembly.
5. Peel the coin-cell battery along with its cable off the palm-rest and keyboard assembly.

Installing the coin-cell battery

CAUTION: The information in this installation section is intended for authorized service technicians only.

Prerequisites

If you are replacing a component, remove the existing component before performing the installation procedure.

About this task

The following images indicate the location of the coin-cell battery and provide a visual representation of the installation procedure.

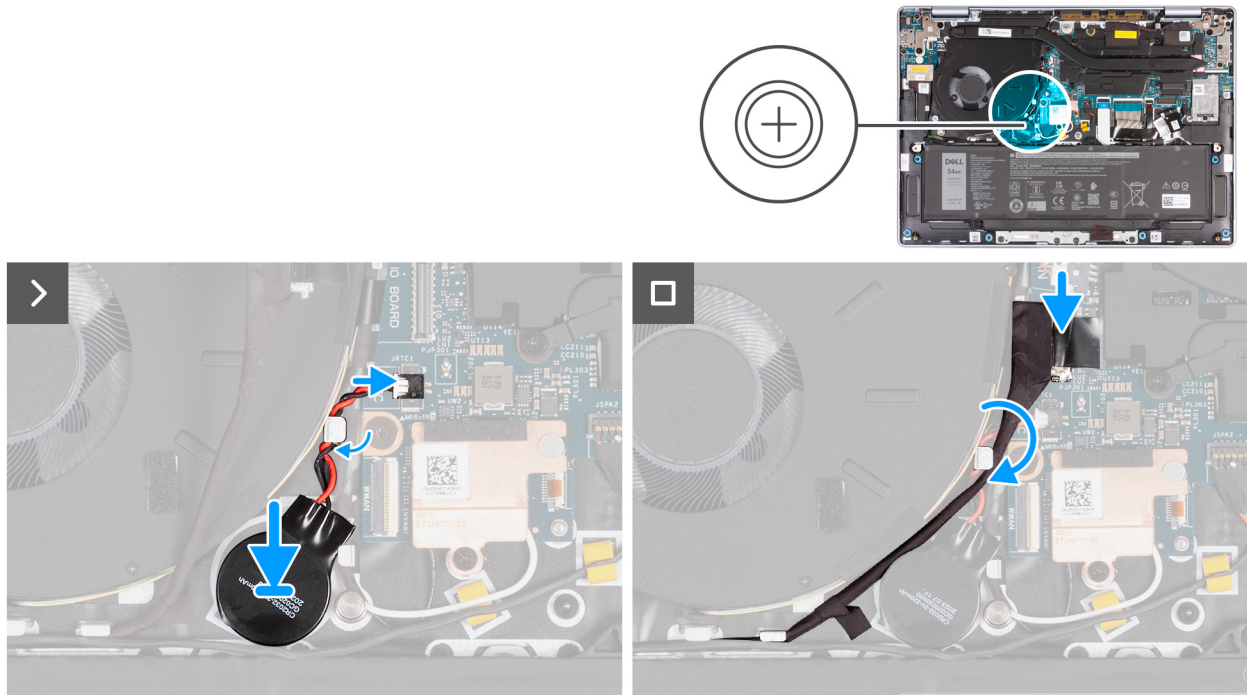

Figure 35. Installing the coin-cell battery

Steps

1. Adhere the coin-cell battery on to the coin-cell battery slot on the palm-rest and keyboard assembly.
2. Route the coin-cell battery cable through the routing guides on the palm-rest and keyboard assembly.
3. Connect the coin-cell battery cable to the connector (JRTC1) on the system board.
4. Route the I/O-board cable through the routing guides and connect it to the connector (JIO1) on the system board.
5. Connect the I/O-board cable to the connector (JIO1) on the system board.

Next steps

1. Install the [base cover](#).
2. Follow the procedure in [After working inside your computer](#).

I/O-board cable

Removing the I/O-board cable

CAUTION: The information in this removal section is intended for authorized service technicians only.

Prerequisites

1. Follow the procedure in [Before working inside your computer](#).
2. Remove the [base cover](#).

About this task

The following image indicates the location of the I/O-board cable on the palm-rest and keyboard assembly.

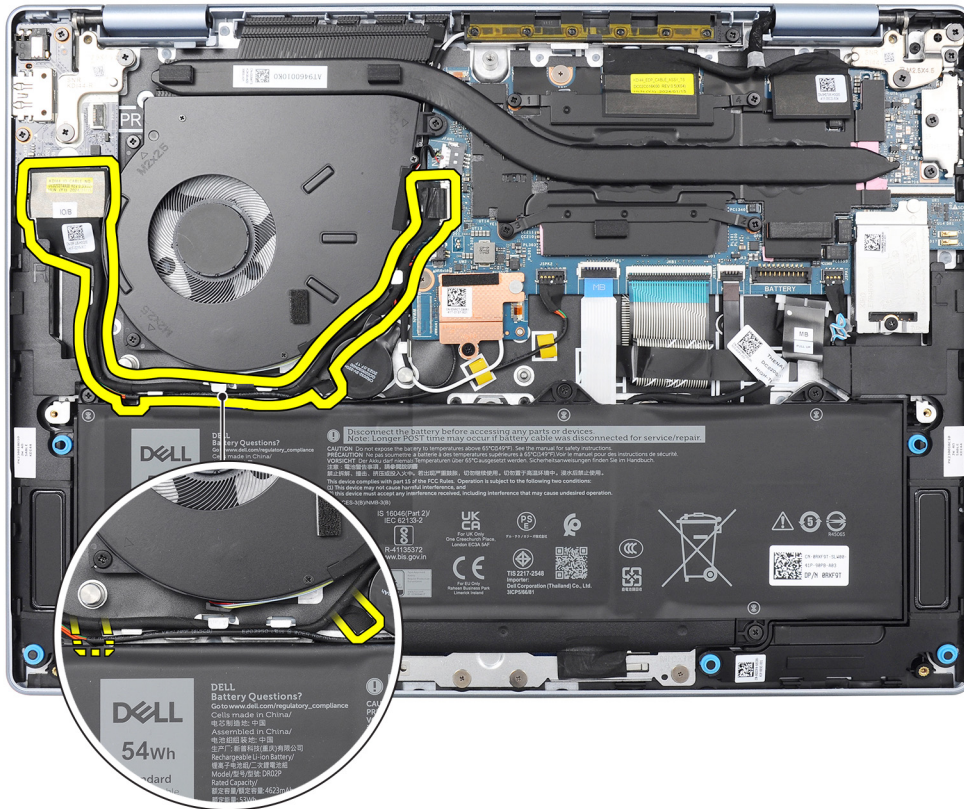

Figure 36. Location of the I/O-board cable

The following images indicate the location of the I/O-board cable and provide a visual representation of the removal procedure.

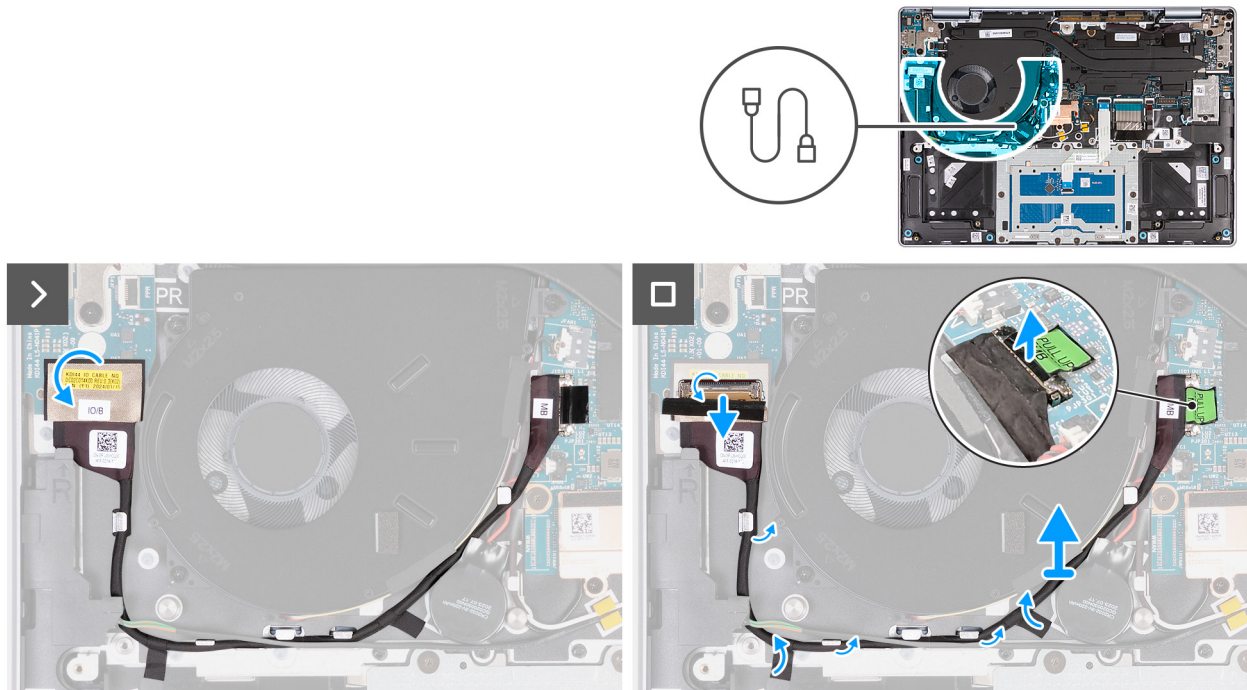

Figure 37. Removing the I/O-board cable

NOTE: The I/O-board cable is routed along the bottom-right of the fan and secured in place by two pieces of tape.

Steps

1. Peel the tape that secures the I/O-board cable to the connector (JIO1) on the I/O board.
2. Open the latch and disconnect the I/O-board cable from the connector (JIO1) on the I/O board.
3. Remove the I/O-board cable from the routing guides on the palm-rest and keyboard assembly.
4. Lift the pull tab upwards to disconnect the I/O-board cable from the connector (JIO1) on the system board.
5. Lift the I/O-board cable off the computer.

Installing the I/O-board cable

CAUTION: The information in this installation section is intended for authorized service technicians only.

Prerequisites

If you are replacing a component, remove the existing component before performing the installation procedure.

About this task

The following image indicates the location of the I/O-board cable on the palm-rest and keyboard assembly.

NOTE: The I/O-board cable is routed along the bottom-right side of the fan and secured in place by two pieces of tape.

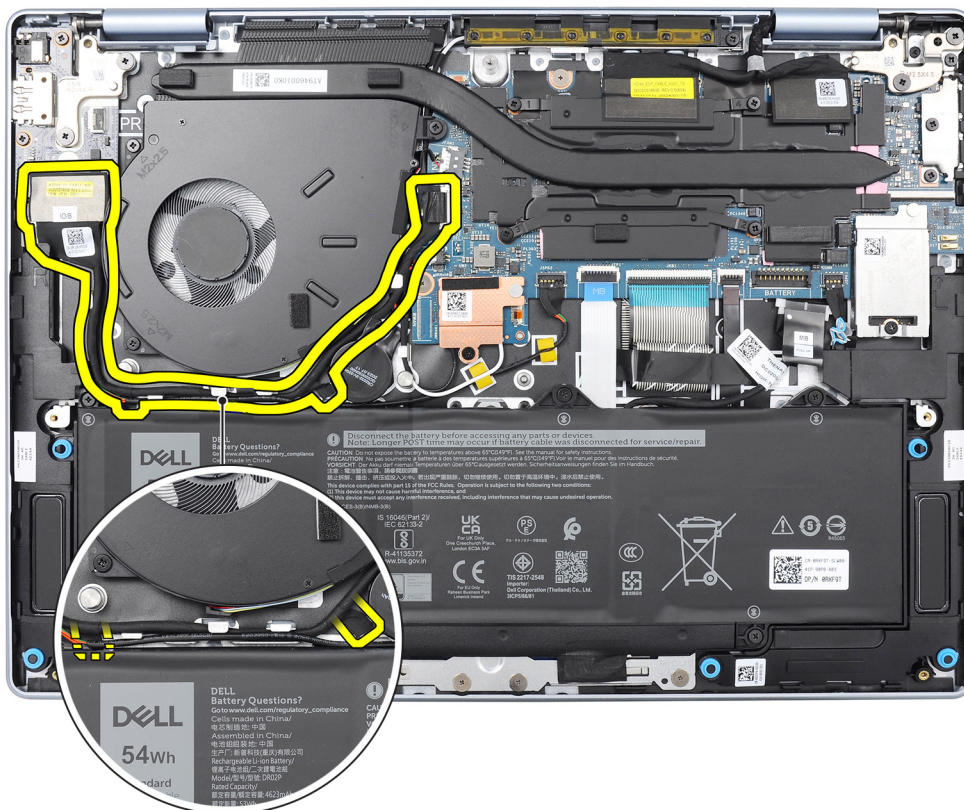

Figure 38. Location of the I/O-board cable

The following images indicate the location of the I/O-board cable and provide a visual representation of the installation procedure.

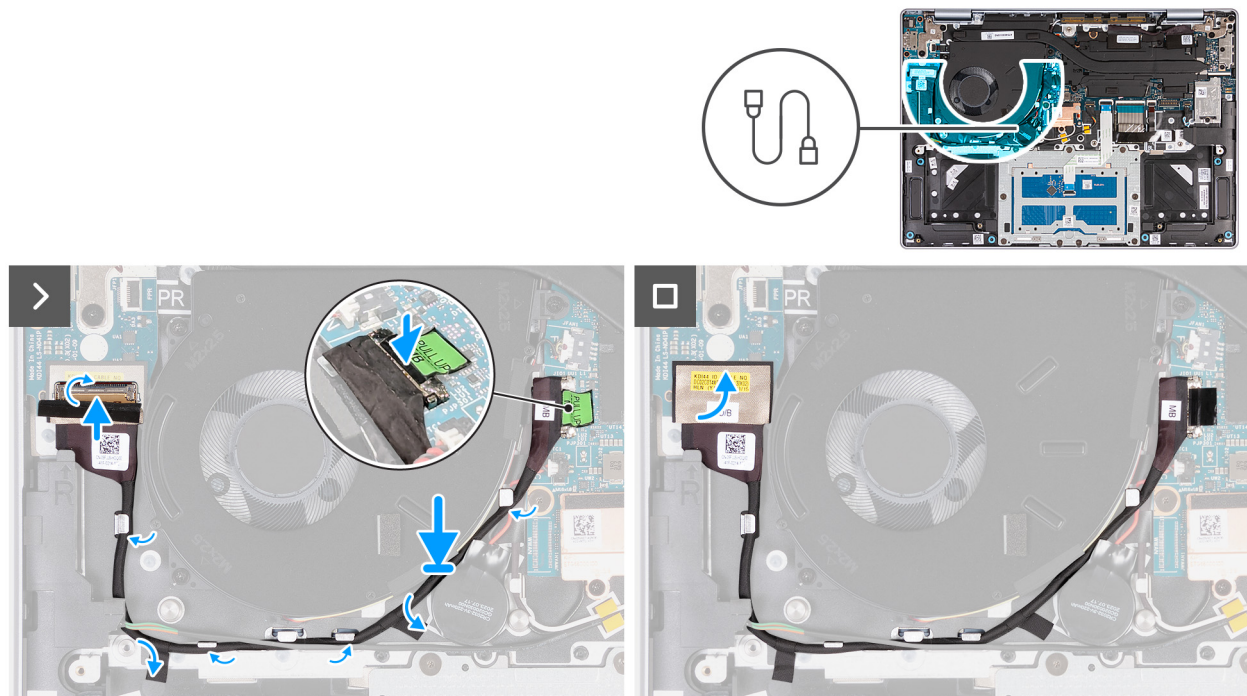

Figure 39. Installing the I/O-board cable

Steps

1. Connect the I/O-board cable to the connector (JIO1) on the I/O board and close the latch to secure the cable in place.
2. Route the I/O-board cable through the routing guides on the palm-rest and keyboard assembly.
3. Connect and press down the I/O-board cable connector to the connector (JIO1) on the system board.
4. Adhere the tape to secure the I/O-board cable to the connector (JIO1) on the I/O board.

Next steps

1. Install the [base cover](#).
2. Follow the procedure in [After working inside your computer](#).

WLAN-antenna module

Removing the WLAN-antenna module

⚠ CAUTION: The information in this removal section is intended for authorized service technicians only.

Prerequisites

1. Follow the procedure in [Before working inside your computer](#).
2. Remove the [base cover](#).
3. Remove the [fan](#).

About this task

The following images indicate the location of the WLAN-antenna module and provide a visual representation of the removal procedure.



2x
M2x2.5

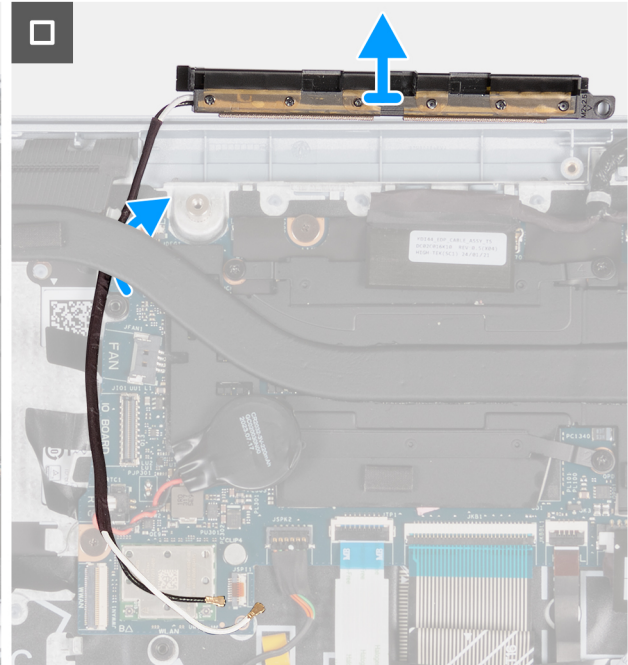
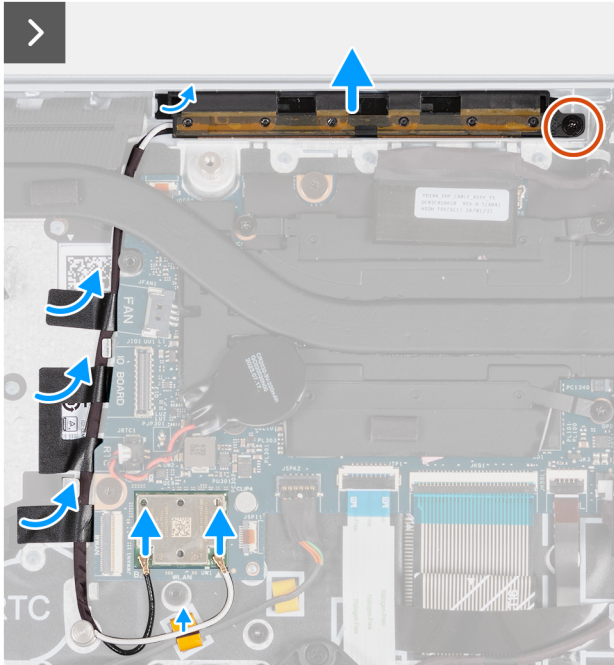
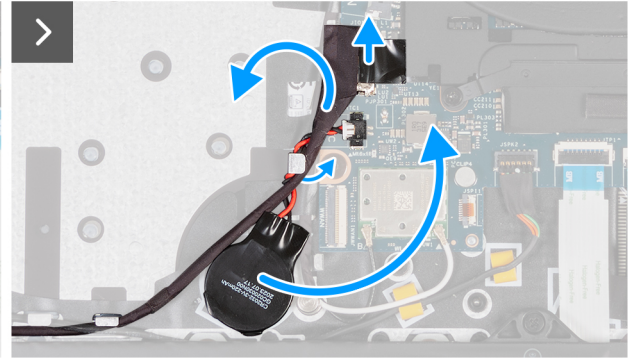
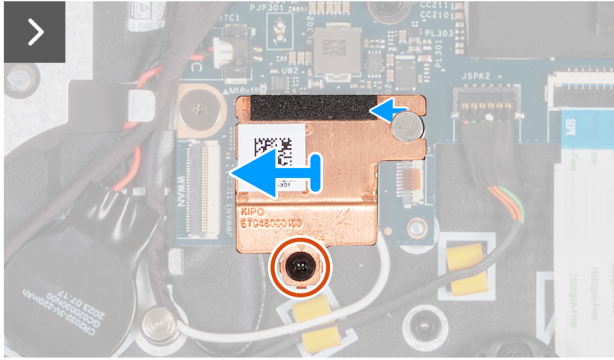
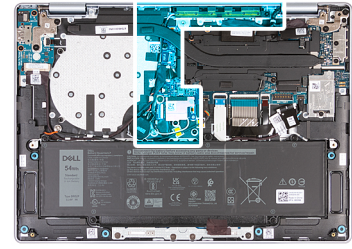

Figure 40. Removing the WLAN-antenna module

Steps

1. Remove the screw (M2x2.5) that secures the WLAN-thermal shield to the WLAN module.
2. Slide the WLAN-thermal shield to the left and lift the shield off the palm-rest and keyboard assembly.

NOTE: The WLAN-thermal shield includes a thermal pad that is attached to the bottom of the shield. Ensure that you adhere the thermal pad back to its location if it is displaced during the removal procedure.

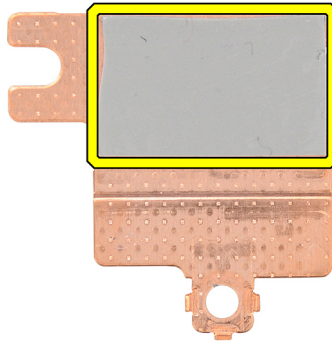

Figure 41. Thermal pad below the WLAN-thermal shield

3. Disconnect the WLAN-antenna cables from the connectors (B and W) on the WLAN module.
4. Disconnect the I/O cable (MB) from the connector (JIO1) on the system board.
5. Peel the coin-cell battery and move it along with its cable from the routing guide on the palm-rest and keyboard assembly.
6. Peel away the Mylar that secures the WLAN-antenna cables to the palm-rest and keyboard assembly.
7. Remove the screw (M2x2.5) that secures the WLAN-antenna module to the palm-rest and keyboard assembly.
8. Remove the WLAN-antenna cables from the routing guides on the palm-rest and keyboard assembly.

NOTE: Ensure that you remove the antenna cables from its routing guides under the heat sink.

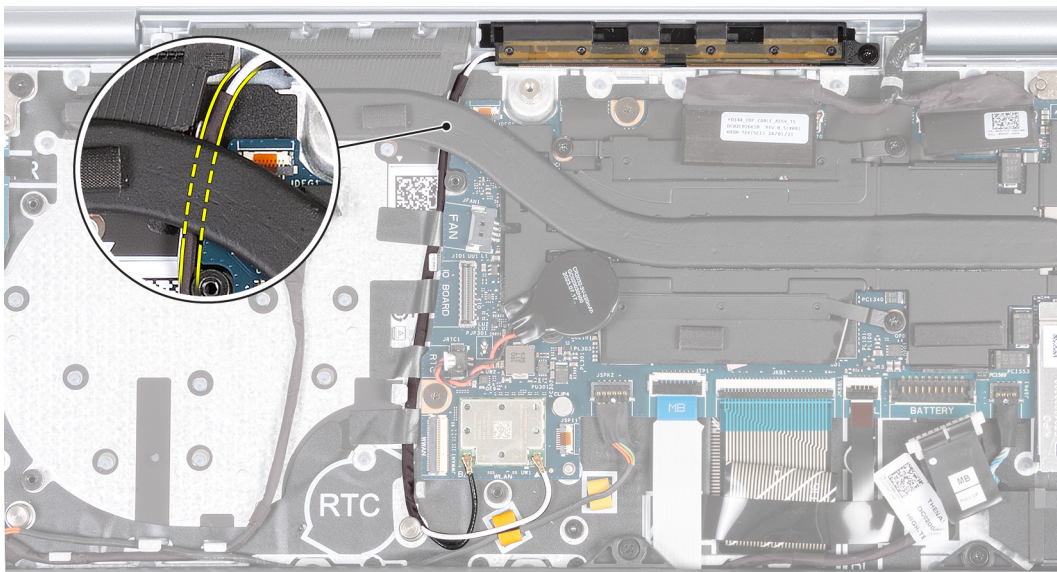

Figure 42. Removing WLAN-antenna cables

9. Lift the WLAN-antenna module off the palm-rest and keyboard assembly, ensuring that you thread the WLAN-antenna cables through the routing guide beneath the heat sink.

Installing the WLAN-antenna module

CAUTION: The information in this installation section is intended for authorized service technicians only.

Prerequisites

If you are replacing a component, remove the existing component before performing the installation procedure.

About this task

The following images indicate the location of the WLAN-antenna module and provide a visual representation of the installation procedure.

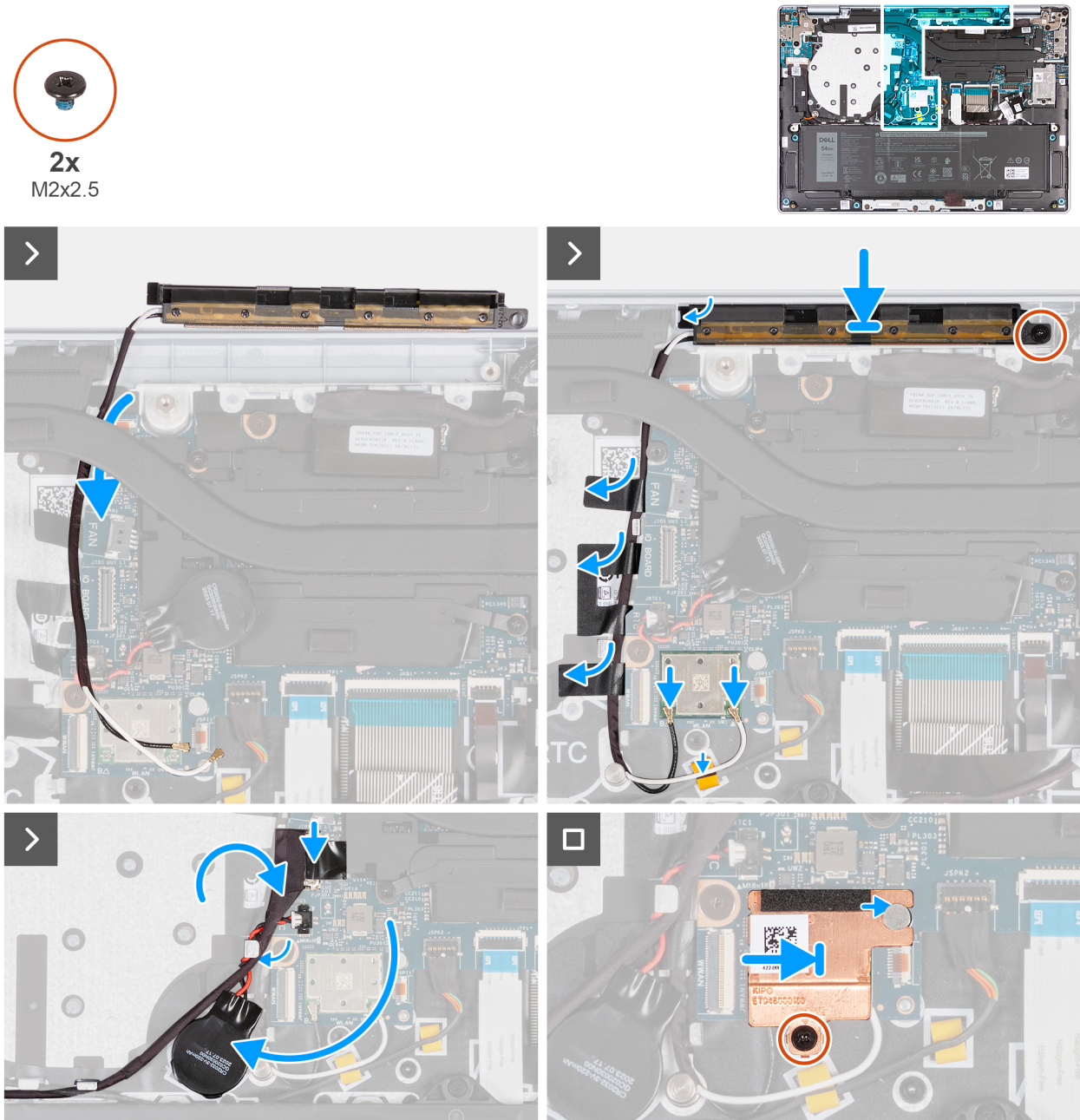

Figure 43. Installing the WLAN-antenna module

Steps

1. Route the WLAN-antenna cables along the routing guides on the palm-rest and keyboard assembly.

(i) NOTE: Ensure that you route the antenna cables along its routing guides under the heat sink.

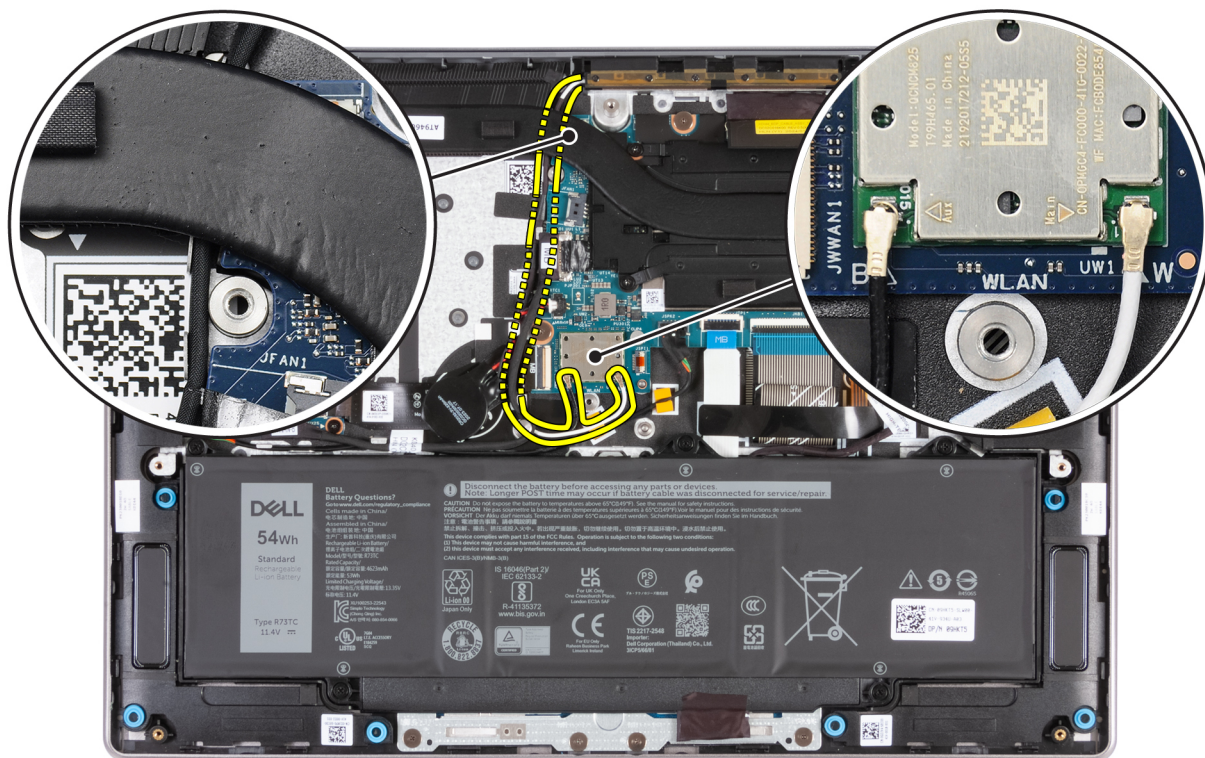

Figure 44. Installing WLAN-antenna cables

2. Place the WLAN-antenna module in the slot on the palm-rest and keyboard assembly.
3. Align the screw hole on the WLAN-antenna module with the screw hole on the palm-rest and keyboard assembly.
4. Replace the screw (M2x2.5) that secures the WLAN-antenna module to the palm-rest and keyboard assembly.
5. Adhere the tape that secures the antenna cables to the palm-rest and keyboard assembly.
6. Connect the WLAN-antenna cables to the connectors (B and W) on the WLAN module.

The following table provides the WLAN-antenna cables color scheme for the WLAN module that is supported for your computer.

Table 29. Antenna-cable color scheme

Connectors on the wireless card	Antenna-cable color	Silkscreen marking
Main	White	W
Auxiliary	Black	B

7. Move and adhere the coin-cell battery and route the coin-cell battery cable through the routing guide on the palm-rest and keyboard assembly.
8. Route the I/O-board cable through the routing guides on the palm-rest and keyboard assembly.
9. Connect the I/O-board cable to the connector (JIO1) on the system board.
10. Align and slide the WLAN-thermal shield to the right until the screw hole on the WLAN-thermal shield aligns with the screw hole on the system board.

NOTE: The WLAN-thermal shield includes a thermal pad that is attached to the bottom of the shield. Ensure that you adhere the thermal pad back to its location if it is displaced during the removal procedure.

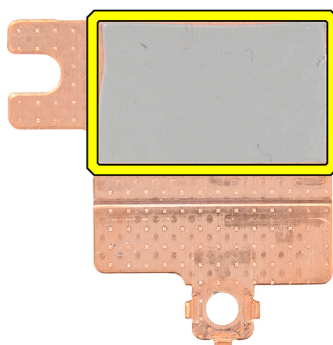

Figure 45. Thermal pad below the WLAN-thermal shield

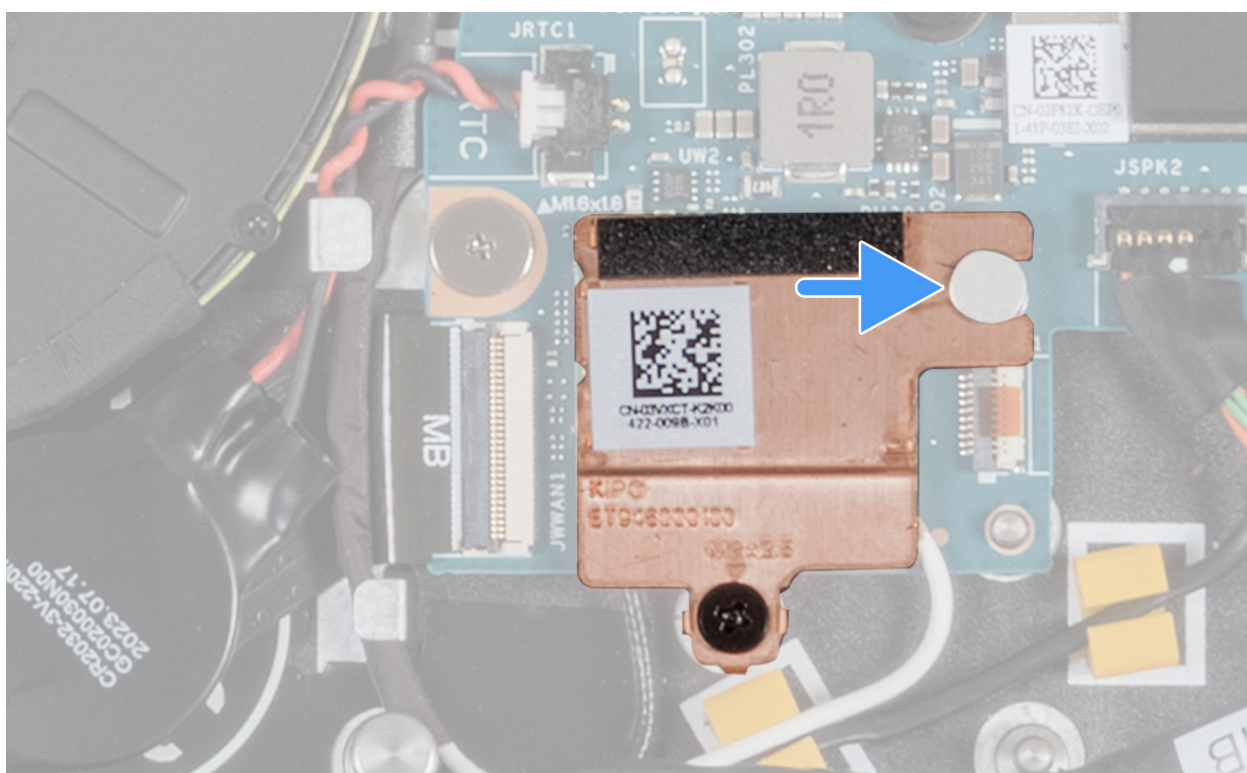

Figure 46. Installing the WLAN-thermal shield

11. Replace the screw (M2x2.5) that secures the WLAN-thermal shield to the WLAN module.

Next steps

1. Install the [fan](#).
2. Install the [base cover](#).
3. Follow the procedure in [After working inside your computer](#).

Display assembly

Removing the display assembly

⚠ CAUTION: The information in this removal section is intended for authorized service technicians only.

CAUTION: The maximum operating angle for the display-panel hinge is 135 degrees.

Prerequisites

1. Follow the procedure in [Before working inside your computer](#).
2. Remove the [base cover](#).

About this task

The following images indicate the location of the display assembly and provide a visual representation of the removal procedure.

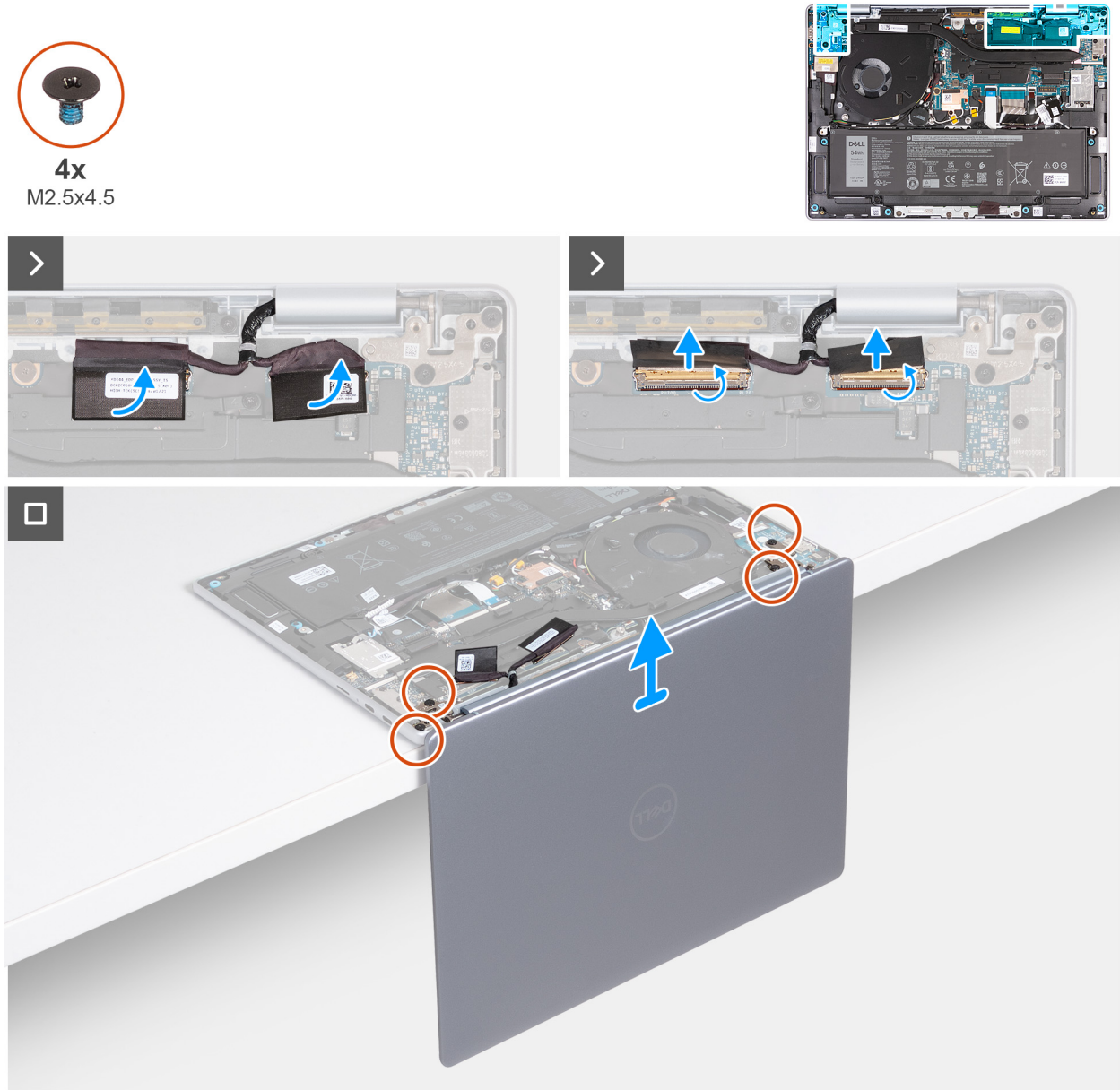

Figure 47. Removing the display assembly

Steps

1. Peel the Mylar and open the latch from the camera connector (MIPI) on the system board.
2. Disconnect the camera cable from the camera connector (MIPI) on the system board.
3. Peel the Mylar and open the latch from the display connector (EDP) on the system board.
4. Disconnect the display cable from the display connector (EDP) on the system board.
5. Open the display to a 90-degree angle and place the computer at the edge of a flat table.

6. Remove the four screws (M2.5x4.5) that secure the left and the right display hinges to the palm-rest and keyboard assembly.
 7. Lift the display assembly off the palm-rest and keyboard assembly.
 8. After performing all the above steps, you are left with the display assembly.
- NOTE:** The display assembly is a Hinge-Up Design (HUD) assembly, which cannot be further disassembled. If any components in the display assembly malfunction and require replacement, the entire display assembly has to be replaced.



Figure 48. Display assembly

Installing the display assembly

CAUTION: The information in this installation section is intended for authorized service technicians only.

CAUTION: The maximum angle for the display hinge is 135 degrees.

Prerequisites

If you are replacing a component, remove the existing component before performing the installation procedure.

About this task

The following images indicate the location of the display assembly and provide a visual representation of the installation procedure.



4x
M2.5x4.5

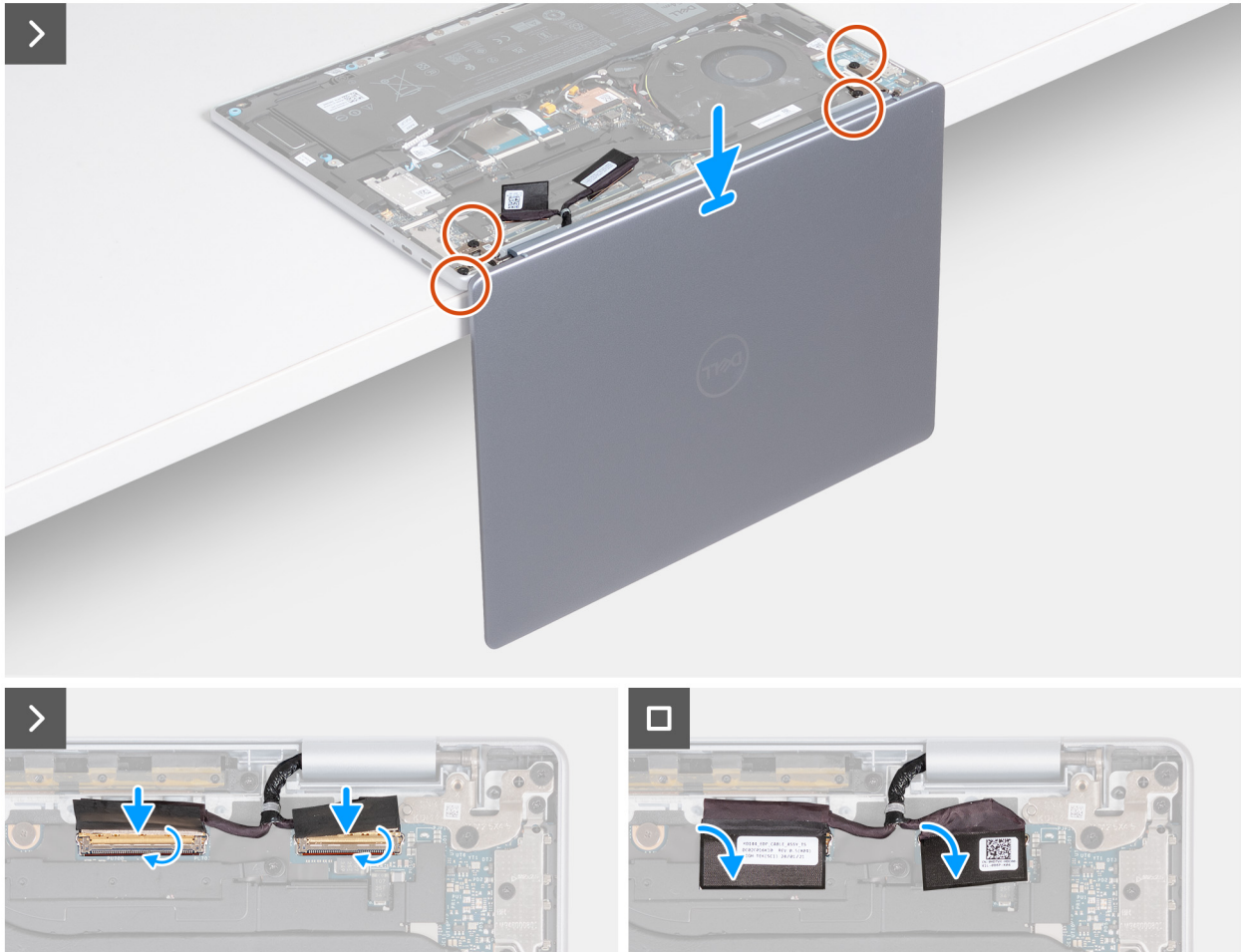
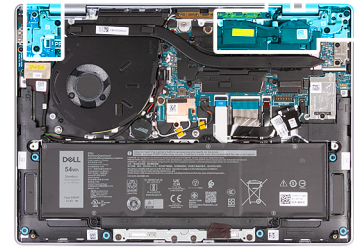

Figure 49. Installing the display assembly

Steps

1. Place the palm-rest and keyboard assembly at the edge of a flat table.
2. Open the hinges of the display assembly to a 90-degree angle.
3. Align the screw holes on the display hinges with the screw holes on the palm-rest and keyboard assembly.
4. Replace the four screws (M2.5x4.5) to secure the left and the right display hinges to the palm-rest and keyboard assembly.
5. Connect the display cable to the display connector (EDP) on the system board.
6. Close the latch and adhere the Mylar to the display connector (EDP) on the system board.
7. Connect the camera cable to the camera connector (MIPI) on the system board.
8. Close the latch and adhere the Mylar to the camera connector (MIPI) on the system board.

Next steps

1. Install the [base cover](#).
2. Follow the procedure in [After working inside your computer](#).

I/O board

Removing the I/O board

CAUTION: The information in this removal section is intended for authorized service technicians only.

Prerequisites

1. Follow the procedure in [Before working inside your computer](#).
2. Remove the [base cover](#).

About this task

The following images indicate the location of the I/O board and provide a visual representation of the removal procedure.

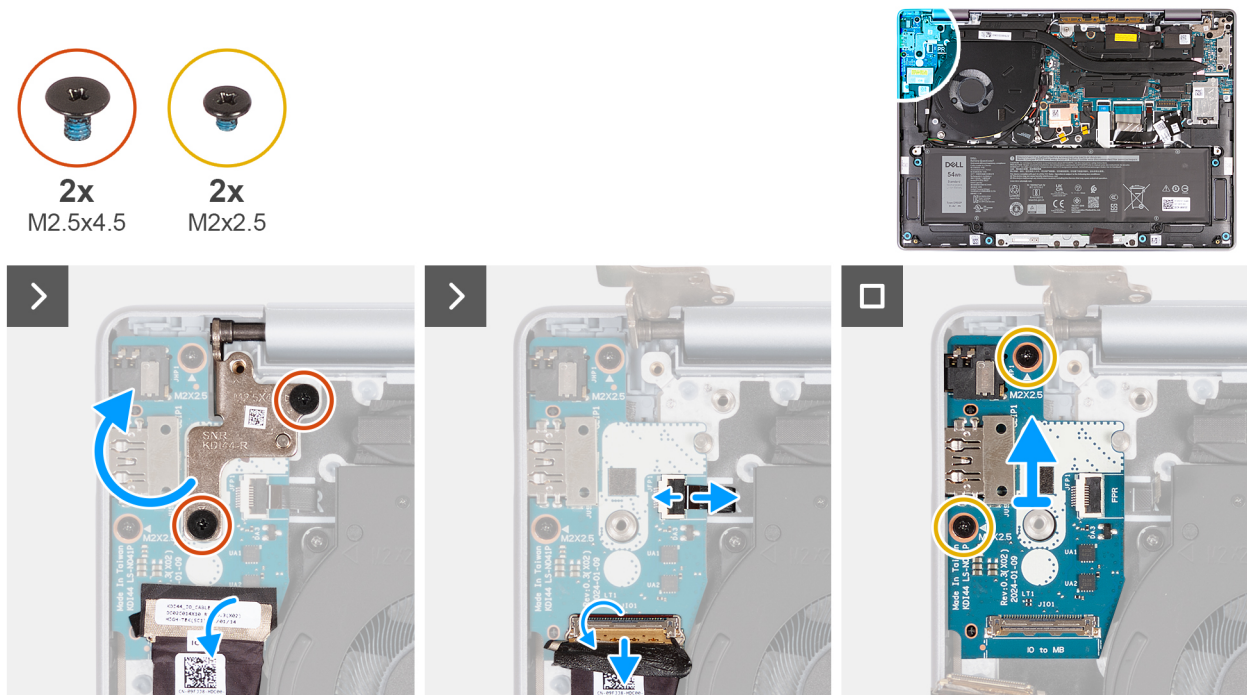

Figure 50. Removing the I/O board

Steps

1. Remove the two screws (M2.5x4.5) that secure the right-display hinge to the palm-rest and keyboard assembly.
2. Lift and open the right-display hinge to a 90-degree angle from the palm-rest and keyboard assembly.
3. Peel the tape that secures the I/O-board cable to the connector (JIO1) on the I/O board.
4. Open the latch and disconnect the I/O-board cable from the connector (JIO1) on the I/O board.
5. For computers with a fingerprint reader installed, open the latch and disconnect the fingerprint reader cable from the connector (JFP1) on the I/O board.
6. Remove the two screws (M2x2.5) that secure the I/O board to the palm-rest and keyboard assembly.
7. Carefully slide and lift the I/O board at an angle, moving it away from the port slots, and then remove it from the palm-rest and keyboard assembly.

Installing the I/O-board

CAUTION: The information in this installation section is intended for authorized service technicians only.

Prerequisites

If you are replacing a component, remove the existing component before performing the installation procedure.

About this task

The following images indicate the location of the I/O board and provide a visual representation of the installation procedure.

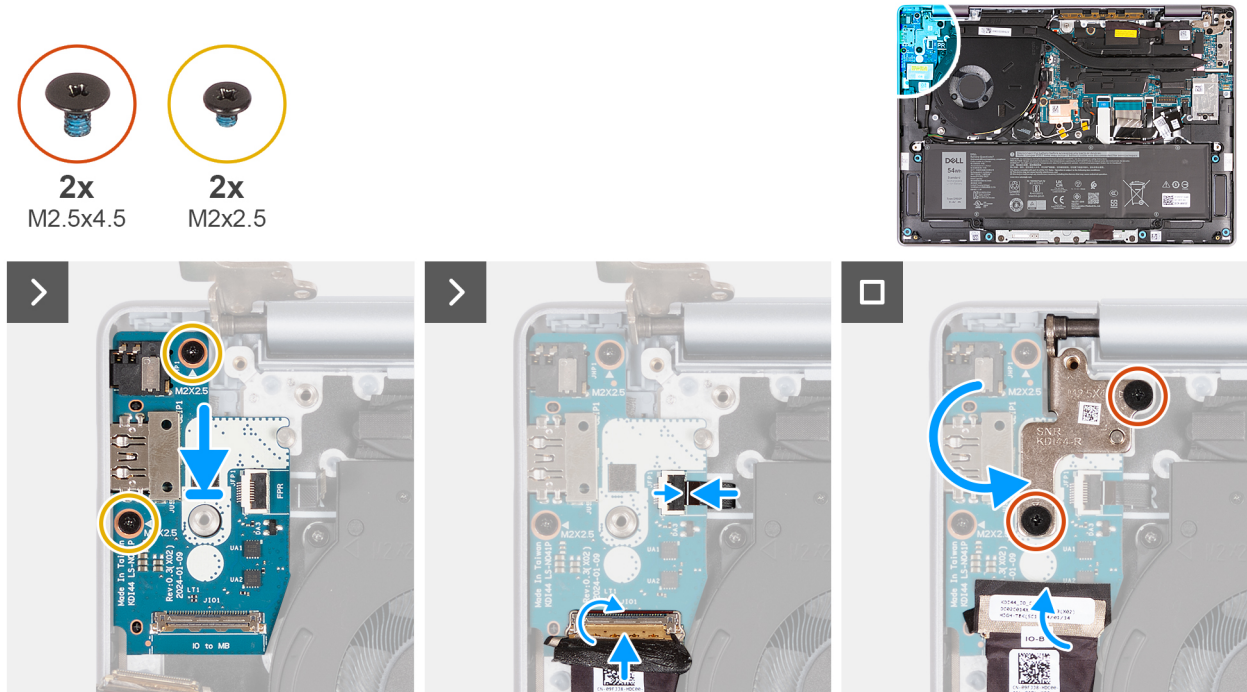

Figure 51. Installing the I/O board

Steps

1. Carefully slide and place the I/O board on the palm-rest and keyboard assembly.
2. Align the ports on the I/O board with the port slots on the palm-rest and keyboard assembly.
3. Replace the two screws (M2x2.5) that secure the I/O board to the palm-rest and keyboard assembly.
4. For computers with a fingerprint reader installed, connect the fingerprint reader cable to the connector (JFP1) on the I/O board and close the latch to secure the cable in place.
5. Connect the I/O board cable to the connector (JIO1) on the I/O board and close the latch to secure the cable in place.
6. Adhere the tape to secure the I/O-board cable to the connector (JIO1) on the I/O board.
7. Close the right-display hinge and align the screw holes on the display hinge with the screw holes on the I/O board and palm-rest and keyboard assembly.
8. Replace the two screws (M2.5x4.5) that secure the right-display hinge to the palm-rest and keyboard assembly.

Next steps

1. Install the [base cover](#).
2. Follow the procedure in [After working inside your computer](#).

Touchpad assembly

Removing the touchpad assembly

CAUTION: The information in this removal section is intended for authorized service technicians only.

Prerequisites

1. Follow the procedure in [Before working inside your computer](#).
2. Remove the [base cover](#).
3. Remove the [battery](#).

About this task

The following images indicate the location of the touchpad assembly and provide a visual representation of the removal procedure.

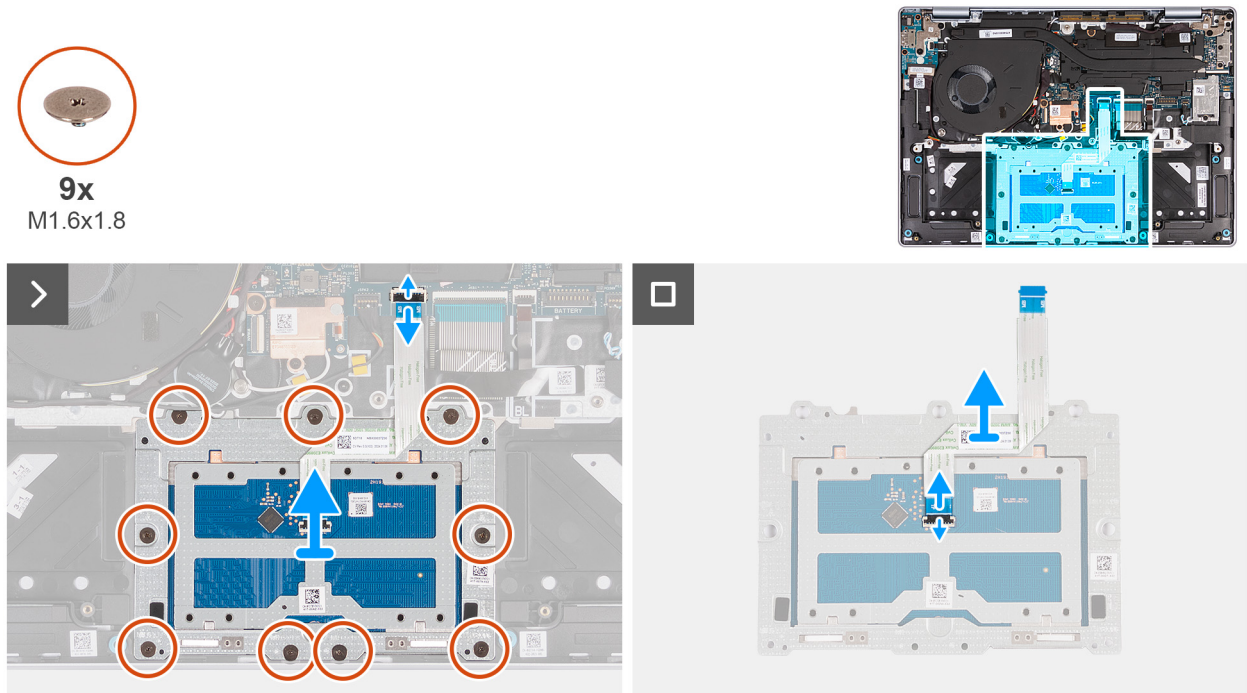

Figure 52. Removing the touchpad assembly

Steps

1. Open the latch and disconnect the touchpad cable (MB) from the touchpad cable connector (JTP1) on the system board.
2. Remove the nine screws (M1.6x1.8) that secure the touchpad assembly to the palm-rest and keyboard assembly.
3. Lift the touchpad assembly, along with the cable off the computer.
4. Open the latch and disconnect the touchpad cable (TP) from the connector on the touchpad assembly.

Installing the touchpad assembly

CAUTION: The information in this installation section is intended for authorized service technicians only.

Prerequisites

If you are replacing a component, remove the existing component before performing the installation procedure.

About this task

The following images indicate the location of the touchpad assembly and provide a visual representation of the installation procedure.



9x
M1.6x1.8

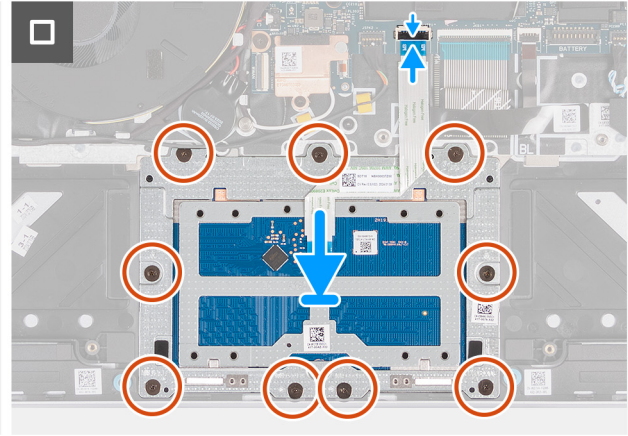
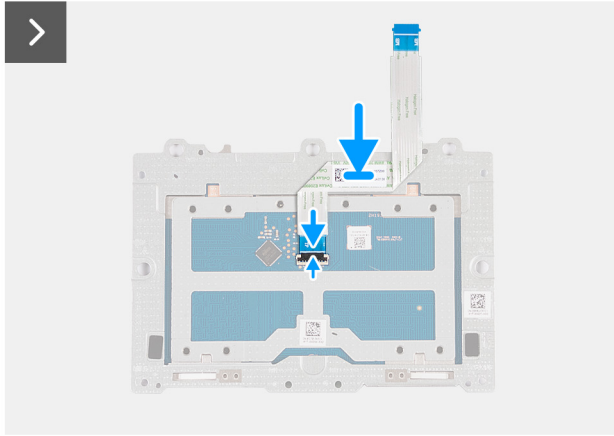
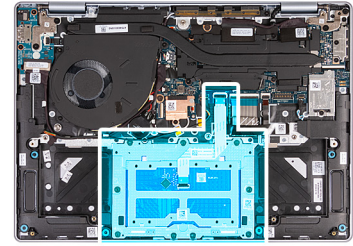

Figure 53. Installing the touchpad assembly

Steps

1. Connect the touchpad cable (TP) to the connector on the touchpad assembly and close the latch to secure the cable in place.
2. Place the touchpad into its slot on the computer.
3. Align the screw holes on the touchpad assembly to the screw holes on the palm-rest and keyboard assembly.
4. Replace the nine screws (M1.6x1.8) that secure the touchpad assembly to the palm-rest and keyboard assembly.
5. Connect the touchpad cable (MB) to the touchpad cable connector (JTP1) on the system board and close the latch to secure the cable.

Next steps

1. Install the [battery](#).
2. Install the [base cover](#).
3. Follow the procedure in [After working inside your computer](#).

Power button

Removing the power button

CAUTION: The information in this removal section is intended for authorized service technicians only.

Prerequisites

1. Follow the procedure in [Before working inside your computer](#).
2. Remove the [base cover](#).
3. Remove the [display assembly](#).
4. Remove the [I/O board](#).

About this task

The following images indicate the location of the power button and provide a visual representation of the removal procedure.

NOTE: The power button on your computer may vary depending on the configuration which you have ordered.

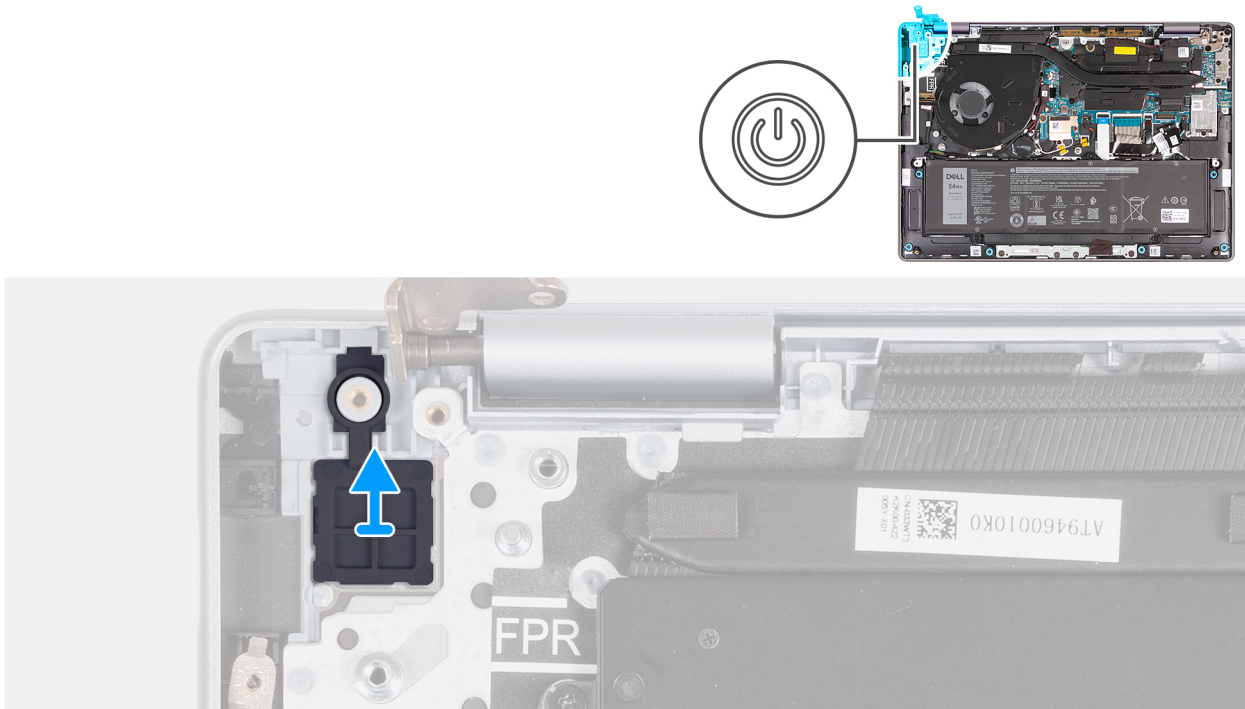

Figure 54. Removing the power button

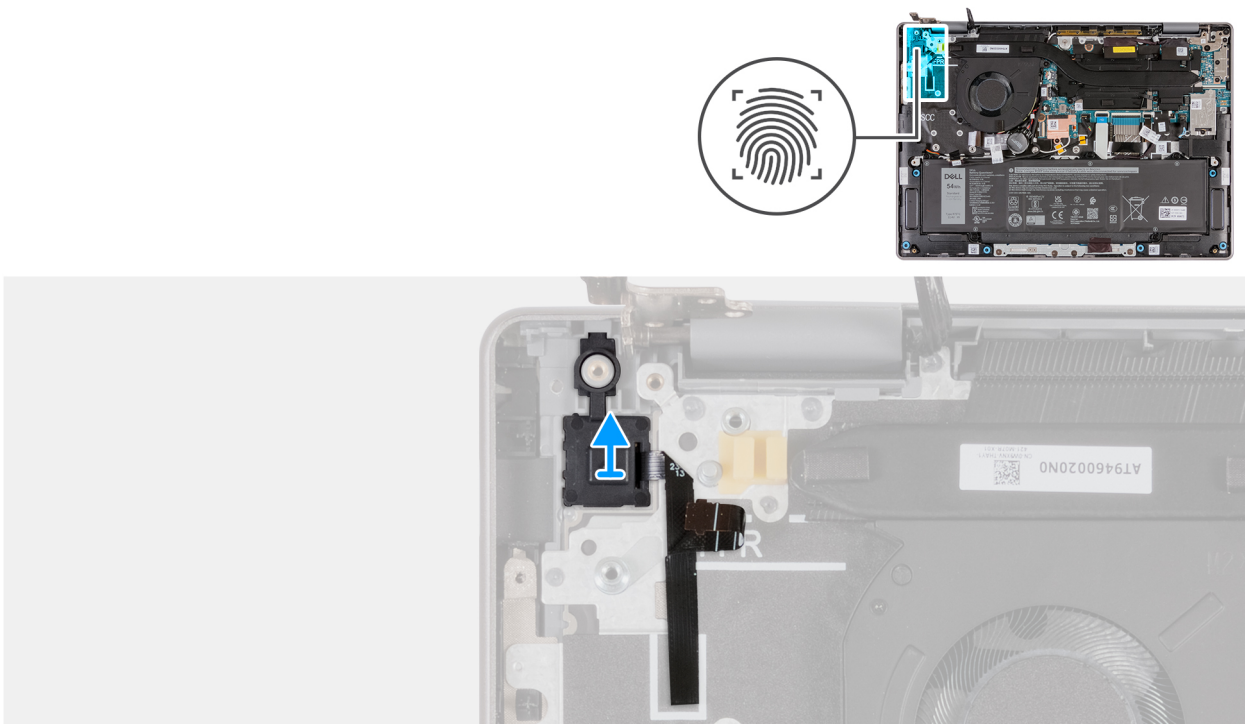

Figure 55. Removing the power button with fingerprint reader

Lift the power button off the palm-rest and keyboard assembly.

Installing the power button

CAUTION: The information in this installation section is intended for authorized service technicians only.

Prerequisites

If you are replacing a component, remove the existing component before performing the installation procedure.

About this task

The following images indicate the location of the power button and provide a visual representation of the installation procedure.

NOTE: The power button on your computer may vary depending on the configuration which you have ordered.

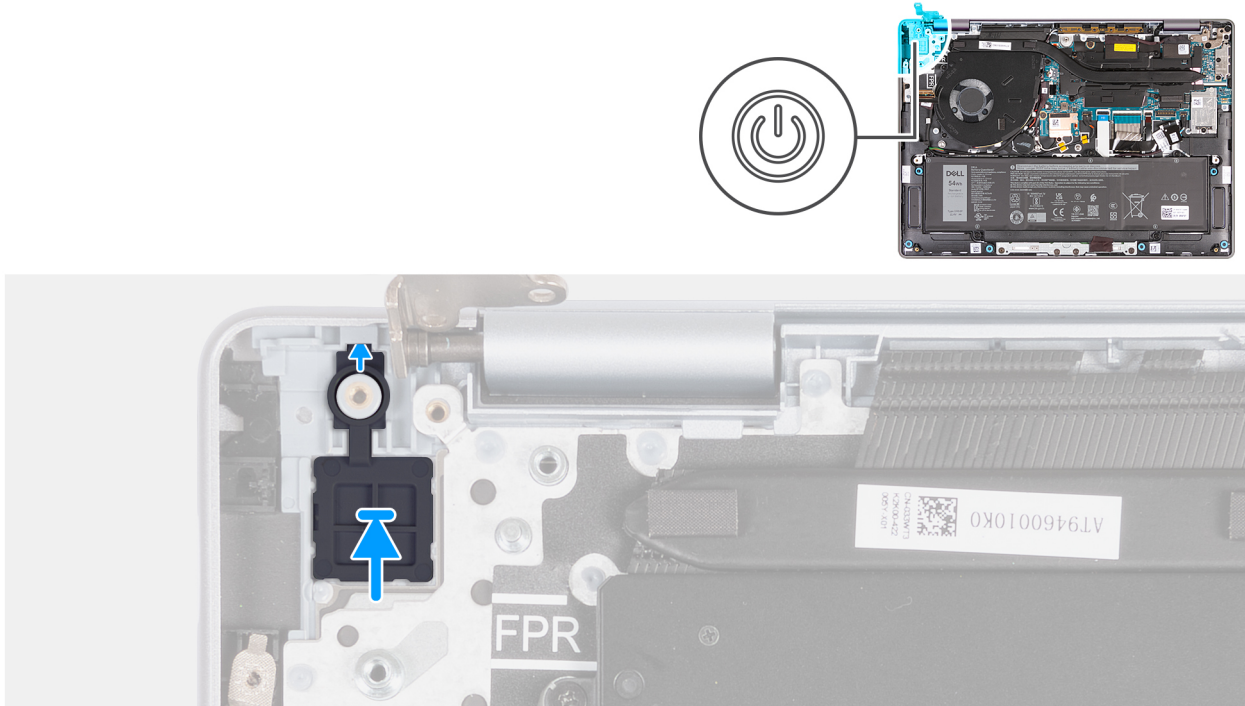

Figure 56. Installing the power button

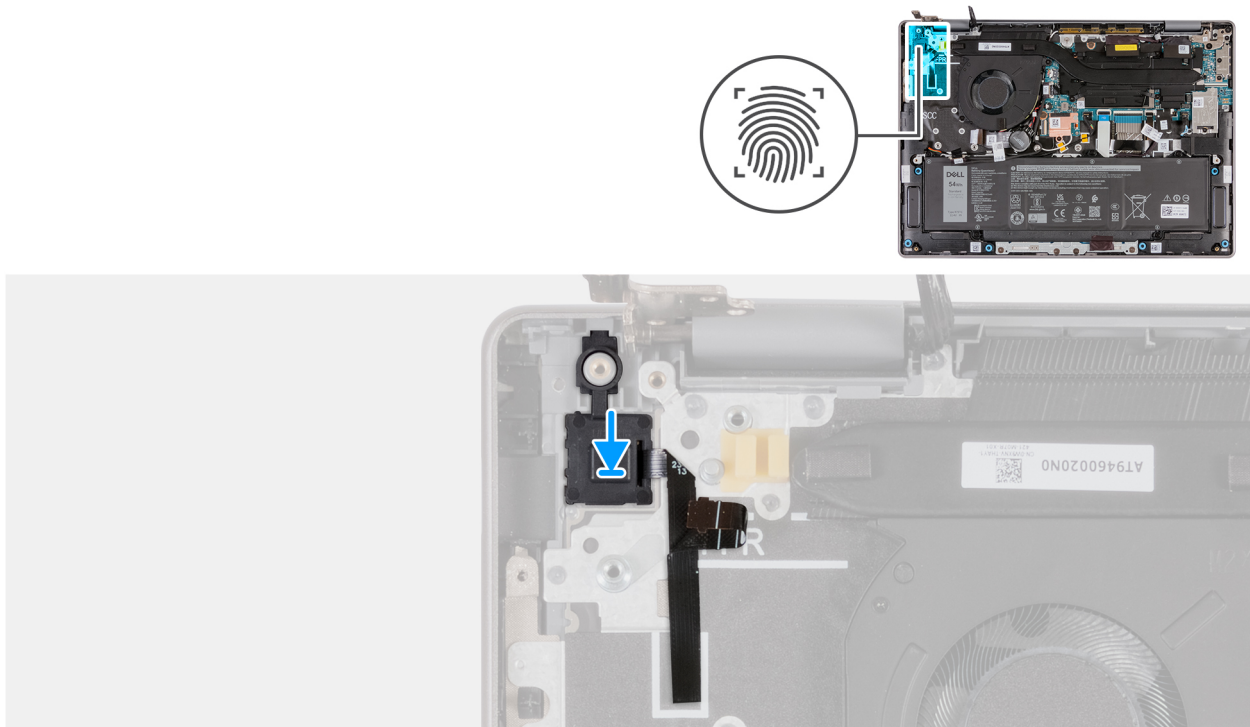

Figure 57. Installing the power button with fingerprint reader

Using the alignment post, place the power button in the slot on the palm-rest and keyboard assembly.

NOTE: Ensure that the tab is inserted inside the slot and not on top of it. Avoid creating a gap, which may damage the I/O board or the base cover.

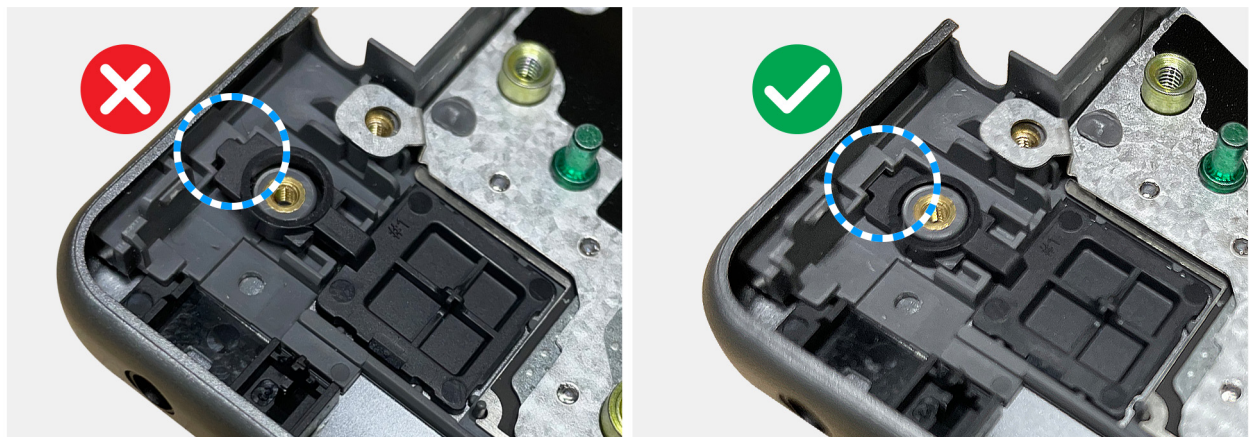

Figure 58. Installing the power button

Next steps

1. Install the [I/O board](#).
2. Install the [display assembly](#).
3. Install the [base cover](#).
4. Follow the procedure in [After working inside your computer](#).

System board

Removing the system board

CAUTION: The information in this removal section is intended for authorized service technicians only.

Prerequisites

1. Follow the procedure in [Before working inside your computer](#).
2. Remove the [base cover](#).
3. Remove the [SSD](#).
4. Remove the [fan](#).
5. Remove the [heat sink](#).
6. Remove the [display assembly](#).

About this task

The following image indicates the system-board connectors.

NOTE: The USB Type-C bracket is bundled with the system board. DO NOT remove the USB Type-C bracket from the system board.

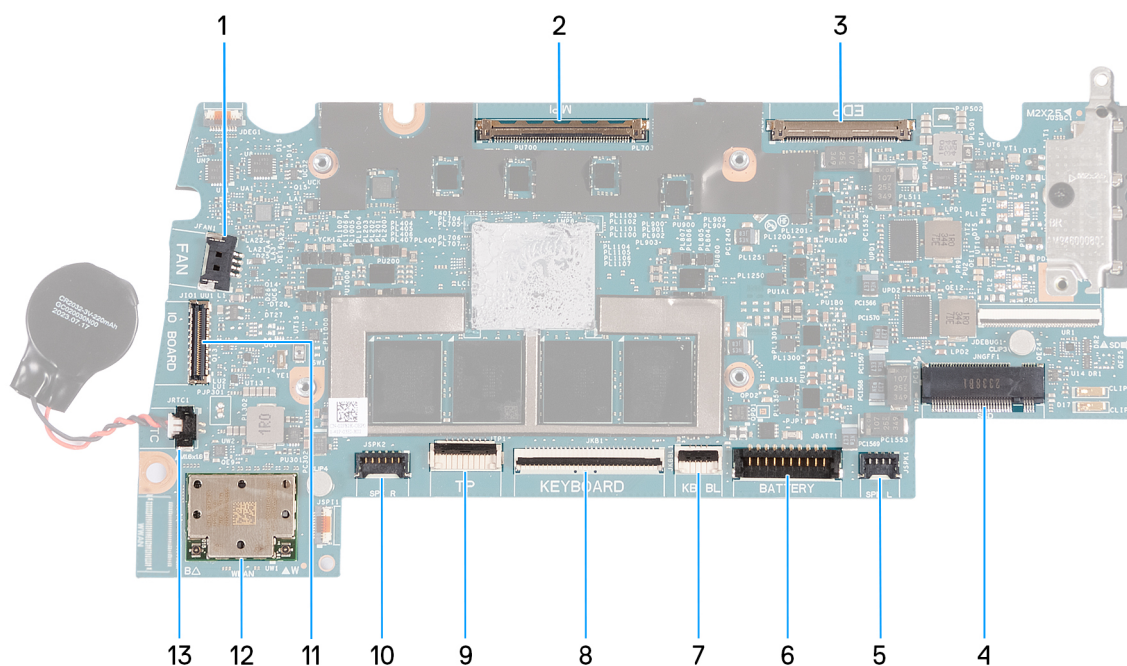

Figure 59. System-board connectors

1. Fan cable connector (JFAN1)
2. Camera-cable connector (MIPI)
3. Display-cable connector (EDP)
4. Solid state drive slot (SSD)
5. Left speaker-cable connector (JSPK1)
6. Battery-cable connector (JBATT1)
7. Keyboard-backlight cable connector (JKBBL1)
8. Keyboard-cable connector (JKB1)
9. Touchpad-cable connector (JTP1)
10. Right speaker-cable connector (JSPK2)
11. I/O-board cable connector (JIO1)

- 12. Wireless card (WLAN)
- 13. Coin-cell cable connector (JRRTC1)

NOTE: The replacement system board is shipped with the coin-cell battery attached.

The following images indicate the location of the system board and provide a visual representation of the removal procedure.

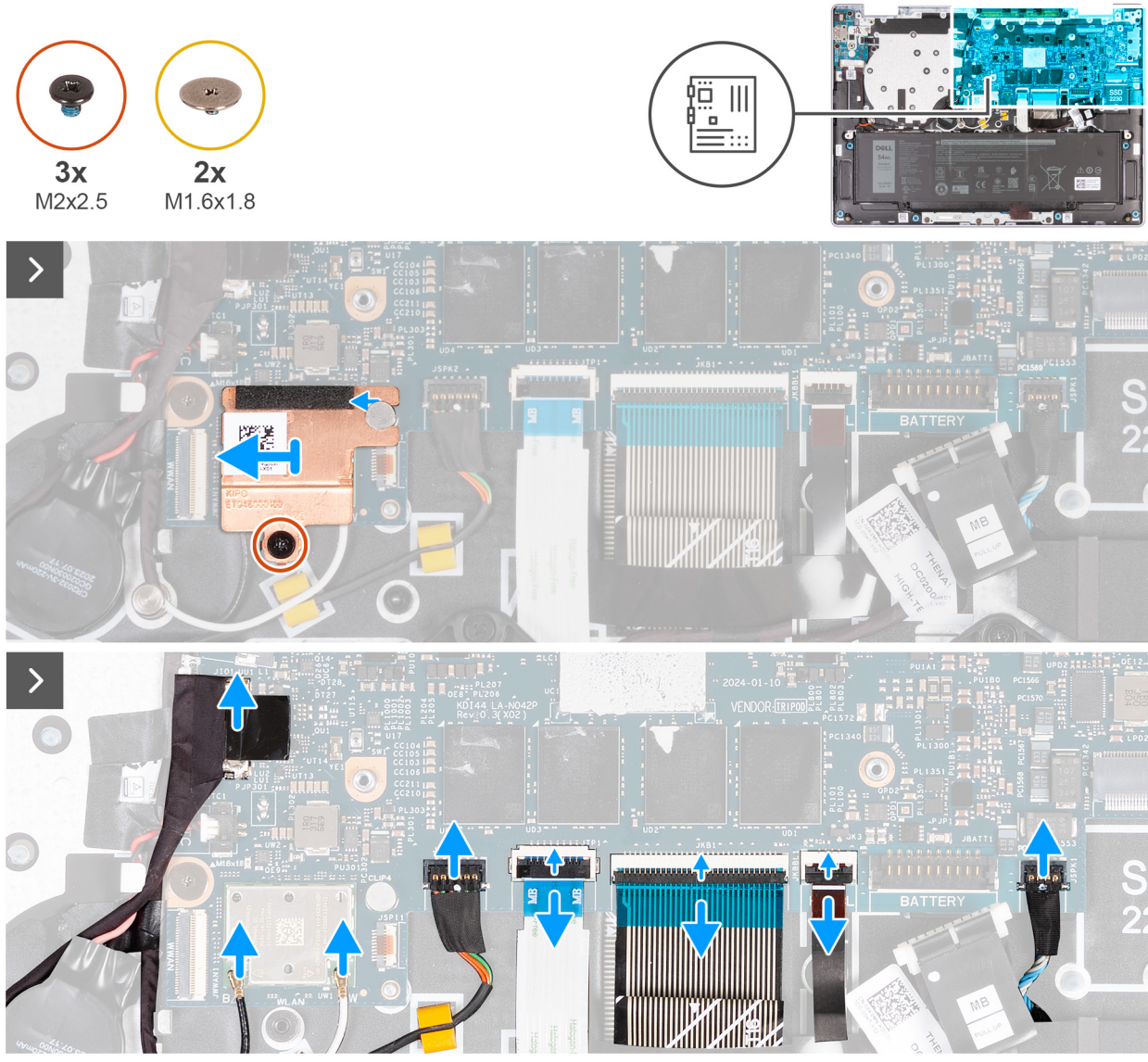

Figure 60. Removing the system board

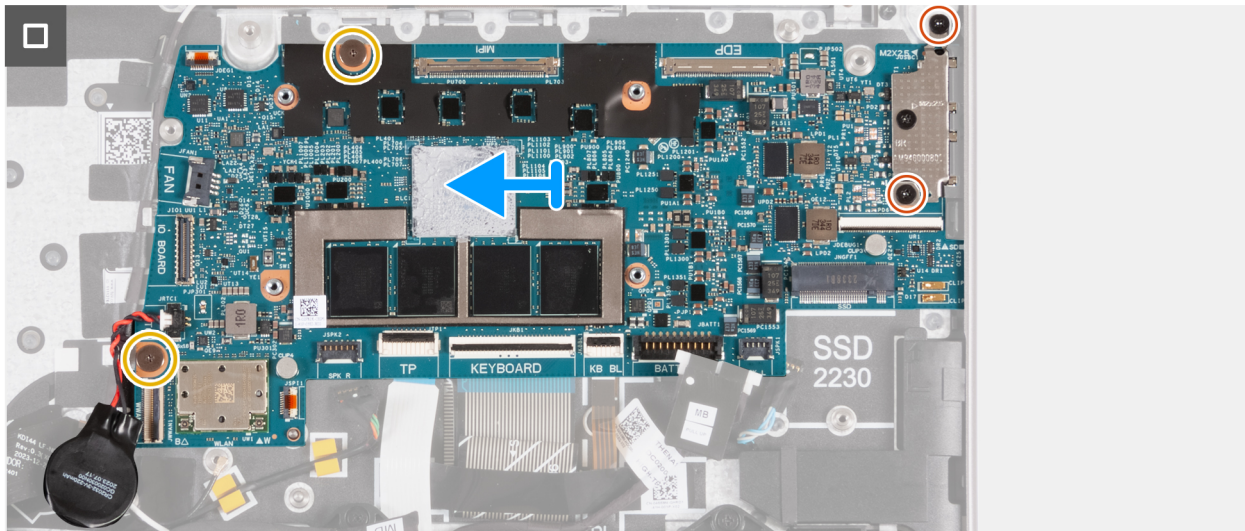

Figure 61. Removing the system board

Steps

1. Remove the screw (M2x2.5) that secures the WLAN thermal shield to the palm-rest and keyboard assembly.
2. Slide the WLAN thermal shield to the left and lift the shield off the palm-rest and keyboard assembly.
3. Disconnect the WLAN antenna cables from the connectors (B and W) on the WLAN module.
4. Disconnect the I/O board cable from the connector (JIO1) on the system board.
5. Disconnect the right speaker-cable from the connector (JSPK2) on the system board.
6. Open the latch and disconnect the touchpad cable from the connector (JTP1) on the system board.
7. Open the latch and disconnect the keyboard cable from the connector (JKB1) on the system board.
8. Open the latch and disconnect the keyboard backlight-cable from the connector (JKBBL1) on the system board.
9. Disconnect the left speaker-cable from the connector (JSPK1) on the system board.
10. Remove the two screws (M1.6x1.8) that secure the system board to the palm-rest and keyboard assembly.
11. Lift the system board off the palm-rest and keyboard assembly.

NOTE: The USB Type-C bracket is bundled with the system board. DO NOT remove the USB Type-C bracket from the system board.

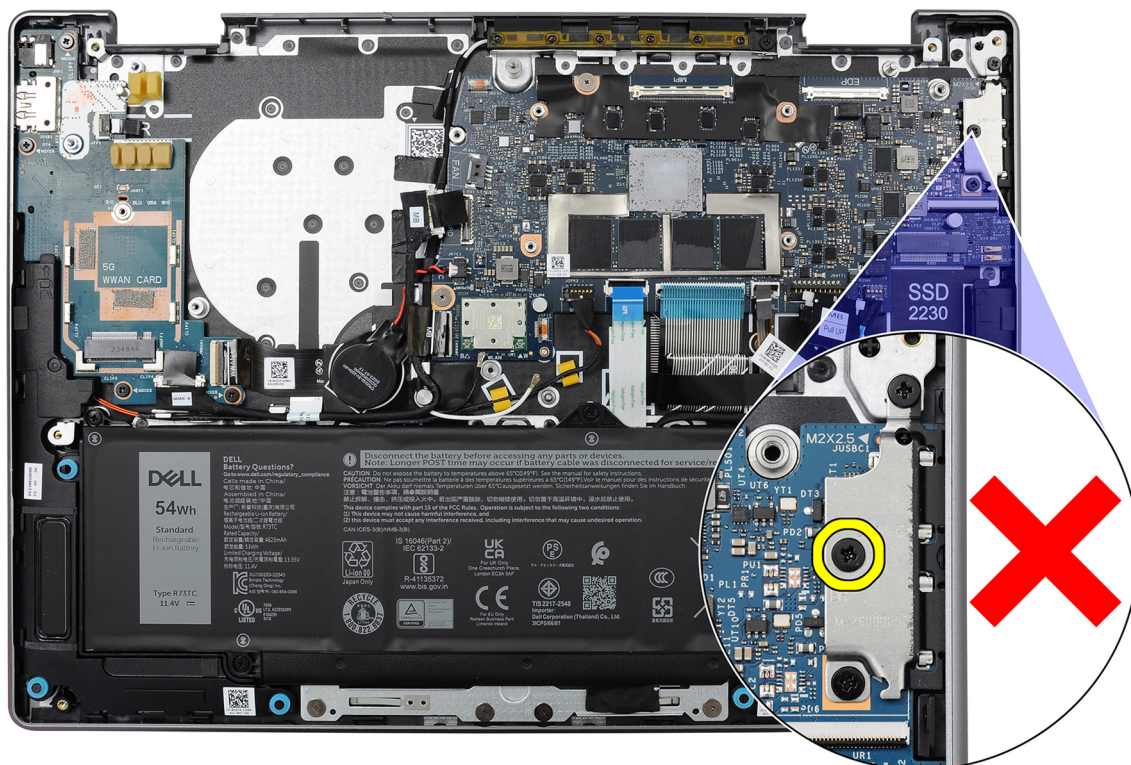

Figure 62. USB Type-C bracket

Installing the system board

CAUTION: The information in this installation section is intended for authorized service technicians only.

Prerequisites

If you are replacing a component, remove the existing component before performing the installation procedure.

About this task

The following image indicates the system-board connectors.

NOTE: The Type-C bracket is bundled with the system board. DO NOT remove the USB Type-C bracket from the system board.

NOTE: The replacement system board is shipped with the coin-cell battery attached.

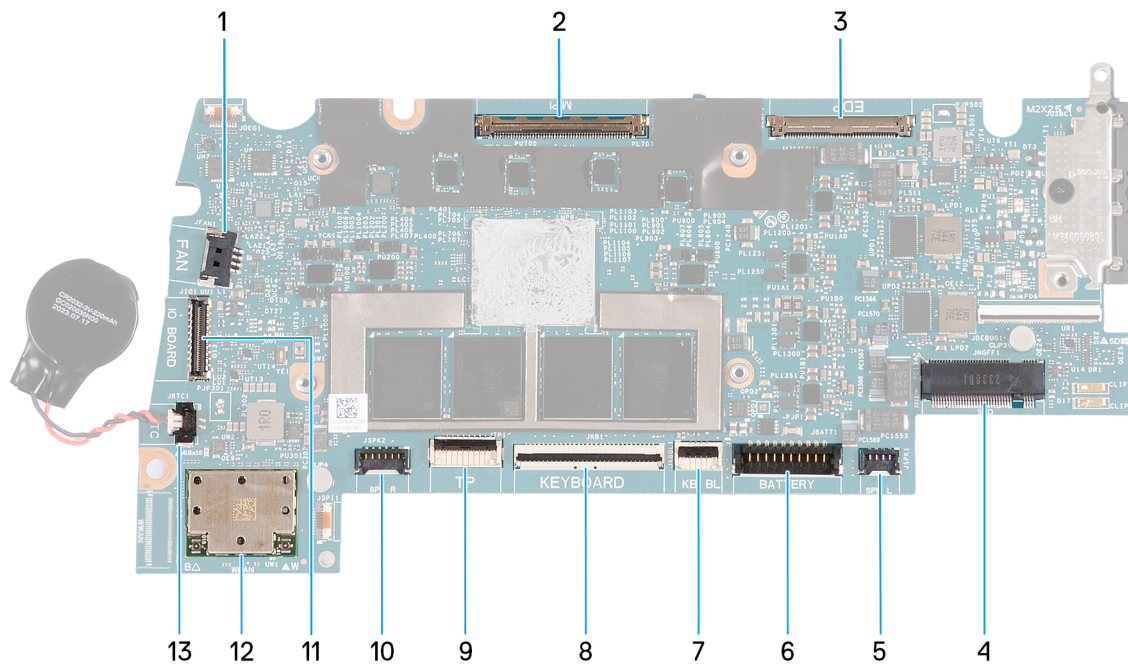

Figure 63. System-board connectors

1. Fan cable connector (JFAN1)
2. Camera-cable connector (MIPI)
3. Display-cable connector (EDP)
4. Solid state drive slot (SSD)
5. Left speaker-cable connector (JSPK1)
6. Battery-cable connector (JBATT1)
7. Keyboard-backlight cable connector (JKBBL1)
8. Keyboard-cable connector (JKB1)
9. Touchpad-cable connector (JTP1)
10. Right speaker-cable connector (JSPK2)
11. I/O-board cable connector (JIO1)
12. WLAN module
13. Coin-cell cable connector (JRTC1)

NOTE: The replacement system board is shipped with the coin-cell battery attached.

The following images indicate the location of the system board and provide a visual representation of the removal procedure.

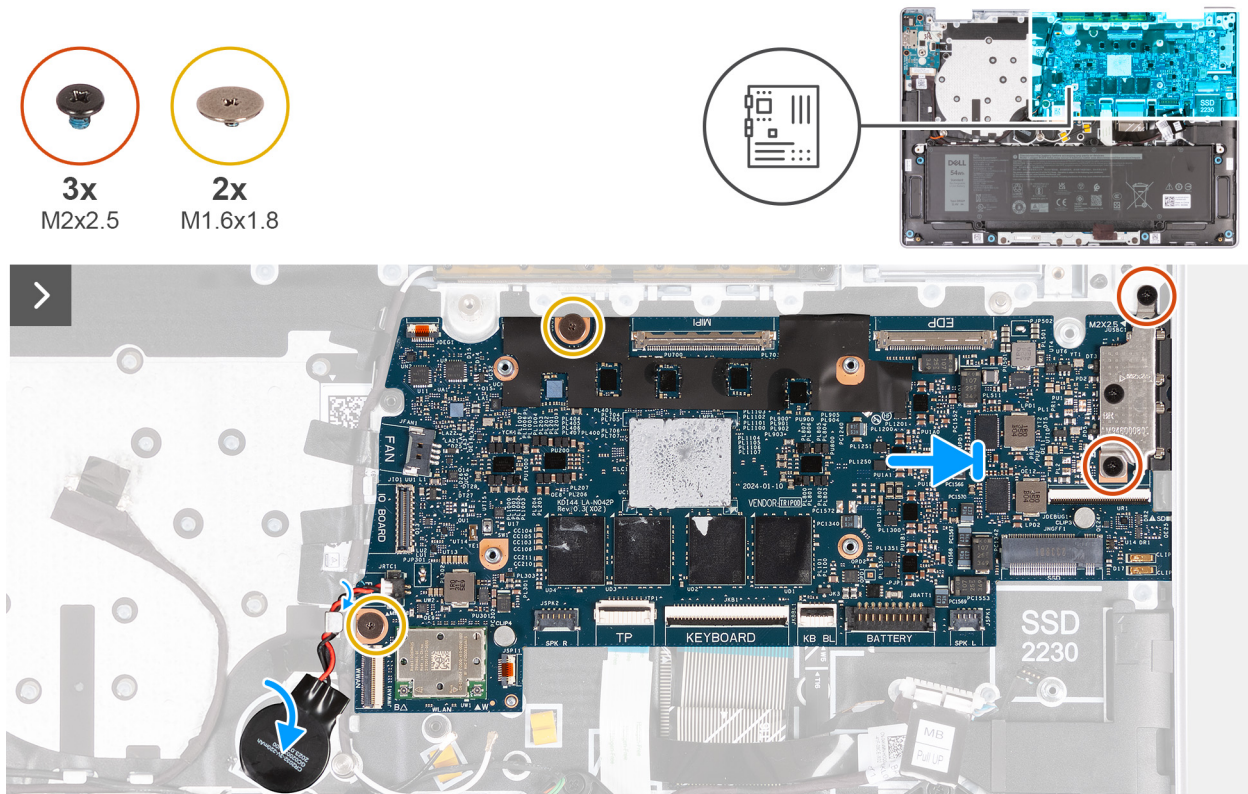

Figure 64. Installing the system board

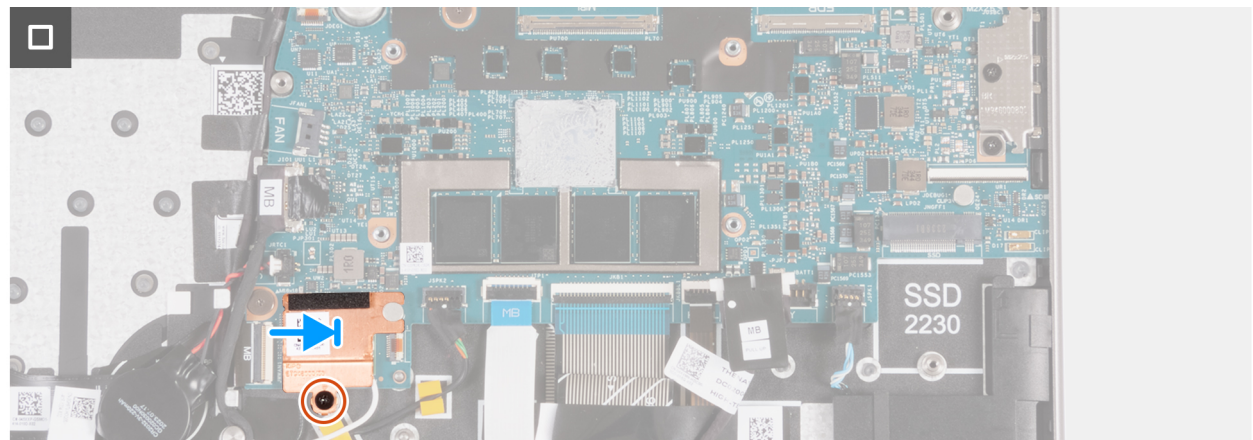

Figure 65. Installing the system board

Steps

1. Align the screw holes of the system board with the screw holes on the palm-rest and keyboard assembly.
2. Replace the two screws (M2x2.5) that secure the USB Type-C bracket to the palm-rest and keyboard assembly.
3. Connect the left speaker-cable to the connector (JSPK1) on the system board and close the latch to secure the cable.
4. Connect the keyboard backlight-cable to the connector (JKBBL1) on the system board and close the latch to secure the cable.
5. Connect the keyboard cable to the connector (JKB1) on the system board and close the latch to secure the cable.
6. Connect the touchpad cable to the connector (JTP1) on the system board and close the latch to secure the cable.
7. Connect the right speaker-cable to the connector (JSPK2) on the system board.
8. Connect the WLAN antenna cables to the connectors on the WLAN module.

The following table provides the antenna-cable color scheme for the WLAN module on your computer.

Table 30. Antenna-cable color scheme

Connectors on the wireless card	Antenna-cable color	Silkscreen marking	
Main	White	W	▲ (solid triangle)
Auxiliary	Black	B	△ (outlined triangle)

- Place the WLAN-thermal shield on the WLAN-antenna module and slide the shield to the right.
- Align the screw hole on the WLAN-thermal shield with the screw hole on the palm-rest and keyboard assembly.
- Replace the screw (M2x2.5) that secures the WLAN-thermal shield to the palm-rest and keyboard assembly.

Next steps

- Install the [display assembly](#).
- Install the [heat sink](#).
- Install the [fan](#).
- Install the [SSD](#).
- Install the [base cover](#).
- Follow the procedure in [After working inside your computer](#).

Palm-rest and keyboard assembly

Removing the palm-rest and keyboard assembly

 **CAUTION:** The information in this removal section is intended for authorized service technicians only.

Prerequisites

- Follow the procedure in [Before working inside your computer](#).
- Remove the [base cover](#).
- Remove the [SSD](#).
- Remove the [speakers](#).
- Remove the [fan](#).
- Remove the [battery](#).
- Remove the [heat sink](#).
- Remove the [I/O-board cable](#).
- Remove the [WLAN-antenna module](#).
- Remove the [display assembly](#).
- Remove the [touchpad assembly](#).
- Remove the [I/O board](#).
- Remove the [power button](#).
- Remove the [system board](#).

 **NOTE:** The system board can be removed with the coin-cell battery and heat sink attached to simplify the procedure and preserve the thermal bond between the system board and heat sink.

About this task

 **NOTE:** The palm-rest and keyboard assembly cannot be further disassembled once all the components in the prerequisite steps have been removed. If the keyboard is malfunctioning and is required to be replaced, replace the entire palm-rest and keyboard assembly.

The image below shows the palm-rest and keyboard assembly after all the components in the prerequisite steps are removed.

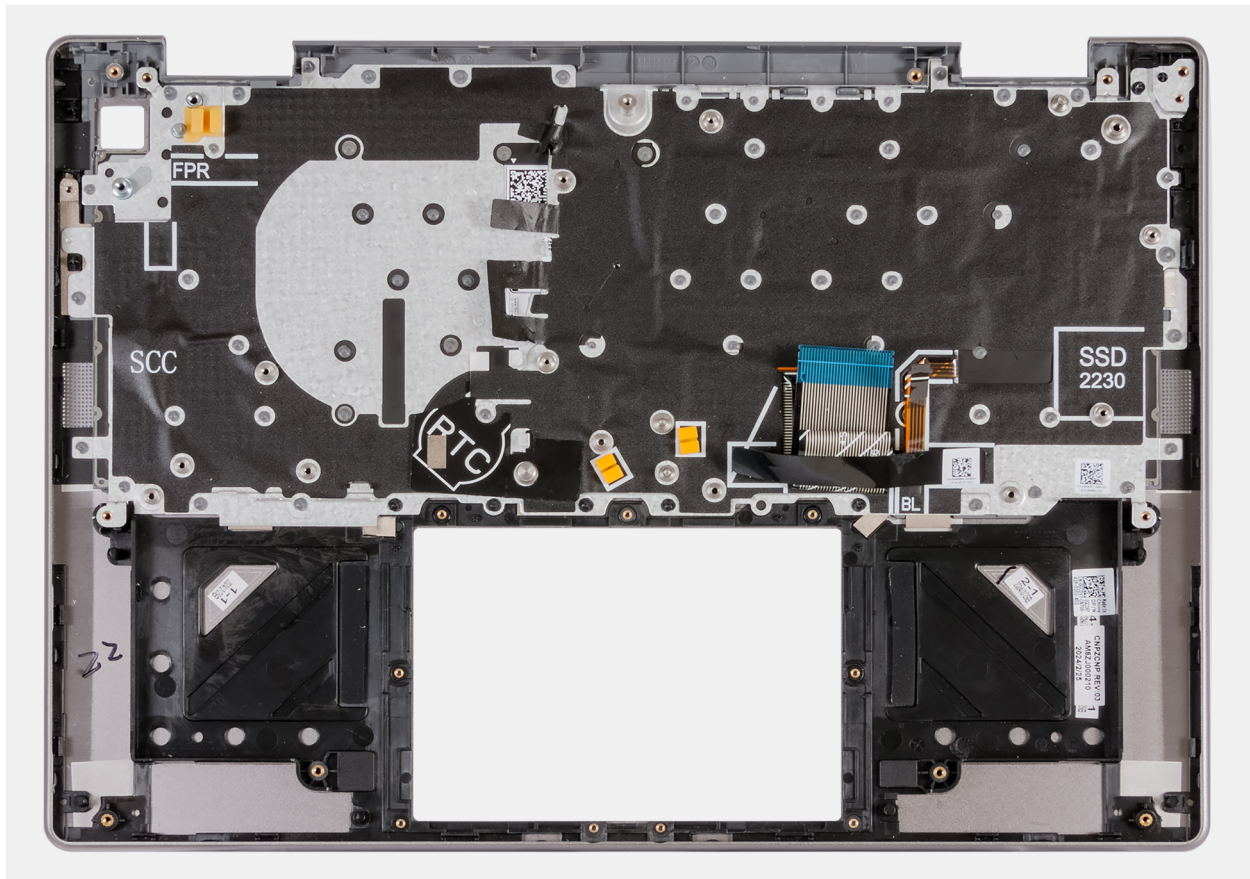

Figure 66. Palm-rest and keyboard assembly

Installing the palm-rest and keyboard assembly

CAUTION: The information in this installation section is intended for authorized service technicians only.

Prerequisites

If you are replacing a component, remove the existing component before performing the installation procedure.

About this task

The following image shows the palm-rest and keyboard assembly before all the components in the post-requisites steps have been installed. Place the palm-rest and keyboard assembly on a flat surface.

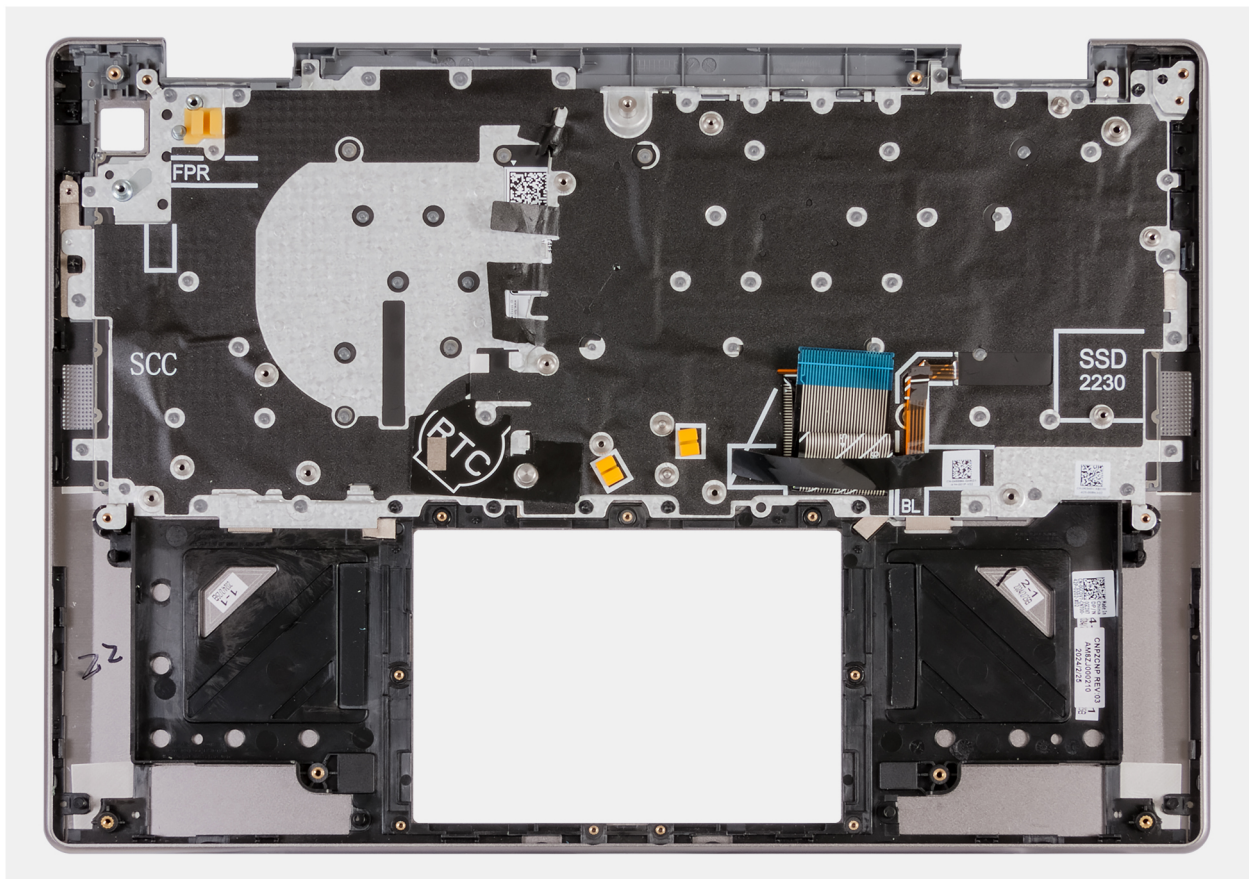

Figure 67. Palm-rest and keyboard assembly

Next steps

1. Install the [system board](#).
2. Install the [power button](#).
3. Install the [I/O board](#).
4. Install the [touchpad assembly](#).
5. Install the [display assembly](#).
6. Install the [WLAN-antenna module](#).
7. Install the [I/O-board cable](#).
8. Install the [heat sink](#).
9. Install the [battery](#).
10. Install the [fan](#).
11. Install the [speakers](#).
12. Install the [SSD](#).
13. Install the [base cover](#).
14. Follow the procedure in [After working inside your computer](#).

Software

This chapter details the supported operating systems along with instructions on how to install the drivers.

Operating system

Your Latitude 5455 supports the following operating systems:

- Windows 11 Home, ARM
- Windows 11 Pro, ARM

Drivers and downloads

When troubleshooting, downloading, or installing drivers, it is recommended that you read the Dell Knowledge Base article Drivers and Downloads FAQs [000123347](#).

BIOS Setup

CAUTION: Unless you are an expert computer user, do not change the settings in the BIOS Setup. Certain changes can make your computer work incorrectly.

NOTE: Depending on the computer and the installed devices, the options that are listed in this section may or may not be displayed.

NOTE: Before you change the settings in BIOS Setup, it is recommended that you note down the original settings for future reference.

Use BIOS Setup for the following purposes:

- Get information about the hardware installed in your computer, such as the amount of RAM and the size of the storage device.
- Change the system configuration information.
- Set or change a user-selectable option, such as the user password, type of hard drive installed, and enable or disable base devices.

Entering BIOS Setup program

About this task

Turn on (or restart) your computer and press F2 immediately.

Navigation keys

NOTE: For most of the BIOS Setup options, changes that you make are recorded but do not take effect until you restart the computer.

Table 31. Navigation keys

Keys	Navigation
Up arrow	Moves to the previous field.
Down arrow	Moves to the next field.
Enter	Selects a value in the selected field (if applicable) or follows the link in the field.
Spacebar	Expands or collapses a drop-down list, if applicable.
Tab	Moves to the next focus area.
Esc	Moves to the previous page until you view the main screen. Pressing Esc in the main screen displays a message that prompts you to save any unsaved changes and restart the computer.

F12 One Time Boot menu

To enter the One Time Boot menu, turn on your computer, and then press F12 immediately.

NOTE: If you are unable to enter the One Time Boot menu, repeat the above action.

The One Time Boot menu displays the devices that you can boot from and also display the options to start diagnostics. The boot menu options are:

- Removable Drive (if available)
- STXXXX Drive (if available)

NOTE: XXX denotes the SATA drive number.

- Optical Drive (if available)
- SATA Hard Drive (if available)
- Diagnostics

The One Time Boot menu screen also displays the option to access BIOS Setup.

View Advanced Setup options

About this task

Some BIOS Setup options are only visible by enabling **Advanced Setup** mode.

NOTE: BIOS Setup options, including **Advanced Setup** options, are described in [System setup options](#). By default, **Advanced Setup** options are visible.

To enable Advanced Setup

Steps

1. Enter BIOS Setup.
The **Overview** menu appears.
2. Click the **Advanced Setup** option to move it to the **ON** mode.
The **Advanced BIOS Setup** options are visible.

System setup options

NOTE: Depending on your computer and its installed devices, the items that are listed in this system setup section may or may not be displayed.

Table 32. System setup options—Overview menu

Overview	
Latitude 5455	
BIOS Version	Displays the BIOS version number.
Service Tag	Displays the Service Tag of the computer.
Asset Tag	Displays the Asset Tag of the computer.
Manufacture Date	Displays the manufacture date of the computer.
Ownership Date	Displays the ownership date of the computer.
Express Service Code	Displays the Express Service Code of the computer.
Ownership Tag	Displays the Ownership Tag of the computer.
Signed Firmware Update	Displays whether the Signed Firmware Update is enabled on your computer. By default, the Signed Firmware Update option is enabled.
BATTERY	
Primary	Displays the primary battery of the computer.
Battery Level	Displays the battery level of the computer.

Table 32. System setup options—Overview menu (continued)

Overview	
Battery State	Displays the battery state of the computer.
Health	Displays the battery health of the computer.
AC Adapter	Displays whether an AC adapter is connected. If connected, displays the type of AC adapter that is connected.
PROCESSOR	
Processor Type	Displays the processor type.
Maximum Clock Speed	Displays the maximum processor clock speed.
Current Clock Speed	Displays the current processor clock speed.
Core Count	Displays the number of cores on the processor.
Processor L2 Cache	Displays the processor L2 Cache size.
64-Bit Technology	Displays whether 64-bit technology is used.
MEMORY	
Memory Installed	Displays the total computer memory installed.
Memory Available	Displays the total computer memory available.
Memory Speed	Displays the memory speed.
Memory Channel Mode	Displays single or dual channel mode.
Memory Technology	Displays the technology that is used for the memory.
DEVICES	
Panel Type	Displays the Panel Type of the computer.
Video Controller	Displays the video controller type of the computer.
Wi-Fi Device	Displays the wireless device information of the computer.
Native Resolution	Displays the native resolution of the computer.
Video BIOS Version	Displays the video BIOS version of the computer.
Audio Controller	Displays the audio controller information of the computer.
Bluetooth Device	Displays the Bluetooth device information of the computer.
Pass Through MAC Address	Displays the MAC address of the video pass-through.

Table 33. System setup options—Boot Configuration menu

Boot Configuration	
Boot Sequence	
Boot Mode: UEFI only	Displays the boot mode of the computer.
Boot Sequence	Displays the boot sequence.
Secure Boot	
	Secure Boot is a method of guaranteeing the integrity of the boot path by performing additional validation of the operating system and PCI add-in cards. The computer stops booting to the operating system when a component is not authenticated during the boot process. Secure Boot can be enabled in BIOS setup or using management interfaces like Dell Command Configure, but can only be disabled from BIOS setup.
Enable Secure Boot	Enables the computer to boot using only validated boot software. By default, the Enable Secure Boot option is disabled.

Table 33. System setup options—Boot Configuration menu (continued)

Boot Configuration	
	For additional security, Dell Technologies recommends keeping the Secure Boot option enabled to ensure that the UEFI firmware validates the operating system during the boot process.
Enable Microsoft UEFI CA	<p>When disabled, the UEFI CA is removed from the BIOS UEFI Secure Boot database.</p> <p>i NOTE: When disabled, the Microsoft UEFI CA can cause your computer to not boot, computer graphics may not function, some devices may not function properly, and the computer could become unrecoverable.</p> <p>By default, the Enable Microsoft UEFI CA option is enabled.</p> <p>For additional security, Dell Technologies recommends keeping the Microsoft UEFI CA option enabled to ensure the broadest compatibility with devices and operating systems.</p>
Secure Boot Mode	<p>Enables or disables the Secure Boot operation mode.</p> <p>By default, the Deployed Mode is selected.</p> <p>i NOTE: Deployed Mode should be selected for normal operation of Secure Boot.</p>
Expert Key Management	
Enable Custom Mode	<p>Enables or disables the keys in the PK, KEK, db, and dbx security key databases to be modified.</p> <p>By default, the Enable Custom Mode option is disabled.</p> <p>i NOTE: To view this option, enable Advanced Setup mode as described in View Advanced Setup options.</p>
Custom Mode Key Management	<p>Selects the custom values for expert key management.</p> <p>i NOTE: To view this option, enable Advanced Setup mode as described in View Advanced Setup options.</p>

Table 34. System setup options—Integrated Devices menu

Integrated Devices	
Camera	
Enable Camera	<p>Enables the camera.</p> <p>By default, the Enable Camera option is enabled.</p> <p>i NOTE: Depending on the configuration ordered, the camera setup option may not be available.</p>
Audio	
Enable Internal Speaker	<p>Enables the internal speaker.</p> <p>By default, the Enable Internal Speaker option is enabled.</p>
USB/Thunderbolt Configuration	
Enable External USB Ports	<p>Enable the external USB ports.</p> <p>By default, the Enable External USB Ports option is enabled.</p>
Enable USB Boot Support	<p>Enable the boot up from USB mass storage devices that are connected to external USB ports.</p> <p>By default, the Enable USB Boot Support option is enabled.</p>

Table 34. System setup options—Integrated Devices menu (continued)

Integrated Devices	
Enable Thunderbolt Technology Support	
Enable Thunderbolt Technology Support	Enable the associated ports and adapters for Thunderbolt Technology support. By default, the Enable Thunderbolt Technology Support option is enabled.
Disable USB4 PCIE Tunneling	Disables the USB4 PCIE Tunneling option. By default, the Disable USB4 PCIE Tunneling option is disabled.
Video/Power only on Type-C Ports	Enables or disables the Type-C port functionality to video or only power. By default, the Video/Power only on Type-C Ports option is disabled.
Miscellaneous Devices	
Enable Fingerprint Reader Device	Enables the Fingerprint Reader Device option. By default, the Enable Fingerprint Reader Device option is enabled.

Table 35. System setup options—Connection menu

Connection	
Wireless Device Enable	
WLAN	Enables or disables the internal WLAN device. By default, the WLAN option enabled.
Bluetooth	Enables or disables the internal Bluetooth device. By default, the Bluetooth option enabled. i NOTE: To view this option, enable Advanced Setup mode as described in View Advanced Setup options .
Enable UEFI Network Stack	Enables or disables the UEFI Network Stack and controls the onboard LAN Controller. By default, the Enable UEFI Network Stack option is enabled. i NOTE: To view this option, enable Advanced Setup mode as described in View Advanced Setup options .
HTTP(s) Boot Feature	
HTTP(s) Boot	Enable or disable the HTTPs Boot feature. By default, the HTTP(s) Boot option is enabled. i NOTE: To view this option, enable Advanced Setup mode as described in View Advanced Setup options .
HTTP(s) Boot Modes	With Auto Mode , the HTTPs Boot automatically extracts the Boot URL from the DHCP. With Manual Mode , the HTTPs Boot reads the Boot URL from the user-provided data. By default, the Auto Mode option is enabled. i NOTE: To view this option, enable Advanced Setup mode as described in View Advanced Setup options .
CA Certificate	Upload or delete the CA certificate. i NOTE: To view this option, enable Advanced Setup mode as described in View Advanced Setup options .

Table 36. System setup options—Storage menu

Storage	
Storage Interface	Displays the information of various onboard drives.
Port Enablement	Enables or disables the M.2 PCIe SSD option. By default, the M.2 PCIe SSD option is enabled.
Drive Information	Displays the information of onboard drives.

Table 37. System setup options—Display menu

Display	
Display Brightness	
Brightness on battery power	Enables to set the screen brightness when the computer is running on battery power. By default, the screen brightness is set to 50 when the computer is running on battery power.
Brightness on AC power	Enables to set the screen brightness when the computer is running on AC power. By default, the screen brightness is set to 100 when the computer is running on AC power.

Table 38. System setup options—Power menu

Power	
Thermal Management	Enables or disables cooling of fan and manages processor heat to adjust the computer performance, noise, and temperature. By default, the Optimized option is selected. Standard setting for balanced performance, noise, and temperature.  NOTE: To view this option, enable Advanced Setup mode as described in View Advanced Setup options .
Lid Switch	
Enable Lid Switch	Enables or disables the Lid Switch. By default, the Enable Lid Switch option is enabled.
Power On Lid Open	When enabled, it allows the computer to turn on from the off state whenever the lid is opened. By default, the Power On Lid Open option is enabled.

Table 39. System setup options—Security menu

Security	
TPM 2.0 Security	The Trusted Platform Module (TPM) provides various cryptographic services which serve as the cornerstone for many platform security technologies. Trusted Platform Module (TPM) is a security device that stores computer-generated keys for encryption and features such as BitLocker, Virtual Secure Mode, remote Attestation.
TPM 2.0 Security On	Allows you to enable or disable TPM. By default, the TPM 2.0 Security On option is enabled. For additional security, Dell Technologies recommends keeping TPM 2.0 Security On enabled to allow these security technologies to fully function.  NOTE: The options that are listed apply to computers with a discrete Trusted Platform Module (TPM) chip.

Table 39. System setup options—Security menu (continued)

Security	
Attestation Enable	<p>The Attestation Enable option controls the endorsement hierarchy of TPM. Disabling the Attestation Enable option prevents TPM from being used to digitally sign certificates.</p> <p>By default, the Attestation Enable option is enabled.</p> <p>For additional security, Dell Technologies recommends keeping the Attestation Enable option enabled.</p> <p>NOTE: When disabled, this feature may cause compatibility issues or loss of functionality in some operating systems.</p>
Key Storage Enable	<p>The Key Storage Enable option controls the storage hierarchy of TPM, which is used to store digital keys. Disabling the Key Storage Enable option restricts the ability of TPM to store owner's data.</p> <p>By default, the Key Storage Enable option is enabled.</p> <p>For additional security, Dell Technologies recommends keeping the Key Storage Enable option enabled.</p> <p>NOTE: When disabled, this feature may cause compatibility issues or loss of functionality in some operating systems.</p>
Clear	<p>When enabled, the Clear option clears information that is stored in the TPM after exiting the computer's BIOS. This option returns to the disabled state when the computer restarts.</p> <p>By default, the Clear option is disabled.</p> <p>Dell Technologies recommends enabling the Clear option only when TPM data is required to be cleared.</p>
PPI Bypass for Clear Commands	<p>The PPI (Physical Presence Interface) Bypass for Clear Commands option allows the operating system to manage certain aspects of PTT. When enabled, you are not prompted to confirm changes to the PTT configuration.</p> <p>By default, the PPI Bypass for Clear Commands option is disabled.</p> <p>For additional security, Dell Technologies recommends keeping the PPI Bypass for Clear Commands option disabled.</p>
Chassis Intrusion	
Chassis Intrusion	<p>The chassis intrusion detection enables a physical switch that triggers an event when the computer cover is opened.</p> <p>When set to Enabled, a notification is displayed on the next boot and the event is logged in the BIOS Events log.</p> <p>When set to On-Silent, the event is logged in the BIOS Events log, but no notification is displayed.</p> <p>When set to Disabled, no notification is displayed and no event is logged in the BIOS Events log.</p> <p>By default, the On-Silent option is enabled.</p> <p>For additional security, Dell Technologies recommends keeping the Chassis Intrusion Detection option enabled.</p>
Clear Intrusion Warning	<p>The Clear Intrusion Warning option appears only after chassis intrusion is enabled and is tripped.</p> <p>By default, the Clear Intrusion Warning option is disabled.</p>
Block Boot Until Cleared	<p>Enables or disables the Block Boot Until Cleared option.</p> <p>By default, the Block Boot Until Cleared option is disabled.</p>

Table 39. System setup options—Security menu (continued)



Security	
	<p> NOTE: When enabled, the computer does not boot until the chassis intrusion is cleared. If the administrator password is set, Setup has to be unlocked before the warning can be cleared.</p>
Data Wipe on Next Boot	
Start Data Wipe	<p>Data Wipe is a secure wipe operation that deletes information from a storage device.</p> <p> CAUTION: The secure Data Wipe operation deletes information in a way that it cannot be reconstructed.</p> <p>Commands such as delete and format in the operating system may remove files from showing up in the file system. However, they can be reconstructed through forensic means as they are still represented on the physical media. Data Wipe prevents this reconstruction and is not recoverable.</p> <p>When enabled, the data wipe option will prompt to wipe any storage devices that are connected to the computer on the next boot.</p> <p>By default, the Start Data Wipe option is disabled.</p>
UEFI Boot Path Security	<p>Enables or disables the computer to prompt the user to enter the Administrator password (if set) when booting to a UEFI boot path device from the F12 boot menu.</p> <p>By default, the Always Except Internal HDD option is enabled.</p>
Pluton Security Processor	<p>Pluton Security Processor is used by the operating system to provide security services such as Key Storage Provider functionality. When enabled, the Pluton Security Processor services are available to the operating system. Disabling the Pluton Security Processor might limit some operating system security services and impact functionality. .</p> <p>By default, the Pluton Security Processor option is enabled.</p> <p>For additional security, Dell Technologies recommends keeping the Pluton Security Processor option enabled.</p>

Table 40. System setup options—Passwords menu

Passwords	
Admin Password	<p>The Administrator Password prevents unauthorized access to the BIOS Setup options. Once the administrator password is set, the BIOS setup options can only be modified after providing the correct password.</p> <p>The following rules and dependencies apply to the Administrator Password -</p> <ul style="list-style-type: none"> • The administrator password cannot be set if computer and/or internal hard drive passwords are previously set. • The administrator password can be used in place of the computer and/or internal hard drive passwords. • When set, the administrator password must be provided during a firmware update. • Clearing the administrator password also clears the computer password (if set). <p>Dell Technologies recommends using an administrator password to prevent unauthorized changes to BIOS setup options.</p>
System Password	<p>The System Password prevents the computer from booting to an operating system without entering the correct password.</p> <p>The following rules and dependencies apply when the System Password is used -</p>

Table 40. System setup options—Passwords menu (continued)

<p>Passwords</p>	<ul style="list-style-type: none"> • The computer shuts down when idle for approximately 10 minutes at the computer password prompt. • The computer shuts down after three incorrect attempts to enter the computer password. • The computer shuts down when the Esc key is pressed at the System Password prompt. • The computer password is not prompted when the computer resumes from standby mode. <p>Dell Technologies recommends using the computer password in situations where it is likely that a computer may be lost or stolen.</p>
<p>M.2 PCIe SSD-0</p>	<p>The Hard Drive Password can be set to prevent unauthorized access of the data stored on the hard drive. The computer prompts for the hard drive password during boot in order to unlock the drive. A password-secured hard drive stays locked even when removed from the computer or placed into another computer. It prevents an attacker from accessing data on the drive without authorization.</p> <p>The following rules and dependencies apply when the Hard Drive Password is used -</p> <ul style="list-style-type: none"> • The hard drive password option cannot be accessed when a hard drive is disabled in the BIOS setup. • The computer shuts down when idle for approximately 10 minutes at the hard drive password prompt. • The computer shuts down after three incorrect attempts to enter the hard drive password and treats the hard drive as not available. • The hard drive does not accept password unlock attempts after five incorrect attempts to enter the hard drive password from the BIOS Setup. The hard drive password must be reset for the new password unlock attempts. • The computer treats the hard drive as not available when the Esc key is pressed at the hard drive password prompt. • The hard drive password is not prompted when the computer resumes from standby mode. When the hard drive is unlocked by the user before the computer goes into standby mode, it remains unlocked after the computer resumes from standby mode. • If the computer and hard drive passwords are set to the same value, the hard drive unlocks after the correct computer password is entered. <p>Dell Technologies recommends using a hard drive password to protect unauthorized data access.</p>
<p>Password Configuration</p>	<p>The Password configuration page includes several options for changing the requirements of BIOS passwords. You can modify the minimum and maximum length of the passwords and require passwords to contain certain character classes (upper case, lower case, digit, special character).</p> <p>Dell Technologies recommends setting the minimum password length to at least eight characters.</p> <p> NOTE: To view this option, enable Advanced Setup mode as described in View Advanced Setup options.</p>
<p>Password Changes</p>	<p>Allow Non-Admin Password Changes</p> <p>The Allow Non-Admin Password Changes option in BIOS setup allows an end user to set or change the computer or hard drive passwords without entering the administrator password. This gives an administrator control over the BIOS settings but enables an end user to provide their own password.</p> <p>By default, the Allow Non-Admin Password Changes option is disabled.</p> <p>For additional security, Dell Technologies recommends keeping the Allow Non-Admin Password Changes option disabled.</p>

Table 40. System setup options—Passwords menu (continued)







Passwords	
	<p> NOTE: To view this option, enable Advanced Setup mode as described in View Advanced Setup options.</p>
Admin Setup Lockout	<p>The Admin Setup Lockout option prevents an end user from even viewing the BIOS setup configuration without first entering the administrator password (if set).</p> <p>By default, the Enable Admin Setup Lockout option is disabled.</p> <p>For additional security, Dell Technologies recommends keeping the Admin Setup Lockout option disabled.</p> <p> NOTE: To view this option, enable Advanced Setup mode as described in View Advanced Setup options.</p>
Master Password Lockout	
Enable Master Password Lockout	<p>The Master Password Lockout setting allows you to disable the Recovery Password feature. If the computer, administrator, or hard drive password is forgotten, the computer becomes unusable.</p> <p> NOTE: When the owner password is set, the Master Password Lockout option is not available.</p> <p> NOTE: When an internal hard drive password is set, it must first be cleared before Master Password Lockout can be changed.</p> <p>By default, the Enable Master Password Lockout option is disabled.</p> <p>Dell Technologies does not recommend enabling the Master Password Lockout unless you have implemented your own password recovery computer.</p> <p> NOTE: To view this option, enable Advanced Setup mode as described in View Advanced Setup options.</p>
Allow Non-Admin PSID Revert	
Enable Allow Non-Admin PSID Revert	<p>Controls access to the Physical Security ID (PSID) revert of NVMe hard-drives from the Dell Security Manager prompt.</p> <p>By default, the Enable Allow Non-Admin PSID Revert option is disabled.</p> <p> NOTE: To view this option, enable Advanced Setup mode as described in View Advanced Setup options.</p>

Table 41. System setup options—Update, Recovery menu

Update, Recovery	
BIOS Downgrade	
Allow BIOS Downgrade	<p>Controls flashing of the computer firmware to previous revisions.</p> <p>By default, the Allow BIOS Downgrade option is enabled.</p>

Table 42. System setup options—System Management menu

System Management	
Service Tag	Displays the Service Tag of the computer.
Asset Tag	<p>Creates a computer Asset Tag that can be used by an IT administrator to uniquely identify a particular computer.</p> <p> NOTE: Once set in BIOS, the Asset Tag cannot be changed.</p>
AC Behavior	

Table 42. System setup options—System Management menu (continued)

System Management	
Wake on AC	Enables or disables the computer to turn on and go to boot when AC power is supplied to the computer. By default, the Wake on AC option is disabled.
First Power On Date	
Set Ownership Date	Sets the ownership date or date of first power on for your computer. By default, the Set Ownership Date option is disabled.

Table 43. System setup options—Keyboard menu



Keyboard	
Fn Lock Options	Enables or disables the Fn Lock option. By default, the Fn Lock option is enabled.  NOTE: To view this option, enable Advanced Setup mode as described in View Advanced Setup options .
Lock Mode	By default, the Lock Mode Secondary option is enabled. With this option, the F1-F12 keys scan the code for their secondary functions.  NOTE: To view this option, enable Advanced Setup mode as described in View Advanced Setup options .
Keyboard Illumination	Configures the operating mode of the keyboard illumination feature. By default, the Dim option is selected. Enables the keyboard illumination feature at 100% brightness level.
Keyboard Backlight Timeout on AC	Sets the timeout value for the keyboard backlight when an AC adapter is connected to the computer. By default, the 10 seconds option is selected.
Keyboard Backlight Timeout on Battery	Sets the timeout value for the keyboard backlight when the computer is running only on the battery power. The keyboard backlight timeout value is only effective when the backlight is enabled. By default, the 10 seconds option is selected.

Table 44. System setup options—Preboot Behavior menu

Preboot Behavior	
MAC Address Pass-Through	Replaces the external NIC MAC address (in a supported dock or dongle) with the selected MAC address from the computer. By default, the Passthrough MAC Address option is selected.
Sign of Life	
Early Keyboard Backlight	Keyboard Backlight Sign of Life. By default, the Early Keyboard Backlight option is enabled.

Table 45. System setup options—System Logs menu

System Logs	
BIOS Event Log	
Clear BIOS Event Log	Allows you to select option to keep or clear BIOS events logs. By default, the Keep Log option is selected.

Updating the BIOS

Updating the BIOS in Windows

About this task

 **CAUTION:** If BitLocker is not suspended before updating the BIOS, the next time you reboot the computer it will not recognize the BitLocker key. You will then be prompted to enter the recovery key to progress, and the computer will ask for this on each reboot. If the recovery key is not known this can result in data loss or an unnecessary operating system reinstall. For more information about this subject, search in the Knowledge Base Resource at [Dell Support Site](#).

Steps

1. Go to [Dell Support Site](#).
2. Click **Product support**. In the **Search support** box, enter the Service Tag of your computer, and then click **Search**.
 **NOTE:** If you do not have the Service Tag, use the SupportAssist to automatically identify your computer. You can also use the product ID or manually browse for your computer model.
3. Click **Drivers & Downloads**. Expand **Find drivers**.
4. Select the operating system installed on your computer.
5. In the **Category** drop-down list, select **BIOS**.
6. Select the latest version of BIOS, and click **Download** to download the BIOS file for your computer.
7. After the download is complete, browse the folder where you saved the BIOS update file.
8. Double-click the BIOS update file icon and follow the on-screen instructions.
For more information, search in the Knowledge Base Resource at [Dell Support Site](#).

Updating the BIOS using the USB drive in Windows

About this task

 **CAUTION:** If BitLocker is not suspended before updating the BIOS, the next time you reboot the computer it will not recognize the BitLocker key. You will then be prompted to enter the recovery key to progress, and the computer will ask for this on each reboot. If the recovery key is not known this can result in data loss or an unnecessary operating system reinstall. For more information about this subject, search in the Knowledge Base Resource at [Dell Support Site](#).

Steps

1. Follow the procedure from step 1 to step 6 in [Updating the BIOS in Windows](#) to download the latest BIOS setup program file.
2. Create a bootable USB drive. For more information, search in the Knowledge Base Resource at [Dell Support Site](#).
3. Copy the BIOS setup program file to the bootable USB drive.
4. Connect the bootable USB drive to the computer that needs the BIOS update.
5. Restart the computer and press **F12**.
6. Select the USB drive from the **One Time Boot Menu**.
7. Type the BIOS setup program filename and press **Enter**.
The **BIOS Update Utility** appears.
8. Follow the on-screen instructions to complete the BIOS update.

Updating the BIOS from the One-Time boot menu

Update your computer BIOS using the BIOS XXXX.exe file that is copied to a FAT32 USB drive and booting from the One-Time boot menu.

About this task

CAUTION: If BitLocker is not suspended before updating the BIOS, the next time you reboot the computer it will not recognize the BitLocker key. You will then be prompted to enter the recovery key to progress, and the computer will ask for this on each reboot. If the recovery key is not known this can result in data loss or an unnecessary operating system reinstall. For more information about this subject, search in the Knowledge Base Resource at [Dell Support Site](#).

BIOS Update

You can run the BIOS flash update file from Windows using a bootable USB drive or you can also update the BIOS from the One-Time boot menu on the computer.

You can confirm by booting your computer to the **One Time Boot** Menu to see if BIOS FLASH UPDATE is listed as a boot option . If the option is listed, then the BIOS can be updated using this method..

Updating from the One-Time boot menu

To update your BIOS from the One-Time boot menu, you need the following:

- USB drive formatted to the FAT32 file system (the drive does not have to be bootable)
- BIOS executable file that you downloaded from the Dell Support website and copied to the root of the USB drive
- AC power adapter must be connected to the computer
- Functional computer battery to flash the BIOS

Perform the following steps to perform the BIOS flash update process from the One-Time boot menu:

CAUTION: Do not turn off the computer during the BIOS flash update process. The computer may not boot if you turn off your computer.

Steps

1. Turn off your computer, insert the USB drive where you copied the BIOS flash update file into a USB port of the computer.
2. Turn on the computer and press to access the **One Time Boot** Menu. Select BIOS Update using the mouse or arrow keys then press Enter.
The flash BIOS menu is displayed.
3. Click **Flash from file**.
4. Select the external USB device.
5. Select the file and double-click the flash target file, and then click **Submit**.
6. Click **Update BIOS**. The computer restarts to flash the BIOS.
7. The computer will restart after the BIOS flash update is completed.

System and setup password

Table 46. System and setup password

Password type	Description
System password	Password that you must enter to log in to your system.
Setup password	Password that you must enter to access and make changes to the BIOS settings of your computer.

You can create a system password and a setup password to secure your computer.

CAUTION: The password features provide a basic level of security for the data on your computer.

CAUTION: Anyone can access the data that is stored on your computer, when left unattended.

 **NOTE:** System and setup password feature is disabled.

Assigning a System Setup password

Prerequisites

You can assign a new System or Admin Password only when the status is in **Not Set**.

About this task

To enter BIOS System Setup, press F2 immediately after a power-on or reboot.

Steps

1. In the **System BIOS** or **System Setup** screen, select **Security** and press Enter.
The **Security** screen is displayed.
2. Select **System/Admin Password** and create a password in the **Enter the new password** field.
Use the following guidelines to assign the system password:
 - A password can have up to 32 characters.
 - At least one special character: "(! " # \$ % & ' * + , - . / : ; < = > ? @ [\] ^ _ ` { | })"
 - Numbers 0 to 9.
 - Upper case letters from A to Z.
 - Lower case letters from a to z.
3. **Confirm new password** type the system password that you entered earlier in the field and click **OK**.
4. Press Esc and save the changes as prompted by the message.
5. Press Y to save the changes.
The computer restarts.

Deleting or changing an existing system password or setup password

Prerequisites

Ensure that the **Password Status** is Unlocked (in the System Setup) before attempting to delete or change the existing system password and/or setup password. You cannot delete or change an existing system password or setup password if the **Password Status** is Locked.

About this task

To enter the System Setup, press F2 immediately after a power-on or reboot.

Steps

1. In the **System BIOS** or **System Setup** screen, select **System Security** and press Enter.
The **System Security** screen is displayed.
2. In the **System Security** screen, verify that the **Password Status** is Unlocked.
3. Select **System Password**. Update or delete the existing system password, and press Enter or Tab.
4. Select **Setup Password**. Update or delete the existing setup password, and press Enter or Tab.
 **NOTE:** If you change the system password and/or setup password, reenter the new password when prompted. If you delete the system password and/or setup password, confirm the deletion when prompted.
5. Press Esc. A message prompts you to save the changes.
6. Press Y to save the changes and exit from **System Setup**.
The computer restarts.

Clearing CMOS settings

About this task

 **CAUTION:** Clearing CMOS settings resets the BIOS settings on your computer.

Steps

1. Remove the [base cover](#).
2. Disconnect the battery cable from the system board.
3. Remove the [coin-cell battery](#).
4. Wait for one minute.
5. Replace the [coin-cell battery](#).
6. Connect the battery cable to the system board.
7. Replace the [base cover](#).

Clearing BIOS (System Setup) and System passwords

About this task

To clear the computer or BIOS passwords, contact Dell technical support as described at [Contact Support](#). For more information, go to [Dell Support Site](#).

 **NOTE:** For information about how to reset Windows or application passwords, see the documentation accompanying Windows or your application.

Clearing chassis intrusion alert

The computer features a chassis intrusion switch that detects when the base cover had been removed from the computer.

Alerts to notify you of any intrusions can be enabled through the **Chassis Intrusion** field in the **Security** submenu of the BIOS setup menu.

When enabled, the **Block Boot Until Cleared** field allows you to choose whether to prevent normal boot-up of the computer until the intrusion alert is cleared.

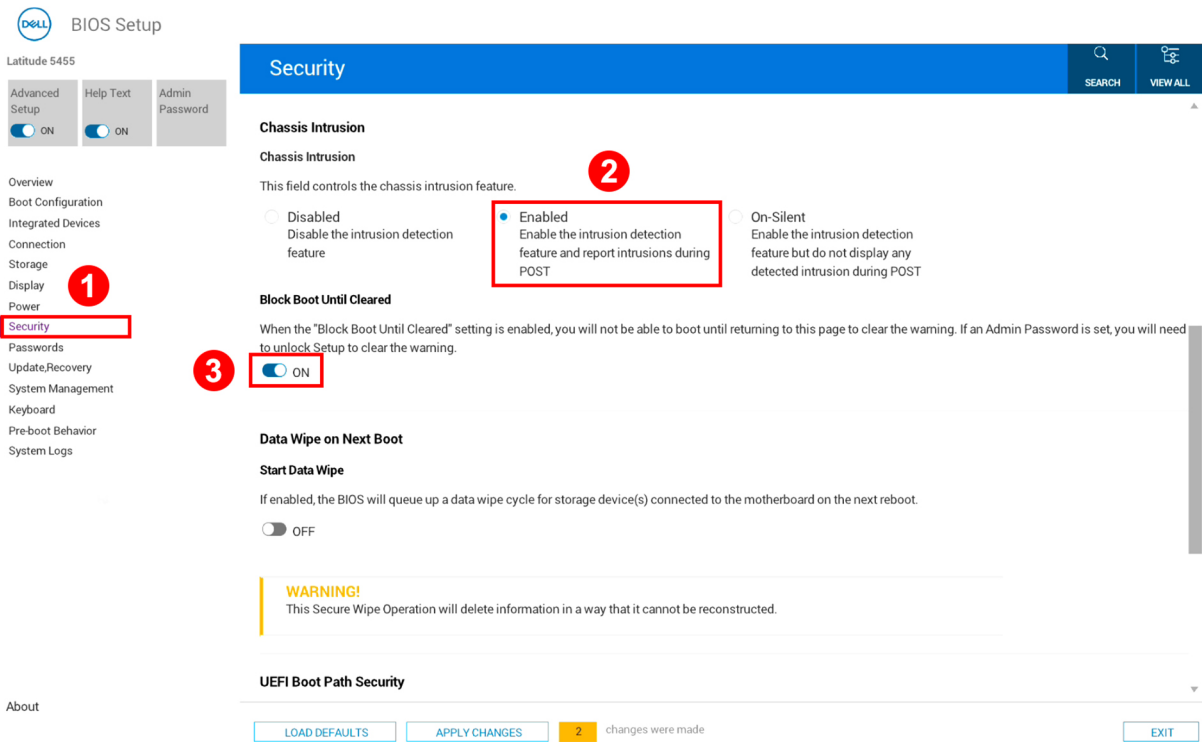

Figure 68. Enable block boot until cleared

If **Block Boot Until Cleared** is set to **ON**, select **BIOS-Setup** to clear the alert so the computer boots up as per normal.

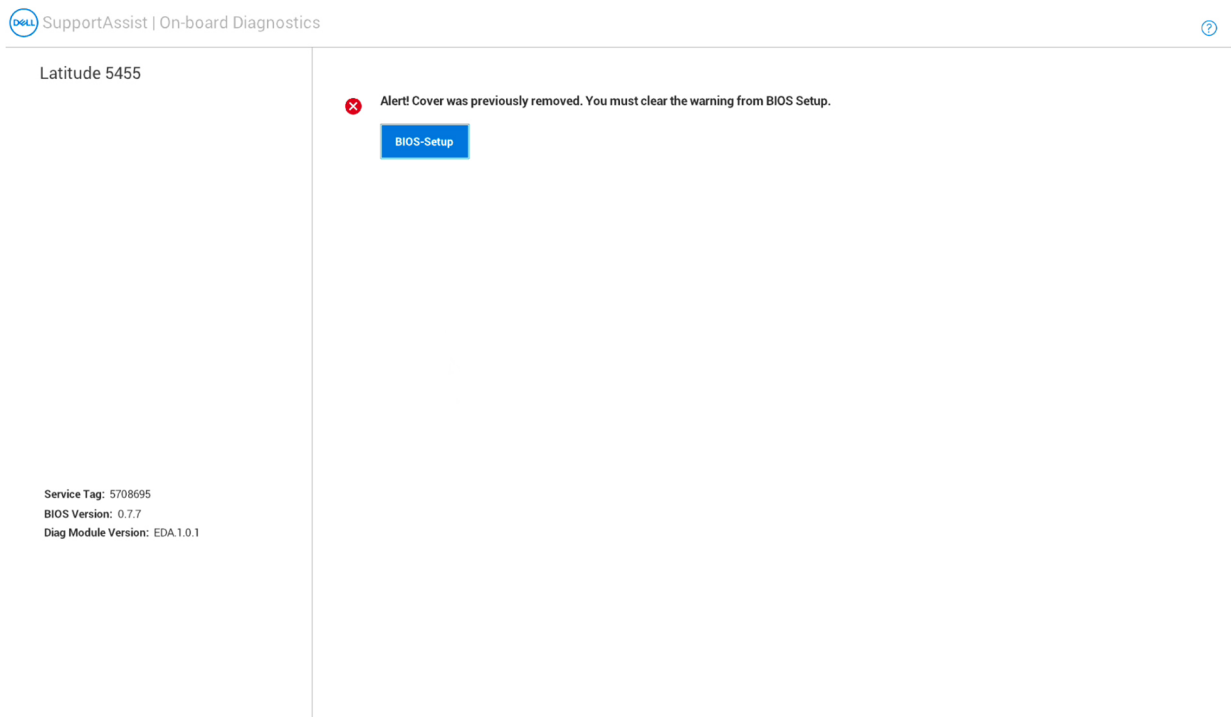

Figure 69. Clear chassis intrusion alert

If **Block Boot Until Cleared** is set to **OFF**, select **Continue** or **BIOS-Setup** to clear the alert so the computer boots up as per normal.

Latitude 5455

Alert! Cover was previously removed.
 Note: This warning can be disabled in BIOS setup.

Service Tag: 5708695
 BIOS Version: 0.7.7
 Diag Module Version: EDA.1.0.1

Figure 70. Clear chassis intrusion alert

NOTE: If **Continue** is selected, the user continues to see the alert each time the computer is turned on until the alert is cleared.

To clear the alert, select **ON** in the **Clear Intrusion Warning** field in the **Security** submenu of the BIOS setup menu.

The screenshot shows the BIOS Setup interface for a Latitude 5455. The 'Security' submenu is selected, and the 'Chassis Intrusion' section is expanded. The 'Clear Intrusion Warning' toggle switch is currently set to 'OFF' and is highlighted with a red box. Other settings like 'Block Boot Until Cleared' (ON) and 'Data Wipe on Next Boot' (OFF) are also visible. At the bottom, a 'WARNING!' banner indicates that 0 changes were made.

Figure 71. Clear intrusion warning

Troubleshooting

Handling swollen rechargeable Li-ion batteries

Like most laptops, Dell laptops use Lithium-ion batteries. One type of Lithium-ion battery is the rechargeable Li-ion battery. Rechargeable Li-ion batteries have increased in popularity in recent years and have become a standard in the electronics industry due to customer preferences for a slim form factor (especially with newer ultra-thin laptops) and long battery life. Inherent to rechargeable Li-ion battery technology is the potential for swelling of the battery cells.

A swollen battery may impact the performance of the laptop. To prevent possible further damage to the device enclosure or internal components leading to malfunction, discontinue the use of the laptop and discharge it by disconnecting the AC adapter and letting the battery drain.

Swollen batteries should not be used and must be replaced and disposed of properly. We recommend contacting Dell Support for options to replace a swollen battery under the terms of the applicable warranty or service contract, including options for replacement by a Dell authorized service technician.

The guidelines for handling and replacing rechargeable Li-ion batteries are as follows:

- Exercise caution when handling rechargeable Li-ion batteries.
- Discharge the battery before removing it from the computer. To discharge the battery, unplug the AC adapter from the computer and operate the computer only on battery power. The battery is fully discharged when the computer no longer turns on when the power button is pressed.
- Do not crush, drop, mutilate, or penetrate the battery with foreign objects.
- Do not expose the battery to high temperatures, or disassemble battery packs and cells.
- Do not apply pressure to the surface of the battery.
- Do not bend the battery.
- Do not use tools of any type to pry on or against the battery.
- If a battery gets stuck in a device as a result of swelling, do not try to free it as puncturing, bending, or crushing a battery can be dangerous.
- Do not attempt to reassemble a damaged or swollen battery into a laptop.
- Swollen batteries that are covered under warranty should be returned to Dell in an approved shipping container (provided by Dell)—this is to comply with transportation regulations. Swollen batteries that are not covered under warranty should be disposed of at an approved recycling center. Contact Dell Support at [Dell Support Site](#) for assistance and further instructions.
- Using a non-Dell or incompatible battery may increase the risk of fire or explosion. Replace the battery only with a compatible battery purchased from Dell that is designed to work with your Dell computer. Do not use a battery from other computers with your computer. Always purchase genuine batteries from [Dell Site](#) or otherwise directly from Dell.

Rechargeable Li-ion batteries can swell for various reasons such as age, number of charge cycles, or exposure to high heat. For more information about how to improve the performance and lifespan of the laptop battery and to minimize the possibility of occurrence of the issue, search Dell laptop battery in the Knowledge Base Resource at [Dell Support Site](#).

Locating the Service Tag or Express Service Code of your Dell computer

Your Dell computer is uniquely identified with a Service Tag or Express Service Code. To view relevant support resources for your Dell computer, we recommend entering the Service Tag or Express Service Code at [Dell Support Site](#).

For more information about how to find the Service Tag for your computer, see [Instructions on how to find your Service Tag or Serial Number](#).

Dell SupportAssist Pre-boot System Performance Check diagnostics

About this task

SupportAssist diagnostics (also known as system diagnostics) performs a complete check of your hardware. The Dell SupportAssist Pre-boot System Performance Check diagnostics is embedded with the BIOS and launched by the BIOS internally. The embedded system diagnostics provides options for particular devices or device groups allowing you to:

- Run tests automatically or in an interactive mode.
- Repeat the tests.
- Display or save test results.
- Run thorough tests to introduce additional test options to provide extra information about one or more failed devices.
- View status messages that inform you the tests are completed successfully.
- View error messages that inform you of problems encountered during testing.

 **NOTE:** Some tests for specific devices require user interaction. Always ensure that you are present at the computer when the diagnostic tests are performed.

For more information, see the knowledge base article [000181163](#).

Running the SupportAssist Pre-Boot System Performance Check

Steps

1. Turn on your computer.
2. As the computer boots, press the F12 key as the Dell logo appears.
3. On the boot menu screen, select the **Diagnostics** option.
4. Click the arrow at the bottom left corner.
Diagnostics page is displayed.
5. Click the arrow in the lower-right corner to go to the page listing.
The items that are detected are listed.
6. To run a diagnostic test on a specific device, press Esc and click **Yes** to stop the diagnostic test.
7. Select the device from the left pane and click **Run Tests**.
8. If there are any issues, error codes are displayed.
Note the error code and validation number and contact Dell.

Built-in self-test (BIST)

LCD Built-in Self-Test (BIST)

Dell laptops have a built-in diagnostic tool that helps you determine if the screen abnormality you are experiencing is an inherent problem with the LCD (screen) of the Dell laptop or with the video card (GPU) and computer settings.

When you notice screen abnormalities like flickering, distortion, clarity issues, fuzzy or blurry image, horizontal or vertical lines, color fade and so on, it is always a good practice to isolate the LCD (screen) by running the Built-In Self-Test (BIST).

How to invoke the LCD BIST

1. Turn off your computer.
2. Disconnect any peripherals that are connected to the computer. Connect only the AC adapter (charger) to the computer.
3. Ensure that the LCD (screen) is clean (no dust particles on the surface of the screen).
4. Press and hold the **D** key and press the power button to enter LCD built-in self-test (BIST) mode. Continue to hold the **D** key until the computer boots up.
5. The screen displays solid colors and change colors on the entire screen to white, black, red, green, and blue twice.
6. Then it displays the colors white, black, and red.

7. Carefully inspect the screen for abnormalities (any lines, fuzzy color, or distortion on the screen).
8. At the end of the last solid color (red), the computer shuts down.

NOTE: Dell SupportAssist Preboot diagnostics upon launch initiates an LCD BIST first, expecting a user intervention to confirm functionality of the LCD.

LCD Power rail test (L-BIST)

L-BIST is an enhancement to the single LED error code diagnostics and is automatically initiated during POST. L-BIST checks the LCD power rail. If there is no power supplied to the LCD (that is if the L-BIST circuit fails), the battery-status light flashes either error code [1,3], [1,4], or [2,8].

NOTE: If L-BIST fails, LCD-BIST cannot function as no power is supplied to the LCD.

How to invoke the L-BIST Test

1. Press the power button to start the computer.
2. If the computer does not start up, check the battery-status light:
 - If the battery-status light flashes an error code [1,3] or [1,4], the display cable may not be connected properly.
 - If the battery-status light flashes an error code [2,8], there is a failure on the LCD power rail of the system board, hence there is no power that is supplied to the LCD.
3. For cases, when a [1,3] or [1,4] error code is shown, check if the display cable is properly connected.
4. For cases when a [2,8] error code is shown, replace the system board.

System-diagnostic lights

This section lists the system-diagnostic light codes of your Latitude 5455.

NOTE: The battery-status light indicator shows the system-diagnostic light codes.

Table 47. System-diagnostic light codes

Blinking pattern		Problem description
Amber	White	
1	3	Short in the hinge cable tripped OCP1
1	4	Short in the hinge cable tripped OCP2
2	2	System board failure (included BIOS corruption or ROM error)
2	8	LCD failure (EC detection of power rail failure)

Backup media and recovery options

It is recommended to create a recovery drive to troubleshoot and fix problems that may occur with Windows. Dell provides multiple options for recovering the Windows operating system on your Dell computer. For more information, see [Dell Windows Backup Media and Recovery Options](#).

Wi-Fi power cycle

About this task

If your computer is unable to access the Internet due to Wi-Fi connectivity issues, reset your Wi-Fi device by performing the following steps:

Steps

1. Turn off the computer.
2. Turn off the modem.
 **NOTE:** Some Internet service providers (ISPs) provide a modem and router combo device.
3. Turn off the wireless router.
4. Wait for 30 seconds.
5. Turn on the wireless router.
6. Turn on the modem.
7. Turn on the computer.

Drain residual flea power (perform hard reset)

About this task

Flea power is the residual static electricity that remains in the computer even after it has been powered off and the battery is removed.

For your safety, and to protect the sensitive electronic components in your computer, you must drain residual flea power before removing or replacing any components in your computer.

Draining residual flea power, also known as performing a "hard reset," is also a common troubleshooting step if your computer does not turn on or boot into the operating system.

Perform the following steps to drain the residual flea power:

Steps

1. Turn off the computer.
2. Disconnect the power adapter from the computer.
3. Remove the base cover.
4. Remove the battery.
 **CAUTION: The battery is a Field Replaceable Unit (FRU) and the removal and installation procedures are intended for authorized service technicians only.**
5. Press and hold the power button for 20 seconds to drain the flea power.
6. Install the battery.
7. Install the base cover.
8. Connect the power adapter to the computer.
9. Turn on the computer.

 **NOTE:** For more information about performing a hard reset, search in the Knowledge Base Resource at the [Dell Support Site](#).

Getting help and contacting Dell

Self-help resources

You can get information and help on Dell products and services using these self-help resources:

Table 48. Self-help resources

Self-help resources	Resource location
Information about Dell products and services	Dell Site
Tips	
Contact Support	In Windows search, type <code>Contact Support</code> , and press Enter.
Online help for operating system	Windows Support Site
Access top solutions, diagnostics, drivers and downloads, and learn more about your computer through videos, manuals, and documents.	Your Dell computer is uniquely identified by a Service Tag or Express Service Code. To view relevant support resources for your Dell computer, enter the Service Tag or Express Service Code at Dell Support Site . For more information about how to find the Service Tag for your computer, see Instructions on how to find your Service Tag or Serial Number .
Dell knowledge base articles	<ol style="list-style-type: none"> 1. Go to Dell Support Site. 2. On the menu bar at the top of the Support page, select Support > Support Library. 3. In the Search field on the Support Library page, type the keyword, topic, or model number, and then click or tap the search icon to view the related articles.

Contacting Dell

To contact Dell for sales, technical support, or customer service issues, see [Contact Support at Dell Support Site](#).

 **NOTE:** Availability of the services may vary depending on the country or region, and product.

 **NOTE:** If you do not have an active Internet connection, you can find contact information about your purchase invoice, packing slip, bill, or Dell product catalog.