

IdeaPad Flex 5i Chromebook Plus (14", 7) and Lenovo Flex 5i Chromebook Plus 14 User Guide



Lenovo

Read this first

Before using this documentation and the product it supports, ensure that you read and understand the following:

- *Safety and Warranty Guide*
- *Setup Guide*
- [Generic Safety and Compliance Notices](#)

First Edition (June 2023)

© Copyright Lenovo 2023.

LIMITED AND RESTRICTED RIGHTS NOTICE: If data or software is delivered pursuant to a General Services Administration "GSA" contract, use, reproduction, or disclosure is subject to restrictions set forth in Contract No. GS-35F-05925.

Contents

Discover your Chromebook	ii
Chapter 1. Meet your Chromebook	1
Front	1
Base	2
Left	3
Right	4
Bottom	5
Features and specifications	6
Statement on USB transfer rate	7
Operating environment	7
Chapter 2. Get started with your Chromebook	9
Charge your Chromebook	9
Lock your Chromebook	9
Connect to Wi-Fi	10
Use the touch screen	10
Use the keyboard shortcuts	12
Use the touchpad	13
Use the camera	14
Use audio	14
Lenovo USI Pen (for selected models)	15
Before first use	15
Connect to an external display	16
Connect to Bluetooth devices	16
Get to know your Chromebook modes	17
Set the power plan	18
Chapter 3. CRU replacement	19
What are CRUs	19
Replace a CRU	19
Pen dummy (for selected models)	19
Base cover assembly	20
Chapter 4. Help and support	23
Frequently asked questions	23
Lenovo Customer Support Center	23
Get help from Google	24
Appendix A. Open source information	27
Appendix B. Notices and trademarks	29

Discover your Chromebook

Thank you for choosing a Lenovo® Chromebook™! We are dedicated to delivering the best solution to you.

Before starting your tour, please read the following information:

- This guide applies to Lenovo product model(s) listed below. Illustrations in this guide may look slightly different from your product model.

Model name	Machine type (MT)
IP Flex 5 Chrome 14IAU7	83EK

- For further compliance information, refer to the *Generic Safety and Compliance Notices* at https://pcsupport.lenovo.com/docs/generic_notices.
- Depending on the model, some optional accessories, features, software programs, and user interface instructions might not be applicable to your Chromebook.
- Documentation content is subject to change without notice. To get the latest documentation, go to <https://pcsupport.lenovo.com>.

Chapter 1. Meet your Chromebook

Front



1. Microphones	Capture or record sound and voice.
2. Camera	Capture still and moving images for taking photos, recording videos, and video chatting.
3. Camera cover	Cover or uncover the camera lens. Note: The camera cover helps you better protect your privacy.
4. Camera light	If the light is on, the camera is in use.
5. Screen	Display text, graphics, and videos. Support multi-touch function.

Base



1. Speakers	Produce sound.
2. Keyboard	Enter characters and interact with programs. Note: The keyboard also includes function keys and key combinations for changing settings and performing tasks quickly.
3. Fingerprint reader*	Enroll and read your fingerprint for user authentication.
4. Touchpad	Perform finger touch and all the functions of a traditional mouse. Note: The touchpad also supports multi-touch function.
5. Wireless antennas	Send and receive radio waves for the built-in wireless local area network (LAN) and Bluetooth module. Note: The antennas are not visible from the outside of the Chromebook.

* for selected models

Left



1. Charging light	Indicate the ac power status and the battery status. See “AC power status indicator behavior” on page 9.
2. Multi-purpose USB Type-C® connector	<ul style="list-style-type: none">• This multi-purpose connector can be used to connect display devices and devices that utilize the USB data transfer technology. It also supports USB Power Delivery. <p>Note: When connecting display devices, you need to use appropriate cables and adapters (if needed) according to the connection capabilities of the display device.</p> <ul style="list-style-type: none">• The USB Type-C connector with a plug icon  next to it also functions as the PC's power input connector.
3. USB (3.2 Gen 1) Type-A connector	Connect a USB-compatible device, such as a USB keyboard, a USB mouse, a USB storage device, or a USB printer.
4. Combo audio jack	Connect headphones or headsets with a 3.5 mm (0.14 inch), 4-pole plug. <p>Note: This jack does not support standalone external microphones. If you use headsets, choose one with a single plug.</p>
5. microSD card slot	Insert a microSD card into the slot for data transfer or storage.

Right

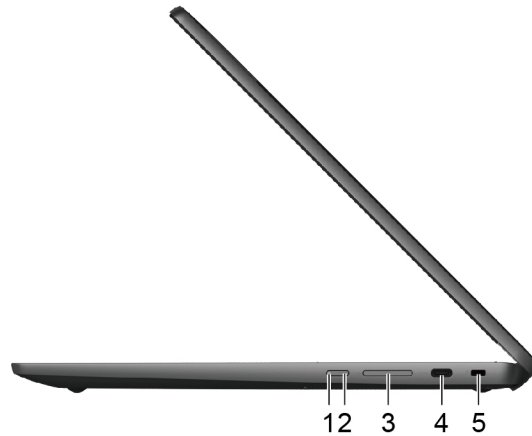

1. Power light	<ul style="list-style-type: none">• On: the Chromebook is turned on.• Off: the Chromebook is turned off or in hibernation mode.• Blinking: the Chromebook is in sleep mode.
2. Power button	<p>Press the button to turn on the Chromebook or put the Chromebook into sleep mode.</p> <p>Notes: When you finish working with your Chromebook, shut it down to save power.</p> <ul style="list-style-type: none">• Click  in the system tray.• Press the power button.
3. Volume buttons	<p>Press the button to increase or decrease the system volume.</p>
4. Multi-purpose USB Type-C connector	<p>This multi-purpose connector can be used to connect devices that utilize the USB data transfer technology and display devices. It also supports USB Power Delivery.</p> <p>Note: When connecting display devices, you need to use appropriate cables and adapters (if needed) according to the connection capabilities of the display device.</p>
5. Nano security-lock slot	<p>Lock your Chromebook to a desk, table, or other fixtures through a compatible security cable lock. See “Lock your Chromebook” on page 9.</p>

Bottom



1. Ventilation slots (outlet)

Maintain the outgoing airflow to dissipate the internal heat.
Attention: Do not block the ventilation slots. Otherwise, the computer may overheat.

2. Ventilation slots (inlet)

Maintain the incoming airflow to dissipate the internal heat.
Attention: Do not block the ventilation slots. Otherwise, the computer might overheat.

Features and specifications

Note: Specifications might change without notice. Some specifications are model-specific and might not apply to the Chromebook model that you purchased.

Dimensions	<ul style="list-style-type: none">• Width: 315.5 mm (12.4 inches)• Depth: 229 mm (9 inches)• Thickness: 19.8 mm (0.8)
ac power adapter	<ul style="list-style-type: none">• Input: 100 V ac–240 V ac, 50 Hz–60 Hz• Output: 15 V dc, 3 A• Power: 45 W
Battery pack	<ul style="list-style-type: none">• Capacity: 51 Wh• Number of cells: 4 <p>Note: The battery capacity is the typical or average capacity as measured in a specific test environment. Capacities measured in other environments may differ but are no lower than the rated capacity (see product label).</p>
Microprocessor	To view the microprocessor information of your Chromebook, type system information in the search box and then press Enter.
Memory	<ul style="list-style-type: none">• Type: Low Power Double data rate 4x (LPDDR4x)• Number of physical slots: 0
Secondary storage device	<ul style="list-style-type: none">• Type 1: Embedded multi media card (eMMC)<ul style="list-style-type: none">– Bus: eMMC– Capacity: 128 G• Type 2: Solid-state drive (SSD)<ul style="list-style-type: none">– Bus: PCIe– Capacity: 256 G or 512 G <p>Note: The capacity of the storage device displayed in the operating system is typically lower than the nominal capacity.</p>
Screen	<ul style="list-style-type: none">• Size: 355.6 mm (14 inches)• Display resolution: 1920 × 1200 pixels (FHD model)
Keyboard	<ul style="list-style-type: none">• Function keys• Keyboard backlight

Connectors and slots

- Combo audio jack
- microSD card slot
- USB Type-A connector
 - Supports power output up to 4.5 W (5 V, 0.9 A)
- Multi-purpose USB Type-C connector × 2
 - Supports power input up to 45 W using the included power adapter
 - Supports SuperSpeed USB 10 Gbps
 - Supports DisplayPort™ Alt Mode (DisplayPort 1.4 Compliant)
 - Supports USB Power Delivery
 - Supports power output up to 15 W (5 V, 3 A)

Note: Data rates and performance ratings are dependent on connected devices and cables if they are used. For DisplayPort connection through a USB Type-C connector, the listed maximum output capacity is only available on external displays with a DisplayPort, a Mini DisplayPort, or a USB Type-C connector that supports DisplayPort Alternate Mode. For connections using a converter or an adapter, the actual output resolution may be lower.

Security

- Fingerprint reader*
- Nano security-lock slot

Network

- Bluetooth and Wi-Fi® combo adapter
-

* for selected models

Statement on USB transfer rate

Depending on many factors such as the processing capability of the host and peripheral devices, file attributes, and other factors related to system configuration and operating environments, the actual transfer rate using the various USB connectors on this device will vary and will be slower than the data rate listed below for each corresponding device.

USB device	Data rate (Gbit/s)
USB 3.2 Gen 1	5
USB 3.2 Gen 2	10

Operating environment

Maximum altitude (without pressurization)

3048 m (10 000 ft)

Temperature

- Operating: 5°C to 35°C (41°F to 95°F)
- Storage: 5°C to 43°C (41°F to 109°F)

Note: When you charge the battery, its temperature must be no lower than 10°C (50°F).

Relative humidity

- Operating: 8% to 95% at wet-bulb temperature 23°C (73°F)

- Storage: 5% to 95% at wet-bulb temperature 27°C (81°F)

Chapter 2. Get started with your Chromebook

Charge your Chromebook

The USB Type-C connector on your Chromebook works as the power connector. Plug in the ac power adapter to charge the built-in battery pack and provide power to the Chromebook.

Connect to ac power

CAUTION:

All plugs must be firmly and securely inserted into receptacles.

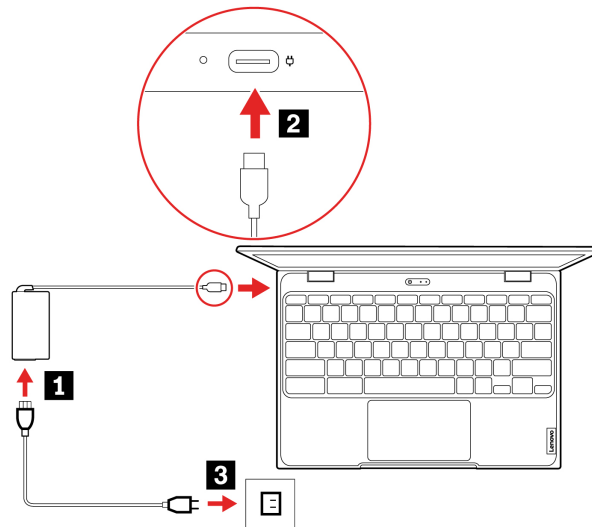

1. Connect the power cord to the ac power adapter.
2. Plug the power adapter into the USB Type-C connector of the Chromebook.
3. Plug the power cord into an electrical outlet.

AC power status indicator behavior

The ac power status indicator is next to the USB Type-C connector. The following table shows the indicator behaviors and the indicated power and battery status.

AC power status indicator	Power status	Battery status
on (red)	plugged in	being charged, remaining power is less than 5%
on (amber)	plugged in	being charged, remaining power is between 5% and 97%
on (green)	plugged in	fully charged (97% to 100%)
off	unplugged	discharging

Lock your Chromebook

Lock your Chromebook to a desk, table, or other fixtures through a compatible security cable lock.

Note: The slot supports cable locks that conform to the NanoSaver® lock standards using Cleat™ locking technology. Do not attempt to use other types of cable locks that use a rotating T-bar™ locking mechanism. You are responsible for evaluating, selecting, and implementing the locking device and security feature. Lenovo makes no comments, judgments, or warranties about the function, quality, or performance of the locking device and security feature. Cable locks for your product are available from Lenovo at <https://www.lenovoquickpick.com/>.

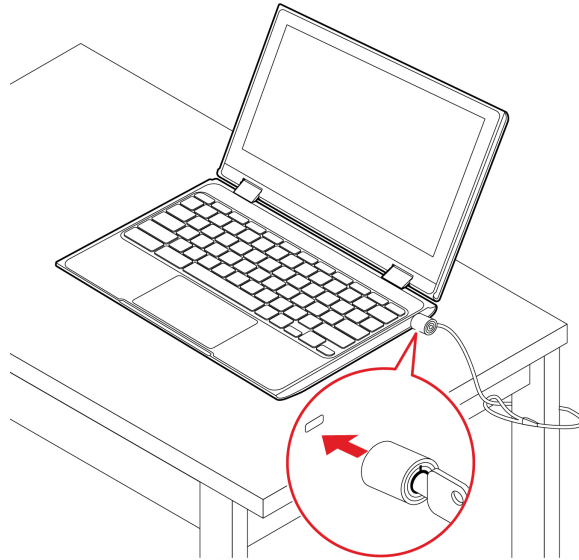

Connect to Wi-Fi

To connect your Chromebook to Wi-Fi:

1. Click your system tray.
2. Click the network icon and turn on the wireless feature.
3. Select an available network to connect. Provide required information if needed.

Use the touch screen

If your Chromebook display supports the multi-touch function, you can navigate the screen with simple touch gestures.

Note: Some gestures might not be available depending on the app you use.



Tap once to single click



Tap and hold to right-click

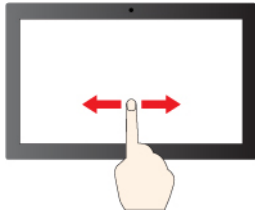

Slide to scroll through items

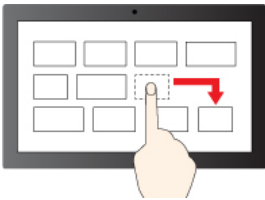

Drag

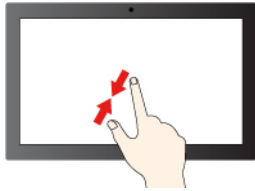

Zoom out

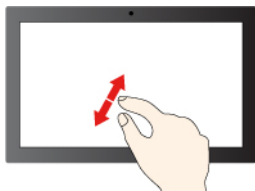

Zoom in

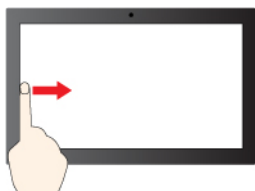

Swipe from the left: view all open windows

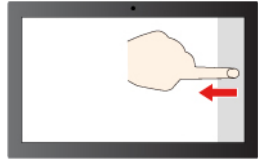

Swipe from the right: open action center

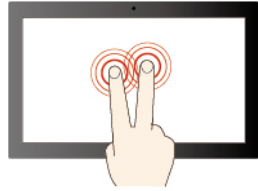

Tap with two fingers to open a shortcut menu

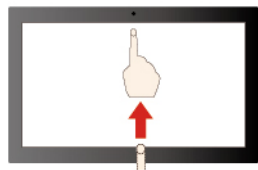









Swipe upwards to unfold the app Launcher



Maintenance tips:

- Turn off the Chromebook before cleaning the multi-touch screen.
- Use a dry, soft, and lint-free cloth or a piece of absorbent cotton to remove fingerprints or dust from the multi-touch screen. Do not apply solvents to the cloth.
- The multi-touch screen is a glass panel covered with a plastic film. Do not apply pressure or place any metallic object on the screen, which might damage the touch panel or cause it to malfunction.
- Do not use fingernails, gloved fingers, or inanimate objects for input on the screen.
- Regularly calibrate the accuracy of the finger input to avoid a discrepancy.





Use the keyboard shortcuts

The function keys on the keyboard help you work more easily and effectively.

	Go to the previous page
	Go to the next page
	Reload your current page
	Hide the tabs and the App Launcher in full-screen mode
	Show all windows in overview mode
	Decrease the brightness of the Chromebook screen
	Increase the brightness of the Chromebook screen
	Mute the speakers
	Decrease the volume

	Increase the volume
	Lock the Chromebook screen

Your Chromebook also supports some key combinations.

ctrl + 	Take a screenshot
alt + 	Switch the Caps Lock function
 + l	Lock your Chromebook screen
ctrl + alt + ?	View all keyboard shortcuts
*alt + 	Turn off the keyboard backlight and decrease the brightness
*alt + 	Turn on the keyboard backlight and increase the brightness

* for selected models

To change the keyboard settings:

1. Click the setting icon in the system tray, and then click **Device → Keyboard**.
2. Follow the on-screen instructions to change the settings as you prefer.

Use the touchpad

The entire touchpad surface is sensitive to finger touch and movement. You can use the touchpad to perform all the pointing, clicking, and scrolling functions of a traditional mouse.

Use the touch gestures

Notes:

- When using two or more fingers, ensure that you position your fingers slightly apart.
- Some gestures are only available when you are using certain apps.
- If the touchpad surface is stained with oil, turn off the Chromebook first. Then, gently wipe the touchpad surface with a soft and lint-free cloth moistened with lukewarm water or Chromebook cleaner.

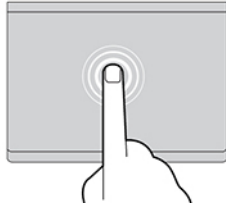

Tap once to select or open an item.

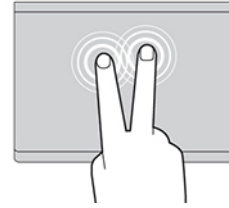

Tap twice quickly to display a shortcut menu.

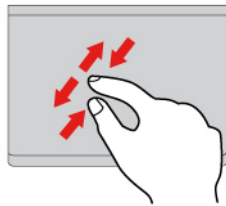

Two-finger zoom in or zoom out.

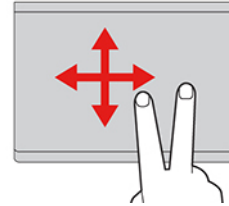

Scroll through items.

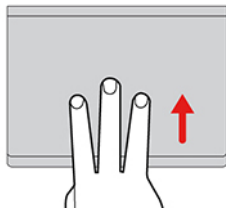

Open the task view.

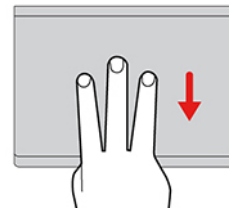

Show the current window.

To change the settings:

1. Click the setting icon in the system tray, and then click **Device → Touchpad**.
2. Follow the on-screen instructions to change the settings as you prefer.

If **Enable tap-to-click** is turned on, you can tap or press the touchpad. Otherwise, you can only press the touchpad to achieve the clicking function of a traditional mouse.

Use the camera

The built-in camera can be used for video calling or video conferencing. The indicator next to the camera turns on when the camera is activated.

To take photos with the camera:

1. Click the Launcher button.
2. Click **Camera** and take photos.

Use audio

You can connect headphones or a headset with a 3.5-mm (0.14-inch), 4-pole plug to the audio connector to listen to the sound from your Chromebook.

To play a saved audio or video:

1. Click the Launcher button, and then select **Files**.
2. Double-click a file to open it in the media player.

To adjust the volume, click the system tray, and then adjust the volume as you prefer.

Lenovo USI Pen (for selected models)

Your Chromebook might come with a Lenovo USI Pen (referred to as *the pen* in this section). The pen enables you to write and draw in a natural manner.

Notes:

- The pen is not waterproof. Take care not to drop the pen in water.
- The pen contains pressure sensors. Do not push the tip of the pen for an extended period of time. Do not subject the pen to shock or vibration.

Pen overview



Name	Description
1. End cap	Unscrew the end cap to install or replace a battery.
2. Pen tip	To click, tap on the screen with the tip. To double-click, tap twice.

Before first use

An insulation pad may be included in the Lenovo USI Pen to prevent capacity loss during shipping. The first time you use the pen, check and remove the insulation pad. 

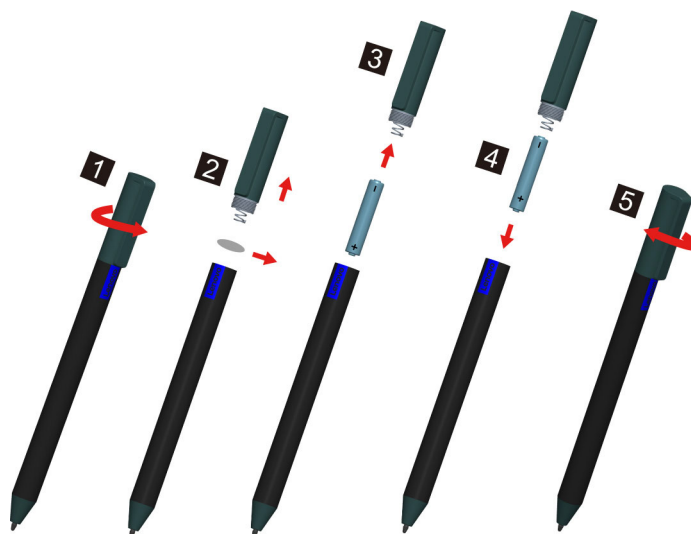

CAUTION:
The Lenovo USI Pen uses AAAA battery. Replace with the right battery.

Connect to an external display

You can use the Chromebook's USB Type-C connectors to connect a projector or an external display.

1. Use a USB Type-C to USB Type-C cable (not supplied) to connect your Chromebook to an external display.

Note: If the external display does not support input through USB Type-C connector, you may need to purchase and use adapters. Lenovo provides various USB Type-C accessories at <https://www.lenovo.com/accessories>, to help you expand your Chromebook functionality.

2. Connect the external display to an electrical outlet.
3. Turn on the external display.

To change display settings:

1. Click your system tray, and then click **Settings**.
2. In the **Device** section, click **Displays**.
3. Follow the on-screen instructions to change the display settings as you desire.

Connect to Bluetooth devices

Your Chromebook supports Bluetooth feature. You can connect your Chromebook to a Bluetooth keyboard, mouse, speakers, or other Bluetooth devices.

Note: The Bluetooth devices must be within a short distance, usually 10 meters (33 feet), from the Chromebook.

1. Click your system tray, and then click the Bluetooth icon.
2. Turn on **Bluetooth**.
3. Select the device you want to pair and follow the on-screen instructions.

Get to know your Chromebook modes

Rotate the display to switch among different modes according to your preference. The keyboard is automatically disabled in the stand mode, tent mode, and tablet mode. Use the touch screen to control your Chromebook instead.

Attention: Do not rotate the Chromebook display with too much force, or apply too much force to the upper-right or upper-left corner of the Chromebook display. Otherwise, the display or hinges might get damaged.

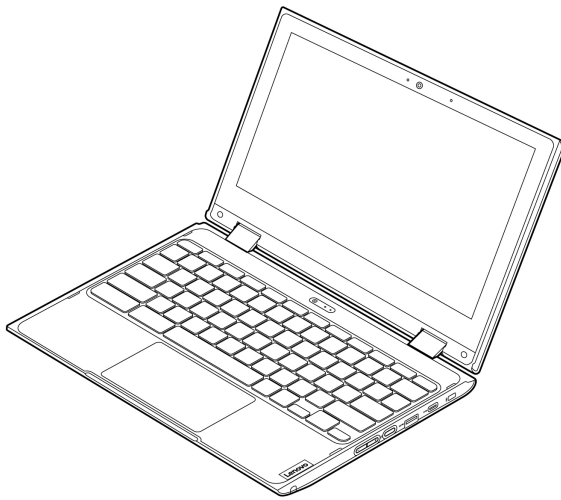

Laptop mode

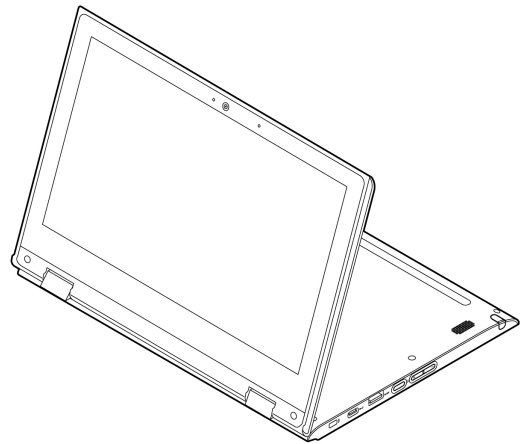

Stand mode

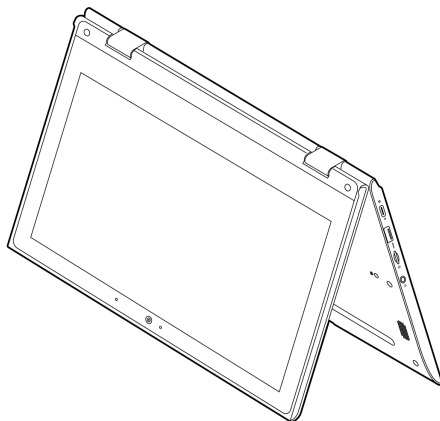

Tent mode

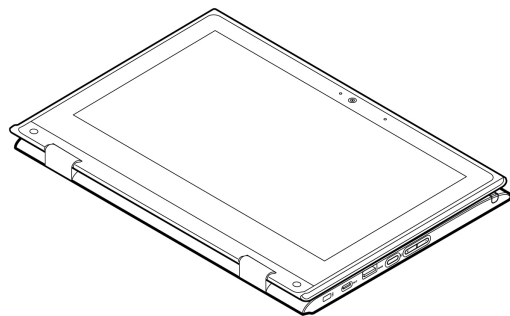

Tablet mode

Warning: When operating in the tablet mode with any external device connected, the upper case (keyboard's side) of the Chromebook may become hot. Avoid keeping your hands, lap, or any part of the body in contact with the upper case for over one minute.

Set the power plan

For ENERGY STAR® compliant Chromebooks, the following power plan takes effect when your Chromebooks have been idle for a specified duration:

Table 1. Default power plan (when plugged into ac power)

- | |
|--|
| <ul style="list-style-type: none">• Turn off the display: After seven minutes and 30 seconds• Put the Chromebook into sleep: After eight minutes and 30 seconds |
|--|

To reset the power plan to achieve the best balance between performance and power saving:

1. Click the setting icon in the system tray, and then click **Device → Power**.
2. Follow the on-screen instructions to change the settings as you prefer.

Chapter 3. CRU replacement

Customer Replaceable Units (CRUs) are parts that can be replaced by the customer. The Chromebooks contain the following types of CRUs:

- **Self-service CRUs:** Refer to parts that can be replaced easily by customer themselves or by trained service technicians at an additional cost.
- **Optional-service CRUs:** Refer to parts that can be replaced by customers with a greater skill level. Trained service technicians can also provide service to replace the parts under the type of warranty designated for the customer's machine.

If you intend on installing a CRU, Lenovo will ship the CRU to you. CRU information and replacement instructions are shipped with your product and are available from Lenovo at any time upon request. You might be required to return the defective part that is replaced by the CRU. When return is required: (1) return instructions, a prepaid shipping label, and a container will be included with the replacement CRU; and (2) you might be charged for the replacement CRU if Lenovo does not receive the defective CRU within thirty (30) days of your receipt of the replacement CRU. For full details, see the Lenovo Limited Warranty documentation at https://www.lenovo.com/warranty/llw_02.

What are CRUs

Refer to the following CRU list for your Chromebook.

Self-service CRUs

- ac power adapter
- Lenovo USI Pen*
- Pen dummy*
- Power cord

Optional-service CRUs

- Base cover assembly

* for selected models

Note: Replacement of any parts not listed above, including the built-in rechargeable battery, must be done by a Lenovo-authorized repair facility or technician. Go to <https://support.lenovo.com/partnerlocation> for more information.

Replace a CRU

Follow the replacement procedure to replace a CRU.

Pen dummy (for selected models)

Prerequisite

Before you start, read [Generic Safety and Compliance Notices](#) and print the following instructions.

For access, do the following:

1. Ensure that your Chromebook is off or in sleep mode. Disconnect the Chromebook from ac power and all connected cables.
2. Close the Chromebook display and turn the Chromebook over.

Removal procedure

Use a tool as shown to release the pen dummy **1** **2**, then remove it **3**.

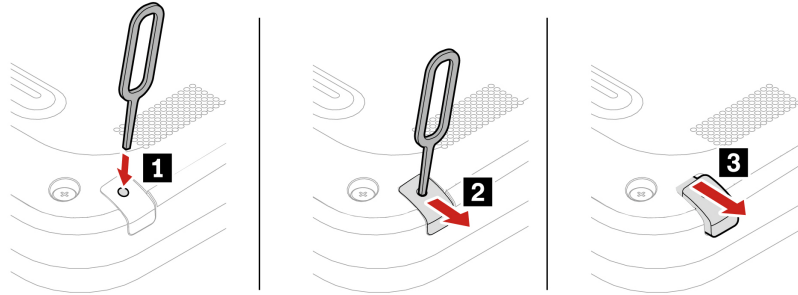

Base cover assembly

Prerequisite

Before you start, read [Generic Safety and Compliance Notices](#) and print the following instructions.

Note: Do not remove the base cover assembly when your Chromebook is connected to ac power.

For access, do the following:

1. Disable the built-in battery. Press  together with the power button for about five seconds, and at the same time detach the ac power adapter from the Chromebook.

Note: Power supply from the built-in battery will resume after you reconnect the Chromebook to the ac power adapter.

2. Close the Chromebook display and turn over the Chromebook.

Removal procedure

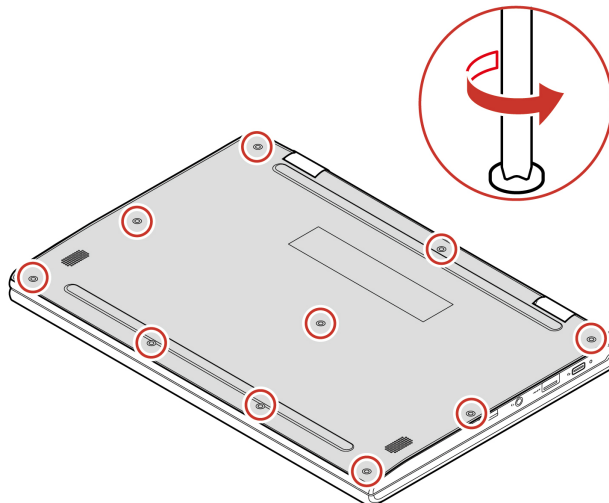

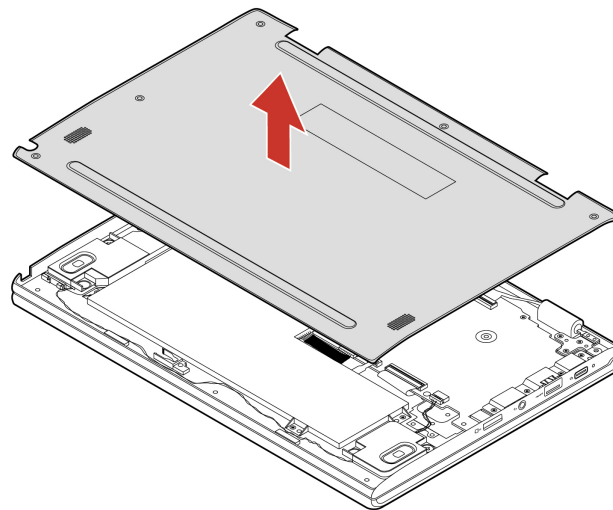
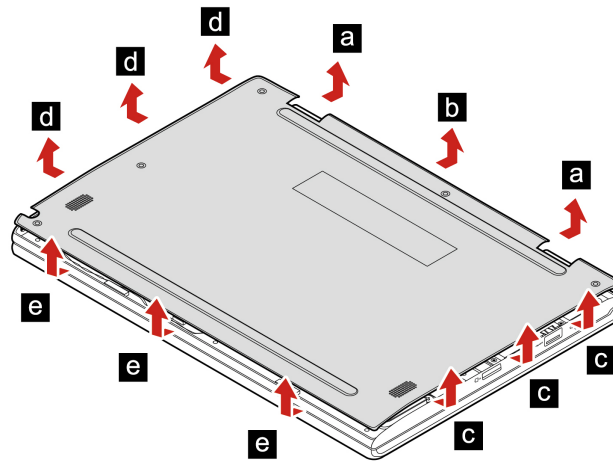

Installation procedure

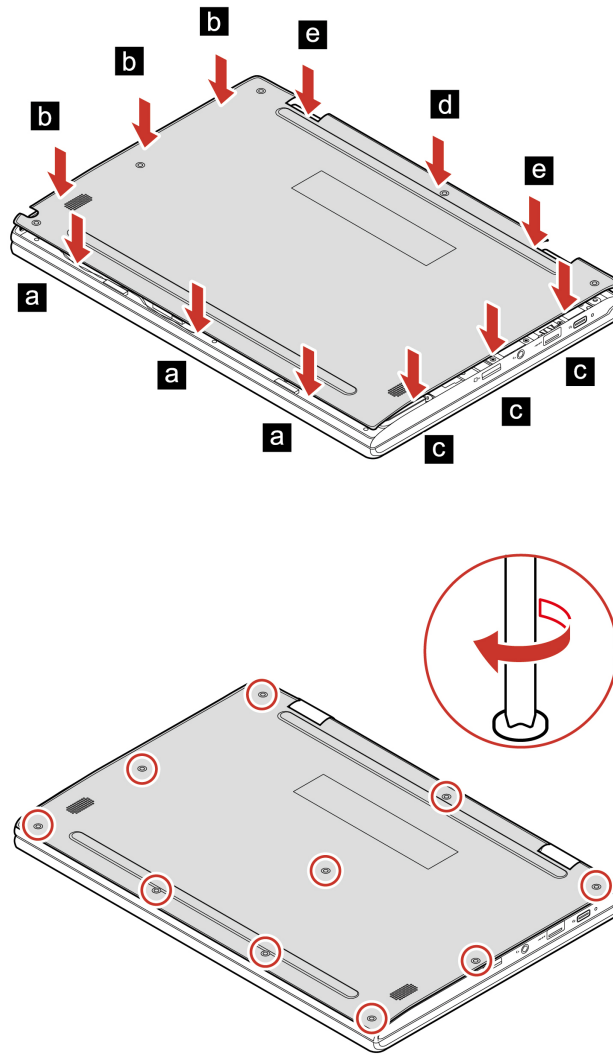

Troubleshooting

If the Chromebook does not start up after you reinstall the base cover assembly, disconnect the ac power adapter and then reconnect it to the Chromebook.

Chapter 4. Help and support

Frequently asked questions

What do I do if my Chromebook stops responding?

1. Press and hold the power button until the Chromebook turns off. Then, restart the Chromebook.
2. If step 1 does not work:
 - For models with an emergency reset hole: Insert a straightened paper clip into the emergency reset hole to cut off power supply temporarily. Then, restart the Chromebook with ac power connected.
 - For models without an emergency reset hole:
 - For models with the removable battery, remove the removable battery and disconnect all power sources. Then, reconnect to ac power and restart the Chromebook.
 - For models with the built-in battery, disconnect all power sources. Press and hold the power button for about seven seconds. Then, reconnect to ac power and restart the Chromebook.

What do I do if I spill liquid on the Chromebook?

1. Carefully unplug the ac power adapter and turn off the Chromebook immediately. The more quickly you stop the current from passing through the Chromebook the more likely you will reduce damage from short circuits.
Attention: Although you might lose some data or work by turning off the Chromebook immediately, leaving the Chromebook on might make your Chromebook unusable.
2. Do not try to drain out the liquid by turning over the Chromebook. If your Chromebook has keyboard drainage holes on the bottom, the liquid will be drained out through the holes.
3. Wait until you are certain that all the liquid is dry before turning on your Chromebook.

How do I disinfect my Chromebook?

1. Squeeze out excess liquid from wipe or disinfecting cloth before using. Recommended wipes are hydrogen peroxide wipes and alcohol based wipes. Do not use wipes containing sodium hypochlorite (bleach).
2. Gently wipe the Chromebook thoroughly, being careful to ensure no liquid drips into the Chromebook. Do not wipe on connector pins.
3. After disinfecting, follow the cleaning procedure from the wipe supplier to minimize chemical buildup of disinfectant residue.
4. Always allow the Chromebook to completely dry prior to any use.

For more information about cleaning and disinfecting, go to <https://support.lenovo.com/in/en/solutions/ht035676>.

How do I find accessibility information?

<https://www.lenovo.com/accessibility>

Lenovo Customer Support Center

If you have tried to correct the problem yourself and still need help, you can call Lenovo Customer Support Center.

Before you contact Lenovo

Record product information and problem details before you contact Lenovo.

Production information	Problem symptoms and details
<ul style="list-style-type: none">• Product name• Machine type and serial number	<ul style="list-style-type: none">• What is the problem? Is it continuous or intermittent?• Any error message or error code?• What operating system are you using? Which version?• Which software applications were running at the time of the problem?• Can the problem be reproduced? If so, how?

Note: The product name and serial number can usually be found on the bottom of the Chromebook, either printed on a label or etched on the cover.

Telephone numbers

For a list of the Lenovo Support phone numbers for your country or region, go to <https://pcsupport.lenovo.com/supportphonenumber> for the latest phone numbers.

Note: Phone numbers are subject to change without notice. If the number for your country or region is not provided, contact your Lenovo reseller or Lenovo marketing representative.

Services available during the warranty period

- Problem determination - Trained personnel are available to assist you with determining if you have a hardware problem and deciding what action is necessary to fix the problem.
- Lenovo hardware repair - If the problem is determined to be caused by Lenovo hardware under warranty, trained service personnel are available to provide the applicable level of service.
- Engineering change management - Occasionally, there might be changes that are required after a product has been sold. Lenovo or your reseller, if authorized by Lenovo, will make selected Engineering Changes (ECs) that apply to your hardware available.

Services not covered

- Replacement or use of parts not manufactured for or by Lenovo or nonwarranted parts
- Identification of software problem sources
- Configuration of UEFI BIOS as part of an installation or upgrade
- Changes, modifications, or upgrades to device drivers
- Installation and maintenance of network operating systems (NOS)
- Installation and maintenance of programs

For the terms and conditions of the Lenovo Limited Warranty that apply to your Lenovo hardware product, go to:

- https://www.lenovo.com/warranty/llw_02
- <https://pcsupport.lenovo.com/warrantylookup>

Get help from Google

After signing in to your Chromebook, start Get Help from the app Launcher. The Get Help app provides comprehensive instructions on using your Chromebook.

In addition, if you are interested in visiting the Chromebook Help Center and Community, go to <http://support.google.com/chromebook>.

Appendix A. Open source information

Your Chromebook may include software made publicly available by Google and other third parties, including software licensed under the General Public License and/or the Lesser General Public License (the “open source software”).

You may obtain a copy of the corresponding source code for any such open source software licensed under the General Public License and/or the Lesser General Public License (or any other license requiring us to make a written offer to provide corresponding source code to you) from Lenovo for a period of three years without charge except for the cost of media, shipping, and handling, upon written request to Lenovo. This offer is valid to anyone in receipt of this device. You may send your request in writing to the address below accompanied by a check or money order for \$5 to:

*Lenovo Legal Department
Attn: Open Source Team / Source Code Requests
8001 Development Dr.
Morrisville, NC 27560*

As part of your request, please include a “UNAME” and a “CHROME VERSION” of this device available by typing: “Chrome://system” in a Chrome Browser’s address bar. Be sure to provide a return address.

The open source software is distributed in hope it will be useful, but WITHOUT ANY WARRANTY; without even the implied warranty of MERCHANTABILITY or FITNESS FOR A PARTICULAR PURPOSE. See for example the GNU General Public License and/or the Lesser General Public License for more information.

To view additional information regarding licenses, acknowledgments and required copyright notices for the open source software used in your device, type: “Chrome://credits” in the Chrome Browser’s address bar.

This device may include certain pre-installed application programs or pre-configured links for downloading application programs published by parties other than Lenovo. Such third-party application programs may include open source software made publicly available by the respective publishers of those application programs. You may obtain the corresponding source code for any such open source software directly from the publisher of the applicable application program, to the extent permitted under the relevant open source software license agreement. Additional information is provided by the publisher of each application program within the menu structure of its application program.

Appendix B. Notices and trademarks

Notices

Lenovo may not offer the products, services, or features discussed in this document in all countries. Consult your local Lenovo representative for information on the products and services currently available in your area. Any reference to a Lenovo product, program, or service is not intended to state or imply that only that Lenovo product, program, or service may be used. Any functionally equivalent product, program, or service that does not infringe any Lenovo intellectual property right may be used instead. However, it is the user's responsibility to evaluate and verify the operation of any other product, program, or service.

Lenovo may have patents or pending patent programs covering subject matter described in this document. The furnishing of this document does not give you any license to these patents. You can send license inquiries, in writing, to:

*Lenovo (United States), Inc.
8001 Development Drive
Morrisville, NC 27560
U.S.A.
Attention: Lenovo Director of Licensing*

LENOVO PROVIDES THIS PUBLICATION "AS IS" WITHOUT WARRANTY OF ANY KIND, EITHER EXPRESS OR IMPLIED, INCLUDING, BUT NOT LIMITED TO, THE IMPLIED WARRANTIES OF NON-INFRINGEMENT, MERCHANTABILITY OR FITNESS FOR A PARTICULAR PURPOSE. Some jurisdictions do not allow disclaimer of express or implied warranties in certain transactions, therefore, this statement may not apply to you.

Changes are made periodically to the information herein; these changes will be incorporated in new editions of the publication. To provide better service, Lenovo reserves the right to improve and/or modify the products and software programs described in the manuals included with your Chromebook, and the content of the manual, at any time without additional notice.

The software interface and function and hardware configuration described in the manuals included with your Chromebook might not match exactly the actual configuration of the Chromebook that you purchase. For the configuration of the product, refer to the related contract (if any) or product packing list, or consult the distributor for the product sales. Lenovo may use or distribute any of the information you supply in any way it believes appropriate without incurring any obligation to you.

The products described in this document are not intended for use in implantation or other life support applications where malfunction may result in injury or death to persons. The information contained in this document does not affect or change Lenovo product specifications or warranties. Nothing in this document shall operate as an express or implied license or indemnity under the intellectual property rights of Lenovo or third parties. All information contained in this document was obtained in specific environments and is presented as an illustration. The result obtained in other operating environments may vary.

Lenovo may use or distribute any of the information you supply in any way it believes appropriate without incurring any obligation to you.

Any references in this publication to non-Lenovo Web sites are provided for convenience only and do not in any manner serve as an endorsement of those Web sites. The materials at those Web sites are not part of the materials for this Lenovo product, and use of those Web sites is at your own risk.

Any performance data contained herein was determined in a controlled environment. Therefore, the result obtained in other operating environments may vary significantly. Some measurements may have been made on development-level systems and there is no guarantee that these measurements will be the same on generally available systems. Furthermore, some measurements may have been estimated through extrapolation. Actual results may vary. Users of this document should verify the applicable data for their specific environment.

This document is copyrighted by Lenovo and is not covered by any open source license, including any Linux® agreement(s) which may accompany software included with this product. Lenovo may update this document at any time without notice.

For the latest information or any questions or comments, contact or visit the Lenovo Web site:

<https://pcsupport.lenovo.com>

Trademarks

LENOVO, LENOVO logo and IdeaPad are trademarks of Lenovo. ENERGY STAR is a registered trademark of the U.S. Environmental Protection Agency. Google, Chrome, and Chromebook are trademarks or registered trademarks of Google LLC. NanoSaver and Cleat are trademarks or registered trademarks of ACCO Brands. DisplayPort is a trademark of the Video Electronics Standards Association. USB Type-C is a registered trademark of USB Implementers Forum. Wi-Fi is a registered trademark of Wi-Fi Alliance. All other trademarks are the property of their respective owners.

Lenovo