

# IdeaPad Flex 5i Chromebook Plus (14", 7) and Lenovo Flex 5i Chromebook Plus 14 Hardware Maintenance Manual



**Lenovo**

**First Edition (April 2022)**

**© Copyright Lenovo 2022.**

---

# Contents

## About this manual . . . . . iii

## Chapter 1. Safety information . . . . . 1

General safety . . . . .	1
Electrical safety . . . . .	1
Safety inspection guide . . . . .	2
Handling devices that are sensitive to electrostatic discharge . . . . .	3
Grounding requirements . . . . .	4
Safety notices (multilingual translations) . . . . .	4

## Chapter 2. General checkout . . . . . 21

What to do first . . . . .	21
CRU list . . . . .	22

## Chapter 3. Identifying FRUs (CRUs) . . . . . 23

Locate FRUs and CRUs . . . . .	23
--------------------------------	----

## Chapter 4. Removing a FRU or CRU . . . . . 27

Service tools . . . . .	27
General guidelines . . . . .	27
Remove the lower case . . . . .	28
Remove the battery pack . . . . .	29
Remove the solid-state drive . . . . .	30
Remove the touch pad cable . . . . .	31
Remove the heat sink . . . . .	33

Remove the system fan . . . . .	34
Remove the I/O board cables . . . . .	36
Remove the I/O board . . . . .	37
Remove the Wi-Fi card . . . . .	38
Remove the MCU cable (for selected models) . . . . .	40
Remove the MCU board (for selected models) . . . . .	40
Remove the fingerprint reader board, bracket and cable (for selected models) . . . . .	41
Remove the system board . . . . .	43
Use a Golden Key U1 tool to flash-write key id information . . . . .	45
Remove the LCD unit . . . . .	45
Remove the upper case assembly . . . . .	46
Disassemble the LCD unit . . . . .	47
Remove the strip cover . . . . .	47
Remove the hinge rubbers . . . . .	48
Remove the LCD module . . . . .	49
Remove the hinges . . . . .	49
Remove the microphone rubbers . . . . .	50
Remove the camera board . . . . .	51
Remove the EDP cable . . . . .	52
Remove the HPS camera and the HPS board (for selected models) . . . . .	53
Remove the sensor board . . . . .	55
Remove the LCD cover . . . . .	56
Trademarks . . . . .	lvii



---

## About this manual

This manual contains service and reference information for the following Lenovo products.

<b>Machine</b>	<b>Machine type (MT)</b>
IP Flex 5 Chrome 14IAU7	83EK

### **Important:**

- This manual is intended only for trained service technicians who are familiar with Lenovo products.
- Before servicing a Lenovo product, be sure to read all the information under Chapter 1 “Safety information” on page 1.



---

## Chapter 1. Safety information

This chapter presents the following safety information that you need to be familiar with before you service a Lenovo notebook computer.

---

### General safety

Follow these rules to ensure general safety:

- Observe good housekeeping in the area of the machines during and after maintenance.
- When lifting any heavy object:
  1. Make sure that you can stand safely without slipping.
  2. Distribute the weight of the object equally between your feet.
  3. Use a slow lifting force. Never move suddenly or twist when you attempt to lift.
  4. Lift by standing or by pushing up with your leg muscles; this action removes the strain from the muscles in your back. *Do not attempt to lift any object that weighs more than 16 kg (35 lb) or that you think is too heavy for you.*
- Do not perform any action that causes hazards to the customer, or that makes the equipment unsafe.
- Before you start the machine, make sure that other service technicians and the customer's personnel are not in a hazardous position.
- Place removed covers and other parts in a safe place, away from all personnel, while you are servicing the machine.
- Keep your tool case away from walk areas so that other people will not trip over it.
- Do not wear loose clothing that can be trapped in the moving parts of a machine. Make sure that your sleeves are fastened or rolled up above your elbows. If your hair is long, fasten it.
- Insert the ends of your necktie or scarf inside clothing or fasten it with a non-conductive clip, about 8 centimeters (3 inches) from the end.
- Do not wear jewelry, chains, metal-frame eyeglasses, or metal fasteners for your clothing.

**Attention:** Metal objects are good electrical conductors.

- Wear safety glasses when you are hammering, drilling, soldering, cutting wire, attaching springs, using solvents, or working in any other conditions that might be hazardous to your eyes.
- After service, reinstall all safety shields, guards, labels, and ground wires. Replace any safety device that is worn or defective.
- Reinstall all covers correctly before returning the machine to the customer.
- Fan louvers on the machine help to prevent overheating of internal components. Do not obstruct fan louvers or cover them with labels or stickers.

---

### Electrical safety

Observe the following rules when working on electrical equipment.

**Important:** Use only approved tools and test equipment. Some hand tools have handles covered with a soft material that does not insulate you when working with live electrical currents. Many customers have, near their equipment, rubber floor mats that contain small conductive fibers to decrease electrostatic discharges. Do not use this type of mat to protect yourself from electrical shock.

- Find the room emergency power-off (EPO) switch, disconnecting switch, or electrical outlet. If an electrical accident occurs, you can then operate the switch or unplug the power cord quickly.
- Do not work alone under hazardous conditions or near equipment that has hazardous voltages.
- Disconnect all power before:
  - Performing a mechanical inspection
  - Working near power supplies

- Removing or installing main units
- Before you start to work on the machine, unplug the power cord. If you cannot unplug it, ask the customer to power-off the wall box that supplies power to the machine, and to lock the wall box in the off position.
- If you need to work on a machine that has *exposed* electrical circuits, observe the following precautions:
  - Ensure that another person, familiar with the power-off controls, is near you.

**Attention:** Another person must be there to switch off the power, if necessary.

- Use only one hand when working with powered-on electrical equipment; keep the other hand in your pocket or behind your back.

**Attention:** An electrical shock can occur only when there is a complete circuit. By observing the above rule, you may prevent a current from passing through your body.

- When using testers, set the controls correctly and use the approved probe leads and accessories for that tester.
- Stand on suitable rubber mats (obtained locally, if necessary) to insulate you from grounds such as metal floor strips and machine frames.

Observe the special safety precautions when you work with very high voltages; Instructions for these precautions are in the safety sections of maintenance information. Use extreme care when measuring high voltages.

- Regularly inspect and maintain your electrical hand tools for safe operational condition.
- Do not use worn or broken tools and testers.
- *Never assume* that power has been disconnected from a circuit. First, *check* that it has been powered off.
- Always look carefully for possible hazards in your work area. Examples of these hazards are moist floors, non-grounded power extension cables, power surges, and missing safety grounds.
- Do not touch live electrical circuits with the reflective surface of a plastic dental mirror. The surface is conductive; such touching can cause personal injury and machine damage.
- Do not service the following parts *with the power on* when they are removed from their normal operating places in a machine:
  - Power supply units
  - Pumps
  - Blowers and fans
  - Motor generators
  - Similar units as listed above

This practice ensures correct grounding of the units.

- If an electrical accident occurs:
  - Use caution; do not become a victim yourself.
  - Switch off power.
  - Send another person to get medical aid.

---

## Safety inspection guide

The purpose of this inspection guide is to assist you in identifying potentially unsafe conditions. As each machine was designed and built, required safety items were installed to protect users and service technicians from injury. This guide addresses only those items. You should use good judgment to identify potential safety hazards due to attachment of non-Lenovo features or options not covered by this inspection guide.

If any unsafe conditions are present, you must determine how serious the apparent hazard could be and whether you can continue without first correcting the problem.

Consider these conditions and the safety hazards they present:

- Electrical hazards, especially primary power (primary voltage on the frame can cause serious or fatal electrical shock)
- Explosive hazards, such as a damaged cathode ray tube (CRT) face or a bulging capacitor
- Mechanical hazards, such as loose or missing hardware



To determine whether there are any potentially unsafe conditions, use the following checklist at the beginning of every service task. Begin the checks with the power off, and the power cord disconnected.

Checklist:

1. Check exterior covers for damage (loose, broken, or sharp edges).
2. Power off the computer. Disconnect the power cord.
3. Check the power cord for:
  - a. A third-wire ground connector in good condition. Use a meter to measure third-wire ground continuity for 0.1 ohm or less between the external ground pin and the frame ground.
  - b. The power cord should be the authorized type specified for your computer. Go to: <http://www.lenovo.com/serviceparts-lookup>
  - c. Insulation must not be frayed or worn.
4. Check for cracked or bulging batteries.
5. Remove the cover.
6. Check for any obvious non-Lenovo alterations. Use good judgment as to the safety of any non-Lenovo alterations.
7. Check inside the unit for any obvious unsafe conditions, such as metal filings, contamination, water or other liquids, or signs of fire or smoke damage.
8. Check for worn, frayed, or pinched cables.
9. Check that the power-supply cover fasteners (screws or rivets) have not been removed or tampered with.

---

## Handling devices that are sensitive to electrostatic discharge

Any computer part containing transistors or integrated circuits (ICs) should be considered sensitive to electrostatic discharge (ESD). ESD damage can occur when there is a difference in charge between objects. Protect against ESD damage by equalizing the charge so that the machine, the part, the work mat, and the person handling the part are all at the same charge.

### Notes:

1. Use product-specific ESD procedures when they exceed the requirements noted here.
2. Make sure that the ESD protective devices you use have been certified (ISO 9000) as fully effective.

When handling ESD-sensitive parts:

- Keep the parts in protective packages until they are inserted into the product.
- Avoid contact with other people.
- Wear a grounded wrist strap against your skin to eliminate static on your body.
- Prevent the part from touching your clothing. Most clothing is insulative and retains a charge even when you are wearing a wrist strap.
- Use a grounded work mat to provide a static-free work surface. The mat is especially useful when handling ESD-sensitive devices.
- Select a grounding system, such as those listed below, to provide protection that meets the specific service requirement.

**Note:** The use of a grounding system to guard against ESD damage is desirable but not necessary.

- Attach the ESD ground clip to any frame ground, ground braid, or green-wire ground.
- When working on a double-insulated or battery-operated system, use an ESD common ground or reference point. You can use coax or connector-outside shells on these systems.
- Use the round ground prong of the ac plug on ac-operated computers.

---

## Grounding requirements

Electrical grounding of the computer is required for operator safety and correct system function. Proper grounding of the electrical outlet can be verified by a certified electrician.

---

## Safety notices (multilingual translations)

The safety notices in this section are provided in the following languages:

- English
- Arabic
- Brazilian Portuguese
- French
- German
- Hebrew
- Japanese
- Korean
- Spanish
- Traditional Chinese



### DANGER

Before the computer is powered on after FRU replacement, make sure that all screws, springs, and other small parts are in place and are not left loose inside the computer. Verify this by shaking the computer and listening for rattling sounds. Metallic parts or metal flakes can cause electrical short circuits.



### DANGER

Some standby batteries contain a small amount of nickel and cadmium. Do not disassemble a standby battery, recharge it, throw it into fire or water, or short-circuit it. Dispose of the battery as required by local ordinances or regulations. Use only the battery in the appropriate parts listing. Use of an incorrect battery can result in ignition or explosion of the battery.



### DANGER

The battery pack contains small amounts of nickel. Do not disassemble it, throw it into fire or water, or short-circuit it. Dispose of the battery pack as required by local ordinances or regulations. Use only the battery in the appropriate parts listing when replacing the battery pack. Use of an incorrect battery can result in ignition or explosion of the battery.



## DANGER

The lithium battery can cause a fire, an explosion, or a severe burn. Do not recharge it, remove its polarized connector, disassemble it, heat it above 100°C (212°F), incinerate it, or expose its cell contents to water. Dispose of the battery as required by local ordinances or regulations. Use only the battery in the appropriate parts listing. Use of an incorrect battery can result in ignition or explosion of the battery.



## DANGER

If the LCD breaks and the fluid from inside the LCD gets into your eyes or on your hands, immediately wash the affected areas with water for at least 15 minutes. Seek medical care if any symptoms from the fluid are present after washing.



## DANGER

To avoid shock, do not remove the plastic cover that protects the lower part of the inverter card.



## DANGER

Though the main batteries have low voltage, a short-circuited or grounded battery can produce enough current to burn personnel or combustible materials.



## DANGER

Unless hot swap is allowed for the FRU being replaced, do as follows before removing it: power off the computer, unplug all power cords from electrical outlets, remove the battery pack, and disconnect any interconnecting cables.



قبل إعادة تشغيل الحاسب بعد الانتهاء من استبدال FRU، تأكد من أنه قد تم إعادة كل من المسامير والسوست وكل الأجزاء الصغيرة الأخرى في أماكنهم ولم يتم فقدهم داخل الحاسب. ويمكن التحقق من ذلك عن طريق هز الحاسب والاستماع لأي صوت صاخب يصدر منه. قد تؤدي الأجزاء أو الرقائق المعدنية إلى حدوث دائرة قصر.



تحتوي بعض البطاريات الاحتياطية على كمية صغيرة من مادتي النيكل والكاديوم. لا تقم بفك أو إعادة شحن البطارية الاحتياطية ولا تقم أيضا بالقائها في النار أو الماء ولا تتسبب في أحداث دائرة قصر بها. قم بالتخلص من البطارية كما هو موضح في القوانين المحلية. استخدم نوع البطارية المحدد والذي يوصى باستخدامه. حيث أنه قد يؤدي استخدام نوع بطارية غير صحيح إلى اشتعالها أو انفجارها.



تحتوي حزمة البطارية على كمية صغيرة من مادة النيكل. لا تقم بفكها أو القاءها في النار أو الماء ولا تتسبب في أحداث دائرة قصر بها. تخلص من حزمة البطارية وفقا لما هو موضح في القوانين المحلية. قم، عند استبدال حزمة البطارية، باستخدام الأنواع المحددة فقط والتي يوصى باستخدامها. حيث أنه قد يؤدي استخدام نوع بطارية غير صحيح إلى اشتعالها أو انفجارها.



قد تتسبب بطارية الليثيوم في حدوث حريق أو انفجار أو حدوث حروق شديدة. لا تقم بإعادة شحن البطارية أو إزالة موصل الاستقطاب الخاص بها ولا تحاول أيضا فكها أو تسخينها لأكثر من ١٠٠ درجة مئوية (٢١٢١ فهرنهايت) أو حرقها أو تعريض محتويات الخانة الخاصة بها للماء. قم بالتخلص من البطارية وفقا لما هو موضح في القوانين المحلية. استخدم نوع البطارية المحدد والذي يوصى باستخدامه. حيث أنه قد يؤدي استخدام نوع بطارية غير صحيح إلى اشتعالها أو انفجارها.



إذا ما انكسرت شاشة LCD ولامس السائل الداخلي عينيك أو يديك، قم في الحال بغسلها بالماء لمدة لا تقل عن ١٥ دقيقة. إذا ما وجدت أي أعراض بعد الغسل اطلب عندئذ المساعدة الطبية.



خطر

لتجنب التعرض لأي صدمات، لا تقم بإزالة الغطاء البلاستيكي الذي يحمي الجزء الأسفل من بطاقة العاكس.



خطر

على الرغم من أن البطاريات الرئيسية يكون لها جهد منخفض، إلا أنه قد تقوم البطاريات التي حدث قصور بها أو التي تم توصيلها أرضيا بإصدار تيار يكفي لحدوث حروق للأفراد أو تعرض المواد القابلة للاشتعال للحريق.



خطر

ما لم يتم السماح بالتبديل الفوري لأي FRU الجاري استبداله بدون ضرورة اغلاق النظام، قم بتنفيذ ما يلي قبل ازالته، قم بإيقاف تشغيل الحاسب ونزع كل أسلاك الطاقة من المخارج الكهربائية وقم أيضا بإزالة حزمة البطارية ثم قم بفصل أي كابلات متصلة.



PERIGO

Antes de ligar o computador após a substituição da FRU, certifique-se de que todos os parafusos, molas e outras peças pequenas estejam no lugar e não estejam soltos dentro do computador. Verifique isso sacudindo o computador e procurando ouvir sons de peças soltas. Peças metálicas ou lascas de metal podem causar curto-circuito.



PERIGO

Algumas baterias reserva contêm uma pequena quantidade de níquel e cádmio. Não desmonte uma bateria reserva, recarregue-a, jogue-a no fogo ou na água, ou deixe-a entrar em curto-circuito. Descarte a bateria conforme requerido pelas leis ou regulamentos locais. Use somente a bateria nas partes listadas apropriadas. O uso de uma bateria incorreta pode resultar em combustão ou explosão da bateria.



PERIGO

O pacote da bateria contém uma pequena quantidade de níquel. Não o desmonte, jogue-o no fogo ou na água, ou deixe-o entrar em curto-circuito. Descarte o pacote da bateria conforme requerido pelas leis ou regulamentos locais. Use somente a bateria nas partes listadas apropriadas ao substituir o pacote da bateria. O uso de uma bateria incorreta pode resultar em combustão ou explosão da bateria.



#### PERIGO

A bateria de lítio pode causar incêndio, explosão ou graves queimaduras. Não a recarregue, remova seu conector polarizado, desmonte-a, aqueça-a acima de 100°C (212°F), incinere-a, ou exponha o conteúdo de sua célula à água. Descarte a bateria conforme requerido pelas leis ou regulamentos locais. Use somente a bateria nas partes listadas apropriadas. O uso de uma bateria incorreta pode resultar em combustão ou explosão da bateria.



#### PERIGO

Se o LCD quebrar e o fluido de dentro dele entrar em contato com seus olhos ou com suas mãos, lave as áreas afetadas imediatamente com água durante pelo menos 15 minutos. Procure cuidados médicos se algum sintoma causado pelo fluido surgir após a lavagem.



#### PERIGO

Para evitar choque elétrico, não remova a capa plástica que protege a parte inferior da placa inversora.



#### PERIGO

Embora as principais baterias possuam baixa voltagem, uma bateria em curto-circuito ou aterrada pode produzir corrente o bastante para queimar materiais de pessoal ou inflamáveis.



#### PERIGO

A menos que uma hot swap seja permitida para a FRU que está sendo substituída, faça o seguinte antes de removê-la: desligue o computador, desconecte todos os cabos de energia das tomadas, remova o pacote de baterias e desconecte quaisquer cabos de interconexão.



#### DANGER

Avant de remettre l'ordinateur sous tension après remplacement d'une unité en clientèle, vérifiez que tous les ressorts, vis et autres pièces sont bien en place et bien fixées. Pour ce faire, secouez l'unité et assurez-vous qu'aucun bruit suspect ne se produit. Des pièces métalliques ou des copeaux de métal pourraient causer un court-circuit.



#### DANGER

Certaines batteries de secours contiennent du nickel et du cadmium. Ne les démontez pas, ne les rechargez pas, ne les exposez ni au feu ni à l'eau. Ne les mettez pas en court-circuit. Pour les mettre au rebut, conformez-vous à la réglementation en vigueur. Lorsque vous remplacez la pile de sauvegarde ou celle de l'horloge temps réel, veillez à n'utiliser que les modèles cités dans la liste de pièces détachées adéquate. Une batterie ou une pile inappropriée risque de prendre feu ou d'exploser.



#### DANGER

La batterie contient du nickel. Ne la démontez pas, ne l'exposez ni au feu ni à l'eau. Ne la mettez pas en court-circuit. Pour la mettre au rebut, conformez-vous à la réglementation en vigueur. Lorsque vous remplacez la batterie, veillez à n'utiliser que les modèles cités dans la liste de pièces détachées adéquate. En effet, une batterie inappropriée risque de prendre feu ou d'exploser.



#### DANGER

La pile de sauvegarde contient du lithium. Elle présente des risques d'incendie, d'explosion ou de brûlures graves. Ne la rechargez pas, ne retirez pas son connecteur polarisé et ne la démontez pas. Ne l'exposez pas à une température supérieure à 100°C, ne la faites pas brûler et n'en exposez pas le contenu à l'eau. Mettez la pile au rebut conformément à la réglementation en vigueur. Une pile inappropriée risque de prendre feu ou d'exploser.



## DANGER

Si le panneau d'affichage à cristaux liquides se brise et que vous recevez dans les yeux ou sur les mains une partie du fluide, rincez-les abondamment pendant au moins quinze minutes. Consultez un médecin si des symptômes persistent après le lavage.



## DANGER

Afin d'éviter tout risque de choc électrique, ne retirez pas le cache en plastique protégeant la partie inférieure de la carte d'alimentation.



## DANGER

Bien que le voltage des batteries principales soit peu élevé, le court-circuit ou la mise à la masse d'une batterie peut produire suffisamment de courant pour brûler des matériaux combustibles ou causer des brûlures corporelles graves.



## DANGER

Si le remplacement à chaud n'est pas autorisé pour l'unité remplaçable sur site que vous remplacez, procédez comme suit avant de retirer l'unité : mettez l'ordinateur hors tension, débranchez tous les cordons d'alimentation des prises de courant, retirez le bloc de batterie et déconnectez tous les câbles d'interconnexion.



## VORSICHT

Bevor nach einem FRU-Austausch der Computer wieder angeschlossen wird, muß sichergestellt werden, daß keine Schrauben, Federn oder andere Kleinteile fehlen oder im Gehäuse vergessen wurden. Der Computer muß geschüttelt und auf Klappergeräusche geprüft werden. Metallteile oder-splitter können Kurzschlüsse erzeugen.





## VORSICHT

Die Bereitschaftsbatterie, die sich unter dem Diskettenlaufwerk befindet, kann geringe Mengen Nickel und Cadmium enthalten. Sie darf nur durch die Verkaufsstelle oder den IBM Kundendienst ausgetauscht werden. Sie darf nicht zerlegt, wiederaufgeladen, kurzgeschlossen, oder Feuer oder Wasser ausgesetzt werden. Die Batterie kann schwere Verbrennungen oder Verätzungen verursachen. Bei der Entsorgung die örtlichen Bestimmungen für Sondermüll beachten. Beim Ersetzen der Bereitschafts- oder Systembatterie nur Batterien des Typs verwenden, der in der Ersatzteilliste aufgeführt ist. Der Einsatz falscher Batterien kann zu Entzündung oder Explosion führen.



## VORSICHT

Akkus enthalten geringe Mengen von Nickel. Sie dürfen nicht zerlegt, wiederaufgeladen, kurzgeschlossen, oder Feuer oder Wasser ausgesetzt werden. Bei der Entsorgung die örtlichen Bestimmungen für Sondermüll beachten. Beim Ersetzen der Batterie nur Batterien des Typs verwenden, der in der Ersatzteilliste aufgeführt ist. Der Einsatz falscher Batterien kann zu Entzündung oder Explosion führen.



## VORSICHT

Die Systembatterie ist eine Lithiumbatterie. Sie kann sich entzünden, explodieren oder schwere Verbrennungen hervorrufen. Batterien dieses Typs dürfen nicht aufgeladen, zerlegt, über 100°C erhitzt oder verbrannt werden. Auch darf ihr Inhalt nicht mit Wasser in Verbindung gebracht oder der zur richtigen Polung angebrachte Verbindungsstecker entfernt werden. Bei der Entsorgung die örtlichen Bestimmungen für Sondermüll beachten. Beim Ersetzen der Batterie nur Batterien des Typs verwenden, der in der Ersatzteilliste aufgeführt ist. Der Einsatz falscher Batterien kann zu Entzündung oder Explosion führen.



## VORSICHT

Die Leuchtstoffröhre im LCD-Bildschirm enthält Quecksilber. Bei der Entsorgung die örtlichen Bestimmungen für Sondermüll beachten. Der LCD-Bildschirm besteht aus Glas und kann zerbrechen, wenn er unsachgemäß behandelt wird oder der Computer auf den Boden fällt. Wenn der Bildschirm beschädigt ist und die darin befindliche Flüssigkeit in Kontakt mit Haut und Augen gerät, sollten die betroffenen Stellen mindestens 15 Minuten mit Wasser abgespült und bei Beschwerden anschließend ein Arzt aufgesucht werden.



## VORSICHT

Aus Sicherheitsgründen die Kunststoffabdeckung, die den unteren Teil der Spannungswandlerplatine umgibt, nicht entfernen.



## VORSICHT

Obwohl Hauptbatterien eine niedrige Spannung haben, können sie doch bei Kurzschluß oder Erdung genug Strom abgeben, um brennbare Materialien zu entzünden oder Verletzungen bei Personen hervorzurufen.



## VORSICHT

Wenn ein Austausch der FRU bei laufendem Betrieb nicht erlaubt ist, gehen Sie beim Austausch der FRU wie folgt vor: Schalten Sie den Computer aus, ziehen Sie alle Netzkabel von den Netzsteckdosen ab, entfernen Sie den Akku und ziehen Sie alle miteinander verbundenen Kabel ab.



סכנה

לפני הפעלת המחשב לאחר החלפת FRU יש לוודא שכל תברגים, הקפיצים, וחלקים קטנים אחרים נמצאים במקומם ואינם חופשיים לזוז בתוך המחשב. כדי לוודא זאת, יש לטלטל את המחשב ולחקשיב לגילוי קולות שקשוק. חלקי או שבבי מתכת עלולים לגרום לקצרים חשמליים.



סכנה

סוללות המתנה מסוימות מכילות כמוט קטנה של ניקל וקדמיום. אין לפרק סוללות המתנה, לטעון אותה מחדש, להשליך אותה לאש או למים או לקצר אותה. יש לסלק את הסוללה כנדרש על ידי התקנות והחוקים המקומיים. יש להשתמש רק בסוללה המופיעה ברשימת החלקים המתאימה. שימוש בסוללה לא מתאימה עלול לגרום להצתה או התמוצות של הסוללה.



סכנה

מארו הסוללה מכיל כמוט קטנה של ניקל וקדמיום. אין לפרק את מארו הסוללה, להשליך אותו לאש או למים או לקצר אותו. יש לסלק את מארו הסוללה הסוללה כנדרש על ידי התקנות והחוקים המקומיים. יש להשתמש רק בסוללה המופיעה ברשימת החלקים המתאימה בזמן החלפת מארו הסוללה. שימוש בסוללה לא מתאימה עלול לגרום להצתה או התמוצות של הסוללה.



סכנה

סוללת חליתיום עלולה לגרום לשריפה, להתפוצצות או לכוויות קשות. אין לטעון אותה מחדש, לסלק את המחבר המקוטב שלה, לפרק אותה או לחמם אותה לטמפרטורה העולה על 100 מעלות צלזיוס. אין לשרוף את הסוללה ואין לחשוף את תוכן התא למים. יש לסלק את הסוללה כנדרש בתקנות ובחוקים המקומיים. יש להשתמש רק בסוללה המופיעה ברשימת החלקים המתאימים. שימוש בסוללה אחרת עלול לגרום לסכנת שריפה או התפוצצות.



סכנה

אם מסך חגביש הנוזלי (LCD) נשבר והנוזל מתוך המסך בא במגע עם עיניכם או ידיכם, שטפו את האזורים הנוגעים מיד במים במשך 15 דקות לפחות. פנו לקבלת עזרה רפואית אם תסמינים הנובעים מחמצע עם הנוזל נמשכים לאחר השטיפה.



סכנה

כדי למנוע התחשמלות, אין להסיר את מכסה הפלסטיק המגן על חלקו התחתון של הכרטיס ההפוך.



סכנה

אף שהסוללות הראשיות הן בעלות מתח נמוך, סוללה מקוצרת או מוארכת עלולה להפיק זרם מספיק לגרימת כוויות או להצתת חומרים דליקים.



סכנה

אלא אם כן מותרת 'החלפה חמה' של ה-FRU המוחלף, פעלו כדלהלן לפני הסרתו: כבו את המחשב, נתקו את כל כבלי החשמל מהשקעים, חוציאו את מארז הסוללות ונתקו את כל הכבלים המחוברים.



החלפה

FRU の交換後、ThinkPad の電源を入れる前に、ねじ、バネ、その他の小さな部品がすべて正しい位置にあり、また ThinkPad の内部で緩んでいないことを確認してください。  
これを確認するには、ThinkPad を振って、カチャカチャと音がしないか確かめます。金属部品や金属破片はショートの原因になることがあります。



החלפה

予備バッテリーの中には少量のニッケルとカドミウムが含まれているものがあります。したがって、予備バッテリーの分解、再充電、火または水の中への投棄、またはショートさせることは決して行わないでください。バッテリーを廃棄する場合は地方自治体の条例に従ってください。適切なパーツ・リストにあるバッテリーだけを使用してください。誤ったバッテリーを使用すると、バッテリーが発火したり、爆発したりすることがあります。



危険

バッテリー・パックには少量のニッケルが含まれています。バッテリー・パックを分解したり、火または水の中に投げ込んだり、ショートさせないでください。バッテリー・パックの廃棄にあたっては、地方自治体の条例または規則に従ってください。バッテリー・パックを交換するときは、適切なパーツ・リストにあるバッテリーだけを使用してください。誤ったバッテリーを使用すると、バッテリーが発火したり、爆発したりすることがあります。



危険

リチウム・バッテリーは、火災、爆発、または重症のやけどを引き起こすことがあります。バックアップ・バッテリーの充電、その極性コネクタの取り外し、バッテリー本体の分解、100 °C (212 °F) 以上への加熱、焼却、電池の中身を水に浸すことはしないでください。バッテリーを廃棄する場合は地方自治体の条例に従ってください。適切なパーツ・リストにあるバッテリーだけを使用してください。誤ったバッテリーを使用すると、バッテリーが発火したり、爆発したりすることがあります。



危険

LCD が破損し、LCD 中の液体が目に入ったり、手に触れたりした場合は、液体が触れた部分を少なくとも 15 分間洗い流してください。洗い流した後に、液体によって何らかの症状が現れた場合は、医師の治療を受けてください。



危険

感電を防ぐため、インバーター・カードの下部を保護しているプラスチック・カバーを外さないでください。



危険

メイン・バッテリーの電圧は低くても、ショートしたり、接地したバッテリーが、作業者にやけどを負わせたり、可燃物を燃やすだけの電流を発生させる場合があります。



## 危険

交換しようとしている FRU がホット・スワップに対応していない場合、それを取り外す前に、コンピューターの電源をオフにし、すべての電源コードをコンセントから抜き、バッテリー・パックを取り外して、相互接続しているケーブルをすべて切り離してください。



## 위험

FRU를 교체하고 나서 컴퓨터 전원을 켜기 전에 모든 나사, 스프링 및 기타 작은 부품들이 올바른 위치에 있는지, 컴퓨터 내부에 단단하게 연결되어 있는지 확인하십시오. 컴퓨터를 흔들어 달걀거리는 소리가 나지 않는지 확인하십시오. 금속 부품 또는 금속 조각은 누전을 일으킬 수 있습니다.



## 위험

일부 보조 배터리에는 소량의 니켈 및 카드뮴이 포함되어 있습니다. 보조 배터리를 분해하거나, 다시 충전하거나, 불 또는 물에 던지거나, 단락시키지 마십시오. 배터리 팩을 폐기할 때에는 해당 지역의 법률 규정을 따르십시오. 배터리 팩을 교체할 때에는 올바른 배터리만 사용하십시오. 올바르지 않은 배터리를 사용하면 배터리가 발화되거나 폭발할 수 있습니다.



## 위험

배터리 팩에는 소량의 니켈이 포함되어 있습니다. 배터리 팩을 분해하거나, 불 또는 물에 던지거나, 단락시키지 마십시오. 배터리 팩을 폐기할 때에는 해당 지역의 법률 규정을 따르십시오. 배터리 팩을 교체할 때에는 올바른 배터리만 사용하십시오. 올바르지 않은 배터리를 사용하면 배터리가 발화되거나 폭발할 수 있습니다.



## 위험

리튬 배터리는 화재, 폭발 또는 심각한 화상을 일으킬 수 있습니다. 리튬 배터리를 다시 충전하거나, 극성 커넥터를 제거하거나, 분해하거나, 100C(212F) 이상으로 가열하거나, 소각하거나, 전지 내용물을 물에 노출시키지 마십시오. 배터리를 폐기할 때에는 해당 지역의 법률 규정을 따르십시오. 올바른 배터리만 사용하십시오. 올바르지 않은 배터리를 사용하면 배터리가 발화되거나 폭발할 수 있습니다.



## 위험

LCD가 파손되어 LCD 내부의 액체가 눈에 들어가거나 손에 묻으면 즉시 깨끗한 물로 15분 이상 닦아 내십시오. 씻은 후에 조금이라도 이상을 느끼면 즉시 병원에 가서 의사의 진찰을 받아야 합니다.



위험

전기적 위험을 방지하려면 인버터 카드의 아래 부분을 보호하는 플라스틱 덮개를 제거하지 마십시오.



위험

기본 배터리의 전압은 낮지만, 단락되거나 접지된 배터리는 화상을 입히기에 충분한 전류와 가연성 물질을 발생시킬 수 있습니다.



위험

FRU 교체 시 Hot Swap이 지원되지 않는 경우, FRU를 제거하기 전에 컴퓨터의 전원을 끄고, 전기 콘센트에서 전원 코드를 분리하고, 배터리를 제거한 후, 연결된 모든 케이블을 분리하십시오.



PELIGRO

Antes de encender el sistema después de sustituir una FRU, compruebe que todos los tornillos, muelles y demás piezas pequeñas se encuentran en su sitio y no se encuentran sueltas dentro del sistema. Compruébelo agitando el sistema y escuchando los posibles ruidos que provocarían. Las piezas metálicas pueden causar cortocircuitos eléctricos.



PELIGRO

Algunas baterías de reserva contienen una pequeña cantidad de níquel y cadmio. No las desmonte, ni recargue, ni las eche al fuego o al agua ni las cortocircuite. Deséchelas tal como dispone la normativa local. Utilice sólo baterías que se encuentren en la lista de piezas. La utilización de una batería no apropiada puede provocar la ignición o explosión de la misma.



PELIGRO

Las baterías contienen pequeñas cantidades de níquel. No las desmonte, ni recargue, ni las eche al fuego o al agua ni las cortocircuite. Deséchelas tal como dispone la normativa local. Utilice sólo baterías que se encuentren en la lista de piezas al sustituir la batería. La utilización de una batería no apropiada puede provocar la ignición o explosión de la misma.



**PELIGRO**

La batería de repuesto es una batería de litio y puede provocar incendios, explosiones o quemaduras graves. No la recargue, ni quite el conector polarizado, ni la desmonte, ni caliente por encima de los 100°C (212°F), ni la incinere ni exponga el contenido de sus celdas al agua. Deséchela tal como dispone la normativa local.



**PELIGRO**

Si la LCD se rompe y el fluido de su interior entra en contacto con sus ojos o sus manos, lave inmediatamente las áreas afectadas con agua durante 15 minutos como mínimo. Obtenga atención médica si se presenta algún síntoma del fluido después de lavarse.



**PELIGRO**

Para evitar descargas, no quite la cubierta de plástico que rodea la parte baja de la tarjeta invertida.



**PELIGRO**

Aunque las baterías principales tienen un voltaje bajo, una batería cortocircuitada o con contacto a tierra puede producir la corriente suficiente como para quemar material combustible o provocar quemaduras en el personal.



**PELIGRO**

Salvo que se permita el intercambio en caliente para la unidad sustituible localmente, realice lo siguiente antes de extraerla: apague el sistema, desconecte todos los cables de alimentación de las tomas de alimentación eléctrica, extraiga la batería y desconecte los cables de interconexión.



### 危險

完成 FRU 更換之後，在開啟電腦的電源之前，請確定所有螺絲、彈簧及其他小零件都已歸位，沒有遺留在電腦內部。  
若要確認這一點，請搖晃電腦，聽聽看是否有卡嗒的聲響。  
金屬零件或儀錶的火花會造成電線短路。



### 危險

部分備用電池含有微量的鎳和鎘。請勿拆開備用電池、再充電、丟入火或水中，或使其形成短路。請按照當地法令或規定來棄置電池。  
僅限使用零件清單中的電池。使用不適當的電池會導致電池起火或爆炸。



### 危險

電池套件含有微量的鎳。請勿拆開電池套件、丟入火或水中，或使其形成短路。請按照當地法令或規定來棄置電池套件。  
更換電池套件時，僅限使用零件清單中的電池。使用不適當的電池會導致電池起火或爆炸。



### 危險

鋰電池會導致起火、爆炸或嚴重燒傷。請勿再充電、拔除其電極接頭、拆開、加熱超過 100°C (212°F)、焚燒，或讓電池組成物浸到水。請按照當地法令或規定來棄置電池。  
僅限使用零件清單中的電池。使用不適當的電池會導致電池起火或爆炸。



### 危險

如果 LCD 破裂導致 LCD 流出的液體沾到您的眼睛或手，請立即以清水沖洗沾染部位至少 15 分鐘。如果在清洗後出現該液體所造成的任何症狀，請就醫治療。



### 危險

為避免電擊，請勿拆下轉換卡下面的塑膠護蓋。





危險

雖然主電池的電壓很低，但短路或接地電池所產生的電流，仍足以使人燒傷或使可燃物質起火。



危險

除非 FRU 允許以熱抽換來替換，否則請依下列方式將其移除：將電腦關機，拔除插座上所有電源線，移除電池包，並拔開任何交互連接的線材。



---

## Chapter 2. General checkout

This chapter contains the following topics:

Before you go to the checkout instructions, ensure that you read the following important notes.

### Important notes:

- **Only certified trained personnel should service the computer.**
- **Before replacing any FRU, read the entire page on removing and replacing FRUs.**
- **Be extremely careful during such write operations as copying, saving, or formatting.** Drives in the computer that you are servicing sequence might have been altered. If you select an incorrect drive, data or programs might be overwritten.
- **Replace a FRU only with another FRU of the correct model.** When you replace a FRU, make sure that the model of the machine and the FRU part number are correct by referring to the FRU parts list.
- **A FRU should not be replaced because of a single, unreproducible failure.** Single failures can occur for a variety of reasons that have nothing to do with a hardware defect, such as cosmic radiation, electrostatic discharge, or software errors. Consider replacing a FRU only when a problem recurs. If you suspect that a FRU is defective, clear the error log and run the test again. If the error does not recur, do not replace the FRU.
- **Be careful not to replace a nondefective FRU.**

---

## What to do first

When you return a FRU, you must include the following information in the parts exchange form or parts return form that you attach to it:

1. Name and phone number of service technician
2. Date of service
3. Date on which the machine failed
4. Date of purchase
5. Failure symptoms, error codes appearing on the display, and beep symptoms
6. Procedure index and page number in which the failing FRU was detected
7. Failing FRU name and part number
8. Machine type, model number, and serial number
9. Customer's name and address

**Note:** During the warranty period, the customer may be responsible for repair costs if the computer damage was caused by misuse, accident, modification, unsuitable physical or operating environment, or improper maintenance by the customer. Following is a list of some common items that are not covered under warranty and some symptoms that might indicate that the system was subjected to stress beyond normal use.

Before checking problems with the computer, determine whether the damage is covered under the warranty by referring to the following list:

### The following are not covered under warranty:

- LCD panel cracked from the application of excessive force or from being dropped
- Scratched (cosmetic) parts
- Distortion, deformation, or discoloration of the cosmetic parts
- Plastic parts, latches, pins, or connectors that have been cracked or broken by excessive force
- Damage caused by liquid spilled into the system

- Damage caused by the improper insertion of a personal-computer card (PC card) or the installation of an incompatible card
- Improper disc insertion or use of an external optical drive
- Fuses blown by attachment of a non-supported device
- Forgotten computer password (making the computer unusable)
- Sticky keys caused by spilling a liquid onto the keyboard
- Use of an incorrect ac power adapter on laptop products

**The following symptoms might indicate damage caused by non-warranted activities:**

- Missing parts might be a symptom of unauthorized service or modification.
- Check for obvious damage to a hard disk drive. If the spindle of a hard disk drive becomes noisy, the hard disk drive might have been dropped or subject to excessive force.

---

## CRU list

*Table 1. Model: IP Flex 5 Chrome 14IAU7 (Machine type: 83EK)*

CRU	Type
ac power adapter	self-service
power cord	self-service

## Chapter 3. Identifying FRUs (CRUs)

### Locate FRUs and CRUs

The exploded illustrations help Lenovo service technicians identify FRUs or CRUs that they may need to replace when servicing a customer's computer.

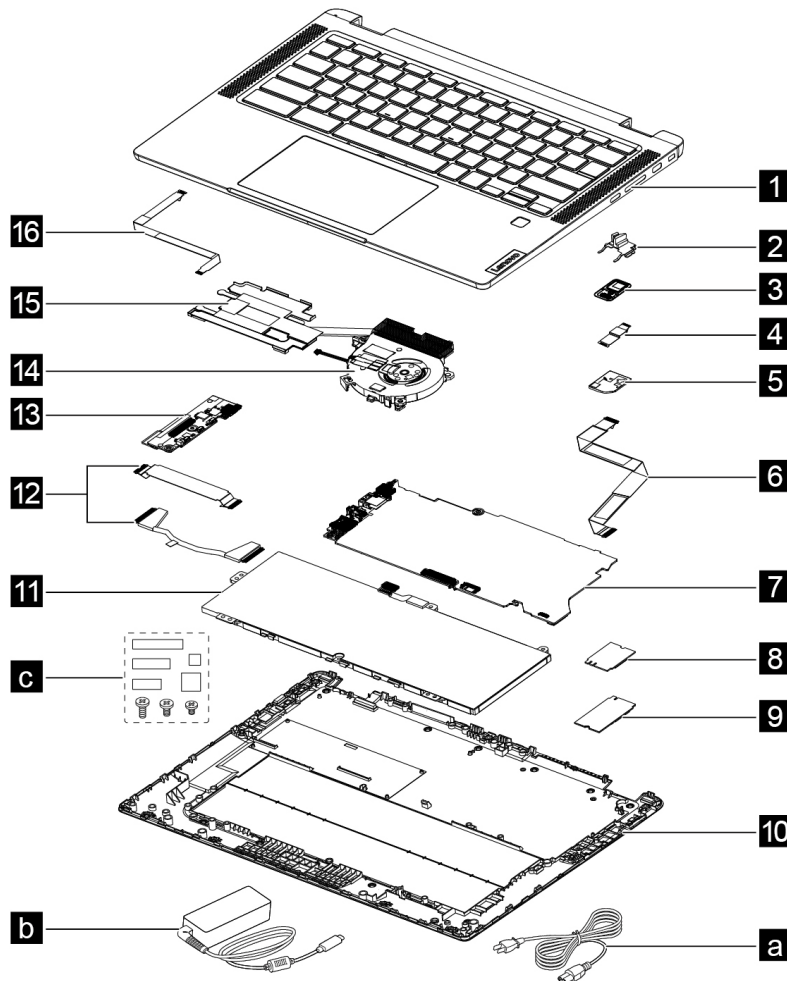

Figure 1. Exploded view

Table 2. FRU (CRU) categories

No.	FRU (CRU) category
1	Upper case assembly
2	Fingerprint reader bracket with rubber*
3	Fingerprint reader board*
4	Fingerprint reader cable*

Table 2. FRU (CRU) categories (continued)

<b>5</b>	MCU board*
<b>6</b>	MCU cable*
<b>7</b>	System board
<b>8</b>	Wi-Fi card
<b>9</b>	Solid-state drive
<b>10</b>	Lower case
<b>11</b>	Battery pack
<b>12</b>	I/O board cables
<b>13</b>	I/O board
<b>14</b>	System fan
<b>15</b>	Heat sink
<b>16</b>	Touch pad cable
<b>a</b>	Power cord
<b>b</b>	ac power adapter
<b>c</b>	Screw kit

\* for selected models

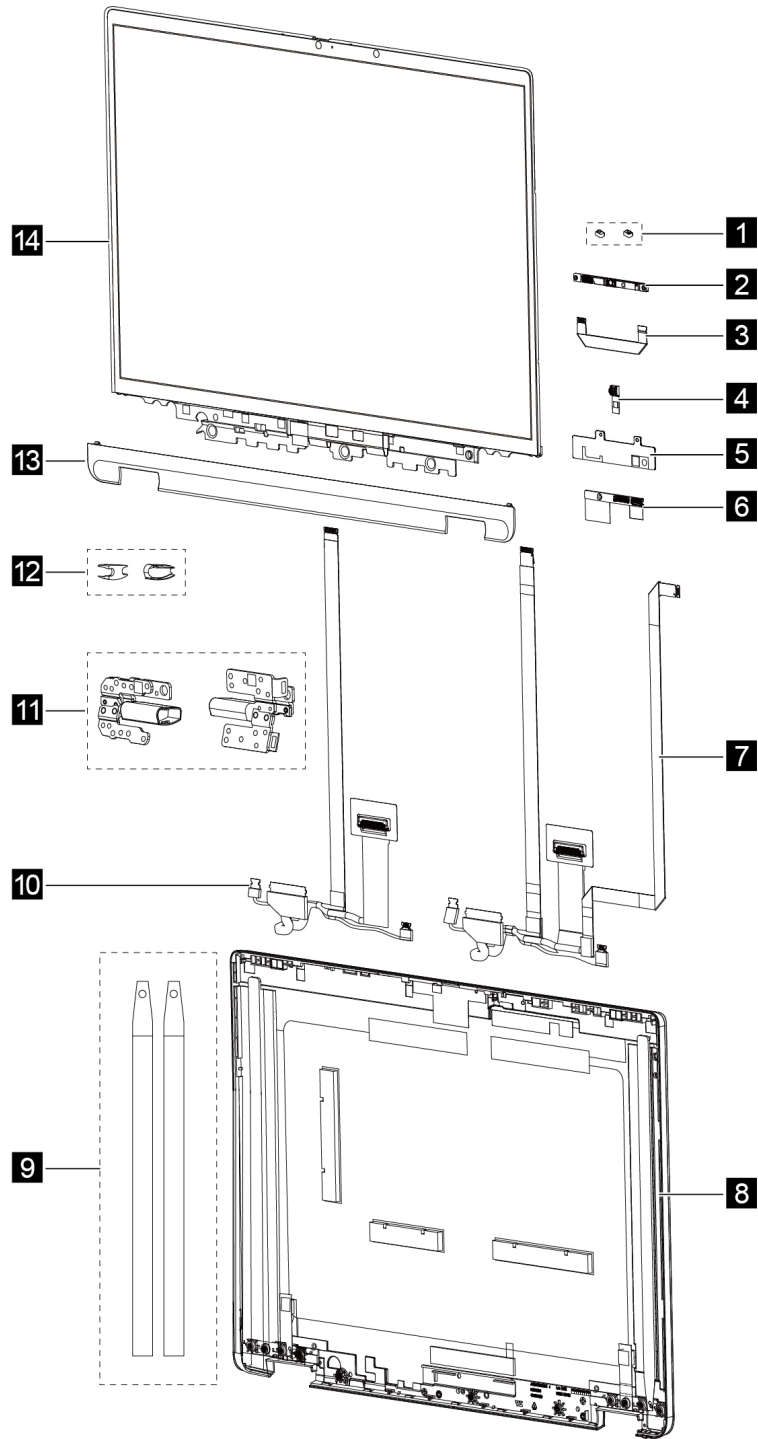

Figure 2. Exploded view of the LCD unit

Table 3. FRU (CRU) categories

No.	FRU (CRU) category
1	Microphone rubbers
2	Camera board

Table 3. FRU (CRU) categories (continued)

<b>3</b>	Camera board cable
<b>4</b>	HPS camera*
<b>5</b>	HPS board*
<b>6</b>	Sensor board
<b>7</b>	EDP cable (for models without HPS)
<b>8</b>	LCD cover
<b>9</b>	Removable tapes
<b>10</b>	EDP cable (for models with HPS)
<b>11</b>	Hinges
<b>12</b>	Hinge rubbers
<b>13</b>	Strip cover
<b>14</b>	LCD panel

\* for selected models



---

## Chapter 4. Removing a FRU or CRU

---

### Service tools

The following table lists tools for servicing Lenovo computers. Tools with a cross mark are needed for servicing the product models as described by this publication. Prepare them before you service the product.

Table 4. Service tools

Service tool and consumable	Model applicability
Screw driver (Phillips head) (PH1/PH01)	X
Screw driver (Torx head) (T5)	X
Screw driver (Torx head) (T30)	
Pry tool 1	X
Tweezers (conductive)	X
Tweezers (isolated)	
Suction cup	
Hexagonal socket	
Silicone grease	X
Acetate tape	X
Polyamide tape	
Mylar tape	X
Electrical tape	
Double-sided tape	
Conductive tape	X
Eraser	
Heat gun	
Brown brush	

#### Notes:

- T30 screw drivers are used to service the new Intel Xeon CPUs.
- Hexagonal sockets are used to remove antenna connectors.
- Silicone grease is applied to the CPU and heatsink surfaces to eliminate air gaps.

---

### General guidelines

When removing or replacing a FRU, ensure that you observe the following general guidelines:

1. Do not try to service any computer unless you have been trained and certified. An untrained person runs the risk of damaging parts.
2. Begin by removing any FRUs that have to be removed before replacing the failing FRU. Any such FRUs are listed at the beginning of each FRU replacement procedure. Remove them in the order in which they are listed.

3. Follow the correct sequence in the steps for removing a FRU, as shown in the illustrations by the numbers in square callouts.
4. When removing a FRU, move it in the direction as shown by the arrow in the illustration.
5. To install a new FRU in place, perform the removal procedure in reverse and follow any notes that pertain to replacement.
6. When replacing a FRU, carefully retain and reuse all screws.
7. When replacing the base cover, reapply all labels that come with the replacement base cover. If some original labels are not included with the replacement base cover, peel them off from the original base cover and paste them on the replacement base cover.



**Before removing any FRU or CRU, shut down the computer and unplug all power cords from electrical outlets.**

**Attention:** After replacing a FRU, do not turn on the computer until you have ensured that all screws, springs, and other small parts are in place and none are loose inside the computer. Verify this by shaking the computer gently and listening for rattling sounds. Metallic parts or metal flakes can cause electrical short circuits.

**Attention:** The system board is sensitive to and can be damaged by ESD. Before touching it, establish personal grounding by touching a ground point with one hand or by using an ESD strap (P/N 6405959).

## Remove the lower case

Make sure the computer has been shut down before servicing the computer.

- Step 1. Place the computer upside down on a flat surface.
- Step 2. Remove nine screws.

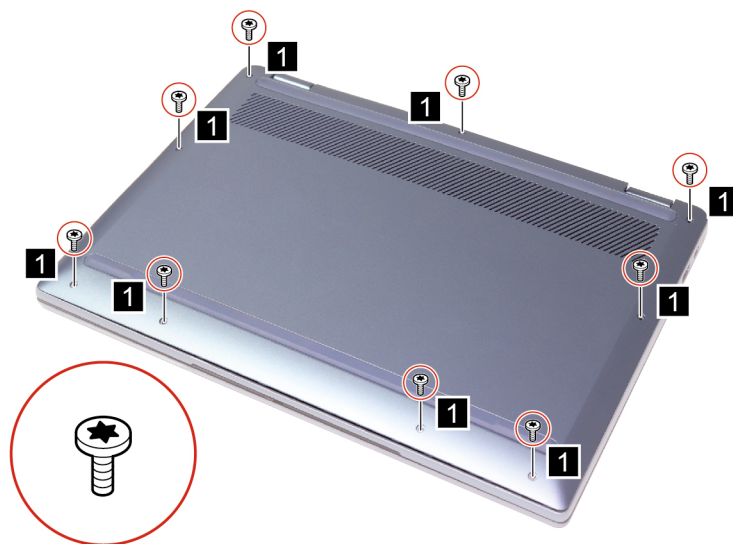

Figure 3. Remove nine screws

Screw specifications	Number of screws
M2 x L6	9

Step 3. Pry up the latches and then remove the lower case.

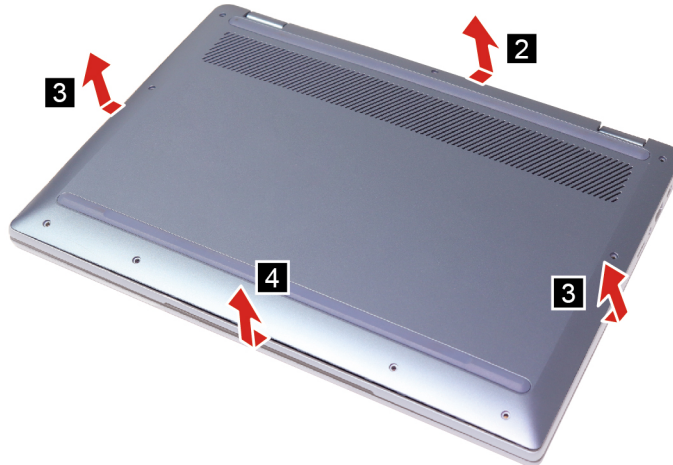

Figure 4. Pry up the latches and remove the lower case

Go to <https://support.lenovo.com/partslookup> to look up the Lenovo part numbers of the following replacement part:

Lower case

---

## Remove the battery pack

Make sure the following FRUs (or CRUs) have been removed.

“Remove the lower case” on page 28

Step 1. Disconnect the cable from the system board.

**Attention:** Use your fingernail to pull the connector to unplug it. Do not pull the cable.

Step 2. Remove five screws and then remove the battery pack.

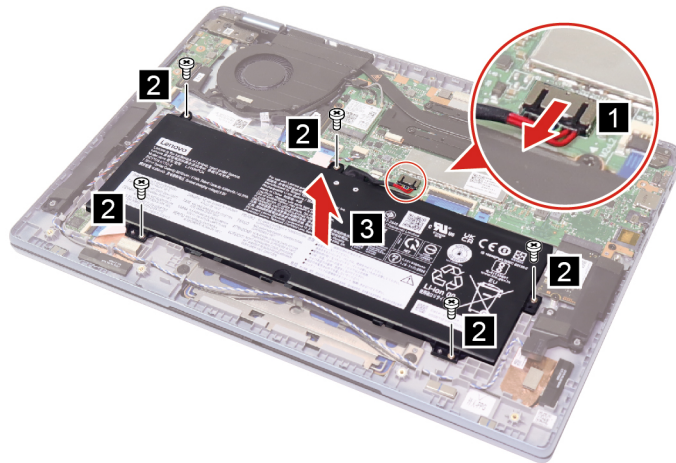

Figure 5. Remove the battery pack

Screw specifications	Number of screws
M2 x L3	5

Go to <https://support.lenovo.com/partslookup> to look up the Lenovo part numbers of the following replacement part:

Battery pack

---

## Remove the solid-state drive

Make sure the following FRUs (or CRUs) have been removed.

“Remove the lower case” on page 28

Step 1. Disconnect the battery pack cable from the system board. Then, remove one screw.

**Attention:** Use your fingernail to pull the connector to unplug it. Do not pull the cable.

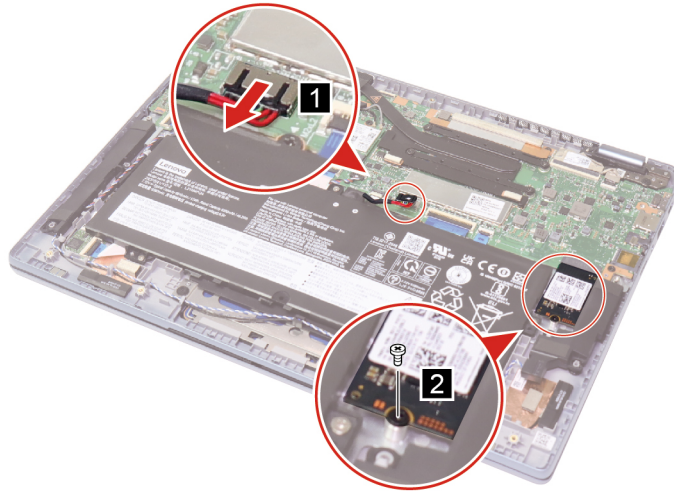

Figure 6. Disconnect the battery pack cable and remove one screw

Screw specifications	Number of screws
M2 x L2	1

Step 2. Remove the solid-state drive by pulling it away from the slot.

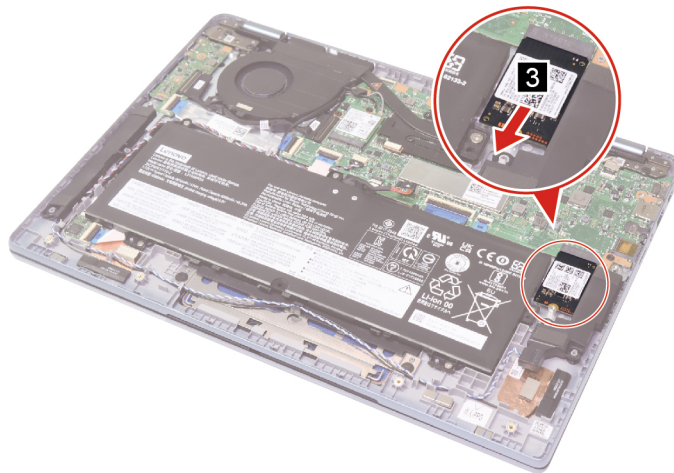

Figure 7. Remove the solid-state drive

Go to <https://support.lenovo.com/partslookup> to look up the Lenovo part numbers of the following replacement part:

Solid-state drive

---

## Remove the touch pad cable

Make sure the following FRUs (or CRUs) have been removed.

“Remove the lower case” on page 28

“Remove the battery pack” on page 29

Step 1. Peel back the rubber on the touch pad.

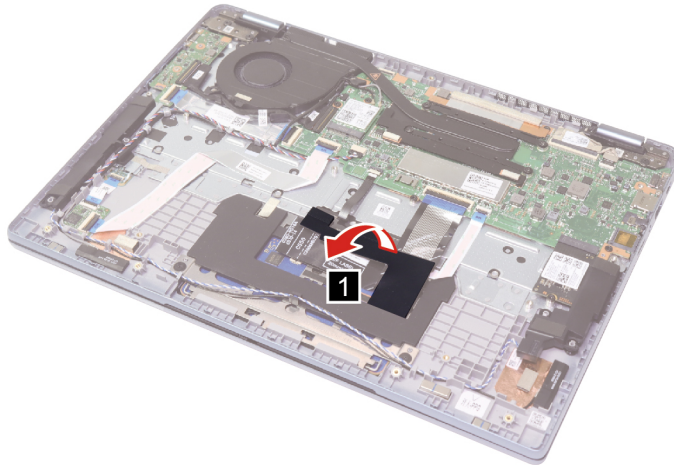

*Figure 8. Peel back the rubber*

Step 2. Peel back the keyboard cable.

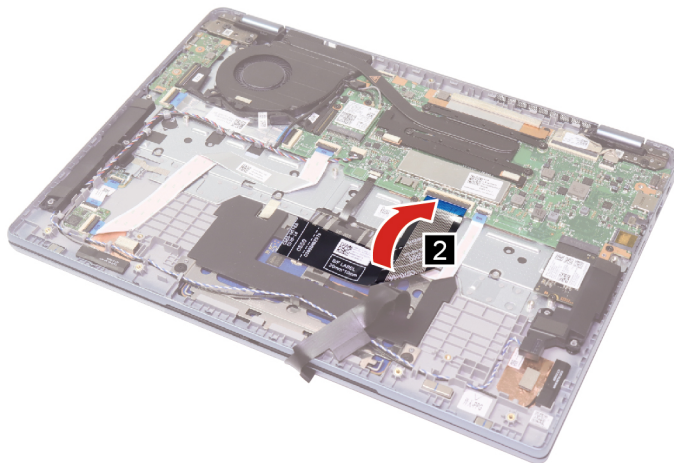

*Figure 9. Peel back the keyboard cable*

Step 3. Disconnect the touch pad cable connectors from the system board and the touch pad. Then, remove the touch pad cable.

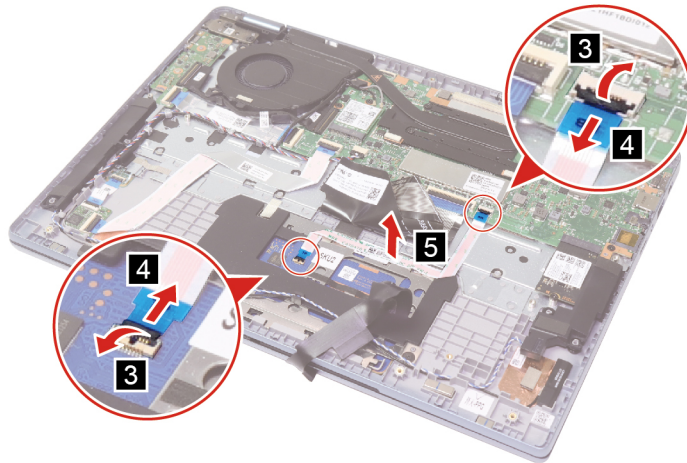

Figure 10. Disconnect and remove the touch pad cable

Go to <https://support.lenovo.com/partslookup> to look up the Lenovo part numbers of the following replacement part:

Touch pad cable

---

## Remove the heat sink

Make sure the following FRUs (or CRUs) have been removed.

“Remove the lower case” on page 28

Step 1. Disconnect the battery pack cable from the system board. Then, peel off the tape.

**Attention:** Use your fingernail to pull the connector to unplug it. Do not pull the cable.

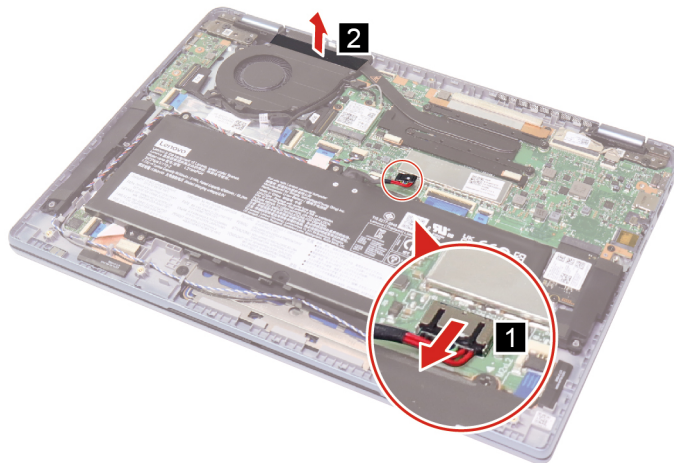

Figure 11. Disconnect the battery pack cable and peel off the tape

Step 2. Loosen four screws and remove the heat sink.

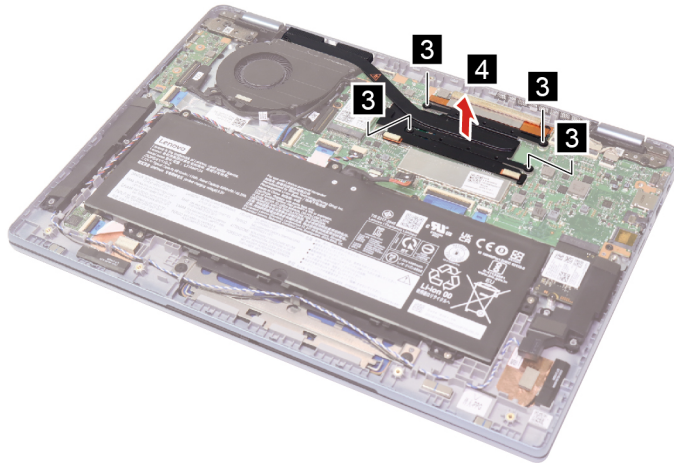

Figure 12. Loosen four screws and remove the heat sink

Go to <https://support.lenovo.com/partslookup> to look up the Lenovo part numbers of the following replacement part:

Heat sink

---

## Remove the system fan

Make sure the following FRUs (or CRUs) have been removed.

“Remove the lower case” on page 28

Step 1. Disconnect the battery pack cable from the system board. Then, peel off the tape.

**Attention:** Use your fingernail to pull the connector to unplug it. Do not pull the cable.



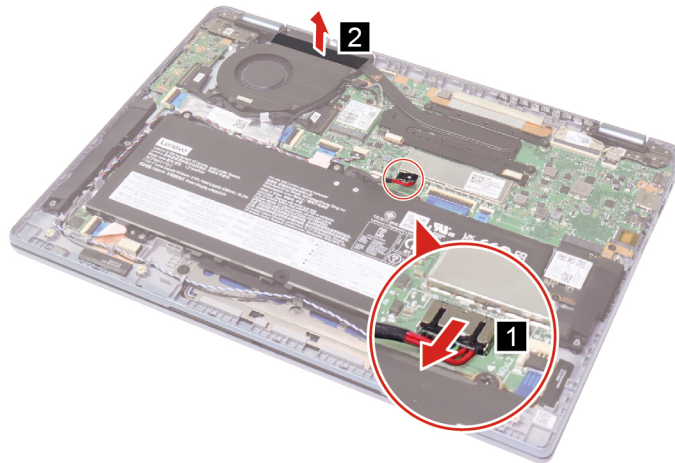

Figure 13. Disconnect the battery pack cable and peel off the tape

Step 2. Disconnect the antenna cables from the Wi-Fi card. Disconnect the system fan cable and I/O board cable from the system board. Then, remove all the cables from the fan hooks.

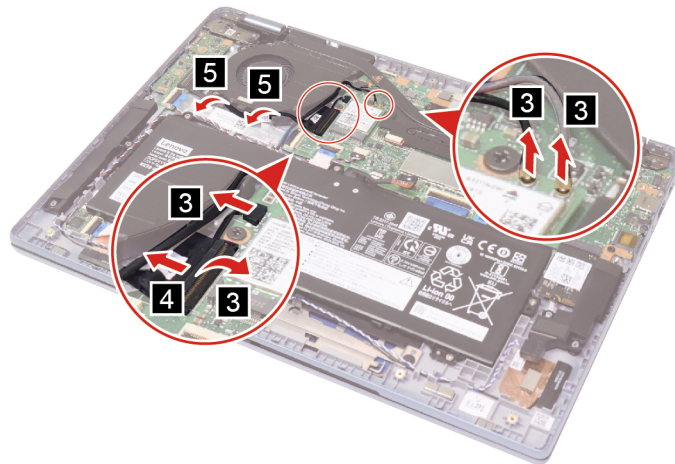

Figure 14. Disconnect cables

Step 3. Remove three screws. Then, remove the system fan.

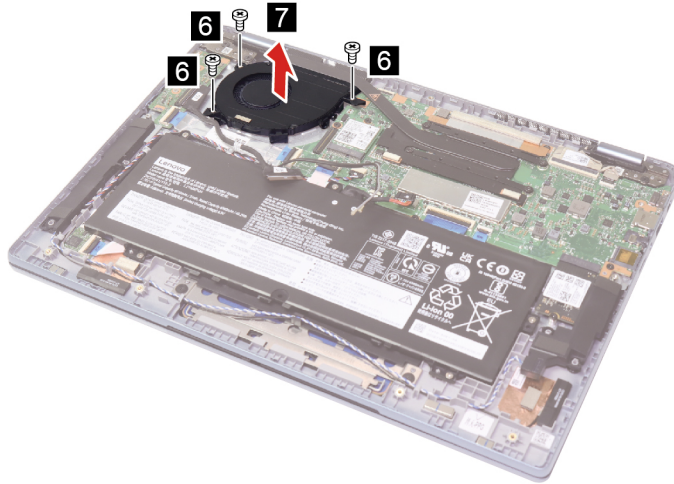

Figure 15. Remove three screws and the system fan

Screw specifications	Number of screws
M2 x L3	3

Go to <https://support.lenovo.com/partslookup> to look up the Lenovo part numbers of the following replacement part:

System fan

---

## Remove the I/O board cables

Make sure the following FRUs (or CRUs) have been removed.

“Remove the lower case” on page 28

Step 1. Disconnect the battery pack cable from the system board. Disconnect the antenna cables from the Wi-Fi card. Then, remove the antenna cables.

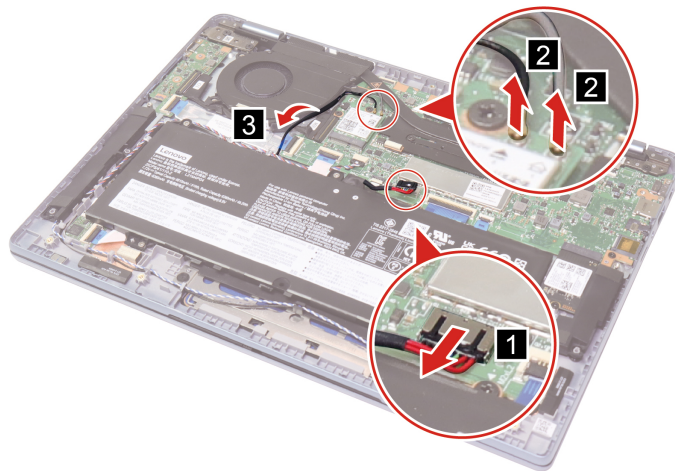

Figure 16. Disconnect the battery pack cable and the antenna cables

Step 2. Disconnect and remove the I/O board cables.

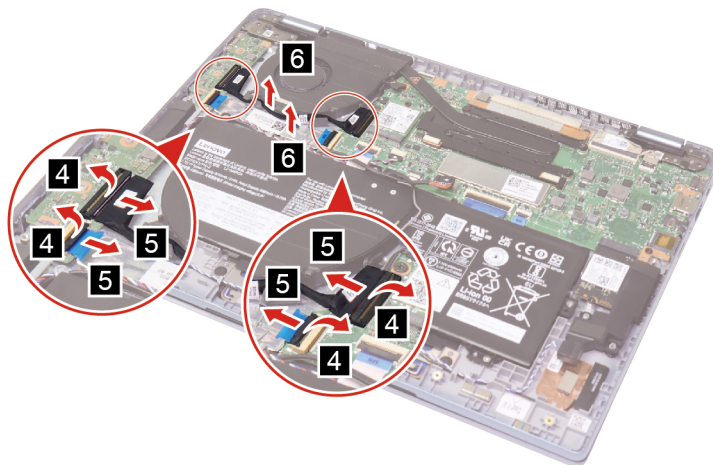

Figure 17. Disconnect and remove the I/O board cables

Go to <https://support.lenovo.com/partslookup> to look up the Lenovo part numbers of the following replacement parts:

I/O board cables

---

## Remove the I/O board

Make sure the following FRUs (or CRUs) have been removed.

“Remove the lower case” on page 28

Step 1. Disconnect the battery pack cable from the system board. Then, disconnect the I/O board cables from the I/O board.

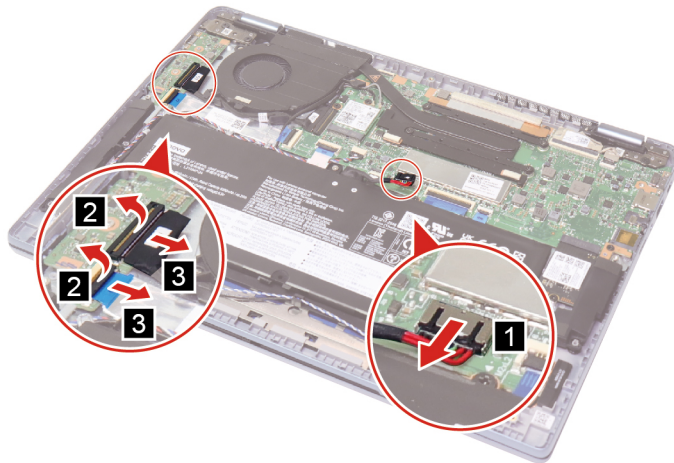

Figure 18. Disconnect the battery pack cable and the I/O board cables

Step 2. Remove three screws. Then, remove the I/O board.

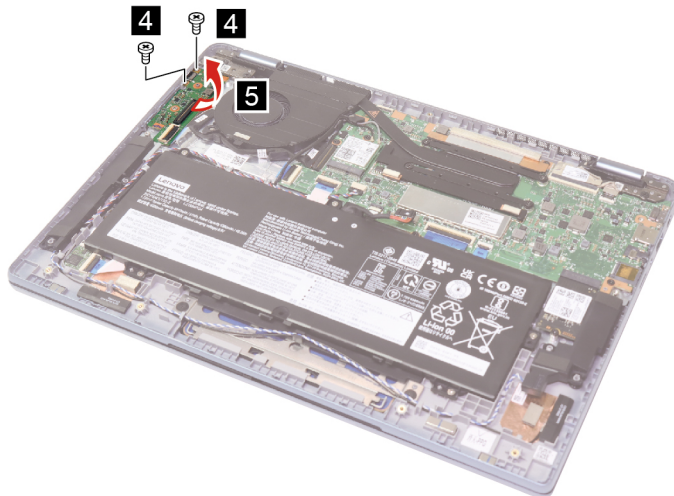

Figure 19. Remove three screws and the I/O board

Screw specifications	Number of screws
M2 x L3	2

Go to <https://support.lenovo.com/partslookup> to look up the Lenovo part numbers of the following replacement part:

I/O board

## Remove the Wi-Fi card

Make sure the following FRUs (or CRUs) have been removed.

“Remove the lower case” on page 28

Step 1. Disconnect the battery pack cable from the system board. Remove one screw, and then remove the antenna cables from the Wi-Fi card.

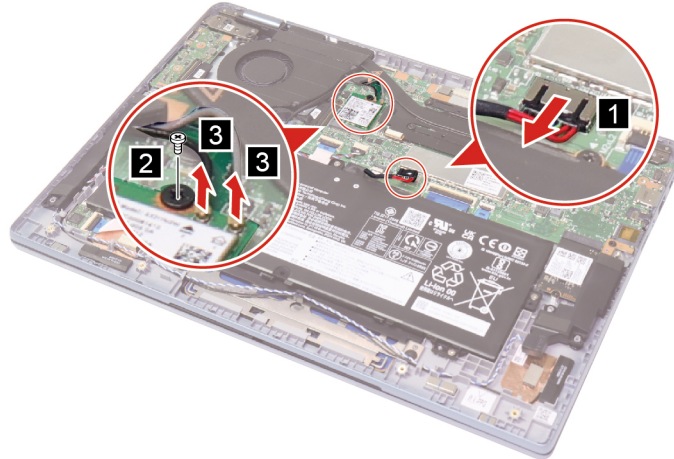

Figure 20. Disconnect cables and remove one screw

Screw specifications	Number of screws
M2 x L2	1

Step 2. Remove the Wi-Fi card.

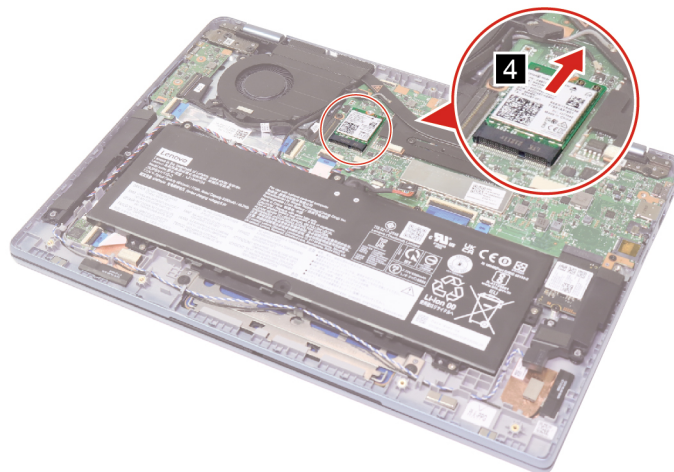

Figure 21. Remove the Wi-Fi card

Go to <https://support.lenovo.com/partslookup> to look up the Lenovo part numbers of the following replacement part:

Wi-Fi card

---

## Remove the MCU cable (for selected models)

Make sure the following FRUs (or CRUs) have been removed.

“Remove the lower case” on page 28

“Remove the battery pack” on page 29

Step 1. Disconnect and remove the MCU cable.

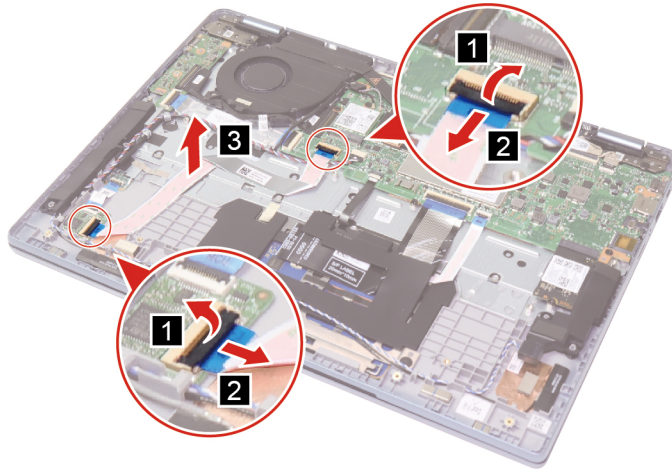

Figure 22. Disconnect and remove the MCU cable

Go to <https://support.lenovo.com/partslookup> to look up the Lenovo part numbers of the following replacement part:

MCU cable

---

## Remove the MCU board (for selected models)

Make sure the following FRUs (or CRUs) have been removed.

“Remove the lower case” on page 28

“Remove the battery pack” on page 29

Step 1. Disconnect the MCU cable and fingerprint reader cable from the MCU board. Then remove the MCU board.

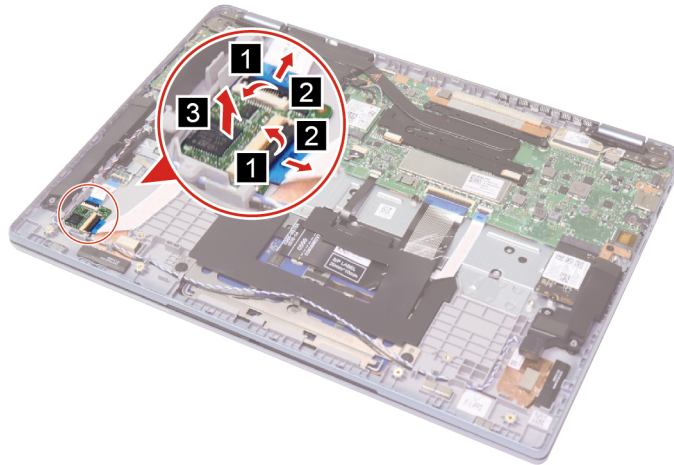

Figure 23. Disconnect cables and remove the MCU board

Go to <https://support.lenovo.com/partslookup> to look up the Lenovo part numbers of the following replacement part:

MCU board

---

## Remove the fingerprint reader board, bracket and cable (for selected models)

Make sure the following FRUs (or CRUs) have been removed.

“Remove the lower case” on page 28

“Remove the battery pack” on page 29

Step 1. Peel off the tape and release the cable from the rubber.

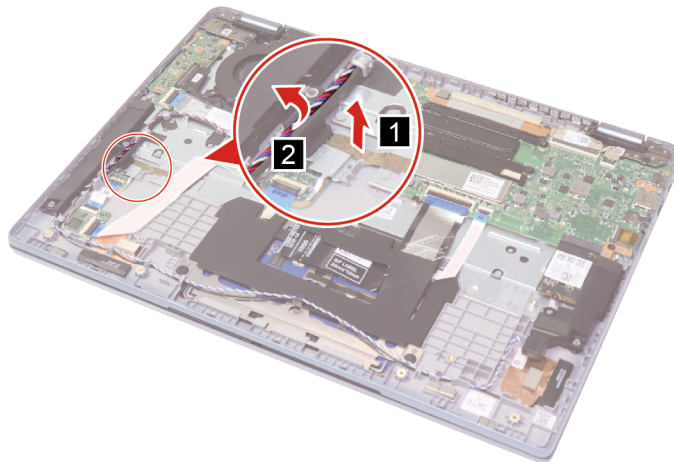

Figure 24. Peel off the tape and release the cable from the rubber

Step 2. Remove the fingerprint reader bracket with rubber.

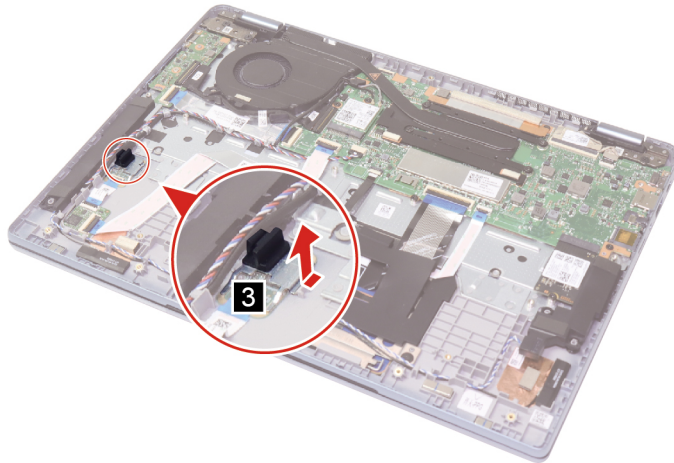

Figure 25. Remove the fingerprint reader bracket with rubber

Step 3. Disconnect the fingerprint reader cable and remove the fingerprint reader board.

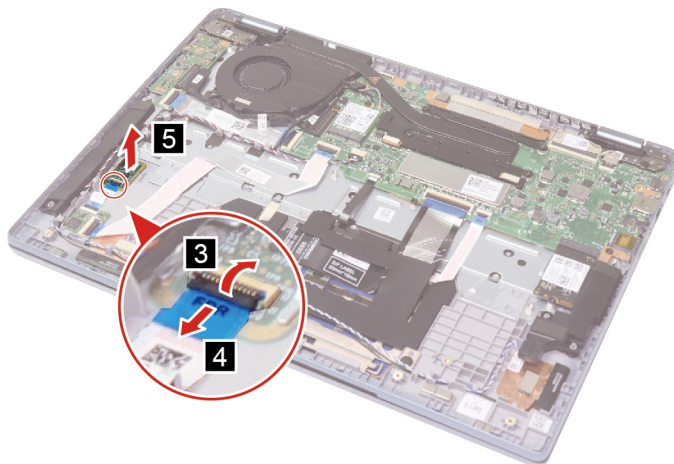

Figure 26. Disconnect the cable and remove the fingerprint reader board

Step 4. Disconnect the fingerprint reader cable from the MCU board and remove the fingerprint reader cable.



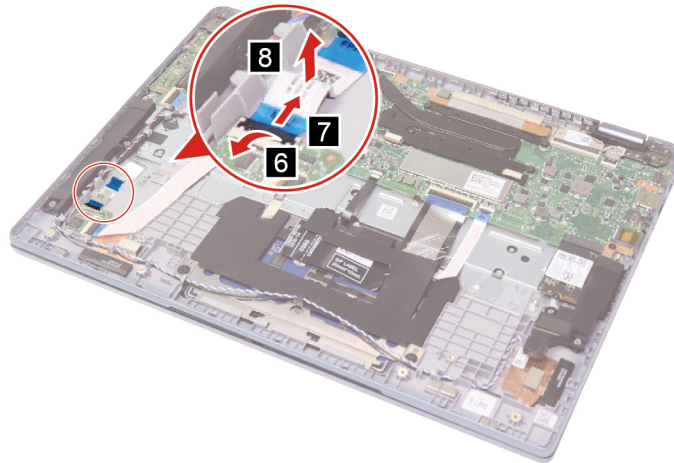

Figure 27. Disconnect and remove the fingerprint reader cable

Go to <https://support.lenovo.com/partslookup> to look up the Lenovo part numbers of the following replacement parts:

- Fingerprint reader board
- Fingerprint reader bracket with rubber
- Fingerprint reader cable

---

## Remove the system board

Make sure the following FRUs (or CRUs) have been removed.

- “Remove the lower case” on page 28
- “Remove the battery pack” on page 29
- “Remove the solid-state drive” on page 30
- “Remove the heat sink” on page 33
- “Remove the system fan” on page 34
- “Remove the Wi-Fi card” on page 38

Step 1. Disconnect all cables connected to the system board.

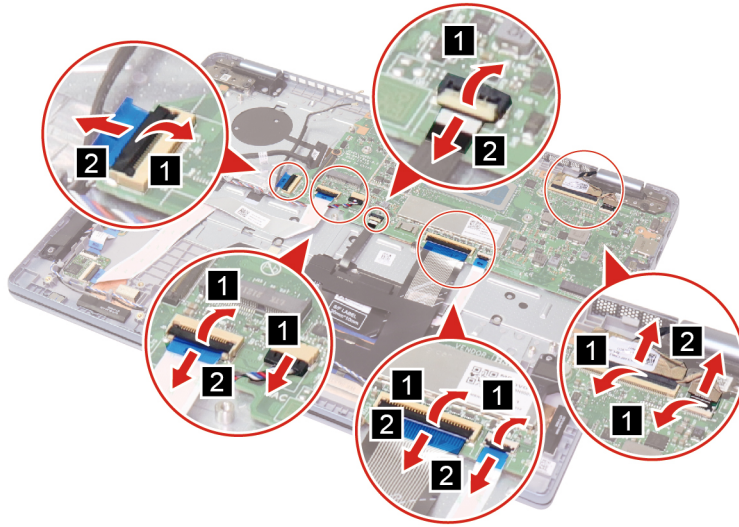

Figure 28. Disconnect all cables

Step 2. Remove five screws. Then, remove the system board.

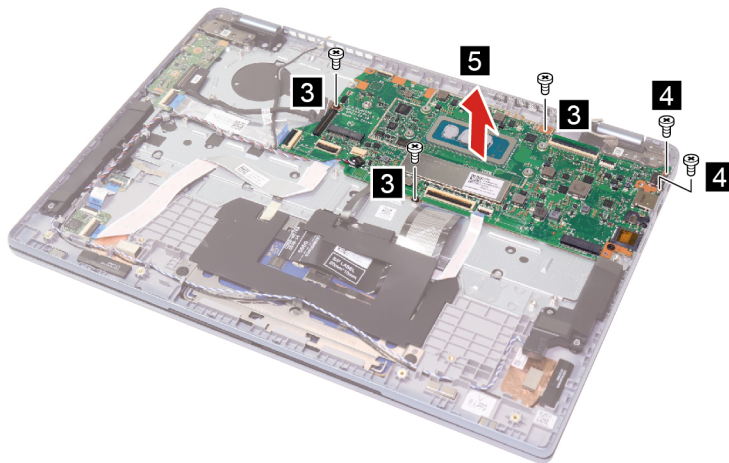

Figure 29. Remove five screws and the system board

Screw specifications	Number of screws
M2 x L2	3
M2 x L3	2

Go to <https://support.lenovo.com/partslookup> to look up the Lenovo part numbers of the following replacement part:

System board

## Use a Golden Key U1 tool to flash-write key id information

After replacing the system board and re-assembling the computer, use a pre-made Golden Key U1 tool to start the computer and flash-write the serial number (SN), machine type (MT), product name (PN), and UUID to the new system board.

The Golden Key U1 tool is prepared by running the U1 Update software on a FAT32-formatted USB thumb drive. Go to <http://support.lenovo.com/us/en/solutions/HT506954> for detailed instructions on how to create and use a Golden Key U1 tool.

---

## Remove the LCD unit

Make sure the following FRUs (CRUs) have been removed.

“Remove the lower case” on page 28

Step 1. Disconnect the battery pack cable and the EDP cable connectors from the system board.

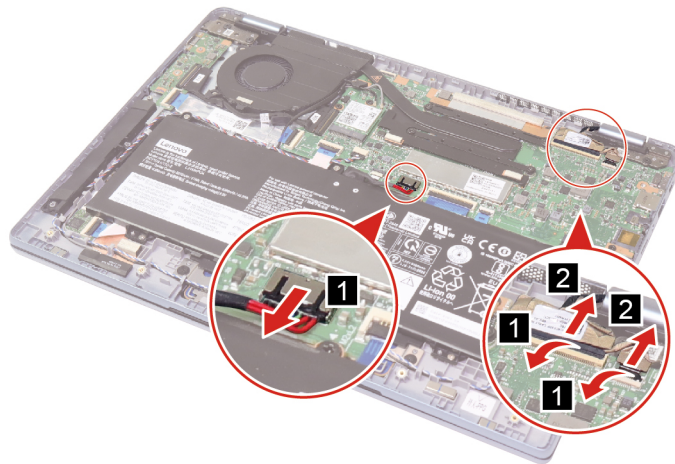

Figure 30. Disconnect the battery pack cable and EDP cable connectors

Step 2. Remove four screws.

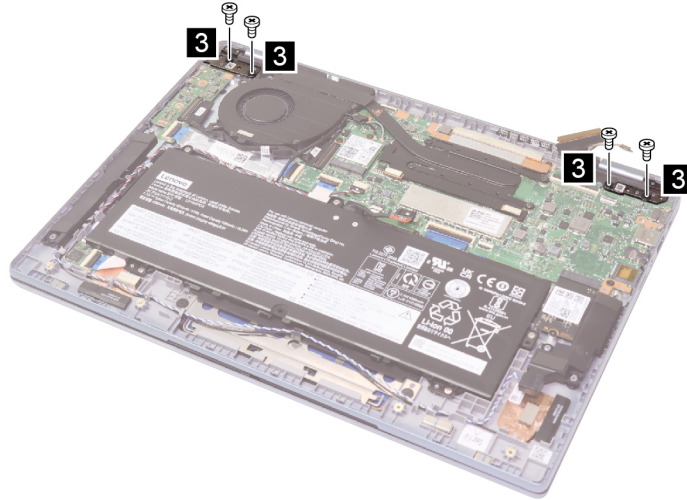

Figure 31. Remove four screws

Screw specifications	Number of screws
M2.5 x L5	4

Step 3. Remove the LCD unit.

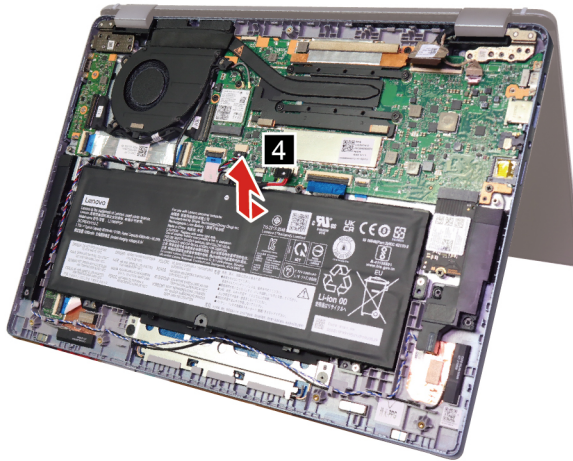

Figure 32. Remove the LCD unit

Go to <https://support.lenovo.com/partslookup> to look up the Lenovo part numbers of the following replacement part:

LCD unit

## Remove the upper case assembly

Make sure the following FRUs (CRUs) have been removed.

- “Remove the lower case” on page 28
- “Remove the battery pack” on page 29
- “Remove the solid-state drive” on page 30
- “Remove the touch pad cable” on page 31
- “Remove the heat sink” on page 33
- “Remove the system fan” on page 34
- “Remove the I/O board cables” on page 36
- “Remove the I/O board” on page 37
- “Remove the Wi-Fi card” on page 38
- “Remove the MCU cable (for selected models)” on page 40
- “Remove the MCU board (for selected models)” on page 40
- “Remove the fingerprint reader board, bracket and cable (for selected models)” on page 41
- “Remove the system board” on page 43
- “Remove the LCD unit” on page 45

Go to <https://support.lenovo.com/partslookup> to look up the Lenovo part numbers of the following replacement part:

Upper case assembly

---

## Disassemble the LCD unit

The LCD unit as a whole is not an FRU. Instead, it contains FRUs as its components. Before disassembling the LCD unit, make sure it has been detached from the upper case assembly.

### Remove the strip cover

Make sure the following FRUs (or CRUs) have been removed.

- “Remove the LCD unit” on page 45

Step 1. Remove the strip cover.



Figure 33. Remove the strip cover

Refer to <https://support.lenovo.com/partslookup> to look up the Lenovo part numbers of the following replacement part:

Strip cover

## Remove the hinge rubbers

Make sure the following FRUs (or CRUs) have been removed.

“Remove the LCD unit” on page 45

“Remove the strip cover” on page 47

Step 1. Remove two hinge rubbers from the hinge caps carefully.

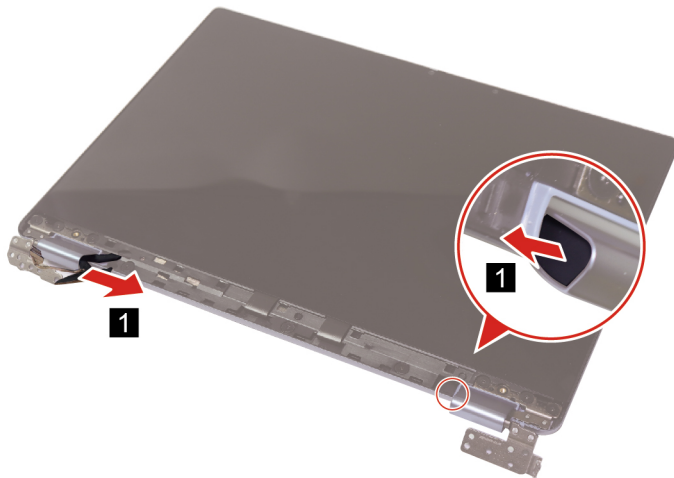

Figure 34. Remove hinge rubbers

Refer to <https://support.lenovo.com/partslookup> to look up the Lenovo part numbers of the following replacement parts:

Hinge rubbers

## Remove the LCD module

Make sure the following FRUs (or CRUs) have been removed.

“Remove the LCD unit” on page 45

“Remove the strip cover” on page 47

“Remove the hinge rubbers” on page 48

Step 1. Pull the two tapes (located on left and right edges under the LCD panel) downwards steadily with the bottom edge as an axis.

Step 2. Remove three screws. Then, remove the LCD module.

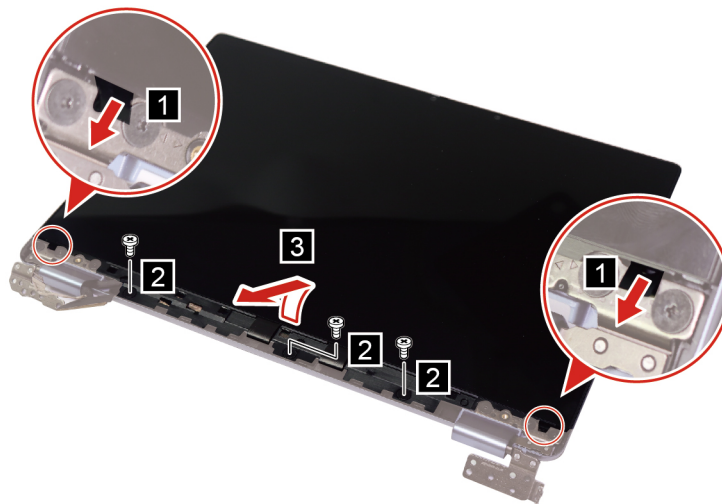

Figure 35. Remove three screws and the LCD module

Screw specifications	Number of screws
M2 x L3	3

Refer to <https://support.lenovo.com/partslookup> to look up the Lenovo part numbers of the following replacement part:

LCD module

## Remove the hinges

Make sure the following FRUs (or CRUs) have been removed.

“Remove the LCD unit” on page 45

“Remove the strip cover” on page 47

“Remove the hinge rubbers” on page 48

“Remove the LCD module” on page 49

Step 1. Remove six screws and then remove the hinges.

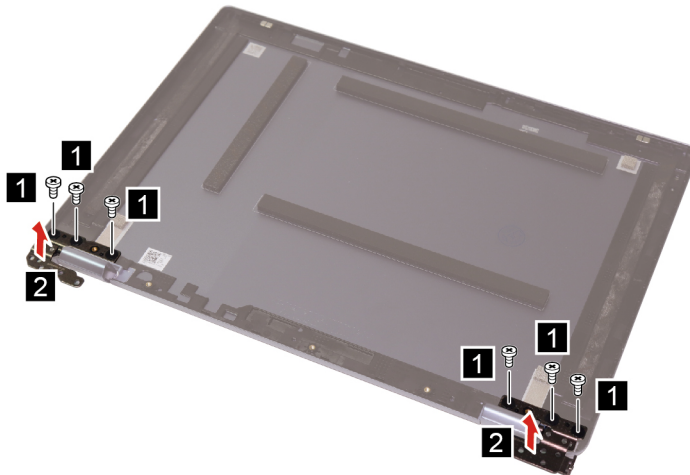

Figure 36. Remove six screws and the hinges

Screw specifications	Number of screws
M2 x 3	6

Refer to <https://support.lenovo.com/partslookup> to look up the Lenovo part numbers of the following replacement parts:

Hinges

## Remove the microphone rubbers

Make sure the following FRUs (or CRUs) have been removed.

- “Remove the LCD unit” on page 45
- “Remove the strip cover” on page 47
- “Remove the hinge rubbers” on page 48
- “Remove the LCD module” on page 49

Step 1. Remove the camera aluminum (Al) foil.



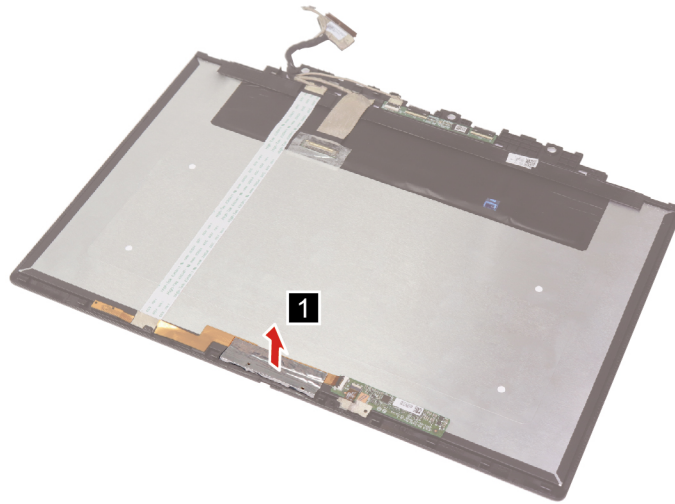

Figure 37. Remove the camera AI foil

Step 2. Turn over the camera board. Then, remove the microphone rubbers.

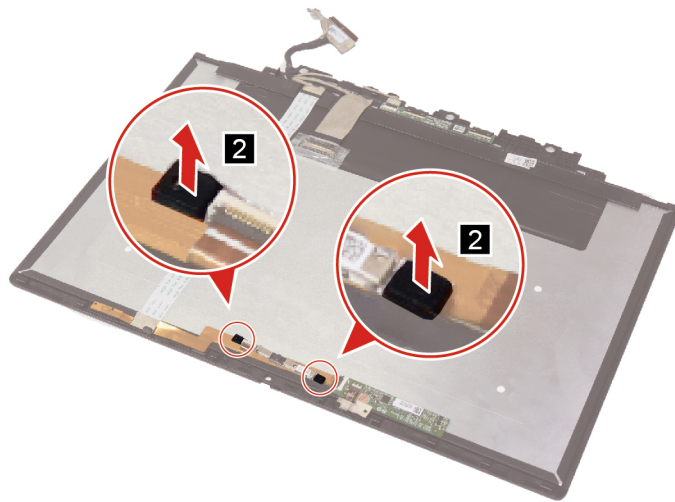

Figure 38. Remove the microphone rubbers

Go to <https://support.lenovo.com/partslookup> to look up the Lenovo part numbers of the following replacement parts:

Microphone rubbers

Camera AI foil

## Remove the camera board

Make sure the following FRUs (or CRUs) have been removed.

“Remove the LCD unit” on page 45

“Remove the strip cover” on page 47

- “Remove the hinge rubbers” on page 48
- “Remove the LCD module” on page 49
- “Remove the microphone rubbers” on page 50

Step 1. Disconnect the EDP cable from the camera board. Then, remove the camera board.

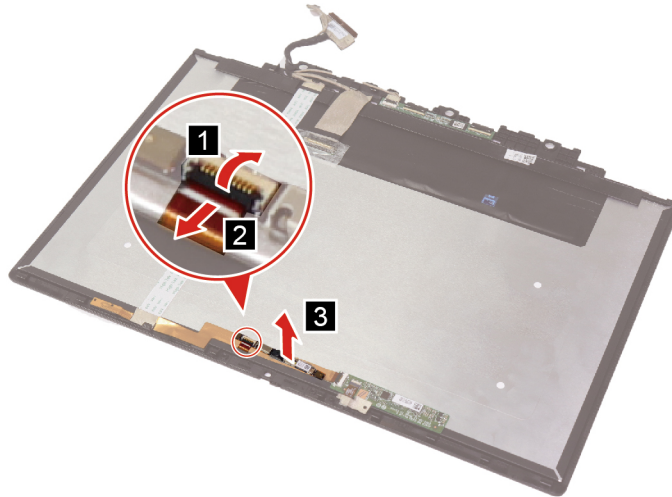

Figure 39. Remove the camera board

Go to <https://support.lenovo.com/partslookup> to look up the Lenovo part numbers of the following replacement part:

Camera board

## Remove the EDP cable

Make sure the following FRUs (or CRUs) have been removed.

- “Remove the LCD unit” on page 45
- “Remove the strip cover” on page 47
- “Remove the hinge rubbers” on page 48
- “Remove the LCD module” on page 49
- “Remove the microphone rubbers” on page 50
- “Remove the camera board” on page 51

Step 1. Disconnect all connectors of the EDP cable. Then, remove the EDP cable.

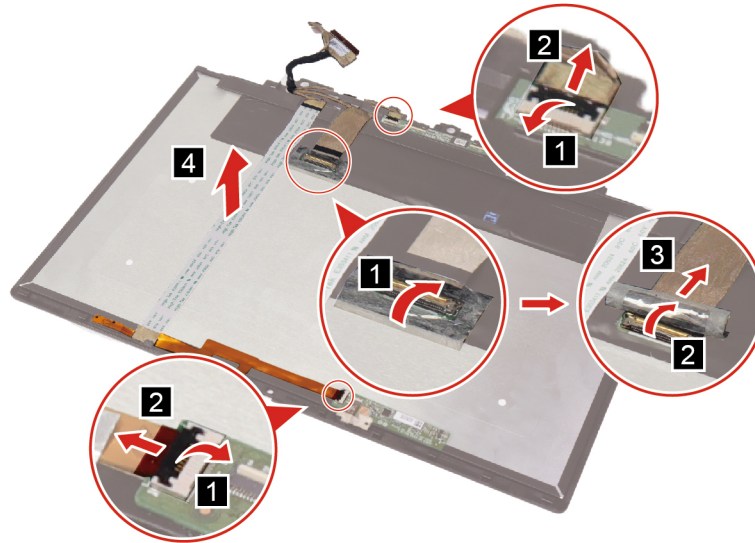

Figure 40. Disconnect all connectors and remove the EDP cable.

Go to <https://support.lenovo.com/partslookup> to look up the Lenovo part numbers of the following replacement part:

EDP cable

## Remove the HPS camera and the HPS board (for selected models)

Make sure the following FRUs (or CRUs) have been removed.

- “Remove the LCD unit” on page 45
- “Remove the strip cover” on page 47
- “Remove the hinge rubbers” on page 48
- “Remove the LCD module” on page 49

Step 1. Peel off the acetate tape.

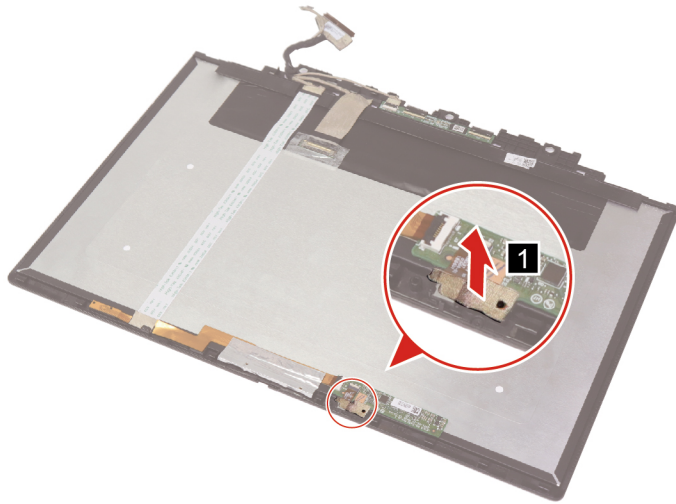

Figure 41. Peel off the acetate tape

Step 2. Disconnect the cable and remove the HPS camera.

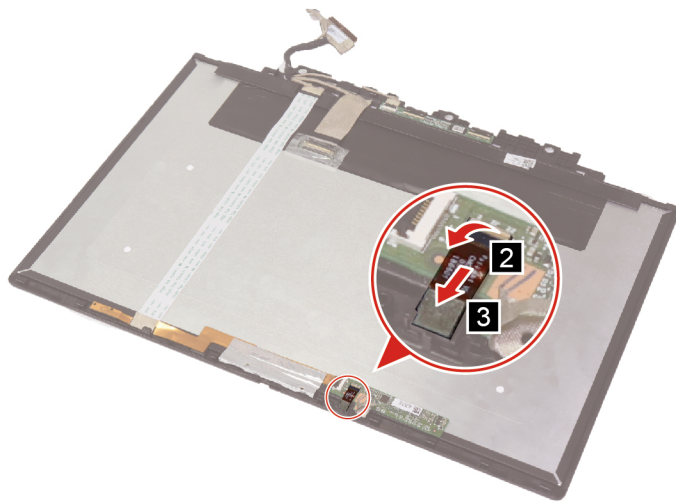

Figure 42. Disconnect the cable and remove the HPS camera

Step 3. Disconnect the cable and remove the HPS board.

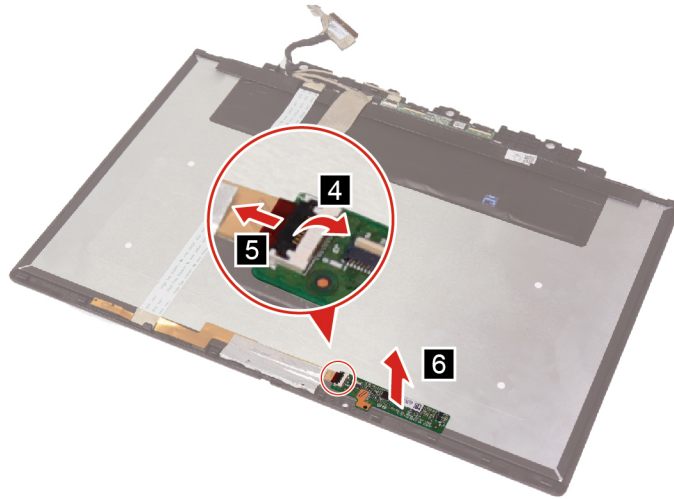

Figure 43. Disconnect the cable and remove the HPS board

Go to <https://support.lenovo.com/partslookup> to look up the Lenovo part numbers of the following replacement parts:

HPS camera

HPS board

## Remove the sensor board

Make sure the following FRUs (or CRUs) have been removed.

“Remove the LCD unit” on page 45

“Remove the strip cover” on page 47

“Remove the hinge rubbers” on page 48

“Remove the LCD module” on page 49

Step 1. Disconnect all cables and remove the sensor board.

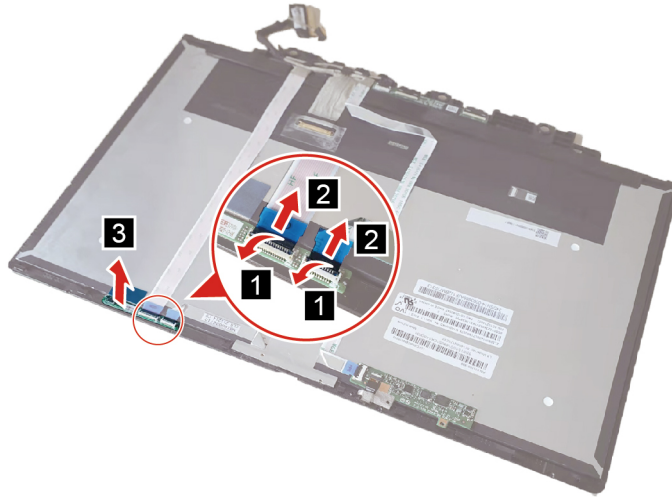

Figure 44. Disconnect cables and remove the sensor board

Go to <https://support.lenovo.com/partslookup> to look up the Lenovo part numbers of the following replacement part:

Sensor board

## Remove the LCD cover

Make sure the following FRUs (CRUs) have been removed.

- “Remove the lower case” on page 28
- “Remove the LCD unit” on page 45
- “Remove the strip cover” on page 47
- “Remove the hinge rubbers” on page 48
- “Remove the LCD module” on page 49
- “Remove the hinges” on page 49
- “Remove the microphone rubbers” on page 50
- “Remove the camera board” on page 51
- “Remove the EDP cable” on page 52
- “Remove the HPS camera and the HPS board (for selected models)” on page 53
- “Remove the sensor board” on page 55

Go to <https://support.lenovo.com/partslookup> to look up the Lenovo part numbers of the following replacement part:

LCD cover

---

## **Trademarks**

LENOVO, the LENOVO logo, and IdeaPad are trademarks of Lenovo.

All other trademarks are the property of their respective owners. © 2022 Lenovo.







**Lenovo**