

# VG2758-2K

## Display User Guide

**IMPORTANT:** Please read this User Guide to obtain important information on installing and using your product in a safe manner, as well as registering your product for future service. Warranty information contained in this User Guide will describe your limited coverage from ViewSonic® Corporation, which is also found on our web site at <http://www.viewsonic.com> in English, or in specific languages using the Regional selection box of our website.

Model No. VS20064  
P/N: VG2758-2K | VG2758-2K-1B

## **Thank you for choosing ViewSonic®**

As a world-leading provider of visual solutions, ViewSonic® is dedicated to exceeding the world's expectations for technological evolution, innovation, and simplicity. At ViewSonic®, we believe that our products have the potential to make a positive impact in the world, and we are confident that the ViewSonic® product you have chosen will serve you well.

Once again, thank you for choosing ViewSonic®!

# Safety Precautions

- Read these instructions completely before using the equipment.
- Keep these instructions in a safe place.
- Heed all warnings and follow all instructions.
- Sit at least 18" / 45 cm from the monitor.
- When installing the monitor, please leave 4" / 10 cm of open space around the monitor for ventilation safety purposes.
- Always handle the display with care when moving it.
- Always use cabinets or stands or installation methods recommended by the manufacturer of the monitor set.
- Always use furniture that can safely support the monitor.
- Always ensure the monitor is not overhanging the edge of the supporting furniture.
- Do not place the monitor where children are likely to be present.
- Always educate children about the dangers of climbing on furniture to reach the monitor or related equipment.
- Always route and manage cords and cables connected to your monitor so they cannot be tripped over, pulled, or grabbed.
- Exercise caution when removing the rear cover of the monitor. This monitor contains high-voltage parts.
- Do not use this equipment near water. To reduce the risk of fire or electric shock, do not expose the monitor to rain or moisture.
- Avoid exposing the monitor to direct sunlight or other sources of sustained heat. Do not install near any heat sources such as radiators, heat registers, stoves, or other devices (including amplifiers) that may increase the temperature of the monitor to dangerous levels.
- Clean with a soft, dry cloth. If further cleaning is required, see the "Maintenance" section in this guide for further instructions.
- Avoid touching the screen. Skin oils are difficult to remove.
- Do not touch, rub, or apply pressure to the monitor screen, as it may permanently damage the screen.
- Do not place the monitor in an unstable location.
- Do not place the monitor on tall furniture (for example, cupboards or bookcases) without anchoring both the furniture and the monitor to a suitable support.
- Do not place the monitor on cloth or other materials that may be located between the product and supporting furniture.

- Place the monitor in a well-ventilated area. Do not place anything on the display that prevents heat dissipation.
- Do not place heavy objects on the display, video cable, or power cord.
- Do not place items that might tempt children to climb, such as toys and remote controls, on the top of the monitor or furniture on which the product is placed.
- If smoke appears, an abnormal noise, or a strange odor is present, immediately switch the display off and contact your dealer or ViewSonic. It is dangerous to continue using the display.
- Do not attempt to circumvent the safety provisions of the polarized or grounding-type plug. A polarized plug has two blades with one wider than the other. A grounding type plug has two blades and a third grounding prong. The wide blade and the third prong are provided for your safety. If the plug does not fit into your outlet, obtain an adaptor and do not attempt to force the plug into the outlet.
- Please confirm the distribution system installed in the building. The system should provide a circuit breaker rated at 120/240V, 20A.
- When connecting to a power outlet, DO NOT remove the grounding prong. Please ensure grounding prongs are NEVER REMOVED.
- Protect the power cord from being treaded upon or pinched, particularly at the plug, and at the point where it emerges from the equipment. Be sure that the power outlet is located near the equipment so that it is easily accessible.
- Only use attachments/accessories specified by the manufacturer.
- Use only with the cart, stand, tripod, bracket, or table specified by the manufacturer, or sold with the equipment. When a cart is used, use with caution when moving the cart/equipment combination to avoid injury from tipping over.
- Unplug this equipment when it will be unused for long periods of time.
- Refer all servicing to qualified service personnel. Service will be required when the unit has been damaged in any way, such as: if the power-supply cord or plug is damaged, if liquid is spilled onto or objects fall into the unit, if the unit is exposed to rain or moisture, or if the unit does not operate normally or has been dropped.
- Excessive sound volume from ear-/headphones may cause hearing damage/hearing loss.
- Adjustment of the volume control as well as the equalizer may increase the ear-/headphones output voltage and therefore, the sound volume level.
- The factors influencing the ear-/headphones output other than those specified by the manufacturer (e.g. operating system, equalizer software, firmware, driver) may increase the ear-/headphone output voltage and therefore, the sound volume level.

- **Stability Hazard:** The display may fall, causing serious personal injury or death. To prevent injury, this display must be securely attached to the floor/wall in accordance with the installation instructions.
- Fastening the monitor to a wall or fixed object using cordage or other restraining devices can help support the weight of the monitor in order to prevent the monitor from falling over.

Hole pattern (W x H)	Interface Pad (W x H x D)	Pad Hole	Screw Specification	Screw Quantity
100 x 100 mm	N/A	Ø 5 mm	M4 x 10 mm	4 pieces

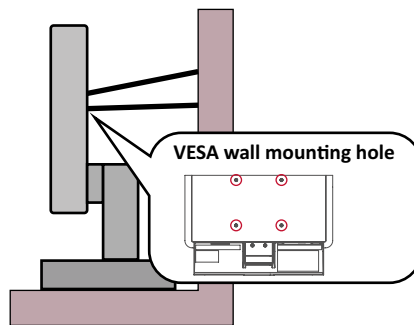

**NOTE:**

- Restraining device/cordage should be able to withstand 100N force.
- Make sure the cordage is straightened, and any slack is removed. The back of the device shall face the wall to ensure the device cannot tilt under external force.
- Make sure the monitor does not tilt under external force at any height and rotation angle of the device.
- If the existing monitor is going to be retained and relocated, the same considerations as above should be applied.

# Contents

<b>Safety Precautions.....</b>	<b>3</b>
<b>Introduction .....</b>	<b>8</b>
Package Contents .....	8
Product Overview .....	9
Front and Rear View.....	9
<b>Initial Setup.....</b>	<b>10</b>
Installing the Stand .....	10
Removing the Stand and Mounting the Display .....	12
Using the Security Slot.....	14
<b>Making Connections .....</b>	<b>15</b>
Connecting to Power .....	15
Display Connection .....	16
HDMI .....	16
DisplayPort .....	17
USB Type C .....	18
USB Type C MST Daisy Chain.....	19
USB Connection .....	21
Using the USB Ports.....	22
Ethernet Connection .....	24
Audio Connection .....	25
<b>Using the Monitor .....</b>	<b>26</b>
Adjusting the Viewing Angle.....	26
Height Adjustment .....	26
Screen Orientation Adjustment (Pivot).....	27
Swivel Adjustment.....	28
Tilt Angle Adjustment.....	29
Turning the Monitor On/Off.....	30
Using the Joy Key.....	30
Quick Menu .....	31
Hot Keys .....	34
Configuring the Settings .....	36
General Operations .....	36
On-Screen Display (OSD) Menu Tree .....	38
Menu Options .....	43

<b>Appendix.....</b>	<b>51</b>
Specifications.....	51
Glossary .....	54
Troubleshooting .....	59
Maintenance.....	61
General Precautions .....	61
Cleaning the Screen.....	61
Cleaning the Case .....	61
Blue Light Filter and Eye Health.....	62
Calculating Breaks .....	62
Looking at Distant Objects .....	62
Eye and Neck Exercises .....	62
Product Upgradeability and Repairability .....	63
<b>Regulatory and Service Information .....</b>	<b>64</b>
Compliance Information.....	64
FCC Compliance Statement.....	64
Industry Canada Statement.....	64
CE Conformity for European Countries.....	64
Declaration of RoHS2 Compliance.....	65
Indian Restriction of Hazardous Substances .....	66
Product Disposal at End of Product Life .....	66
TCO Certified .....	67
Copyright Information .....	68
Customer Service.....	69
Limited Warranty .....	70
Mexico Limited Warranty.....	73

# Introduction

## Package Contents

- Monitor
- Power cord
- Video cable
- USB cable
- Quick start guide

### **NOTE:**

- The cables included in your package may vary depending on your country. Please contact your local reseller for more information.
- The USB Type C ports on this monitor support power delivery and can provide up to 100W of power. For your safety, please use the supplied USB Type C cable to connect only manufacturer-approved devices that meet the fire protection requirements of IEC 62368 to the monitor.

# Product Overview

## Front and Rear View

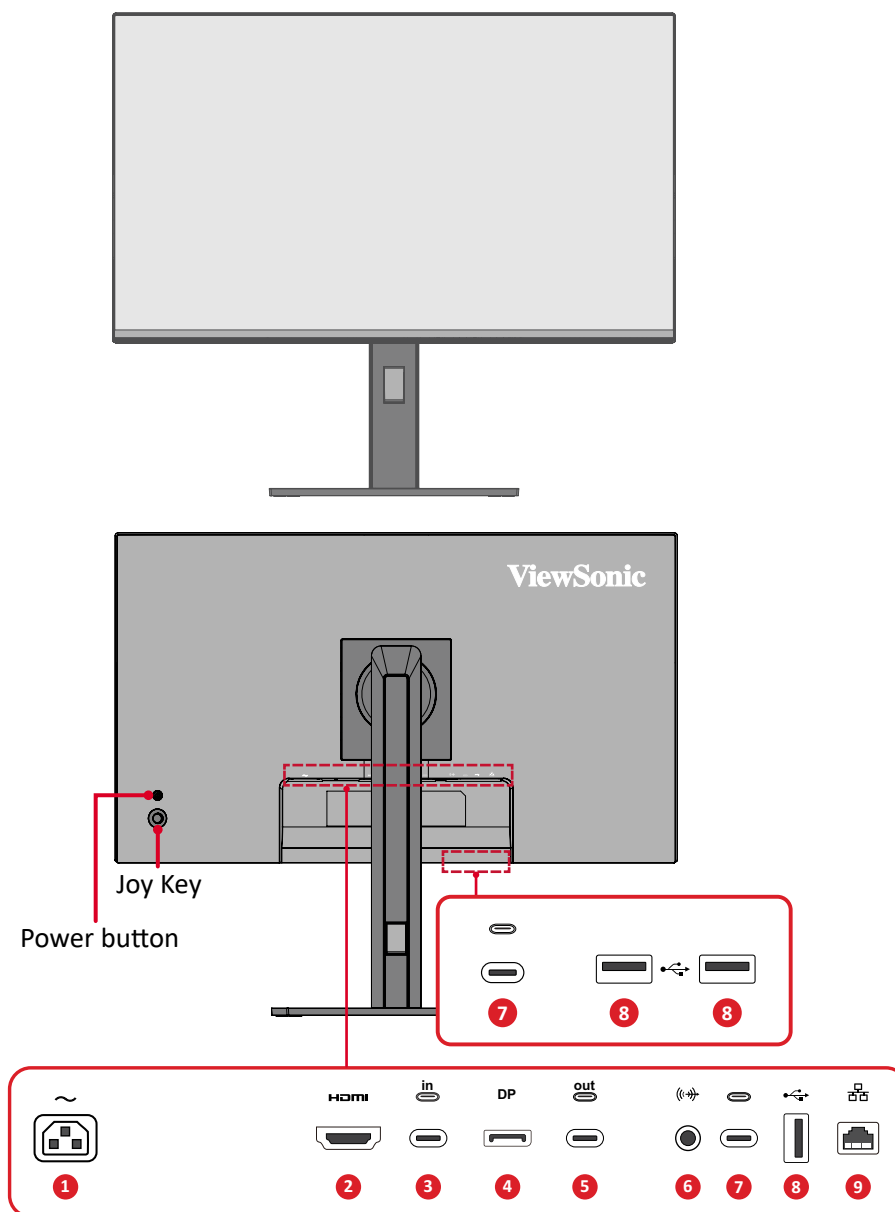

- 1. AC IN
- 2. HDMI
- 3. USB Type C In (Upstream)
- 4. DisplayPort
- 5. USB Type C Out
- 6. Audio Out
- 7. USB Type C Downstream
- 8. USB Downstream
- 9. LAN

**NOTE:** For more information about the **Joy Key** and its functions, refer to “Hot Keys” on page 34.

# Initial Setup

## Installing the Stand

1. Place the box on a flat, stable surface and follow the instructions on the front flap of the box to reveal the contents.
2. Remove the monitor stand's base and neck from the top tray.
3. Carefully connect the monitor stand's neck into the monitor stand's base until it clicks into place.

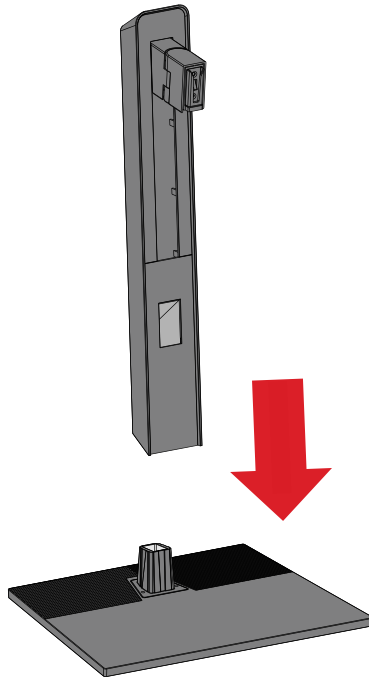

4. Remove the top tray and open the protective cover to reveal the pre-installed VESA cover.

5. Align and slide the upper hook of the monitor stand onto the rail of the pre-installed VESA cover on the rear of the monitor.

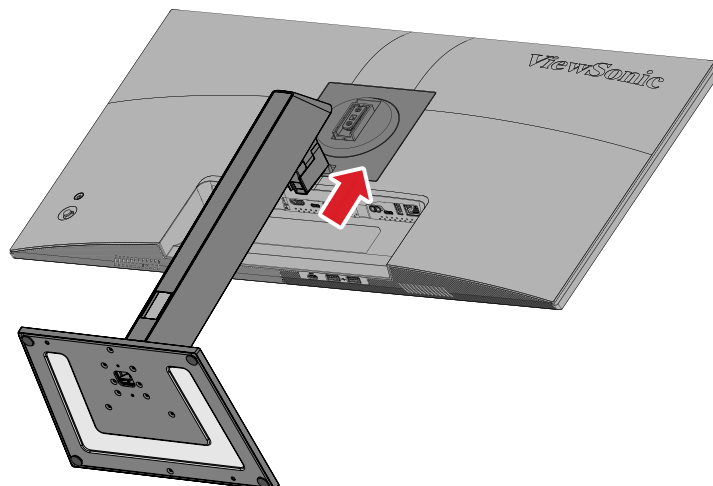

**NOTE:** Please make sure the stand is secure and the quick release tab positively clicks into place.

6. Using the stand's handle, lift the monitor into its upright position on a flat, stable surface.

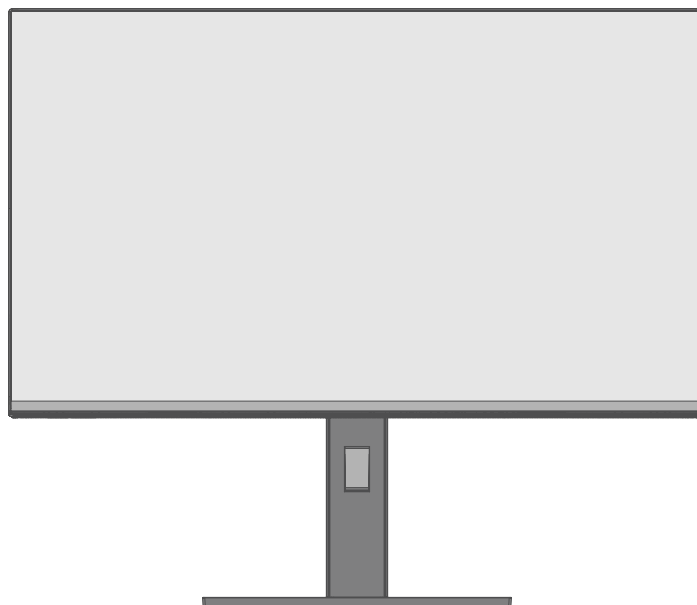

**NOTE:** Always place the monitor on a flat, stable surface. Failure to do so may cause the monitor to fall and damage the monitor and/or result in personal injury.

# Removing the Stand and Mounting the Display

Refer to the table below for the standard dimensions for mounting kits.

**NOTE:** For use only with a UL certified mounting kit/bracket. To obtain a wall mounting kit or height adjustment base, contact ViewSonic® or your local dealer.

Maximum Loading	Hole pattern (W x H)	Interface Pad (W x H x D)	Pad Hole	Screw Specification	Screw Quantity
14 kg	100 x 100 mm	N/A	Ø 5 mm	M4 x 10 mm	4 pieces

**NOTE:** Mounting kits are sold separately.

1. Turn off the monitor and disconnect all cables.
2. Place the monitor on a flat, stable surface with the screen facing down.
3. Press and hold the quick release tab and carefully lift the stand.

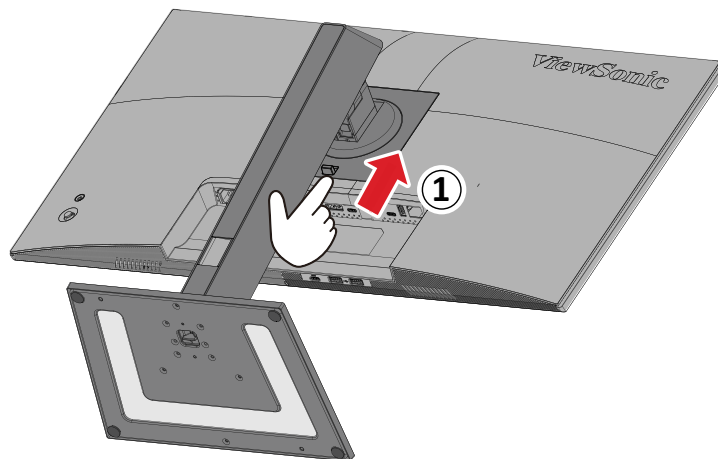

4. Pull down slightly to disengage the hooks and remove the stand.

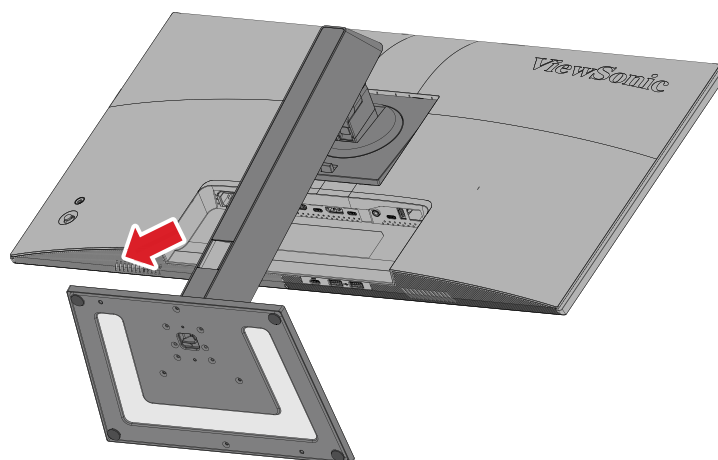

5. Attach the mounting bracket to the VESA mounting holes at the rear of the monitor. Then secure it with four screws (M4 x 10 mm).

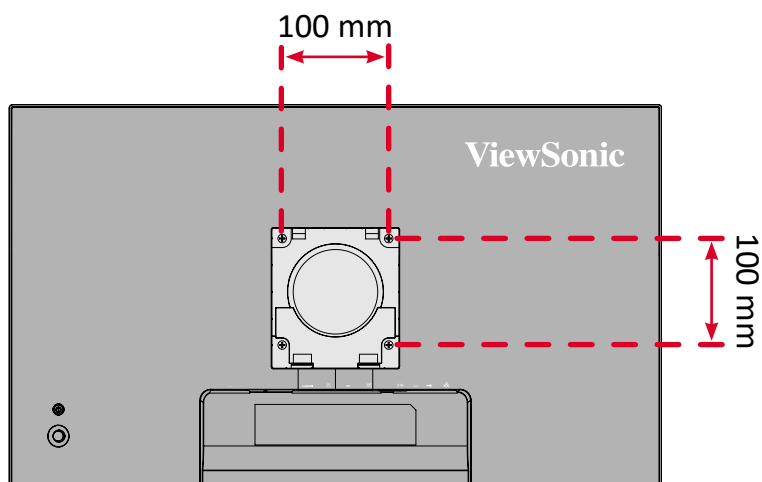

6. Follow the instructions that come with the mounting kit to mount the monitor.

## Using the Security Slot

To help prevent the monitor from being stolen, use a security slot locking device to secure the monitor to a fixed object.

Additionally, fastening the monitor to a wall or fixed object using a security cable can help support the weight of the monitor in order to prevent the monitor from falling over.

Below is an example of setting up a security slot locking device on a table.

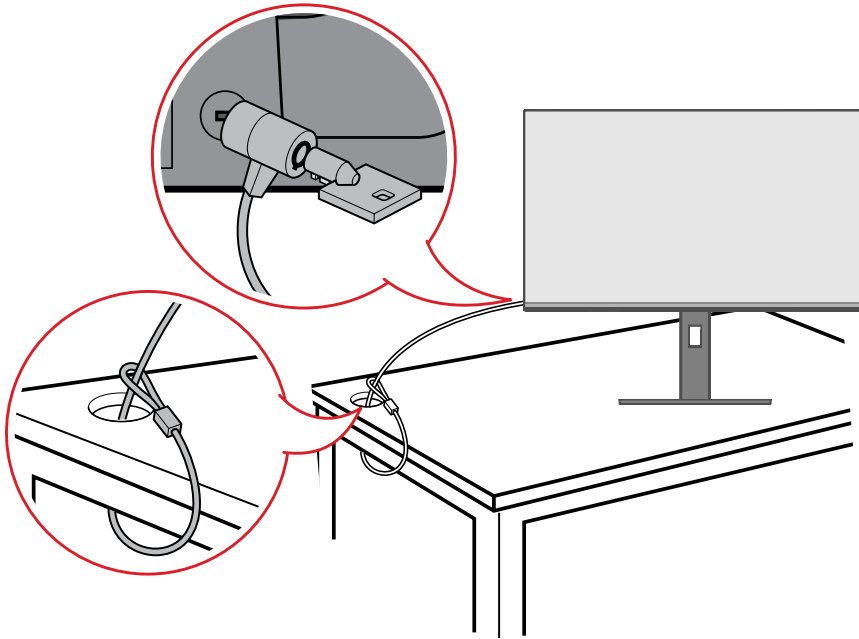

# Making Connections

## Connecting to Power

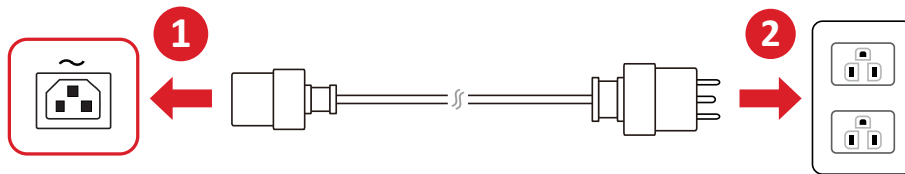
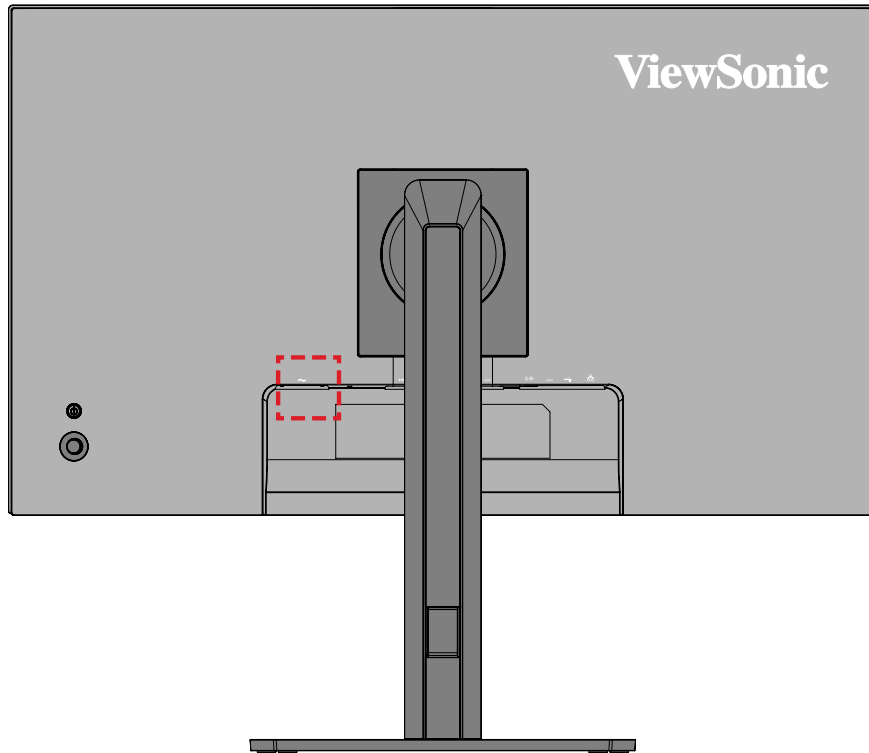

1. Connect the power cord to the **AC IN** jack at the rear of the monitor.
2. Plug the power cord plug into a power outlet.

# Display Connection

## HDMI

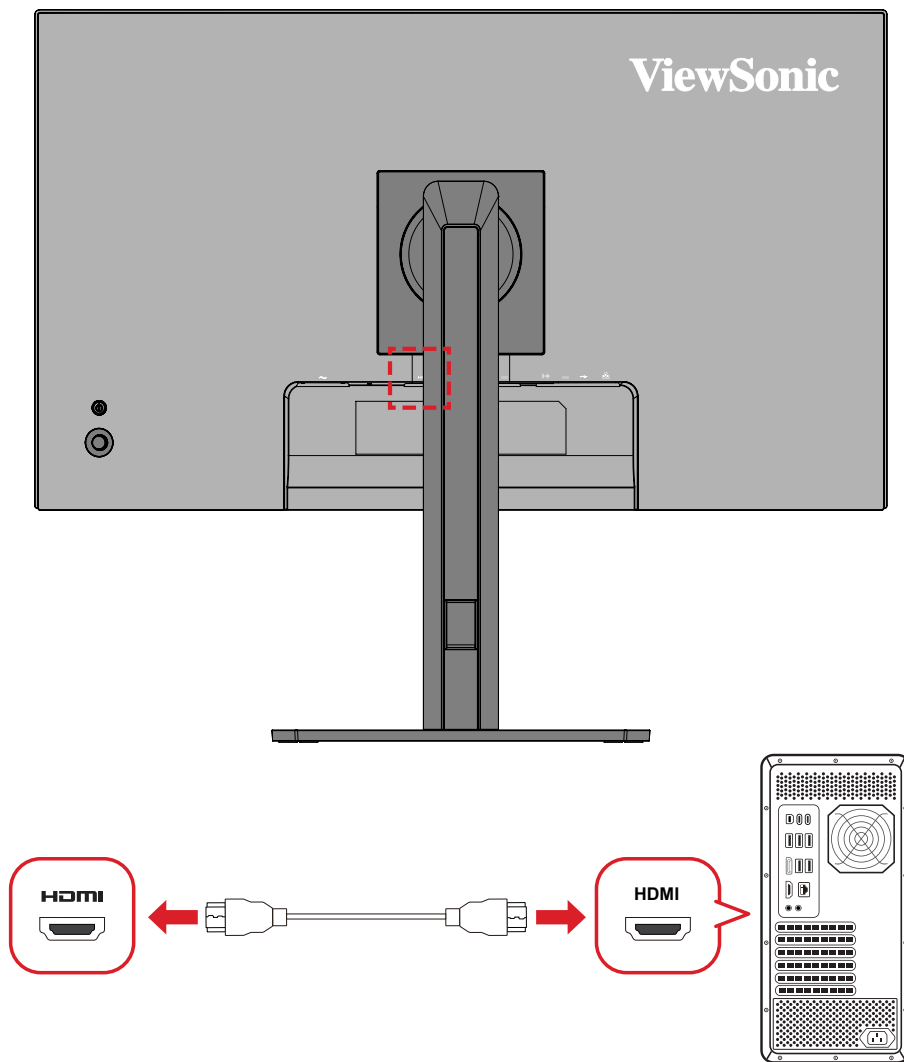

1. Connect one end of an HDMI cable to the HDMI port of your monitor.
2. Plug the other end of the cable to the HDMI port of your computer.

## DisplayPort

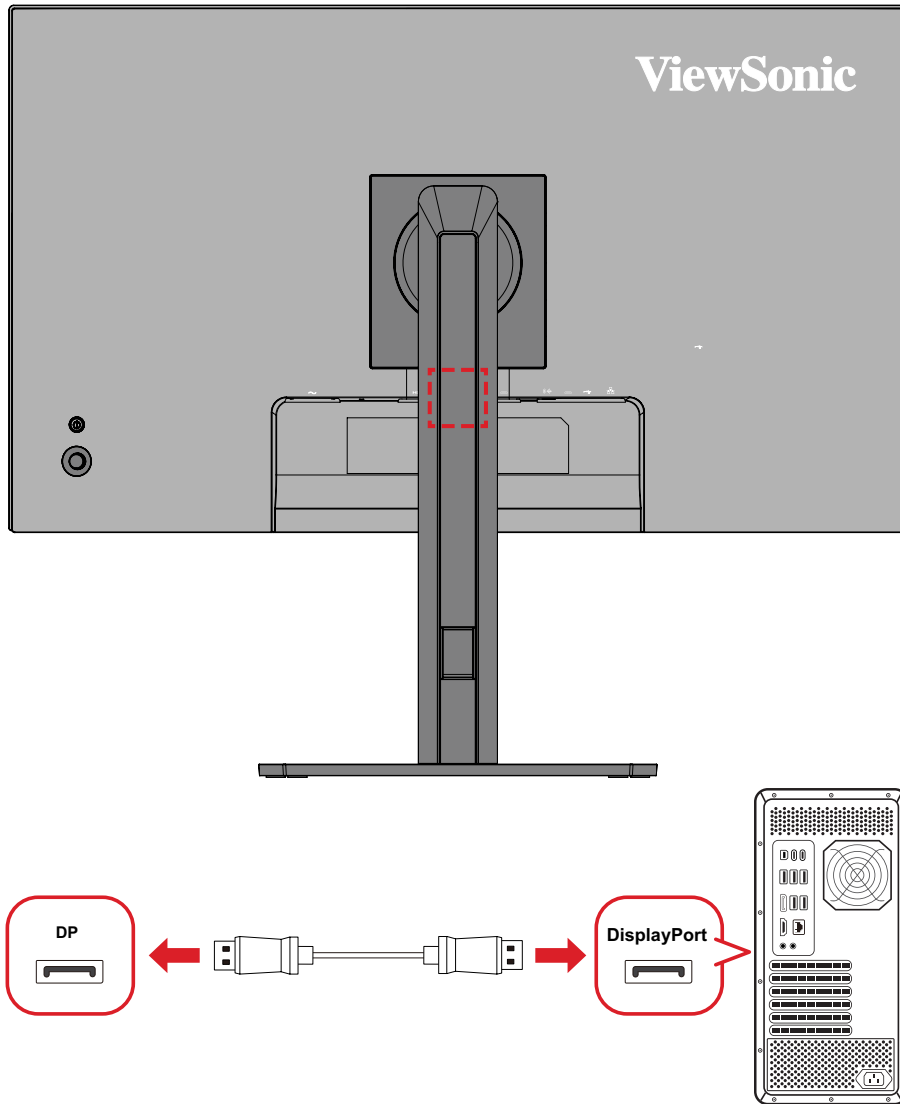

1. Connect one end of a DisplayPort cable to the DisplayPort port of the monitor.
2. Plug the other end of the cable to the DisplayPort or mini DisplayPort port of your computer.

**NOTE:** To connect the monitor to the Thunderbolt port (v. 1 & v. 2) on your Mac, connect the mini DisplayPort end of the “mini DisplayPort to DisplayPort cable” to the Thunderbolt output of your Mac. Then connect the other end of the cable to the DisplayPort port of the monitor.

## USB Type C

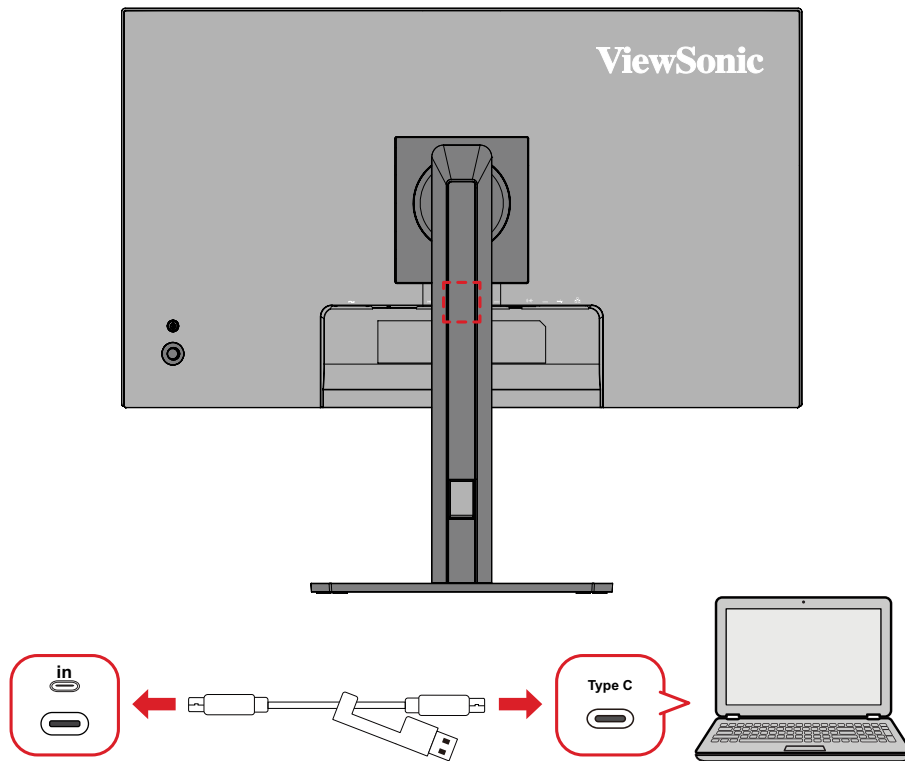

1. Connect one end of a USB Type C cable to the rear upstream USB Type C port of the monitor.
2. Plug the other end of the cable into the full-featured USB port of your computer.

### NOTE:

- For video output use, make sure your USB Type C output device (e.g., laptop) and cable support video signal transmission.
- Please use the supplied USB Type C cable, or alternatively a full-featured USB Type C cable that supports SuperSpeed data transfer (up to 10Gbps), DP Alt Mode, and 100W (5A) power delivery.
- When you use Type C as the video signal input source, it is recommended to unplug the DisplayPort and HDMI signals to avoid audio output confusion.
- Due to the product's Type C power delivery design, do not connect the laptops' adapter at the same time. This can cause laptops' power distribution conflicts, resulting in flashing screens or the forced shutdown of the laptop(s).

## USB Type C MST Daisy Chain

With DisplayPort 1.4 Multi-Stream Transport (MST) support, you can daisy chain up to two of the ViewSonic's QHD (2560 x 1440) @100 Hz monitors from the USB Type C ports without losing USB 3.2 speeds.

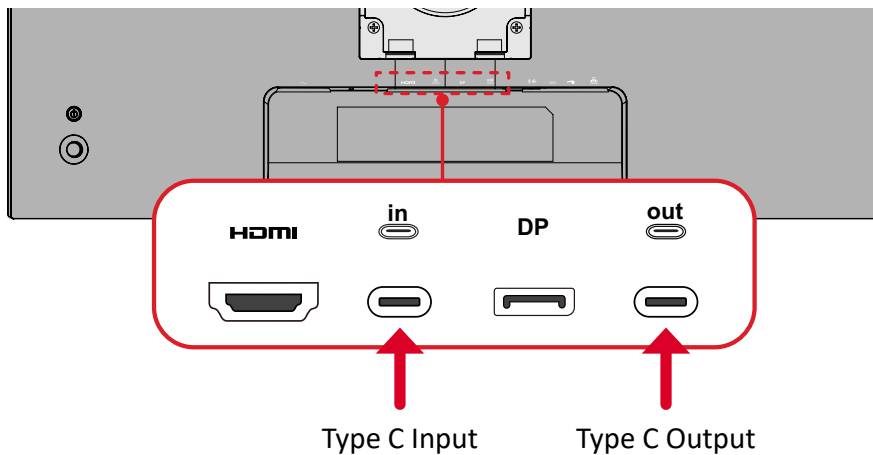

1. Connect one end of a DisplayPort/USB Type C cable to the USB Type C port of your computer. Then connect the other end of the cable to the USB Type C In port of the monitor.  
**NOTE:** Make sure your computer's graphics card supports DisplayPort MST.
2. Use a USB Type C cable to connect to the USB Type C Out port of the first monitor. Then connect the other end of the cable to the USB Type C In port of the second monitor.
3. Repeat **Step 2** as needed (see the following diagram for the maximum number of the VG2758-2K monitors that can be connected).

### NOTE:

- DisplayPort 1.4 MST must be turned on in the **Setup Menu** in the OSD Menu to enable daisy chaining.
  - If **High Data Speed** is selected, it will prioritize high speed data transfer and Ethernet.
  - If **High Resolution** is selected, MST can support 2560 x 1440 @100 Hz, but data transfer and Ethernet speed will be limited to USB 2.0 standards due to bandwidth limitation.
- If the input source changes to HDMI, DisplayPort 1.4 MST will turn off automatically.

## Example of Maximum Number of the VG2758-2K Monitors

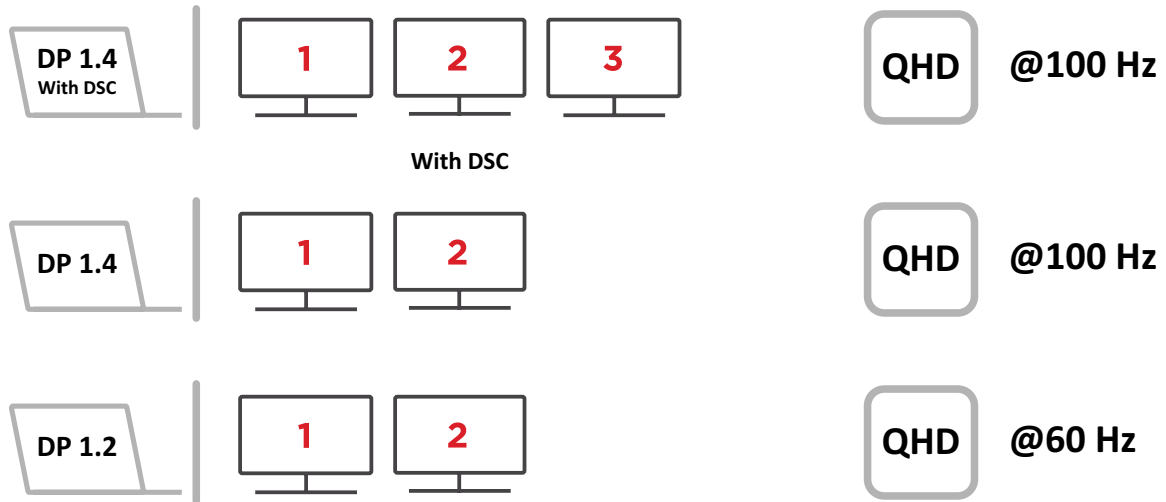

### NOTE:

- Please use the supplied USB Type C cable with the USB Type C In port, or alternatively a full-featured USB Type C cable that supports SuperSpeed data transfer (up to 10Gbps), DP Alt Mode, and 100W (5A) power delivery.
- When an appropriate USB Type C cable is connected to the USB Type C Out port, the cable must support SuperSpeed data transfer (up to 10Gbps) and DP Alt Mode.
- The diagram is provided for reference only. The number of monitors you can connect to your system depends on your graphics card compatibility and monitor resolution.
- A laptop's screen can be counted as one monitor.
- VESA's Display Stream Compression (DSC) standard enables displays to support higher resolutions and refresh rates without a noticeable loss in image quality and with reduced bandwidth.
- VG2758-2K is a DSC-compatible docking monitor. In order to enable 2K resolution @ 100 Hz with DSC, a graphics card that supports DSC must be used. Desktops and laptops may have different compatibilities for daisy chaining monitors. Please check the manufacturer of your graphics card or computer for DSC support.

# USB Connection

The monitor supports two types of USB ports, upstream and downstream. When making connection(s), observe the following guidelines.

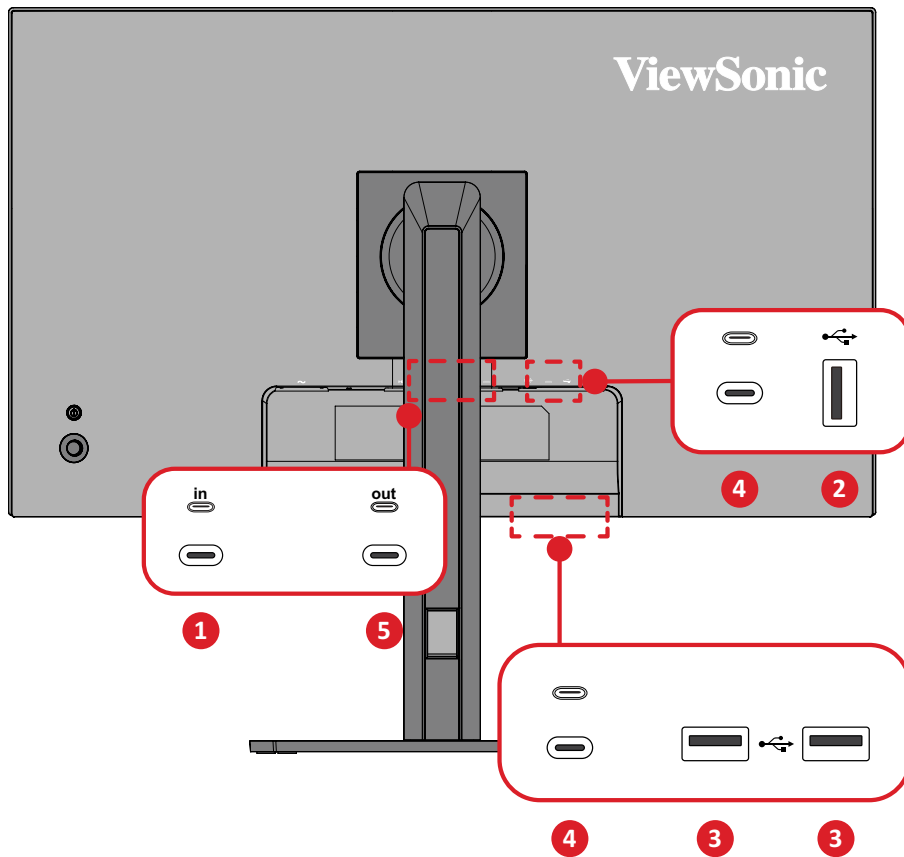

USB Type	Connection Type	Description	
1	Upstream	Type C	Full-featured port: transfers data, audio, video, and power.
			Supports: 5V/3A, 9V/3A, 10V/3A, 12V/3A, 15V/3A, 20V/4.9A (LPS) charging.
2	Downstream	Type A	For peripheral device(s) (e.g., storage device, keyboard, mouse, etc.).
			Supports 5V/900mA charging.
			For peripheral device(s) (e.g., storage device, keyboard, mouse, etc.).
			Supports 5V/1.5A charging and BC 1.2.
4	Downstream	Type C	For peripheral device(s) (e.g., storage device, keyboard, mouse, etc.).
			Supports 5V/3A.
5	Downstream	Type C	For peripheral device(s) (e.g., storage device, keyboard, mouse, etc.) or MST Daisy Chain Function.
			Supports 5V/900mA charging.

## Using the USB Ports

1. To use the downstream USB ports, connect one end of a USB Type C cable to the rear upstream USB Type C ( **1** ) port of the monitor. Plug the other end of the cable into a USB port of your computer.
2. Connect your peripheral device to a downstream USB port (Type A ( **2** or **3** ) or Type C ( **4** or **5** )) of the monitor.

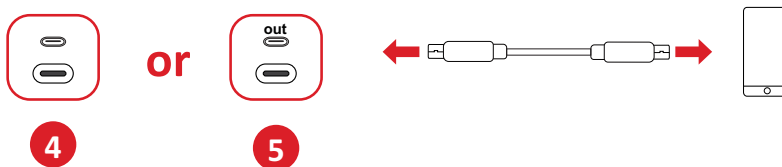
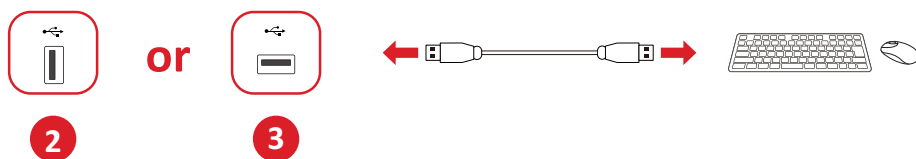
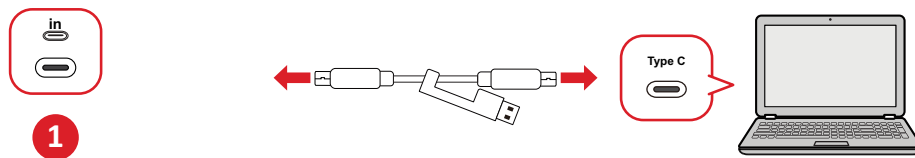
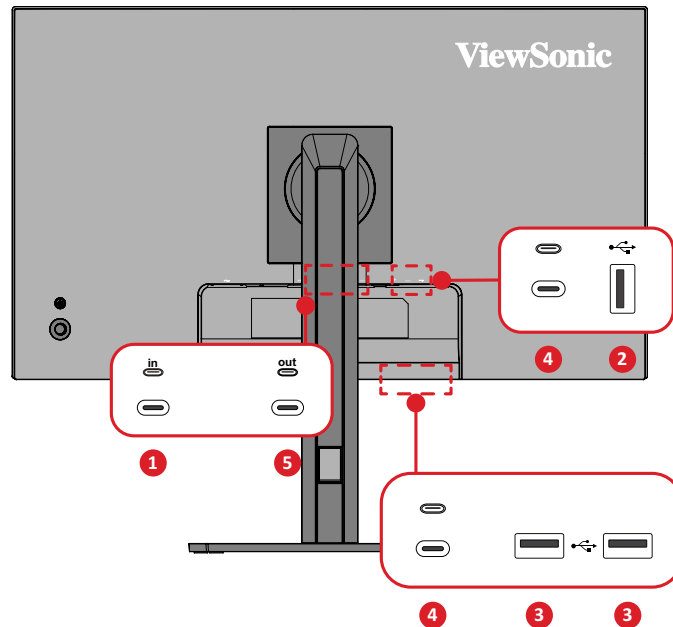

**NOTE:** If you are required to connect through either HDMI or DisplayPort, please also use a USB Type C to USB Type A cable to connect to the monitor to enable data transfer.

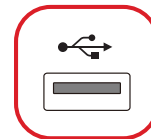
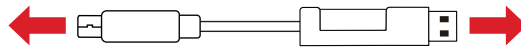
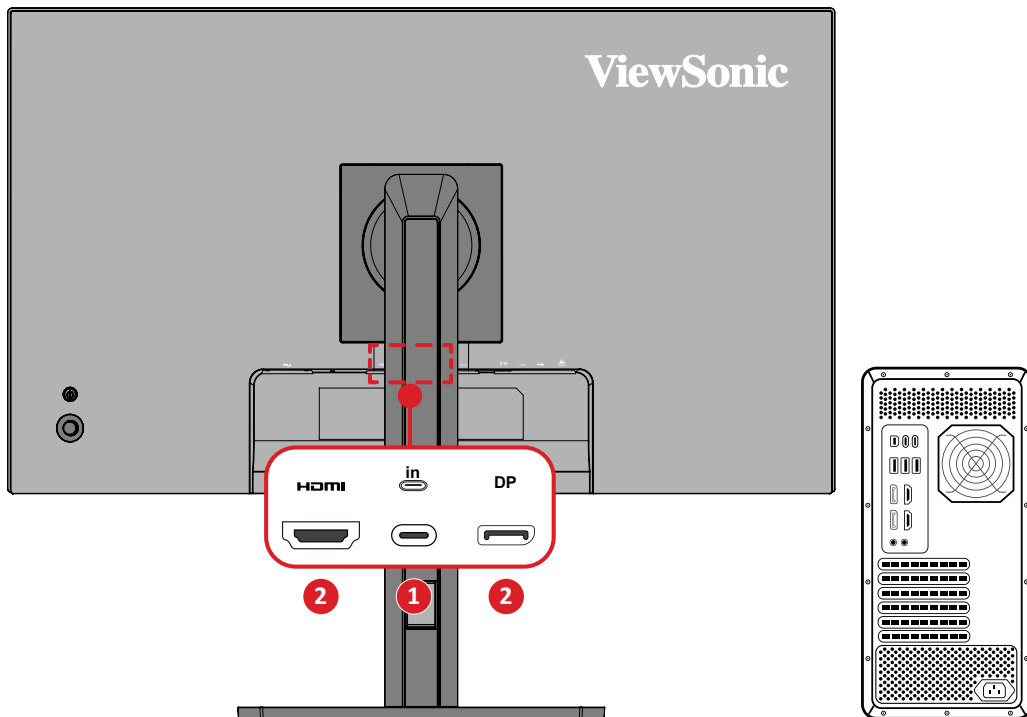

2

or

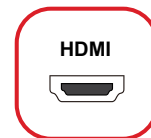

# Ethernet Connection

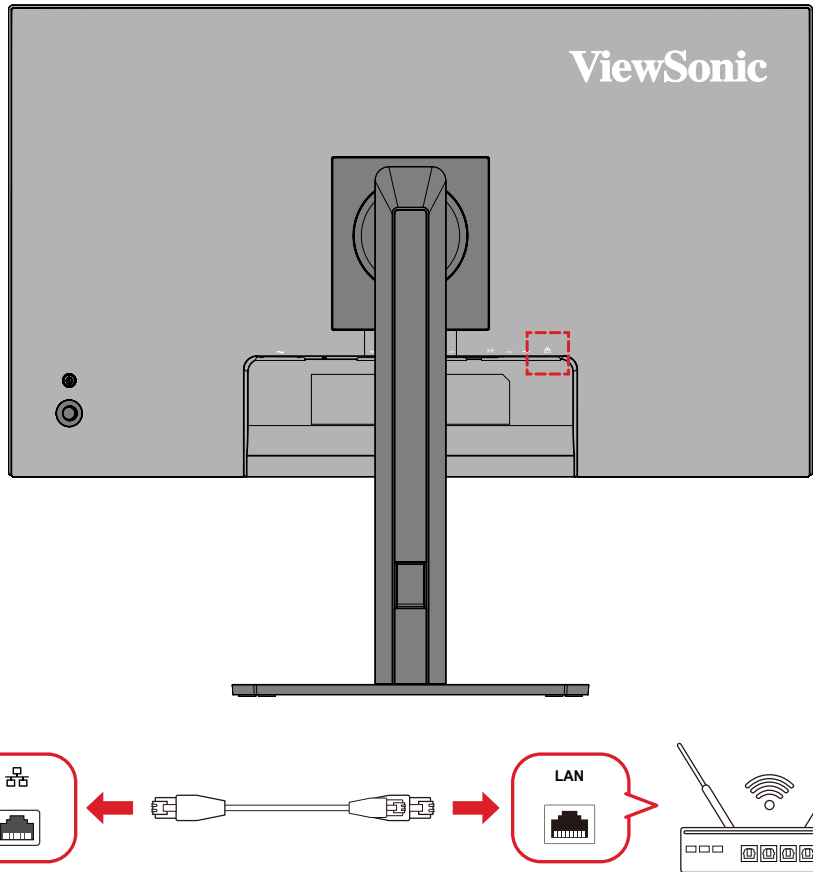

1. Connect one end of your LAN (RJ45) cable to the LAN (RJ45) port of the monitor.

**NOTE:** Please make sure your computer is also connected to the monitor by the rear upstream USB Type C port of the monitor. See page 21 for more information.

2. Plug the other end into your network modem or port.

## Ethernet Connection When Using USB Type C for Video Input

No further steps are required. If needed, see page 22 for more information.

## Ethernet Connection When Using DisplayPort or HDMI for Video Input

In addition to the DisplayPort or HDMI connection, please also connect your computer to the rear upstream USB Type C port of the monitor to enable data transmission. See page 23 for more information.

## Audio Connection

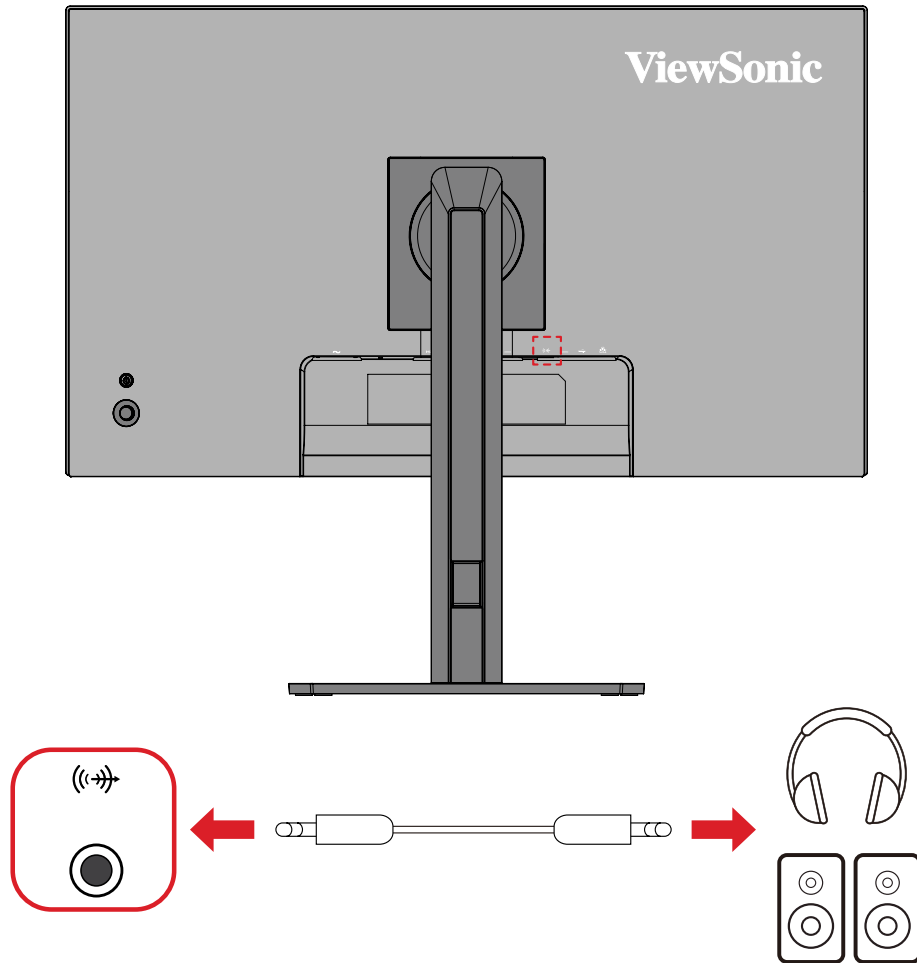

Plug the audio jack of the audio device into the Audio Out port of the monitor. Additionally, you can connect the monitor to a sound bar using an audio cable.

**NOTE:** The monitor is equipped with dual speakers.

# Using the Monitor

## Adjusting the Viewing Angle

### Height Adjustment

Lower or raise the monitor to the desired height (0 to 150 mm).

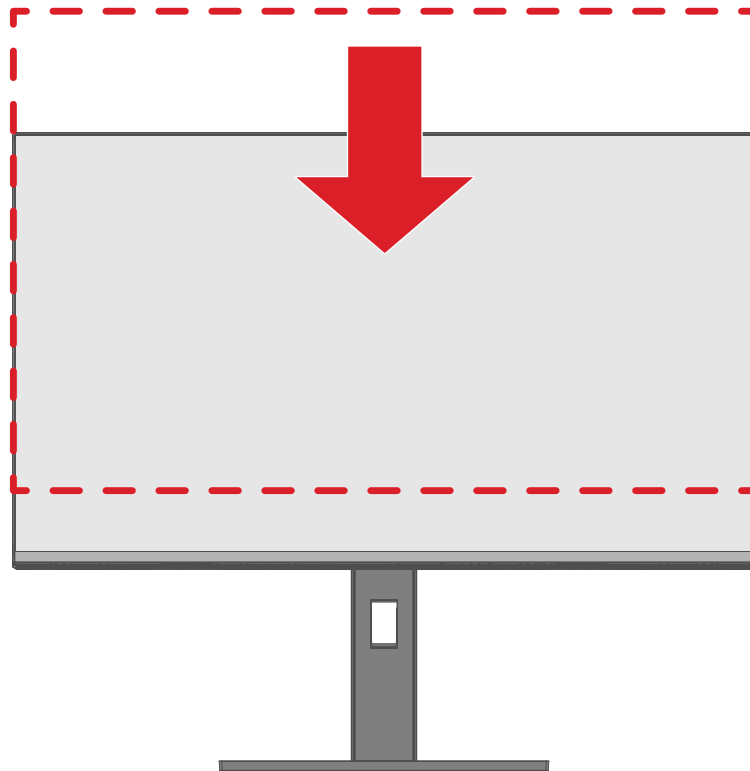

**NOTE:** When adjusting, press down firmly along the adjustment track holding the monitor with both hands on the side.

## Screen Orientation Adjustment (Pivot)

1. Adjust the monitor height to the highest position. Then tilt the monitor backwards to the full tilt position.

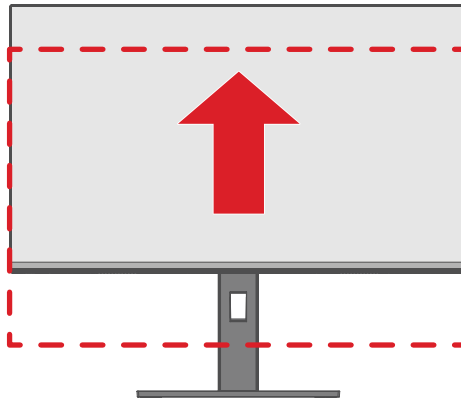

2. Rotate the monitor 90° clockwise or counterclockwise from landscape to portrait orientation.

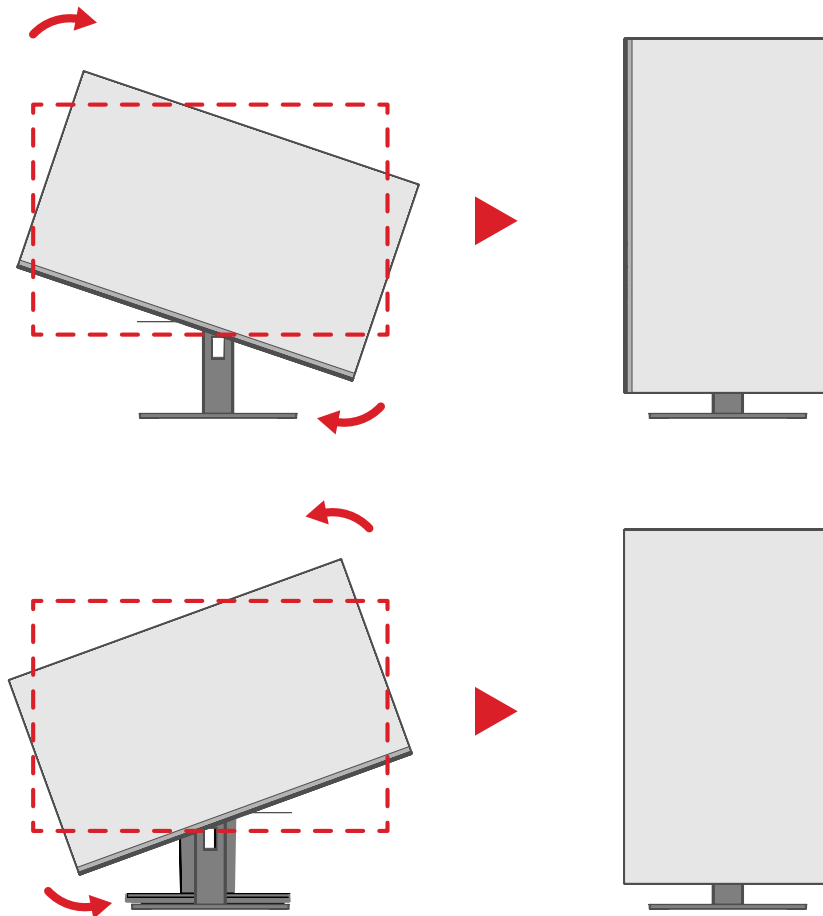

### NOTE:

- To rotate the screen image, manually change the system's display orientation settings.
- When adjusting, make sure to hold both sides of your monitor firmly with both hands.

## Swivel Adjustment

Swivel the monitor to the left or right for the desired viewing angle (45°).

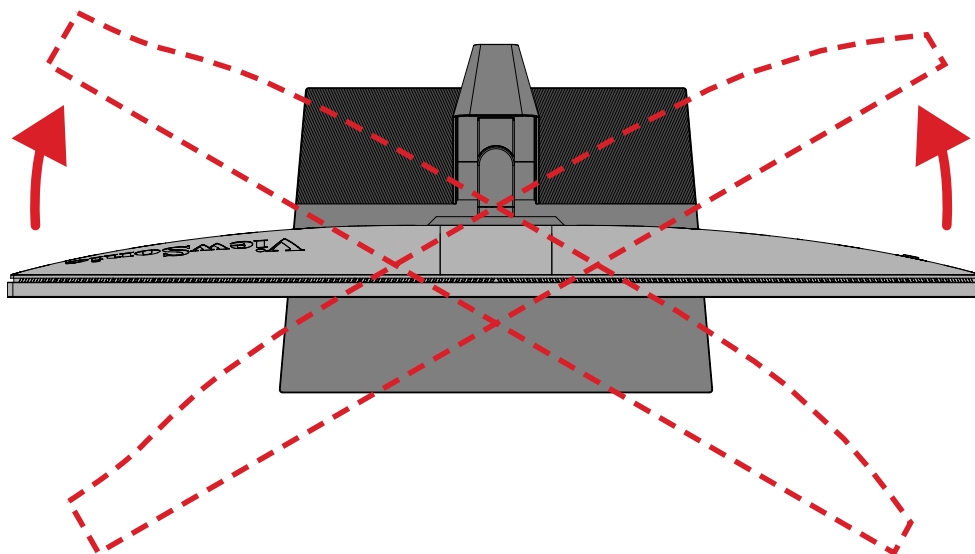

## Tilt Angle Adjustment

Tilt the monitor forwards or backwards to the desired viewing angle (-5° to 30°).

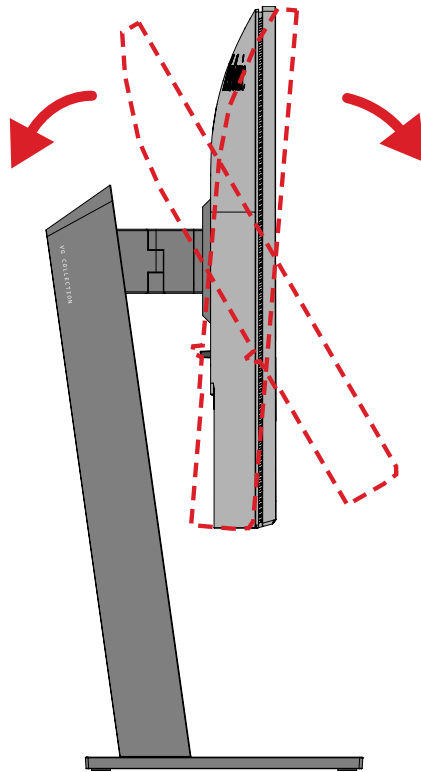

### NOTE:

- When adjusting, support the stand firmly with one hand while tilting the monitor forwards or backwards with the other hand.
- The monitor must be lifted to the highest position, then it can support 30° tilt.

## Turning the Monitor On/Off

1. Plug the power cord into a power outlet.
2. Press the **Power** button to turn on the monitor.
3. To turn the monitor off, press the **Power** button again.

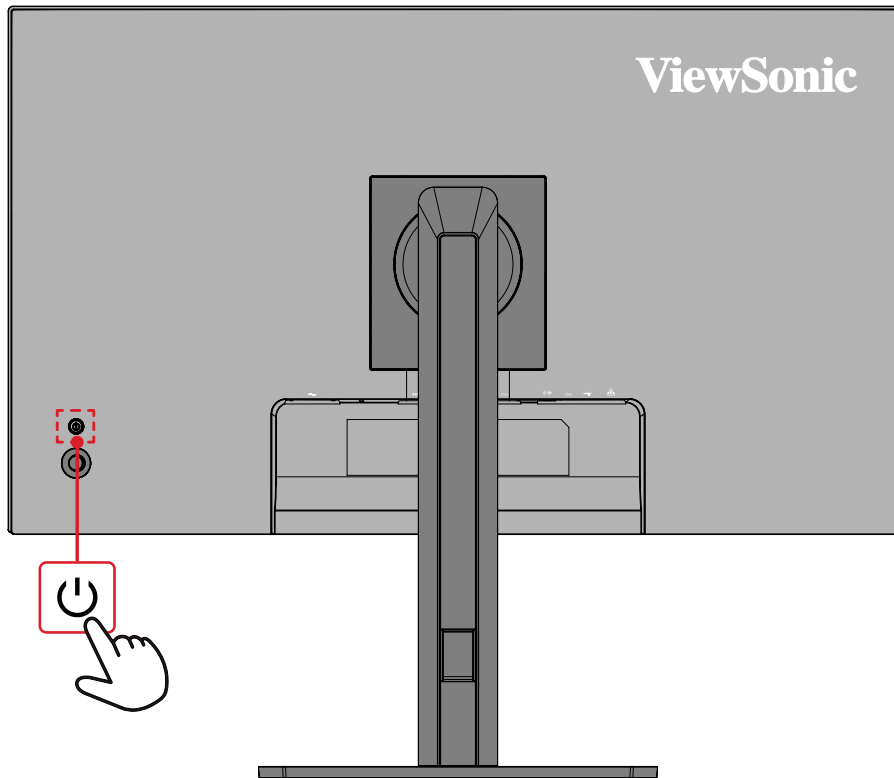

**NOTE:** The monitor will still consume some power as long as the power cord is connected to the power outlet. If the monitor is not being used for a long period of time, please disconnect the power plug from the power outlet.

## Using the Joy Key

Use the **Joy Key** to activate Hot Keys, navigate the On-Screen Display (OSD) Menu, and change the settings.

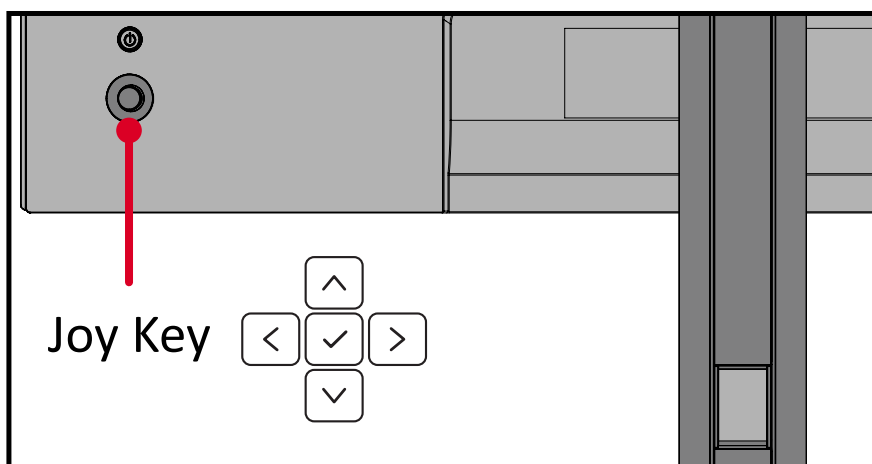

## Quick Menu

Move the **Joy Key**  /  /  /  to activate the Quick Menu.

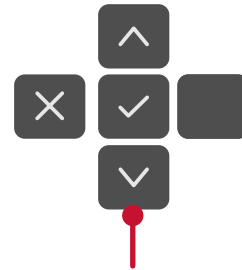
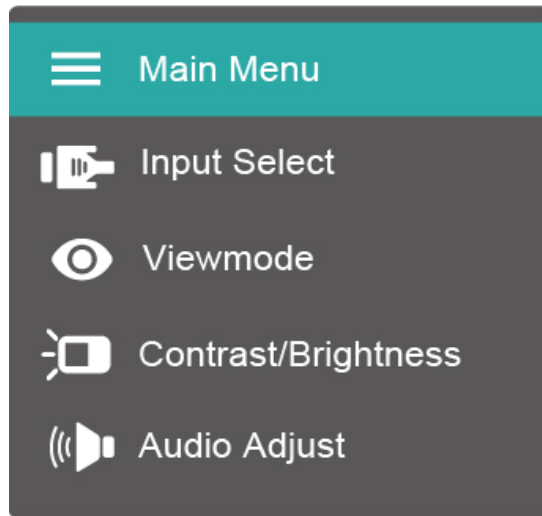

**Key guide**

**NOTE:** Follow the key guide that appears on the screen to select the option or make adjustments.



## Main Menu

Enter the On-Screen Display Menu.

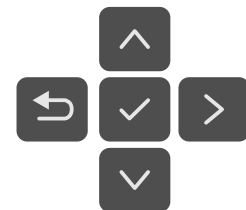
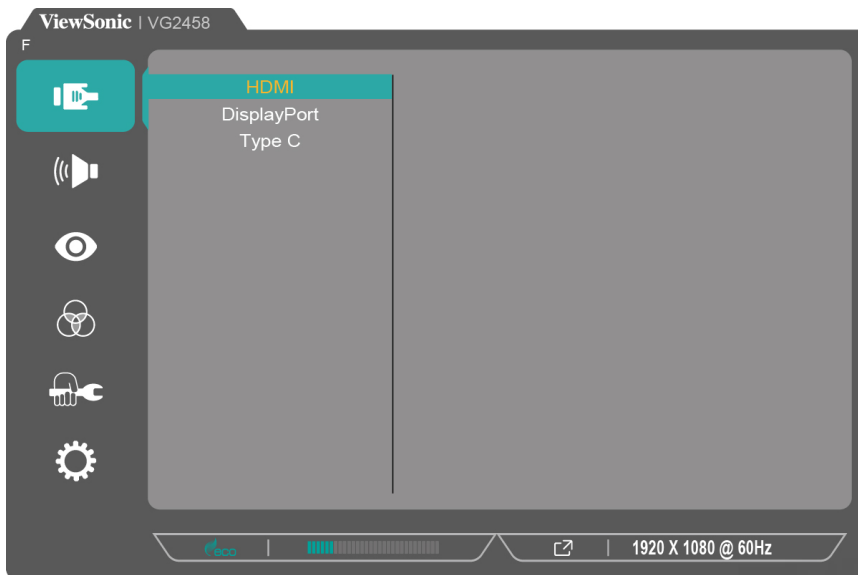



### Input Select

Select the input source.

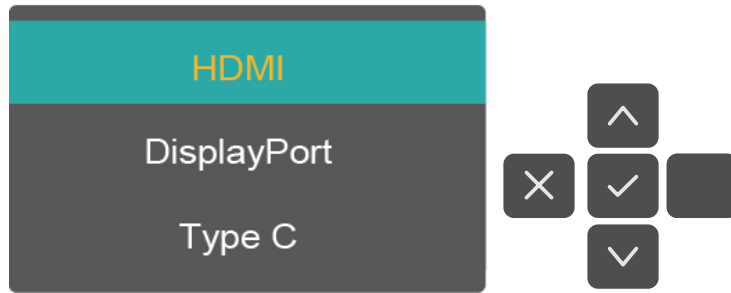

### ViewMode

Select one of the preset color settings.

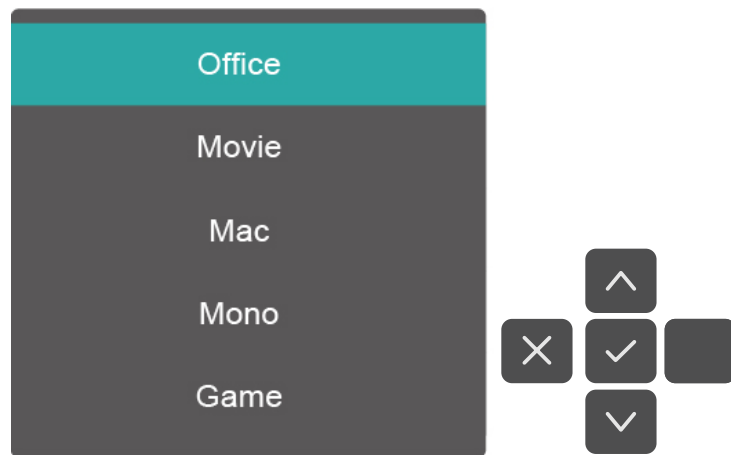

### Contrast/Brightness

Adjust the contrast or brightness level.

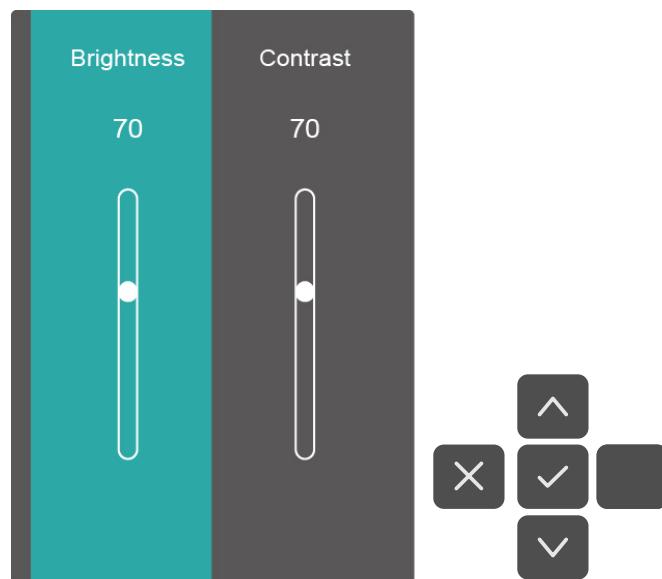



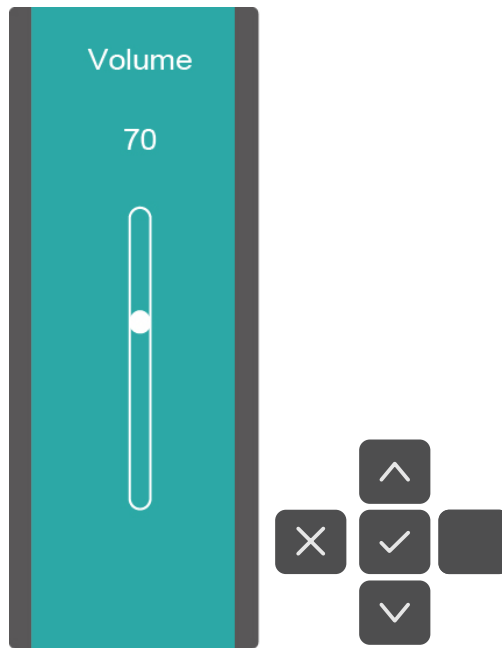

## Audio Adjust

Adjust the level, or mute the volume.



## Hot Keys

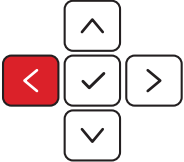

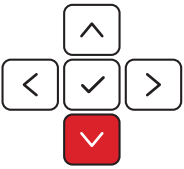
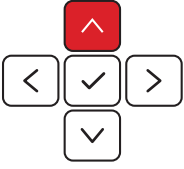

When the On-Screen Display (OSD) Menu is off, you can quickly access special functions by using the **Joy Key**.

Key	Description
	<p>Press and hold the key to lock/unlock the OSD Menu.</p> <p>When the menu appears on the screen, continue holding the key for five seconds to lock/unlock the OSD Menu.</p>  <p>If the OSD Menu is locked, the below message will appear on the screen:</p> 



Key	Description
	<p>Press and hold the key to lock/unlock the <b>Power</b> button.</p> <p>When the menu appears on the screen, continue holding the key for five seconds to lock/unlock the <b>Power</b> button.</p> <div data-bbox="655 349 1142 701" style="border: 1px solid gray; background-color: #333; color: white; padding: 10px; text-align: center;"> <p>Power Lock/Unlock ▼</p> <p>Locking Power Button</p> <p>▬ 5</p> <hr/> <p>Press and hold for 5s to lock OSD</p> </div> <p>If the <b>Power</b> button is locked, the below message will appear on the screen:</p> <div data-bbox="655 831 1142 1182" style="border: 1px solid gray; background-color: #333; color: white; padding: 10px; text-align: center;"> <p>Power Lock/Unlock ▼</p> <p>Power Button Locked</p> </div>
	<p>Press and hold the key to display/hide the boot up screen when the monitor is turned on.</p> <div data-bbox="667 1314 1134 1653" style="border: 1px solid gray; background-color: #333; color: white; padding: 10px; text-align: center;"> <p>Boot Up Screen On/Off ▼</p> <p>Off</p> <hr/> <p>Press to turn on</p> </div>

# Configuring the Settings



## General Operations

1. Move the **Joy Key**  /  /  /  to display the Quick Menu. Then navigate to **Main Menu** and press the **Joy Key**  to display the On-Screen Display (OSD) Menu.





2. Move the **Joy Key**  or  to select the main menu. Then press the **Joy Key**  to enter the selected menu.



3. Move the Joy Key  or  to select the desired menu option. Then press the Joy Key  to enter the sub-menu.



4. Move the Joy Key  or  to adjust/select the setting. Then press the Joy Key  to confirm.

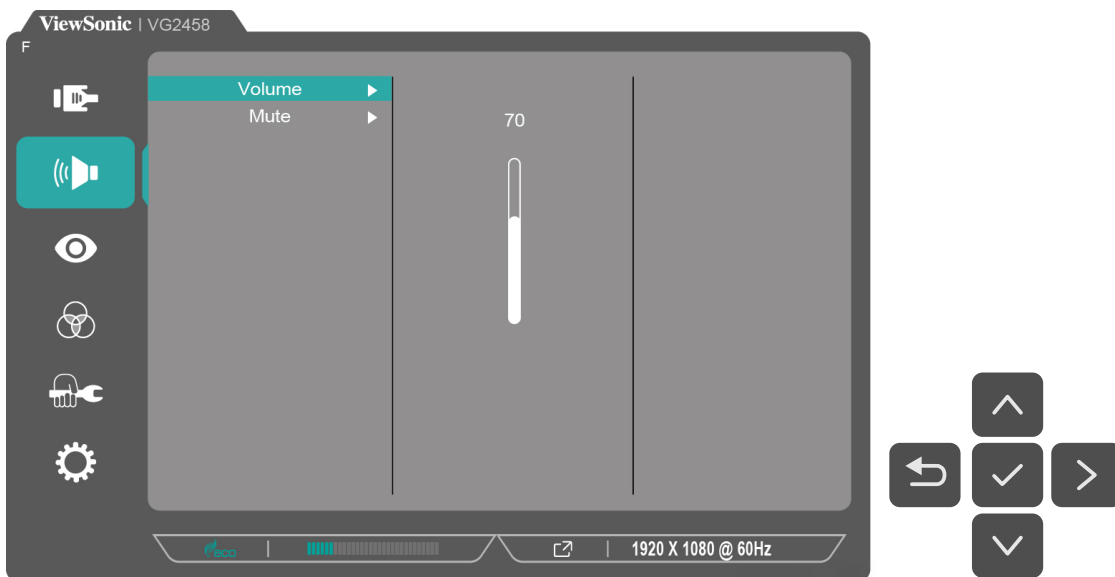

5. Move the Joy Key  to return to the previous menu.

## On-Screen Display (OSD) Menu Tree

Main Menu	Sub-menu	Menu Option	
Input Select	HDMI		
	DisplayPort		
	Type-C		
Audio Adjust	Volume	(-/+ , 0~100)	
	Mute	On	
		Off	

Main Menu	Sub-menu	Menu Option			
ViewMode	Off				
	Office	Web			
		Text			
		CUSTOM 1/2/3	Low Input Lag	On	
				Off	
			Black Stabilization	(-/+ , 0~100)	
			Advanced DCR	(-/+ , 0~100)	
			Response Time	Standard	
				Advanced	
				Ultra Fast	
			Hue	Red	(-/+ , 0~100)
				Green	(-/+ , 0~100)
				Blue	(-/+ , 0~100)
				Cyan	(-/+ , 0~100)
				Magenta	(-/+ , 0~100)
				Yellow	(-/+ , 0~100)
			Saturation	Red	(-/+ , 0~100)
				Green	(-/+ , 0~100)
				Blue	(-/+ , 0~100)
				Cyan	(-/+ , 0~100)
				Magenta	(-/+ , 0~100)
	Yellow	(-/+ , 0~100)			
	Rename				
	Recall				
	Movie				
	MAC				
	Mono				
	Game	FPS 1			
		FPS 2			
		RTS			
MOBA					

Main Menu	Sub-menu	Menu Option		
Color Adjust	Contrast/ Brightness	Contrast	(-/+ , 0~100)	
		Brightness	(-/+ , 0~100)	
	Color Temperature	Bluish		
		Cool		
		Native		
		Warm		
		User Color	Red	(-/+ , 0~100)
	Green		(-/+ , 0~100)	
	Blue		(-/+ , 0~100)	
	Color Space	Auto		
		RGB		
		YUV		
	Color Range	Auto		
		Full Range		
		Limited Range		
	Gamma	1.8		
		2.0		
2.2				
2.4				
2.6				
2.8				
Manual Image Adjust	Sharpness	(-/+ , 0~100)		
	Aspect Ratio	4:3		
		Full Screen		
	Overscan	On		
		Off		

Main Menu	Sub-menu	Menu Option	
Setup Menu	Language Select	English	
		Français	
		Deutsch	
		Español	
		Italiano	
		Suomi	
		Русский	
		Türkçe	
		日本語	
		한국어	
		繁體中文	
		简体中文	
		Česká	
		Svenska	
	Resolution Notice	On	
		Off	
	Information		
	OSD Timeout	(-/+ , 5/15/30/60)	
	OSD Background	On	
		Off	
	OSD Pivot	0°	
		+90°	
-90°			
Power Indicator	On		
	Off		

Main Menu	Sub-menu	Menu Option		
Setup Menu	Auto Power Off	On		
		Off		
	Sleep	30 minutes		
		45 minutes		
		60 minutes		
		120 minutes		
		Off		
	ECO Mode	Standard		
		Optimize		
		Conserve		
		Energy Saving <sup>1</sup>		On
				Off
	DisplayPort Version <sup>2</sup>	1.1 <sup>3</sup>		
		1.2		
		1.4		
	DisplayPort MST	On		
		Off		
		Type C Prioritization		
				High Resolution
	DDC/CI	On		
Off				
Auto Detect	On			
	Off			
All Recall				

1 - This function is ON by default. When the monitor is in Energy Saving mode, the maximum brightness of 350 nits cannot be reached even if the Brightness setting is at 100%. To achieve the full 100% brightness, please turn off this function.

2 - If no DisplayPort connection is detected, this menu option will be grayed out.

3 - DisplayPort 1.1 does not support Multi-Stream (MST) Transport.

## Menu Options

### Input Select

1. Move the **Joy Key**  /  /  /  to display the Quick Menu. Then navigate to **Main Menu** and press the **Joy Key**  to display the On-Screen Display (OSD) Menu.
2. Move the **Joy Key**  or  to select **Input Select** . Then press the **Joy Key**  to enter the **Input Select** menu.



3. Move the **Joy Key**  or  to select the desired input source. Then press the **Joy Key**  to confirm the selection.

## Audio Adjust

1. Move the **Joy Key**  /  /  /  to display the Quick Menu. Then navigate to **Main Menu** and press the **Joy Key**  to display the OSD Menu.
2. Move the **Joy Key**  or  to select **Audio Adjust**. Then press the **Joy Key**  to enter the **Audio Adjust** menu.

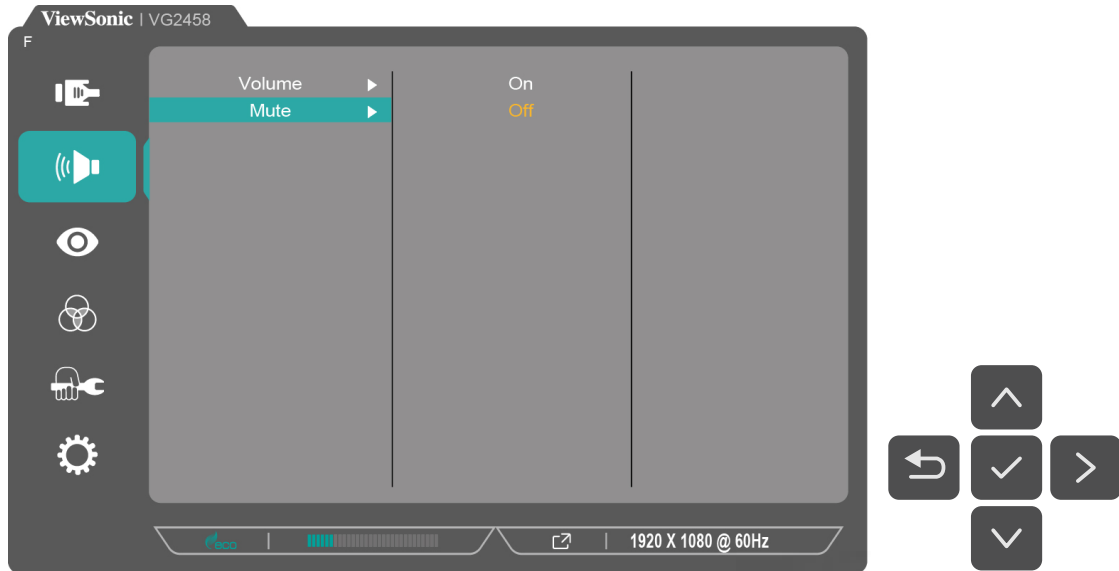

3. Move the **Joy Key**  or  to select the desired menu option. Then press the **Joy Key**  to enter its sub-menu.
4. Move the **Joy Key**  or  to adjust/select the setting. Then press the **Joy Key**  to confirm the selection (if applicable).

Menu Option	Description
Volume	Adjust the monitor's sound level.
Mute	Mute/unmute the monitor's sound.

## ViewMode

1. Move the **Joy Key**  /  /  /  to display the Quick Menu. Then navigate to **Main Menu** and press the **Joy Key**  to display the OSD Menu.
2. Move the **Joy Key**  or  to select **ViewMode**. Then press the **Joy Key**  to enter the **ViewMode** menu.



3. Move the **Joy Key**  or  to select the desired menu option. Then press the **Joy Key**  to enter its sub-menu.
4. Move the **Joy Key**  or  to adjust/select the setting. Then press the **Joy Key**  to confirm the selection (if applicable).

**NOTE:** Some sub-menu options may have another sub-menu. To enter the respective sub-menu, press the **Joy Key** . Follow the key guide that appears on the screen to select the option or make adjustments.

Menu Option	Description
Off	Disable the function.
Office	Select this option for office applications.
Movie	Select this option for watching movies.
MAC	Select this option when connecting the monitor to Mac computers.
Mono	Select this option for monochrome.
Game	Select this option for playing games.

## Color Adjust

**NOTE:** Some sub-menus may not be adjustable depending on the user's custom settings.

1. Move the **Joy Key**  /  /  /  to display the Quick Menu. Then navigate to **Main Menu** and press the **Joy Key**  to display the OSD Menu.
2. Move the **Joy Key**  or  to select **Color Adjust**. Then press the **Joy Key**  to enter the **Color Adjust** menu.



3. Move the **Joy Key**  or  to select the desired menu option. Then press the **Joy Key**  to enter its sub-menu.
4. Move the **Joy Key**  or  to adjust/select the setting. Then press the **Joy Key**  to confirm the selection (if applicable).

**NOTE:** Some sub-menu options may have another sub-menu. To enter the respective sub-menu, press the **Joy Key** . Follow the key guide that appears on the screen to select the option or make adjustments.

Menu Option	Description
Contrast/ Brightness	<u>Contrast</u> Adjust the degree of difference between the lightest and darkest parts of the picture and change the amount of black and white in the image.
	<u>Brightness</u> Adjust the background black levels of the screen image.
Color Temperature	Select the color temperature setting. <ul style="list-style-type: none"> <li>• Bluish: Set the color temperature to 9300K.</li> <li>• Cool: Set the color temperature to 7500K.</li> <li>• Native: Default color temperature. Recommended for regular use.</li> <li>• Warm: Set the color temperature to 5000K.</li> <li>• User Color: Adjust red, green, and blue values as desired.</li> </ul>
Color Space	Allows users to choose which color space they would like to use for monitor color output. <ul style="list-style-type: none"> <li>• Auto: Automatically recognizes the color format and black and white levels.</li> <li>• RGB: The input signal color format is RGB.</li> <li>• YUV: The input signal color format is YUV.</li> </ul>
Color Range	The monitor can detect the input signal color range automatically. You can manually change the color range options to fit the correct color range if the colors are not displayed correctly. <ul style="list-style-type: none"> <li>• Auto: Automatically recognizes the color format and black and white levels.</li> <li>• Full Range: Black and white levels are full.</li> <li>• Limited Range: Black and white levels are limited.</li> </ul>
Gamma	Manually adjust the brightness level of the monitor's grayscale levels.

## Manual Image Adjust









1. Move the **Joy Key**  /  /  /  to display the Quick Menu. Then navigate to **Main Menu** and press the **Joy Key**  to display the OSD Menu.
2. Move the **Joy Key**  or  to select **Manual Image Adjust**. Then press the **Joy Key**  to enter the **Manual Image Adjust** menu.







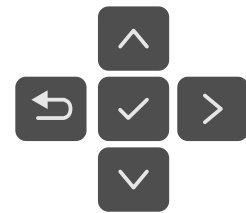
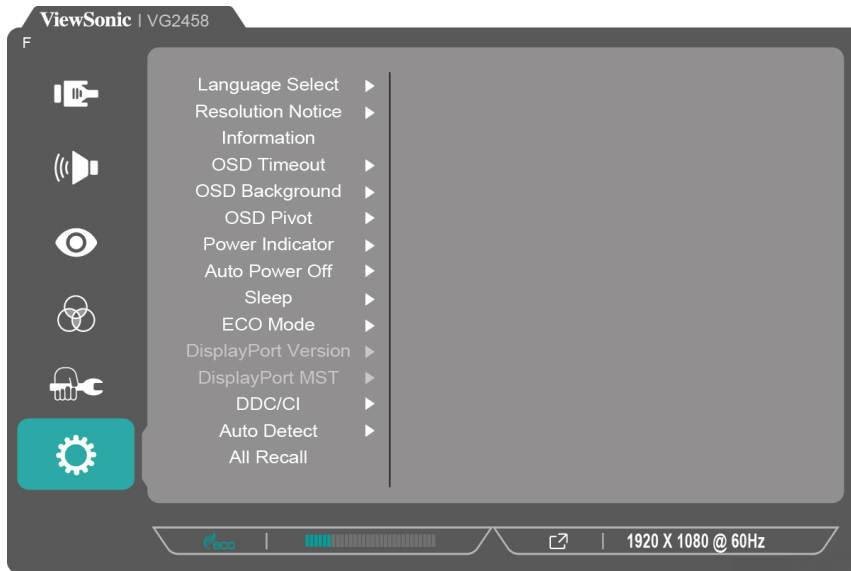

3. Move the **Joy Key**  or  to select the desired menu option. Then press the **Joy Key**  to enter its sub-menu.
4. Press the **Joy Key**  or  to adjust/select the setting. Then press the **Joy Key**  to confirm the selection (if applicable).

Menu Option	Description
Sharpness	Adjust the sharpness and picture quality of the monitor.
Aspect Ratio	Select the aspect ratio of the monitor.
Overscan	Enable this option to automatically enlarge the original picture horizontally and vertically to an equal aspect ratio that fills the screen.

## Setup Menu

1. Move the **Joy Key**  /  /  /  to display the Quick Menu. Then navigate to **Main Menu** and press the **Joy Key**  to display the OSD Menu.
2. Move the **Joy Key**  or  to select **Setup Menu**. Then press the **Joy Key**  to enter the **Setup Menu** menu.



3. Move the **Joy Key**  or  to select the desired menu option. Then press the **Joy Key**  to enter its sub-menu.
4. Press the **Joy Key**  or  to adjust/select the setting. Then press the **Joy Key**  to confirm the selection (if applicable).

**NOTE:** Some sub-menu options may have another sub-menu. To enter the respective sub-menu, press the **Joy Key** . Follow the key guide that appears on the screen to select the option or make adjustments.

Menu Option	Description
Language Select	Select an available language for the OSD Menu.
Resolution Notice	Enable this option to allow the system to inform users that the current viewing resolution is not the correct native resolution.
Information	Display the monitor information.
OSD Timeout	Set the length of time the OSD Menu remains on the screen.
OSD Background	Show/Hide the OSD background when the OSD Menu appears on the screen.
OSD Pivot	Set the OSD Menu orientation. <ul style="list-style-type: none"> <li>• 0°: Sets the OSD Menu without a pivot.</li> <li>• +90°: Sets the OSD Menu with a +90° pivot.</li> <li>• -90°: Sets the OSD Menu with a -90° pivot.</li> </ul>
Power Indicator	Set the power indicator on or off. If the setting is set to <b>On</b> , the power indicator lights blue when the monitor is turned on.
Auto Power Off	Enable this option to allow the monitor to automatically turn off after a certain amount of time.
Sleep	Set the amount of idle time before the monitor enters <i>Sleep mode</i> .
ECO Mode	Choose between various modes, based on power consumption.
DisplayPort Version	If the connected monitor does not support DisplayPort 1.4, the DisplayPort version can be changed to 1.1 or 1.2.
DisplayPort MST	When using the USB Type C port for DisplayPort Multi-Stream Transport (MST), you can choose to prioritize “High Data Speed” or “High Resolution” data transfer.
DDC/CI	Enable this option to allow the monitor control via the graphics card.
Auto Detect	Automatically detect the input signal.
All Recall	Resets all settings to their default values.

# Appendix

## Specifications

Item	Category	Specifications
LCD	Type	a-Si TFT Active Maxtix, 2560 x 1440 LCD 0.2331 (H)mm x 0.2331 (V)mm pixel pitch
	Display Size	68.58 cm
		27" viewable
	Color Filter	RGB vertical stripe
Glass Surface	Anti-Glare (Haze 25%), Hard Coating (3H)	
Input Signal	Video Sync	<u>TMDS digital (100 Ω)</u> DisplayPort: $f_h$ :30~151 kHz, $f_v$ :50~100 Hz HDMI: $f_h$ :30~151 kHz, $f_v$ :50~100 Hz Type C: $f_h$ :30~151 kHz, $f_v$ :50~100 Hz
Compatibility	PC	up to 2560 x 1440
	Macintosh	up to 2560 x 1440

Item	Category	Specifications
Resolution <sup>1</sup>	Recommended	2560 x 1440 @ 60 Hz
	Supported	<ul style="list-style-type: none"> <li>• 2560 x 1440 @ 60, 75, 100 Hz</li> <li>• 1920 x 1080 @ 50, 60, 100 Hz</li> <li>• 1680 x 1050 @ 60 Hz</li> <li>• 1600 x 1200 @ 60 Hz</li> <li>• 1600 x 900 @ 60 Hz</li> <li>• 1440 x 900 @ 60, 75 Hz</li> <li>• 1440 x 576 @ 50 Hz</li> <li>• 1400 x 1050 @ 60, 75 Hz</li> <li>• 1366 x 768 @ 60 Hz</li> <li>• 1360 x 768 @ 60 Hz</li> <li>• 1280 x 1024 @ 50, 60, 75 Hz</li> <li>• 1280 x 960 @ 50, 60, 75 Hz</li> <li>• 1280 x 800 @ 60, 75 Hz</li> <li>• 1280 x 768 @ 50, 60, 75 Hz</li> <li>• 1280 x 720 @ 50, 60 Hz</li> <li>• 1152 x 900 @ 66 Hz</li> <li>• 1152 x 870 @ 75 Hz</li> <li>• 1152 x 864 @ 60, 75 Hz</li> <li>• 1024 x 768 @ 50, 60, 70, 72, 75 Hz</li> <li>• 1024 x 600 @ 60 Hz</li> <li>• 848 x 480 @ 60 Hz</li> <li>• 832 x 624 @ 75 Hz</li> <li>• 800 x 600 @ 56, 60, 72, 75 Hz</li> <li>• 720 x 576 @ 50 Hz</li> <li>• 720 x 480 @ 60 Hz</li> <li>• 720 x 400 @ 70 Hz</li> <li>• 640 x 480 @ 50, 60, 66, 72, 75 Hz</li> <li>• 640 x 400 @ 60, 70 Hz</li> <li>• 640 x 350 @ 70 Hz</li> </ul>
Power <sup>2</sup>	Input Voltage	AC 100-240 V, 50/60 Hz 3A
Display area	Active Size (H x V)	596.74 x 335.66 mm
		23.49" x 13.22"
Operating Conditions	Altitude	4.9 km
		16,404 ft
	Relative Humidity	20% to 90% (non-condensing)
	Temperature	0° C to 40° C
32° F to 104° F		

1 - Do not set the graphics card in your computer to exceed these timing modes; doing so may result in permanent damage to the display.

2 - Please use the power adapter from ViewSonic® or an authorized source only.

Item	Category	Specifications
Storage Conditions	Altitude	12.1 km
		40,000 ft
	Humidity	5% to 90% (non-condensing)
	Temperature	-20° C to 60° C
-4° F to 140° F		
Dimensions (with stand)	Physical (W x H x D)	612.60 x 525.64 x 218.47 mm
		24.12" x 20.69" x 8.60"
Wall Mount	Dimensions	100 x 100 mm
Weight (with stand)	Physical	7.42 kg
		16.36 lb
Power Consumption	On <sup>3</sup>	200W (Typical)
	Off	< 0.3W (Maximum)
	Standby/Sleep	< 0.5W

**HDMI**™ HIGH-DEFINITION MULTIMEDIA INTERFACE The terms HDMI, HDMI High-Definition Multimedia Interface, HDMI trade dress and the HDMI Logos are trademarks or registered trademarks of HDMI Licensing Administrator, Inc.

3 - ECO Mode set to Standard. Power consumption is without audio and with all USB ports loading.

# Glossary

This section describes the standard glossary of terms used in all LCD display models. All terms are listed in alphabetical order.

**NOTE:** Some terms may not be applicable to your monitor.

## **A** **Advanced DCR**

Advanced DCR technology automatically detects the image signal and intelligently controls the backlight brightness and color to improve on the ability to make the black blacker in a dark scene, and make the white whiter in a bright environment.

## **All Recall**

Returns the adjustments back to factory settings if the display is operating in a factory Preset Timing Mode listed in the Specifications of this manual.

**NOTE:** (Exception) This control does not affect changes made with the “Language Select” or “Power Lock setting”.

## **Audio Adjust**

Adjusts the volume, mutes the sound, or toggles between inputs if you have more than one source.

## **Auto Detect**

If the current input source has no signal, the monitor will automatically switch to the next input option. This function, on some models, is disabled by default.

## **Auto Image Adjust**

Automatically sizes, centers, and fine tunes the video signal to eliminate waviness and distortion.

## **B** **Black Stabilization**

ViewSonic’s Black Stabilization provides heightened visibility and detail by brightening dark scenes.

## **Brightness**

Adjusts background black levels of the screen image.

## C Color Adjust

Provides several color adjustment modes, to help adjust the color settings to fit the user's needs.

### Color Range

The monitor can detect the input signal color range automatically. You can manually change the color range options to fit the correct color range if the colors are not displayed correctly.

Options	Description
Auto	The monitor automatically recognizes the color format and black and white levels.
Full Range	The color range of the black and white levels are full.
Limited Range	The color range of the black and white levels are limited.

### Color Space

Allows users to choose which color space they would like to use for monitor color output (RGB, YUV).

### Color Temperature

Allows users to select specific color temperature settings to further customize their viewing experience.

Panel Default	Panel Original Status
sRGB	Standard color space used for the Windows system.
Bluish	Set the color temperature to 9300K.
Cool	Set the color temperature to 7500K.
Native	Default color temperature. Recommended for general use.
Warm	Set the color temperature to 5000K.

### Contrast

Adjusts the difference between the image background (black level) and the foreground (white level).

## F Fine Tune

Improve distorted images caused by an analog signal.

**G Game Mode**  
Integrates a gaming-oriented On-Screen Display (OSD) design, including: pre-calibrated FPS, RTS, and MOBA gaming settings. Each mode is functionally customized with in-game testing and adjustments made for the best blend of color and technology.

**Gamma**

Allows users to manually adjust the brightness level of the monitor's grayscale levels. There are six selections: 1.8, 2.0, 2.2, 2.4, 2.6 and 2.8.

**H H./V. Position**

Manually adjust the screen image horizontally and/or vertically.

**Horizontal Size**

Manually stretch or shorten the screen image on its horizontal axis.

**Hue**

Adjusts the tint of each color (red, green, blue, cyan, magenta, and yellow).

**I Information**

Displays the timing mode (video signal input) coming from the graphics card in the computer, the LCD model number, the serial number, and the ViewSonic® website URL. See your graphics cards's user guide for instructions on changing the resolution and refresh rate (vertical frequency).

**NOTE:** VESA 1024 x 768 @ 60Hz, for example, means that the resolution is 1024 x 768 and the refresh rate is 60Hz.

**Input Select**

Toggles between the various input options that are available for the monitor.

**L Low Input Lag**

ViewSonic® offers low input lag, utilizing a monitor process reducer, which decreases signal latency. Under the "Low Input Lag" sub-menu, you can select the appropriate speed for your desired use from the two options.

## **M** Manual Image Adjust

Displays the “Manual Image Adjust” menu. You can manually set a variety of image quality adjustments.

### **Memory Recall**

Returns the adjustments back to factory settings if the display is operating in a factory preset timing mode listed in the “Specifications” of this manual.

#### **NOTE:**

- (Exception) This control does not affect changes made in the “Language Select” or “Power Lock” setting.
- Memory Recall is the default as-shipped display configuration and settings. Memory Recall is the setting in which the product qualifies for ENERGY STAR®. Any changes to default as-shipped display configuration and settings would change the energy consumption, and may increase energy consumption beyond the limits required for ENERGY STAR® qualification, as applicable. ENERGY STAR® is a set of power-saving guidelines issued by the U.S. Environmental Protection Agency (EPA). ENERGY STAR® is a joint program of the U.S. Environmental Protection Agency and the U.S. Department of Energy helping us all save money and protect the environment through energy efficient products and practices.



## **O** OSD Pivot

Sets the monitor’s On-Screen Display (OSD) Menu display direction.

<b>Options</b>	<b>Description</b>
0°	Sets the OSD Menu without a pivot.
+90°	Sets the OSD Menu with a +90° pivot.
-90°	Sets the OSD Menu with a -90° pivot.

### **Overscan**

Refers to a cropped image on your monitor’s screen. A setting on your monitor zooms in on movie content, so that you cannot see the outermost edges of the film.

**R** **Recall**  
Resets the ViewMode monitor settings.

**Resolution Notice**

The notice tells users that the current viewing resolution is not the correct native resolution. This notice will appear in the display settings window when setting up the display resolution.

**Response Time**

Adjusts the response time, creating smooth images without streaking, blurring, or ghosting. A low response time is perfect for the most graphic-intensive gaming, and provides amazing visual quality while watching sports or action movies.

**RGB Color Space**

The most common color space for displays. Red, green, and blue light are added together to reproduce a broad array of colors.

**S** **Saturation**

Adjusts the color depth of each color (red, green, blue, cyan, magenta, and yellow).

**Setup Menu**

Adjusts On-Screen Display (OSD) Menu settings. Many of these settings can activate on-screen display notifications so users do not have to reopen the menu.

**Sharpness**

Adjusts the picture quality of the monitor.

**V** **ViewMode**

ViewSonic's unique ViewMode feature offers "Game", "Movie", "Web", "Text", "MAC", and "Mono" presets. These presets are specifically designed to deliver an optimized viewing experience for different screen applications.

**Y** **YUV Color Space**

YUV color space is used for color image and video processing; taking into account properties of the human eye that allow for reduced bandwidth of chroma components without perceptual distortion.

# Troubleshooting

This section describes some common problems that you may experience when using the monitor.

Problem or Issue	Possible Solutions
No power	<ul style="list-style-type: none"><li>• Make sure you have turned on the monitor by pressing the <b>Power</b> button.</li><li>• Make sure the power cord is properly and securely connected to the monitor and power outlet.</li><li>• Plug another electrical device into the power outlet to verify that the outlet is supplying power.</li></ul>
Power is On, but no image appears on screen	<ul style="list-style-type: none"><li>• Make sure the video cable connecting the monitor to the computer is properly and securely connected.</li><li>• Adjust the brightness and contrast settings.</li><li>• Make sure the correct input source is selected.</li></ul>
Wrong or abnormal colors	<ul style="list-style-type: none"><li>• If any colors (red, green, or blue) are missing, check the video cable to make sure it is properly and securely connected. Loose or broken pins in the cable connector could cause an improper connection.</li><li>• Connect the monitor to another computer.</li></ul>
Screen image is too light or dark	<ul style="list-style-type: none"><li>• Adjust brightness and contrast settings via the OSD Menu.</li><li>• Reset the monitor to factory settings.</li></ul>
Screen image cuts in and out	<ul style="list-style-type: none"><li>• Make sure the correct input source is selected.</li><li>• Check for bent or broken pins in the video cable connector.</li><li>• Make sure the video cable connecting the monitor to the computer is properly and securely connected.</li></ul>
Screen image is blurred	<ul style="list-style-type: none"><li>• Adjust the resolution to the correct Aspect Ratio.</li><li>• Reset the monitor to factory settings.</li></ul>
The screen isn't centered correctly	<ul style="list-style-type: none"><li>• Adjust the horizontal and vertical controls via the OSD Menu.</li><li>• Check the Aspect Ratio.</li><li>• Reset the monitor to factory settings.</li></ul>

Problem or Issue	Possible Solutions
The OSD Menu does not appear on the screen/the OSD controls are inaccessible	<ul style="list-style-type: none"> <li>• Check whether the OSD Menu is locked.</li> <li>• Turn off the monitor, unplug the power cord, plug it back in, and then turn on the monitor.</li> <li>• Reset the monitor to factory settings.</li> </ul>
Control panel keys do not work	<ul style="list-style-type: none"> <li>• Press only one key at a time.</li> <li>• Restart the computer.</li> </ul>
Some menus aren't selectable in the OSD	<ul style="list-style-type: none"> <li>• Adjust the ViewMode or the input source.</li> <li>• Reset the monitor to factory settings.</li> </ul>
No audio output	<ul style="list-style-type: none"> <li>• If using ear-/headphones, ensure the mini stereo jack is connected.</li> <li>• Make sure the volume is not muted, nor set to 0.</li> <li>• Check the Audio Input setting.</li> </ul>
The monitor will not adjust	<ul style="list-style-type: none"> <li>• Make sure there are no obstructions near or on the monitor, and that there is adequate spacing.</li> <li>• For more information, see "Adjusting the Viewing Angle".</li> </ul>
USB devices connected to the monitor do not work	<ul style="list-style-type: none"> <li>• Make sure the USB cable is connected properly.</li> <li>• Try changing to another USB port (if applicable).</li> <li>• Some USB devices require a higher electric current; connect the device directly to the computer.</li> </ul>
The external device is connected, but no image appears on the screen	<ul style="list-style-type: none"> <li>• Make sure the Power is On</li> <li>• Adjust brightness and contrast via the OSD Menu.</li> <li>• Check the connecting cable and make sure it is properly and securely connected. Loose or broken pins in the cable connector could cause an improper connection.</li> </ul>

# Maintenance

## General Precautions

- Make sure the monitor is turned off and the power cable is unplugged from the power outlet.
- Never spray or pour any liquid directly onto the screen or case.
- Handle the monitor with care, as a darker-colored monitor, if scuffed, may show marks more clearly than a lighter-colored monitor.

## Cleaning the Screen

- Wipe the screen with a clean, soft, lint-free cloth. This removes dust and other particles.
- If the screen is still not clean, apply a small amount of non-ammonia, non-alcohol based glass cleaner onto a clean, soft, lint-free cloth; then wipe the screen.

## Cleaning the Case

- Use a soft, dry cloth.
- If the case is still not clean, apply a small amount of non-ammonia, non-alcohol based, mild non-abrasive detergent onto a clean, soft, lint-free cloth, then wipe the surface.

## Disclaimer

- ViewSonic® does not recommend the use of any ammonia or alcohol-based cleaners on the display screen or case. Some chemical cleaners have been reported to damage the screen and/or case of the monitor.
- ViewSonic® will not be liable for damage resulting from use of any ammonia or alcohol-based cleaners.

## **Blue Light Filter and Eye Health**

The Blue Light Filter blocks high-energy blue light for a more comfortable viewing experience.

While using and enjoying your monitor please keep the following in mind:

- Viewing computer screens for extended periods of time may cause eye irritation and discomfort. To reduce these effects, it is recommended to take periodic breaks from viewing to allow the eyes to relax.
- The monitor also supports Flicker-Free, which reduces or eliminates screen flicker, thus easing potential eye strain.

### **Calculating Breaks**

When viewing the monitor for extended periods, it is recommended to take periodic breaks from viewing. Short breaks of at least five (5) minutes are recommended after one (1) to two (2) hours of continuous viewing.

Taking shorter, more frequent breaks are generally more beneficial than longer, less frequent breaks.

### **Looking at Distant Objects**

While taking breaks, users can further reduce eye strain and dryness by focusing on objects that are further away from them.

### **Eye and Neck Exercises**

#### Eye Exercises

Eye exercises can help minimize eye strain. Slowly roll your eyes to the left, right, up, and down. Repeat as many times as needed.

#### Neck Exercises

Neck exercises can also help minimize eye strain. Relax your arms and let them hang at your sides, bend forward slightly to stretch the neck, turn your head to the right and to the left. Repeat as many times as needed.

# Product Upgradeability and Repairability

The following is a list of hardware features available for at least 5 years after the sale of the product.	Upgradable	Repairable	Replaceable
Main Processor(s) or SOC	No	No	Yes
Memory	N/A	N/A	N/A
HDD	N/A	N/A	N/A
Wireless Networking Capability	N/A	N/A	N/A
Graphics Card	N/A	N/A	N/A
Rechargeable Battery	N/A	N/A	N/A
Fan Assembly	N/A	N/A	N/A
Camera	N/A	N/A	N/A
Fingerprint Reader	N/A	N/A	N/A
Display Assembly	No	No	Yes
Keyboard	N/A	N/A	N/A
Internal Power Supply	No	No	Yes

**NOTE:** \*N/A = Not applicable for the product.

# Regulatory and Service Information

## Compliance Information

This section addresses all connected requirements and statements regarding regulations. Confirmed corresponding applications shall refer to nameplate labels and relevant markings on the unit.

### FCC Compliance Statement

This device complies with part 15 of FCC Rules. Operation is subject to the following two conditions: (1) this device may not cause harmful interference, and (2) this device must accept any interference received, including interference that may cause undesired operation. This equipment has been tested and found to comply with the limits for a Class B digital device, pursuant to part 15 of the FCC Rules.

These limits are designed to provide reasonable protection against harmful interference in a residential installation. This equipment generates, uses, and can radiate radio frequency energy, and if not installed and used in accordance with the instructions, may cause harmful interference to radio communications. However, there is no guarantee that interference will not occur in a particular installation. If this equipment does cause harmful interference to radio or television reception, which can be determined by turning the equipment off and on, the user is encouraged to try to correct the interference by one or more of the following measures:

- Reorient or relocate the receiving antenna.
- Increase the separation between the equipment and receiver.
- Connect the equipment into an outlet on a circuit different from that to which the receiver is connected.
- Consult the dealer or an experienced radio/TV technician for help.

**Warning:** You are cautioned that changes or modifications not expressly approved by the party responsible for compliance could void your authority to operate the equipment.

### Industry Canada Statement

CAN ICES (B) / NMB (B)

### CE Conformity for European Countries



The device complies with the EMC Directive 2014/30/EU and Low Voltage Directive 2014/35/EU.

## The following information is only for EU-member states:

The mark shown to the right is in compliance with the Waste Electrical and Electronic Equipment Directive 2012/19/EU (WEEE). The mark indicates the requirement NOT to dispose of the equipment as unsorted municipal waste, but use the return and collection systems according to local law.



## Declaration of RoHS2 Compliance

This product has been designed and manufactured in compliance with Directive 2011/65/EU of the European Parliament and the Council on restriction of the use of certain hazardous substances in electrical and electronic equipment (RoHS2 Directive) and is deemed to comply with the maximum concentration values issued by the European Technical Adaptation Committee (TAC) as shown below:

Substance	Proposed Maximum Concentration	Actual Concentration
Lead (Pb)	0.1%	< 0.1%
Mercury (Hg)	0.1%	< 0.1%
Cadmium (Cd)	0.01%	< 0.01%
Hexavalent Chromium (Cr6 <sup>+</sup> )	0.1%	< 0.1%
Polybrominated biphenyls (PBB)	0.1%	< 0.1%
Polybrominated diphenyl ethers (PBDE)	0.1%	< 0.1%
Bis (2-ethylhexyl) phthalate (DEHP)	0.1%	< 0.1%
Butyl benzyl phthalate (BBP)	0.1%	< 0.1%
Dibutyl phthalate (DBP)	0.1%	< 0.1%
Diisobutyl phthalate (DIBP)	0.1%	< 0.1%

**Certain components of products as stated above are exempted under the Annex III of the RoHS2 Directives as noted below. Examples of exempted components are:**

- Copper alloy containing up to 4% lead by weight.
- Lead in high melting temperature type solders (i.e. lead-based alloys containing 85% by weight or more lead).
- Electrical and electronic components containing lead in a glass or ceramic other than dielectric ceramic in capacitors, e.g. piezoelectronic devices, or in a glass or ceramic matrix compound.
- Lead in dielectric ceramic in capacitors for a rated voltage of 125V AC or 250V DC or higher.

## Indian Restriction of Hazardous Substances

Restriction on Hazardous Substances statement (India). This product complies with the “India E-waste Rule 2011” and prohibits use of lead, mercury, hexavalent chromium, polybrominated biphenyls or polybrominated diphenyl ethers in concentrations exceeding 0.1 weight % and 0.01 weight % for cadmium, except for the exemptions set in Schedule 2 of the Rule.

## Product Disposal at End of Product Life

ViewSonic® respects the environment and is committed to working and living green. Thank you for being part of Smarter, Greener Computing. Please visit the ViewSonic® website to learn more.

### USA & Canada:

<https://www.viewsonic.com/us/go-green-with-viewsonic>

### Europe:

<https://www.viewsonic.com/eu/environmental-social-governance/recycle>

### Taiwan:

<https://recycle.moenv.gov.tw/>

**For EU users, please contact us for any safety/accident issue experienced with this product:**

ViewSonic Europe Limited



Haaksbergweg 75  
1101 BR Amsterdam  
Netherlands



+31 (0) 650608655



[EPREL@viewsoniceurope.com](mailto:EPREL@viewsoniceurope.com)



<https://www.viewsonic.com/eu/>

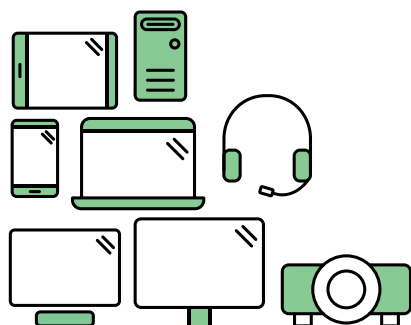

## Say hello to a more sustainable product

IT products are associated with a wide range of sustainability risks throughout their life cycle. Human rights violations are common in the factories. Harmful substances are used both in products and their manufacture. Products can often have a short lifespan because of poor ergonomics, low quality and when they are not able to be repaired or upgraded.

This product is a better choice . It meets all the criteria in TCO Certified, the world's most comprehensive sustainability certification for IT products. Thank you for making a responsible product choice, that help drive progress towards a more sustainable future!

Criteria in TCO Certified have a life-cycle perspective and balance environmental and social responsibility. Conformity is verified by independent and approved verifiers that specialize in IT products, social responsibility or other sustainability issues. Verification is done both before and after the certificate is issued, covering the entire validity period. The process also includes ensuring that corrective actions are implemented in all cases of factory non-conformities. And last but not least, to make sure that the certification and independent verification is accurate, both TCO Certified and the verifiers are reviewed regularly.

### Want to know more?

Read information about TCO Certified, full criteria documents, news and updates at [tcocertified.com](http://tcocertified.com). On the website you'll also find our Product Finder, which presents a complete, searchable listing of certified products.

## Copyright Information

Copyright© ViewSonic® Corporation, 2024. All rights reserved.

Macintosh and Power Macintosh are registered trademarks of Apple Inc.

Microsoft, Windows, and the Windows logo are registered trademarks of Microsoft Corporation in the United States and other countries.

ViewSonic® and the three birds logo are registered trademarks of ViewSonic® Corporation.

VESA is a registered trademark of the Video Electronics Standards Association. DPMS, DisplayPort, and DDC are trademarks of VESA.

**Disclaimer:** ViewSonic® Corporation shall not be liable for technical or editorial errors or omissions contained herein; nor for incidental or consequential damages resulting from furnishing this material, or the performance or use of this product.

In the interest of continuing product improvement, ViewSonic® Corporation reserves the right to change product specifications without notice. Information in this document may change without notice.

No part of this document may be copied, reproduced, or transmitted by any means, for any purpose without prior written permission from ViewSonic® Corporation.

# Customer Service

For technical support or product service, see the table below or contact your reseller.

**NOTE:** You will need the product’s serial number, which is located on the rear of the monitor by the I/O ports.

Country/ Region	Website	Country/ Region	Website
<b>Asia Pacific &amp; Africa</b>			
Australia	<a href="http://www.viewsonic.com/au/">www.viewsonic.com/au/</a>	Bangladesh	<a href="http://www.viewsonic.com/bd/">www.viewsonic.com/bd/</a>
中国 (China)	<a href="http://www.viewsonic.com.cn">www.viewsonic.com.cn</a>	香港 (繁體中文)	<a href="http://www.viewsonic.com/hk/">www.viewsonic.com/hk/</a>
Hong Kong (English)	<a href="http://www.viewsonic.com/hk-en/">www.viewsonic.com/hk-en/</a>	India	<a href="http://www.viewsonic.com/in/">www.viewsonic.com/in/</a>
Indonesia	<a href="http://www.viewsonic.com/id/">www.viewsonic.com/id/</a>	Israel	<a href="http://www.viewsonic.com/il/">www.viewsonic.com/il/</a>
日本 (Japan)	<a href="http://www.viewsonic.com/jp/">www.viewsonic.com/jp/</a>	Korea	<a href="http://www.viewsonic.com/kr/">www.viewsonic.com/kr/</a>
Malaysia	<a href="http://www.viewsonic.com/my/">www.viewsonic.com/my/</a>	Middle East	<a href="http://www.viewsonic.com/me/">www.viewsonic.com/me/</a>
Myanmar	<a href="http://www.viewsonic.com/mm/">www.viewsonic.com/mm/</a>	Nepal	<a href="http://www.viewsonic.com/np/">www.viewsonic.com/np/</a>
New Zealand	<a href="http://www.viewsonic.com/nz/">www.viewsonic.com/nz/</a>	Pakistan	<a href="http://www.viewsonic.com/pk/">www.viewsonic.com/pk/</a>
Philippines	<a href="http://www.viewsonic.com/ph/">www.viewsonic.com/ph/</a>	Singapore	<a href="http://www.viewsonic.com/sg/">www.viewsonic.com/sg/</a>
臺灣 (Taiwan)	<a href="http://www.viewsonic.com/tw/">www.viewsonic.com/tw/</a>	ประเทศไทย	<a href="http://www.viewsonic.com/th/">www.viewsonic.com/th/</a>
Việt Nam	<a href="http://www.viewsonic.com/vn/">www.viewsonic.com/vn/</a>	South Africa & Mauritius	<a href="http://www.viewsonic.com/za/">www.viewsonic.com/za/</a>
<b>Americas</b>			
United States	<a href="http://www.viewsonic.com/us">www.viewsonic.com/us</a>	Canada	<a href="http://www.viewsonic.com/us">www.viewsonic.com/us</a>
Latin America	<a href="http://www.viewsonic.com/la">www.viewsonic.com/la</a>		
<b>Europe</b>			
Europe	<a href="http://www.viewsonic.com/eu/">www.viewsonic.com/eu/</a>	France	<a href="http://www.viewsonic.com/fr/">www.viewsonic.com/fr/</a>
Deutschland	<a href="http://www.viewsonic.com/de/">www.viewsonic.com/de/</a>	Қазақстан	<a href="http://www.viewsonic.com/kz/">www.viewsonic.com/kz/</a>
Россия	<a href="http://www.viewsonic.com/ru/">www.viewsonic.com/ru/</a>	España	<a href="http://www.viewsonic.com/es/">www.viewsonic.com/es/</a>
Türkiye	<a href="http://www.viewsonic.com/tr/">www.viewsonic.com/tr/</a>	Україна	<a href="http://www.viewsonic.com/ua/">www.viewsonic.com/ua/</a>
United Kingdom	<a href="http://www.viewsonic.com/uk/">www.viewsonic.com/uk/</a>		

## Limited Warranty

ViewSonic® Display

### What the warranty covers:

ViewSonic® warrants its products to be free from defects in material and workmanship during the warranty period. If a product proves to be defective in material or workmanship during the warranty period, ViewSonic® will, at its sole option, and as your sole remedy, repair or replace the product with a similar product. Replacement Product or parts may include remanufactured or refurbished parts or components. The repair or replacement unit or parts or components will be covered by the balance of the time remaining on the customer's original limited warranty and the warranty period will not be extended. ViewSonic® provides no warranty for any third-party software whether included with the product or installed by the customer, installation of any unauthorized hardware parts or components (e.g. Projector Lamps). (Please refer to: "What the warranty excludes and does not cover" section).

### How long the warranty is effective:

ViewSonic® displays are warranted for between 1 and 3 years, depending on your country of purchase, for all parts including the light source and for all labor from the date of the first consumer purchase.

### Who the warranty protects:

This warranty is valid only for the first consumer purchaser.

### What the warranty excludes and does not cover:

- Any product on which the serial number has been defaced, modified, or removed.
- Damage, deterioration, or malfunction resulting from:
  - » Accident, misuse, neglect, fire, water, lightning, or other acts of nature, unauthorized product modification, or failure to follow instructions supplied with the product.
  - » Repair or attempted repair by anyone not authorized by ViewSonic®.
  - » Damage to or loss of any programs, data, or removable storage media.
  - » Normal wear and tear.
  - » Removal or installation of the product.
- Software or data loss occurring during repair or replacement.
- Any damage of the product due to shipment.

- Causes external to the product, such as electric power fluctuations or failure.
- Use of supplies or parts not meeting ViewSonic’s specifications.
- Failure of owner to perform periodic product maintenance as stated in the User Guide.
- Any other cause which does not relate to a product defect.
- Damage caused by static (non-moving) images displayed for lengthy periods of time (also referred to as image burn-in).
- Software - Any third-party software included with the product or installed by the customer.
- Hardware/Accessories/Parts/Components – Installation of any unauthorized hardware, accessories, consumable parts or components (e.g. Projector Lamps).
- Damage to, or abuse of, the coating on the surface of the display through inappropriate cleaning as described in the product User Guide.
- Removal, installation, and set-up service charges, including wall-mounting of the product.

**How to get service:**

- For information about receiving service under warranty, contact ViewSonic® Customer Support (Please refer to the “Customer Service” page). You will need to provide your product’s serial number.
- To obtain warranty service, you will be required to provide: (a) the original dated sales slip, (b) your name, (c) your address, (d) a description of the problem, and (e) the serial number of the product.
- Take or ship the product, freight prepaid, in the original container to an authorized ViewSonic® service center or ViewSonic®.
- For additional information or the name of the nearest ViewSonic® service center, contact ViewSonic®.

**Limitation of implied warranties:**

There are no warranties, express or implied, which extend beyond the description contained herein including the implied warranty of merchantability and fitness for a particular purpose.

**Exclusion of damages:**

ViewSonic's liability is limited to the cost of repair or replacement of the product. ViewSonic® shall not be liable for:

- Damage to other property caused by any defects in the product, damages based upon inconvenience, loss of use of the product, loss of time, loss of profits, loss of business opportunity, loss of goodwill, interference with business relationships, or other commercial loss, even if advised of the possibility of such damages.
- Any other damages, whether incidental, consequential or otherwise.
- Any claim against the customer by any other party.
- Repair or attempted repair by anyone not authorized by ViewSonic®.

**Effect of state law:**

This warranty gives you specific legal rights, and you may also have other rights which vary from state to state. Some states do not allow limitations on implied warranties and/or do not allow the exclusion of incidental or consequential damages, so the above limitations and exclusions may not apply to you.

**Sales outside the U.S.A. and Canada:**

For warranty information and service on ViewSonic® products sold outside of the U.S.A. and Canada, contact ViewSonic® or your local ViewSonic® dealer.

The warranty period for this product in mainland China (Hong Kong, Macao, and Taiwan Excluded) is subject to the terms and conditions of the Maintenance Guarantee Card.

For users in Europe and Russia, full details of warranty provided can be found at: <http://www.viewsonic.com/eu/> under "Support/Warranty Information".

# Mexico Limited Warranty

ViewSonic® Display

## What the warranty covers:

ViewSonic® warrants its products to be free from defects in material and workmanship, under normal use, during the warranty period. If a product proves to be defective in material or workmanship during the warranty period, ViewSonic® will, at its sole option, repair or replace the product with a like product. Replacement product or parts may include remanufactured or refurbished parts or components & accessories.

## How long the warranty is effective:

ViewSonic® LCD displays are warranted for between 1 and 3 years, depending on your country of purchase, for all parts including the light source and for all labour from the date of the first consumer purchase.

## Who the warranty protects:

This warranty is valid only for the first consumer purchaser.

## What the warranty excludes and does not cover:

- Any product on which the serial number has been defaced, modified or removed.
- Damage, deterioration, or malfunction resulting from:
  - » Accident, misuse, neglect, fire, water, lightning, or other acts of nature, unauthorized product modification, unauthorized attempted repair, or failure to follow instructions supplied with the product.
  - » Causes external to the product, such as electrical power fluctuations or failure.
  - » Use of supplies or parts not meeting ViewSonic®'s specifications.
  - » Normal wear and tear.
  - » Any other cause which does not relate to a product defect.
- Any product exhibiting a condition commonly known as “image burn-in” which results when a static image is displayed on the product for an extended period of time.
- Removal, installation, insurance, and set-up service charges.

## How to get service:

For information about receiving service under warranty, contact ViewSonic® Customer Support (Please refer to the attached “Customer Service” page). You will need to provide your product’s serial number, so please record the product information in the space provided below on your purchase for your future use. Please retain your receipt of proof of purchase to support your warranty claim.

## For Your Records

Product Name: \_\_\_\_\_ Model Number: \_\_\_\_\_

Document Number: \_\_\_\_\_ Serial Number: \_\_\_\_\_

Purchase Date: \_\_\_\_\_ Extended Warranty Purchase? \_\_\_\_\_ (Y/N)

If so, what date does warranty expire? \_\_\_\_\_

- To obtain warranty service, you will be required to provide (a) the original dated sales slip, (b) your name, (c) your address, (d) a description of the problem, and (e) the serial number of the product.
- Take or ship the product, in the original container packaging, to an authorized ViewSonic® service center.
- Round trip transportation costs for in-warranty products will be paid by ViewSonic®.

## Limitation of implied warranties:

There are no warranties, express or implied, which extend beyond the description contained herein including the implied warranty of merchantability and fitness for a particular purpose.

## Exclusion of damages:

ViewSonic®’s liability is limited to the cost of repair or replacement of the product.

ViewSonic® shall not be liable for:

- Damage to other property caused by any defects in the product, damages based upon inconvenience, loss of use of the product, loss of time, loss of profits, loss of business opportunity, loss of goodwill, interference with business relationships, or other commercial loss, even if advised of the possibility of such damages.
- Any other damages, whether incidental, consequential or otherwise.
- Any claim against the customer by any other party.
- Repair or attempted repair by anyone not authorized by ViewSonic®.

Contact Information for Sales & Authorized Service (Centro Autorizado de Servicio) within Mexico:	
<b>Name, address, of manufacturer and importers:</b> México, Av. de la Palma #8 Piso 2 Despacho 203, Corporativo Interpalmas, Col. San Fernando Huixquilucan, Estado de México Tel: (55) 3605-1099 <a href="http://www.viewsonic.com/la/soporte/index.htm">http://www.viewsonic.com/la/soporte/index.htm</a>	
NÚMERO GRATIS DE ASISTENCIA TÉCNICA PARA TODO MÉXICO: 001.866.823.2004	
<b>Hermosillo:</b> Distribuciones y Servicios Computacionales SA de CV. Calle Juárez 284 local 2 Col. Bugambilias C.P: 83140 Tel: 01-66-22-14-9005 E-Mail: <a href="mailto:disc2@hmo.megared.net.mx">disc2@hmo.megared.net.mx</a>	<b>Villahermosa:</b> Compumantenimientos Garantizados, S.A. de C.V. AV. GREGORIO MENDEZ #1504 COL, FLORIDA C.P. 86040 Tel: 01 (993) 3 52 00 47 / 3522074 / 3 52 20 09 E-Mail: <a href="mailto:compumantenimientos@prodigy.net.mx">compumantenimientos@prodigy.net.mx</a>
<b>Puebla, Pue. (Matriz):</b> RENTA Y DATOS, S.A. DE C.V. Domicilio: 29 SUR 721 COL. LA PAZ 72160 PUEBLA, PUE. Tel: 01(52).222.891.55.77 CON 10 LINEAS E-Mail: <a href="mailto:datos@puebla.megared.net.mx">datos@puebla.megared.net.mx</a>	<b>Veracruz, Ver.:</b> CONEXION Y DESARROLLO, S.A DE C.V. Av. Americas # 419 ENTRE PINZÓN Y ALVARADO Fracc. Reforma C.P. 91919 Tel: 01-22-91-00-31-67 E-Mail: <a href="mailto:gacosta@qplus.com.mx">gacosta@qplus.com.mx</a>
<b>Chihuahua:</b> Soluciones Globales en Computación C. Magisterio # 3321 Col. Magisterial Chihuahua, Chih. Tel: 4136954 E-Mail: <a href="mailto:Cefeo@soluglobales.com">Cefeo@soluglobales.com</a>	<b>Cuernavaca:</b> Compusupport de Cuernavaca SA de CV Francisco Leyva # 178 Col. Miguel Hidalgo C.P. 62040, Cuernavaca Morelos Tel: 01 777 3180579 / 01 777 3124014 E-Mail: <a href="mailto:aquevedo@compusupportcva.com">aquevedo@compusupportcva.com</a>
<b>Distrito Federal:</b> QPLUS, S.A. de C.V. Av. Coyoacán 931 Col. Del Valle 03100, México, D.F. Tel: 01(52)55-50-00-27-35 E-Mail : <a href="mailto:gacosta@qplus.com.mx">gacosta@qplus.com.mx</a>	<b>Guadalajara, Jal.:</b> SERVICRECE, S.A. de C.V. Av. Niños Héroes # 2281 Col. Arcos Sur, Sector Juárez 44170, Guadalajara, Jalisco Tel: 01(52)33-36-15-15-43 E-Mail: <a href="mailto:mmiranda@servicrece.com">mmiranda@servicrece.com</a>
<b>Guerrero Acapulco:</b> GS Computación (Grupo Sesicomp) Progreso #6-A, Colo Centro 39300 Acapulco, Guerrero Tel: 744-48-32627	<b>Monterrey:</b> Global Product Services Mar Caribe # 1987, Esquina con Golfo Pérsico Fracc. Bernardo Reyes, CP 64280 Monterrey N.L. México Tel: 8129-5103 E-Mail: <a href="mailto:aydeem@gps1.com.mx">aydeem@gps1.com.mx</a>
<b>MERIDA:</b> ELECTROSER Av Reforma No. 403Gx39 y 41 Mérida, Yucatán, México CP97000 Tel: (52) 999-925-1916 E-Mail: <a href="mailto:rrrb@sureste.com">rrrb@sureste.com</a>	<b>Oaxaca, Oax.:</b> CENTRO DE DISTRIBUCION Y SERVICIO, S.A. de C.V. Murguía # 708 P.A., Col. Centro, 68000, Oaxaca Tel: 01(52)95-15-15-22-22 Fax: 01(52)95-15-13-67-00 E-Mail: <a href="mailto:gpotai2001@hotmail.com">gpotai2001@hotmail.com</a>
<b>Tijuana:</b> STD Av Ferrocarril Sonora #3780 L-C Col 20 de Noviembre Tijuana, Mexico	<b>FOR USA SUPPORT:</b> ViewSonic® Corporation 381 Brea Canyon Road, Walnut, CA. 91789 USA Tel: 800-688-6688 E-Mail: <a href="http://www.viewsonic.com">http://www.viewsonic.com</a>



**ViewSonic®**