

Dell Pro Slim

QCS1250

Owner's Manual

Notes, cautions, and warnings

 **NOTE:** A NOTE indicates important information that helps you make better use of your product.

 **CAUTION:** A CAUTION indicates either potential damage to hardware or loss of data and tells you how to avoid the problem.

 **WARNING:** A WARNING indicates a potential for property damage, personal injury, or death.

Chapter 1: Views of Dell Pro Slim QCS1250	7
Front.....	7
Back.....	8
Top.....	10
Chapter 2: Set up your computer	11
Chapter 3: Specifications of Dell Pro Slim QCS1250	15
Dimensions and weight.....	15
Processor.....	15
Operating system.....	17
Chipset.....	17
Memory.....	18
External ports and slots.....	19
External Port (optional module slot).....	19
Internal slots.....	20
Ethernet.....	20
Wireless module.....	20
Audio.....	21
Storage.....	21
Power ratings.....	21
Power supply connector.....	22
GPU—Integrated.....	22
GPU—Integrated.....	23
Video port and resolution matrix.....	23
GPU—Discrete.....	23
Hardware security.....	24
Environmental.....	24
Regulatory compliance.....	25
Operating and storage environment.....	25
Chapter 4: Working inside your computer	26
Safety instructions.....	26
Before working inside your computer.....	26
Safety precautions.....	27
Electrostatic discharge—ESD protection.....	27
ESD Field Service kit	28
Transporting sensitive components.....	29
After working inside your computer.....	29
BitLocker.....	29
Information on repairability for Québec - From Dell Canada Inc. - to Quebec consumers.....	29
Recommended tools.....	30
Screw list.....	30
Major components of Dell Pro Slim QCS1250.....	31

Chapter 5: Cable cover.....	34
Removing the cable cover.....	34
Installing the cable cover.....	34
Chapter 6: Side cover.....	36
Removing the side cover.....	36
Installing the side cover.....	37
Chapter 7: Coin-cell battery cover.....	40
Removing the coin-cell battery cover.....	40
Installing the coin-cell battery cover.....	40
Chapter 8: Coin-cell battery.....	42
Removing the coin-cell battery.....	42
Installing the coin-cell battery.....	43
Chapter 9: Removing and installing Customer Replaceable Units (CRUs).....	44
Dust filter.....	44
Removing the dust filter.....	44
Installing the dust filter.....	45
Front cover	45
Removing the front cover.....	45
Installing the front cover.....	46
Internal speaker.....	47
Removing the internal speaker.....	47
Installing the internal speaker.....	48
Memory.....	49
Removing the memory.....	49
Installing the memory module.....	50
Solid state drive.....	51
Removing the M.2 2230 solid state drive.....	51
Installing the M.2 2230 solid state drive.....	52
Removing the M.2 2280 solid state drive.....	53
Installing the M.2 2280 solid state drive.....	54
Location of the screw mount on M.2 slot 0.....	55
Graphics card.....	56
Removing the graphics card.....	56
Installing the graphics card.....	57
Wireless card.....	58
Removing the wireless card.....	58
Installing the wireless card.....	59
Optical drive.....	61
Removing the optical drive.....	61
Installing the optical drive.....	62
Drive bay.....	64
Removing the drive bay.....	64
Installing the drive bay.....	66
Hard drive.....	69

Removing the hard drive.....	69
Installing the hard drive.....	70
Intrusion switch.....	72
Removing the intrusion switch.....	72
Installing the Intrusion switch.....	72
Power button.....	73
Removing the power button.....	73
Installing the power button.....	74
Chapter 10: Removing and installing Field Replaceable Units (FRUs).....	76
Antenna modules.....	76
Removing the antenna modules.....	76
Installing the antenna modules.....	77
Power-supply unit.....	79
Removing the power-supply unit.....	79
Installing the power-supply unit.....	81
Processor fan and heat-sink assembly.....	83
Removing the processor fan and heat-sink assembly.....	83
Installing the processor fan and heat-sink assembly.....	84
External port (optional module).....	85
Removing the optional-port module.....	85
Installing the optional-port module.....	86
Serial-port module.....	89
Removing the serial-port module.....	89
Installing the serial-port module.....	90
Processor.....	92
Removing the processor.....	92
Installing the processor.....	93
System board.....	94
Removing the system board.....	94
Installing the system board.....	99
Chapter 11: Software.....	105
Operating system.....	105
Drivers and downloads.....	105
Chapter 12: BIOS Setup.....	106
Entering BIOS Setup program.....	106
Navigation keys.....	106
One time boot menu.....	106
F12 One Time Boot menu.....	107
BIOS Setup options.....	107
Updating the BIOS.....	118
Updating the BIOS in Windows.....	118
Updating the BIOS in Linux and Ubuntu.....	118
Updating the BIOS using the USB drive in Windows.....	119
Updating the BIOS from the One-Time boot menu.....	119
System and setup password.....	119
Assigning a System Setup password.....	120

Deleting or changing an existing system password or setup password.....	120
Clearing CMOS settings.....	120
Clearing system and setup passwords.....	121
Chapter 13: Troubleshooting.....	122
Dell SupportAssist Pre-boot System Performance Check diagnostics.....	122
Running the SupportAssist Pre-Boot System Performance Check.....	122
Power-Supply Unit Built-in Self-Test	122
System-diagnostic lights.....	122
Recovering the operating system.....	123
Real-Time Clock—RTC reset.....	124
Backup media and recovery options.....	124
Network power cycle.....	124
Chapter 14: Getting help and contacting Dell.....	125
Chapter 15: Revision history.....	126

Views of Dell Pro Slim QCS1250

Front

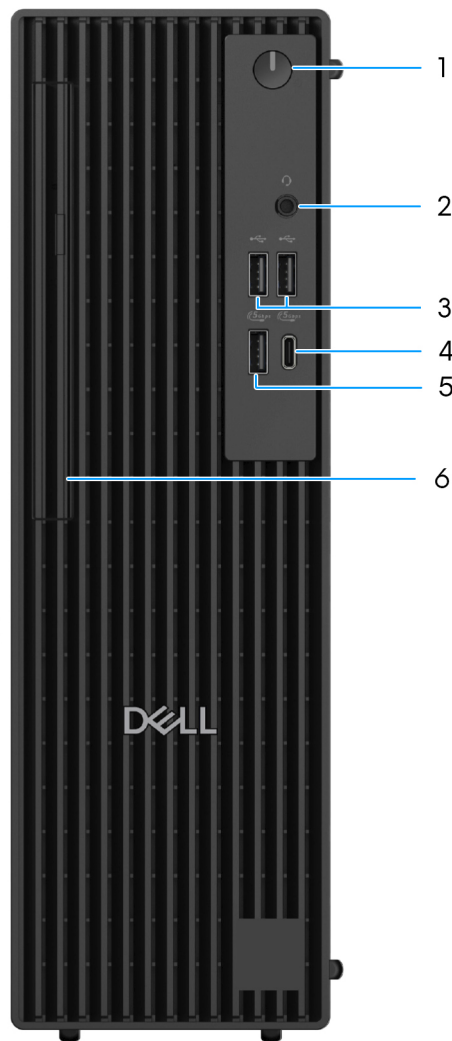

Figure 1. Front view of Dell Pro Slim QCS1250

1. Power button with diagnostic LED

Press to turn on the computer if it is turned off, in sleep state, or in hibernate state.

When the computer is turned on, press the power button to put the computer to sleep state; press and hold the power button for four seconds to force shut-down the computer.

NOTE: You can customize the power-button behavior in Windows.

2. Global headset jack

Connect headphones or a headset (headphone and microphone combo).

3. USB 2.0 (480 Mbps) ports

Connect to a TV, an external display, or another HDMI-in enabled device. Maximum resolution that is supported up to 4096 x 2160 at 60 Hz.

3. Two USB 3.2 Gen 1 (5 Gbps) ports

Connect devices such as external storage devices and printers. The port supports a data transfer speed of up to 5 Gbps.

4. Two USB 2.0 (480 Mbps) ports with SmartPower On

Connect devices such as external storage devices and printers. The port supports a data transfer speed of up to 480 Mbps.

5. Two half-height PCIe x1 slots

Connect a PCI-Express card such as an audio, or network card to enhance the capabilities of your computer.

6. Half-height PCIe x16 slot

Connect a PCI-Express card such as an audio, or network card to enhance the capabilities of your computer.

7. Power-cord connector port

Connect a power cable to provide power to your computer.

8. Power-supply diagnostic light

Indicates the power-supply state.

9. Padlock ring

Attach a standard padlock to prevent unauthorized access to the interior of your computer.

10. RJ45 ethernet port (1 Gbps)

Connect an RJ45 ethernet cable from a router or a broadband modem for network or Internet access.

11. Security-cable slot (for a Kensington lock)

Connect a security cable to prevent unauthorized movement of your computer.

12. Optional port

The port available at this location depends on the optional port module that is installed on your computer.

 **NOTE:** Only one of these options can be installed at the location shown on your computer.

- **HDMI 2.1 (FRL) port**

Connect to a TV, external display or another HDMI-in enabled device. The port supports a resolution of up to 5120 x 3200 at 60 Hz.

- **HDMI 2.1 (TMDS) port**

Connect to a TV, external display or another HDMI-in enabled device. The port supports a resolution of up to 4096 x 2160 at 60 Hz.

- **DisplayPort 2.1 (UHBR20) port**

Connect an external display or a projector. The port supports a resolution of up to 7680 x 4320 at 60 Hz.

- **DisplayPort 1.4a (HBR3) port**

Connect an external display or a projector. The port supports a resolution of up to 5120 x 3200 at 60 Hz.

- **VGA port**

Connect an external display or a projector. The port supports a resolution of up to 1920 x 1200 at 60 Hz.

- **USB 3.2 Gen 2 (10 Gbps) Type-C with DisplayPort port**

Connect devices such as external storage devices and printers. Provides a data transfer speed of up to 10 Gbps. The port supports a resolution of up to 5120 x 3200 at 60 Hz with a Type-C to DisplayPort adapter.

- **Two USB 3.2 Gen 2 (10 Gbps) ports**

Connect devices such as external storage devices and printers. Provides a data transfer speed of up to 10 Gbps.

13. Legacy serial port (optional)

Connect a peripheral or device to the RS-232 serial port.

14. Service Tag label

The Service Tag is a unique alphanumeric identifier that enables Dell service technicians to identify the hardware components in your computer and access warranty information.

Top



Figure 3. Top view of Dell Pro Slim QCS1250

1. MyDell QR code

MyDell is your hub for content that is personalized to your Dell Pro Slim QCS1250, including videos, articles, manuals, and easy access to support.

Set up your computer

Steps

1. Connect the keyboard and mouse.

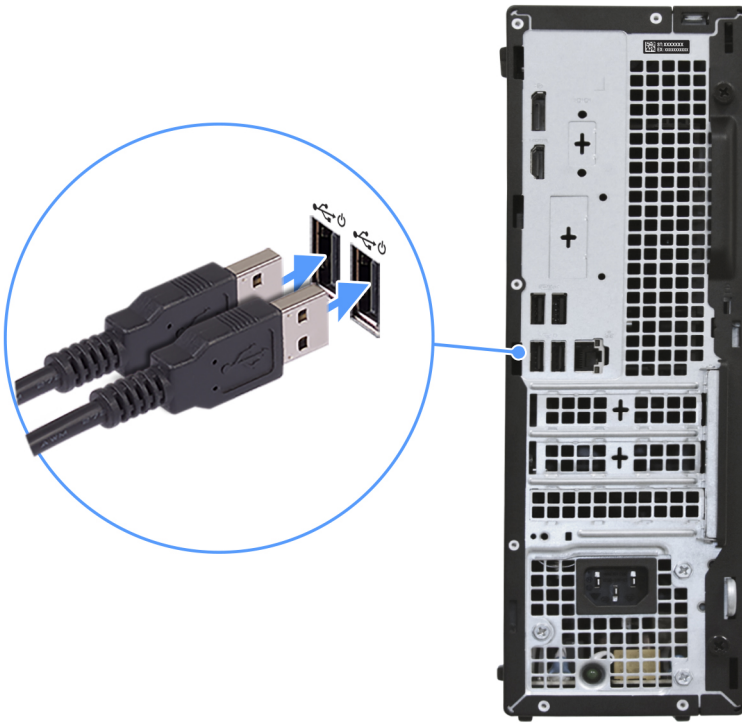

2. Connect to your network using a cable, or connect to a wireless network.

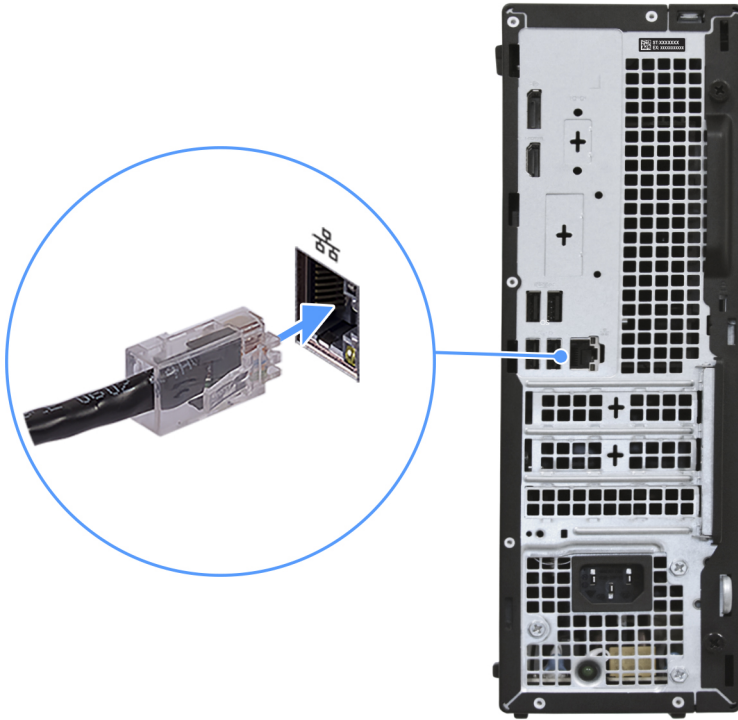

3. Connect the display.



4. Connect the power cable.

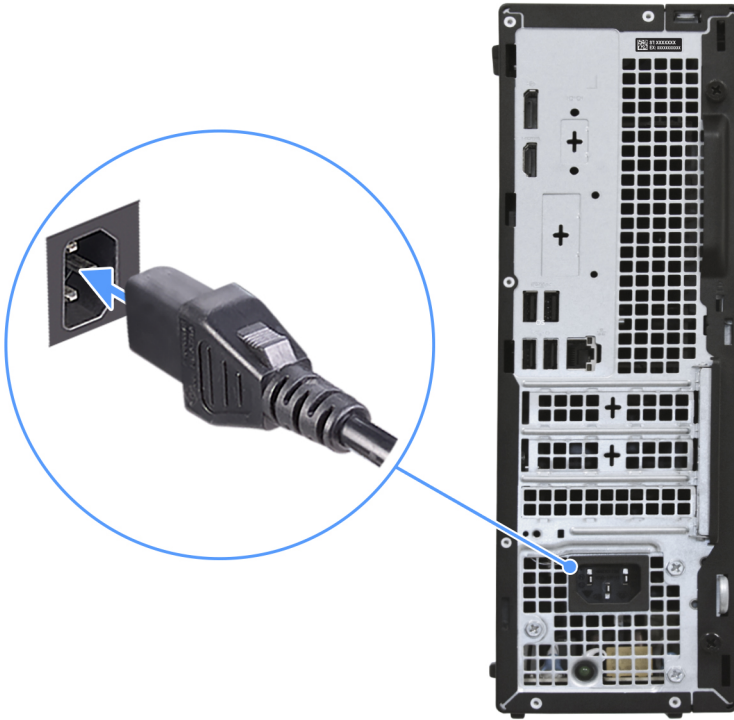

5. Press the power button.



6. Finish operating system setup.

For Ubuntu:

Follow the on-screen instructions to complete the setup. For more information about installing and configuring Ubuntu, search in the Knowledge Base Resource at [Dell Support Site](#).

For Windows:

Follow the on-screen instructions to complete the setup. When setting up, Dell Technologies recommends that you:







- Connect to a network for Windows updates.

 **NOTE:** If connecting to a secured wireless network, enter the password for the wireless network access when prompted.

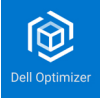
- If connected to the Internet, sign-in with or create a Microsoft account. If not connected to the Internet, create an offline account.
- On the **Support and Protection** screen, enter your contact details.

7. Locate and use Dell apps from the Windows Start menu—Recommended

Table 1. Locate Dell apps

Resources	Description
	<p>Dell Optimizer is an application designed to enhance computer performance and productivity by optimizing settings for power, battery, display, collaboration touchpad, and presence detection. It also provides access to applications purchased with your new computer.</p> <p>For more information, see Dell Optimizer User's Guide at Dell Support Site.</p>
	<p>Dell Product Registration</p> <p>Register your computer with Dell.</p>
	<p>Dell Help & Support</p> <p>Access help and support for your computer.</p>
	<p>SupportAssist</p> <p>SupportAssist is a proactive and predictive technology that offers automated technical support for Dell computers. It proactively monitors both hardware and software, addressing performance issues, preventing security threats, and automating engagement with Dell Technical Support.</p> <p>For more information, see SupportAssist documentation at Dell Support Site.</p> <p> NOTE: In SupportAssist, click the warranty expiry date to renew or upgrade your warranty.</p>
	<p>SupportAssist</p> <p>SupportAssist is a proactive and predictive technology that offers automated technical support for Dell computers. It proactively monitors both hardware and software, addressing performance issues, preventing security threats, and automating engagement with Dell Technical Support.</p> <p>For more information, see SupportAssist for Home PCs User's Guide at Dell Support Site.</p> <p> NOTE: In SupportAssist, click the warranty expiry date to renew or upgrade your warranty.</p>

Specifications of Dell Pro Slim QCS1250

Dimensions and weight

The following table lists the height, width, depth, and weight of your Dell Pro Slim QCS1250.

Table 2. Dimensions and weight

Description	Values
Height:	
Front height	303.50 mm (11.95 in.)
Rear height	303.50 mm (11.95 in.)
Width	95 mm (3.74 in.)
Depth	293 mm (11.54 in.)
Weight  NOTE: The weight of your computer depends on the configuration that you ordered.	<ul style="list-style-type: none"> • Minimum: 3.90 kg (8.61 lb) • Maximum: 5.89 kg (12.99 lb)

Processor

The following tables list the details of the processors that are supported in your Dell Pro Slim QCS1250.

Table 3. Processor





Description		Option 1	Option 2	Option 3	Option 4	Option 5
Processor type		Intel 300	Intel Core i3 14100	Intel Core i5 14500 vPro	Intel Core i5 14600 vPro	Intel Core i7 14700 vPro
Processor wattage		46 W	60 W	65 W	65 W	65 W
Processor total core count		2	4	14	14	20
Performance-cores		2	4	6	6	8
Efficient-cores		None	None	8	8	12
Processor total thread count		4	8	20	20	28
 NOTE: Intel Hyper-Threading Technology is available only on Performance-cores.						
Processor speed		Up to 3.9 GHz	Up to 4.7 GHz	Up to 5 GHz	Up to 5.2 GHz	Up to 5.4 GHz
Frequency—Performance cores						
	Processor base frequency	3.9 GHz	3.5 GHz	2.6 GHz	2.7 GHz	2.1 GHz
	Maximum turbo frequency	3.9 GHz	4.7 GHz	5 GHz	5.2 GHz	5.4 GHz
Frequency—Efficient cores						
	Processor base frequency	Not applicable	Not applicable	1.9 GHz	2 GHz	1.5 GHz
	Maximum turbo frequency	Not applicable	Not applicable	3.7 GHz	3.9 GHz	4.2 GHz
Processor cache		6 MB	12 MB	24 MB	24 MB	33 MB
Integrated graphics		Intel UHD Graphics 710	Intel UHD 730 Graphics	Intel UHD 770 Graphics	Intel UHD 770 Graphics	Intel UHD 770 Graphics
AI technology		None	None	None	None	None
Neural Processing Unit (NPU) performance		Not applicable	Not applicable	Not applicable	Not applicable	Not applicable
 NOTE: Tera Operations Per Second (TOPS) is an AI performance metric that measures how many trillions of operations per second an AI processor can perform.						

Table 4. Processor

Description	Option 6	Option 7	Option 8
Processor type	Intel Core Ultra 5 235	Intel Core Ultra 5 245	Intel Core Ultra 7 265
Processor wattage	65 W	65 W	65 W
Processor total core count	14	14	20
Performance-cores	6	6	8
Efficient-cores	8	8	12

Table 4. Processor (continued)

Description		Option 6	Option 7	Option 8
Processor total thread count		14	14	20
 NOTE: Intel Hyper-Threading Technology is available only on Performance-cores.				
Processor speed		Up to 5 GHz	Up to 5.1 GHz	Up to 5.3 GHz
Frequency—Performance cores				
	Processor base frequency	3.4 GHz	3.5 GHz	2.4 GHz
	Maximum turbo frequency	5 GHz	5.1 GHz	5.3 GHz
Frequency—Efficient cores				
	Processor base frequency	2.9 GHz	3 GHz	1.8 GHz
	Maximum turbo frequency	4.4 GHz	4.5 GHz	4.6 GHz
Processor cache		24 MB	24 MB	30 MB
Integrated graphics		Intel Graphics	Intel Graphics	Intel Graphics
AI technology		Intel AI Boost	Intel AI Boost	Intel AI Boost
Neural Processing Unit (NPU) performance		Up to 13 TOPS	Up to 13 TOPS	Up to 13 TOPS
 NOTE: Tera Operations Per Second (TOPS) is an AI performance metric that measures how many trillions of operations per second an AI processor can perform.				

Operating system

Your Dell Pro Slim QCS1250 supports the following operating systems:

- Windows 11 Home
- Windows 11 Pro
- Windows 11 Pro National Education
- Ubuntu Linux 24.04 LTS

Chipset

The following table lists the details of the chipset that is supported by your Dell Pro Slim QCS1250.

Table 5. Chipset

Description	Option one	Option two
Processors	Intel 300/Core i3/i5/i7	Intel Core Ultra 5/7
Chipset	Intel Q670	Intel Q870
DRAM bus width	64-bit/128-bit	64-bit/128-bit
Flash EPROM	32 MB RPMC + 16 MB nRPMC	32 MB RPMC + 32 MB nRPMC

Table 5. Chipset (continued)

Description	Option one	Option two
PCIe bus	Up to Gen3	Up to Gen4

Memory

The following table lists the memory specifications that are supported by your Dell Pro Slim QCS1250.

Table 6. Memory specifications

Description	Values
Memory slots	Two UDIMM slots
Memory type	DDR5
Memory speed	<ul style="list-style-type: none"> Up to 4800 MT/s Up to 5600 MT/s Up to 6400 MT/s
Maximum memory configuration	64 GB
Minimum memory configuration	8 GB
Memory size per slot	8 GB, 16 GB, or 32 GB
Memory configurations supported	<p>For computers shipped with an Intel Core 300/i3 14100/i5 14500 vPro processor:</p> <ul style="list-style-type: none"> 8 GB: 1 x 8 GB, single-channel DDR5, up to 4800 MT/s 16 GB: 1 x 16 GB, single-channel DDR5, up to 4800 MT/s 16 GB: 2 x 8 GB, dual-channel DDR5, up to 4800 MT/s 32 GB: 1 x 32 GB, single-channel DDR5, up to 4800 MT/s 32 GB: 2 x 16 GB, dual-channel DDR5, up to 4800 MT/s 64 GB: 2 x 32 GB, dual-channel DDR5, up to 4800 MT/s <p>For computers shipped with an Intel Core i5 14600 vPro/i7 14700 vPro processor:</p> <ul style="list-style-type: none"> 8 GB: 1 x 8 GB, single-channel DDR5, up to 5600 MT/s 16 GB: 1 x 16 GB, single-channel DDR5, up to 5600 MT/s 16 GB: 2 x 8 GB, dual-channel DDR5, up to 5600 MT/s 32 GB: 1 x 32 GB, single-channel DDR5, up to 5600 MT/s 32 GB: 2 x 16 GB, dual-channel DDR5, up to 5600 MT/s 64 GB: 2 x 32 GB, dual-channel DDR5, up to 5600 MT/s <p>For computers shipped with an Intel Core Ultra 5 235/245 or Ultra 7 265 processor:</p> <ul style="list-style-type: none"> 8 GB: 1 x 8 GB, single-channel DDR5, up to 6400 MT/s 16 GB: 1 x 16 GB, single-channel DDR5, up to 6400 MT/s 16 GB: 2 x 8 GB, dual-channel DDR5, up to 6400 MT/s 32 GB: 1 x 32 GB, single-channel DDR5, up to 6400 MT/s 32 GB: 2 x 16 GB, dual-channel DDR5, up to 6400 MT/s 64 GB: 2 x 32 GB, dual-channel DDR5, up to 6400 MT/s

External ports and slots

The following table lists the external ports and slots of your Dell Pro Slim QCS1250.

Table 7. External ports and slots

Description	Values
Network port	One RJ45 ethernet port (1 Gbps)
USB ports	<ul style="list-style-type: none"> • Two USB 2.0 (480 Mbps) ports • Three USB 3.2 Gen 1 (5 Gbps) port • One USB 3.2 Gen 1 (5 Gbps) Type-C port • Two USB 2.0 (480 Mbps) ports with SmartPower On
Audio port	One global headset jack
Video port(s)	<ul style="list-style-type: none"> • One DisplayPort 1.4a (HBR2) port, for computers shipped with Intel 300 and Intel Core processors • One DisplayPort 1.4a (HBR3) port, for computers shipped with Intel Core Ultra processors • One HDMI 2.1 (TMDS) port
Media-card reader	Not supported
Power port	One power-cable connector
Peripheral port	One serial port (optional)
Security-cable slot	<ul style="list-style-type: none"> • One padlock ring • One security-cable slot (for a Kensington lock)

External Port (optional module slot)

The following table lists the external ports that are supported on the optional module slot for Dell Pro Slim QCS1250.

NOTE: The ports that are listed in this table are mutually exclusive. Your Dell Pro Slim QCS1250 can only support one of the listed options.

Table 8. External ports (optional module)

Description	Values
USB ports	<ul style="list-style-type: none"> • Two USB 3.2 Gen 2 (10 Gbps) ports • One USB 3.2 Gen 2 (10 Gbps) Type-C port with DisplayPort Alt Mode
Video ports	<p>For computers shipped with an Intel Core 300/i3 14100/i5 14500 vPro/i5 14600 vPro/i7 14700 vPro processor:</p> <ul style="list-style-type: none"> • One HDMI 2.1 (TMDS) port • One VGA port • One DisplayPort 1.4a (HBR3) port <p>For computers shipped with an Intel Core Ultra 5 235/245 or Ultra 7 265 processor:</p> <ul style="list-style-type: none"> • One HDMI 2.1 (FRL) port • One VGA port • One DisplayPort 2.1 (UHBR20) port

Internal slots

The following table lists the internal slots on your Dell Pro Slim QCS1250.

Table 9. Internal slots

Description	Values
M.2	<ul style="list-style-type: none"> One M.2 slot for M.2 2230 WiFi and Bluetooth combo card One M.2 slot for M.2 2230/2280 solid state drive <p>NOTE: To learn more about the features of different types of M.2 cards, search in the Knowledge Base Resource at Dell Support Site.</p>
SATA	<ul style="list-style-type: none"> One SATA 3.0 slot for 3.5-inch hard-disk drive One SATA 3.0 slot for slimline optical drive
PCIe	<ul style="list-style-type: none"> One half-height Gen3 PCIe x16 slot Two half-height Gen3 PCIe x1 slots

Ethernet

The following table lists the wired ethernet Local Area Network (LAN) specifications of your Dell Pro Slim QCS1250.

Table 10. Ethernet specifications

Description	Values
Model	Intel i219-LM
Transfer rate	10/100/1000 Mbps

Wireless module

The following table lists the Wireless Local Area Network (WLAN) module specifications of your Dell Pro Slim QCS1250.

Table 11. Wireless module specifications

Description	Option one	Option two	Option three
Model number	Intel Wi-Fi 6E AX211	Intel Wi-Fi 7 BE200	MediaTek Wi-Fi 6 MT7920
Transfer rate	Up to 2400 Mbps	Up to 5760 Mbps	Up to 1200 Mbps
Frequency bands supported	2.4 GHz/5 GHz/6 GHz	2.4 GHz/5 GHz/6 GHz	2.4 GHz/5 GHz/6 GHz
Wireless standards	<ul style="list-style-type: none"> WiFi 802.11a/b/g Wi-Fi 4 (WiFi 802.11n) Wi-Fi 5 (WiFi 802.11ac) Wi-Fi 6E (WiFi 802.11ax) 	<ul style="list-style-type: none"> WiFi 802.11a/b/g Wi-Fi 4 (WiFi 802.11n) Wi-Fi 5 (WiFi 802.11ac) Wi-Fi 6 (WiFi 802.11ax) Wi-Fi 7 (WiFi 802.11be) 	<ul style="list-style-type: none"> WiFi 802.11a/b/g Wi-Fi 4 (WiFi 802.11n) Wi-Fi 5 (WiFi 802.11ac) Wi-Fi 6 (WiFi 802.11ax)
Encryption	<ul style="list-style-type: none"> 64-bit/128-bit WEP AES-CCMP TKIP 	<ul style="list-style-type: none"> 64-bit/128-bit WEP AES-CCMP TKIP 	<ul style="list-style-type: none"> 64-bit/128-bit WEP AES-CCMP TKIP
Bluetooth wireless card	Bluetooth 5.3	Bluetooth 5.4	Bluetooth 5.4

Table 11. Wireless module specifications (continued)

Description	Option one	Option two	Option three
 NOTE: The functionality of the Bluetooth wireless card may vary based on the operating system.			

Audio

The following table lists the audio specifications of your Dell Pro Slim QCS1250.

Table 12. Audio specifications

Description	Values
Audio type	High Definition Audio
Audio controller	Realtek ALC3204
Internal audio interface	High Definition Audio (HDA) interface
External audio interface	One global headset jack

Storage

This section lists the storage options on your Dell Pro Slim QCS1250.

Your Dell Pro Slim QCS1250 supports a combination of the following storage configurations:

- One 3.5-inch hard drive
- One M.2 2230/2280 solid state drive

The primary drive of your Dell Pro Slim QCS1250 is the M.2 solid state drive.

Table 13. Storage specifications

Storage type	Interface type	Capacity
3.5-inch hard drive	SATA AHCI, up to 6 Gbps	Up to 2 TB
M.2 2230 QLC solid state drive	<ul style="list-style-type: none"> • PCIe Gen3x4 NVMe, up to 32 GT/s • PCIe Gen4x4 NVMe, up to 64 GT/s 	Up to 1 TB
M.2 2230 TLC solid state drive	<ul style="list-style-type: none"> • PCIe Gen3x4 NVMe, up to 32 GT/s • PCIe Gen4x4 NVMe, up to 64 GT/s 	Up to 1 TB
9.5 mm 8x slimline DVD-RW drive	SATA AHCI, up to 1.5 Gbps	One slimline DVD-RW

Power ratings

The following table lists the power rating specifications of Dell Pro Slim QCS1250.

Table 14. Power ratings

Description	Option one	Option two
Type	180 W, Bronze	360 W, Platinum

Table 14. Power ratings (continued)

Description	Option one	Option two
Input voltage	90 VAC–264 VAC	90 VAC–264 VAC
Input frequency	47 Hz–63 Hz	47 Hz–63 Hz
Input current (maximum)	3 A	5 A
Output current (continuous)	Operating: <ul style="list-style-type: none"> ● 12 VA: 15 A ● 12 VB: 14 A Storage: <ul style="list-style-type: none"> ● 12 VA: 1.50 A ● 12 VB: 3.30 A 	Operating: <ul style="list-style-type: none"> ● 12 VA: 18 A ● 12 VB: 18 A ● 12 VC: 13 A Storage: <ul style="list-style-type: none"> ● 12 VA: 1.50 A ● 12 VB: 3.30 A ● 12 VC: 0 A
Rated output voltage	<ul style="list-style-type: none"> ● 12 VA ● 12 VB 	<ul style="list-style-type: none"> ● 12 VA ● 12 VB ● 12 VC
Temperature range:		
Operating	5°C to 45°C (41°F to 113°F)	5°C to 45°C (41°F to 113°F)
Storage	-40°C to 70°C (-40°F to 158°F)	-40°C to 70°C (-40°F to 158°F)

Power supply connector

The following table lists the Power supply connector specifications of your Dell Pro Slim QCS1250.

Table 15. Power supply connector

Power supply	Connectors
180 W internal power supply unit (PSU), 80 Plus Bronze	<ul style="list-style-type: none"> ● One 4-pin connector for the processor ● One 8-pin connector for the system board
360 W internal power supply unit (PSU), 80 Plus Platinum	<ul style="list-style-type: none"> ● Two 4-pin connectors for the processor ● One 8-pin connector for the system board ● One 8-pin header for the graphic card

GPU—Integrated

The following table lists the specifications of the integrated Graphics Processing Unit (GPU) supported by your Dell Pro Slim QCS1250.

Table 16. GPU—Integrated

Controller	Memory size	Processor
Intel UHD Graphics 710/	Shared system memory	Intel Core 300
Intel UHD Graphics 730	Shared system memory	Intel Core i3
Intel UHD Graphics 770	Shared system memory	Intel Core i5/i7
Intel Graphics	Shared system memory	Intel Core Ultra 5/7

GPU—Integrated

The following table lists the specifications of the integrated Graphics Processing Unit (GPU) supported by your Dell Pro Slim QCS1250.

Table 17. GPU—Integrated

Controller	Memory size	Processor
Intel UHD Graphics 710/	Shared system memory	Intel Core 300
Intel UHD Graphics 730	Shared system memory	Intel Core i3

Video port and resolution matrix

The following table lists the Video port and resolution matrix of your Dell Pro Slim QCS1250.

Table 18. Video port and resolution matrix

Port type	DisplayPort 1.4a (HBR2)	DisplayPort 1.4a (HBR3)	DisplayPort 2.1 (UHBR20)	VGA	HDMI 2.1 (FRL)	HDMI 2.1 (TMDS)
Maximum resolution—single display	4096 x 2304 at 60 Hz	5120 x 3200 at 60 GHz	7680 x 4320 at 60 Hz	1920 x 1200 at 60 Hz	5120 x 3200 at 60 Hz	4096 x 2160 at 60 GHz
Maximum resolution—dual MST	2560 x 1600 at 60 Hz	3840 x 2160 at 60 Hz	5120 x 3200 at 60 Hz	Not applicable	Not applicable	Not applicable
Maximum resolution—triple MST	2560 x 1440 at 60 Hz	2560 x 1600 at 60 Hz	4096 x 2304 at 60 Hz	Not applicable	Not applicable	Not applicable
Maximum resolution—four MST	1920 x 1080 at 60 Hz	2560 x 1440 at 60 Hz	4096 x 2304 at 60 Hz	Not applicable	Not applicable	Not applicable

GPU—Discrete

The following table lists the specifications of the discrete Graphics Processing Unit (GPU) supported by your Dell Pro Slim QCS1250.

Table 19. GPU—Discrete

Controller	Memory size	Memory type
AMD Radeon RX 6300	2 GB	GDDR6
AMD Radeon RX 7400	8 GB	GDDR6
NVIDIA RTX A400	4 GB	GDDR6

Hardware security

The following table lists the hardware security of your Dell Pro Slim QCS1250.

Table 20. Hardware security

Hardware security
Chassis intrusion switch (optional)
Chassis lock slot support
Intel Authenticate
Intel Secure Boot
Security-cable slot (Kensington lock)
Local hard drive data wipe through BIOS (Secure Erase)
Lockable cable covers
Microsoft 10 Device Guard and Credential Guard (Enterprise SKU)
Microsoft Windows BitLocker
Padlock ring
SafeBIOS: includes Dell Off-host BIOS Verification, BIOS Resilience, BIOS Recovery, and additional BIOS Controls
SafelD including Trusted Platform Module (TPM) 2.0
Self-encrypting storage drives (Opal, FIPS)
Smart card keyboard (FIPS)
Supply chain tamper alerts
Trusted Platform Module TPM 2.0

Environmental

The following table lists the environmental specifications of your Dell Pro Slim QCS1250.

Table 21. Environmental

Feature	Values
Recyclable packaging	Yes
BFR/PVC—free chassis	Yes
Vertical orientation packaging support	No
Multi-Pack packaging	Yes
Energy-Efficient Power Supply	Standard
ENV0424 compliant	Yes

NOTE: Wood-based fiber packaging contains a minimum of 35% recycled content by total weight of wood-based fiber. Packaging that contains without wood-based fiber can be claimed as Not Applicable. The anticipated required criteria for EPEAT 2018.

Regulatory compliance

The following table lists the regulatory compliance of your Dell Pro Slim QCS1250.

Table 22. Regulatory compliance

Regulatory compliance
Product Safety, EMC and Environmental Datasheets
Dell Regulatory Compliance Home Page
Responsible Business Alliance Policy

Operating and storage environment

This table lists the operating and storage specifications of your Dell Pro Slim QCS1250.

Airborne contaminant level: G1 as defined by ISA-S71.04-1985

Table 23. Computer environment

Description	Operating	Storage
Temperature range	10°C to 35°C (50°F to 95°F)	-40°C to 65°C (-40°F to 149°F)
Relative humidity (maximum)	20% to 80% (non-condensing)	5% to 95% (non-condensing)
Vibration (maximum)*	0.26 GRMS	1.37 GRMS
Shock (maximum)	40 G†	105 G†
Altitude range	-15.2 m to 3048 m (-49.87 ft to 10000 ft)	-15.2 m to 10668 m (-49.87 ft to 35000 ft)
 CAUTION: Operating and storage temperature ranges may differ among components, so operating or storing the device outside these ranges may impact the performance of specific components.		









* Measured using a random vibration spectrum that simulates the user environment.

† Measured using a 2 ms half-sine pulse.

Working inside your computer

Safety instructions

Use the following safety guidelines to protect your computer from potential damage and to ensure your personal safety. Unless otherwise noted, each procedure in this document assumes that you have read the safety information that shipped with your computer.



-  **WARNING:** Before working inside your computer, read the safety information that is shipped with your computer. For more safety best practices, see [Dell Regulatory Compliance Home Page](#).
-  **WARNING:** Disconnect your computer from all power sources before opening the computer cover or panels. After you finish working inside the computer, replace all covers, panels, and screws before connecting your computer to an electrical outlet.
-  **WARNING:** For laptops, discharge the battery completely before removing it. Disconnect the AC power adapter from the computer and operate the computer solely on battery power—the battery is fully discharged when the computer no longer turns on when the power button is pressed.
-  **CAUTION:** To avoid damaging the computer, ensure that the work surface is flat, dry, and clean.
-  **CAUTION:** You should only perform troubleshooting and repairs as authorized or directed by the Dell technical support team. Damage due to servicing that is not authorized by Dell is not covered by your warranty.
-  **CAUTION:** Before touching anything inside your computer, ground yourself by touching an unpainted metal surface, such as the metal at the back of the computer. While you work, periodically touch an unpainted metal surface to dissipate static electricity which could harm internal components.
-  **CAUTION:** To avoid damaging the components and cards, handle them by their edges, and avoid touching the pins and the contacts.
-  **CAUTION:** When you disconnect a cable, pull it by its connector or its pull tab, not the cable itself. Some cables have connectors with locking tabs or thumbscrews that you must disengage before disconnecting the cable. When disconnecting cables, keep them evenly aligned to avoid bending the connector pins. When connecting cables, ensure that the connector on the cable is correctly oriented and aligned with the port.
-  **CAUTION:** Press and eject any installed card from the media-card reader.

Before working inside your computer

About this task

 **NOTE:** The images in this document may differ from your computer depending on the configuration you ordered.

Steps

1. Save and close all open files and exit all open applications.
2. Shut down your computer. For Windows operating system, click **Start** >  **Power** > **Shut down**.
 -  **NOTE:** If you are using a different operating system, see the documentation of your operating system for shut-down instructions.
3. Turn off all the attached peripherals.
4. Disconnect your computer from the electrical outlet.

5. Disconnect all attached network devices and peripherals, such as keyboard, mouse, and monitor from your computer.

 **CAUTION: To disconnect a network cable, unplug the cable from your computer.**

6. Remove any media card and optical disc from your computer, if applicable.

Safety precautions

This section details the primary steps to be followed before disassembling any device or component.

Observe the following safety precautions before any installation or break-fix procedures involving disassembly or reassembly:

- Turn off the computer and all attached peripherals.
- Disconnect the computer from AC power.
- Disconnect all network cables and peripherals from the computer.
- Use an ESD field service kit when working inside your computer to avoid electrostatic discharge (ESD) damage.
- Place the removed component on an anti-static mat after removing it from the computer.
- Press and hold the power button for 15 seconds to discharge the residual power in the system board.

Bonding

Bonding is a method for connecting two or more grounding conductors to the same electrical potential. This is done by using a field service electrostatic discharge (ESD) kit. When connecting a bonding wire, ensure that it is connected to bare metal and never to a painted or nonmetal surface. Ensure that the wrist strap is secure and in full contact with your skin. Remove all jewelry, watches, bracelets, or rings before grounding yourself and the equipment.

Electrostatic discharge—ESD protection

ESD is a major concern when you handle electronic components, especially sensitive components such as expansion cards, processors, memory modules, and system boards. A slight charge can damage circuits in ways that may not be obvious, such as intermittent problems or a shortened product life span. As the industry pushes for lower power requirements and increased density, ESD protection is an increasing concern.

Two recognized types of ESD damage are catastrophic and intermittent failures.

- **Catastrophic** – Catastrophic failures represent approximately 20 percent of ESD-related failures. The damage causes an immediate and complete loss of device functionality. An example of catastrophic failure is a memory module that has received a static shock and immediately generates a "No POST/No Video" symptom with a beep code that is emitted for missing or nonfunctional memory.
- **Intermittent** – Intermittent failures represent approximately 80 percent of ESD-related failures. The high rate of intermittent failures means that most of the time when damage occurs, it is not immediately recognizable. The memory module receives a static shock, but the tracing is merely weakened and does not immediately produce outward symptoms that are related to the damage. The weakened trace may take weeks or months to melt, and in the meantime may cause degradation of memory integrity, intermittent memory errors, and so on.

Intermittent failures that are also called latent or "walking wounded" are difficult to detect and troubleshoot.

Perform the following steps to prevent ESD damage:

- Use a wired ESD wrist strap that is properly grounded. Wireless anti-static straps do not provide adequate protection. Touching the chassis before handling parts does not ensure adequate ESD protection on parts with increased sensitivity to ESD damage.
- Handle all static-sensitive components in a static-safe area. If possible, use anti-static floor pads and workbench pads.
- When unpacking a static-sensitive component from its shipping carton, do not remove the component from the anti-static packing material until you are ready to install the component. Before unwrapping the anti-static packaging, use the anti-static wrist strap to discharge the static electricity from your body.

 **NOTE:** You can protect against ESD and discharge static electricity from your body by touching a metal-grounded object before you interact with anything electronic, for example, an unpainted metal surface on your computer's I/O panel. When connecting a peripheral (including handheld digital assistants) to your computer, you should always ground both yourself and the peripheral before connecting it to the computer. In addition, as you work inside the computer, periodically touch a metal-grounded object to remove any static charge that your body may have accumulated.

For more information about the wrist strap and ESD wrist strap tester, see [Components of an ESD Field Service Kit](#).

- Before transporting a static-sensitive component, place it in an anti-static container or packaging.

ESD Field Service kit

The unmonitored field service kit is the most commonly used service kit. Each Field Service kit includes three main components: anti-static mat, wrist strap, and bonding wire.

 **CAUTION:** It is critical to keep ESD-sensitive devices away from internal parts that are insulated and often highly charged, such as plastic heat sink casings.

Working environment

Before the ESD Field Service kit is deployed, conduct an evaluation of the site to ensure proper setup and readiness. For example, deploying the kit for a server environment is different than for a desktop or laptop environment. Servers are typically installed in a rack within a data center; desktops or laptops are typically placed on office desks or cubicles. Always look for a large open flat work area that is free of clutter and large enough to deploy the ESD kit with additional space to accommodate the type of computer that is being repaired. The workspace should also be free of insulators that can cause an ESD event. On the work area, insulators such as styrofoam and other plastics should always be moved at least 12 inches or 30 centimeters away from sensitive parts before physically handling any hardware components.

ESD packaging

All ESD-sensitive devices must be shipped and received in static-safe packaging. Metal, static-shielded bags are preferred. However, you should always return the damaged component using the same ESD bag and packaging that the new part arrived in. The ESD bag should be folded over and taped shut and all the same foam packing material should be used in the original box that the new part arrived in. ESD-sensitive devices should be removed from packaging only at an ESD-protected work surface, and parts should never be placed on top of the ESD bag because only the inside of the bag is shielded. Always place parts in your hand, on the anti-static mat, in the computer, or inside an ESD bag.

Components of an ESD Field Service kit

The components of an ESD Field Service kit are:

- **Anti-Static Mat** – The anti-static mat is dissipative and parts can be placed on it during service procedures. When using an anti-static mat, your wrist strap should be snug and the bonding wire should be connected to the anti-static mat and to any bare metal on the computer being worked on. Once deployed properly, service parts can be removed from the ESD bag and placed directly on the anti-static mat. ESD-sensitive items are safe in your hand, on the anti-static mat, in the computer, or inside an ESD bag.
- **Wrist Strap and Bonding Wire** – If an anti-static mat is not being used, the wrist strap and bonding wire should be connected directly between your wrist and an exposed metal part of the hardware. If you are using an anti-static mat, connect the wrist strap and bonding wire to the anti-static mat to ensure protection for any hardware placed on the mat. The physical connection of the wrist strap and bonding wire between your skin, the anti-static mat, and the hardware is known as bonding. Use only Field Service kits with a wrist strap, anti-static mat, and bonding wire. Never use wireless wrist straps. Always be cautious that the internal wires of a wrist strap are prone to damage from normal wear and tear, and must be checked regularly with a wrist strap tester in order to avoid accidental ESD hardware damage. It is recommended to test the wrist strap and bonding wire at least once per week.
- **ESD Wrist Strap Tester** – The wires inside an ESD strap are prone to damage over time. When using an unmonitored ESD kit, it is recommended to test the wrist strap regularly—ideally before each service session, and at a minimum, once per week. The most reliable method for testing is with a wrist strap tester. To perform the test, connect the bonding wire of the wrist strap to the tester while wearing the strap. Press the test button to initiate the check. A green LED indicates a successful test, while a red LED and audible alarm signal a failure.

 **NOTE:** It is recommended to always use the traditional wired ESD grounding wrist strap and protective anti-static mat when servicing Dell products. In addition, it is critical to keep sensitive parts separate from all insulator parts while servicing the computer.

Transporting sensitive components

When transporting ESD sensitive components such as replacement parts or parts to be returned to Dell, it is critical to place these parts in anti-static bags for safe transport.

Lifting equipment

Adhere to the following guidelines when lifting heavy equipment:

 **CAUTION: Do not lift greater than 50 pounds. Always obtain additional resources or use a mechanical lifting device.**

1. Get a firm balanced footing. Keep your feet apart for a stable base, and point your toes out.
2. Tighten stomach muscles. Abdominal muscles support your spine when you lift, offsetting the force of the load.
3. Lift with your legs, not your back.
4. Keep the load close. The closer it is to your spine, the less force it exerts on your back.
5. Keep your back upright, whether lifting or setting down the load. Do not add the weight of your body to the load. Avoid twisting your body and back.
6. Follow the same technique in reverse to set the load down.

After working inside your computer

About this task

 **CAUTION: Leaving stray or loose screws inside your computer may severely damage your computer.**

Steps

1. Replace all screws and ensure that no stray screws remain inside your computer.
2. Connect any external devices, peripherals, or cables you removed before working on your computer.
3. Replace any media cards, discs, or any other components that you removed before working on your computer.
4. Connect your computer and all attached devices to their electrical outlets.
5. Turn on your computer.

BitLocker

When updating the BIOS on a computer with BitLocker enabled, consider the following precautions.

 **CAUTION: If BitLocker is not suspended before updating the BIOS, the BitLocker key will not be recognized the next time that you reboot the computer. You are prompted to enter the recovery key to progress, and the computer displays a prompt for the recovery key on each reboot. If the recovery key is not known, this can result in data loss or an operating system reinstall. For more information, see Knowledge Article: [updating the BIOS on Dell computers with BitLocker enabled](#).**

The installation of the following components triggers BitLocker:

- Hard disk drive or solid state drive
- System board

Information on repairability for Québec - From Dell Canada Inc. - to Quebec consumers

Dell does not guarantee the availability of replacement parts, repair services, or information necessary for maintenance or repair.

Recommended tools

The procedures in this document may require the following tools:

- Phillips screwdriver #1
- Plastic scribe

Screw list

NOTE: When removing screws from a component, it is recommended to note the screw type and the quantity of screws, and then place them in a screw storage box. This is to ensure that the correct number of screws and correct screw type is restored when the component is replaced.

NOTE: Some computers have magnetic surfaces. Ensure that the screws are not left attached to such surfaces when replacing a component.

NOTE: Screw color may vary depending on the configuration ordered.

Table 24. Screw list



Component	Screw type	Quantity	Screw image
Side cover	6-32#	2	
M.2 2230/2280 solid-state drive in slot 0	M2x3.5	1	
Wireless card	M2x3.5	1	
Hard drive	6-32#	4	
External port (optional module)	M2x4	2	
Serial-port module	M3	2	
Antenna modules	6-32#	1	
Power-supply unit	6-32#	3	
Processor fan and heat-sink assembly	Captive screw	4	
Front I/O-bracket	6-32#	1	

Table 24. Screw list (continued)

Component	Screw type	Quantity	Screw image
System board	6-32#	6	
	6-32#, screw mount	1	

Major components of Dell Pro Slim QCS1250

The following image shows the major components of Dell Pro Slim QCS1250.

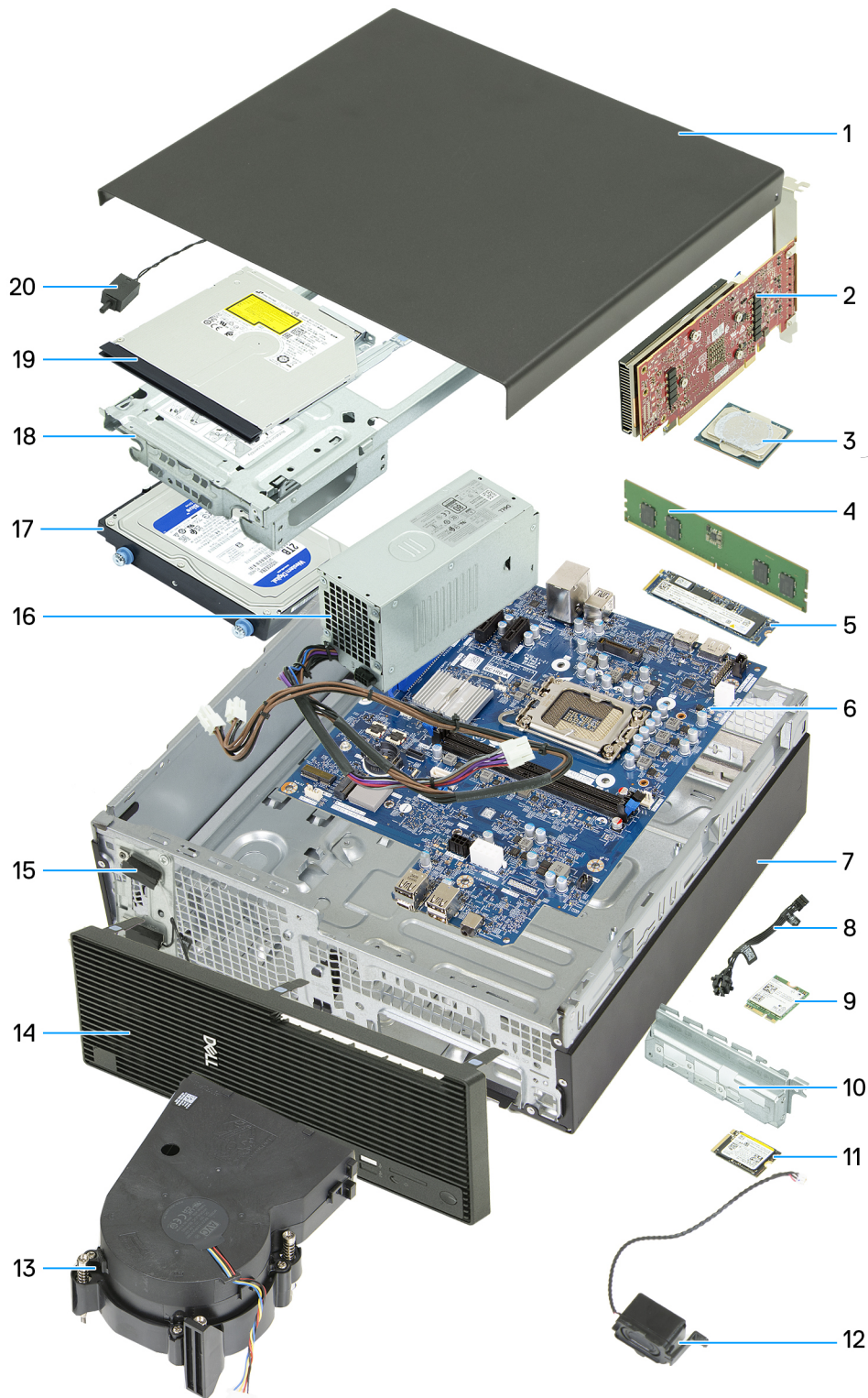

1. Side cover
3. Processor
5. M.2 2280 solid state drive
7. Chassis
9. M.2 2230 solid state drive
11. M.2 wireless card
13. Processor fan and heat-sink assembly
15. Antenna modules
17. Hard drive

2. Graphics card
4. Memory module
6. System board
8. Power-button module
10. Front I/O bracket
12. Internal speaker
14. Front cover
16. Power-supply unit
18. Drive bay

19. Optical drive

20. Intrusion switch

 **NOTE:** Dell provides a list of components and their part numbers for the original system configuration purchased. These parts are available according to warranty coverages purchased by the customer. Contact your Dell sales representative for purchase options.

Cable cover

Removing the cable cover

Prerequisites

1. Follow the procedure in [Before working inside your computer](#).

About this task

The following image indicates the location of the cable cover and provides a visual representation of the removal procedure.



Figure 4. Removing the cable cover

Steps

1. Slide the cable-cover lock to release the cable cover from the chassis.
2. Lift and slide the cable cover from the back of the computer.

Installing the cable cover

Prerequisites

If you are replacing a component, remove the existing component before performing the installation process.

About this task

The following image indicates the location of the cable cover and provides a visual representation of the installation procedure.

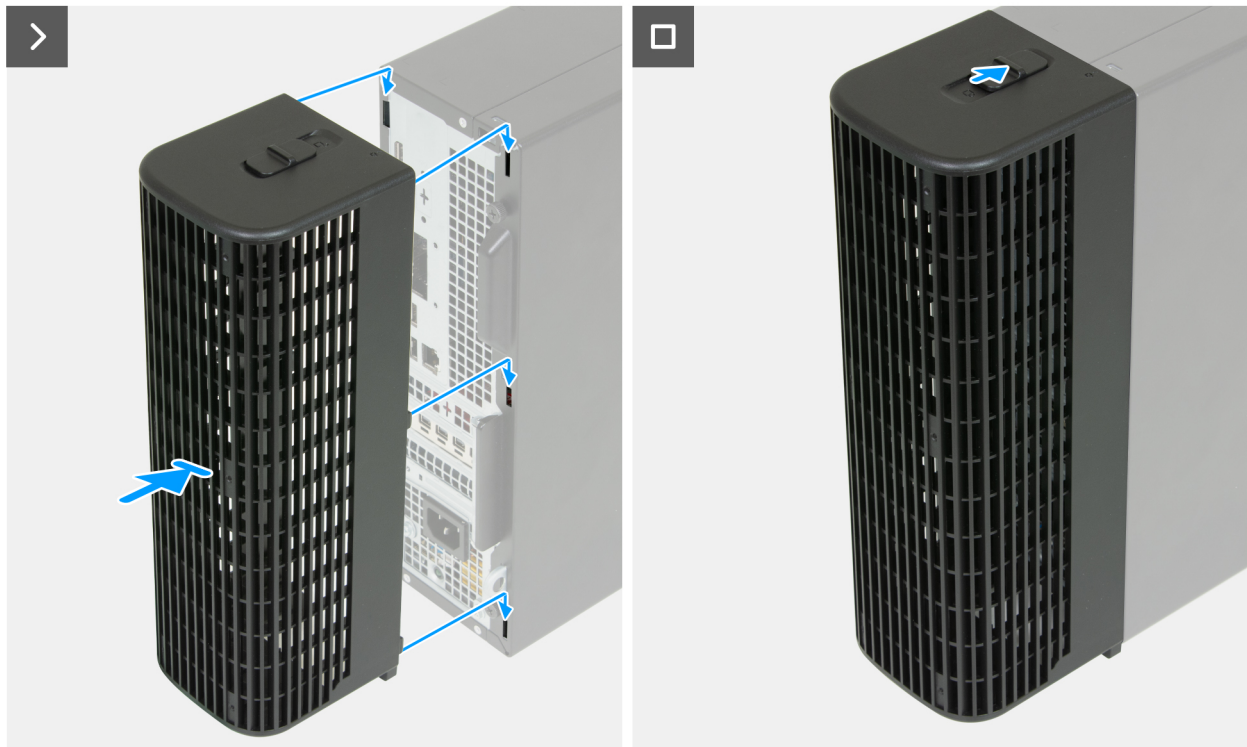

Figure 5. Installing the cable cover

Steps

1. Align the tabs on the cable cover to the slots on the back of the chassis.
2. Insert the tabs on the cable cover into the slots on the back of the chassis and slide downwards.
3. Slide the cable-cover lock to secure the cable cover to the chassis.

Next steps

1. Follow the procedure in [After working inside your computer.](#)

Side cover

Removing the side cover

Prerequisites

1. Follow the procedure in [Before working inside your computer](#).
2. Remove the [cable cover](#), if applicable.

About this task

The following images indicate the location of the side cover and provide a visual representation of the removal procedure.



2x
6-32#



Figure 6. Removing the side cover

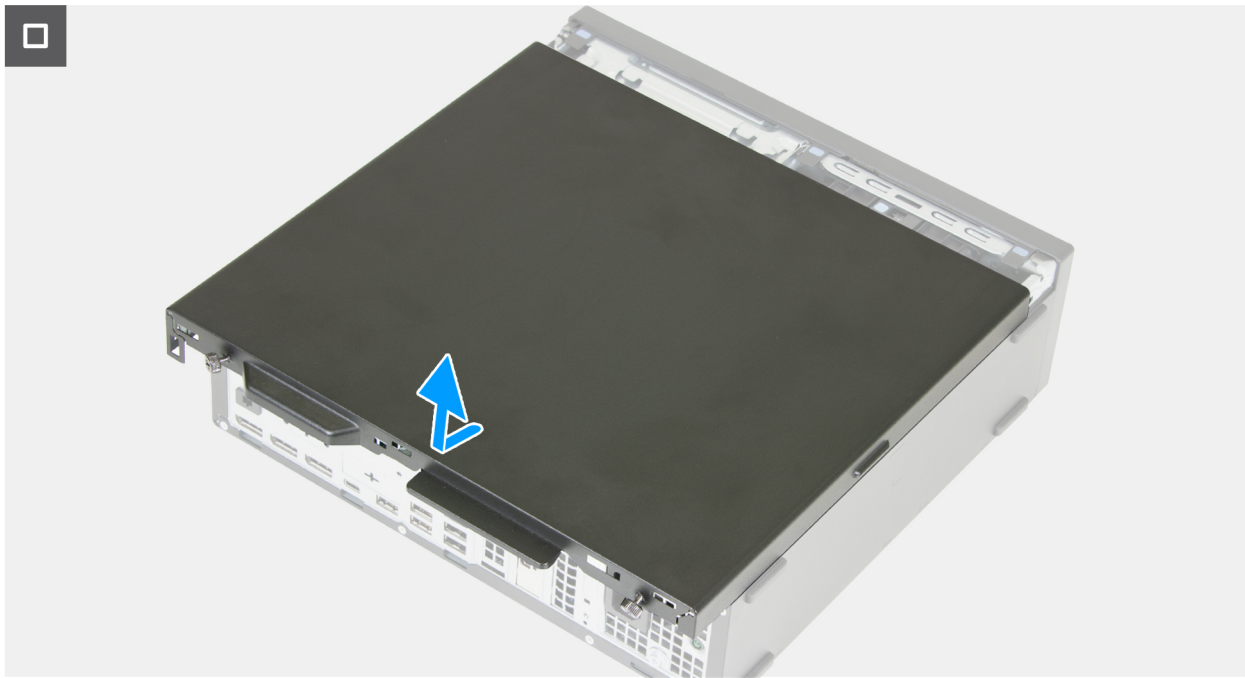

Figure 7. Removing the side cover

Steps

1. Place the computer on its side with the side cover facing up.
2. Loosen the two captive screws (6-32#) that secure the side cover to the chassis.
3. Slide the side cover towards the back of the computer.
4. Lift the side cover from the chassis.

Installing the side cover

Prerequisites

If you are replacing a component, remove the existing component before performing the installation procedure.

About this task

The following images indicate the location of the side cover and provide a visual representation of the installation procedure.



2x
6-32#

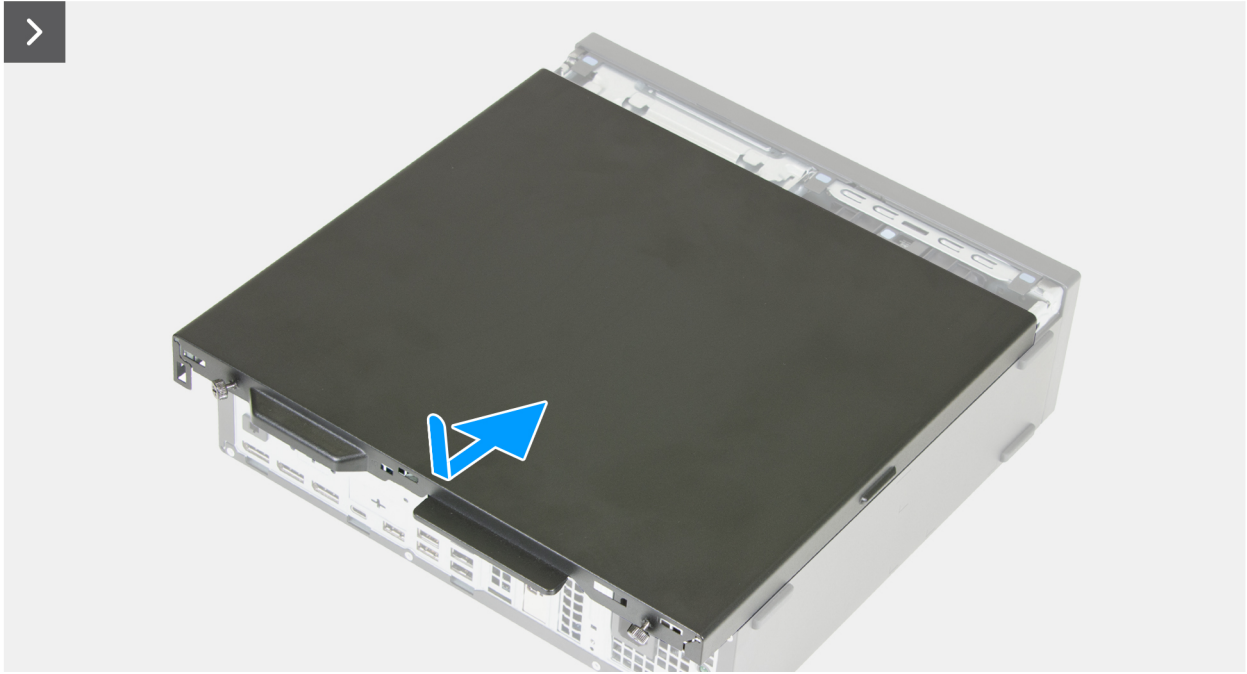

Figure 8. Installing the side cover



Figure 9. Installing the side cover

Steps

1. Align the tabs on the side cover with the slots on the chassis.
2. Slide the side cover towards the front of the computer.
3. Tighten the two captive screws (6-32#) that secure the side cover to the chassis.
4. Place the computer in an upright position.

Next steps

- 1.
2. Install the [cable cover](#), if applicable.
3. Follow the procedure in [After working inside your computer](#).

Coin-cell battery cover

Removing the coin-cell battery cover

Prerequisites

1. Follow the procedure in [Before working inside your computer](#).
2. Remove the [cable cover](#), if applicable.
3. Remove the [dust filter](#), if applicable.
4. Remove the [side cover](#).
5. Remove the [front cover](#).
6. Remove the [drive bay](#), if applicable.

About this task

The following image indicates the location of the coin-cell battery cover and provides a visual representation of the removal procedure.

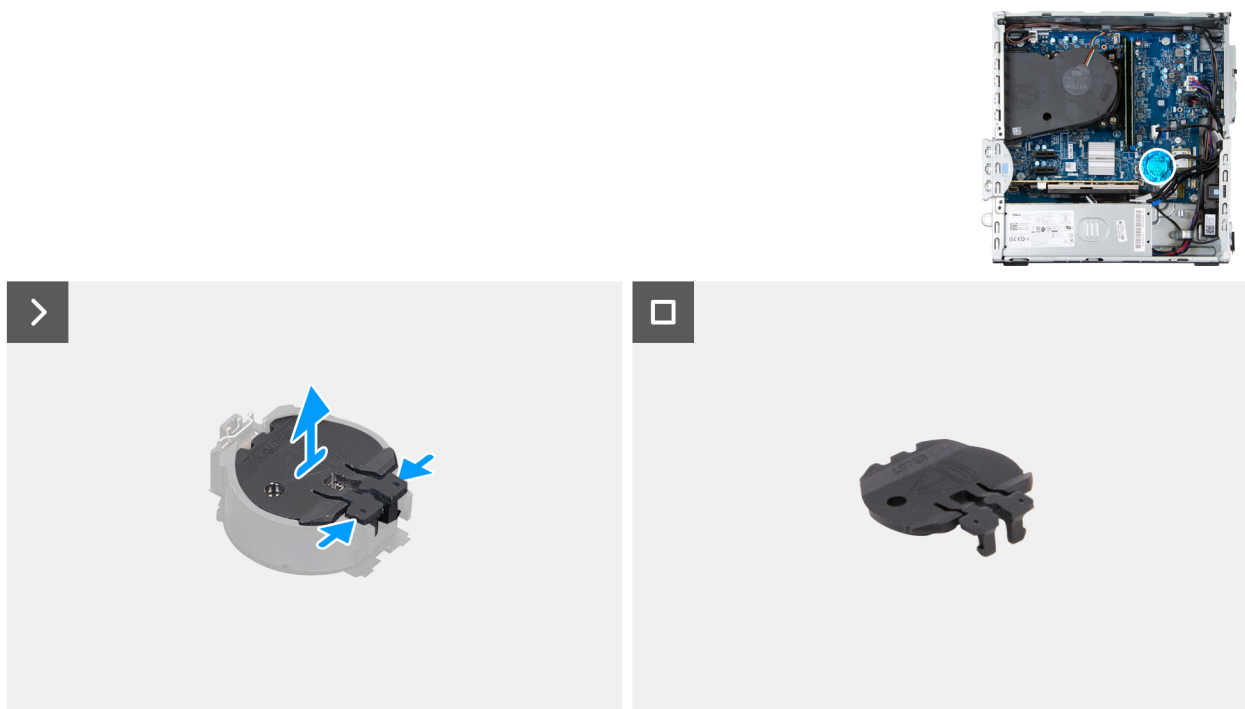

Figure 10. Removing the coin-cell battery cover

Steps

1. Pinch the securing tabs on the coin-cell cover to release the coin-cell cover from the coin-cell battery socket (RTC).
2. Lift the coin-cell cover off the battery socket.

Installing the coin-cell battery cover

Prerequisites

If you are replacing a component, remove the existing component before performing the installation process.

About this task

The following image indicates the location of the coin-cell battery cover and provides a visual representation of the installation procedure.

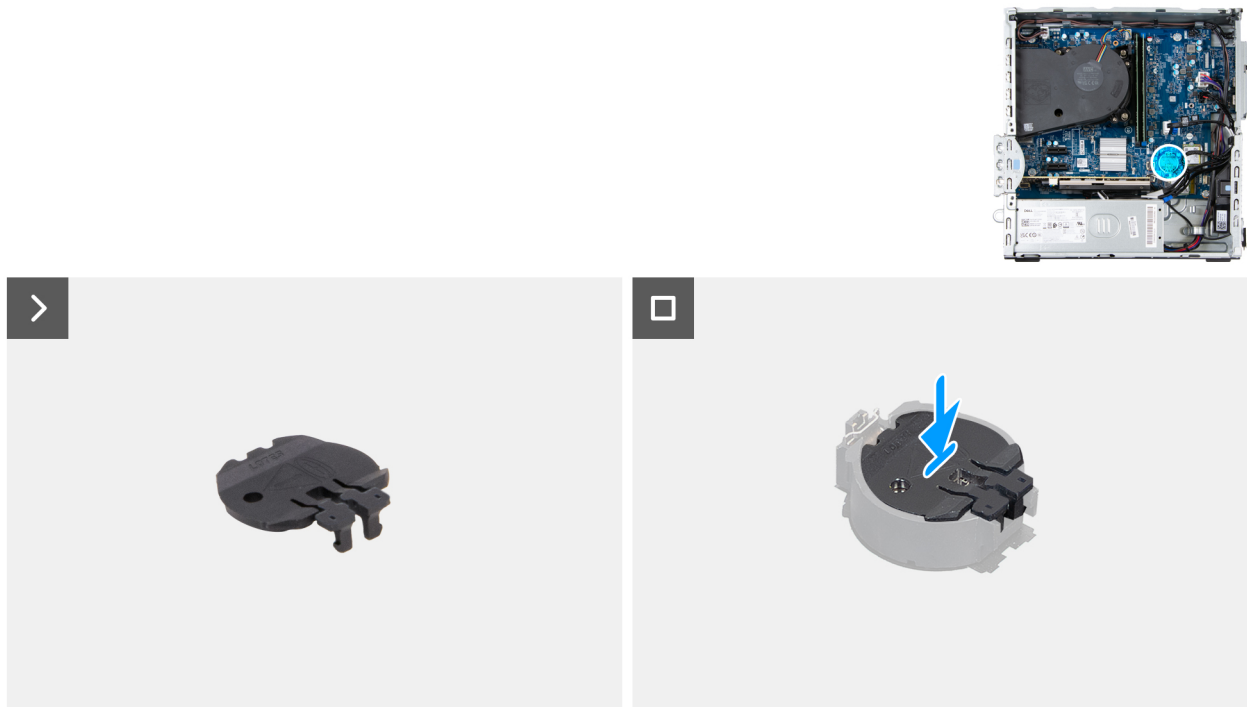

Figure 11. Installing the coin-cell battery cover

Steps

Align the coin-cell battery cover with the battery socket (RTC) and press it into place.

Next steps

1. Install the [drive bay](#), if applicable.
2. Install the [front cover](#).
3. Install the [side cover](#).
4. Install the [dust filter](#), if applicable.
5. Install the [cable cover](#), if applicable.
6. Follow the procedure in [After working inside your computer](#).

Coin-cell battery

Removing the coin-cell battery

⚠ WARNING: This computer contains a coin-cell battery and requires trained technicians for handling guidance.

⚠ CAUTION: Removing the coin-cell battery will clear the CMOS and will reset BIOS settings.

Prerequisites

1. Follow the procedure in [Before working inside your computer](#).
2. Remove the [cable cover](#), if applicable.
3. Remove the [dust filter](#), if applicable.
4. Remove the [side cover](#).
5. Remove the [front cover](#).
6. Remove the [drive bay](#), if applicable.
7. Remove the [coin-cell battery cover](#).

About this task

The following images indicate the location of the coin-cell battery and provide a visual representation of the removal procedure.

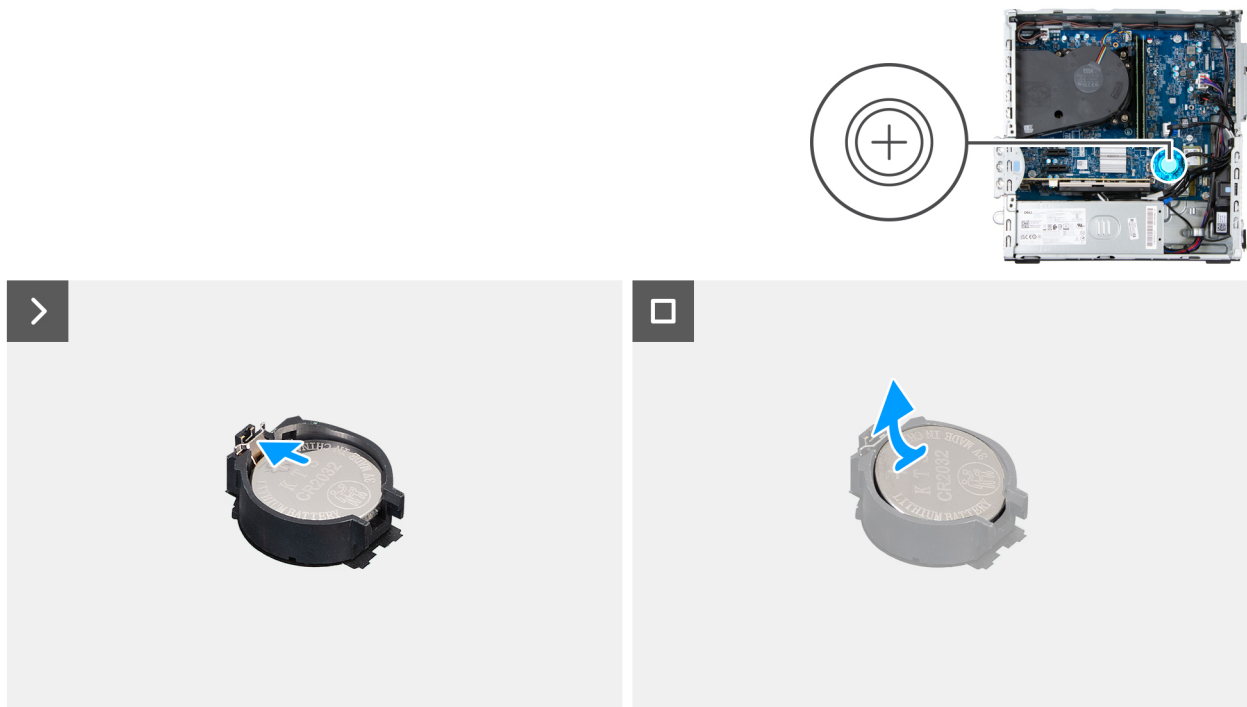

Figure 12. Removing the coin-cell battery

Steps

1. Push the coin-cell battery-release lever on the coin-cell battery socket (RTC) to release the coin-cell battery out of the socket.
2. Remove the coin-cell battery.

Installing the coin-cell battery

⚠ WARNING: This computer contains a coin-cell battery and requires trained technicians for handling guidance.

Prerequisites

If you are replacing a component, remove the existing component before performing the installation procedure.

About this task

The following images indicate the location of the coin-cell battery and provide a visual representation of the installation procedure.

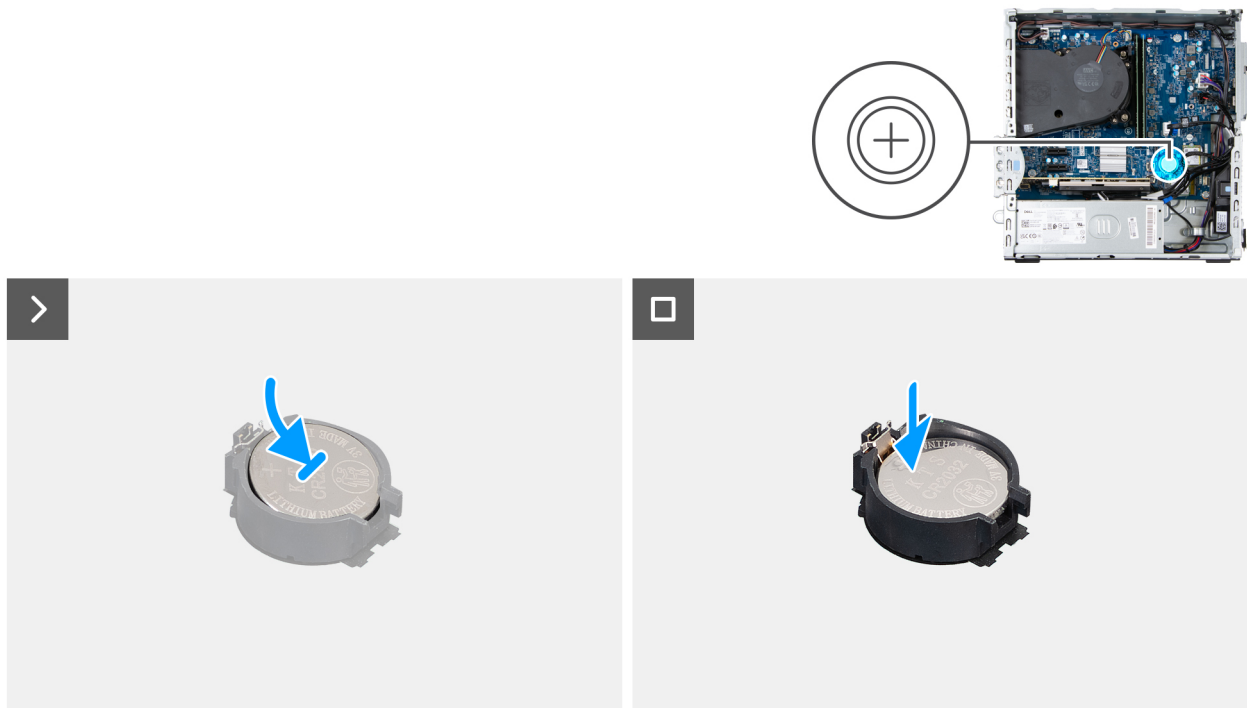

Figure 13. Installing the coin-cell battery

Steps

With the positive side (+) facing up, insert the coin-cell battery into the battery socket (RTC) on the system board and snap the battery in place.

Next steps

1. Install the [coin-cell battery cover](#).
2. Install the [drive bay](#), if applicable.
3. Install the [front cover](#).
4. Install the [side cover](#).
5. Install the [dust filter](#), if applicable.
6. Install the [cable cover](#), if applicable.
7. Follow the procedure in [After working inside your computer](#).

Removing and installing Customer Replaceable Units (CRUs)

The replaceable components in this chapter are Customer Replaceable Units (CRUs).

CAUTION: Customers can replace only the Customer Replaceable Units (CRUs) following the safety precautions and replacement procedures.

NOTE: The images in this document may differ from your computer depending on the configuration you ordered.

Dust filter

Removing the dust filter

Prerequisites

1. Follow the procedure in [Before working inside your computer](#).

About this task

The following image indicates the location of the dust filter and provides a visual representation of the removal procedure.

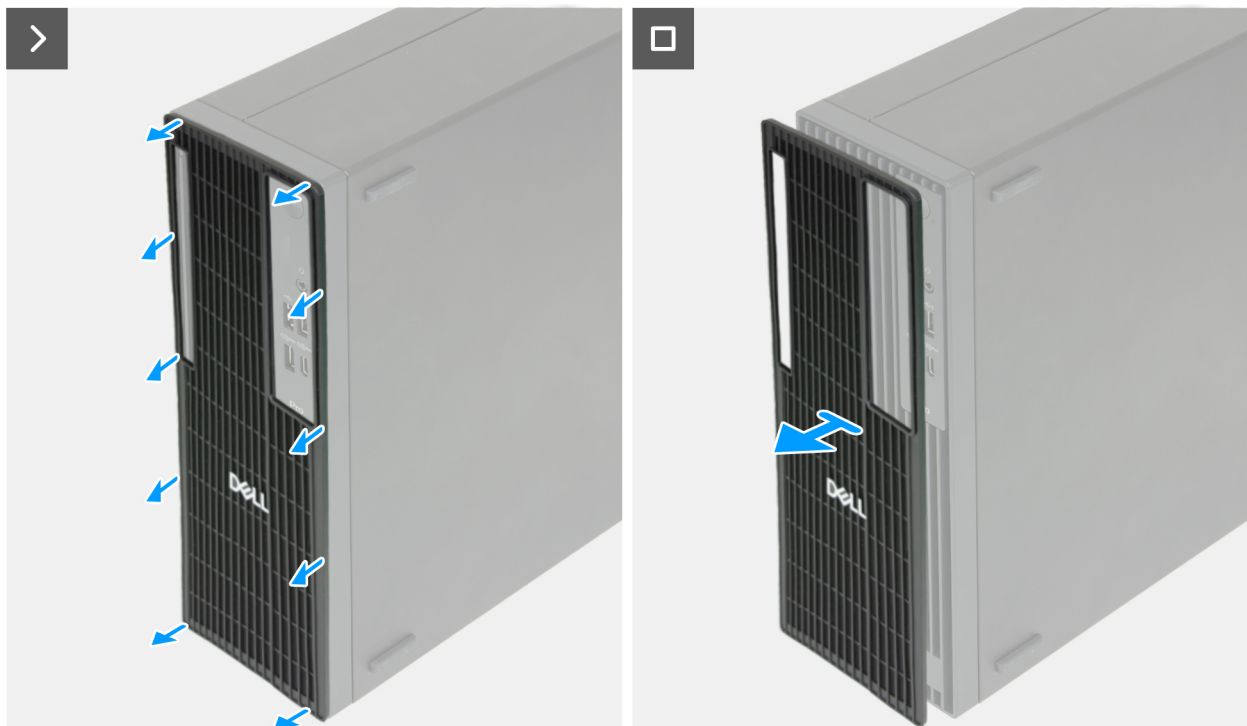

Figure 14. Removing the dust filter

Steps

1. Pry the dust filter from the front cover.
2. Remove the dust filter from the chassis.

Installing the dust filter

Prerequisites

If you are replacing a component, remove the existing component before performing the installation process.

About this task

The following image indicates the location of the dust filter and provides a visual representation of the installation procedure.

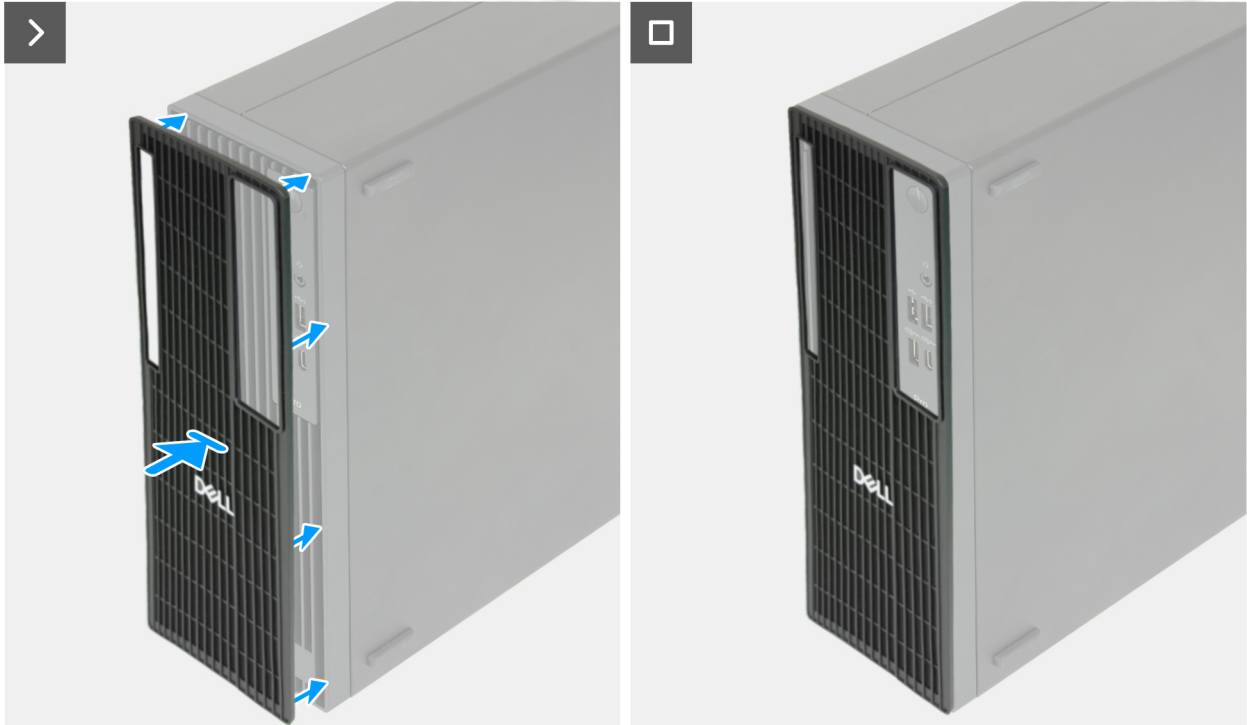

Figure 15. Installing the dust filter

Steps

1. Align the tabs on the dust filter with the grooves on the front cover.
2. Press the dust filter into place on the front cover.

Next steps

1. Follow the procedure in [After working inside your computer](#).

Front cover

Removing the front cover

Prerequisites

1. Follow the procedure in [Before working inside your computer](#).
2. Remove the [cable cover](#), if applicable.
3. Remove the [dust filter](#), if applicable.
4. Remove the [side cover](#).

About this task

The following images indicate the location of the front cover and provide a visual representation of the removal procedure.

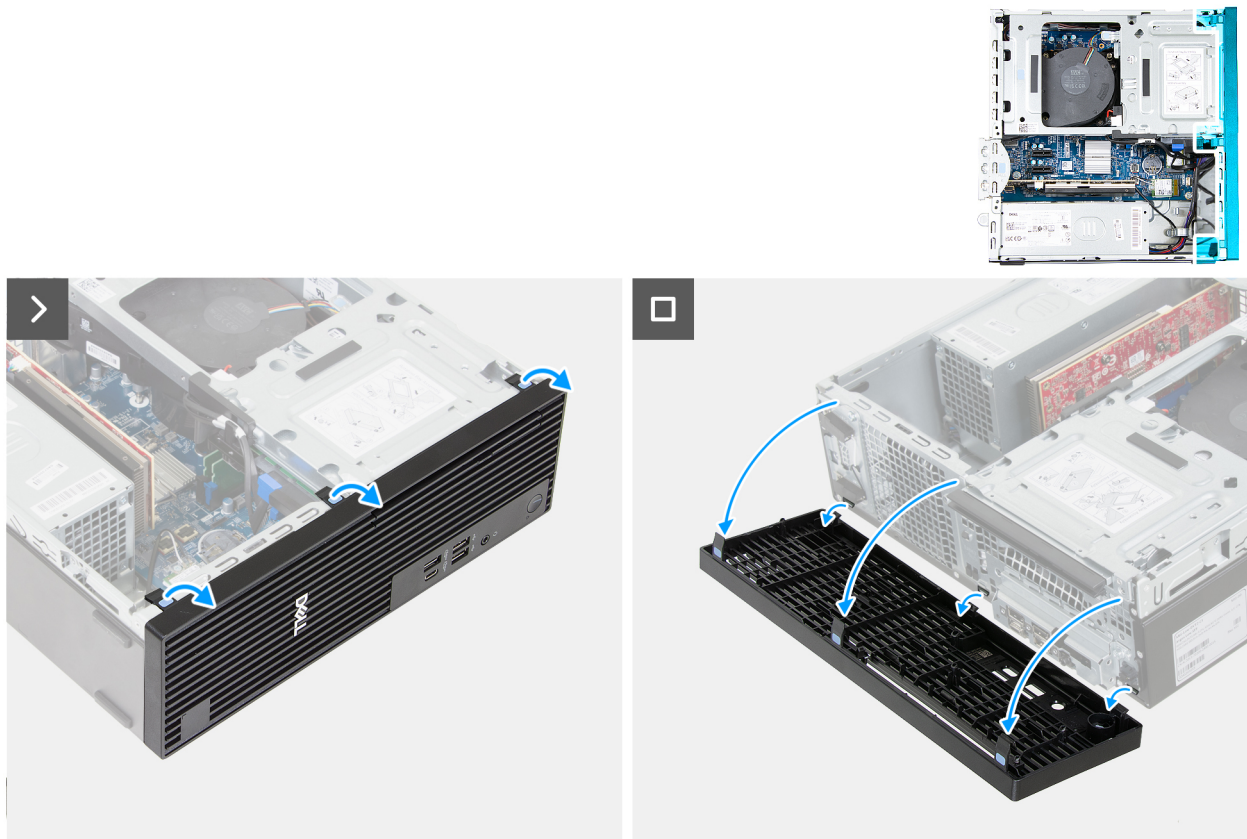

Figure 16. Removing the front cover

Steps

1. Gently pry and release the front-cover tabs one by one.
2. Pivot the front cover outward from the chassis and remove the front cover.

Installing the front cover

Prerequisites

If you are replacing a component, remove the existing component before performing the installation procedure.

About this task

The following images indicate the location of the front cover and provide a visual representation of the installation procedure.

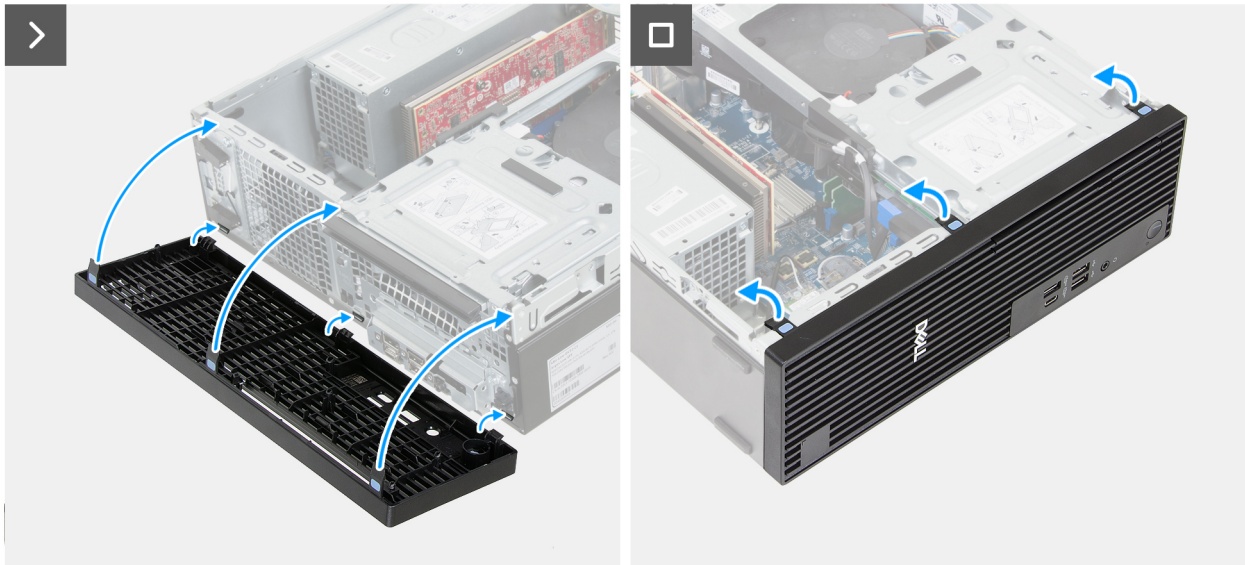
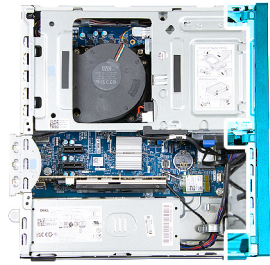

Figure 17. Installing the front cover

Steps

1. Insert the shorter front-cover tabs into the corresponding slots on the chassis.
2. Pivot the front cover on the shorter front-cover tabs toward the chassis, snapping the longer front-cover tabs into place.

Next steps

1. Install the [side cover](#).
2. Install the [dust filter](#), if applicable.
3. Install the [cable cover](#), if applicable.
4. Follow the procedure in [After working inside your computer](#).

Internal speaker

Removing the internal speaker

Prerequisites

1. Follow the procedure in [Before working inside your computer](#).
2. Remove the [cable cover](#), if applicable.
3. Remove the [side cover](#).

About this task

The following image indicates the location of the internal speaker and provides a visual representation of the removal procedure.

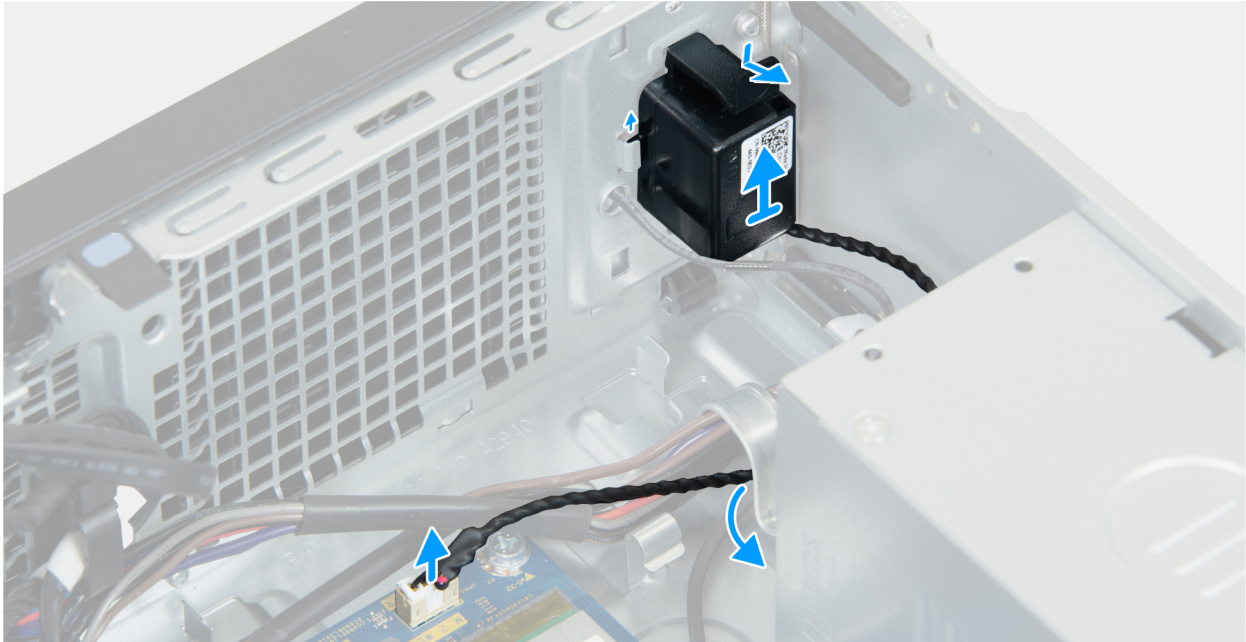

Figure 18. Removing the internal speaker

Steps

1. Disconnect the internal-speaker cable from its connector (INT SPKR) on the system board.
2. Remove the internal-speaker cable from the routing guide on the chassis.
3. Slide and remove the internal speaker from the chassis.

Installing the internal speaker

Prerequisites

If you are replacing a component, remove the existing component before performing the installation process.

About this task

The following image indicates the location of the internal speaker and provides a visual representation of the installation procedure.

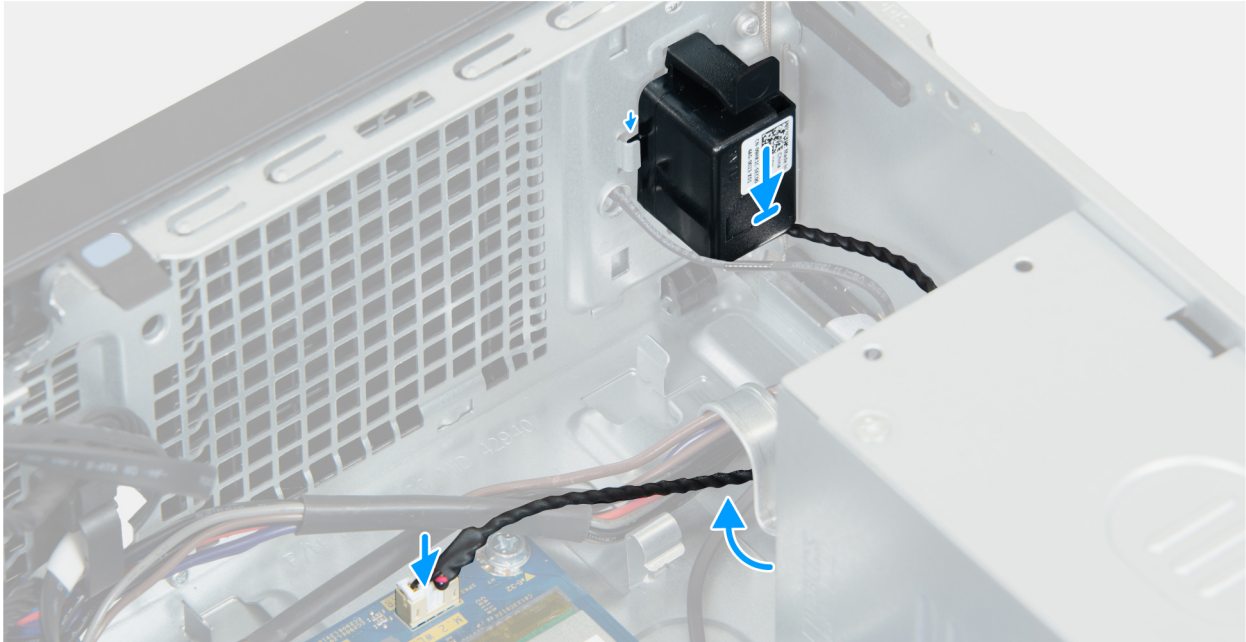

Figure 19. Installing the internal speaker

Steps

1. Place and slide the internal speaker into the bracket on the chassis.
2. Route the internal-speaker cable through the routing guide on the chassis.
3. Connect the internal-speaker cable to its connector (INT SPKR) on the system board.

Next steps

1. Install the [side cover](#).
2. Install the [cable cover](#), if applicable.
3. Follow the procedure in [After working inside your computer](#).

Memory

Removing the memory

Prerequisites

1. Follow the procedure in [Before working inside your computer](#).
2. Remove the [cable cover](#), if applicable.
3. Remove the [dust filter](#), if applicable.
4. Remove the [side cover](#).
5. Remove the [front cover](#).
6. Remove the [drive bay](#), if applicable.

About this task

The following images indicate the location of the memory modules and provide a visual representation of the removal procedure.

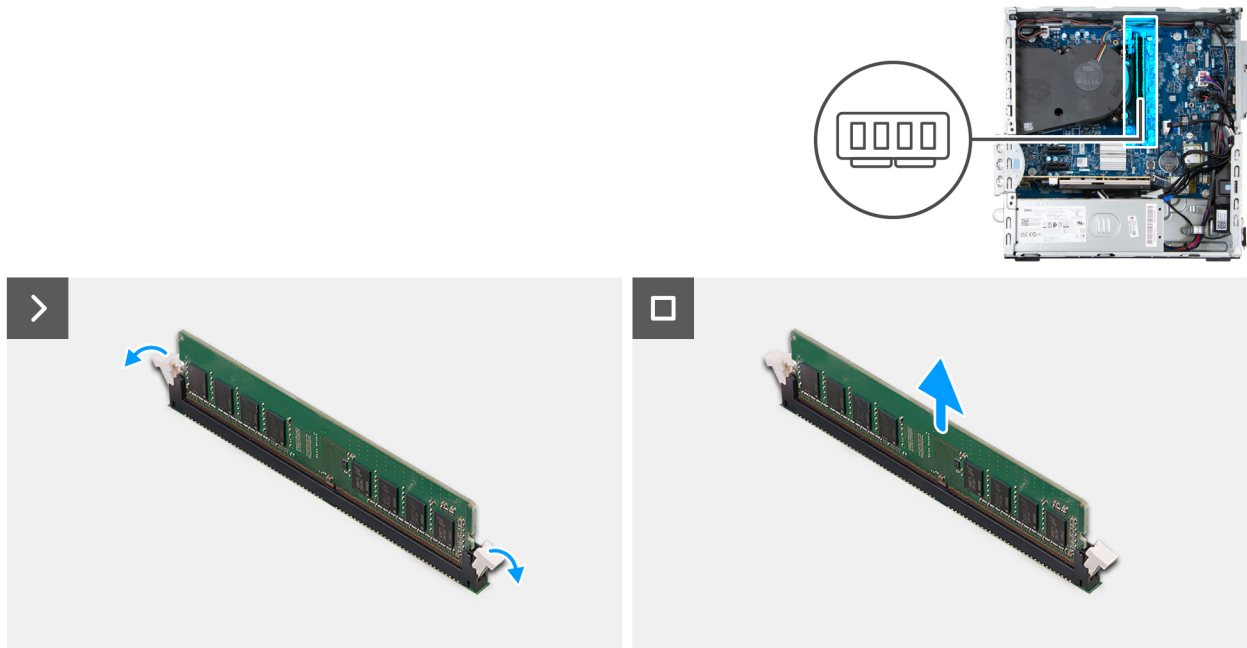

Figure 20. Removing a memory module

Steps

1. Use your fingertips to carefully spread apart the securing clips on each end of the memory-module slot (DIMM1 or DIMM2, whichever is applicable) .
2. Grasp the memory module near the securing clip, and then gently ease the memory module out of the memory-module slot.

CAUTION: To prevent damage to the memory module, hold the memory module by the edges. Do not touch the components or metallic contacts on the memory module as electrostatic discharge (ESD) can inflict severe damage on the components. To read more about ESD protection, see [ESD protection](#).

NOTE: If the memory module is difficult to remove, gently wriggle the memory module back and forth to remove it from the slot.

NOTE: Note the slot and the orientation of the memory module in order to replace it in the correct slot.

3. Repeat steps 1 and 2 if there is another memory module to remove.

Installing the memory module

Prerequisites

If you are replacing a component, remove the existing component before performing the installation procedure.

About this task

The following images indicate the location of the memory modules and provide a visual representation of the installation procedure.

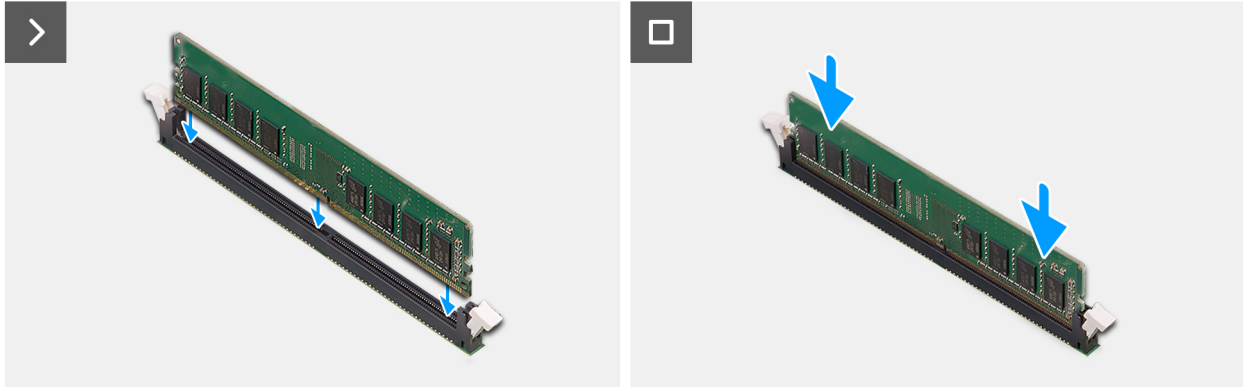
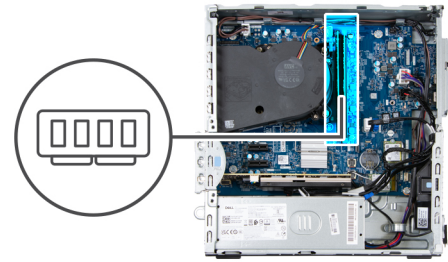

Figure 21. Installing the memory module

Steps

1. Ensure that the memory-module securing clips are in an open position.
2. Align the notch on the memory module with the tab on the memory-module slot (DIMM1 or DIMM2, whichever is applicable).
3. Insert the memory module into the memory-module slot until the memory module snaps into position and the securing clips lock in place.

CAUTION: To prevent damage to the memory module, hold the memory module by the edges. Do not touch the components or metallic contacts on the memory module as electrostatic discharge (ESD) can inflict severe damage on the components. To read more about ESD protection, see [ESD protection](#).

NOTE: If you do not hear the click, remove the memory module and reinstall it.

4. Repeat steps 1 to 3 if there is another memory module to install.

Next steps

1. Install the [drive bay](#), if applicable.
2. Install the [front cover](#).
3. Install the [side cover](#).
4. Install the [dust filter](#), if applicable.
5. Install the [cable cover](#), if applicable.
6. Follow the procedure in [After working inside your computer](#).

Solid state drive

Removing the M.2 2230 solid state drive

Prerequisites

1. Follow the procedure in [Before working inside your computer](#).
2. Remove the [cable cover](#), if applicable.
3. Remove the [dust filter](#), if applicable.
4. Remove the [side cover](#).

5. Remove the [front cover](#).
6. Remove the [drive bay](#), if applicable.

About this task

- NOTE:** This procedure only applies if there is an M.2 2230 solid state drive that is installed in M.2 solid state drive slot 0 (M.2 PCIe SSD - 0)
- NOTE:** Ensure that the mounting screw is in the correct location to install the M.2 2230 solid state drive, see [Location of the screw mount on M.2 slot 0](#) for more information.

The following image indicates the location of the M.2 2230 solid state drive and provides a visual representation of the removal procedure.



Figure 22. Removing the M.2 2230 solid state drive

Steps

1. Remove the screw (M2x3.5) that secures the solid state drive to the system board.
2. Slide and lift the solid state drive from the M.2 solid state drive slot (M.2 PCIe SSD - 0) on the system board.

Installing the M.2 2230 solid state drive

Prerequisites

If you are replacing a component, remove the existing component before performing the installation process.

About this task

- NOTE:** This procedure only applies for installing an M.2 2230 solid state drive into M.2 solid state drive slot 0 (M.2 PCIe SSD - 0)
- NOTE:** Ensure that the M.2 screw mount is in the correct location to install the M.2 2230 solid state drive, see [Location of the screw mount on M.2 slot 0](#) for more information.

The following image indicates the location of the M.2 2230 solid state drive and provides a visual representation of the installation procedure.



1x
M2x3.5

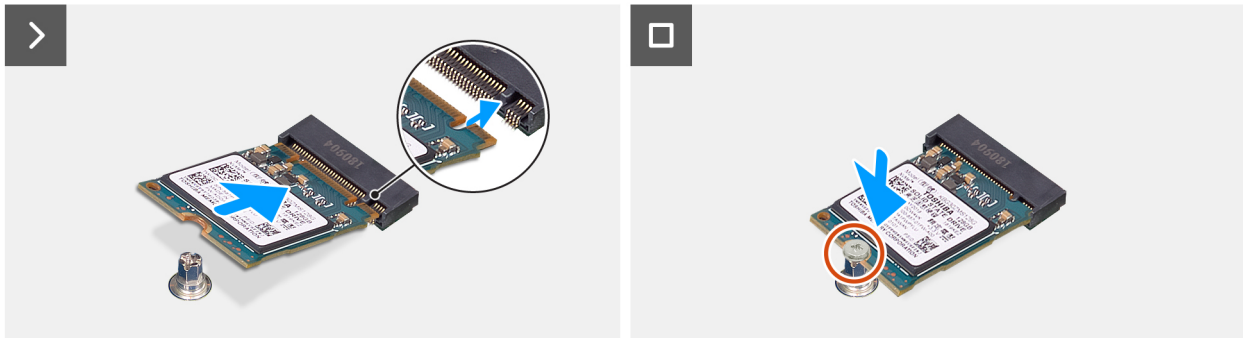

Figure 23. Installing the M.2 2230 solid state drive

Steps

1. Align the notch on the solid state drive with the tab on the M.2 solid state drive slot (M.2 PCIe SSD - 0).
2. Slide the solid state drive into the slot on the system board.
3. Replace the screw (M2x3.5) that secures the solid state drive to the system board.

Next steps

1. Install the [drive bay](#), if applicable.
2. Install the [front cover](#).
3. Install the [side cover](#).
4. Install the [dust filter](#), if applicable.
5. Install the [cable cover](#), if applicable.
6. Follow the procedure in [After working inside your computer](#).

Removing the M.2 2280 solid state drive

Prerequisites

1. Follow the procedure in [Before working inside your computer](#).
2. Remove the [cable cover](#), if applicable.
3. Remove the [dust filter](#), if applicable.
4. Remove the [side cover](#).
5. Remove the [front cover](#).
6. Remove the [drive bay](#), if applicable.

About this task

NOTE: This procedure only applies if there is an M.2 2280 solid state drive that is installed in M.2 solid state drive slot 0 (M.2 PCIe SSD - 0)

The following image indicates the location of the M.2 2280 solid state drive and provides a visual representation of the removal procedure.



1x
M2x3

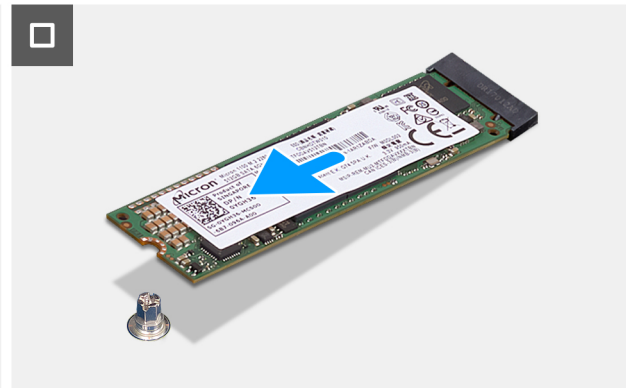

Figure 24. Removing the M.2 2280 solid state drive

Steps

1. Remove the screw (M2x3) that secures the solid state drive to the system board.
2. Slide and lift the solid state drive from the M.2 solid state drive slot (M.2 PCIe SSD - 0) on the system board.

Installing the M.2 2280 solid state drive

Prerequisites

If you are replacing a component, remove the existing component before performing the installation process.

About this task

NOTE: This procedure only applies for installing an M.2 2280 solid state drive into M.2 solid state drive slot 0 (M.2 PCIe SSD - 0)

NOTE: Ensure that the M.2 screw mount is in the correct location to install the M.2 2280 solid state drive, see [Location of the screw mount on M.2 slot 0](#) for more information.

The following image indicates the location of the M.2 2280 solid state drive and provides a visual representation of the installation procedure.



1x
M2x3

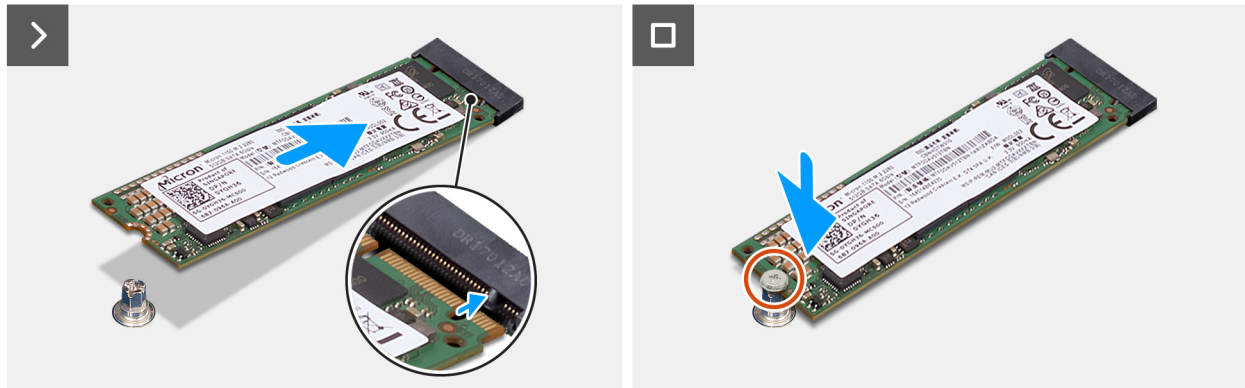

Figure 25. Installing the M.2 2280 solid state drive

Steps

1. Align the notch on the solid state drive with the tab on the M.2 solid state drive slot (M.2 PCIe SSD - 0).
2. Slide the solid state drive into the slot on the system board.
3. Replace the screw (M2x3) that secures the solid state drive to the system board.

Next steps

1. Install the [drive bay](#), if applicable.
2. Install the [front cover](#).
3. Install the [side cover](#).
4. Install the [dust filter](#), if applicable.
5. Install the [cable cover](#), if applicable.
6. Follow the procedure in [After working inside your computer](#).

Location of the screw mount on M.2 slot 0

Prerequisites

To install an M.2 solid state drive of a different form factor on M.2 slot 0, move the mounting screw to the screw mount designated for the particular form factor.

About this task

 **NOTE:** This procedure only applies to the screw mount located on M.2 slot 0.

The following images indicate the location of the screw mount on M.2 slot 0 and provides a visual representation of the procedure to change the position of the screw mount.

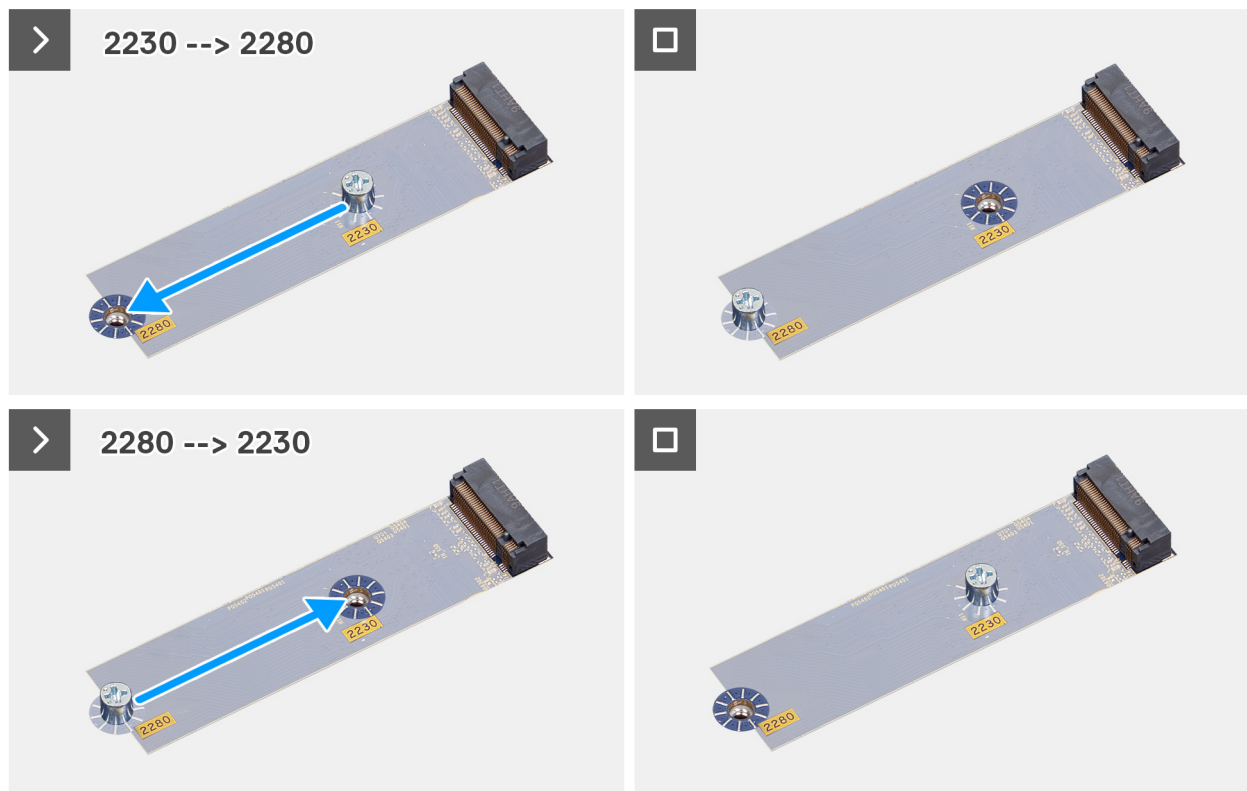

Figure 26. Moving the mounting screw to the screw mount for M.2 2280 solid state drive

Steps

1. Remove the mounting screw from the system board.
2. Install the mounting screw on the screw mount for the appropriate form factor on the system board.

Next steps

1. Install the [M.2 2230 solid state drive](#), or the [M.2 2280 solid state drive](#), whichever is applicable.
2. Install the [side cover](#).
3. Follow the procedure in [After working inside your computer](#).

Graphics card

Removing the graphics card

Prerequisites

1. Follow the procedure in [Before working inside your computer](#).
2. Remove the [cable cover](#), if applicable.
3. Remove the [side cover](#).

About this task

The following images indicate the location of the graphics card and provide a visual representation of the removal procedure.

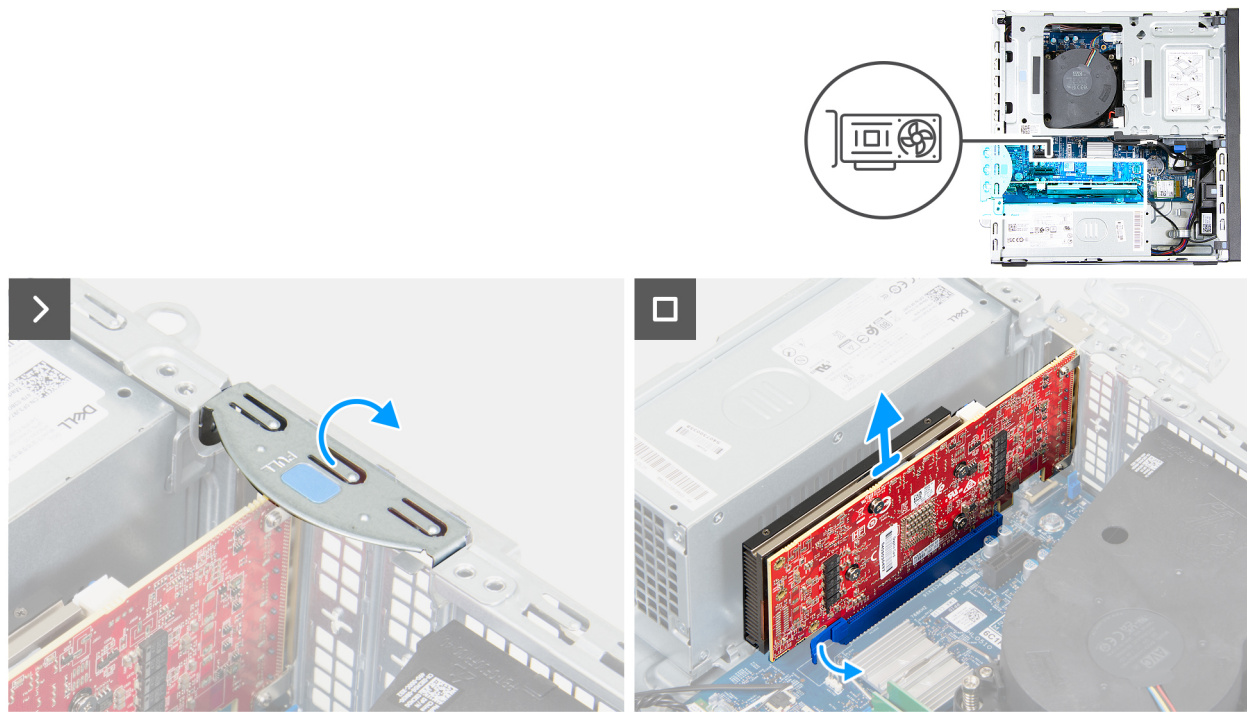

Figure 27. Removing the graphics card

Steps

1. Open the PCIe latch that secures the graphics card to the PCI card connector (SLOT 3).
2. Pull the tab that secures the graphics card to the PCIe card connector (SLOT 3).
3. Gently lift the graphics card off the PCIe card connector (SLOT 3) on the system board.

Installing the graphics card

Prerequisites

If you are replacing a component, remove the existing component before performing the installation procedure.

About this task

The following images indicate the location of the graphics card and provide a visual representation of the installation procedure.



Figure 28. Installing the graphics card

Steps

1. **NOTE:** Ensure that the PCIe door is in the open position and the release tab on the PCIe card connector (SLOT 2) is up.

Align the graphics card with the PCIe card connector (SLOT 3) on the system board.

2. Gently press down on the graphics card until the tab on the PCIe card connector (SLOT 3) locks in place.
3. Close the PCIe latch to secure the graphics card in the PCIe card connector (SLOT 3).

Next steps

1. Install the [side cover](#).
2. Install the [cable cover](#), if applicable.
3. Follow the procedure in [After working inside your computer](#).

Wireless card

Removing the wireless card

Prerequisites

1. Follow the procedure in [Before working inside your computer](#).
2. Remove the [cable cover](#), if applicable.
3. Remove the [side cover](#).

About this task

The following images indicate the location of the wireless card and provide a visual representation of the removal procedure.



1x
M2x3.5

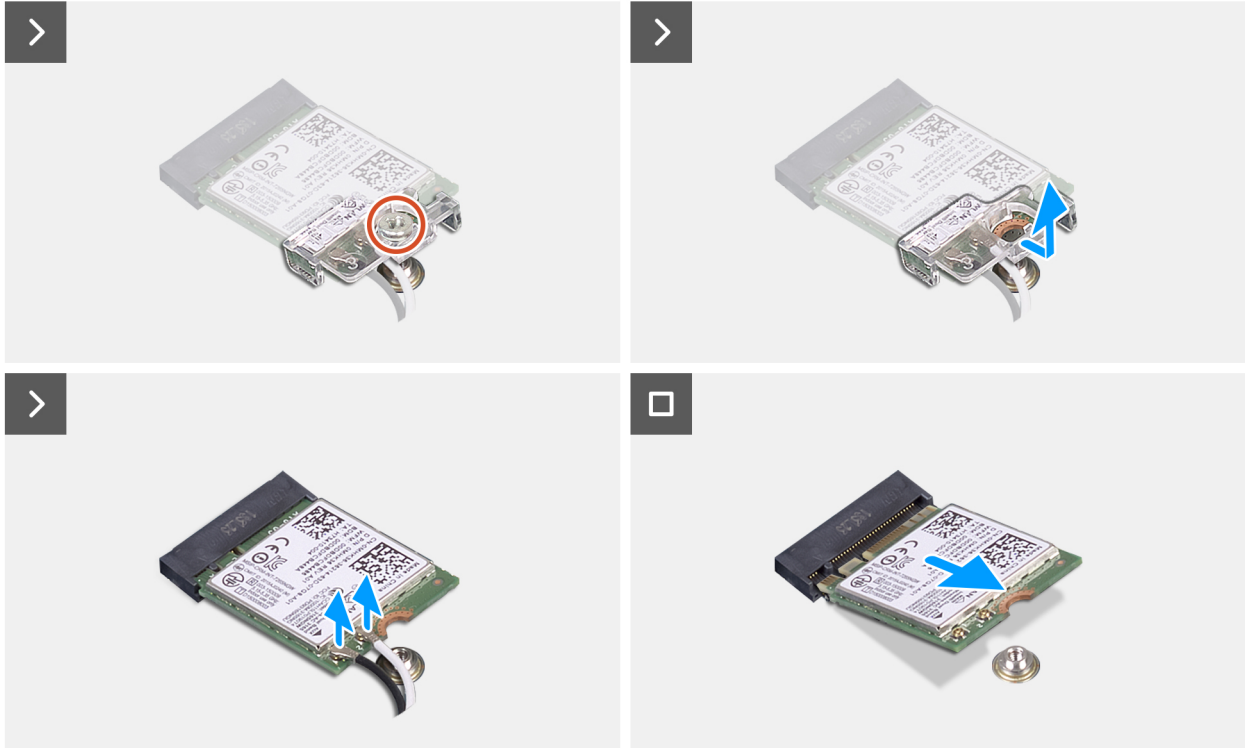

Figure 29. Removing the wireless card

Steps

1. Remove the screw (M2x3.5) that secures the wireless-card bracket to the system board.
2. Slide and lift the wireless-card bracket off the wireless card.
3. Disconnect the antenna cables from the wireless card.
4. Slide and remove the wireless card from the wireless-card slot (M.2 WLAN) on the system board.

Installing the wireless card

Prerequisites

If you are replacing a component, remove the existing component before performing the installation procedure.

About this task

The following images indicate the location of the wireless card and provide a visual representation of the installation procedure.

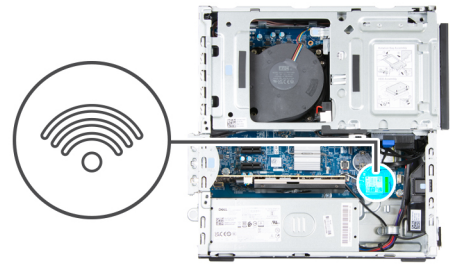

Figure 30. Installing the wireless card

Steps

1. Connect the antenna cables to the wireless card.

Table 25. Antenna-cable color scheme

Connector on the wireless card	Antenna-cable color	Silkscreen marking	
Main	White	MAIN	△ (white triangle)
Auxiliary	Black	AUX	▲ (black triangle)

2. Place the wireless-card bracket on the wireless card.
3. Align the notch on the wireless card with the tab on the wireless-card slot (M.2 WLAN).
4. Slide the wireless card at an angle into the wireless-card slot (M.2 WLAN).
5. Replace the screw (M2x3.5) that secures the wireless-card bracket to the wireless card.

Next steps

1. Install the [side cover](#).
2. Install the [cable cover](#), if applicable.
3. Follow the procedure in [After working inside your computer](#).

Optical drive

Removing the optical drive

Prerequisites

1. Follow the procedure in [Before working inside your computer](#).
2. Remove the [cable cover](#), if applicable.
3. Remove the [dust filter](#), if applicable.
4. Remove the [side cover](#).
5. Remove the [front cover](#).

About this task

NOTE: The optical drive is located within the disk bay.

The following images indicate the location of the optical drive and provide a visual representation of the removal procedure.

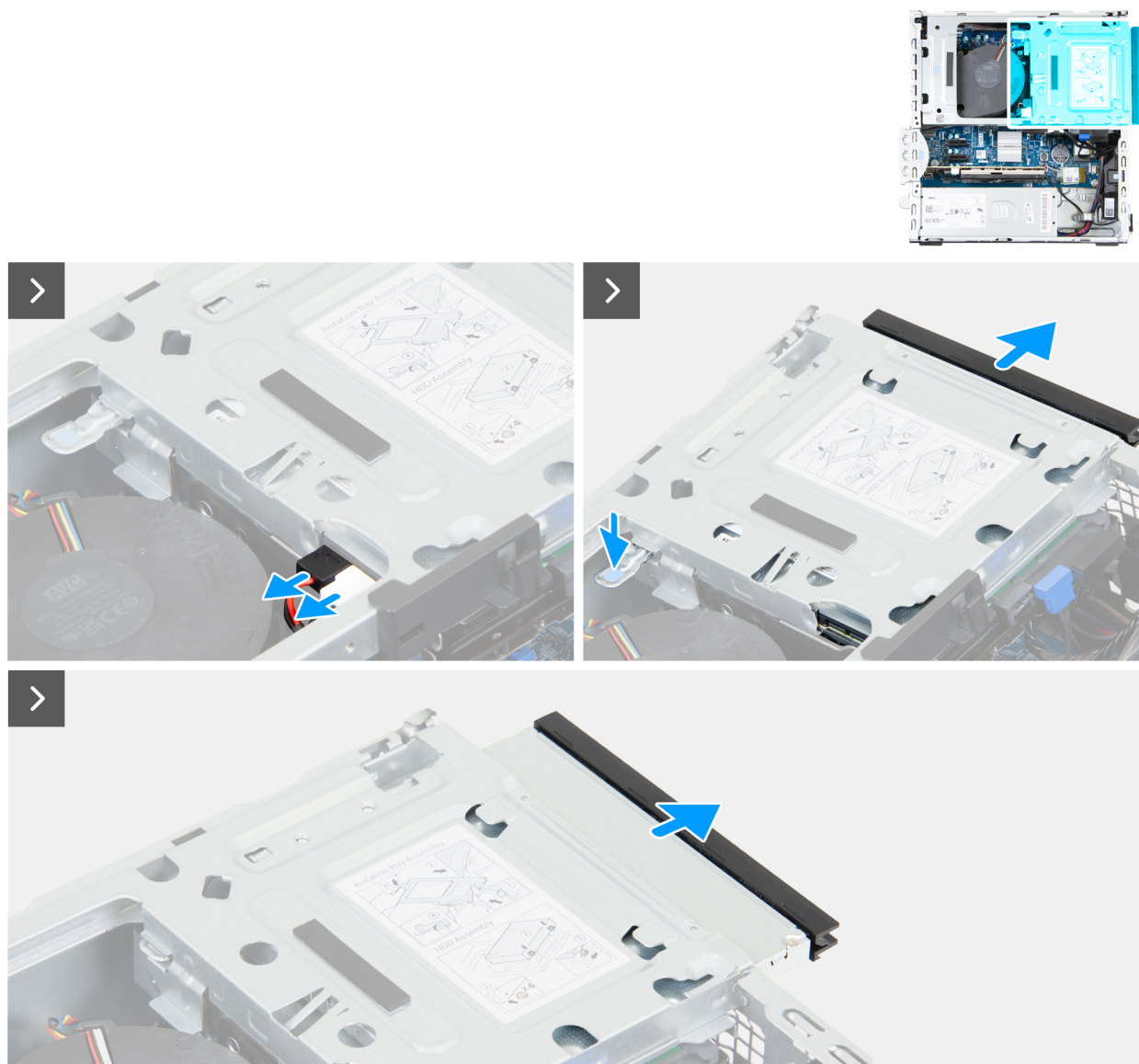

Figure 31. Removing the optical drive

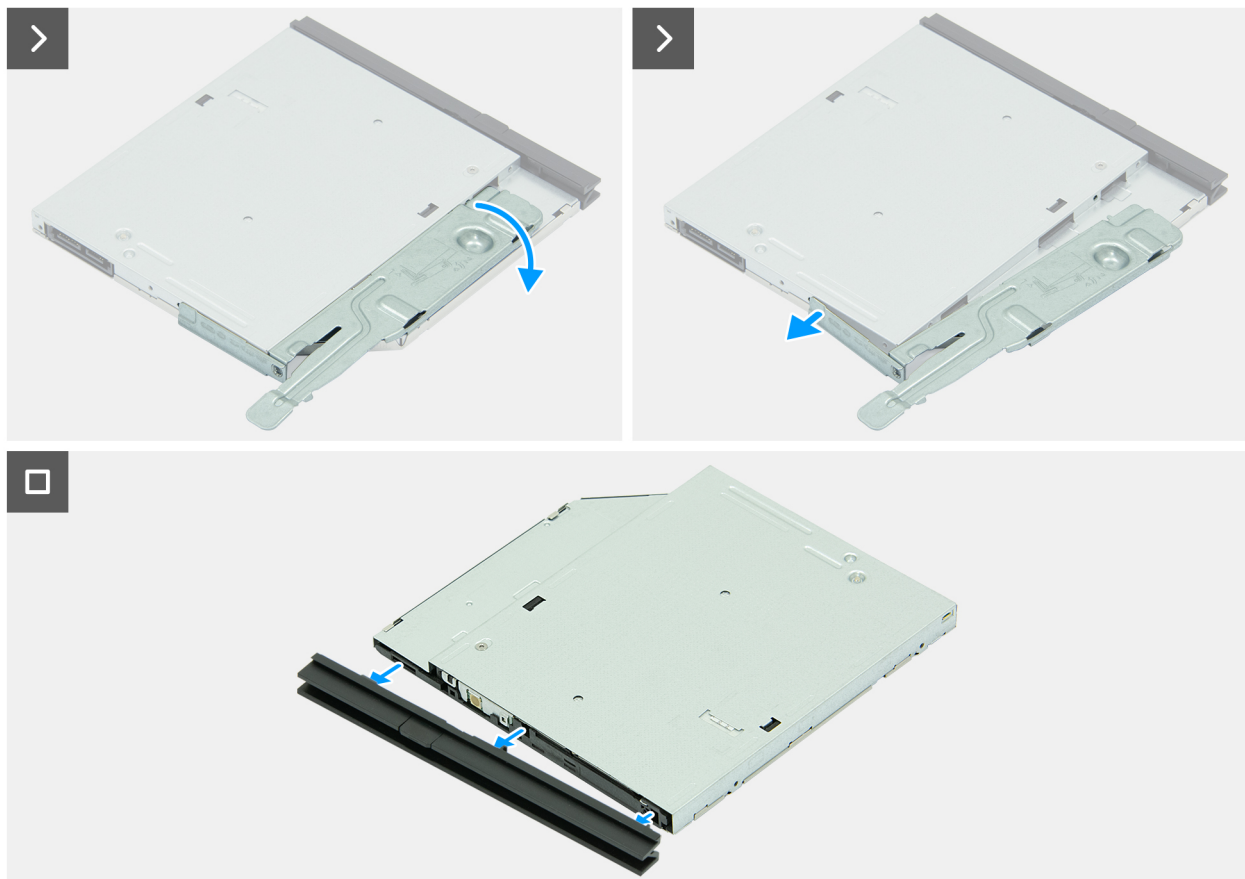

Figure 32. Removing the optical drive

Steps

1. Disconnect the data cable and the power cable from the optical drive.
2. Press down on the securing tab to release the optical drive from the drive bay.
3. Pull to slide the optical drive out of the drive bay.
4. Flip the optical drive over to reveal the securing tab.
5. Rotate the securing tab to release it from the optical drive.
6. Gently pull the bezel from the optical drive.

Installing the optical drive

Prerequisites

If you are replacing a component, remove the existing component before performing the installation procedure.

About this task

NOTE: The optical drive is located within the drive bay. Follow the below-mentioned procedure **on the disk-drive cage** to remove or install the optical drive.

The following images indicate the location of the optical drive and provide a visual representation of the installation procedure.

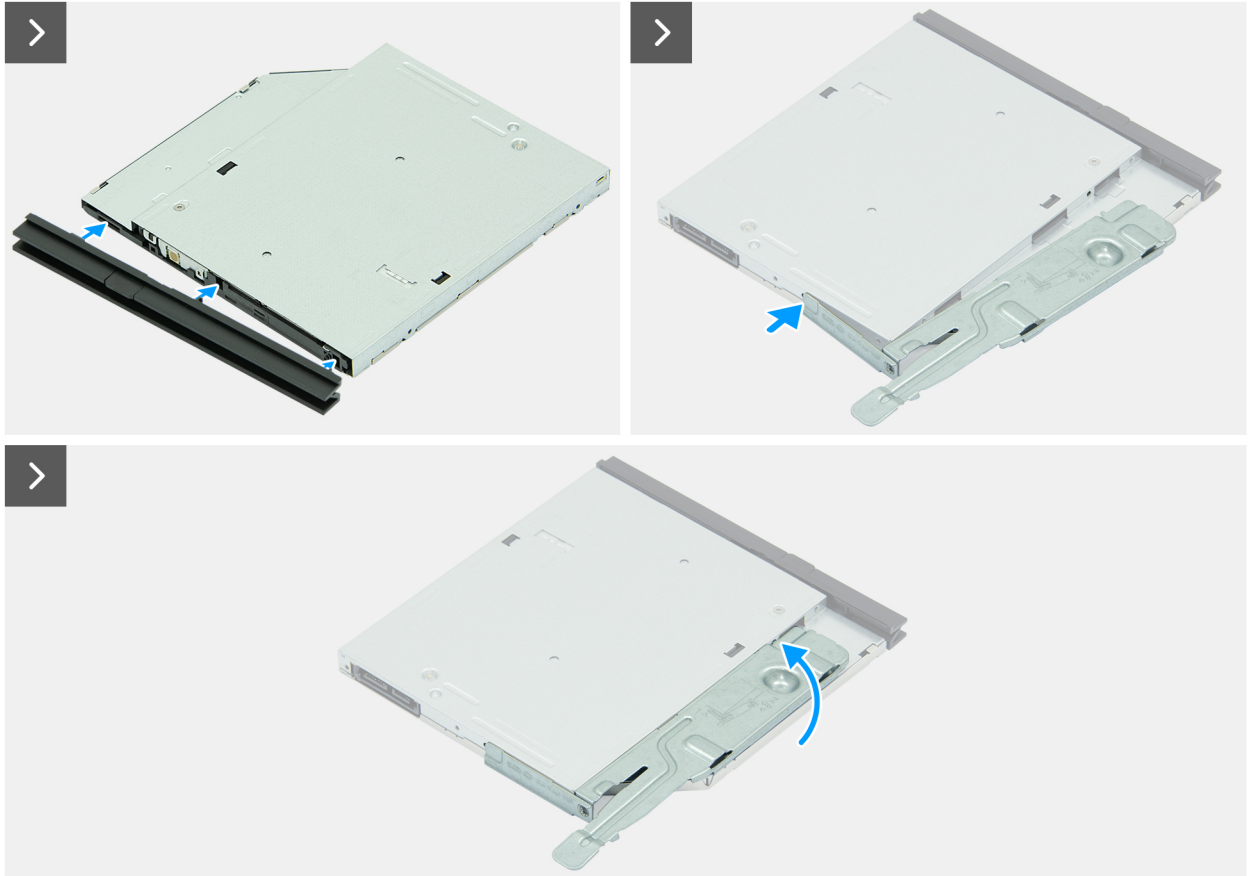

Figure 33. Installing the optical drive

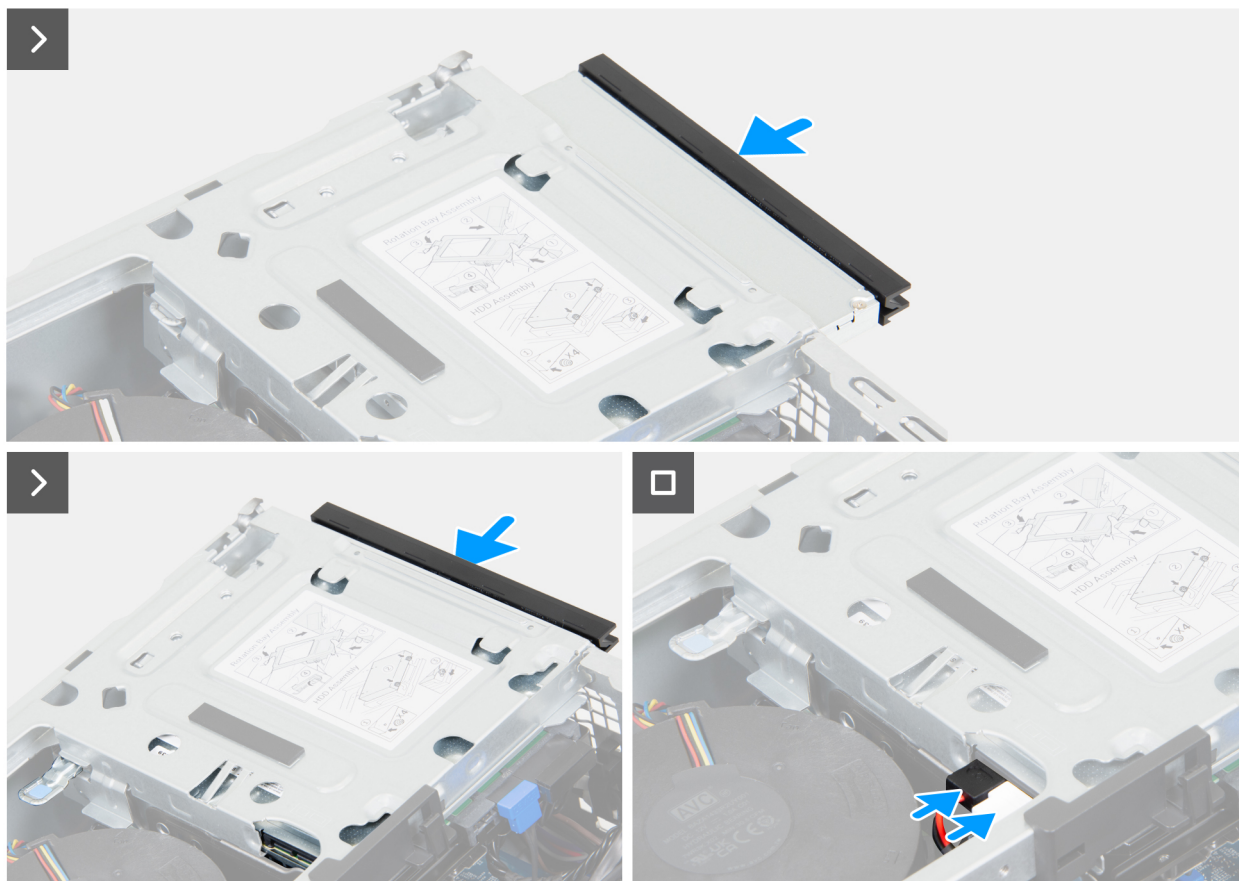

Figure 34. Installing the optical drive

Steps

1. Align the tabs on the bezel with the slots on the optical drive.
2. Press the bezel against the optical drive until the bezel clicks into place.
3. Insert the alignment post on the securing tab into the hole on the optical drive.
4. Rotate the securing tab inward until it clicks into place.
5. Slide the optical drive into the drive bay until the optical drive clicks into place.
6. Connect the data cable and the power cable to the optical drive.

Next steps

1. Install the [front cover](#).
2. Install the [side cover](#).
3. Install the [dust filter](#), if applicable.
4. Install the [cable cover](#), if applicable.
5. Follow the procedure in [After working inside your computer](#).

Drive bay

Removing the drive bay

Prerequisites

1. Follow the procedure in [Before working inside your computer](#).
2. Remove the [cable cover](#), if applicable.
3. Remove the [dust filter](#), if applicable.

4. Remove the [side cover](#).
5. Remove the [front cover](#).

About this task

NOTE: The drive bay is only available in computers shipped with a hard drive or an optical drive.

The following images indicate the location of the drive bay and provide a visual representation of the removal procedure.

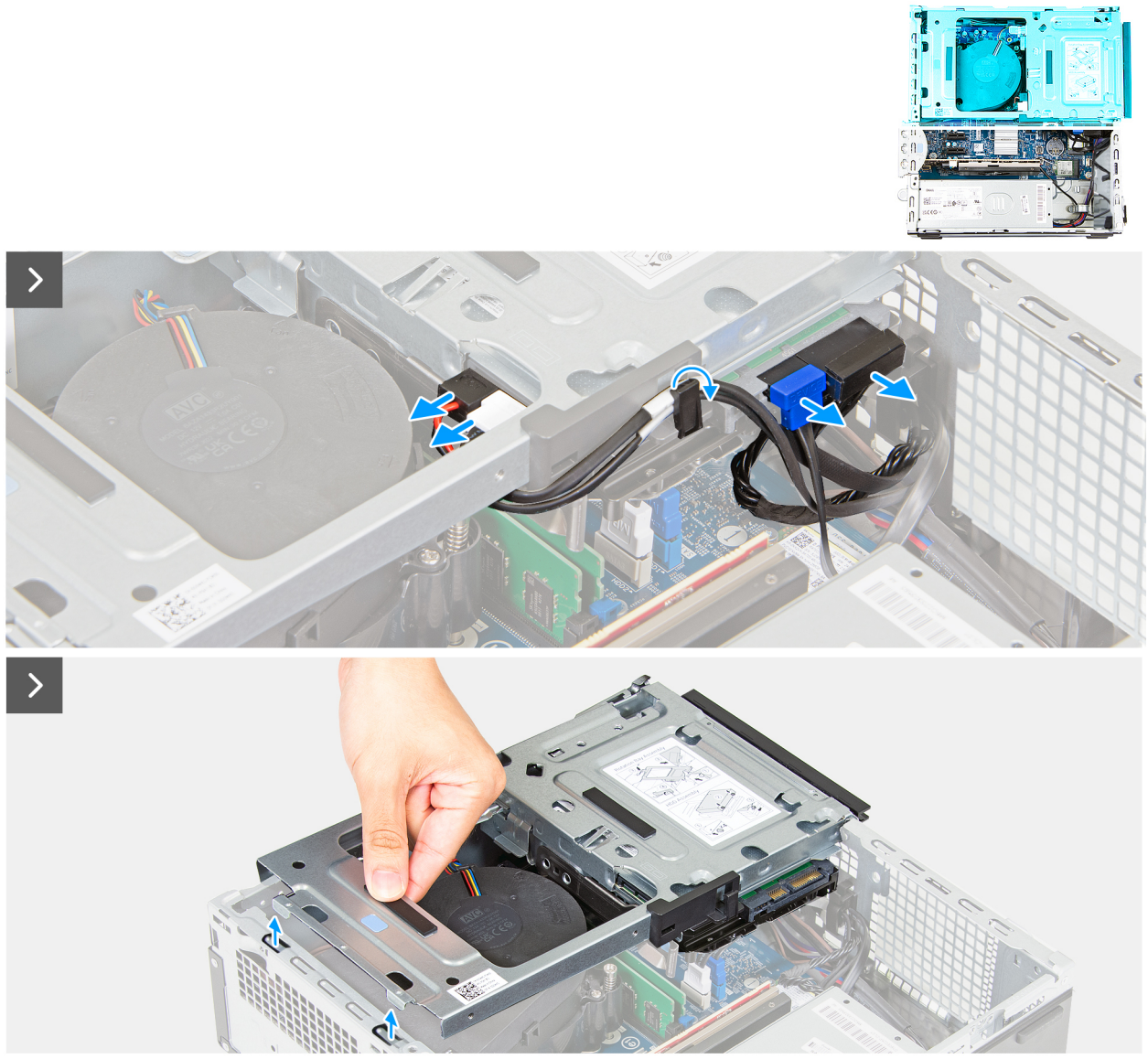

Figure 35. Removing the drive bay

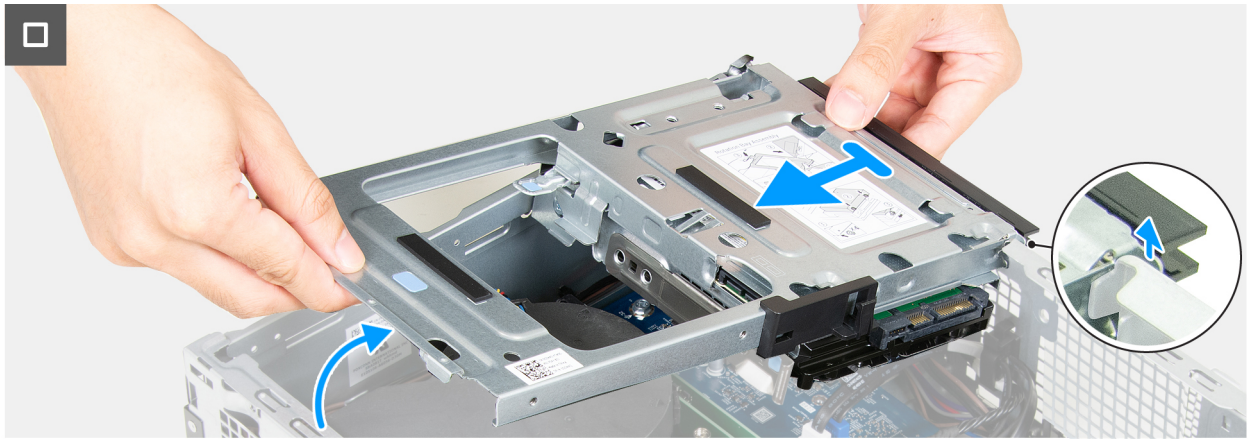

Figure 36. Removing the drive bay

Steps

1. Disconnect the data cable and the power cable from the optical drive.
2. Remove the data cable and the power cable from the routing guide on the drive bay.
3. Disconnect the data cable and the power cable from the hard drive.
4. Lift the drive bay at an angle to release the tabs from the chassis.
5. Hold the drive bay firmly with both hands, slide and remove the drive bay from the chassis.
6. Remove the [hard drive](#).

Installing the drive bay

Prerequisites

If you are replacing a component, remove the existing component before performing the installation process.

About this task

NOTE: To install the drive bay into a computer that did not have one previously installed, contact Dell to purchase a drive bay.

NOTE: Steps 1 to 6 are only applicable when installing a new drive bay purchased from Dell.

The following images indicate the location of the drive bay and provide a visual representation of the installation procedure.

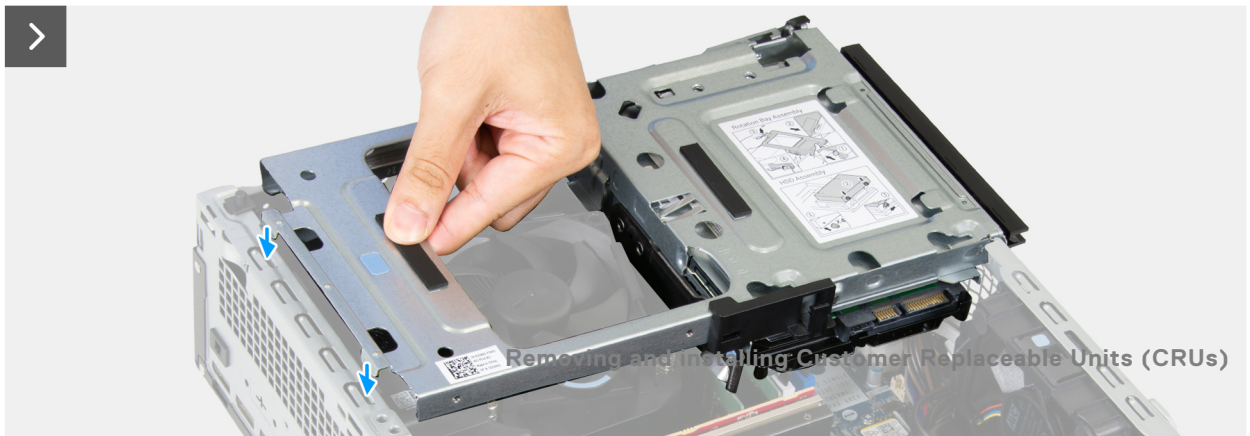
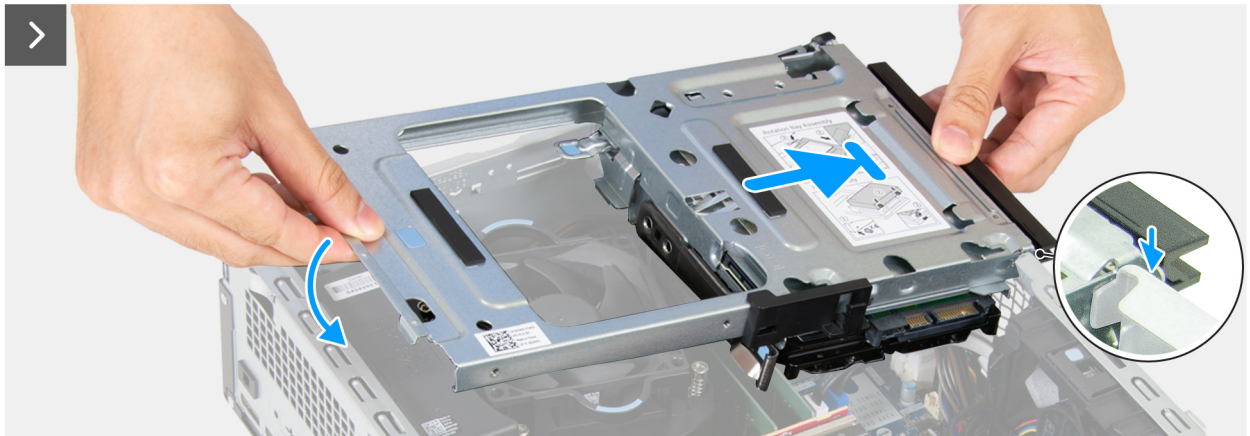
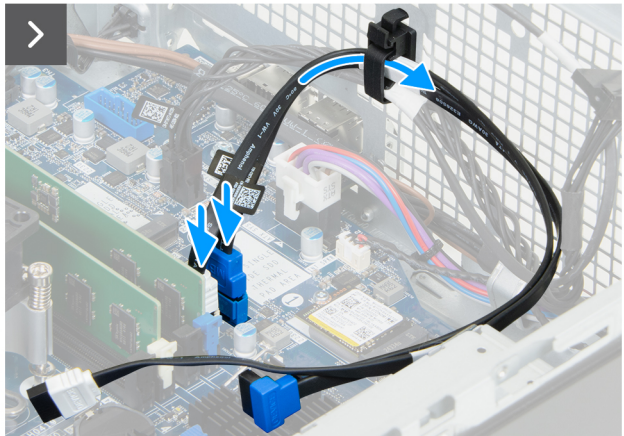
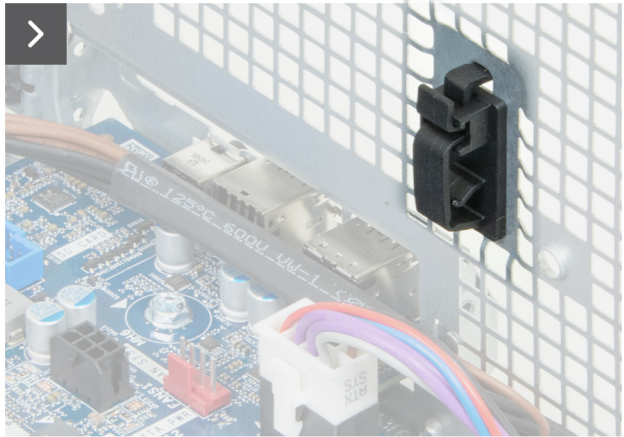
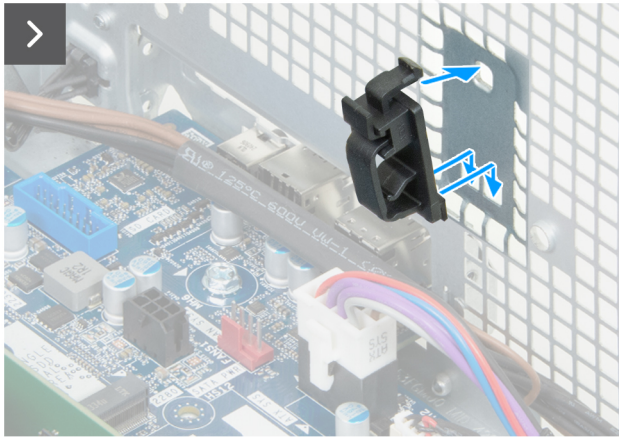

Removing and installing Customer Replaceable Units (CRUs)

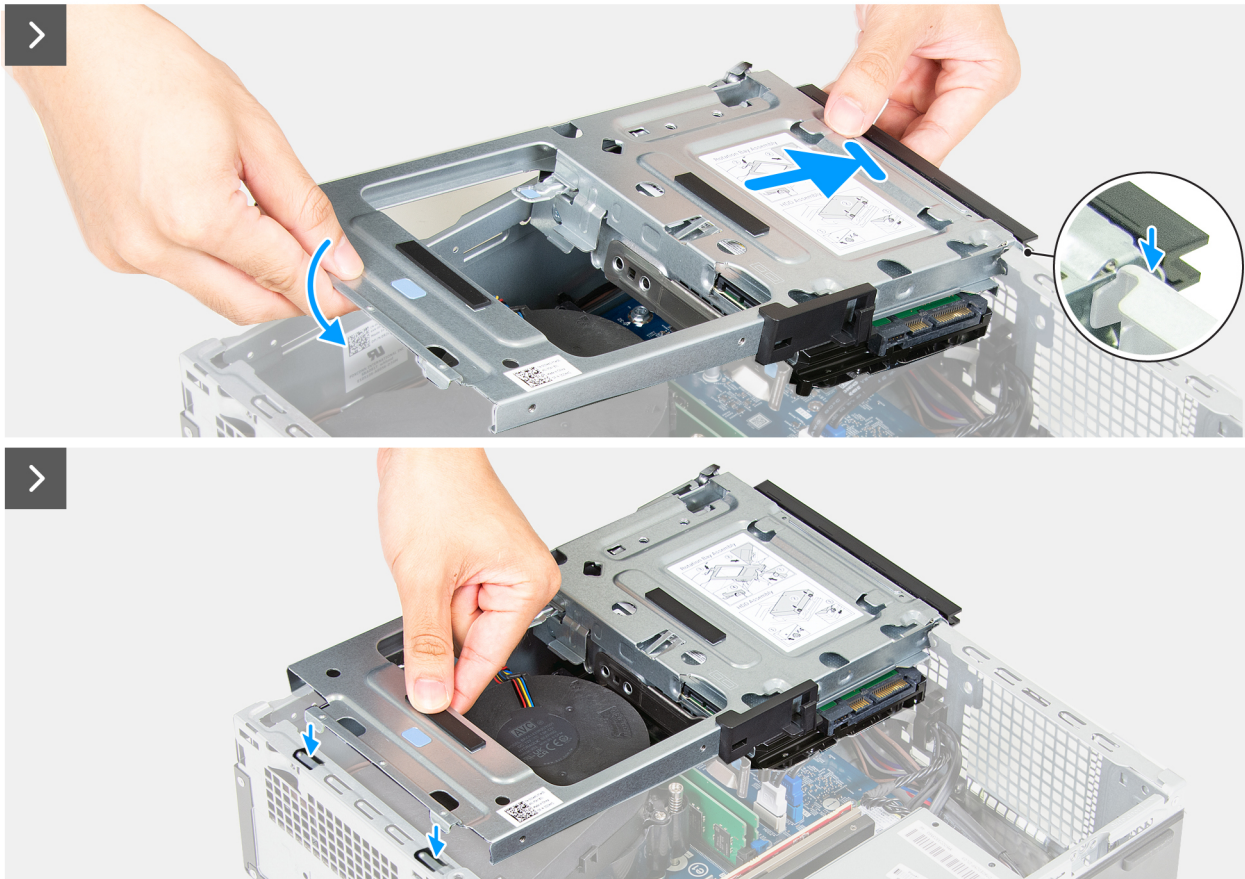

Figure 38. Installing the drive bay

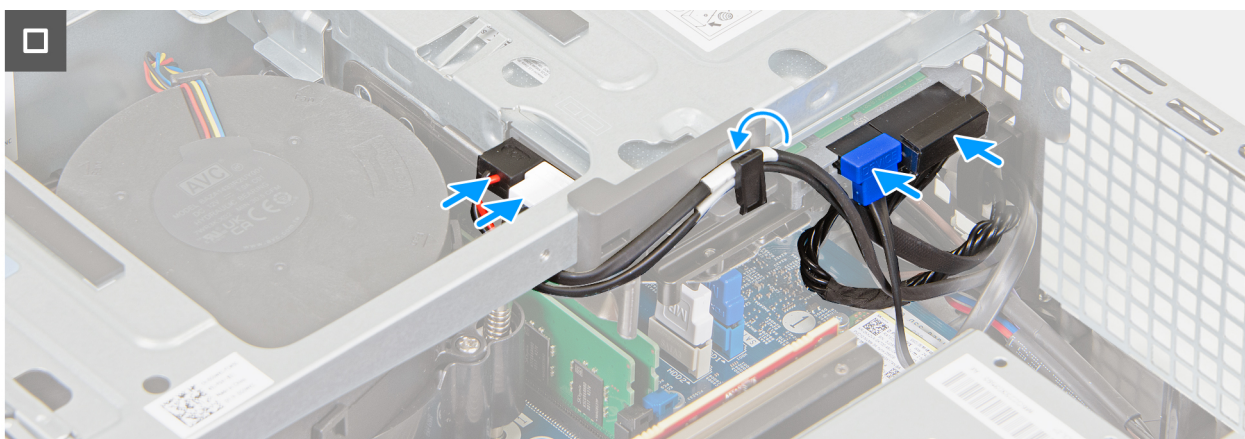

Figure 39. Installing the drive bay

Steps

1. Insert the tabs on the cable clip through the slots on the chassis and press the cable clip into place.

2. Connect the hard-drive and optical drive power cable to its connector (SATA PWR) on the system board.
3. Route the hard-drive and optical drive power cable through the cable clip on the chassis.
4. Connect the optical-drive data cable to its connector (SATA - 3) on the system board.
5. Connect the hard-drive data cable to its connector (SATA - 0) on the system board.
6. Route the hard-drive and optical drive data cables through the cable clip on the chassis.
7. Install the [hard drive](#).
8. Holding the drive bay firmly with both hands, then slide and secure one side of the drive bay to the chassis.
9. Press down the other end of the drive bay securing the tabs on the drive bay with the slots on the chassis.
10. Connect the hard-drive data cable and power cables to the hard drive.
11. Connect the optical-drive data cable and power cables to the optical drive.
12. Route the optical-drive data and power cable through the guide on the drive bay.

Next steps

1. Install the [front cover](#).
2. Install the [side cover](#).
3. Install the [dust filter](#), if applicable.
4. Install the [cable cover](#), if applicable.
5. Follow the procedure in [After working inside your computer](#).

Hard drive

Removing the hard drive

Prerequisites

1. Follow the procedure in [Before working inside your computer](#).
2. Remove the [cable cover](#), if applicable.
3. Remove the [dust filter](#), if applicable.
4. Remove the [side cover](#).
5. Remove the [front cover](#).
6. Remove the [drive bay](#), if applicable.

About this task

The following images indicate the location of the hard drive and provide a visual representation of the removal procedure.



4x
6-32#



Figure 40. Removing the hard drive

Steps

1. Flip the drive bay over to reveal the hard drive.
2. While pulling the securing tab away from the side of the hard drive, slide and lift the hard disk at an angle off the drive bay.
3. Remove the four screws (6-32#) from the hard drive.

Installing the hard drive

Prerequisites

If you are replacing a component, remove the existing component before performing the installation procedure.

About this task

The following images indicate the location of the hard drive and provide a visual representation of the installation procedure.



4x
6-32#



Figure 41. Installing the hard drive

Steps

1. Replace the four screws (6-32#) on the hard drive.
2. Align the screws on the hard drive with the grooves on the drive bay and slide the hard drive until it clicks into place.
3. Flip over the drive bay.

Next steps

1. Install the [drive bay](#), if applicable.
2. Install the [front cover](#).
3. Install the [side cover](#).
4. Install the [dust filter](#), if applicable.
5. Install the [cable cover](#), if applicable.
6. Follow the procedure in [After working inside your computer](#).

Intrusion switch

Removing the intrusion switch

Prerequisites

1. Follow the procedure in [Before working inside your computer](#).
2. Remove the [cable cover](#), if applicable.
3. Remove the [dust filter](#), if applicable.
4. Remove the [side cover](#).
5. Remove the [front cover](#).
6. Remove the [drive bay](#), if applicable.

About this task

The following image indicates the location of the intrusion switch and provides a visual representation of the removal procedure.



Figure 42. Removing the intrusion switch

Steps

1. Disconnect the intrusion-switch cable from its connector (INTRUSION) on the system board.
2. Slide and lift the Intrusion switch away from the computer.

Installing the Intrusion switch

Prerequisites

If you are replacing a component, remove the existing component before performing the installation procedure.

About this task

The following image indicates the location of the Intrusion switch and provides a visual representation of the installation procedure.

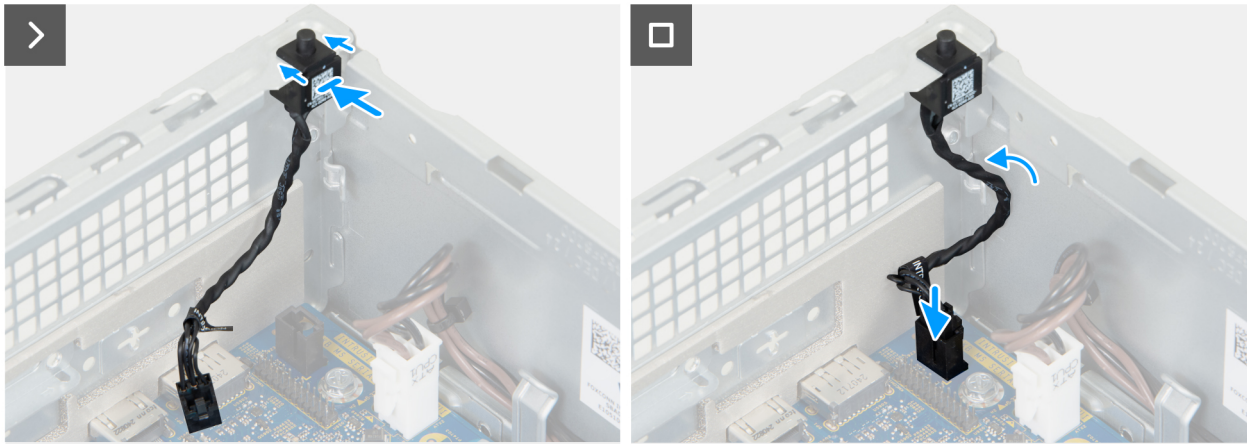

Figure 43. Installing the Intrusion switch

Steps

1. Slide the intrusion switch into the slot on the chassis.
2. Connect the intrusion-switch cable to its connector (INTRUSION) on the system board.

Next steps

1. Install the [drive bay](#), if applicable.
2. Install the [front cover](#).
3. Install the [side cover](#).
4. Install the [dust filter](#), if applicable.
5. Install the [cable cover](#), if applicable.
6. Follow the procedure in [After working inside your computer](#).

Power button

Removing the power button

Prerequisites

1. Follow the procedure in [Before working inside your computer](#).
2. Remove the [cable cover](#), if applicable.
3. Remove the [dust filter](#), if applicable.
4. Remove the [side cover](#).
5. Remove the [front cover](#).
6. Remove the [drive bay](#), if applicable.

About this task

The following image indicates the location of the power button and provides a visual representation of the removal procedure.

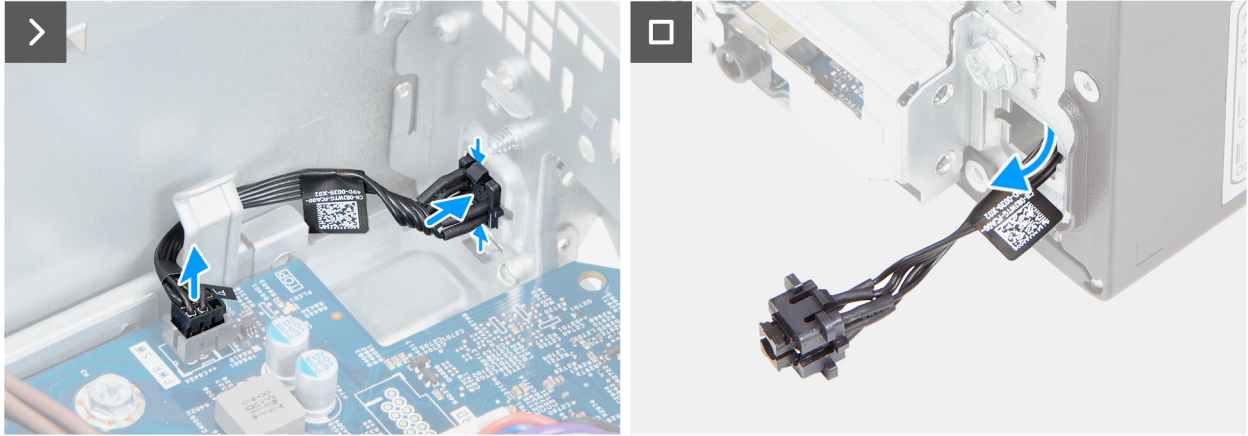
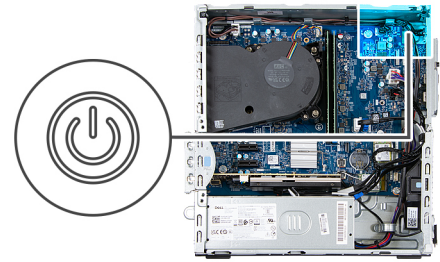

Figure 44. Removing the power button

Steps

1. Remove the processor power cables from the routing guide on the chassis.
2. Move the processor cables off the power-button cable.
3. Disconnect the power-button cable from its connector (PWR SW) on the system board.
4. Pinch the release tabs on the power button to release it from the slot on the chassis.
5. Route the power button along with its cable through the slot on the chassis.
6. Remove the power button and its cable from the front of the chassis.

Installing the power button

Prerequisites

If you are replacing a component, remove the existing component before performing the installation process.

About this task

The following image indicates the location of the power button and provides a visual representation of the installation procedure.



Figure 45. Installing the power button

Steps

1. Thread the power-button module cable through the slot on the front of the chassis.
2. Align the tabs on the side of the power button with the cutouts on the slot in the chassis.
3. Press the power-button module into its slot on the chassis.
4. Connect the power-button cable to its connector (PWR SW) on the system board.
5. Route the processor-power cable through the routing guide on the chassis.

Next steps

1. Install the [drive bay](#), if applicable.
2. Install the [front cover](#).
3. Install the [side cover](#).
4. Install the [dust filter](#), if applicable.
5. Install the [cable cover](#), if applicable.
6. Follow the procedure in [After working inside your computer](#).

Removing and installing Field Replaceable Units (FRUs)

The replaceable components in this chapter are Field Replaceable Units (FRUs).

CAUTION: The information in this removing and installing FRUs section is intended for authorized service technicians only.

CAUTION: To avoid any potential damage to the component or loss of data, Dell Technologies recommends that an authorized service technician replaces the Field Replaceable Units (FRUs).

CAUTION: Your warranty does not cover damages that may occur during FRU repairs that are not authorized by Dell Technologies.

NOTE: The images in this document may differ from your computer depending on the configuration you ordered.

Antenna modules

Removing the antenna modules

CAUTION: The information in this section is intended for authorized service technicians only.

Prerequisites

1. Follow the procedure in [Before working inside your computer](#).
2. Remove the [cable cover](#), if applicable.
3. Remove the [dust filter](#), if applicable.
4. Remove the [side cover](#).
5. Remove the [front cover](#).
6. Remove the [wireless card](#).

About this task

The following images indicate the location of the antenna modules and provide a visual representation of the removal procedure.



1x
6-32#

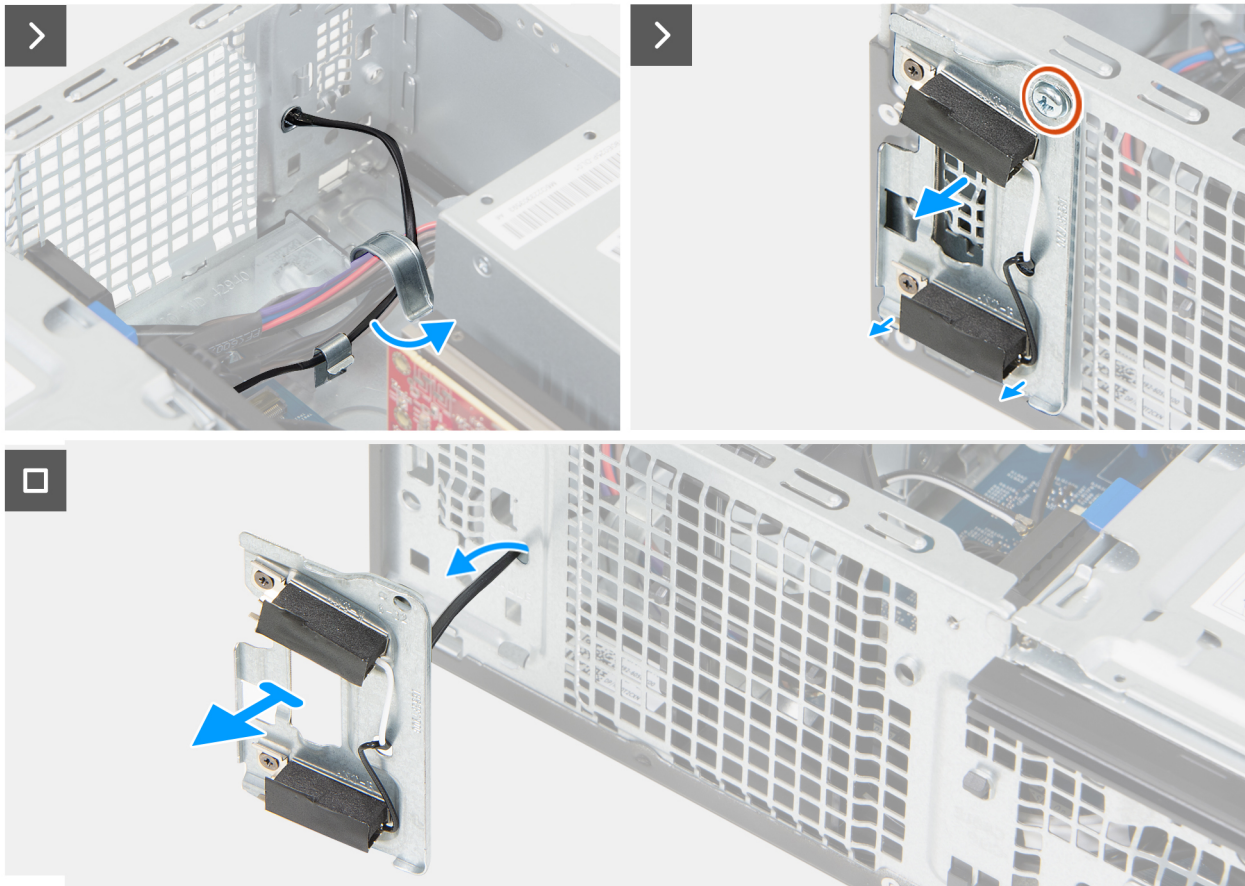

Figure 46. Removing the antenna modules

Steps

1. Gently remove the antenna cable from the routing guide on the chassis interior.
2. Remove the screw (6-32#) that secures the antenna modules to the chassis.
3. Thread the antenna cables through the slot on the chassis.
4. Lift the antenna modules along with its cables off the chassis

Installing the antenna modules

CAUTION: The information in this section is intended for authorized service technicians only.

Prerequisites

If you are replacing a component, remove the existing component before performing the installation procedure.

About this task

The following images indicate the location of the antenna modules and provide a visual representation of the installation procedure.



1x
6-32#

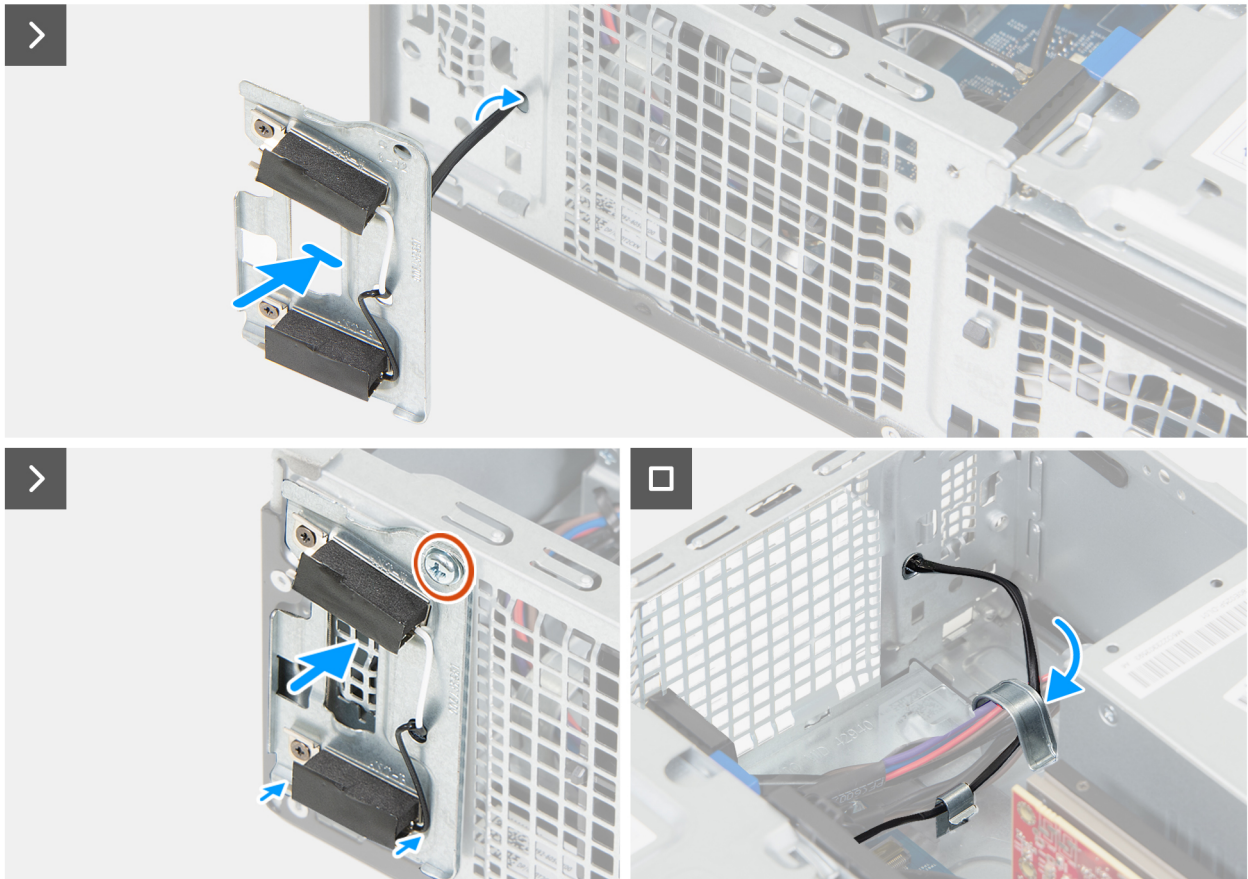

Figure 47. Installing the antenna modules

Steps

1. Thread the antenna cables through the slot on the chassis.
2. Place the antenna modules on the chassis.
3. Align the screw hole on the antenna modules with the screw hole on the chassis.
4. Replace the captive screw (6-32#) that secures the antenna modules to the chassis.
5. Route the antenna cables through the routing guide on the chassis.

Next steps

1. Install the [wireless card](#).
2. Install the [front cover](#).
3. Install the [side cover](#).
4. Install the [dust filter](#), if applicable.
5. Install the [cable cover](#), if applicable.
6. Follow the procedure in [After working inside your computer](#).

Power-supply unit

Removing the power-supply unit

 **CAUTION:** The information in this section is intended for authorized service technicians only.

Prerequisites

1. Follow the procedure in [Before working inside your computer](#).
2. Remove the [cable cover](#), if applicable.
3. Remove the [dust filter](#), if applicable.
4. Remove the [side cover](#).
5. Remove the [front cover](#).
6. Remove the [drive bay](#), if applicable.

About this task

The following images indicate the location of the power-supply unit and provide a visual representation of the removal procedure.



3x
6-32#

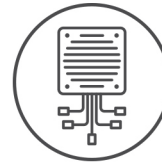

Figure 48. Removing the power-supply unit

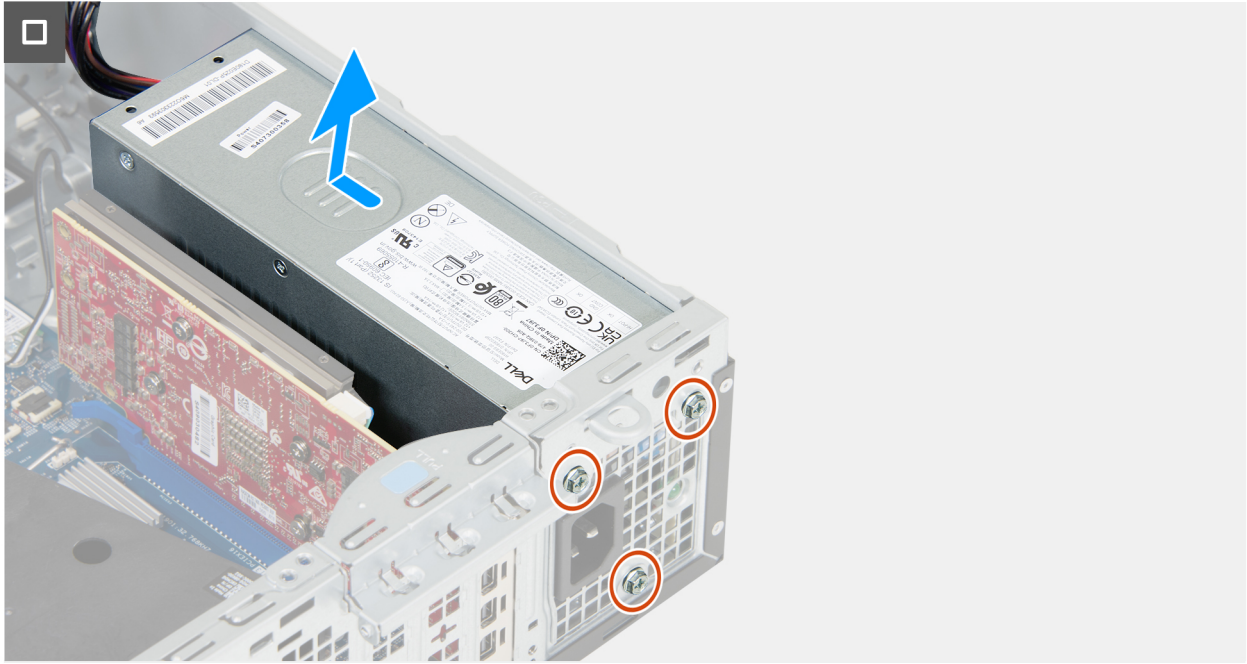

Figure 49. Removing the power-supply unit

Steps

1. Disconnect the power-supply cables from their connectors (ATX CPU1 and ATX SYS) on the system board.
2. Remove the power-supply cables from the routing guides on the chassis.
3. Remove the three screws (6-32#) that secure the power-supply unit to the chassis.
4. Slide and lift the power-supply unit off the chassis.

Installing the power-supply unit

CAUTION: The information in this section is intended for authorized service technicians only.

Prerequisites

If you are replacing a component, remove the existing component before performing the installation procedure.

About this task

The following images indicate the location of the power-supply unit and provide a visual representation of the installation procedure.



3x
6-32#

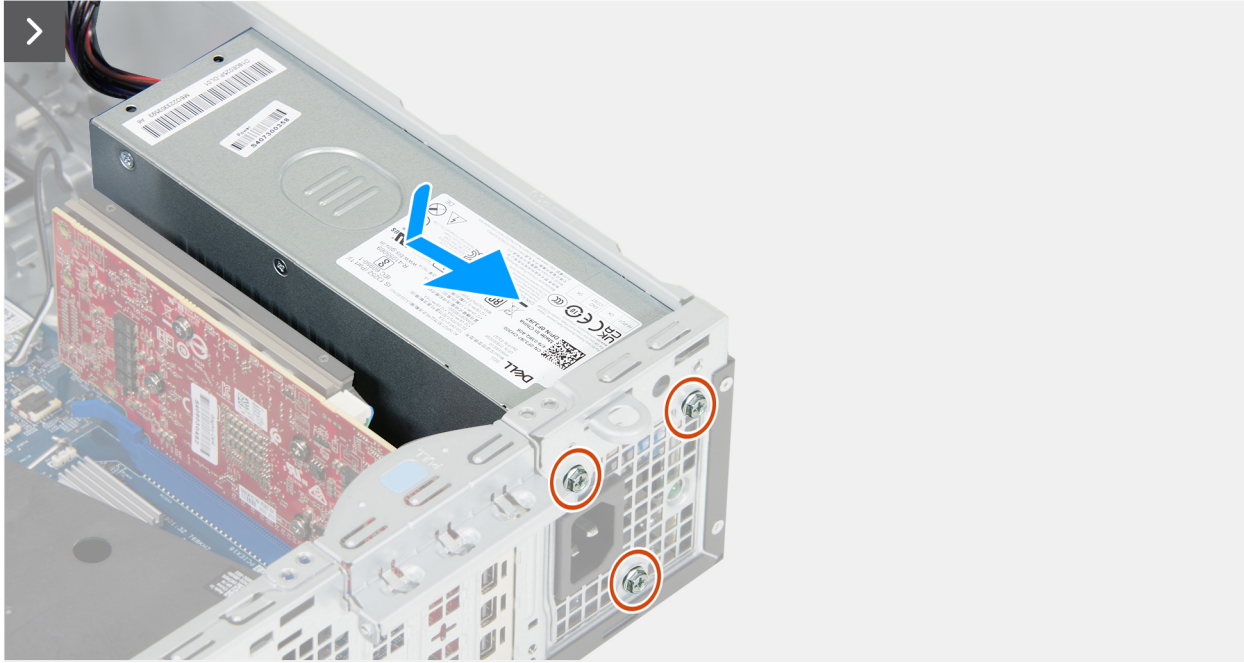
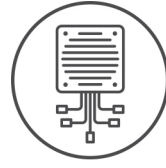

Figure 50. Installing the power-supply unit



Figure 51. Installing the power-supply unit

Steps

1. Place the power-supply unit on the chassis and slide it towards the back of the chassis.
2. Replace the three screws (6-32#) that secure the power-supply unit to the chassis.
3. Route the power-supply cables through their routing guides on the chassis.
4. Connect the power-supply cables to their connectors (ATX CPU1 and ATX SYS) on the system board.

Next steps

1. Install the [drive bay](#), if applicable.
2. Install the [front cover](#).
3. Install the [side cover](#).
4. Install the [dust filter](#), if applicable.
5. Install the [cable cover](#), if applicable.
6. Follow the procedure in [After working inside your computer](#).

Processor fan and heat-sink assembly

Removing the processor fan and heat-sink assembly

⚠ CAUTION: The information in this section is intended for authorized service technicians only.

Prerequisites

1. Follow the procedure in [Before working inside your computer](#).
2. Remove the [cable cover](#), if applicable.
3. Remove the [dust filter](#), if applicable.
4. Remove the [side cover](#).
5. Remove the [front cover](#).
6. Remove the [drive bay](#), if applicable.

About this task

The following images indicate the location of the processor fan and heat-sink assembly and provide a visual representation of the removal procedure.

CAUTION: For maximum cooling of the processor, do not touch the heat-transfer areas on the heat sink. The oils in your skin can reduce the heat-transfer capability of the thermal grease.

NOTE: The heat sink may become hot during normal operation. Allow sufficient time for the heat sink to cool before touching it.

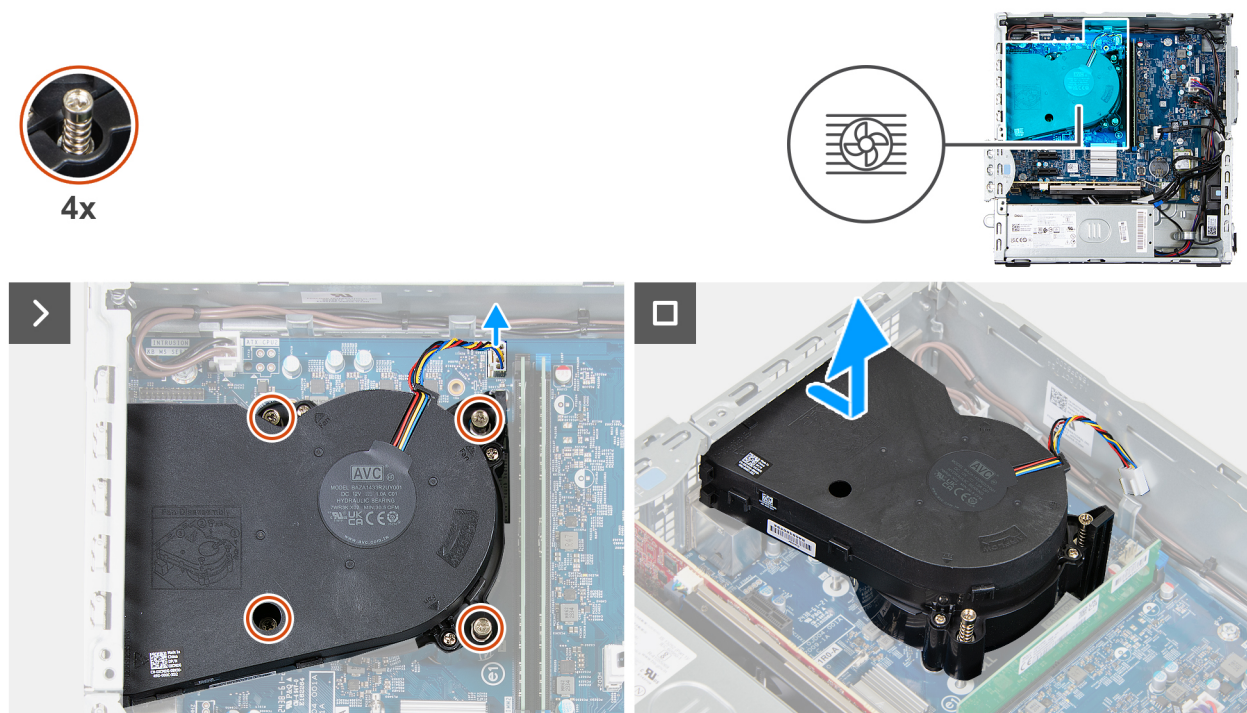

Figure 52. Removing the processor fan and heat-sink assembly

Steps

1. Disconnect the processor-fan cable from its connector (FAN CPU) on the system board.
2. In the reverse sequential order (4, 3, 2, 1), loosen the four captive screws that secure the processor fan and heat-sink assembly to the system board.
3. Lift the processor fan and heat-sink assembly off the system board.

Installing the processor fan and heat-sink assembly

CAUTION: The information in this section is intended for authorized service technicians only.

Prerequisites

If you are replacing a component, remove the existing component before performing the installation procedure.

About this task

The following image indicates the location of the processor fan and heat-sink assembly and provides a visual representation of the installation procedure.

NOTE: If either the processor fan and heat-sink assembly is replaced, use the thermal grease provided in the kit for thermal conductivity.

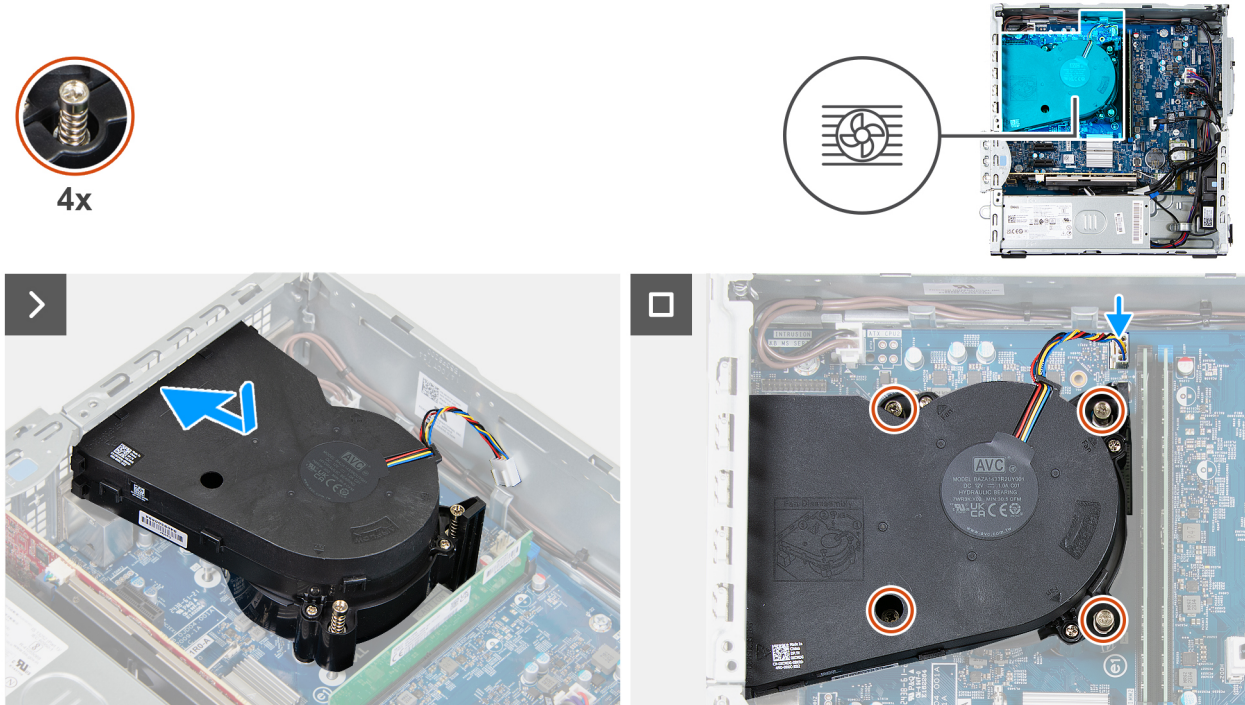

Figure 53. Installing the processor fan and heat-sink assembly

Steps

1. Place the processor fan and heat-sink assembly on the system board and align the captive screws to the screw holes on the system board.
2. In sequential order (1, 2, 3, 4), tighten the four captive screws that secure the processor fan and heat-sink assembly to the system board.
3. Connect the processor-fan cable to its connector (FAN CPU) on the system board.

Next steps

1. Install the [drive bay](#), if applicable.
2. Install the [front cover](#).
3. Install the [side cover](#).
4. Install the [dust filter](#), if applicable.
5. Install the [cable cover](#), if applicable.
6. Follow the procedure in [After working inside your computer](#).

External port (optional module)

NOTE: For more information about the ports supported by the external port (optional module slot), see [Specifications](#).

Removing the optional-port module

CAUTION: The information in this section is intended for authorized service technicians only.

Prerequisites

1. Follow the procedure in [Before working inside your computer](#).
2. Remove the [cable cover](#), if applicable.
3. Remove the [dust filter](#), if applicable.
4. Remove the [side cover](#).
5. Remove the [front cover](#).
6. Remove the [drive bay](#), if applicable.
7. Remove the [processor fan and heat-sink assembly](#).

About this task

NOTE: The procedure to remove the optional-port module is the same for all the different optional-ports that may be installed on your computer.

The following image indicates the location of the optional-port module and provides a visual representation of the removal procedure.

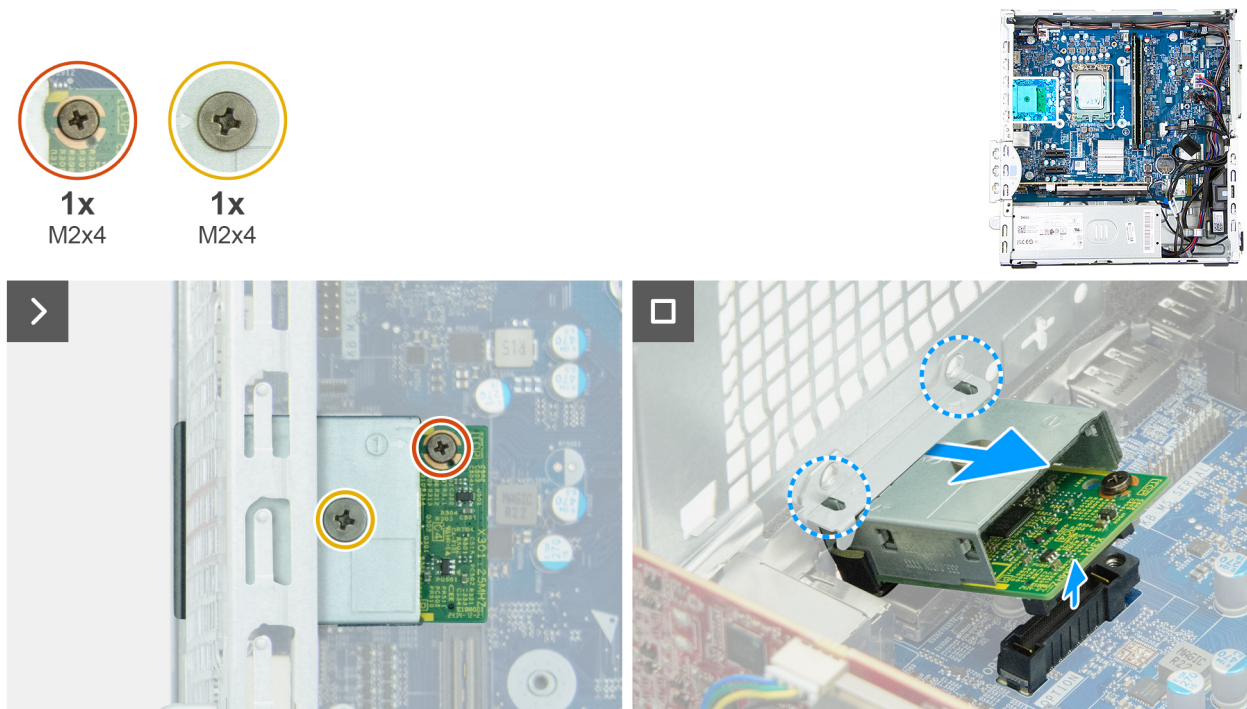

Figure 54. Removing the optional-port module

Steps

1. Remove the screw (M2x4) that secures the optional-port cover to the optional-port module.
2. Remove the screw (M2x4) that secures the optional-port module to the system board.
3. Lift the optional-port module at an angle and remove the tabs on the optional-port module from the slots on the chassis.
4. Remove the optional-port module off the system board.

Installing the optional-port module

CAUTION: The information in this section is intended for authorized service technicians only.

Prerequisites

If you are replacing a component, remove the existing component before performing the installation process.

About this task

NOTE: The optional-port modules are mutually exclusive; only a single module can be installed at a time.

The following images indicate the location of the optional-port module and provide a visual representation of the installation procedure.

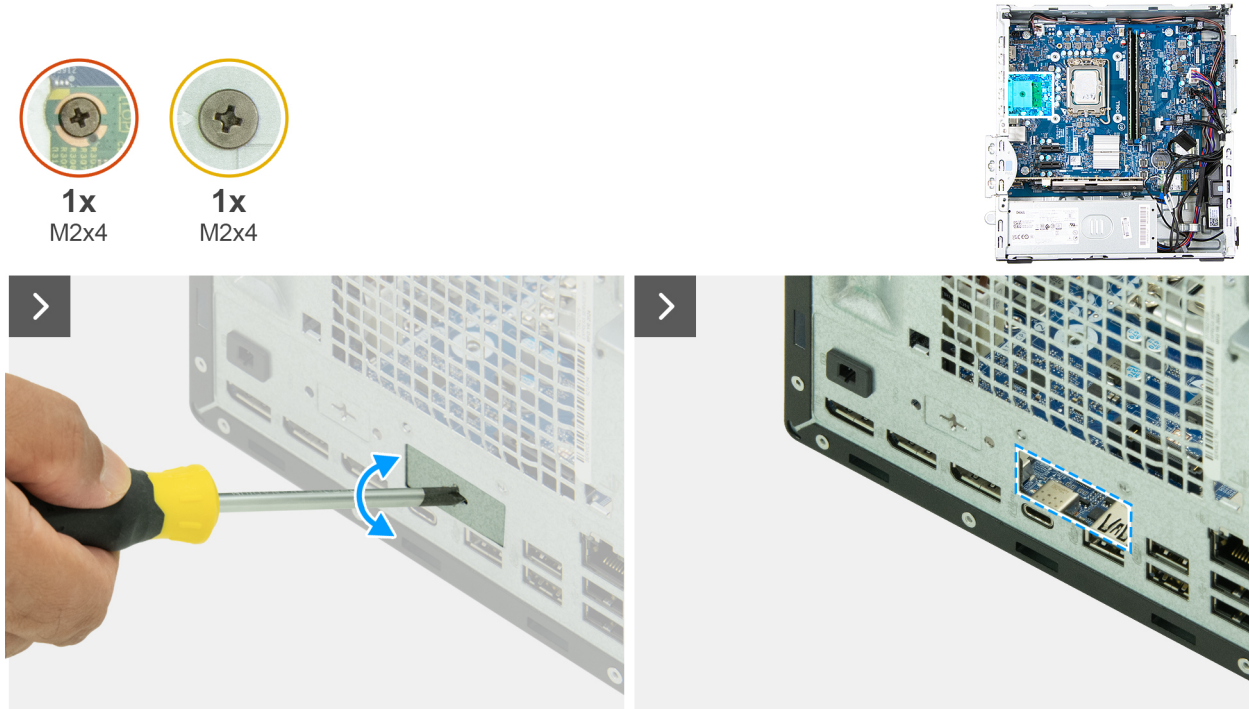

Figure 55. Installing the optional-port module

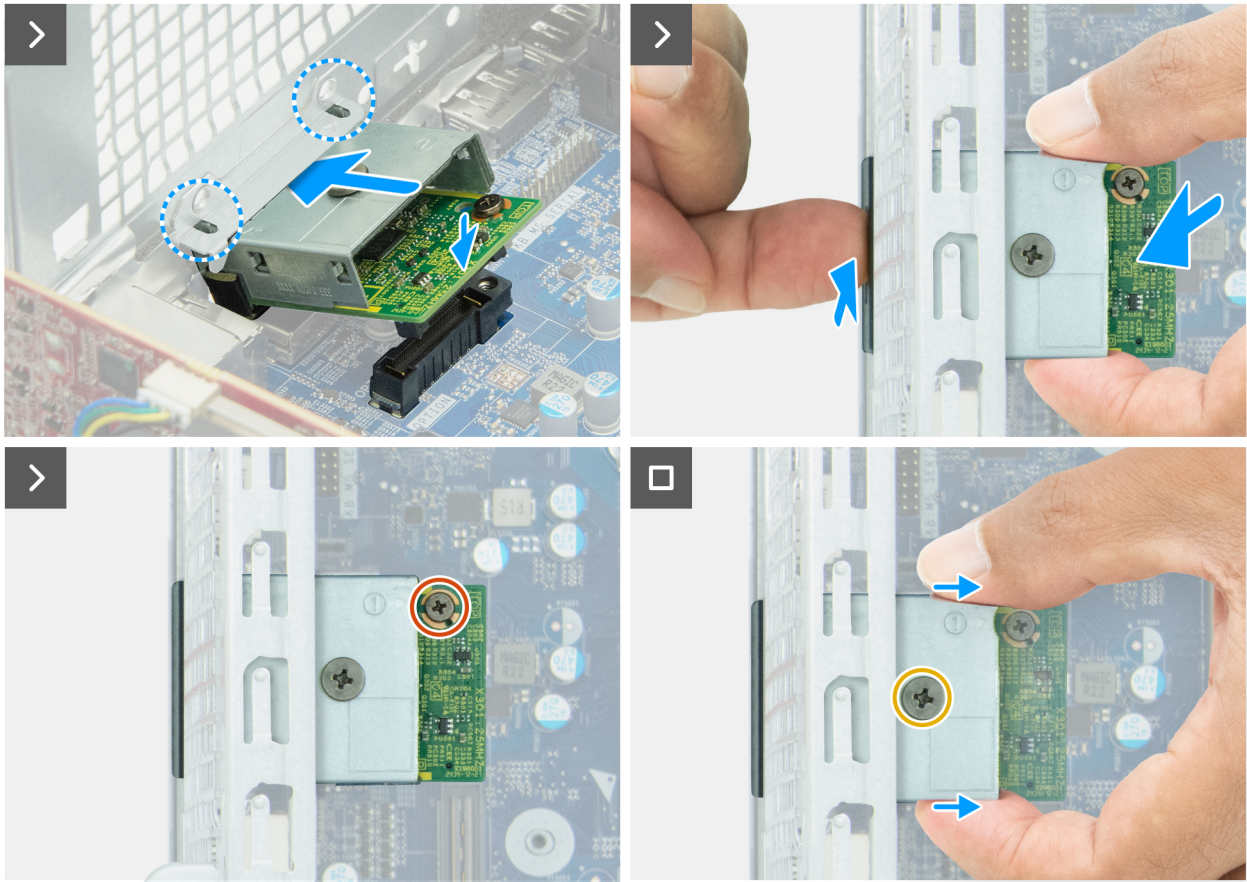

Figure 56. Installing the optional-port module

Steps

1. Using a screwdriver, push against the optional-port cover until it comes off.
 - NOTE:** This step is only applicable if you are installing the optional-port module on a computer that did not previously have it installed.
2. Place the expansion-port module at an angle and align the tabs on the module to the slots on the chassis.
3. Align the expansion-port module to the slot on the chassis and connect the module to the connector on the system board (OPTION).
4. Replace the screw (M2x4) that secures the expansion-port module to the system board.
5. Align the screw on the expansion-port cover to the screw hole on the expansion-port module.
6. Replace the screw (M2x4) that secures the expansion-port cover to the expansion-port module.

Next steps

1. Install the [processor fan and heat-sink assembly](#).
2. Install the [drive bay](#), if applicable.
3. Install the [front cover](#).
4. Install the [side cover](#).
5. Install the [dust filter](#), if applicable.
6. Install the [cable cover](#), if applicable.
7. Follow the procedure in [After working inside your computer](#).

Serial-port module

Removing the serial-port module

 **CAUTION:** The information in this section is intended for authorized service technicians only.

Prerequisites

1. Follow the procedure in [Before working inside your computer](#).
2. Remove the [cable cover](#), if applicable.
3. Remove the [dust filter](#), if applicable.
4. Remove the [side cover](#).
5. Remove the [front cover](#).
6. Remove the [drive bay](#), if applicable.
7. Remove the [processor fan and heat-sink assembly](#).

About this task

The serial-port module is an optional component and may not be installed in your computer.

The following image indicates the location of the serial-port module and provides a visual representation of the removal procedure.



2x
M3

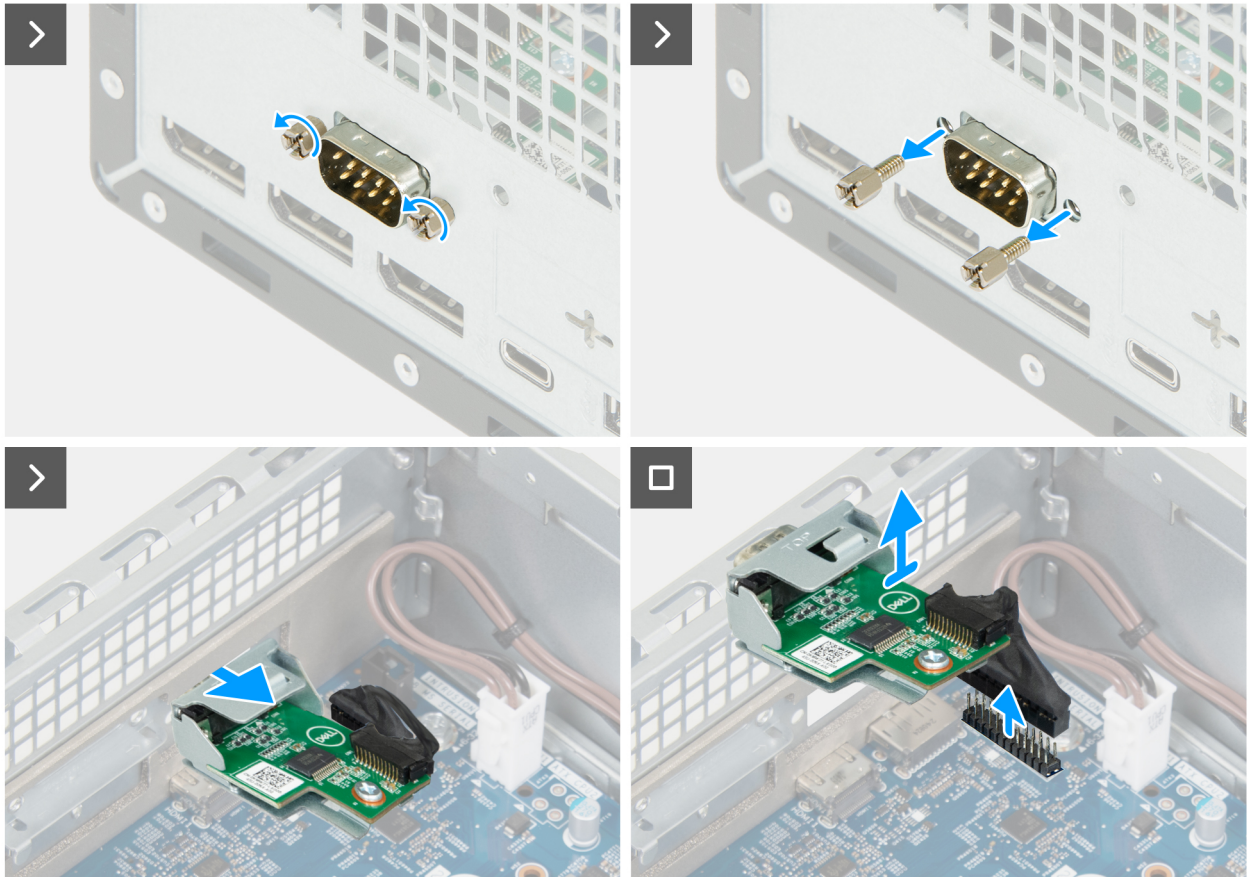

Figure 57. Removing the serial-port module

Steps

1. Remove the two screws (M3) that secure the optional serial-port module to the chassis.
2. Disconnect the serial-port module cable from the connector (KB MS SERIAL) on the system board.
3. Push the serial port through its slot on the chassis and lift the serial-port module off the system board.

Installing the serial-port module

CAUTION: The information in this section is intended for authorized service technicians only.

Prerequisites

If you are replacing a component, remove the existing component before performing the installation process.

About this task

The following image indicates the location of the serial-port module and provides a visual representation of the installation procedure.



2x
M3

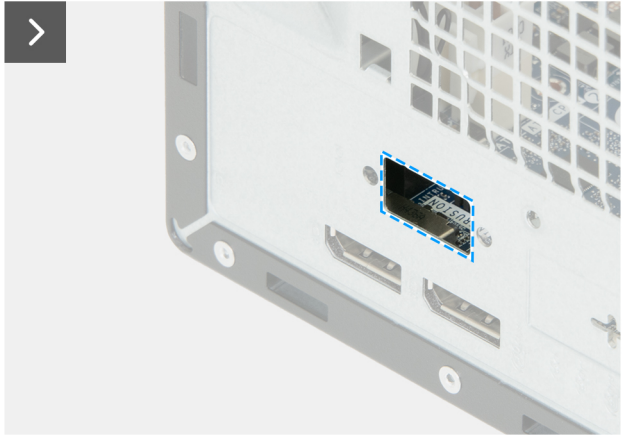
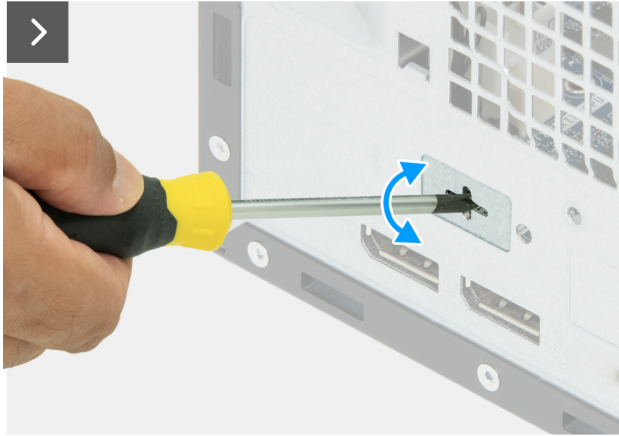

Figure 58. Installing the serial-port module

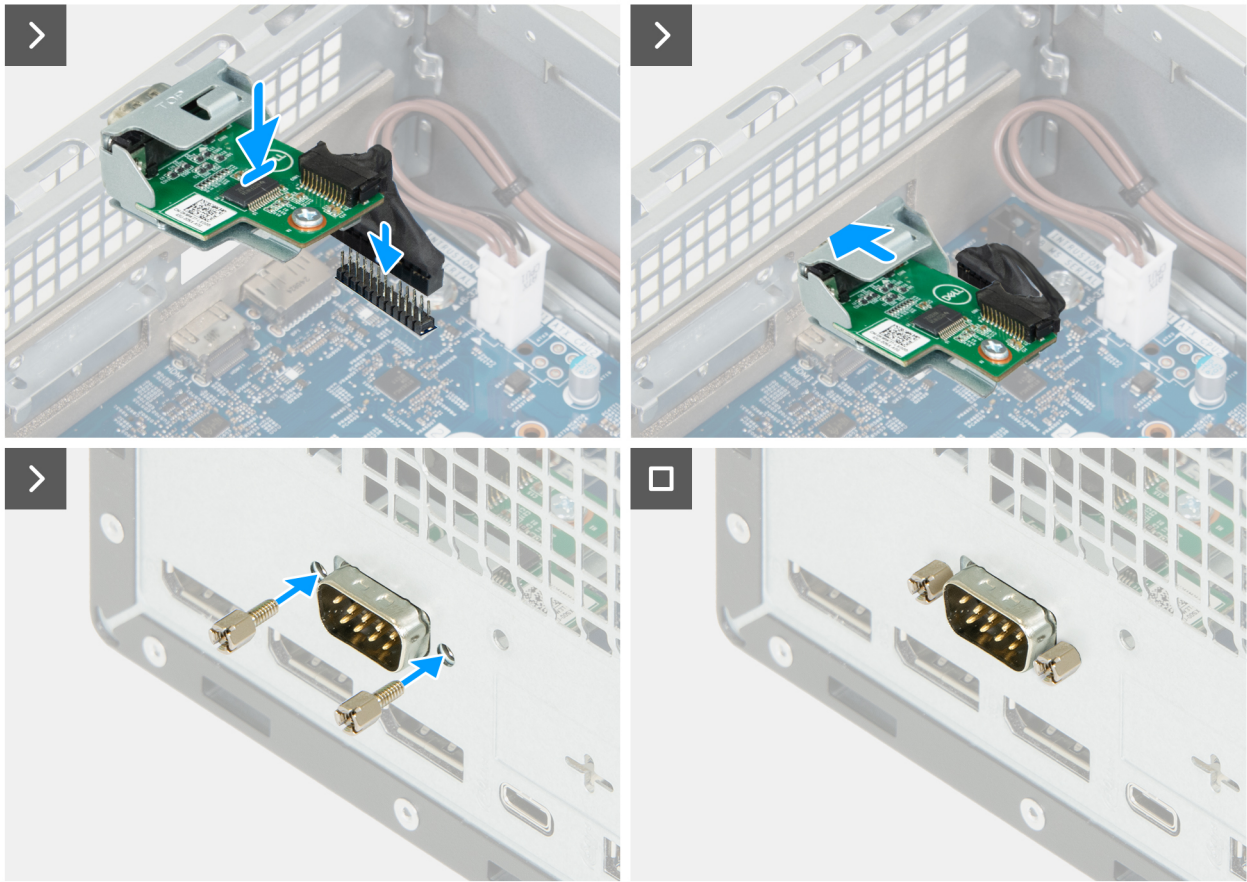

Figure 59. Installing the serial-port module

Steps

1. Using a screwdriver, push against the serial-port cover until it comes off.
 - NOTE:** This step is only applicable if the serial-port module is not previously installed on the computer.
2. Insert the serial-port module into its slot on the chassis.
3. Connect the serial-port module cable to its connector (KB MS SERIAL) on the system board.
4. Replace the two screws (M3) to secure the serial-port module to the chassis.

Next steps

1. Install the [processor fan and heat-sink assembly](#).
2. Install the [drive bay](#), if applicable.
3. Install the [front cover](#).
4. Install the [side cover](#).
5. Install the [dust filter](#), if applicable.
6. Install the [cable cover](#), if applicable.
7. Follow the procedure in [After working inside your computer](#).

Processor

Removing the processor

CAUTION: The information in this section is intended for authorized service technicians only.

Prerequisites

1. Follow the procedure in [Before working inside your computer](#).
2. Remove the [cable cover](#), if applicable.
3. Remove the [dust filter](#), if applicable.
4. Remove the [side cover](#).
5. Remove the [front cover](#).
6. Remove the [drive bay](#), if applicable.
7. Remove the [processor fan and heat-sink assembly](#).

About this task

The following images indicate the location of the processor and provide a visual representation of the removal procedure.

⚠ WARNING: The processor might still be hot after the computer is shut down. Allow the processor to cool down before removing it.

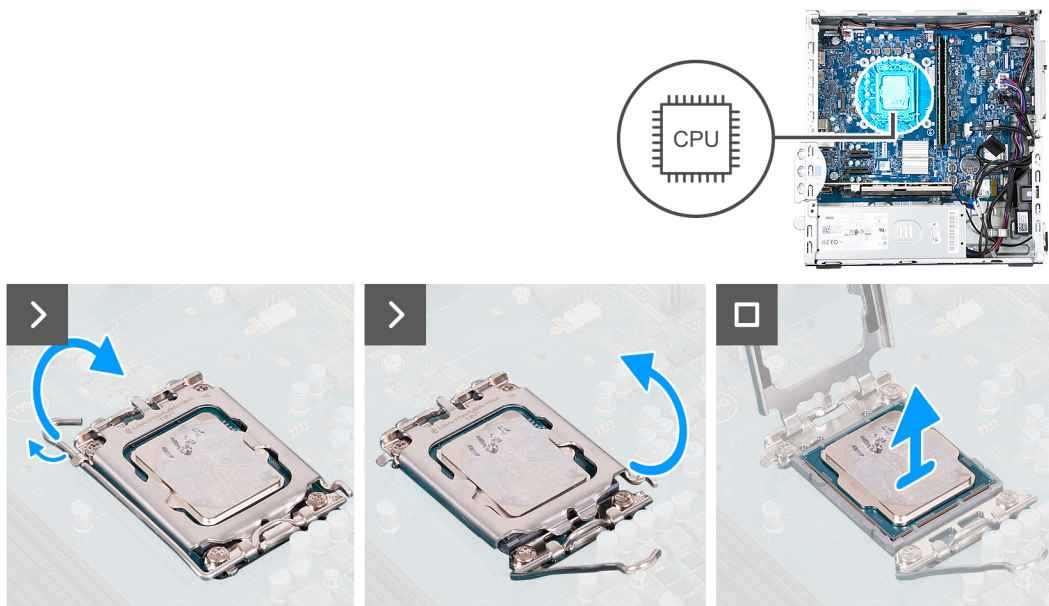

Figure 60. Removing the processor

Steps

1. Press the release lever down and then push it away from the processor to release it from the securing tab.
2. Extend the release lever completely and open the processor cover.

⚠ CAUTION: When removing the processor, do not touch any of the pins inside the socket or allow any objects to fall on the pins in the socket.

3. Gently lift the processor from the processor socket.

Installing the processor

⚠ CAUTION: The information in this section is intended for authorized service technicians only.

Prerequisites

If you are replacing a component, remove the existing component before performing the installation procedure.

About this task

The following images indicate the location of the processor and provide a visual representation of the installation procedure.

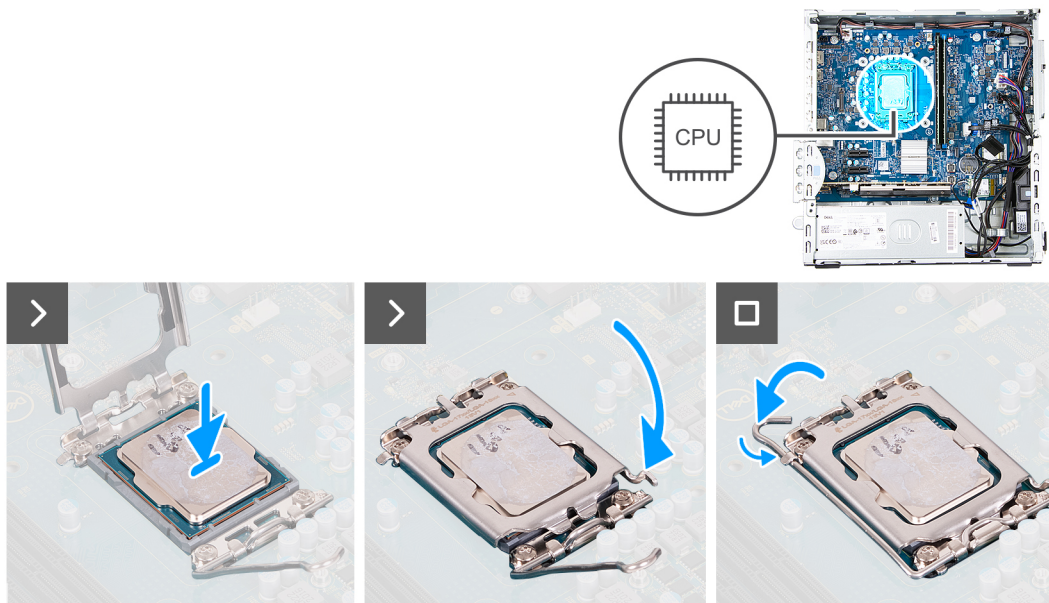

Figure 61. Installing the processor

Steps

1. Ensure that the release lever on the processor socket is fully extended in the open position.

NOTE: The pin-1 corner of the processor has a triangle that aligns with the triangle on the pin-1 corner on the processor socket. When the processor is properly seated, all four corners are aligned at the same height. If one or more corners of the processor are higher than the others, the processor is not seated properly.

2. Align the notches on the processor with the tabs on the processor socket and place the processor in the processor socket.

CAUTION: Ensure that the processor-cover notch is positioned underneath the alignment post.

3. When the processor is fully seated in the socket, pivot the release-lever down and place it under the tab on the processor cover.

Next steps

1. Install the [processor fan and heat-sink assembly](#).
2. Install the [drive bay](#), if applicable.
3. Install the [front cover](#).
4. Install the [side cover](#).
5. Install the [dust filter](#), if applicable.
6. Install the [cable cover](#), if applicable.
7. Follow the procedure in [After working inside your computer](#).

System board

Removing the system board

CAUTION: The information in this removal section is intended for authorized service technicians only.

Prerequisites

1. Follow the procedure in [Before working inside your computer](#).
2. Remove the [cable cover](#), if applicable.
3. Remove the [dust filter](#), if applicable.

4. Remove the [side cover](#).
5. Remove the [coin-cell battery cover](#).
6. Remove the [coin-cell battery](#).
7. Remove the [front cover](#).
8. Remove the [memory](#).
9. Remove the [M.2 2230 solid state drive](#), or the [M.2 2280 solid state drive](#), whichever is applicable.
10. Remove the [wireless card](#).
11. Remove the [graphics card](#), if applicable.
12. Remove the [drive bay](#), if applicable.
13. Remove the [processor fan and heat-sink assembly](#).
14. Remove the [serial-port module](#), if applicable.
15. Remove the [optional port module](#), if applicable.
16. Remove the [processor](#).

About this task

The following image indicates the connectors on your system board.

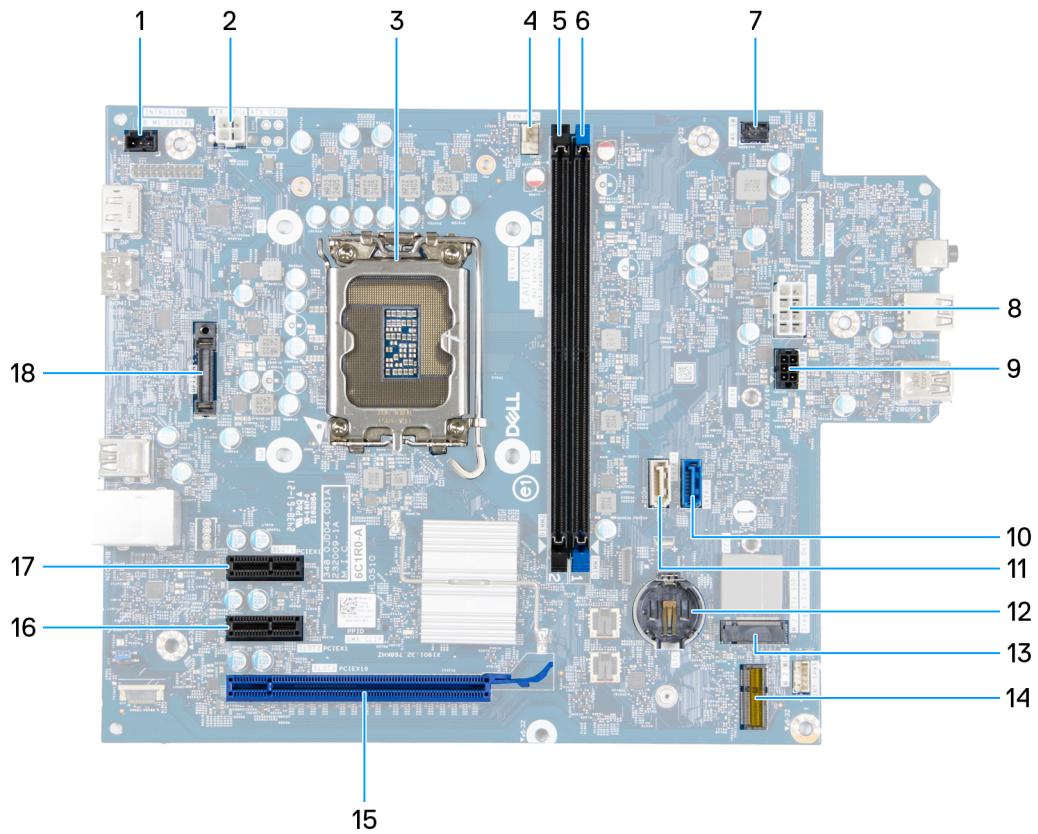

Figure 62. System board overview

1. Intrusion-switch connector (INTRUSION)
2. Processor-power connector (ATX CPU1)
3. Processor socket (CPU)
4. Processor-fan and heat-sink assembly connector (FAN CPU)
5. UDIMM memory slot (DIMM2)
6. UDIMM memory slot (DIMM1)
7. Power-button connector (PWR SW)
8. System-board power connector (ATX SYS)
9. Hard-drive and optical-drive power connector (SATA PWR)

- 10. Hard-drive data connector (SATA - 0)
- 11. Optical-drive data connector (SATA - 3)
- 12. Coin-cell battery socket (RTC)
- 13. Solid state drive slot (M.2 PCIe SSD - 0)
- 14. Wireless-card slot (M.2 WLAN)
- 15. PCIe x16 slot (SLOT 3)
- 16. PCIe x1 slot (SLOT 2)
- 17. PCIe x1 slot (SLOT 1)
- 18. Optional-port module (OPTION)

The following images indicate the location of the system board and provide a visual representation of the removal procedure.

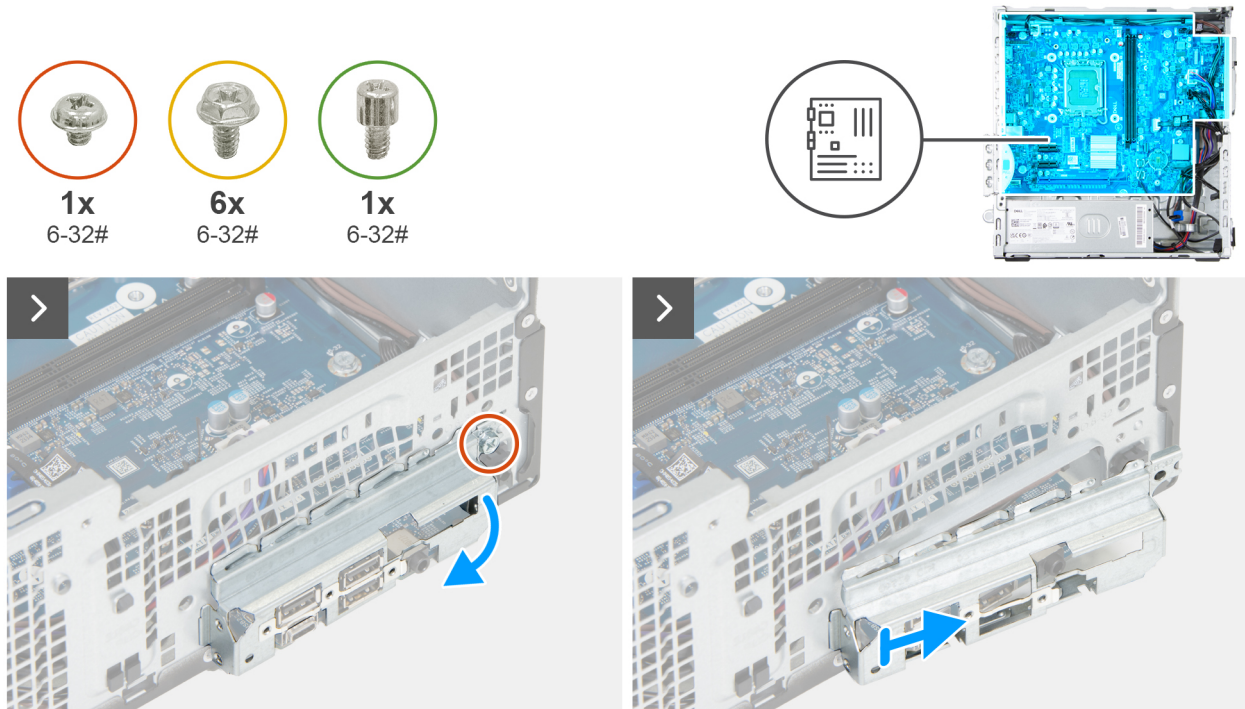

Figure 63. Removing the system board

Steps

1. Remove the screw (6-32#) that secures the front I/O bracket to the chassis.
2. Pivot and remove the front I/O-bracket from the chassis.

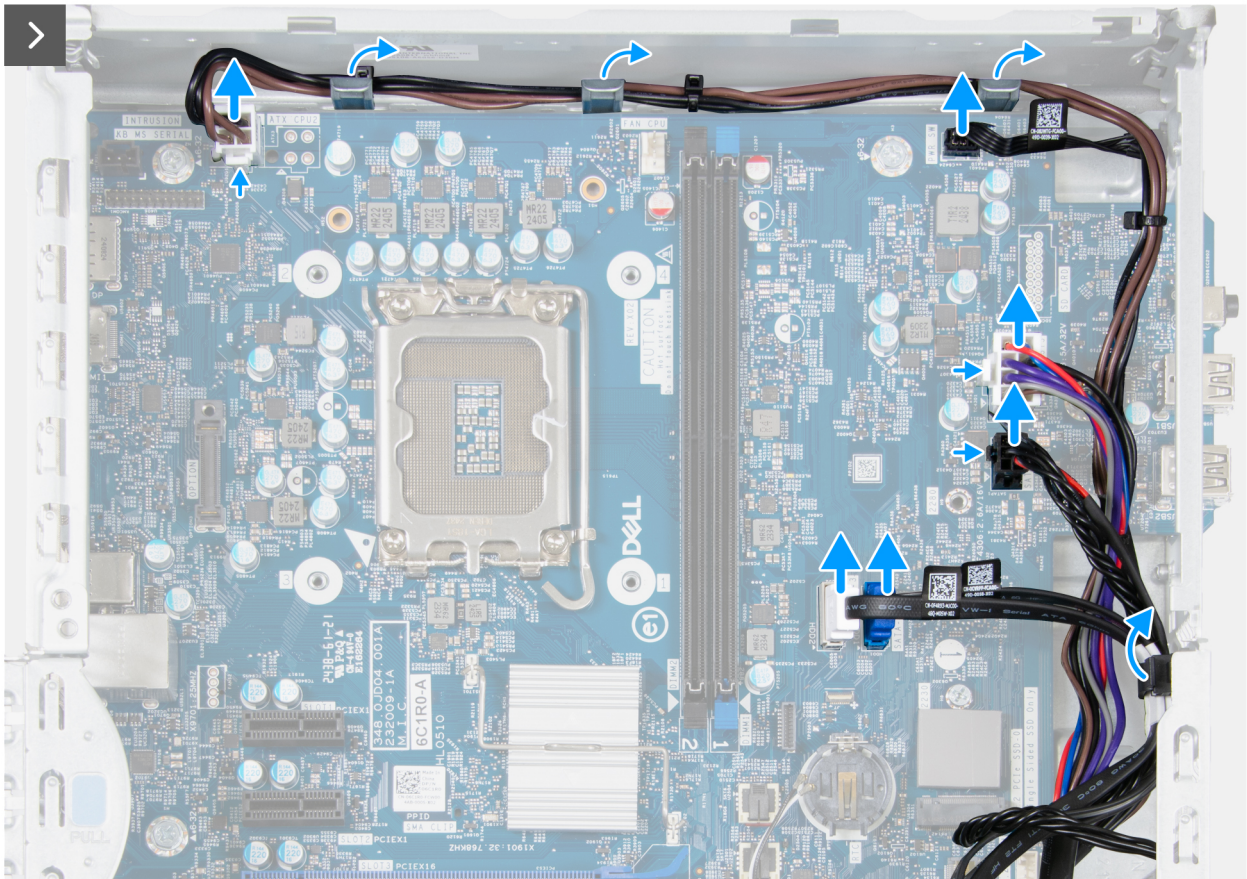

Figure 64. Removing the system board

3. Disconnect the power-supply cable from its connector (ATX CPU1) on the system board.
4. Remove the power-supply cable from the routing guides and keep it away.
5. Disconnect the power-button cable from its connector (PWR SW) on the system board.
6. Disconnect the power-supply cable from its connector (ATX SYS) on the system board.
7. Disconnect the SATA power cable from its connector (SATA PWR) on the system board.
8. Disconnect the optical-drive data cable from its connector (SATA - 3) on the system board.
9. Remove the optical-drive data cable from its routing guide and keep it away.
10. Disconnect the hard-drive data cable from its connector (SATA - 0) on the system board.
11. Remove the hard-drive data cable from its routing guide and keep it away.

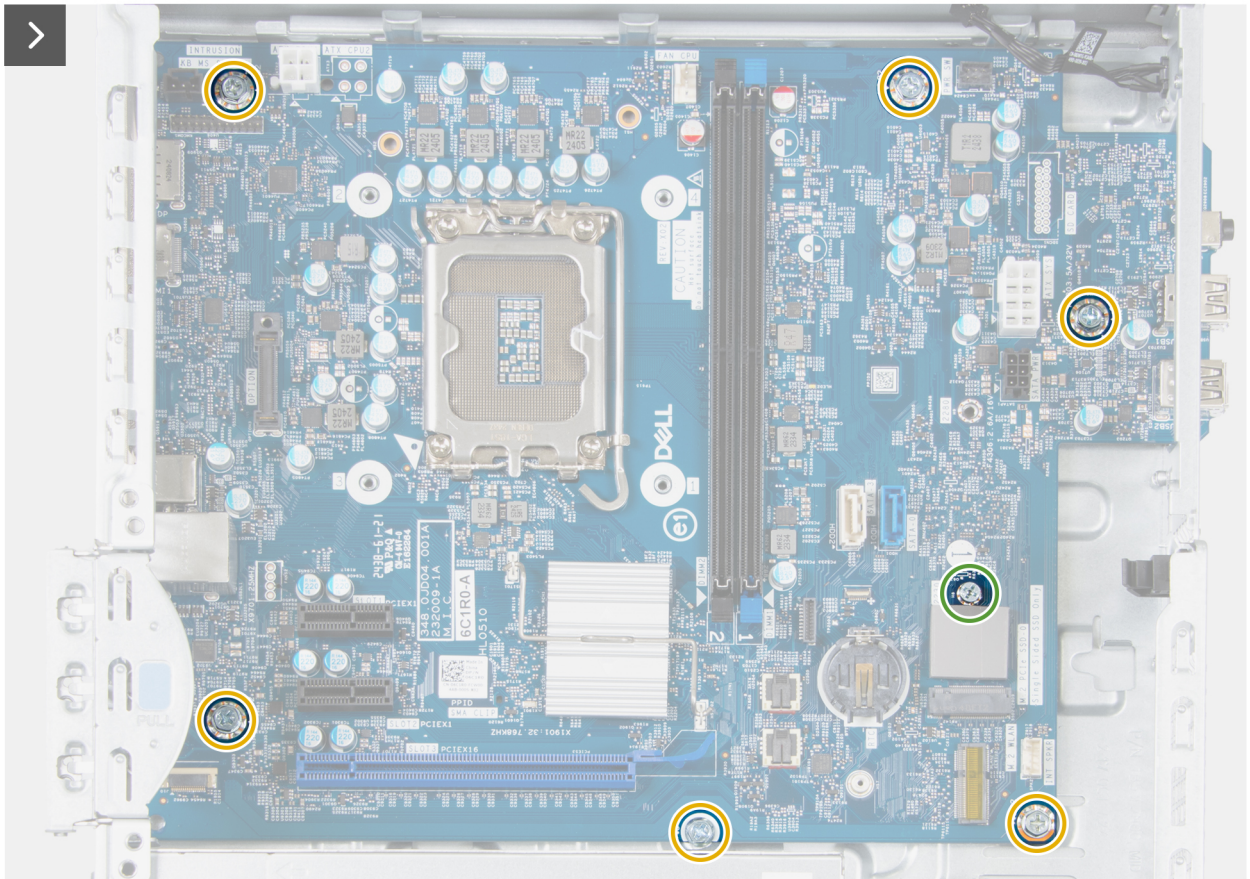

Figure 65. Removing the system board

12. Remove the six screws (6-32#) that secure the system board to the chassis.
13. Remove the screw mount that secures the system board to the chassis.

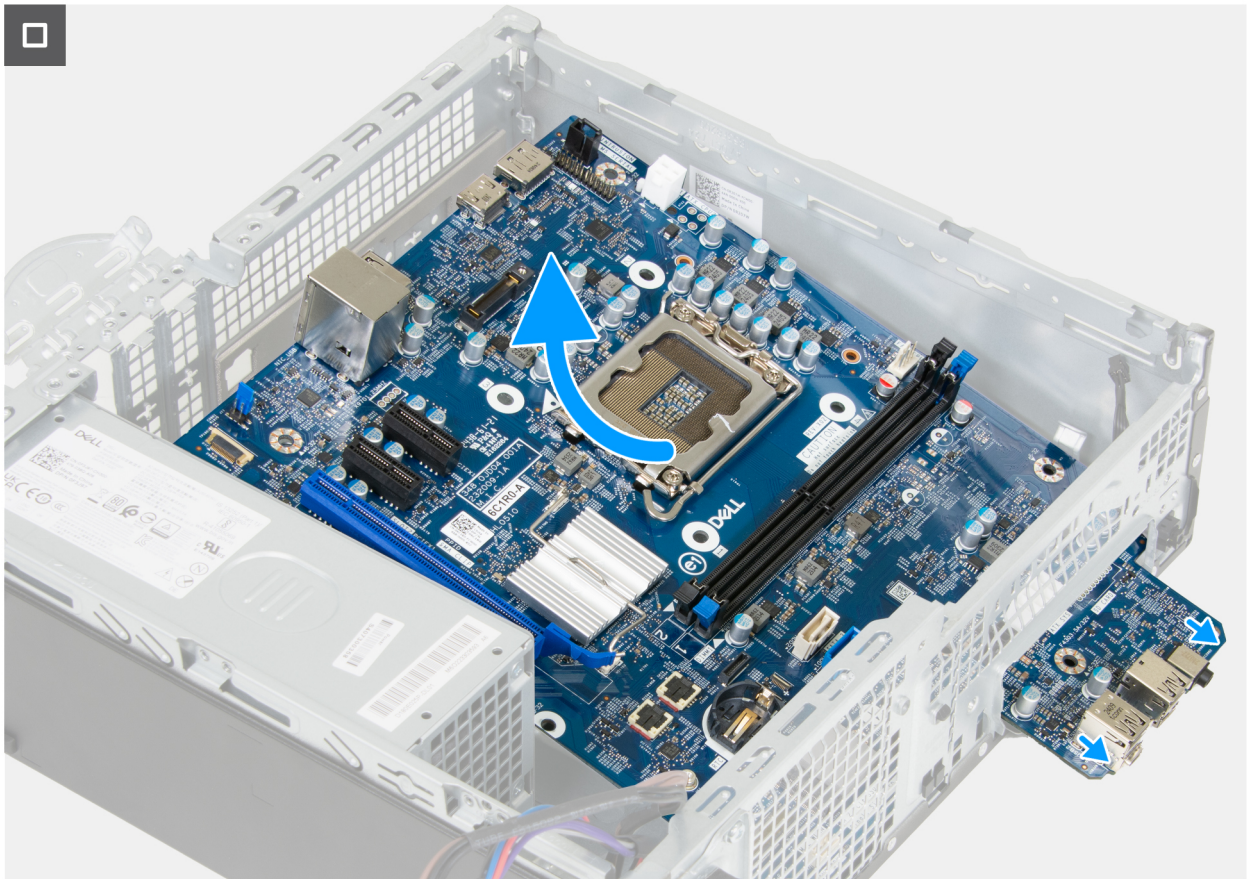

Figure 66. Removing the system board

14. Free the system board from the back I/O panel by sliding it towards the right and lift the system board out of the chassis.

Installing the system board

CAUTION: The information in this removal section is intended for authorized service technicians only.

Prerequisites

If you are replacing a component, remove the existing component before performing the installation procedure.

About this task

The following image indicates the connectors on your system board.

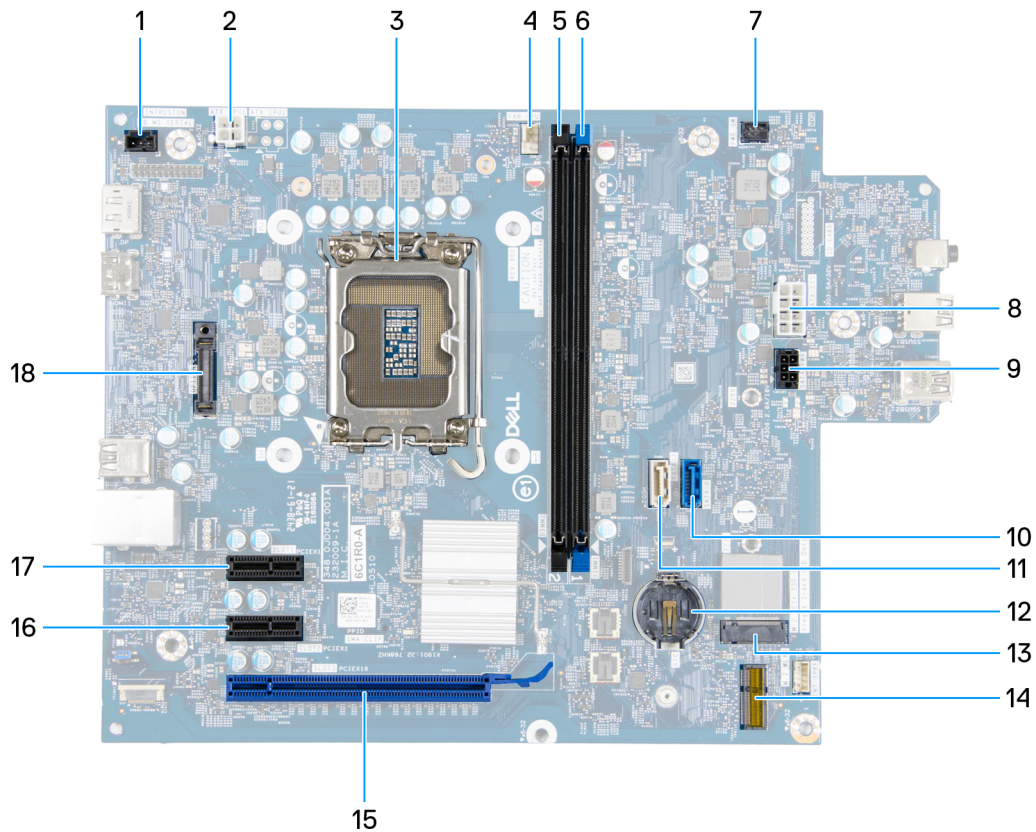

Figure 67. System board overview

1. Intrusion-switch connector (INTRUSION)
2. Processor-power connector (ATX CPU1)
3. Processor socket (CPU)
4. Processor-fan and heat-sink assembly connector (FAN CPU)
5. UDIMM memory slot (DIMM2)
6. UDIMM memory slot (DIMM1)
7. Power-button connector (PWR SW)
8. System-board power connector (ATX SYS)
9. Hard-drive and optical-drive power connector (SATA PWR)
10. Hard-drive data connector (SATA - 0)
11. Optical-drive data connector (SATA - 3)
12. Coin-cell battery socket (RTC)
13. Solid state drive slot (M.2 PCIe SSD - 0)
14. Wireless-card slot (M.2 WLAN)
15. PCIe x16 slot (SLOT 3)
16. PCIe x1 slot (SLOT 2)
17. PCIe x1 slot (SLOT 1)
18. Optional-port module (OPTION)

The following images indicate the location of the system board and provide a visual representation of the installation procedure.



1x
6-32#



6x
6-32#



1x
6-32#

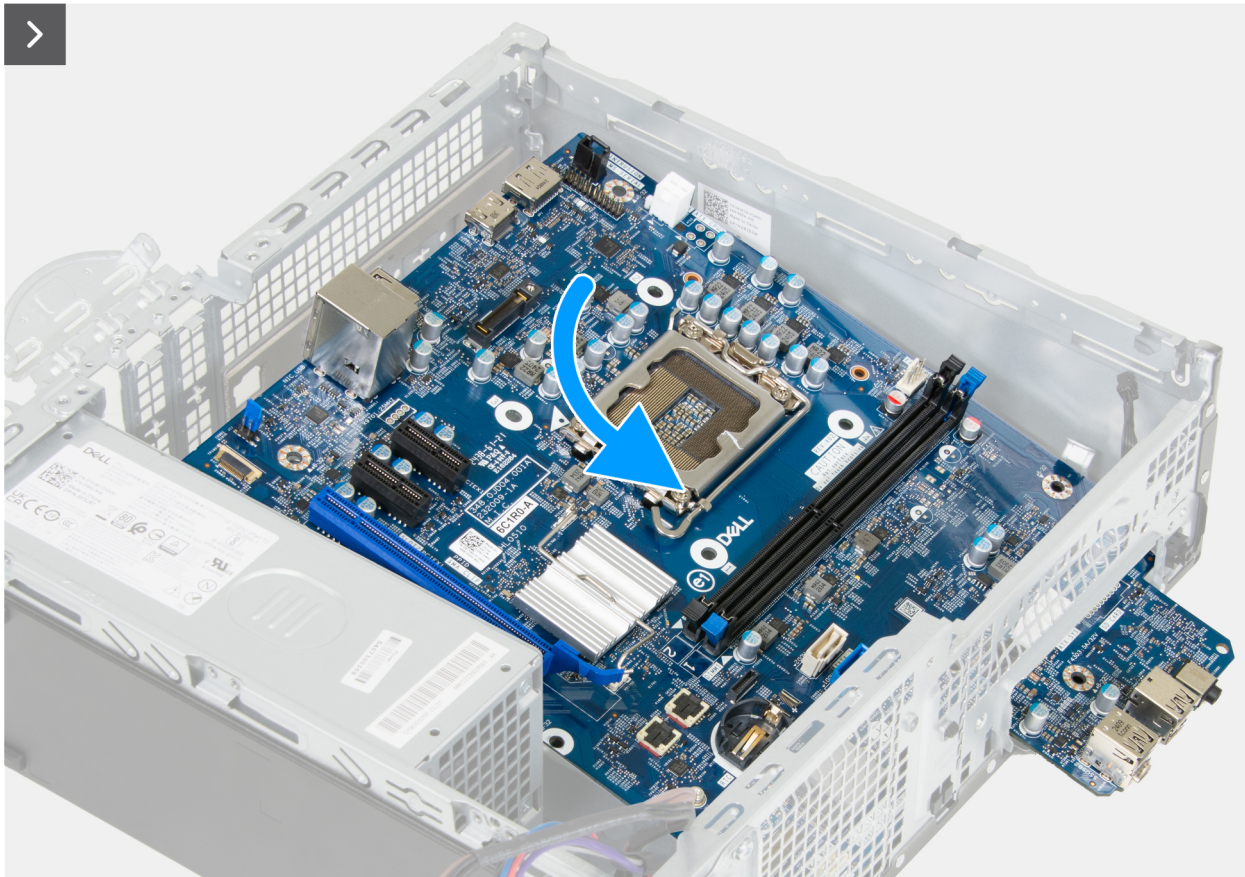

Figure 68. Installing the system board

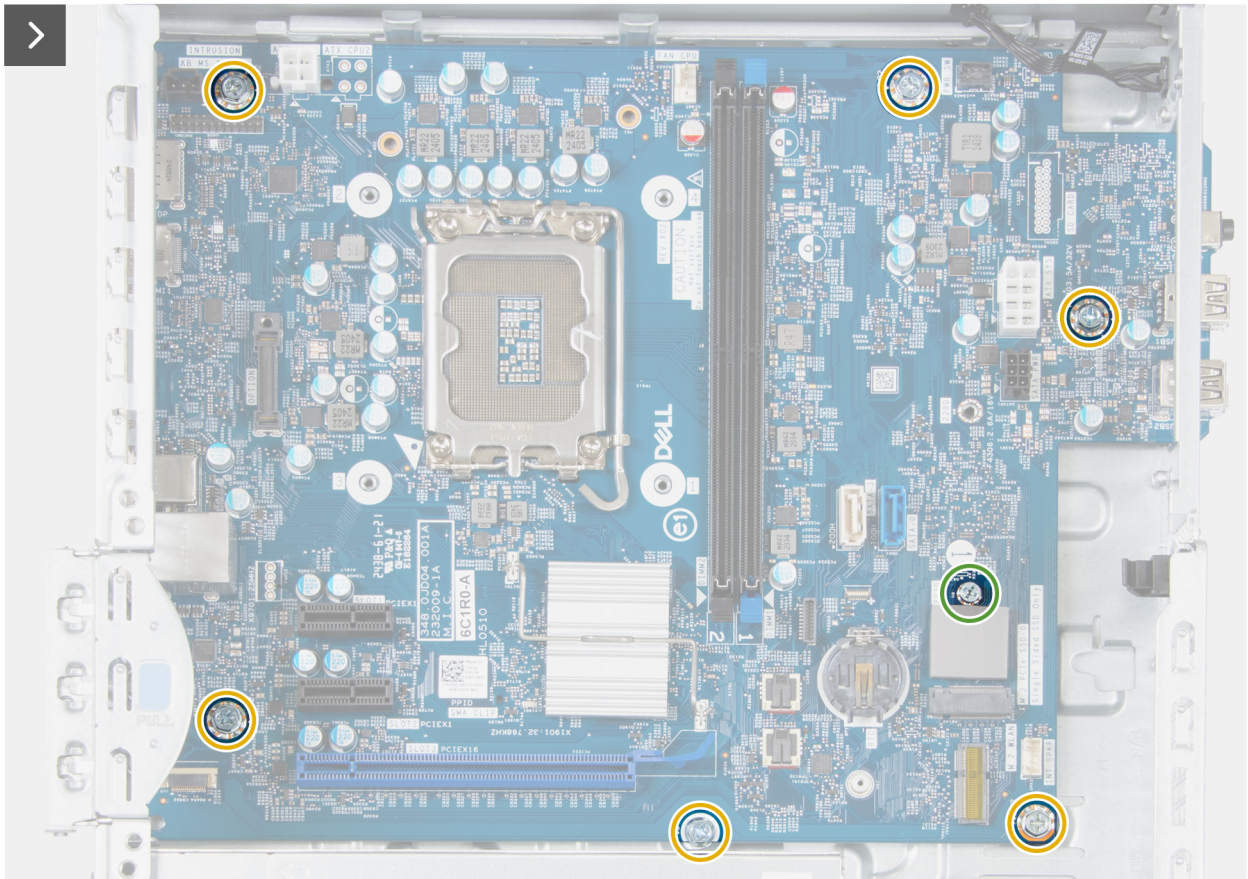

Figure 69. Installing the system board

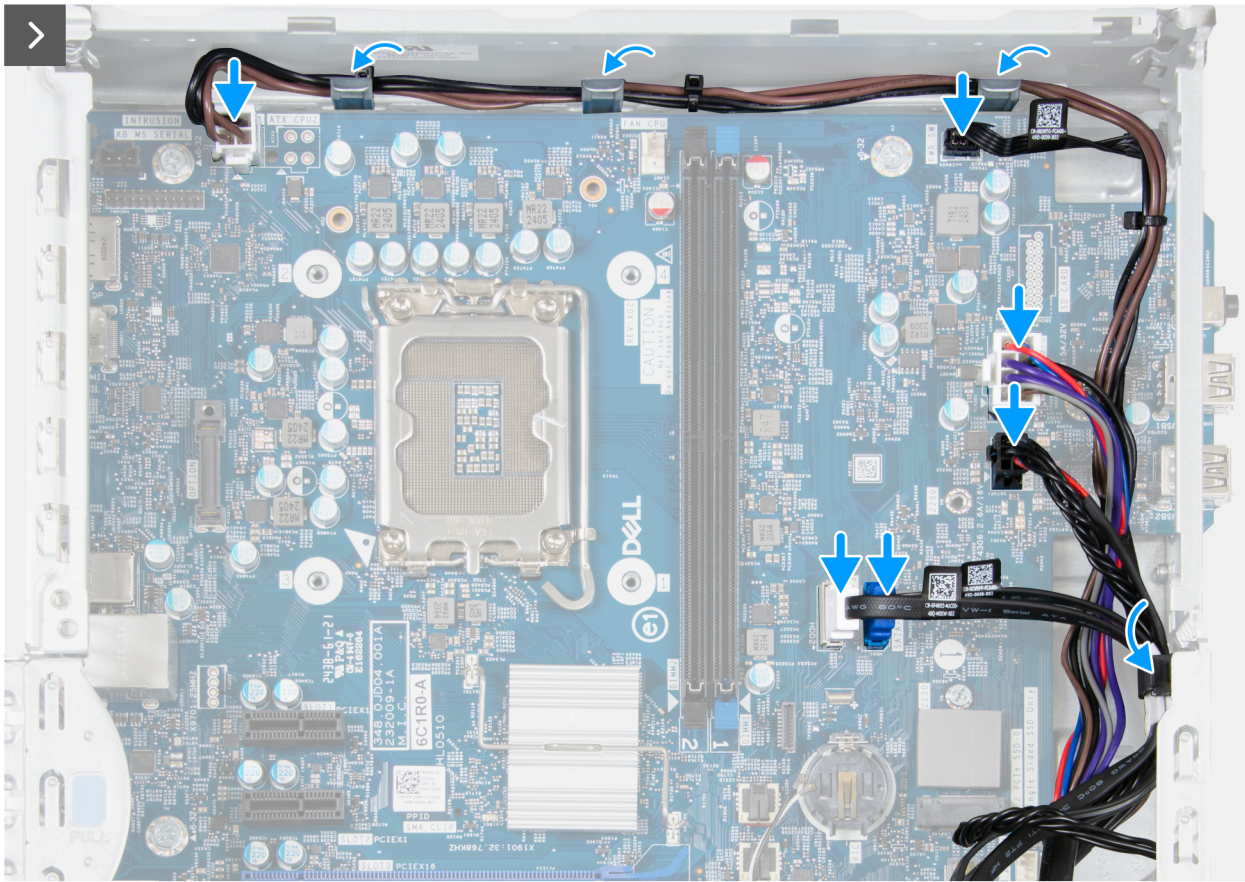

Figure 70. Installing the system board

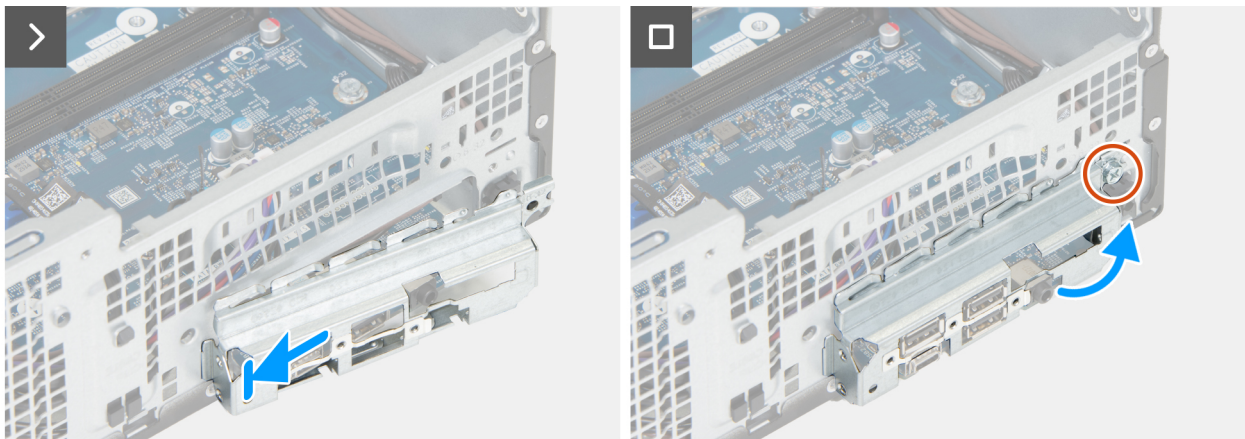

Figure 71. Installing the system board

Steps

1. Align and lower the system board into the system until the stand-off points at the back of the system board align with those on the chassis.
2. Replace the screw mount that secures the system board to the chassis.
3. Replace the six (6-32#)) screws that secure the system board to the chassis.
4. Route and connect the power-supply cable to its connector (ATX CPU1) on the system board.
5. Route and connect the power-button cable to its connector (PWR SW) on the system board.
6. Route and connect the power-supply cable to its connector (ATX SYS) on the system board.
7. Route and connect the SATA power cable to its connector (SATA PWR) on the system board.
8. Route and connect the optical-drive data cable to its connector (SATA - 3) on the system board.

9. Route and connect the hard-drive data cable to its connector (SATA - 0) on the system board.
10. Route and connect the speaker cable to its connector (INT SPKR) on the system board.
11. Route and connect the system-fan cable to its connector (FAN SYS) on the system board.
12. Place and align the front I/O-bracket with the I/O slot on the chassis.
13. Replace the screw (6-32#) that secures the front I/O-bracket to the chassis.

Next steps

1. Install the [processor](#).
2. Install the [optional port module](#), if applicable.
3. Install the [serial-port module](#), if applicable.
4. Install the [processor fan and heat-sink assembly](#).
5. Install the [drive bay](#), if applicable.
6. Install the [graphics card](#), if applicable.
7. Install the [wireless card](#).
8. Install the [M.2 2230 solid state drive](#), or the [M.2 2280 solid state drive](#), whichever is applicable.
9. Install the [memory](#).
10. Install the [front cover](#).
11. Install the [coin-cell battery](#).
12. Install the [coin-cell battery cover](#).
13. Install the [side cover](#).
14. Install the [dust filter](#), if applicable.
15. Install the [cable cover](#), if applicable.
16. Follow the procedure in [After working inside your computer](#).

Software

This chapter details the supported operating systems along with instructions on how to install the drivers.

Operating system

Your Dell Pro Slim QCS1250 supports the following operating systems:

- Windows 11 Home
- Windows 11 Pro
- Windows 11 Pro National Education
- Ubuntu Linux 24.04 LTS

Drivers and downloads

When troubleshooting, downloading, or installing drivers, it is recommended that you read the [Dell Knowledge Base article Drivers and Downloads FAQs](#).

BIOS Setup

CAUTION: Certain changes can make your computer work incorrectly. Before you change the settings in BIOS Setup, it is recommended that you note down the original settings for future reference.

NOTE: Depending on the computer and the installed devices, the options that are listed in this section may differ.

Use BIOS Setup for the following purposes:

- Get information about the hardware installed in your computer, such as the amount of RAM and the capacity of the storage device.
- Change the system configuration information.
- Set or change user-selectable options such as the user password, enabling or disabling base devices, and configuring hard drive settings.

Entering BIOS Setup program

About this task

Turn on (or restart) your computer and press F2 immediately.

Navigation keys

NOTE: For most of the BIOS Setup options, changes that you make are recorded but do not take effect until you restart the computer.

Table 26. Navigation keys

Keys	Navigation
Up arrow	Moves to the previous field.
Down arrow	Moves to the next field.
Enter	Selects a value in the selected field (if applicable) or follows the link in the field.
Spacebar	Expands or collapses a drop-down list, if applicable.
Tab	Moves to the next focus area.
Esc	Moves to the previous page until you view the main screen. Pressing Esc in the main screen displays a message that prompts you to save any unsaved changes and restart the computer.

One time boot menu

To access the **one time boot menu**, turn on your computer, and then press F2 immediately.

NOTE: If your computer fails to enter the boot menu, restart the computer and press F2 immediately.

The one-time boot menu displays the devices that you can boot from, and also displays the option to start diagnostics. The boot menu options are:

- Removable Drive (if available)

- STXXXX Drive (if available)

NOTE: XXX denotes the SATA drive number.

- Optical Drive (if available)
- SATA Hard Drive (if available)
- Diagnostics

NOTE: Choosing **Diagnostics**, will display the **ePSA diagnostics** screen.

The **one time boot menu** also displays the option to access the System Setup screen.

F12 One Time Boot menu

To enter the One Time Boot menu, turn on or restart your computer, and then press F12 immediately.

NOTE: If you are unable to enter the One Time Boot menu, repeat the above action.

The One Time Boot menu displays the devices that you can boot from and also display the options to start diagnostics. The boot menu options are:

- Removable Drive (if available)
- STXXXX Drive (if available)

NOTE: XXXX denotes the SATA drive number.

- Optical Drive (if available)
- SATA Hard Drive (if available)
- Diagnostics

The One Time Boot menu screen also displays the option to access BIOS Setup.

BIOS Setup options

NOTE: Depending on your computer and its installed devices, the items that are listed in this section may or may not be displayed.

Table 27. BIOS Setup options—Overview menu

Overview	
Dell Pro Slim QCS1250	
BIOS Version	Displays the BIOS version number.
Service Tag	Displays the Service Tag of the computer.
Asset Tag	Displays the Asset Tag of the computer.
Manufacture Date	Displays the manufacture date of the computer.
Ownership Date	Displays the ownership date of the computer.
Express Service Code	Displays the Express Service Code of the computer.
Ownership Tag	Displays the Ownership Tag of the computer.
Processor Information	
Processor Type	Displays the processor type.
Maximum Clock Speed	Displays the maximum processor clock speed.
Core Count	Displays the number of cores on the processor.

Table 27. BIOS Setup options—Overview menu (continued)

Overview	
Processor ID	Displays the processor identification code.
Processor L2 Cache	Displays the processor L2 cache size.
Processor L3 Cache	Displays the processor L3 cache size.
Microcode Version	Displays the microcode version.
Intel Hyper-Threading Capable	Displays whether the processor is Hyper-Threading (HT) capable.
Intel vPro Technology	Displays whether Intel vPro technology is used.
Memory Information	
Memory Installed	Displays the total memory that is installed on the computer.
Memory Available	Displays the total memory available on the computer.
Memory Speed	Displays the memory speed.
Memory Technology	Displays the technology that is used for the memory.
DIMM 1 Size	Displays the memory size of the memory that is installed in DIMM 1.
DIMM 2 Size	Displays the memory size of the memory that is installed in DIMM 2.
Devices Information	
Video Controller	Displays the type of video controller available on the computer.
Video Memory	Displays the video memory information of the computer.
Wi-Fi Device	Displays the wireless device information of the computer.
Native Resolution	Displays the native resolution of the computer.
Video BIOS Version	Displays the video BIOS version of the computer.
Audio Controller	Displays the audio controller information of the computer.
Bluetooth Device	Displays the Bluetooth device information of the computer.
LOM MAC Address	Displays the MAC address of the LOM.
Slot 1	Displays the card that is installed in PCIe slot 1.
Slot 2	Displays the card that is installed in PCIe slot 2.
Slot 3	Displays the card that is installed in PCIe slot 3.

Table 28. BIOS Setup options—Boot Configuration menu

Boot Configuration	
Boot Sequence	Displays the boot sequence and sets the order the BIOS searches for boot devices when finding an operating system to boot. Add, delete, or prioritize boot devices in the list for boot operation .
Enable PXE Boot Priority	When Enabled , if a PXE boot option is detected it will be added to the top of the Boot Sequence . When set to Forced any PXE boot option will on top of the Boot Sequence and any external PXE boot option(s) will have higher than any internal PXE boot option(s). OS installation will not change PXE boot option priority.
Extended IPV4 PXE Boot Timeout	Enter the Extended IPV4 PXE Boot Timeout value only if the IPV4 PXE boot fails with standard timeouts.
Force PXE On Next Boot	Click the checkbox to enable the Force PXE feature on the next boot.

Table 28. BIOS Setup options—Boot Configuration menu (continued)

Boot Configuration	
Secure Digital (SD) Card Boot	Click the checkbox to enable the Secure Digital (SD) Card Boot.
Secure Boot	Secure Boot is a method of guaranteeing the integrity of the boot path by performing additional validation of the operating system and PCI add-in cards. The computer stops booting to the operating system when a component is not authenticated during the boot process. Secure Boot can be enabled in BIOS setup or using management interfaces like Dell Command Configure, but can only be disabled from BIOS setup.
Enable Secure Boot	<p>Enables the computer to boot using only validated boot software.</p> <p>By default, the Enable Secure Boot option is enabled.</p> <p>For additional security, Dell Technologies recommends keeping the Secure Boot option enabled to ensure that the UEFI firmware validates the operating system during the boot process.</p> <p>i NOTE: For Secure Boot to be enabled, the computer is required to be in UEFI boot mode and the Enable Legacy Option ROMs option is required to be turned off.</p>
Secure Boot Mode	<p>Enables or disables the Secure Boot operation mode.</p> <p>By default, the Deployed Mode is selected.</p> <p>i NOTE: Deployed Mode should be selected for normal operation of Secure Boot.</p>
Expert Key Management	Enables or disables the ability to modify the keys in the PK, KEK, db, and dbx security key databases to be modified.
Enable Custom Mode	By default, the Enable Custom Mode option is disabled.
Custom Mode Key Management	<p>Selects the custom values for expert key management.</p> <p>By default, the PK option is selected.</p>

Table 29. BIOS Setup options—Integrated Devices menu

Integrated Devices	
Date/Time	
Date	Sets the computer date in MM/DD/YYYY format. Changes to the date format take effect immediately.
Time	Sets the computer time in HH/MM/SS 24-hour format. You can switch between a 12-hour and 24-hour clock. Changes to the time format take effect immediately.
Audio	
Enable Audio	<p>Enables all integrated audio controller.</p> <p>By default, all the options are enabled.</p>
Enable Microphone	<p>Enables the microphone.</p> <p>By default, the Enable Microphone option is enabled.</p> <p>i NOTE: Depending on the configuration ordered, the microphone setup option may not be available.</p>
Enable Internal Speaker	<p>Enables the internal speaker.</p> <p>By default, the Enable Internal Speaker option is enabled.</p>
USB/Thunderbolt Configuration	
Enable Front USB Ports	Enables the front external USB ports.

Table 29. BIOS Setup options—Integrated Devices menu (continued)

Integrated Devices	
	By default, the Enable Front External USB Ports option is enabled.
Enable Rear USB Ports	Enables the rear external USB ports. By default, the Enable Rear External USB Ports option is enabled.
Enable USB Boot Support	Enables booting from USB mass storage devices that are connected to external USB ports. By default, the Enable USB Boot Support option is enabled.
Enable Thunderbolt Technology Support	Enables the Thunderbolt adapter devices during pre-boot. By default, the Enable Thunderbolt Technology Support option is enabled.
Enable Thunderbolt Boot Support	Enables or disables the Thunderbolt boot support during pre-boot. By default, the Enable Thunderbolt Boot Support option is enabled.
Disable USB4 PCIe Tunneling	Enables the USB4 PCIe devices during pre-boot.
Front USB configuration	Click each checkbox to enable each individual USB port option.
Rear USB configuration	Click each checkbox to enable each individual USB port option.
Dust Filter Maintenance	
Dust Filter Maintenance	Enables or disables BIOS messages for maintaining the optional dust filter installed on the computer. Click the checkbox to set the interval for reminders to clean or replace the dust filter .

Table 30. BIOS Setup options—Storage menu

Storage	
SATA/NVMe Operation	
SATA/NVMe Operation	Sets the operating mode of the integrated SATA hard drive controller. By default, the RAID On option is selected. The storage device is configured for AHCI/NVMe mode.
Storage Interface	
Port Enablement	Select onboard drives to enable. By default, all storage options are enabled.
SMART Reporting	
Enable SMART reporting	Enables Self-Monitoring Analysis and Reporting Technology to enable the BIOS to receive analytical information from integrated storage devices and send notifications during startup about storage device errors and possible future failure of the storage device.
Drive Information	
Enable MediaCard	
Secure Digital (SD) Card	Enables or disables the SD card. By default, the Secure Digital (SD) Card option is enabled.
Secure Digital (SD) Card Read-Only Mode	Enables or disables the SD card read-only mode. By default, the Secure Digital (SD) Card Read-Only Mode option is disabled.

Table 31. BIOS Setup options—Display menu

Display	
Primary Display	Determines which video controller will become the primary display when there are multiple controllers available. When a specific device is selected display output is only available from ports located on that selected device.

Table 32. BIOS Setup options—Connection menu

Connection	
Network Controller Configuration	
Integrated NIC	Controls the on-board LAN controller.
Wireless Device Enable	
WLAN	Enables or disables the internal WLAN device. By default, the WLAN option enabled.
Bluetooth	Enables or disables the internal Bluetooth device. By default, the Bluetooth option enabled.
Enable UEFI Network Stack	Enables or disables the UEFI Network Stack and controls the onboard LAN Controller. By default, the Auto Enabled option is enabled.
IPv4 PXE Boot	Enable or disables the IPv4 PXE Boot option.
IPv6 PXE Boot	Enable or disables the IPv6 PXE Boot option.
HTTP(s) Boot Feature	
HTTP(s) Boot Modes	Select the HTTP(s) Boot Mode.

Table 33. BIOS Setup options—Power menu

Power	
USB PowerShare	
Enable USB PowerShare	Enables the computer to supply power to connected USB devices while in sleep state.
Thermal Management	
	Enables or disables cooling of fan and manages processor heat to adjust the computer performance, noise, and temperature. By default, the Optimized option is selected. Standard setting for balanced performance, noise, and temperature.
USB Wake Support	
Enable USB Wake Support	When enabled, a USB device such as a mouse or keyboard can wake the computer from Standby, Hibernate, and Power Off. By default, the Enable USB Wake Support option is enabled.
AC Recovery	
AC Recovery	Set the behavior of your computer when power is restored after an unexpected loss of power.
Block Sleep	
	Enables or disables the computer from entering Sleep (S3) mode in the operating system. By default, the Block Sleep option is disabled.
	i NOTE: When enabled, the computer does not go to Sleep, Intel Rapid Start is disabled automatically, and the operating system power option is blank if it was set to Sleep.

Table 33. BIOS Setup options—Power menu (continued)

Power	
Deep Sleep Control	<p>Determines how aggressive the computer is at conserving power while in Shutdown or Hibernate state.</p> <p>This feature must be disabled to enable Wake From USB keyboard and mouse to work in the Shutdown or Hibernate state.</p>
Fan Control Override	<p>When enabled the computer fans run at full speed.</p>

Table 34. BIOS Setup options—Security menu



Security	
Trusted Platform Module (TPM) 2.0 security	<p>The Trusted Platform Module (TPM) provides various cryptographic services which serve as the cornerstone for many platform security technologies. Trusted Platform Module (TPM) is a security device that stores computer-generated keys for encryption and features such as BitLocker, Virtual Secure Mode, remote Attestation.</p> <p>By default, the Trusted Platform Module (TPM) option is enabled.</p> <p>For additional security, Dell Technologies recommends keeping Trusted Platform Module (TPM) enabled to allow these security technologies to fully function.</p> <p> NOTE: The options that are listed apply to computers with a discrete Trusted Platform Module (TPM) chip.</p>
TPM 2.0 Security On	<p>Allows you to enable or disable TPM.</p> <p>By default, the TPM On option is enabled.</p> <p>For additional security, Dell Technologies recommends keeping TPM On enabled to allow these security technologies to fully function.</p>
Attestation Enable	<p>The Attestation Enable option controls the endorsement hierarchy of TPM. Disabling the Attestation Enable option prevents TPM from being used to digitally sign certificates.</p> <p>By default, the Attestation Enable option is enabled.</p> <p>For additional security, Dell Technologies recommends keeping the Attestation Enable option enabled.</p> <p> NOTE: When disabled, this feature may cause compatibility issues or loss of functionality in some operating systems.</p>
Key Storage Enable	<p>The Key Storage Enable option controls the storage hierarchy of TPM, which is used to store digital keys. Disabling the Key Storage Enable option restricts the ability of TPM to store owner's data.</p> <p>By default, the Key Storage Enable option is enabled.</p> <p>For additional security, Dell Technologies recommends keeping the Key Storage Enable option enabled.</p> <p> NOTE: When disabled, this feature may cause compatibility issues or loss of functionality in some operating systems.</p>
Clear	<p>When enabled, the Clear option clears information that is stored in the TPM after exiting the computer's BIOS. This option returns to the disabled state when the computer restarts.</p> <p>By default, the Clear option is disabled.</p> <p>Dell Technologies recommends enabling the Clear option only when TPM data is required to be cleared.</p>
PPI Bypass for Clear Commands	<p>By default, the PPI Bypass for Clear Commands option is disabled.</p>

Table 34. BIOS Setup options—Security menu (continued)



Security	
	For additional security, Dell Technologies recommends keeping the PPI Bypass for Clear Commands option disabled.
Intel Total Memory Encryption	Intel Total Memory Encryption (TME) protects the memory from physical attacks.
Data Wipe on Next Boot	
Start Data Wipe	<p>Data Wipe is a secure wipe operation that deletes information from a storage device.</p> <p> CAUTION: The secure Data Wipe operation deletes information in a way that it cannot be reconstructed.</p> <p>Commands such as delete and format in the operating system may remove files from showing up in the file system. However, they can be reconstructed through forensic means as they are still represented on the physical media. Data Wipe prevents this reconstruction and the data can no longer be recovered.</p> <p>When enabled, the data wipe option provides prompts to wipe any storage devices that are connected to the computer on the next boot.</p> <p>By default, the Start Data Wipe option is disabled.</p>
Absolute	<p>Absolute Software provides various cyber security solutions, some requiring software preloaded on Dell computers and integrated into the BIOS. To use these features, you must enable the Absolute BIOS setting and contact Absolute for configuration and activation.</p> <p>By default, the Absolute option is enabled.</p> <p>For additional security, Dell Technologies recommends keeping the Absolute option enabled.</p> <p> NOTE: When the Absolute features are activated, the Absolute integration cannot be disabled from the BIOS setup screen.</p>
UEFI Boot Path Security	<p>Enables or disables the computer to prompt the user to enter the Administrator password (if set) when booting to a UEFI boot path device from the F12 boot menu.</p> <p>By default, the Always Except Internal HDD option is enabled.</p>
Authenticated BIOS Interface	
Enable Authenticated BIOS Interface	Clear certificates in KMS storage.
Legacy Manageability Interface Access	Allows the platform administrator to control access via the Legacy Manageability Interface.
Firmware Device Tamper Detection	<p>Allows you to control the firmware device tamper detection feature. This feature notifies the user when the firmware device is tampered. When enabled, a screen warning messages are displayed on the computer and a tamper detection event is logged in the BIOS Events log. The computer fails to reboot until the event is cleared.</p> <p>By default, the Firmware Device Tamper Detection option is enabled.</p> <p>For additional security, Dell Technologies recommends keeping the Firmware Device Tamper Detection option enabled.</p>

Table 35. BIOS Setup options—Passwords menu

Passwords	
Admin Password	The Administrator Password prevents unauthorized access to the BIOS Setup options. Once the administrator password is set, the BIOS setup options can only be modified after providing the correct password.

Table 35. BIOS Setup options—Passwords menu (continued)

Passwords	<p>The following rules and dependencies apply to the Administrator Password -</p> <ul style="list-style-type: none"> • The administrator password cannot be set if computer and/or internal storage passwords are previously set. • The administrator password can be used in place of the computer and/or internal storage passwords. • When set, the administrator password must be provided during a firmware update. • Clearing the administrator password also clears the computer password (if set). <p>Dell Technologies recommends using an administrator password to prevent unauthorized changes to BIOS setup options.</p>
System Password	<p>The System Password prevents the computer from booting to an operating system without entering the correct password.</p> <p>The following rules and dependencies apply when the System Password is used -</p> <ul style="list-style-type: none"> • The computer shuts down when idle for approximately 10 minutes at the computer password prompt. • The computer shuts down after three incorrect attempts to enter the computer password. • The computer shuts down when the Esc key is pressed at the System Password prompt. • The computer password is not prompted when the computer resumes from standby mode. <p>Dell Technologies recommends using the computer password in situations where it is likely that a computer may be lost or stolen.</p>
Password Configuration	<p>The Password configuration page includes several options for changing the requirements of BIOS passwords. You can modify the minimum and maximum length of the passwords and require passwords to contain certain character classes (upper case, lower case, digit, special character).</p> <p>Dell Technologies recommends setting the minimum password length to at least eight characters.</p>
Password Bypass	<p>The Password Bypass option allows the computer to reboot from the operating system without entering the computer or hard drive password. If the computer has already booted to the operating system, it is presumed that the user has already entered the correct computer or hard drive password.</p> <p>NOTE: This option does not remove the requirement to enter the password after shutting down.</p> <p>By default, the Password Bypass option is enabled.</p> <p>For additional security, Dell Technologies recommends keeping the Password Bypass option enabled.</p>
Password Changes	<p>Allow Non-Admin Password Changes</p> <p>The Allow Non-Admin Password Changes option in BIOS setup allows an end user to set or change the computer or hard drive passwords without entering the administrator password. This gives an administrator control over the BIOS settings but enables an end user to provide their own password.</p> <p>By default, the Allow Non-Admin Password Changes option is disabled.</p> <p>For additional security, Dell Technologies recommends keeping the Allow Non-Admin Password Changes option disabled.</p>
Non-Admin Setup Changes	<p>The Non-Admin Setup Changes option allows an end user to configure the wireless devices without requiring the administrator password.</p> <p>By default, the Non-Admin Setup Changes option is disabled.</p>

Table 35. BIOS Setup options—Passwords menu (continued)

Passwords	
	For additional security, Dell Technologies recommends keeping the Non-Admin Setup Changes option disabled.
Admin Setup Lockout	<p>The Admin Setup Lockout option prevents an end user from even viewing the BIOS setup configuration without first entering the administrator password (if set).</p> <p>By default, the Admin Setup Lockout option is disabled.</p> <p>For additional security, Dell Technologies recommends keeping the Admin Setup Lockout option disabled.</p>
Recovery Password	<p>The Recovery Password can be used when a system owner forgets the administrator, system, or hard drive password. You can get an unlock code from Dell Support over the phone after verifying ownership details. The unlock code overrides and removes the existing password.</p> <p>i NOTE: When a hard drive password is overridden using this method, the data on the hard drive is erased if secure erase was enabled when setting the password.</p>
Master Password Lockout	
Enable Master Password Lockout	<p>The Master Password Lockout setting allows you to disable the Recovery Password feature. If the computer, administrator, or hard drive password is forgotten, the computer becomes unusable.</p> <p>i NOTE: When the owner password is set, the Master Password Lockout option is not available.</p> <p>i NOTE: When an internal hard drive password is set, it must first be cleared before Master Password Lockout can be changed.</p> <p>By default, the Enable Master Password Lockout option is disabled.</p> <p>Dell does not recommend enabling the Master Password Lockout unless you have implemented your own password recovery computer.</p>

Table 36. BIOS Setup options—Update, Recovery menu

Update, Recovery	
BIOS Recovery from Hard Drive	<p>Enables or disables the user to recover from certain corrupted BIOS conditions from a recovery file on the user primary hard drive or an external USB key.</p> <p>By default, the BIOS Recovery from Hard Drive option is enabled.</p> <p>i NOTE: BIOS Recovery from Hard Drive is not available for self-encrypting drives (SED).</p> <p>i NOTE: BIOS recovery is designed to fix the main BIOS block and cannot work if the Boot Block is damaged. In addition, this feature cannot work in the event of EC corruption, ME corruption, or a hardware issue. The recovery image must exist on an unencrypted partition on the drive.</p>
BIOS Downgrade	
Allow BIOS Downgrade	<p>Controls flashing of the computer firmware to previous revisions.</p> <p>By default, the Allow BIOS Downgrade option is enabled.</p>
SupportAssist OS Recovery	<p>Enables or disables the boot flow for SupportAssist OS Recovery tool in the event of certain computer errors.</p> <p>By default, the SupportAssist OS Recovery option is enabled.</p>
BIOSConnect	<p>Enables or disables cloud Service operating system recovery if the main operating system fails to boot with the number of failures equal to or greater than the</p>

Table 36. BIOS Setup options—Update, Recovery menu (continued)

Update, Recovery	
	<p>value specified by the Auto OS Recovery Threshold setup option and local Service operating system does not boot or is not installed.</p> <p>By default, the BIOSConnect option is enabled.</p>
Dell Auto OS Recovery Threshold	<p>Allows you to control the automatic boot flow for SupportAssist System Resolution Console and for Dell OS Recovery Tool.</p> <p>By default, the Dell Auto OS Recovery Threshold value is set to 2.</p>

Table 37. BIOS Setup options—System Management menu

System Management	
Service Tag	Displays the Service Tag of the computer.
Asset Tag	<p>Creates a computer Asset Tag that can be used by an IT administrator to uniquely identify a particular computer.</p> <p>i NOTE: Once set in BIOS, the Asset Tag cannot be changed.</p>
Wake on LAN	<p>Enables or disables the computer to turn on by a special LAN signal.</p> <p>By default, the Wake on LAN option is disabled.</p>
Auto On Time	<p>Enable to set the computer to turn on automatically every day or on a preselected date and time. This option can be configured only if the Auto On Time is set to Everyday, Weekdays, or Selected Days.</p> <p>By default, the Auto On Time option is disabled.</p>
Intel AMT Capability	Enable Intel AMT Capability.
SERR Messages	Enable SERR Messages.
First Power On Date	Set the Ownership date.
Diagnostics	
OS Agent Requests	Enables Dell OS Agents to set schedule on-board diagnostics on a subsequent boot.
Power-on-Self-Test Automatic Recovery	Enables Power-on-Self-Test Automatic Recovery to enable BIOS recovery if the computer becomes unresponsive before completing the BIOS Power-on-Self-Test.

Table 38. BIOS Setup options—Keyboard menu

Keyboard	
Enable Numlock LED	Enables or disables Numlock LED when the computer boots.
Device Configuration HotKey Access	<p>Allows you to control whether you can access device configuration screens through hotkeys during computer startup.</p> <p>By default, the Device Configuration HotKey Access option is enabled.</p> <p>i NOTE: This setting controls only the Intel RAID (CTRL+I), MEBX (CTRL+P), and LSI RAID (CTRL+C) Option ROMs. Other preboot Option ROMs, which support entry using a key sequence, are not affected by this setting.</p>

Table 39. BIOS Setup options—Pre-boot Behavior menu

Preboot Behavior	
Warnings and Errors	<p>Enables or disables the action to be taken when a warning or error is encountered.</p> <p>By default, the Prompt on Warnings and Errors option is selected.</p>

Table 39. BIOS Setup options—Pre-boot Behavior menu (continued)

Preboot Behavior	
	<p> NOTE: Errors deemed critical to the operation of the computer hardware stop the functioning of the computer.</p>
Extend BIOS POST Time	<p>Sets the BIOS POST (Power-On Self-Test) load time.</p> <p>By default, the 0 seconds option is selected.</p>

Table 40. BIOS Setup options—Virtualization menu





Virtualization Support	
Intel Virtualization Technology	
Enable Intel Virtualization Technology (VT)	<p>When enabled, the computer can run a Virtual Machine Monitor (VMM).</p> <p>By default, the Enable Intel Virtualization Technology (VT) option is enabled.</p>
DMA Protection	
Enable Pre-Boot DMA Support	<p>Allows you to control the Pre-Boot DMA protection for both internal and external ports. This option does not directly enable DMA protection in the operating system.</p> <p> NOTE: This option is not available when the virtualization setting for IOMMU is disabled (VT-d/AMD Vi).</p> <p>By default, the Enable Pre-Boot DMA Support option is enabled.</p> <p>For additional security, Dell Technologies recommends keeping the Enable Pre-Boot DMA Support option enabled.</p> <p> NOTE: This option is provided only for compatibility purposes, since some older hardware is not DMA capable.</p>
Enable OS Kernel DMA Support	<p>Allows you to control the Kernel DMA protection for both internal and external ports. This option does not directly enable DMA protection in the operating system. For operating systems that support DMA protection, this setting indicates to the operating system that the BIOS supports the feature.</p> <p> NOTE: This option is not available when the virtualization setting for IOMMU is disabled (VT-d/AMD Vi).</p> <p>By default, the Enable OS Kernel DMA Support option is enabled.</p> <p> NOTE: This option is provided only for compatibility purposes, since some older hardware is not DMA capable.</p>
Internal Port DMA Compatibility Mode	<p>When enabled, the BIOS will notify the OS that the Internal ports are not DMA capable.</p>

Table 41. BIOS Setup options—Performance menu

Performance	
Intel SpeedStep	
Enable Intel SpeedStep Technology	<p>Enables the computer to dynamically adjust processor voltage and core frequency, decreasing average power consumption and heat production.</p> <p>By default, the Enable Intel SpeedStep Technology option is enabled.</p>
PCIe Resizable Base Address Register (BAR)	
Enable PCIe Resizable Base Address Register (BAR)	<p>Enables or disables PCIe Resizable Base Address Register (BAR) support.</p>

Table 42. BIOS Setup options—System Logs menu

System Logs	
BIOS Event Log	
Clear BIOS Event Log	Allows you to select option to keep or clear BIOS events logs. By default, the Keep Log option is selected.
Power Event Log	
Clear Power Event Log	Allows you to select option to keep or clear power events logs. By default, the Keep Log option is selected.

Updating the BIOS

Updating the BIOS in Windows

About this task

 **CAUTION:** If BitLocker is not suspended before updating the BIOS, the BitLocker key is not recognized the next time you reboot the computer. You will then be prompted to enter the recovery key to proceed, and the computer displays a prompt for the recovery key on each reboot. Failure to provide the recovery key can result in data loss or an operating system reinstall. For more information, refer [Updating the BIOS on Dell systems with BitLocker enabled](#).

 **CAUTION:** Do not turn off the computer during the BIOS flash update process. The computer may not boot if you turn off your computer.

Steps

1. Go to [Dell Support Site](#).
2. Go to **Identify your product or ask support**. In the box, enter the product identifier, model, service request or describe what you are looking for, and then click **Search**.
 -  **NOTE:** If you do not have the Service Tag, click **Detect This PC**. The site automatically detects your device, and you can then click **Explore Product Support** to go to the support page for your device. You can also use the product ID or manually browse for your computer model.
3. Click **Drivers & Downloads**.
4. Select the operating system installed on your computer.
5. In the **Category** drop-down list, select **BIOS**.
6. Select the latest version of BIOS, and click **Download** to download the BIOS file for your computer.
7. After the download is complete, navigate to the folder where the BIOS update file has been saved.
8. Double-click the BIOS update file and follow the on-screen instructions.
For more information, search [Dell Support Site](#).

Updating the BIOS in Linux and Ubuntu

To update the system BIOS on a computer that is installed with Linux or Ubuntu, see [How to Update the Dell BIOS in the Ubuntu or Linux Environment](#) at [Dell Support Site](#).

Updating the BIOS using the USB drive in Windows

About this task

CAUTION: If BitLocker is not suspended before updating the BIOS, the BitLocker key is not recognized the next time you reboot the computer. You will then be prompted to enter the recovery key to proceed, and the computer displays a prompt for the recovery key on each reboot. Failure to provide the recovery key can result in data loss or an operating system reinstall. For more information, refer [Updating the BIOS on Dell systems with BitLocker enabled](#).

CAUTION: Do not turn off the computer during the BIOS flash update process. The computer may not boot if you turn off your computer.

Steps

1. Go to [Dell Support Site](#).
2. Go to **Identify your product or ask support**. In the box, enter the product identifier, model, service request or describe what you are looking for, and then click **Search**.
NOTE: If you do not have the Service Tag, click **Detect This PC**. The site automatically detects your device, and you can then click **Explore Product Support** to go to the support page for your device. You can also use the product ID or manually browse for your computer model.
3. Click **Drivers & Downloads**.
4. Select the operating system installed on your computer.
5. In the **Category** drop-down list, select **BIOS**.
6. Select the latest version of BIOS, and click **Download** to download the BIOS file for your computer.
7. Create a bootable USB drive. For more information, search [Dell Support Site](#).
8. Copy the BIOS setup program file to the bootable USB drive.
9. Connect the bootable USB drive to the computer that needs the BIOS update.
10. Restart the computer and press **F12**.
11. Select the USB drive from the **One Time Boot Menu**.
12. Type the BIOS setup program filename and press **Enter**.
The **BIOS Update Utility** appears.
13. Follow the on-screen instructions to complete the BIOS update.

Updating the BIOS from the One-Time boot menu

To update the BIOS from the One-Time boot menu, see [Updating the BIOS from the One Time Boot Menu](#) at [Dell Support Site](#).

System and setup password

CAUTION: The password features provide a basic level of security for the data on your computer.

CAUTION: Ensure that your computer is locked when it is not in use. Anyone can access the data that is stored on your computer, when left unattended.

Table 43. System and setup password

Password type	Description
System password	Password that you must enter to boot to your operating system.
Setup password	Password that you must enter to access and change the BIOS settings of your computer.

You can create a system password and a setup password to secure your computer.

 **NOTE:** The System and setup password feature is disabled by default.

Assigning a System Setup password

Prerequisites

You can assign a new System or Admin Password only when the status is set to **Not Set**. To enter BIOS System Setup, press F2 immediately after a power-on or reboot.

Steps

1. To enter the **System Setup**, press **F2** immediately after a power-on or reboot.
2. In the **System BIOS** or **System Setup** screen, select **Security** and press Enter.
The **Security** screen is displayed.
3. Select **System/Admin Password** and create a password in the **Enter the new password** field.
Use the following guidelines to create the system password:
 - Password can be up to 32 characters.
 - Password must contain at least one special character: "(! " # \$ % & ' * + , - . / : ; < = > ? @ [\] ^ _ ` { | })"
 - The password can contain numbers from 0 to 9.
 - The password can contain alphabets A to Z and a to z.
4. Type the system password that you entered earlier in the **Confirm new password** field and click **OK**.
5. Press Y to save the changes.
The computer restarts.

Deleting or changing an existing system password or setup password

Prerequisites

Ensure that the **Password Status** is Unlocked in the System Setup before attempting to delete or change the existing system password and/or setup password. You cannot delete or change an existing system password or setup password if the **Password Status** is Locked. To enter the System Setup, press F2 immediately after a power-on or reboot.

Steps

1. To enter the **System Setup**, press **F2** immediately after a power-on or reboot.
2. In the **System BIOS** or **System Setup** screen, select **System Security** and press Enter.
The **System Security** screen is displayed.
3. In the **System Security** screen, verify that the **Password Status** is Unlocked.
4. Select **System Password**. Update or delete the existing system password, and press Enter or Tab.
5. Select **Setup Password**. Update or delete the existing setup password, and press Enter or Tab.
 **NOTE:** If you change the system password and/or setup password, reenter the new password when prompted. If you delete the system password and/or setup password, confirm the deletion when prompted.
6. Press Esc. A message prompts you to save the changes.
7. Press Y to save the changes and exit from **System Setup**.
The computer restarts.

Clearing CMOS settings

About this task

 **CAUTION:** Clearing CMOS settings resets the BIOS settings on your computer.

Steps

1. Remove the [cable cover](#), if applicable.
2. Remove the [side cover](#).
3. Remove the [coin-cell battery](#).
4. Wait one minute.
5. Replace the [coin-cell battery](#).
6. Replace the [side cover](#).
7. Replace the [cable cover](#), if applicable.

Clearing system and setup passwords

About this task

To clear the system or setup passwords, contact Dell technical support as described at [Contact Support](#).

 **NOTE:** For information about how to reset Windows or application passwords, see the documentation accompanying Windows or your application.

Troubleshooting

Dell SupportAssist Pre-boot System Performance Check diagnostics

About this task

SupportAssist diagnostics (also known as system diagnostics) performs a complete check of your hardware. The Dell SupportAssist Pre-boot System Performance Check diagnostics is embedded within the BIOS and launched by the BIOS internally. The embedded system diagnostics provides options for particular devices or device groups allowing you to:

- Run tests automatically or in an interactive mode.
- Repeat the tests.
- Display or save test results.
- Run thorough tests to add more options and obtain details about any failed devices.
- View status messages that inform you when the tests are completed successfully.
- View error messages that inform you of problems encountered during testing.

 **NOTE:** Some tests for specific devices require user interaction. Always ensure that you are present at the computer when the diagnostic tests are performed.

For more information, see [How to Run Dell Preboot Diagnostics and Hardware Tests on Your Dell Computer](#).

Running the SupportAssist Pre-Boot System Performance Check

Steps

1. Turn on your computer.
2. As the computer boots, press the F12 key.
3. On the boot menu screen, select **Diagnostics**.
The diagnostic quick test begins.

 **NOTE:** For more information about running the SupportAssist Pre-Boot System Performance Check on a specific device, see [Dell Support Site](#).

4. If there are any issues, error codes are displayed.
Note the error code and validation number and contact Dell.

Power-Supply Unit Built-in Self-Test

Built-in Self-Test (BIST) helps determine if the power-supply unit is working. To run self-test diagnostics on the power-supply unit of a desktop or all-in-one computer, search in the Knowledge Base Resource at [Dell Support Site](#).

System-diagnostic lights

This section lists the system-diagnostic lights of your Dell Pro Slim QCS1250.

The following table shows different Service LED blinking patterns and associated problems. The diagnostic light codes consist of a two-digit number, and the digits are separated by a comma. The number stands for a blinking pattern; the first digit shows the number of blinks in amber color, and the second digit shows the number of blinks in white color. The Service LED blinks in the following manner:

- The Service LED blinks the number of times equal to the value of the first digit and turns off with a short pause.

- After that, the Service LED blinks the number of times equal to the value of the second digit.
- The Service LED turns off again with a longer pause.
- After the second pause, the blinking pattern will be repeated.

Table 44. Diagnostic light codes

Diagnostic light codes (Amber, White)	Problem description
1,1	TPM Detection Failure
1,2	Unrecoverable SPI Flash Failure
1,5	EC unable to program i-Fuse
1,6	Generic catch-all for ungraceful EC code flow errors
1,7	Non-RPMC Flash on Boot Guard fused system
1,8	Chipset "Catastrophic Error" signal has tripped
2,1	CPU configuration or CPU failure
2,2	System board: BIOS or Read-Only Memory (ROM) failure
2,3	No memory or Random-Access Memory (RAM) detected
2,4	Memory or Random-Access Memory (RAM) failure
2,5	Invalid memory installed
2,6	System board/Chipset Error
2,7	LCD failure SBIOS message
2,8	Display power-rail failure on the system board
3,1	CMOS battery failure
3,2	PCI of Video card/chip failure
3,3	Recovery image not found
3,4	Recovery image found but invalid
3,5	EC power-rail error
3,6	Flash corruption detected by SBIOS
3,7	Timeout waiting on ME to reply to HECI message
4,1	Memory DIMM power rail failure
4,2	CPU Power cable connection issue

Recovering the operating system

When your computer is unable to boot to the operating system even after repeated attempts, it automatically starts Dell SupportAssist OS Recovery.

Dell SupportAssist OS Recovery is a stand-alone tool that is preinstalled on Dell computers running the Windows operating system. It consists of tools to diagnose and troubleshoot issues that may occur before your computer boots to the operating system. It enables you to diagnose hardware issues, repair your computer, back up your files, and restore your computer to its factory state.

You can also download it from the Dell Support website to troubleshoot and fix your computer when it fails to boot into the primary operating system due to software or hardware failures.

For more information about the Dell SupportAssist OS Recovery, see *Dell SupportAssist OS Recovery User's Guide* at [Serviceability Tools at the Dell Support Site](#). Click **SupportAssist** and then click **SupportAssist OS Recovery**.

 **NOTE:** Windows 11 IoT Enterprise LTSC 2024 and Dell ThinOS 10 do not support Dell SupportAssist. For more information about recovering ThinOS 10, see [Recovery mode using R-Key](#).

Real-Time Clock—RTC reset

The Real-Time Clock (RTC) reset function allows you or the service technician to recover the recently launched model Dell Pro and Pro Max computers from **No POST/No Boot/No Power** situations. You can initiate the RTC reset on the computer from a power-off state only if it is connected to AC power. Press and hold the power button for 25 seconds. The system RTC reset occurs after you release the power button.

 **NOTE:** If AC power is disconnected from the computer during the process or the power button is held longer than 40 seconds, the RTC reset process gets aborted.

The RTC reset will reset the BIOS to its default settings, disable Intel vPro, and reset the computer date and time. The following items are not affected by the RTC reset:

- Service Tag
- Asset Tag
- Ownership Tag
- Admin Password
- System Password
- Storage Password
- Key Databases
- System Logs

 **NOTE:** The IT administrator's vPro account and password on the computer will be unprovisioned. The computer must go through the setup and configuration process again to reconnect it to the vPro server.

The below items may or may not be reset based on your custom BIOS setting selections:

- Boot List
- Enable Legacy Option ROMs
- Secure Boot Enable
- Allow BIOS Downgrade

Backup media and recovery options

It is recommended to create a recovery drive to troubleshoot and fix problems that may occur with Windows. Dell provides multiple options for recovering the Windows operating system on your Dell computer. For more information, see [Dell Windows Backup Media and Recovery Options](#).

Network power cycle

About this task

If your computer is unable to access the Internet due to network connectivity issues, reset your network devices by performing the following steps:

Steps

1. Turn off the computer.
2. Turn off the modem.

 **NOTE:** Some Internet service providers (ISPs) provide a modem and router combo device.

3. Turn off the wireless router.
4. Wait for 30 seconds.
5. Turn on the wireless router.
6. Turn on the modem.
7. Turn on the computer.

Getting help and contacting Dell

Self-help resources

You can get information and help on Dell products and services using these self-help resources:

Table 45. Self-help resources

Self-help resources	Resource location
Information about Dell products and services	Dell Site
Contact Support	In Windows search, type <code>Contact Support</code> , and press Enter.
Online help for operating system	Windows Support Site Linux Support Site
Access top solutions, diagnostics, drivers and downloads, and learn more about your computer through videos, manuals, and documents.	Your Dell computer is uniquely identified using a Service Tag or Express Service Code. To view relevant support resources for your Dell computer, enter the Service Tag or Express Service Code at Dell Support Site . For more information about how to find the Service Tag for your computer, see Locate the Service Tag on your computer .
Dell knowledge base articles	<ol style="list-style-type: none"> 1. Go to Dell Support Site. 2. On the menu bar at the top of the Support page, select Support > Support Library. 3. In the Search field on the Support Library page, type the keyword, topic, or model number, and then click or tap the search icon to view the related articles.

Contacting Dell

To contact Dell for sales, technical support, or customer service issues, see [Dell Support Site](#).

 **NOTE:** Availability of the services may vary depending on the country or region, and product.

 **NOTE:** If you do not have an active Internet connection, you can find contact information in your purchase invoice, packing slip, bill, or Dell product catalog.

Revision history

Tracks all updates that are made to the document. It typically includes the date of change, version number, and a brief description of the modification. This log helps maintain transparency, accountability, and a clear timeline of progress.

Table 46. Revision history

Revision	Date	Description
A06	April 2026	Added Quebec requirement information.
A05	Novemeber 2025	Updated views topic.
A04	September 2025	<ul style="list-style-type: none"> • Updated operating and storage environment specifications. • Updated chassis intrusion switch as optional. • Updated storage specifications.
A03	August 2025	Added drive bay installation support for computers that did not have a drive bay previously installed.
A02	August 2025	Updated removal and installation images.
A01	June 2025	<ul style="list-style-type: none"> • Updated BIOS Setup. • Added AMD Radeon RX 7400 and NVIDIA RTX A400 specifications.
A00	March 2025	Original publish date.