



WEITERE INFORMATIONEN



ANLEITUNGEN



Alle Materialien sind mit den
RoHS-Anforderungen kompatibel



P14 Pro PST

140 mm PWM-Lüfter mit Kabelsplitter

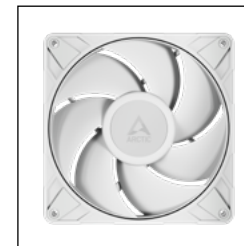
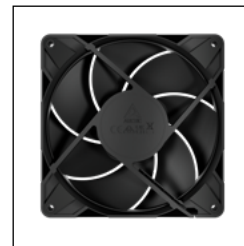
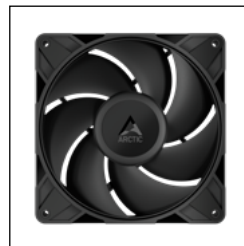

Spezifikationen P14 Pro PST

Allgemeine Spezifikationen

Garantie 6 Jahre

Betriebsumgebungstemperatur 0–40 °C

Abmessungen 140 (L) x 140 (B) x 27 (H) mm

Nettogewicht 242 g

Lüfter-Spezifikationen

Geschwindigkeit 400–2500 rpm (PWM-gesteuert),
0 rpm unter 5 % PWM

Luftstrom 110 cfm | 186 m³/h

Statischer Druck 5,2 mmH₂O

Lüfterlager Hydrodynamisches Gleitlager

Typische Spannung 12 V DC

Anlaufspannung 5 V DC

Stromstärke 0,35 A

Kabellänge 400 mm + 80 mm Daisy-Chain Kabel

Anschluss 4-Pin-Lüfter-Stecker + 4-Pin-Buchse

4-Pin-Lüfter-Stecker + 4-Pin-Buchse

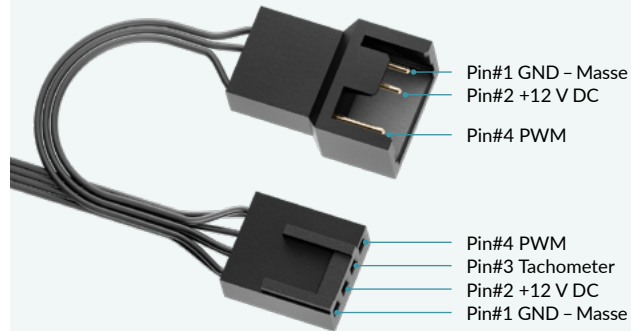

P/Q-Kurve

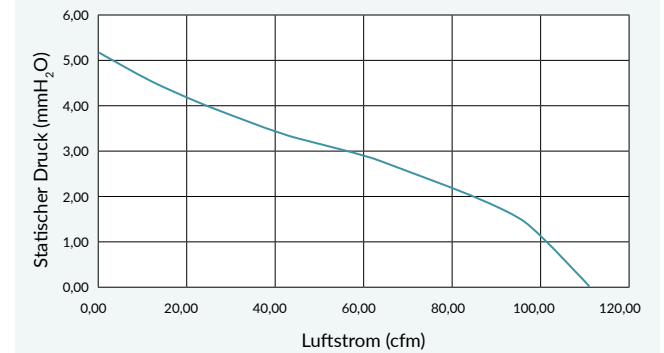

PWM-Regelkurve

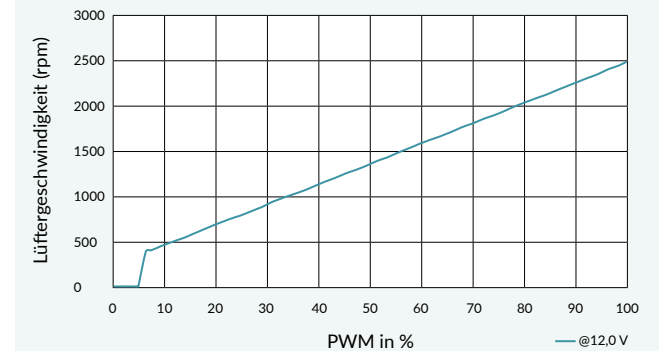

Abmessungen

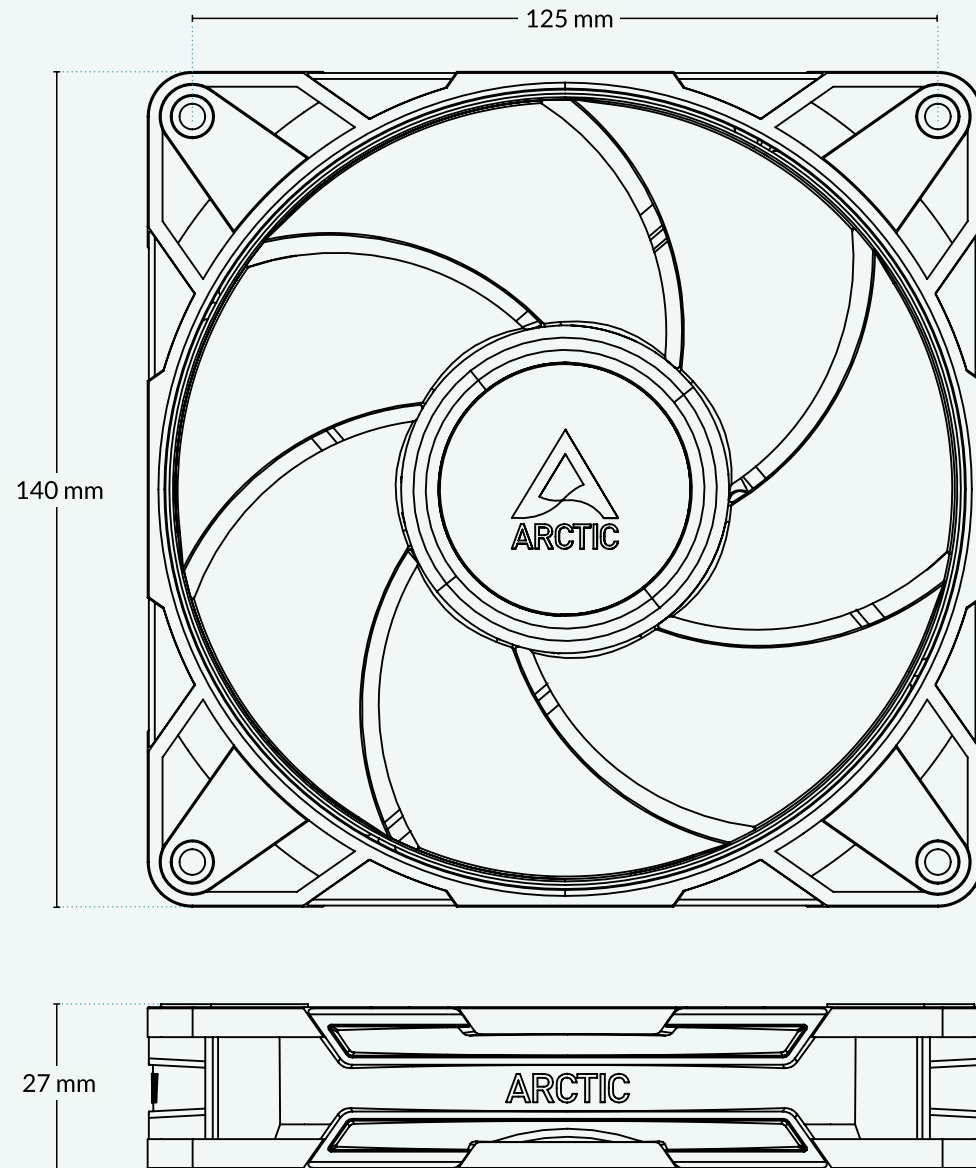

Versandinformationen P14 Pro PST

Box Abmessungen	145 (L) x 145 (B) x 32 (H) mm
Brutto Gewicht	294 g
SKU	ACFAN00314A
EAN	4895265000386
UPC	840033403054
Lieferumfang	P14 Pro PST x1 Montageschrauben x4

Versandinformationen P14 Pro PST - 5 Pack

Box Abmessungen	146 (L) x 145 (B) x 145 (H) mm
Brutto Gewicht	1350 g
SKU	ACFAN00319A
EAN	4895265000430
UPC	840033403108
Lieferumfang	P14 Pro PST x5 Montageschrauben x20

Versandinformationen P14 Pro PST (White)

Box Abmessungen	145 (L) x 145 (B) x 32 (H) mm
Brutto Gewicht	294 g
SKU	ACFAN00317A
EAN	4895265000416
UPC	840033403085
Lieferumfang	P14 Pro PST (White) x1 Montageschrauben x4