

Linux User Guide

Lenovo
ThinkPad



Lenovo

ThinkPad T14 Gen 6 / ThinkPad P14s Gen 6 AMD / ThinkPad T16 Gen 4 / ThinkPad P16s Gen 4 AMD

Read this first

Before using this documentation and the product it supports, ensure that you read and understand the following:

- *Safety and Warranty Guide*
- *Setup Guide*
- [Generic Safety and Compliance Notices](#)

First Edition (March 2025)

© Copyright Lenovo 2025.

LIMITED AND RESTRICTED RIGHTS NOTICE: If data or software is delivered pursuant to a General Services Administration "GSA" contract, use, reproduction, or disclosure is subject to restrictions set forth in Contract No. GS-35F-05925.

Contents

About this documentation iii

Chapter 1. Meet your computer 1

Front view	1
Side view	5
Bottom view	7
USB specifications	8

Chapter 2. Get started with your computer 9

Get started with your desktop	9
Launch an app	9
Launch settings	9
Get support	9
Manage networks	9
Connect to Wi-Fi networks.	10
Connect to a cellular network (for selected models)	10
Airplane mode	10
Interact with your computer	11
Use the camera	11
Use the keyboard shortcuts	11
Use the TrackPoint pointing device	12
Use the Trackpad	13
Use the touch gestures	13
Use the multi-touch screen (for selected models)	14
Connect to an external display	16

Chapter 3. Explore your computer 19

Use the Intelligent Cooling feature	19
Use the P-to-P 2.0 charging function	19
Set the power plan	19
Connect to a Bluetooth-enabled device	20
Enabling Nvidia proprietary drivers in Fedora (for selected models)	20

Chapter 4. Secure your computer and information 21

Lock the computer	21
Use the fingerprint reader (for selected models)	21
Set, change, and remove a password	22
Password types.	23
Power-on password	23
Supervisor password	23
NVMe passwords	23
System management password.	24
Set, change, or remove a password	24

What to do if you forget your power-on password	24
What to do if you forget your system management password	25
What to do if you forget your NVMe password	25
What to do if you forget your supervisor password	25
Use Power Loss Protection function (for selected models)	25

Chapter 5. Configure advanced settings. 27

UEFI BIOS	27
What is UEFI BIOS	27
Enter the UEFI BIOS menu.	27
Navigate in the UEFI BIOS interface	27
Change the startup sequence	27
Detect memory retraining (for Intel models only)	28
Set the system date and time.	28
Recover the UEFI BIOS	28
Update UEFI BIOS	28

Chapter 6. CRU replacement 31

CRU list	31
Disable the built-in battery.	32
Replace a CRU	32
Keyboard	32
Base cover assembly	37
Memory module shielding cap (for selected models)	42
Memory module (for selected models)	45
Wireless WAN module and Wireless WAN module bracket (for selected 4G models)	48
Wireless WAN module and Wireless WAN module bracket (for selected 5G models)	51
M.2 solid-state drive and M.2 solid-state drive bracket	53
Built-in battery	56

Chapter 7. Help and support 61

Frequently asked questions	61
Error messages	62
Beep errors	63
Self-help resources	64
Access product documentation.	64
Visit the Lenovo support Web site	64
Access the Lenovo Limited Warranty.	64

Access Linux distributions 64
Get support information 64
Access open-source information 65
Call Lenovo 65
 Before you contact Lenovo 65
 Lenovo Customer Support Center 66
Purchase additional services. 67

**Appendix A. Compliance
information. 69**

Appendix B. Accessibility features . . 75

**Appendix C. Notices and
trademarks. 77**

About this documentation

- Illustrations in this documentation might look different from your product.
- Depending on the model, some optional accessories, features, software programs, and user interface instructions might not be applicable to your computer.
- Documentation content is subject to change without notice. To get the latest documentation, go to <https://pcsupport.lenovo.com>.







Chapter 1. Meet your computer





Front view

Have a quick glance at the front view of your computer.

ThinkPad T14 Gen 6 / ThinkPad P14s Gen 6 AMD











Item	Description	Item	Description
	Microphone*		Infrared camera* / camera*
	Webcam privacy shutter*		Touch screen*
	Power button with fingerprint reader*		TrackPoint® pointing stick

Item	Description	Item	Description
	Speaker		NFC (near field communication) mark*
	Trackpad		TrackPoint Three Buttons

* for selected models

ThinkPad T16 Gen 4 / ThinkPad P16s Gen 4 AMD



Item	Description	Item	Description
	Microphone*		Infrared camera* / camera*
	Webcam privacy shutter		Touch screen*
	Power button with fingerprint reader*		TrackPoint® pointing stick
	NFC (near field communication) mark*		Trackpad
	TrackPoint Three Buttons		

* for selected models



Webcam privacy shutter

Slide the webcam privacy shutter to cover or uncover the camera lens. It is designed to protect your privacy.

Important information



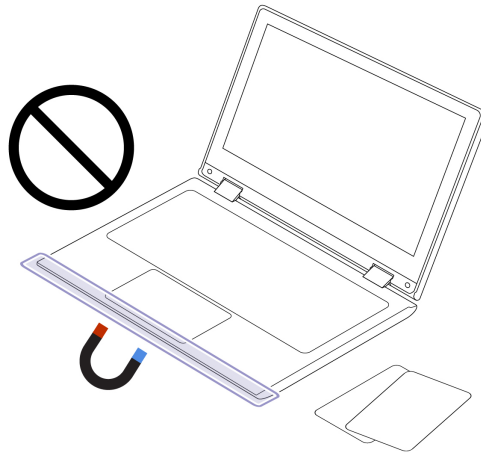



Your computer contains magnets. Keep a safe distance away from devices and objects that might be affected by magnets, such as credit cards.

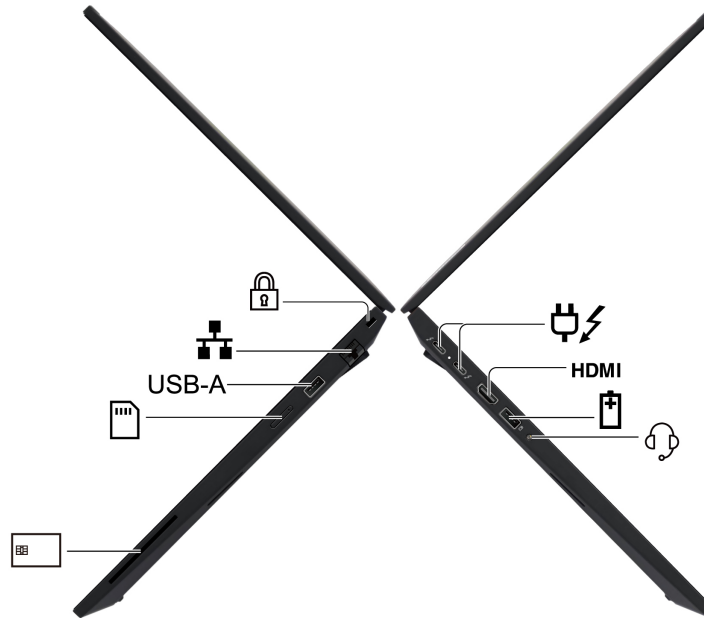

Side view

Have a quick glance at connectors on both sides of your computer.



Item	Description	Item	Description
	USB-C® power connector (Thunderbolt™ 4) Note: For AMD models, when you connect a USB 3.2 Gen 2 device to this connector, the supported transfer rate is up to 10Gbps.	HDMI	HDMI™ connector
	USB-A connector (USB 5Gbps, Always On USB)		Audio connector
	Smart-card* slot		Nano-SIM-card* tray
USB-A	USB-A connector (USB 5Gbps)		Ethernet connector
	Security-lock slot		

* for selected models

Note: For more information about the USB connector name update, see “Notice for USB connector name update” on page 73.

* for selected models

Statement on USB transfer rate

Depending on many factors such as the processing capability of the host and peripheral devices, file attributes, and other factors related to system configuration and operating environments, the actual transfer rate using the various USB connectors on this device will vary and will be slower than the data rate listed in the connector name or below for each corresponding device.

USB device	Data rate (Gbps)
Thunderbolt 3	40
Thunderbolt 4	40

Bottom view

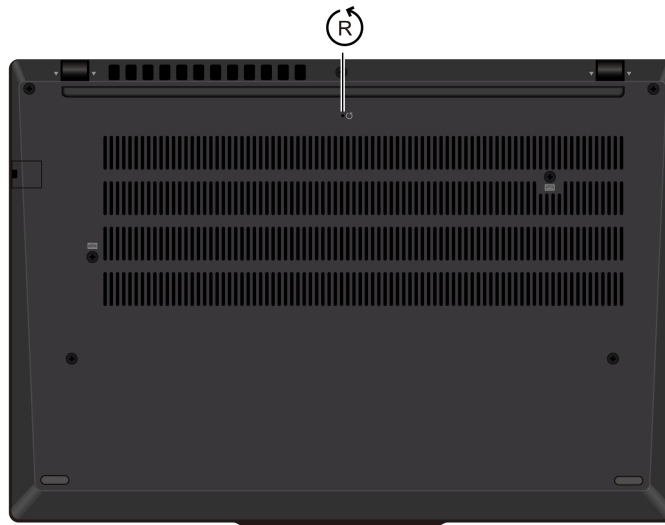

Have a quick glance at the bottom part of your computer.

ThinkPad T14 Gen 6 / ThinkPad P14s Gen 6 AMD

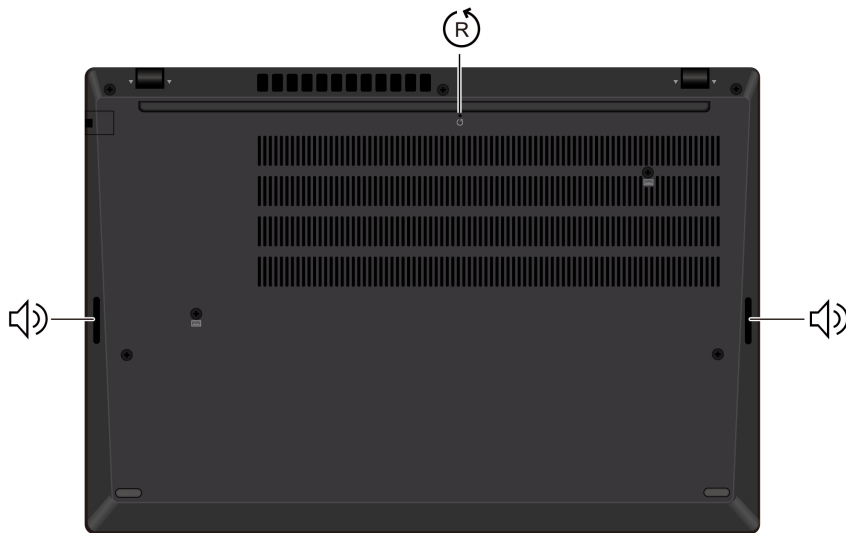

ThinkPad T16 Gen 4 / ThinkPad P16s Gen 4 AMD



Item	Description	Item	Description
	Emergency-reset hole		Speaker

 **Emergency-reset hole**

Emergency-reset hole can help you to recover computer when the computer stops responding and you cannot turn it off by pressing the power button. Do the following to reset your computer:

1. Disconnect your computer from ac power.
2. Insert a straightened paper clip into the hole to cut off power supply temporarily.
3. Connect your computer to ac power and then turn on your computer.

Note: If your computer is still no response, you can call Lenovo Customer Support Center to get further help.

CAUTION:

When the computer is operating, it should be placed on a hard and flat surface with its bottom area not in contact with user’s bare skin. Under normal operating conditions, the temperature of the bottom surface will remain within an acceptable range as defined in IEC 62368-1, but such temperatures can still be high enough to cause discomfort or harm to the user if directly touched for over one minute at a time. As such, it is recommended that users avoid prolonged direct contact with the bottom of the computer.

USB specifications

Get to know more USB specifications.

Note: Depending on the model, some USB connectors might not be available on your computer.

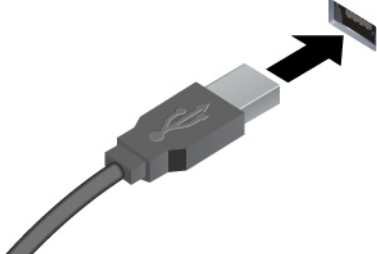
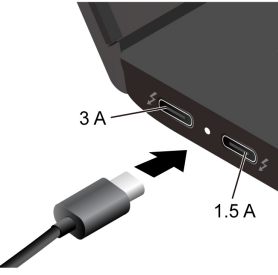
Connector name	Description
 <ul style="list-style-type: none">• USB-A connector (USB 5Gbps)	<p>Connect USB-compatible devices, such as a USB keyboard, USB mouse, USB storage device, or USB printer.</p> <hr/> <ul style="list-style-type: none">• USB-C connector (Thunderbolt 4)• USB-C connector (DP Alt mode DP2.1)
 <ul style="list-style-type: none">• USB-C connector (Thunderbolt 4)• USB-C connector (DP Alt mode DP2.1)	<ul style="list-style-type: none">• Charge USB-C compatible devices with the output voltage and current of 5 V and 3 A or 1.5 A.• Connect to an external display:<ul style="list-style-type: none">– USB-C to VGA: up to 1920 x 1200 pixels, 60 Hz– USB-C to DP: up to 5120 x 3200 pixels, 60 Hz• Connect to USB-C accessories to help expand your computer functionality. To purchase USB-C accessories, go to https://www.lenovo.com/accessories. <hr/>

Chapter 2. Get started with your computer

Get started with your desktop

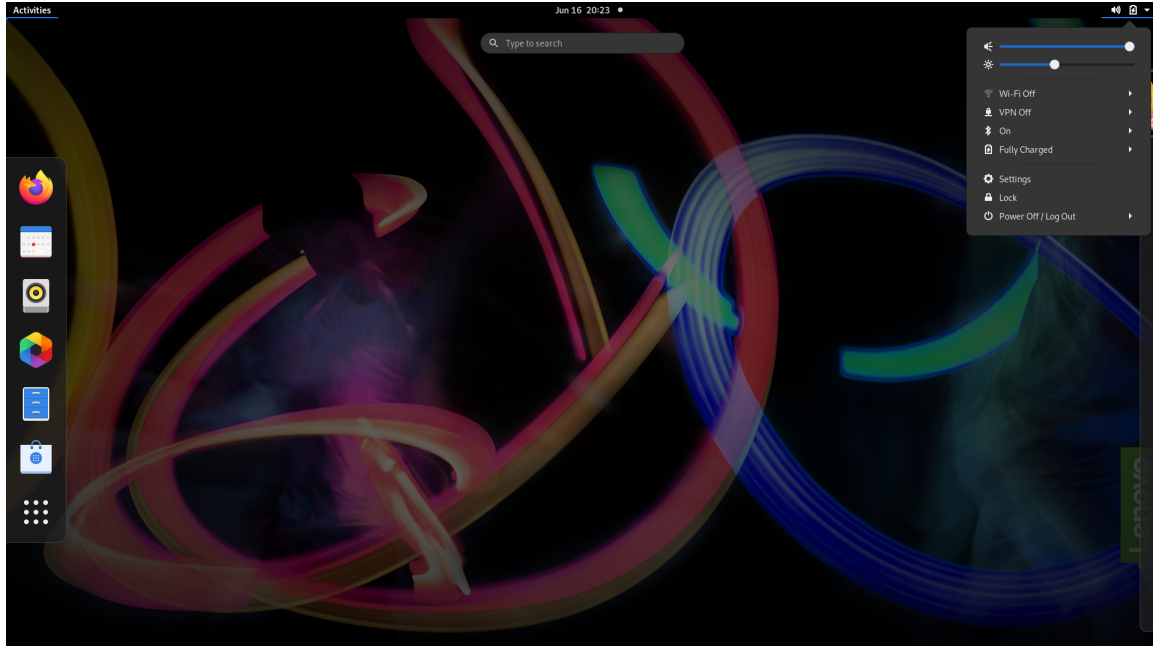

Launch an app

- Use the super key (with the Windows logo) or open the Activities menu on the top left and type in the name of the application you want to launch.
- Click the "show application" menu (For the Fedora operating system, you can see the menu after opening Activities menu) on the lower left and type in the name of the application you want to launch.

Launch settings

Select the system menu arrow on the top right and click on **Settings**.

Get support

Select the system menu arrow on the top right and click on **Settings**.

- For the Ubuntu operating system, see the Ubuntu documentation site at <https://help.ubuntu.com/its/ubuntu-help/index.html>.
- For the Fedora operating system, see the Fedora project wiki at https://fedoraproject.org/wiki/Fedora_Project_Wiki.
- The Gnome desktop is installed by default and is designed to be simple and easy to use. Details on using Gnome are available by launching the Help application or online at <https://help.gnome.org/users/>.

Manage networks

Your computer helps you connect to the world through a wired or wireless network.

Connect to Wi-Fi networks

1. Click the system menu arrow on the top right. A list of available wireless networks is displayed.
2. Select a network available for connection. Provide required information, if needed.

Connect to a cellular network (for selected models)

To connect a 4G or 5G cellular data network, you must have a wireless wide area network (WWAN) card and a nano-SIM card installed. The nano-SIM card might come with your computer by countries or regions. If no nano-SIM card is shipped, you need to purchase one from authorized service carriers.

Notes:

- Depending on the model, your computer might have no WWAN card installed. The 4G or 5G cellular service is provided by authorized mobile service carriers in some countries or regions. You must have a cellular plan from a service carrier to connect to the cellular network. The cellular data plan might vary by location.
- For details on Linux WWAN status for your platform, refer to <https://www.lenovo.com/linux/wwan-enablement-on-Linux.pdf>. Check here first if WWAN is supported on Linux for your platform.
- Network connection speeds might also vary by location, environment, network conditions and other factors.

To establish a cellular connection:

1. Go to <https://support.lenovo.com> and select the entry for your computer. Download the wwan-linux-fcc-unlock package from the product support page. Make sure to check the README to confirm if any restrictions for your geography apply, and to get instructions on how to install the application.

Note: This installs the utilities that are needed to unlock your modem and enable it to run under Linux.

2. Turn off the computer.
3. Insert a straightened paper clip into the hole in the nano-SIM-card tray. The tray ejects. Install a nano-SIM card as shown and insert the tray into the nano-SIM card slot. Note the orientation of the card and ensure that it is seated correctly.

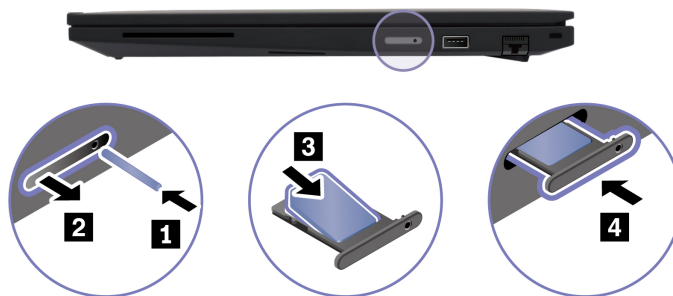

4. Turn on the computer.
5. Click the network icon, and then select the cellular network icon  from the list. Provide required information, if needed.

Airplane mode

When the Airplane mode is enabled, all wireless features are disabled.

To enable or disable the Airplane mode:

1. Use the system menu drop down (top right) and choose **Settings**.
2. Click the Wi-Fi option.
3. Turn on or turn off the **Airplane mode** switch.

Interact with your computer

Your computer provides you various ways to navigate the screen.

Use the camera

- Take pictures or record videos by using the **Snapshot** application. The indicator next to the camera is on when the camera is in use.
- If you use other apps that support photographing, video chatting, and video conference, the camera starts automatically when you enable the camera-required feature from the app.









Note: IR function is currently limited in Linux. Make sure the regular camera mode is selected if you see gray lines.

Use the keyboard shortcuts





Keyboard shortcuts are keys or combinations of keys that provide a quick way to perform particular functions. They help you work more efficiently.

The following tables introduce the functions of keyboard shortcuts.

FnLock and function keys

Key / Key combination	Function description
	Switch between the special and standard functions of the function keys (F1–F12).
Fn+FnLock	Function keys provide two sets of functions: special function and standard function. Icons on the key denote the special function, such as  and  . Characters on the key denote the standard function, such as F1 and F2. LED indicator on Esc key indicates which function of the function keys is enabled: <ul style="list-style-type: none"> • When the indicator is off, the special function is enabled. • When the indicator is on, the standard function is enabled.
	Mute / Unmute (Speakers).
	Decrease volume.
	Increase volume.
	Enable / Disable the microphone.
	Decrease screen brightness.
	Increase screen brightness.
	Select and set up display devices.
Mode	Change power mode.

Other general keyboard shortcuts

Key combination	Function description
Fn+ 	Open the context menu of the current active app.
Fn+ 	Open the Calculator (for ThinkPad T16 Gen 4 / ThinkPad P16s Gen 4 AMD).
Fn+ 	Put the computer to sleep (for ThinkPad T16 Gen 4 / ThinkPad P16s Gen 4 AMD).
Fn+ 	Adjust the keyboard backlight.
Fn+<	Go to beginning.
Fn+>	Go to end.
Fn+Tab	Open Magnifier. Note: Press the Windows logo key+Esc to turn it off.
Fn+4	Enter sleep mode.
Fn+B	Break operation.
Fn+K	Scroll contents.
Fn+P	Pause operation.
Fn+S	Send system request.
Fn+N	Open system information Window.

Use the TrackPoint pointing device

The TrackPoint pointing device enables you to perform all the functions of a traditional mouse, such as pointing, clicking, and scrolling.



1. Pointing stick

Use your index finger or middle finger to apply pressure to the pointing-stick nonslip cap in any direction parallel to the keyboard. The pointer on the screen moves accordingly but the pointing stick itself does not move. The higher the pressure applied, the faster the pointer moves.

2. Left-click button

Press to select or open an item.

3. Right-click button

Press to display a shortcut menu.

4. Middle button

Press and hold the dotted middle button while applying pressure to the pointing stick in the vertical or horizontal direction. Then, you can scroll through the document, Web site, or apps.

Replace the pointing-stick nonslip cap

Note: Ensure that the new cap has grooves **a**.

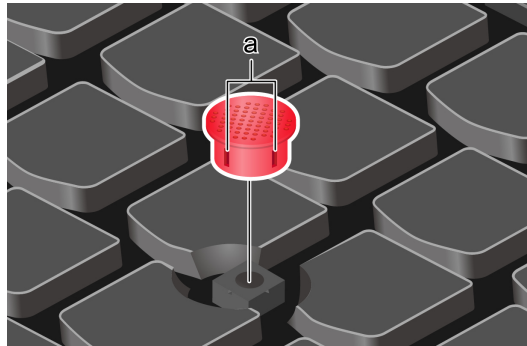

Use the Trackpad

The entire Trackpad surface is sensitive to finger touch and movement. You can use the Trackpad to perform all the pointing, clicking, and scrolling functions of a traditional mouse. Tap on the surface of the Trackpad with one finger to perform the left-click action, with two fingers to perform the right-click action.

Use the touch gestures

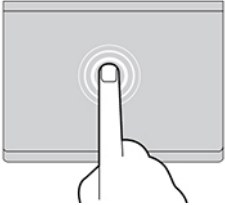
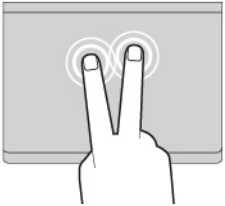
Illustration	Description
	Tap Tap anywhere on the Trackpad with one finger to select or open an item.
	Two-finger tap Tap anywhere on the Trackpad with two fingers to display a shortcut menu.

Illustration

Description

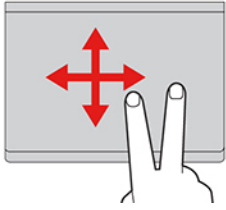

Two-finger scroll

Put two fingers on the Trackpad and move them in the vertical or horizontal direction. This action enables you to scroll through the document, Web site, or apps.

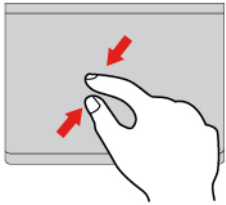

Two-finger zoom out

Put two fingers on the Trackpad and move them closer together to zoom out.

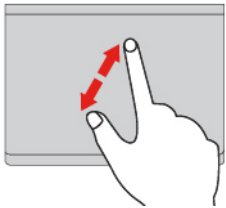

Two-finger zoom in

Put two fingers on the Trackpad and move them farther apart to zoom in.

Notes:

- When using two or more fingers, ensure that you position your fingers slightly apart.
- Some gestures are not available if the last action was done from the TrackPoint pointing device.
- Some gestures are only available when you are using certain apps.
- If the Trackpad surface is stained with oil, turn off the computer first. Then, gently wipe the Trackpad surface with a soft and lint-free cloth moistened with lukewarm water or computer cleaner.

For more gestures, see the help information of the pointing device.

Use the multi-touch screen (for selected models)

If your computer display supports the multi-touch function, you can navigate the screen with simple touch gestures.

Note: Some gestures might not be available depending on the app you use.

Illustration

Description



Tap once

- From the **Start** menu: Open an app or item.
- From the desktop: Select an app or item.
- In an open app: Perform an action such as **Copy**, **Save**, and **Delete**, depending on the app.

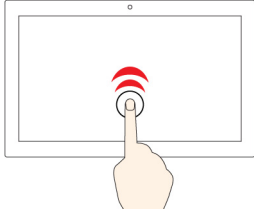

Tap twice quickly

Open an app or item from the desktop.

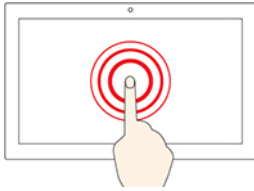

Tap and hold

Open a shortcut menu.

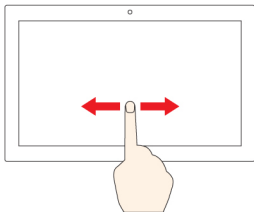

Slide

Scroll through items, such as lists, pages, and photos.

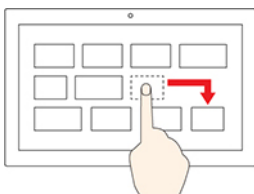

Drag an item to the location you want

Move an object.

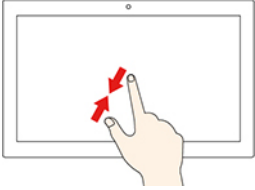
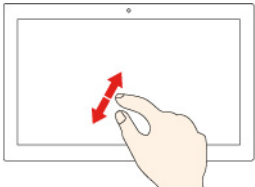
Illustration	Description
	<p>Move two fingers closer together</p> <p>Zoom out.</p>
	<p>Move two fingers farther apart</p> <p>Zoom in.</p>

Tips

- Turn off the computer before cleaning the multi-touch screen.
- Use a dry, soft, and lint-free cloth or a piece of absorbent cotton to remove fingerprints or dust from the multi-touch screen. Do not apply solvents to the cloth.
- The multi-touch screen is a glass panel covered with a plastic film. Do not apply pressure or place any metallic object on the screen, which might damage the touch panel or cause it to malfunction.
- Do not use fingernails, gloved fingers, or inanimate objects for input on the screen.
- Regularly calibrate the accuracy of the finger input to avoid a discrepancy.

Connect to an external display

Connect your computer to a projector or a monitor to give presentations or expand your workspace.

Connect to a wired display

- Step 1. Connect the external display to an appropriate video connector on your computer.
- Step 2. Connect the external display to an electrical outlet.
- Step 3. Turn on the external display.

If your computer cannot detect the external display, right-click a blank area on the desktop, and then click **Display settings**.

Set the display mode

Press F7 or Fn + F7 and then select a display mode of your preference.

Change display settings

- Step 1. Right-click a blank area on the desktop and select **Display settings**.
- Step 2. Select the display that you want to configure.
- Step 3. Change display settings of your preference.

You can change the settings for both the computer display and the external display. For example, you can define which one is the main display and which one is the secondary display. You also can change the resolution and orientation.

Note: If you set a higher resolution for the computer display than the external display, only part of the screen can be displayed on the external display.

Chapter 3. Explore your computer

Use the Intelligent Cooling feature

The Intelligent Cooling feature enables your computer to work in the following three modes:

- Power Saver mode: the quietest fan speed
- Balanced mode: balanced performance and fan speed
- Performance mode: the highest performance and normal fan speed

Your computer starts up in balanced mode by default, do the following to switch to the preferred mode:

- Press Fn+L to switch to power saver mode.
- Press Fn+M to switch to balanced mode.
- Press Fn+H to switch to performance mode.

Use the P-to-P 2.0 charging function

The USB-C connector on the computer features the Lenovo-unique P-to-P 2.0 charging function. When no ac power is available, this feature enables one computer to supply power to another computer through a USB-C to USB-C cable. When ac power is available for only one computer, this feature enables both computers to get charged by ac power.

Before using the function, ensure that:

- The selected connectors support the P-to-P 2.0 charging function and power delivery function.
- **Always On USB** and **Charge in Battery Mode** are enabled in UEFI BIOS of both computers, so that the function works even when the computers are off or in hibernation mode. To enable **Always On USB** and **Charge in Battery Mode**:
 1. Enter the UEFI BIOS menu. See “Enter the UEFI BIOS menu” on page 27.
 2. Click **Config** → **USB** to enable **Always On USB** and **Charge in Battery Mode**.

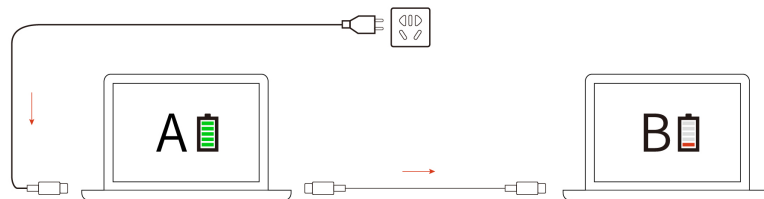

Note: The actual charging speed using the Lenovo-unique P-to-P 2.0 charging function varies depending on many factors, such as the remaining battery power of the computers, the wattage of the ac power adapter, and whether you are using the computers.

Set the power plan

For ENERGY STAR® compliant computers, the following power plan takes effect when your computers have been idle for a specified duration:

- Turn off the display: After 5 minutes

- Put the computer to sleep: After 20 minutes

To reset the power plan to achieve the best balance between performance and power saving:

1. Click on the battery symbol in the system menu drop down box and select **Power Settings**.
2. Choose or customize a power plan of your preference.

Note: Disabling automatic suspend will result in higher power consumption. It is recommended to keep automatic suspend enabled.

Connect to a Bluetooth-enabled device

You can connect all types of Bluetooth-enabled devices to your computer, such as a keyboard, a mouse, a smartphone, or speakers. To ensure the connection is successful, place the devices 10 meters (33 feet), at most, from the computer.

1. Turn on Bluetooth on the computer.
 - Click the system menu drop down (top right) and choose **Settings**.
 - Choose the Bluetooth menu and enable Bluetooth with the toggle button at the top.
2. Any discoverable devices will be shown in the **Devices** list.
3. Select a Bluetooth device, and then follow the on-screen instructions.

Your Bluetooth-enabled device and computer will automatically connect the next time if the two devices are in range of each other with Bluetooth turned on. You can use Bluetooth for data transfer or remote control and communication.

Enabling Nvidia proprietary drivers in Fedora (for selected models)

Your computer might come with an Nvidia card. The Nvidia proprietary drivers that will enable you to take advantage of performance benefits and new graphics functionality are not installed by default with Fedora.

To enable the proprietary drivers:

1. Launch the **Software** utility.
2. From the top right selection box choose Software Repositories.
3. Enable third party repositories.
4. Enable **RPM Fusion for Fedora → Nonfree → Nvidia Driver** and close the Software Repositories window.
5. Go to the updates tab and click on the curved arrow on the top left to refresh the software cache. Reboot the machine and launch the Software utility again.
6. Select **Add-ons** on the bottom right and choose the **Hardware Drivers** tab.
7. Select **NVIDIA Linux Graphics Driver**.
8. Select **Install** and wait for the installation to complete. This can take a few minutes.
9. Reboot and confirm Nvidia drivers are running using the **nvidia-settings** utility.

Chapter 4. Secure your computer and information

Lock the computer

Lock your computer to a desk, table, or other fixtures through a compatible security cable lock.

Note: The slot supports cable locks that conform to the Kensington Nano Saver® lock standards using Cleat™ locking technology. You are responsible for evaluating, selecting, and implementing the locking device and security feature. Lenovo is not responsible for the locking device and security feature. You can purchase the cable locks at <https://smartfind.lenovo.com>.

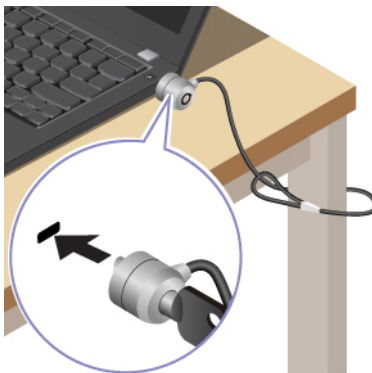

Use the fingerprint reader (for selected models)

If your computer comes with a fingerprint reader, you can use it to enroll your fingerprints. After enrollment, you can tap your finger on the fingerprint reader to log in to the system.

Enroll your fingerprints

Open the system menu and then click **Settings** → **Users** → **Fingerprint Login**. Then, follow the on-screen instructions to finish the enrollment.

During the enrollment, the fingerprints are associated with the user password automatically. It is recommended that you enroll more than one fingerprint in case of any injuries to your fingers.

Log in with your fingerprint

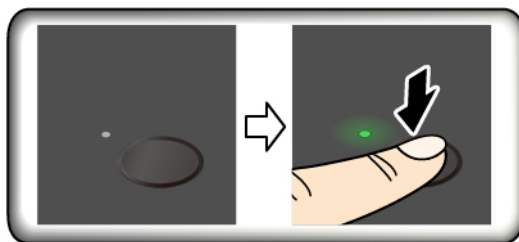

Maintain the fingerprint reader

To ensure that the fingerprint reader works correctly, do not:

- Scratch the surface of the reader with anything hard or sharp.
- Use or touch the reader with a wet, dirty, wrinkled, or injured finger.

Set, change, and remove a password

Before you start, print these instructions.

1. Restart the computer. When the logo screen is displayed, press F1 to enter the UEFI BIOS menu.
2. Select **Security** → **Password** by using the arrow keys.
3. Select the password type. Then, follow the on-screen instructions to set, change, or remove a password.

You should record all your passwords and store them in a safe place. If you forget any of your passwords, any potential repair actions required are not covered under warranty.

What to do if you forget your power-on password

If you forget your power-on password, do the following to remove the power-on password:

- If you have set a supervisor password and remember it:
 1. Restart the computer. When the logo screen is displayed, immediately press F1.
 2. Type the supervisor password to enter the UEFI BIOS menu.
 3. Select **Security** → **Password** → **Power-On Password** by using the arrow keys.
 4. Type the current supervisor password in the **Enter Current Password** field. Then, leave the **Enter New Password** field blank, and press Enter twice.
 5. In the Changes have been saved window, press Enter.
 6. Press F10 to save changes and exit the UEFI BIOS menu.
- If you have not set a supervisor password, contact a Lenovo authorized service provider to have the power-on password removed.

What to do if you forget your hard disk password

If you forget your user hard disk password or both user and master hard disk passwords, Lenovo cannot reset your passwords or recover data from the storage drive. You can contact a Lenovo authorized service provider to have the storage drive replaced. A fee will be charged for parts and service. If the storage drive is a CRU (Customer Replaceable Unit), you can also contact Lenovo to purchase a new storage drive to replace the old one by yourself. To check whether the storage drive is a CRU and the relevant replacement procedure, see Chapter 6 “CRU replacement” on page 31.

What to do if you forget your supervisor password

If you forget your supervisor password, there is no service procedure to remove the password. You have to contact a Lenovo authorized service provider to have the system board replaced. A fee will be charged for parts and service.

What to do if you forget your system management password

If you forget your system management password, do the following to remove the system management password:

- If you have set a supervisor password and remember it:
 1. Restart the computer. When the logo screen is displayed, immediately press F1.
 2. Type the supervisor password to enter the UEFI BIOS menu.
 3. Select **Security** → **Password** → **System Management Password** by using the arrow keys.
 4. Type the current supervisor password in the **Enter Current Password** field. Then, leave the **Enter New Password** field blank, and press Enter twice.

5. In the Changes have been saved window, press Enter.
 6. Press F10 to save changes and exit the UEFI BIOS menu.
- If you have not set a supervisor password, contact a Lenovo authorized service provider to have the system management password removed.
-

Password types

You can set a power-on password, supervisor password, system management password, or NVMe password in UEFI BIOS to prevent unauthorized access to your computer.

However, you are not prompted to enter any UEFI BIOS password when your computer resumes from sleep mode.

Power-on password

If you set a power-on password, a window is displayed on the screen when you turn on the computer. Enter the correct password to use the computer.

Supervisor password

The supervisor password protects the system information stored in UEFI BIOS. When entering the UEFI BIOS menu, enter the correct supervisor password in the window prompted. You also can press Enter to skip the password prompt. However, you cannot change most of the system configuration options in UEFI BIOS.

If you have set both the supervisor password and power-on password, you can use the supervisor password to access your computer when you turn it on. The supervisor password overrides the power-on password.

NVMe passwords

The NVMe password prevents unauthorized access to the data on the storage drive. When an NVMe password is set, you are prompted to type a correct password each time you try to access the storage drive.

- **Single Password**

When a Single NVMe password is set, the user must enter the user NVMe password to access files and applications on the storage drive.

- **Dual Password (User+Admin)**

The admin NVMe password is set and used by a system administrator. It enables the administrator to access any storage drive in a system or any computer connected in the same network. The administrator can also assign a user NVMe password for each computer in the network. The user of the computer can change the user NVMe password as desired, but only the administrator can remove the user NVMe password.

When prompted to enter an NVMe password, press F1 to switch between the admin NVMe password and user NVMe password.

Notes: The NVMe password is not available in the following situations:

- A Trusted Computing Group (TCG) Opal-compliant storage drive and a TCG Opal management software program are installed in the computer, and the TCG Opal management software program is activated.
- An eDrive storage drive is installed in the computer preinstalled with the Windows operating system.

System management password

The system management password can also protect the system information stored in UEFI BIOS like a supervisor password, but it has lower authority by default. The system management password can be set through the UEFI BIOS menu or through Windows Management Instrumentation (WMI) with the Lenovo client-management interface.

You can enable the system management password to have the same authority as the supervisor password to control security-related features. To customize the authority of the system management password through the UEFI BIOS menu:

- Step 1. Restart the computer. When the logo screen is displayed, press F1 to enter the UEFI BIOS menu.
- Step 2. Select **Security → Password → System Management Password Access Control**.
- Step 3. Follow the on-screen instructions.

If you have set both the supervisor password and the system management password, the supervisor password overrides the system management password. If you have set both the system management password and the power-on password, the system management password overrides the power-on password.

Set, change, or remove a password

Follow the instructions to set, change or remove a password.

Before you start, print these instructions.

- Step 1. Restart the computer. When the logo screen is displayed, press F1 to enter the UEFI BIOS menu.
- Step 2. Select **Security → Password** by using the arrow keys.
- Step 3. Select the password type. Then, follow the on-screen instructions to set, change, or remove a password.

You should record all your passwords and store them in a safe place. If you forget any of your passwords, any potential repair actions required are not covered under warranty.

What to do if you forget your power-on password

Follow the instructions to remove the power-on password if you forget your power-on password.

If you have set a supervisor password or a system management password and remember it:

- Step 1. Restart the computer. When the logo screen is displayed, immediately press F1.
- Step 2. Type the supervisor password or the system management password to enter the UEFI BIOS menu.
- Step 3. Select **Security → Password → Power-On Password** by using the arrow keys.
- Step 4. Type the current supervisor password or the system management password in the **Enter Current Password** field. Then, leave the **Enter New Password** field blank, and press Enter twice.
- Step 5. In the Changes have been saved window, press Enter.
- Step 6. Press F10 to save changes and exit the UEFI BIOS menu.

If you have not set a supervisor password or a system management password, contact a Lenovo-authorized service provider to have the power-on password removed.

What to do if you forget your system management password

Follow the instructions to remove the system management password if you forget your system management password.

If you have set a supervisor password and remember it:

- Step 1. Restart the computer. When the logo screen is displayed, immediately press F1.
- Step 2. Type the supervisor password to enter the UEFI BIOS menu.
- Step 3. Select **Security** → **Password** → **System Management Password** by using the arrow keys.
- Step 4. Type the current supervisor password in the **Enter Current Password** field. Then, leave the **Enter New Password** field blank, and press Enter twice.
- Step 5. In the Changes have been saved window, press Enter.
- Step 6. Press F10 to save changes and exit the UEFI BIOS menu.

If you have not set a supervisor password, contact a Lenovo-authorized service provider to have the system management password removed.

What to do if you forget your NVMe password

Follow the instructions to remove the NVMe password if you forget your NVMe password.

If you forget your NVMe password (Single password) or both user and admin NVMe passwords (Dual password), Lenovo cannot reset your passwords or recover data from the storage drive. You can contact a Lenovo-authorized service provider to have the storage drive replaced. A fee will be charged for parts and service. If the storage drive is a CRU (Customer Replaceable Unit), you can also contact Lenovo to purchase a new storage drive to replace the old one by yourself. To check whether the storage drive is a CRU and the relevant replacement procedure, see “CRU list” on page 31.

What to do if you forget your supervisor password

There is no service procedure to remove the password. You can contact a Lenovo-authorized service provider to have the system board replaced. A fee will be charged for parts and service.

Use Power Loss Protection function (for selected models)

For models shipped with an NVMe (Non-Volatile Memory express) M.2 solid-state drive, the M.2 solid-state drive features the Lenovo-unique PLP (Power Loss Protection) function to avoid data loss or damage. On very rare occasions, your computer is not responding and you might have to shut down your computer by pressing and holding the power button for about seven seconds. In this case, the PLP function enables key data of your computer to be saved timely. However, there is no guarantee that all data is saved in any situation. To check the type of your M.2 solid-state drive:

1. Restart the computer. When the logo screen is displayed, press F10 to enter the Lenovo diagnostics window.
2. On the TOOLS tab, select **SYSTEM INFORMATION** → **STORAGE** using the arrow keys.
3. Locate the **Device Type** section to check the information.

Chapter 5. Configure advanced settings

UEFI BIOS

This section introduces what is UEFI BIOS and the operations you can perform in UEFI BIOS.

What is UEFI BIOS

UEFI BIOS is the first program that the computer runs when the computer is turned on. UEFI BIOS initializes the hardware components and loads the operating system and other programs. Your computer comes with a setup program with which you can change UEFI BIOS settings.

Enter the UEFI BIOS menu

Restart the computer. When the logo screen is displayed, press F1 to enter the UEFI BIOS menu.

Note: If you have set the supervisor password, enter the correct password when prompted. You also can press Enter to skip the password prompt and enter the UEFI BIOS menu. However, you cannot change the system configurations that are protected by the supervisor password.

Navigate in the UEFI BIOS interface

Attention: The default configurations are already optimized for you in **boldface**. Improper change of the configurations might cause unexpected results.

You can navigate in the UEFI BIOS interface by pressing the following keys:

Key	Description
F1	Display the General Help screen.
F9	Restore to the default settings.
F10	Save your configuration and exit.
F5	Change to a lower value.
F6	Change to a higher value.
↑ ↓	Locate an item.
← →	Select a tab.
Esc	Exit the submenu and return to the parent menu.
Enter	Enter the selected tab or submenu.

Change the startup sequence

1. Restart the computer. When the logo screen is displayed, press F1.
2. Select **Startup → Boot**. Then, press Enter. The default device order list is displayed.

Note: No bootable device is displayed if the computer cannot start from any devices or the operating system cannot be found.

3. Set the startup sequence as desired.
4. Press F10 to save the changes and exit.

To change the startup sequence temporarily:

1. Restart the computer. When the logo screen is displayed, press F12.
2. Select the device that you want the computer to start from and press Enter.

Detect memory retraining (for Intel models only)

Memory retraining is a process to initialize the memory module and run diagnostic tests for the memory module in your computer. The memory retraining might occur during POST if any of the following situations is detected:

- Memory module replacement
- Total Memory Encryption setting change in UEFI BIOS
- UEFI BIOS update (Memory Reference Code [MRC] change)

When memory retraining occurs, the screen might be blank. You might see the LED indicators on Esc, F1, and F4 blinking sequentially to indicate the progress. Do not press the power button to interrupt the process. Wait a few minutes until the logo screen is displayed.

Set the system date and time

1. Restart the computer. When the logo screen is displayed, press F1.
2. Select **Date/Time** and set the system date and time as desired.
3. Press F10 to save changes and exit.

Recover the UEFI BIOS

If the UEFI BIOS is corrupted or maliciously attacked, it can self-recover and restore your computer from the last uncorrupted and secure backup. This function protects your computer data.

During the UEFI BIOS self-recovery, the screen might be blank. You can check the progress based on blinking modes of the LED indicators on Esc, F1, and F4. For details, refer to the following table.

Note: Do not press the power button to interrupt the progress. Wait a few minutes until the logo screen is displayed.

Blinking modes	Self-recovery progress
LED indicator on Esc blinks	0% to 32%
LED indicators on Esc and F1 blink simultaneously	33% to 65%
LED indicators on Esc, F1 and F4 blink simultaneously	66% to 100%

Update UEFI BIOS

When you install a new program, device driver, or hardware component, you might need to update UEFI BIOS.

Download and install the latest UEFI BIOS update package by one of the following methods:

- Use the fwupdmgr or software utility to check LVFS for firmware updates.
- Go to <https://pcsupport.lenovo.com> and select the entry for your computer. Then, follow the on-screen instructions to download and install the latest UEFI BIOS update package.

Note: During the UEFI BIOS update process, Memory Reference Code (MRC) change might cause memory retraining. Memory retraining is a process to initialize the memory module and run diagnostic tests for the memory module in your computer. When memory retraining occurs, the screen might be blank. You might see the LED indicators on Esc, F1, and F4 blinking sequentially to indicate the progress. Do not press the power button to interrupt the process. Wait a few minutes until the logo screen is displayed.

To know more about UEFI BIOS, visit Knowledge Base of your computer at <https://pcsupport.lenovo.com>.

Chapter 6. CRU replacement

Customer Replaceable Units (CRUs) are parts that can be replaced by the customer. The computers contain the following types of CRUs:

- **Self-service CRUs:** Refer to parts that can be replaced easily by customer themselves or by trained service technicians at an additional cost.
- **Optional-service CRUs:** Refer to parts that can be replaced by customers with a greater skill level. Trained service technicians can also provide service to replace the parts under the type of warranty designated for the customer's machine.

If you intend on installing a CRU, Lenovo will ship the CRU to you. CRU information and replacement instructions are shipped with your product and are available from Lenovo at any time upon request. You might be required to return the defective part that is replaced by the CRU. When return is required: (1) return instructions, a prepaid shipping label, and a container will be included with the replacement CRU; and (2) you might be charged for the replacement CRU if Lenovo does not receive the defective CRU within thirty (30) days of your receipt of the replacement CRU. For full details, see the Lenovo Limited Warranty documentation at https://www.lenovo.com/warranty/llw_02.

CRU list

This topic provides the CRU list of your computer.

Self-service CRUs

- ac power adapter*
- Base cover assembly
- Keyboard
- Memory module*
- Memory module shielding cap*
- M.2 solid-state drive
- M.2 solid-state drive bracket
- Nano-SIM-card tray*
- Power cord*

Optional-service CRUs

- Built-in battery
- Wireless WAN module*
- Wireless-WAN-module bracket*

* for selected models

Note: Replacement of any parts not listed above, including the built-in rechargeable battery (non-CRUable), should be done by a qualified repair technician or by ensuring that you carefully follow all instructions provided by Lenovo. You can also find Lenovo-authorized repair facilities by going to <https://support.lenovo.com/partnerlocator> for more information.

Disable the built-in battery

Before replacing any CRU, ensure that you disable the built-in battery.

To disable the built-in battery:

1. Restart your computer. When the logo screen is displayed, immediately press F1 to enter the UEFI BIOS menu.
2. Select **Config** → **Power**. The **Power** submenu is displayed.
3. Select **Disable Built-in Battery** and press Enter.
4. Select **Yes** in the Setup Confirmation window. The built-in battery is disabled and the computer turns off automatically. Wait three to five minutes to let the computer cool.

Replace a CRU

Follow the replacement procedure to replace a CRU.

Keyboard

Follow the instructions to replace the keyboard.

Before you start, read [Generic Safety and Compliance Notices](#).

For access, do the following:

1. Disable Fast Startup and the built-in battery. See “Disable the built-in battery” on page 32.
2. Turn off the computer and disconnect the computer from ac power and all connected cables.

Part location

- **ThinkPad T14 Gen 6 / ThinkPad P14s Gen 6 AMD**

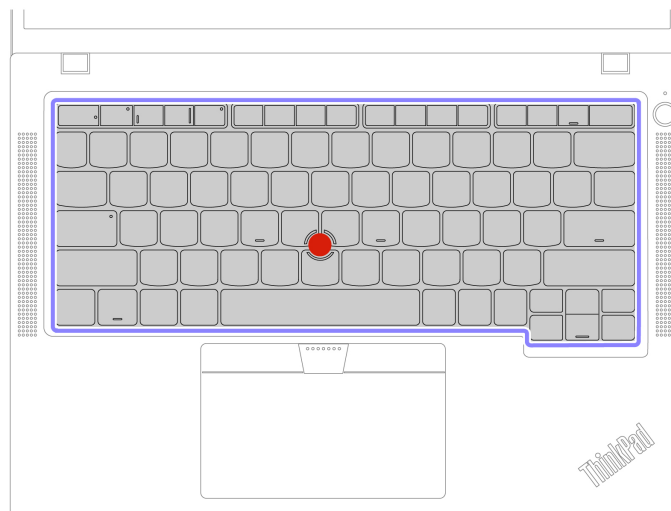

- **ThinkPad T16 Gen 4 / ThinkPad P16s Gen 4 AMD**

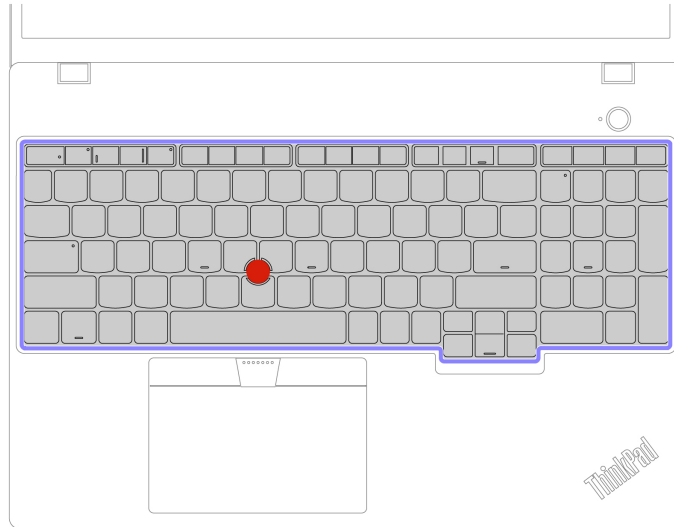

Remove the keyboard

Follow the instructions to remove the keyboard.

Note: You might be instructed to slide the keyboard frame forward or backward in some of the following steps. In this case, ensure that you do not press or hold the keys while sliding the keyboard frame. Otherwise, the keyboard frame cannot be moved.

Tools needed: Phillips head screwdriver

Step 1. Loosen the screws that secure the keyboard.

ThinkPad T14 Gen 6 / ThinkPad P14s Gen 6 AMD

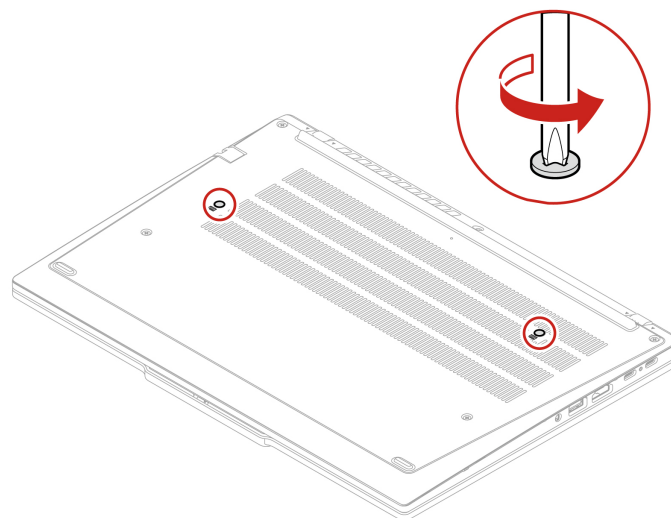

ThinkPad T16 Gen 4 / ThinkPad P16s Gen 4 AMD

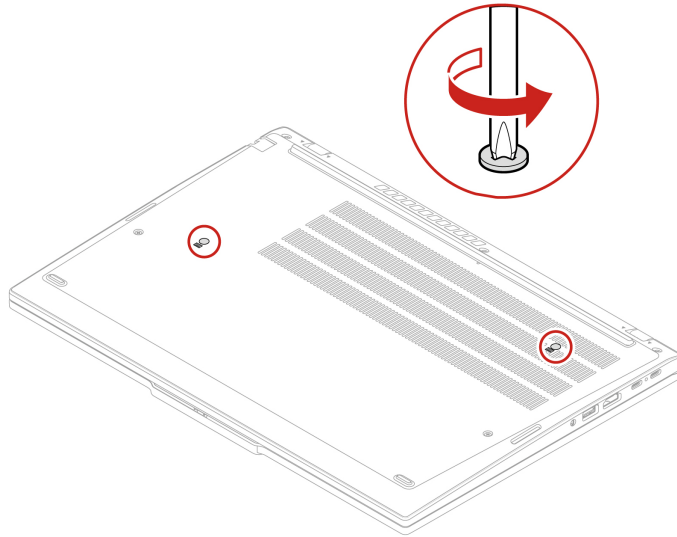

Step 2. Push the keyboard in the direction as shown by arrows to release the latches from the keyboard bezel.



Step 3. Pivot the keyboard slightly upward **1** and then turn over the keyboard **2**.

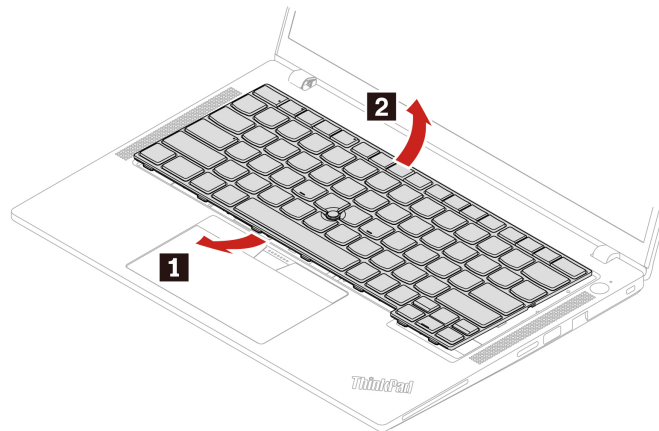

Step 4. Put the keyboard on the palm rest as shown and detach the connectors. Then, remove the keyboard.

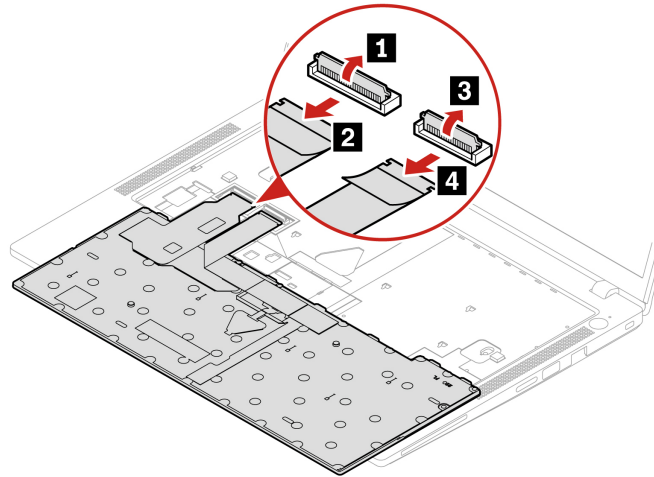

Install the keyboard

Follow the instructions to install the keyboard.

Note: You might be instructed to slide the keyboard frame forward or backward in some of the following steps. In this case, ensure that you do not press or hold the keys while sliding the keyboard frame. Otherwise, the keyboard frame cannot be moved.

Step 1. Attach the connectors and then turn over the keyboard.

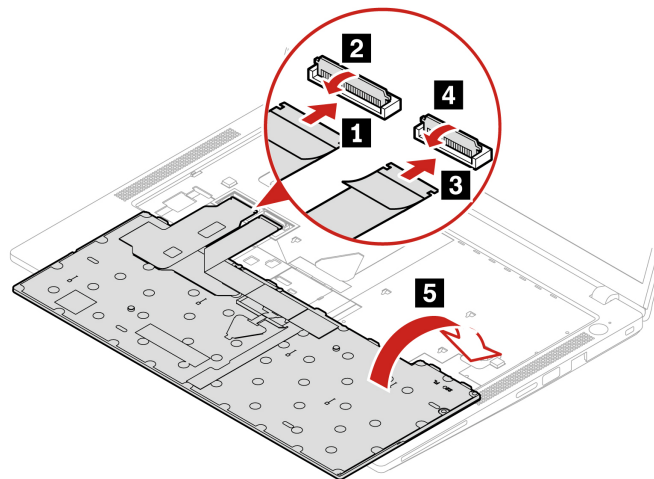

Step 2. Insert the keyboard into the keyboard bezel as shown. Ensure that the top edge of the keyboard (the edge that is close to the display) is under the keyboard bezel.

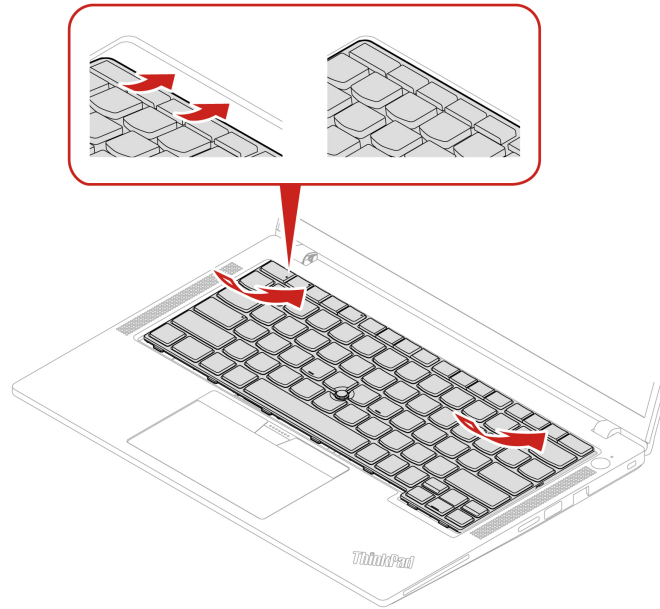

Step 3. Slide the keyboard in the direction as shown. Ensure that the latches are secured under the keyboard frame.

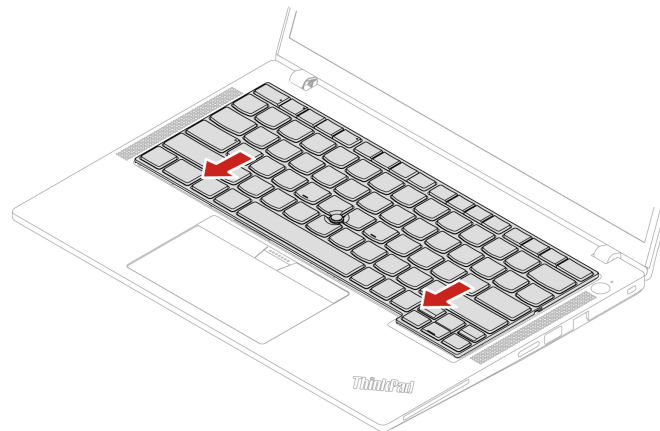

Step 4. Tighten the screws to secure the keyboard.
ThinkPad T14 Gen 6 / ThinkPad P14s Gen 6 AMD

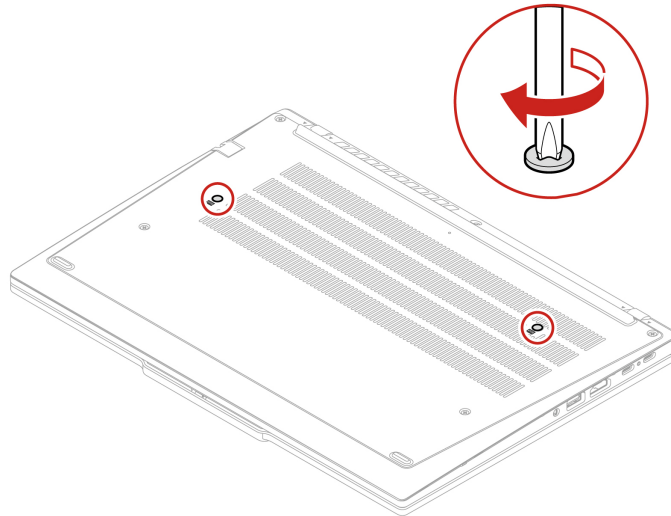

ThinkPad T16 Gen 4 / ThinkPad P16s Gen 4 AMD

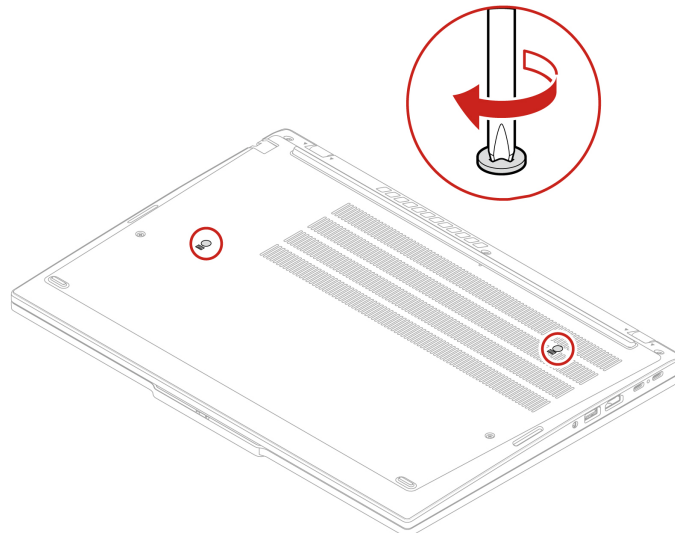

Step 5. Connect the ac power adapter and all disconnected cables to the computer.

Note: Configure the keyboard language in UEFI BIOS.

Base cover assembly

Follow the instructions to replace the base cover assembly.

Before you start, read [Generic Safety and Compliance Notices](#).

Note: Do not remove the base cover assembly when your computer is connected to ac power. Otherwise, there might be a risk of short circuits.

For access, do the following:

1. Disable Fast Startup and the built-in battery. See “Disable the built-in battery” on page 32.
2. Turn off the computer and disconnect the computer from ac power and all connected cables.

3. Remove the nano-SIM-card tray if your computer comes with one. See “Connect to a cellular network (for selected models)” on page 10.
4. Close the computer display and turn over the computer.

Part location

- **ThinkPad T14 Gen 6 / ThinkPad P14s Gen 6 AMD**

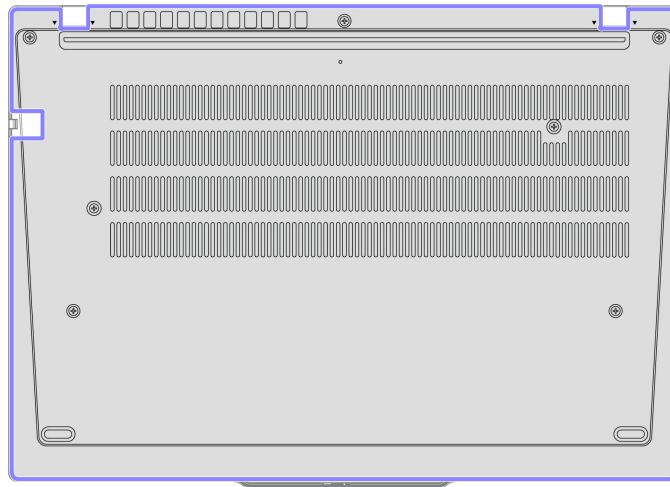

- **ThinkPad T16 Gen 4 / ThinkPad P16s Gen 4 AMD**

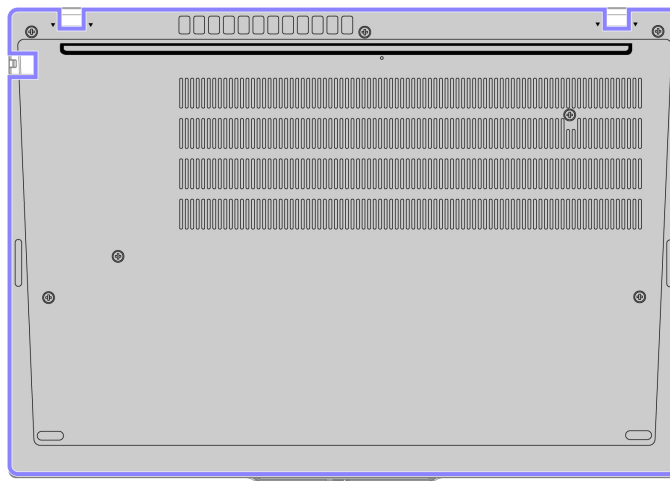

Tools needed: Phillips head screwdriver

Step 1. Remove the base cover assembly as shown below.

Note: Open the base cover assembly as shown with a pressure of less than 5 kg. Release the pressure immediately when the base cover hook is released.

ThinkPad T14 Gen 6 and ThinkPad P14s Gen 6 AMD

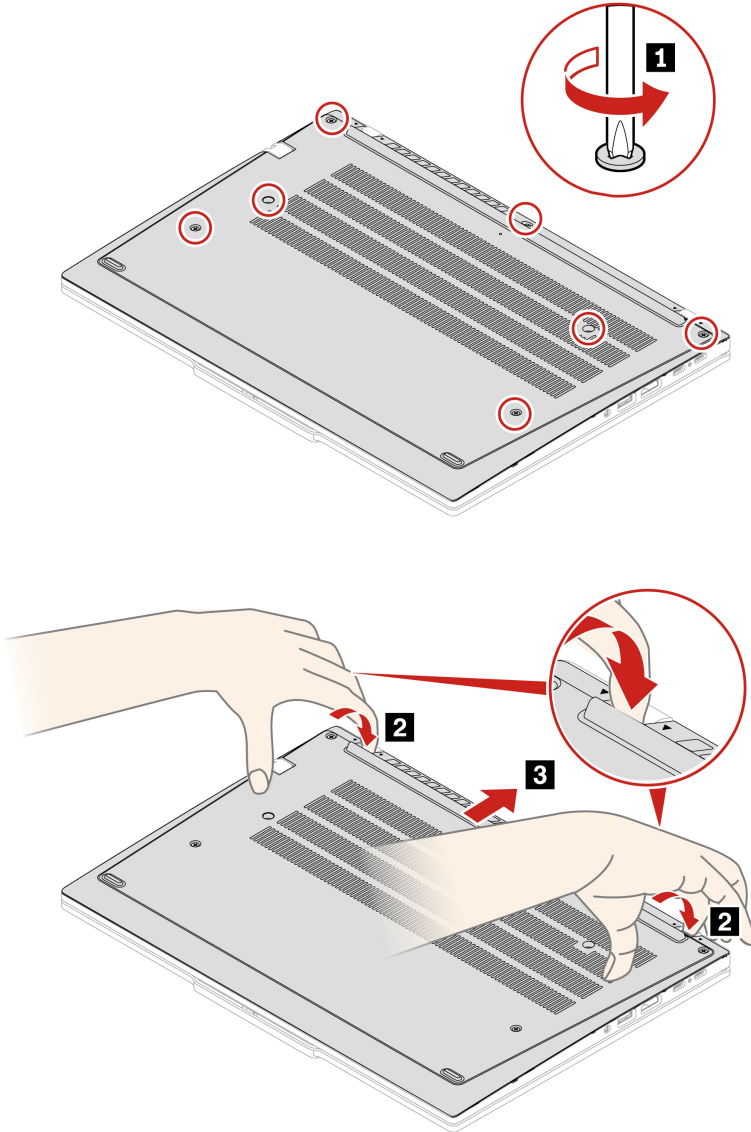

ThinkPad T16 Gen 4 / ThinkPad P16s Gen 4 AMD

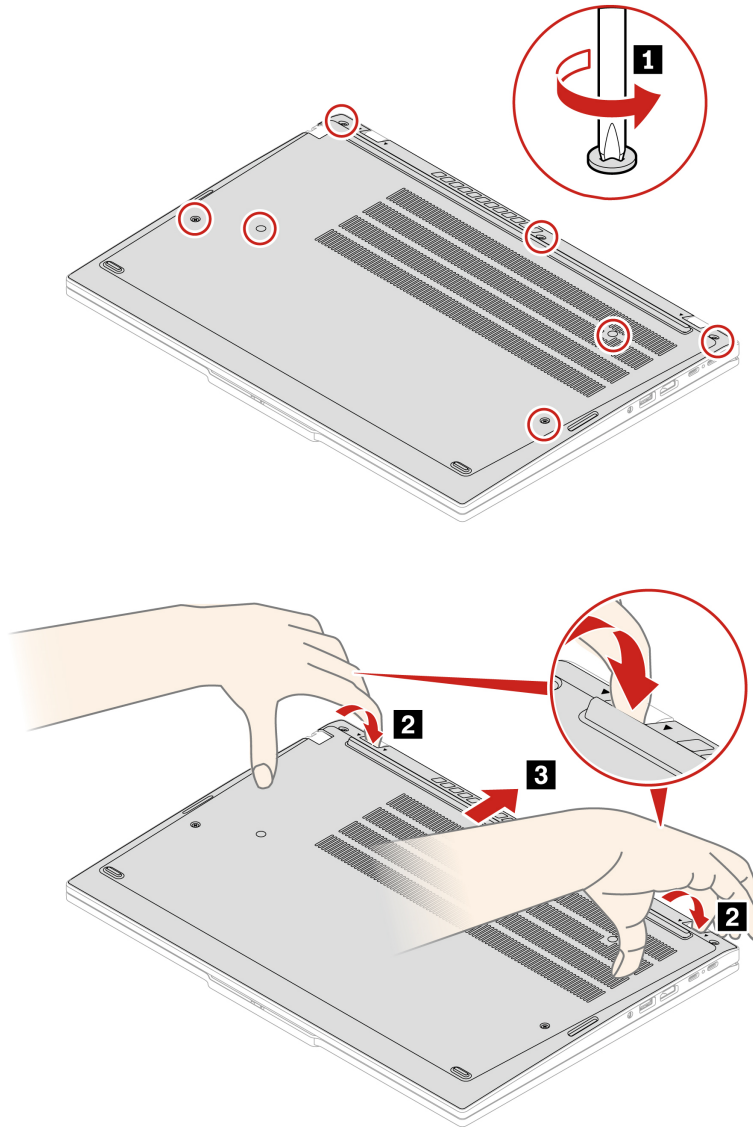

Step 2. Install the base cover assembly as shown below.
ThinkPad T14 Gen 6 / ThinkPad P14s Gen 6 AMD

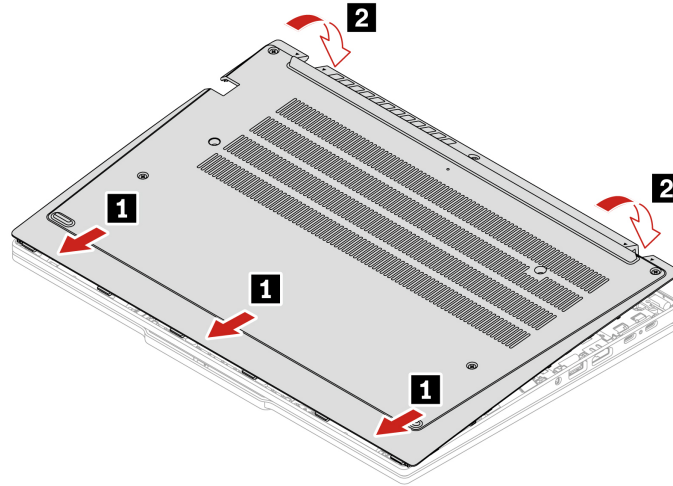

Reinstall the screws in alphabetic order (a to g).

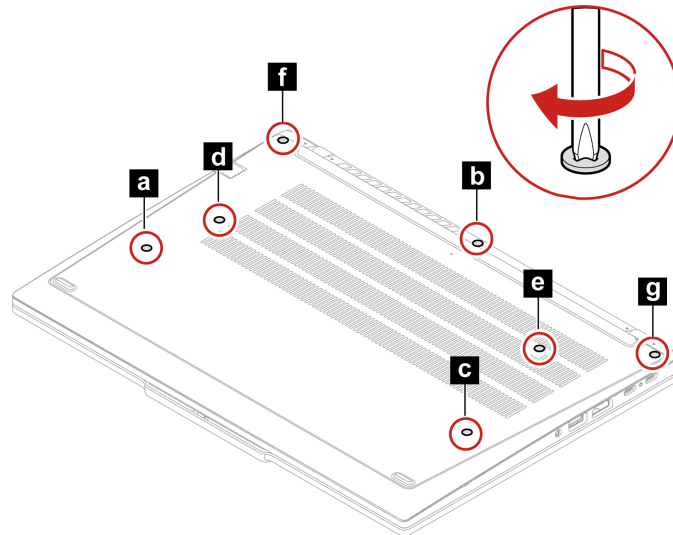

ThinkPad T16 Gen 4 / ThinkPad P16s Gen 4 AMD

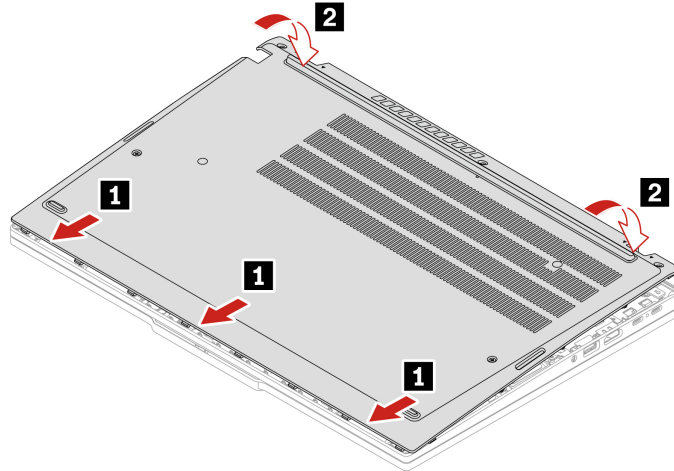

Reinstall the screws in alphabetic order (a to g).

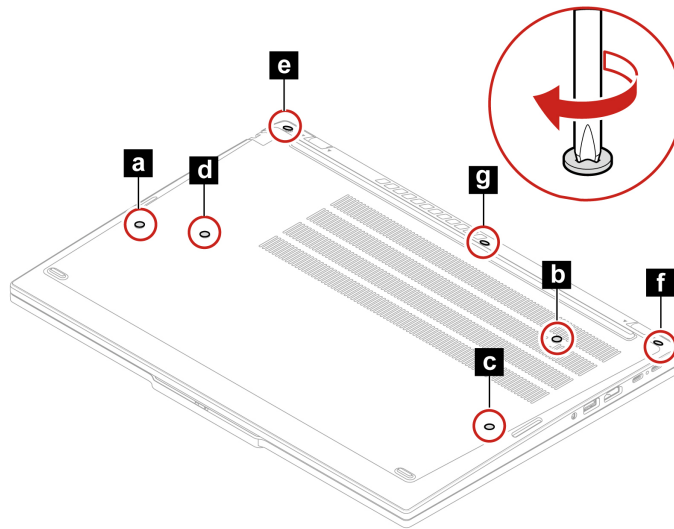

If the computer does not start up after you reinstall the base cover assembly, disconnect the ac power adapter and then reconnect it to the computer.

Memory module shielding cap (for selected models)

Follow the instructions to replace the memory module shielding cap.

Before you start, read [Generic Safety and Compliance Notices](#).

Attention: Do not touch the contact edge of the memory module. Otherwise, the memory module might get damaged.

For access, do the following:

1. Disable Fast Startup and the built-in battery. See “Disable the built-in battery” on page 32.
2. Turn off the computer and disconnect the computer from ac power and all connected cables.
3. Close the computer display and turn over the computer.

4. Remove the base cover assembly. See “Base cover assembly” on page 37.

Part location

- **ThinkPad T14 Gen 6 / ThinkPad P14s Gen 6 AMD**

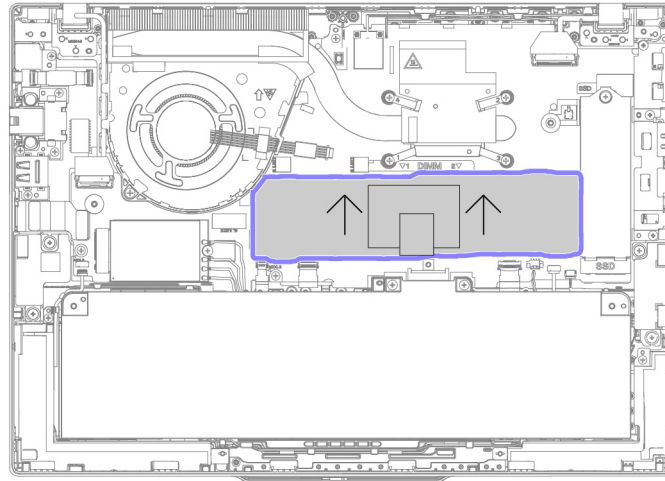

- **ThinkPad T16 Gen 4 / ThinkPad P16s Gen 4 AMD**

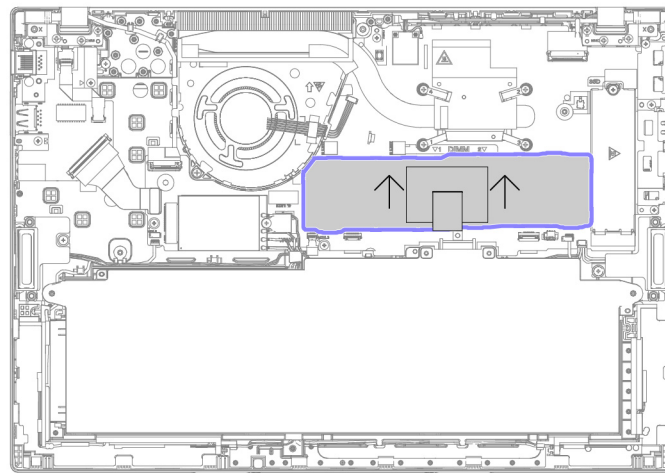

Step 1. Remove the memory module shielding cap as shown below.
ThinkPad T14 Gen 6 / ThinkPad P14s Gen 6 AMD

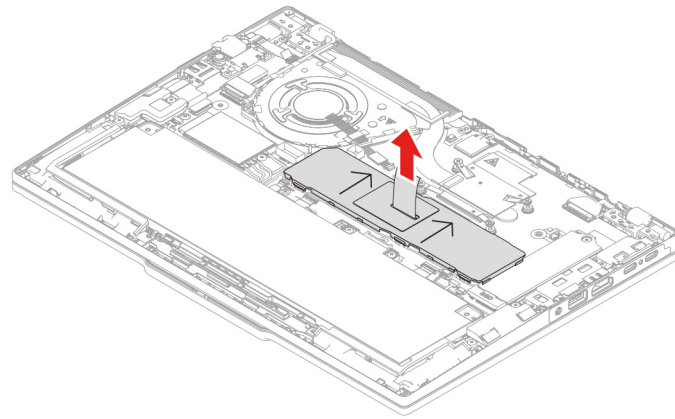

ThinkPad T16 Gen 4 / ThinkPad P16s Gen 4 AMD

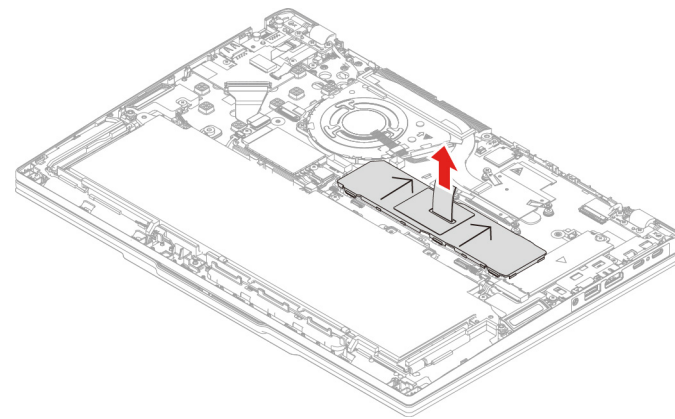

Step 2. Install the memory module shielding cap as shown below.

Note: Ensure that the arrows on the memory module shielding cap point upwards to the direction of the thermal fan assembly. Otherwise, the memory module shielding cap cannot be installed correctly.

ThinkPad T14 Gen 6 / ThinkPad P14s Gen 6 AMD

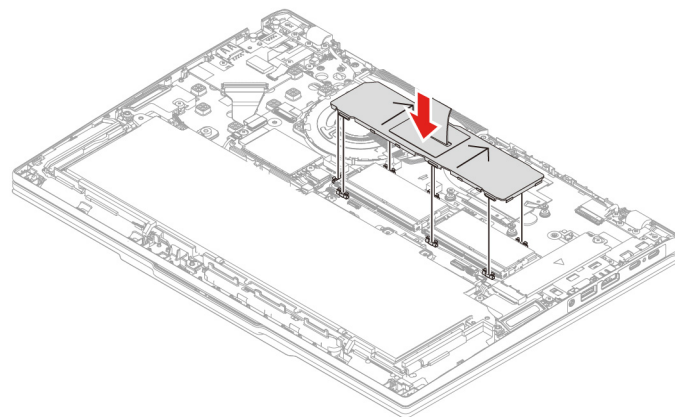

ThinkPad T16 Gen 4 / ThinkPad P16s Gen 4 AMD

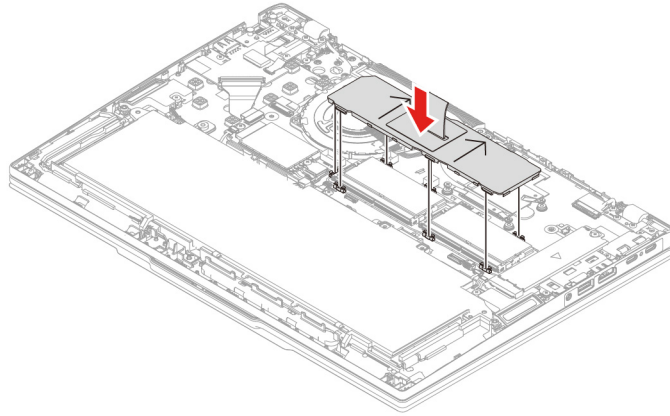

Memory module (for selected models)

Follow the instructions to replace the memory module.

Before you start, read [Generic Safety and Compliance Notices](#).

Attention: Do not touch the contact edge of the memory module. Otherwise, the memory module might get damaged.

For access, do the following:

1. Disable Fast Startup and the built-in battery. See “Disable the built-in battery” on page 32.
2. Turn off the computer and disconnect the computer from ac power and all connected cables.
3. Close the computer display and turn over the computer.
4. Remove the base cover assembly. See “Base cover assembly” on page 37.
5. Remove the memory module shielding cap. See “Memory module shielding cap (for selected models)” on page 42.

Note: Ensure that you follow the installation order for memory modules shown in the following table.

Memory modules	Installation order
one	Slot 1
two	Slot 1 and slot 2

Part location

- ThinkPad T14 Gen 6 / ThinkPad P14s Gen 6 AMD

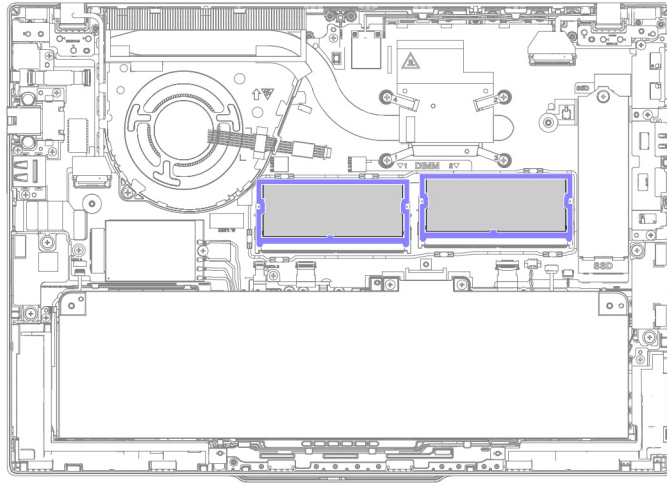

- **ThinkPad T16 Gen 4 / ThinkPad P16s Gen 4 AMD**

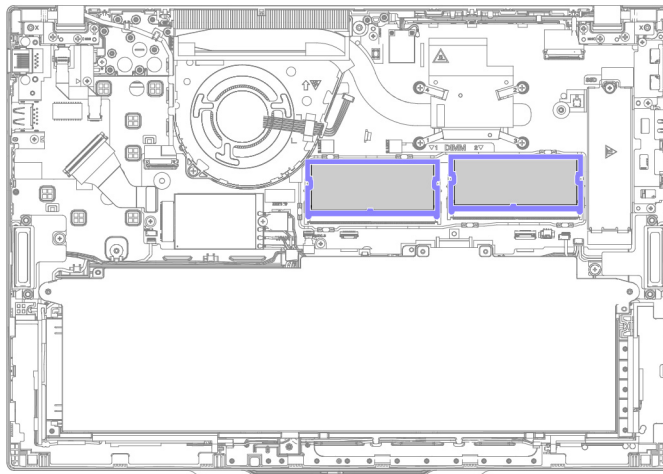

- Step 1. Remove the memory module as shown below.
ThinkPad T14 Gen 6 / ThinkPad P14s Gen 6 AMD

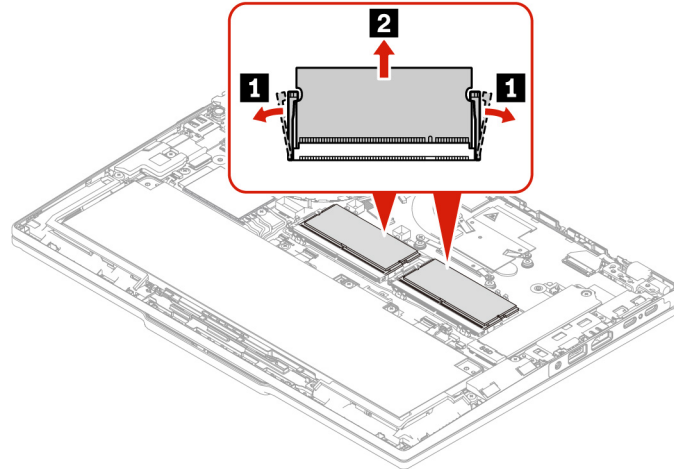

ThinkPad T16 Gen 4 / ThinkPad P16s Gen 4 AMD

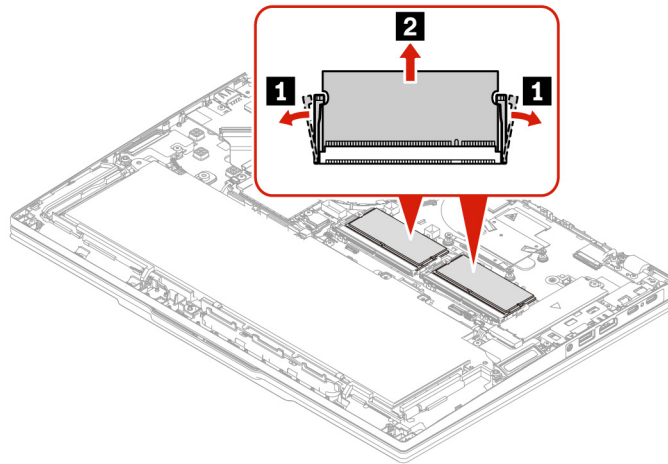

Step 2. Install the memory module as shown below.

ThinkPad T14 Gen 6 / ThinkPad P14s Gen 6 AMD

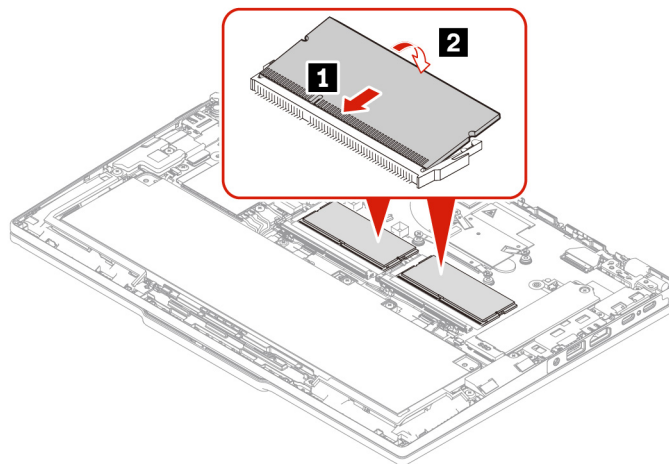

ThinkPad T16 Gen 4 / ThinkPad P16s Gen 4 AMD

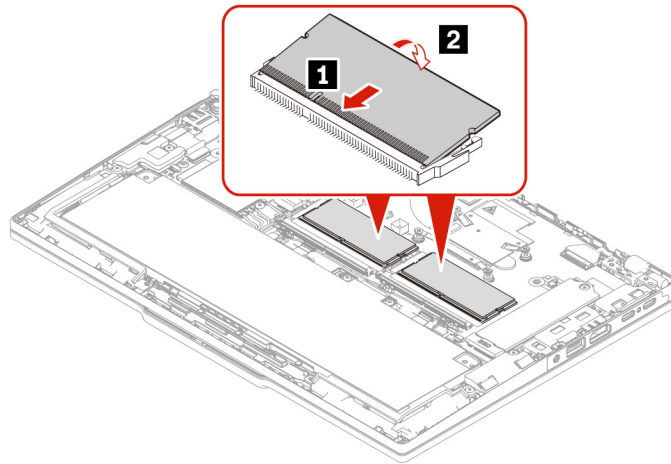

Wireless WAN module and Wireless WAN module bracket (for selected 4G models)

Follow the instructions to replace the Wireless WAN module and Wireless WAN module bracket.

The following information is only for the computer with user-installable modules. Ensure that you use only a Lenovo-authorized wireless module specifically tested for this computer model. Otherwise, the computer will generate an error-code beep sequence when you turn on the computer.

Notes:

- Wireless WAN ready model identifies that product has preinstalled wireless WAN antennas and allows a user-installable wireless WAN module.
- Only wireless WAN model or wireless WAN ready model is allowed to install the optional Lenovo wireless WAN module.

Before you start, read [Generic Safety and Compliance Notices](#).

Attention: Do not touch the contact edge of the wireless WAN module. Otherwise, the wireless WAN module might get damaged.

For access, do the following:

1. Disable Fast Startup and the built-in battery. See “Disable the built-in battery” on page 32.
2. Turn off the computer and disconnect the computer from ac power and all connected cables.
3. Close the computer display and turn over the computer.
4. Remove the base cover assembly. See “Base cover assembly” on page 37.

Part location

- **ThinkPad T14 Gen 6 / ThinkPad P14s Gen 6 AMD**

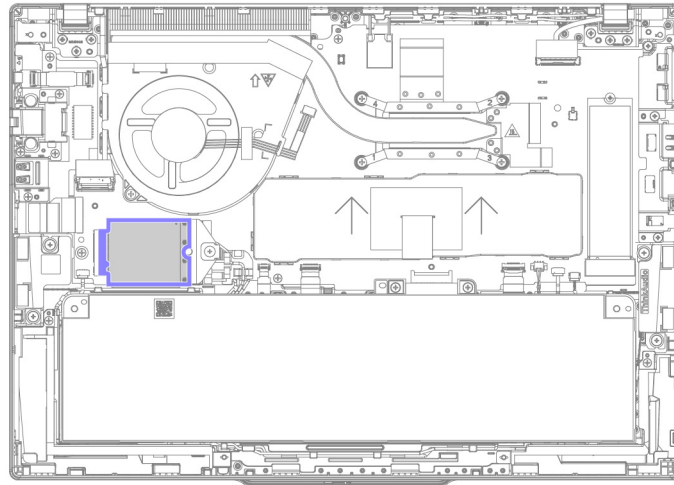

- **ThinkPad T16 Gen 4 / ThinkPad P16s Gen 4 AMD**

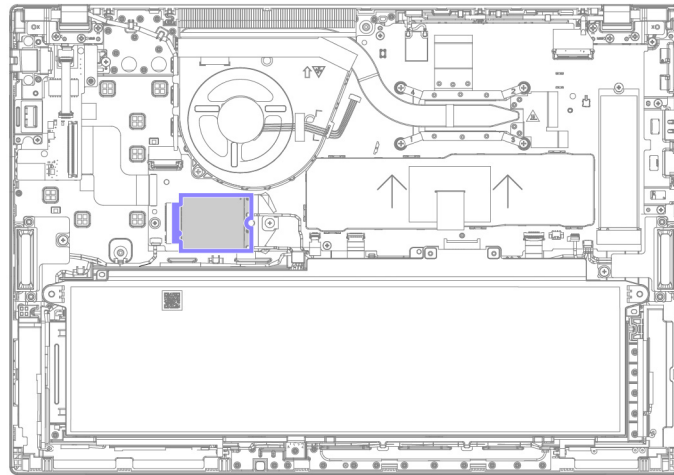

Tools needed: Phillips head screwdriver

- Step 1. Remove the wireless WAN module and its bracket as shown below.
ThinkPad T14 Gen 6 / ThinkPad P14s Gen 6 AMD

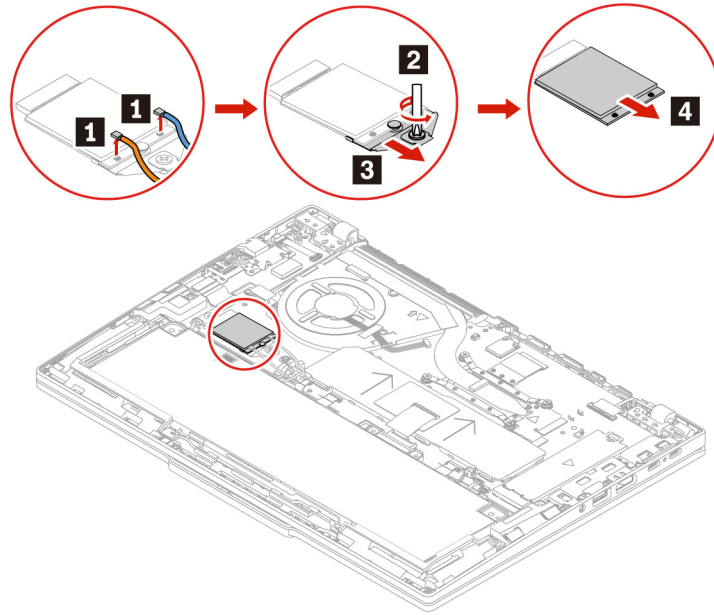

Figure 1. 4G models

ThinkPad T16 Gen 4 / ThinkPad P16s Gen 4 AMD

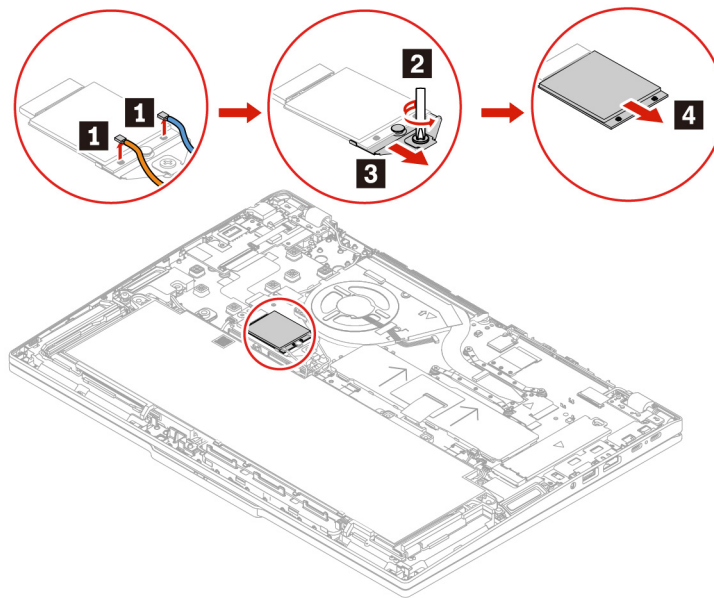

Figure 2. 4G models

Step 2. Install the wireless WAN module and its bracket in reverse order.

Ensure that the antenna cables are installed appropriately:

- The blue cable is connected to the connector labeled Blue on the module.
- The orange cable is connected to the connector labeled Orange on the module.

Wireless WAN module and Wireless WAN module bracket (for selected 5G models)

Follow the instructions to replace the Wireless WAN module and Wireless WAN module bracket.

The following information is only for the computer with user-installable modules. Ensure that you use only a Lenovo-authorized wireless module specifically tested for this computer model. Otherwise, the computer will generate an error-code beep sequence when you turn on the computer.

Notes:

- Wireless WAN ready model identifies that product has preinstalled wireless WAN antennas and allows a user-installable wireless WAN module.
- Only wireless WAN model or wireless WAN ready model is allowed to install the optional Lenovo wireless WAN module.

Before you start, read [Generic Safety and Compliance Notices](#).

Attention: Do not touch the contact edge of the wireless WAN module. Otherwise, the wireless WAN module might get damaged.

For access, do the following:

1. Disable Fast Startup and the built-in battery. See “Disable the built-in battery” on page 32.
2. Turn off the computer and disconnect the computer from ac power and all connected cables.
3. Close the computer display and turn over the computer.
4. Remove the base cover assembly. See “Base cover assembly” on page 37.

Part location

- **ThinkPad T14 Gen 6 / ThinkPad P14s Gen 6 AMD**

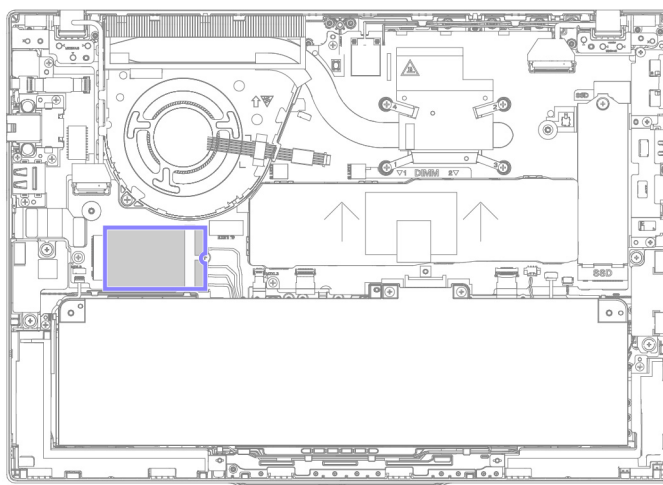

- **ThinkPad T16 Gen 4 / ThinkPad P16s Gen 4 AMD**

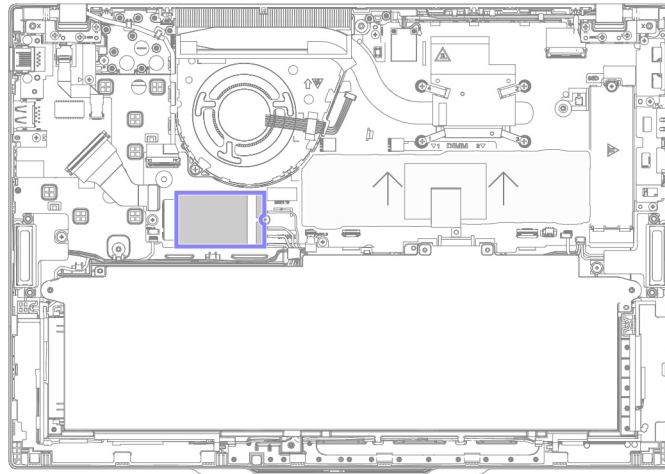

Tools needed: Phillips head screwdriver

Step 1. Remove the wireless WAN module and its bracket as shown below.
ThinkPad T14 Gen 6 / ThinkPad P14s Gen 6 AMD

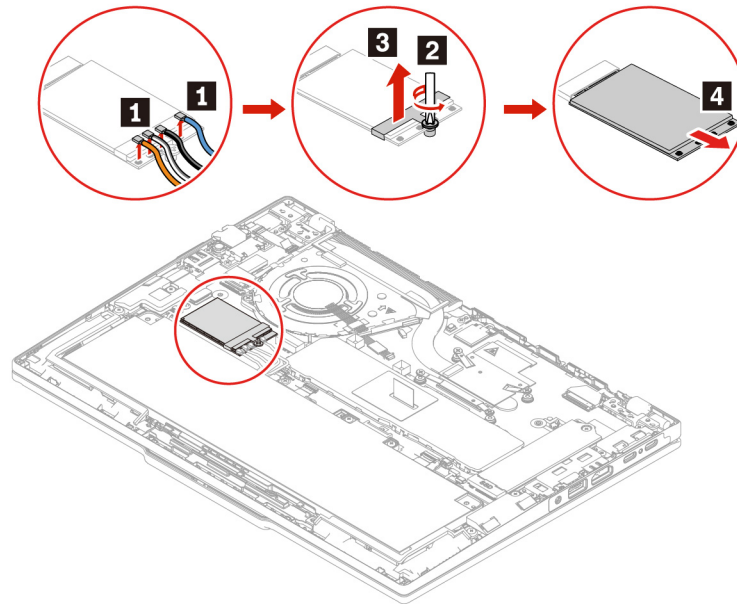

Figure 3. 5G models

ThinkPad T16 Gen 4 / ThinkPad P16s Gen 4 AMD

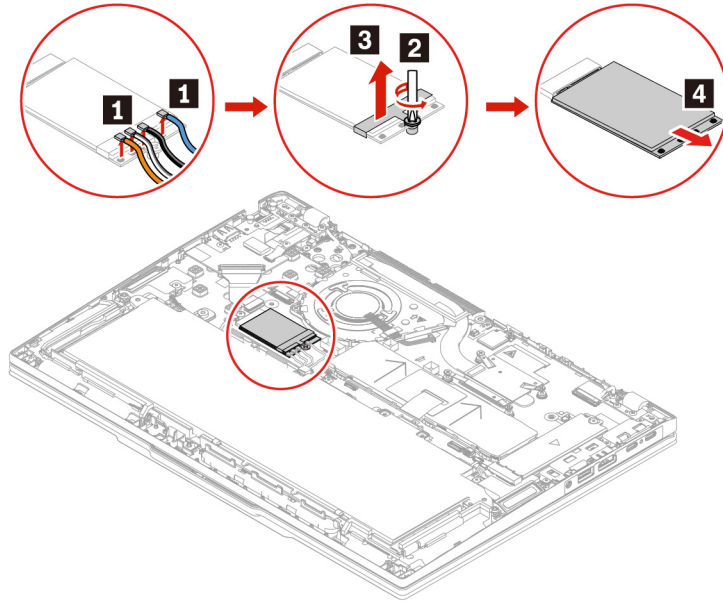

Figure 4. 5G models

Step 2. Install the wireless WAN module and its bracket in reverse order.

Ensure that the antenna cables are installed appropriately:

- The blue cable is connected to the connector labeled Blue on the module.
- The black and grey cable is connected to the connector labeled Black Grey on the module.
- The white and grey cable is connected to the connector labeled White Grey on the module.
- The orange cable is connected to the connector labeled Orange on the module.

M.2 solid-state drive and M.2 solid-state drive bracket

Follow the instructions to replace the M.2 solid-state drive and M.2 solid-state drive bracket.

Before you start, read [Generic Safety and Compliance Notices](#).

Attention: The M.2 solid-state drive is sensitive. Inappropriate handling might cause damage and permanent loss of data.

When handling the M.2 solid-state drive, observe the following guidelines:

- Replace the M.2 solid-state drive only for repair. The M.2 solid-state drive is not designed for frequent changes or replacement.
- Before replacing the M.2 solid-state drive, make a backup copy of all the data that you want to keep.
- Do not apply pressure to the M.2 solid-state drive.
- Do not touch the contact edge or circuit board of the M.2 solid-state drive. Otherwise, the M.2 solid-state drive might get damaged.
- Do not subject the M.2 solid-state drive to physical shocks or vibration. Put the M.2 solid-state drive on a soft material, such as cloth, to absorb physical shocks.

For access, do the following:

1. Disable Fast Startup and the built-in battery. See “Disable the built-in battery” on page 32.

2. Turn off the computer and disconnect the computer from ac power and all connected cables.
3. Close the computer display and turn over the computer.
4. Remove the base cover assembly. See “Base cover assembly” on page 37.

Part location

- **ThinkPad T14 Gen 6 / ThinkPad P14s Gen 6 AMD**

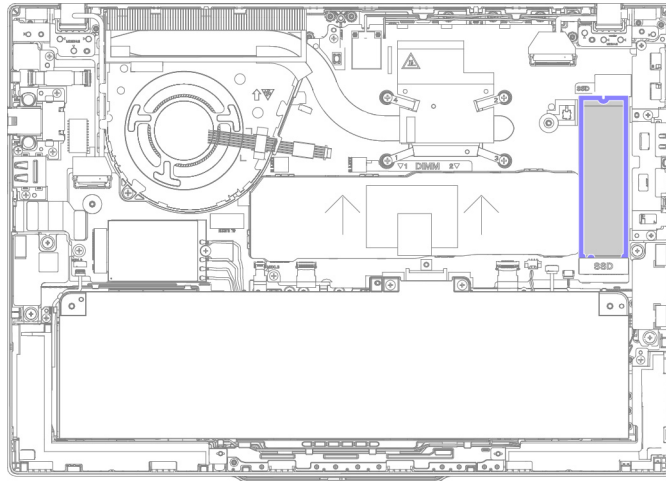

- **ThinkPad T16 Gen 4 / ThinkPad P16s Gen 4 AMD**

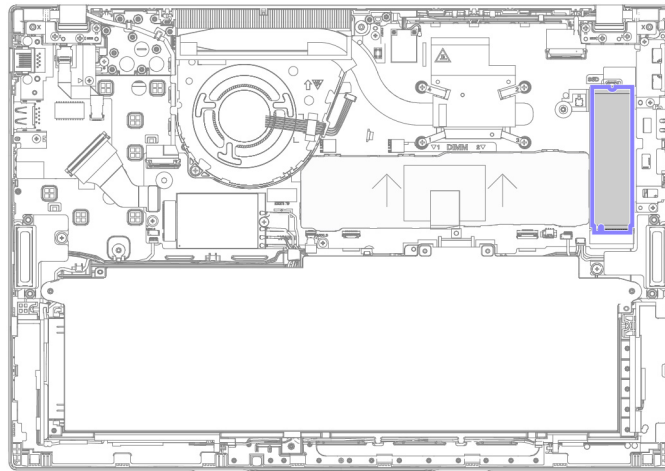

Tools needed: Phillips head screwdriver

- Step 1. Remove the M.2 solid-state drive and its bracket as shown below.
Type 1: ThinkPad T14 Gen 6 / ThinkPad P14s Gen 6 AMD

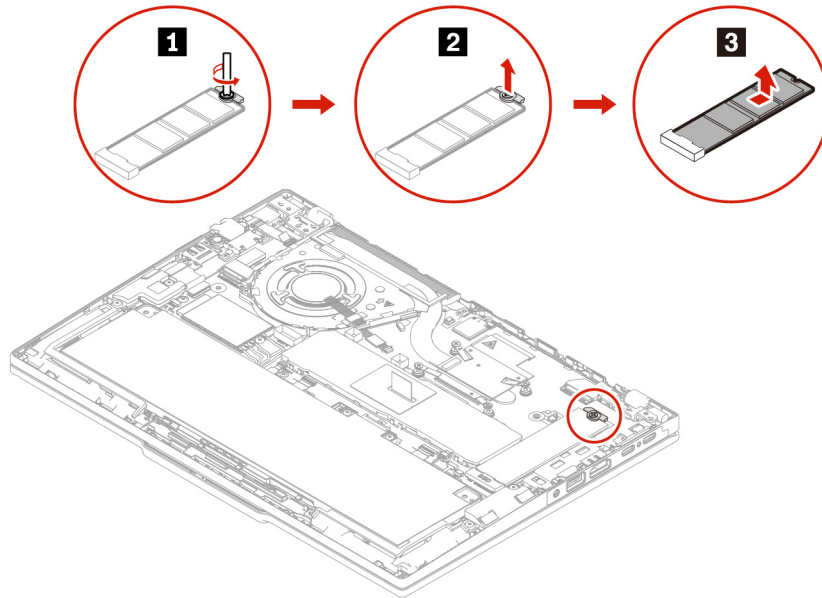

Type 1: ThinkPad T16 Gen 4 / ThinkPad P16s Gen 4 AMD

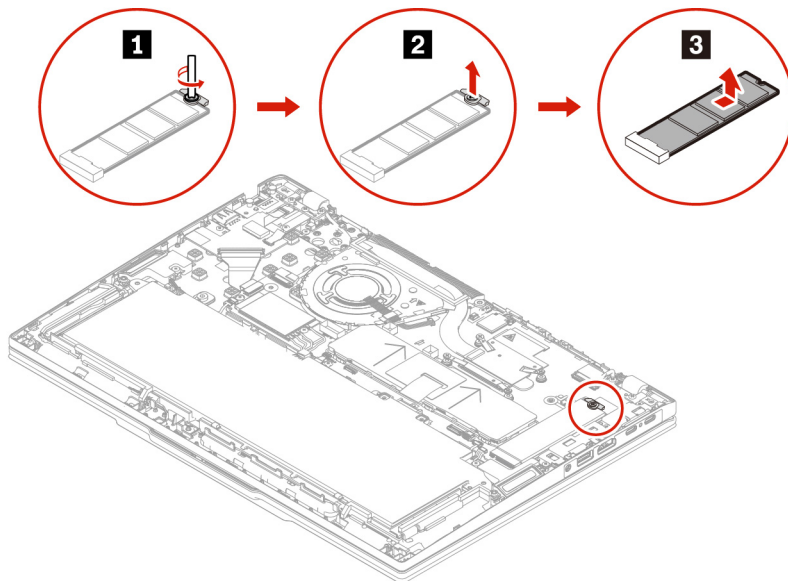

Type 2: ThinkPad T14 Gen 6 / ThinkPad P14s Gen 6 AMD

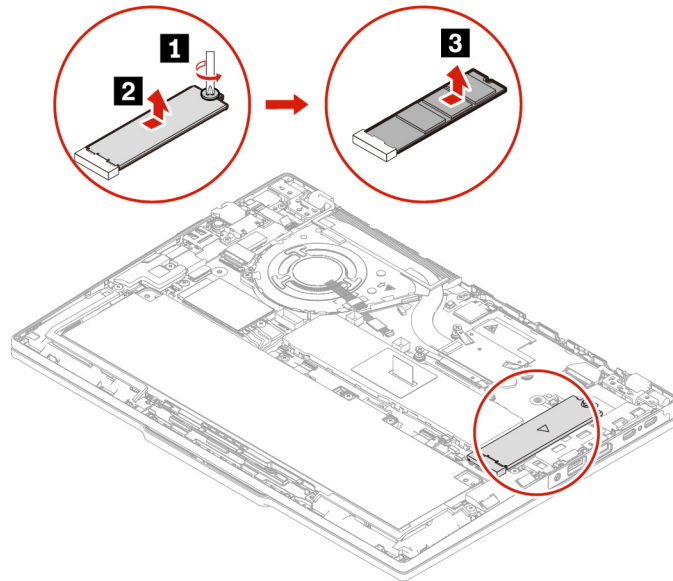

Type 2: ThinkPad T16 Gen 4 / ThinkPad P16s Gen 4 AMD

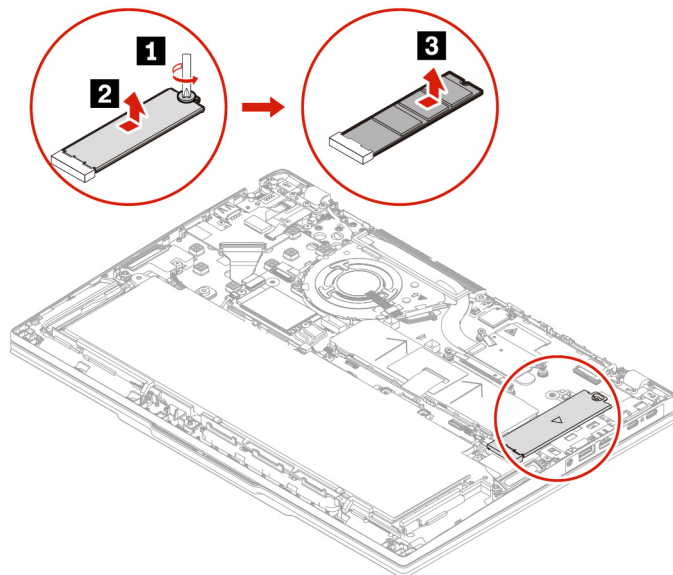

Step 2. Install the M.2 solid-state drive and its bracket in reverse order.

Note: Ensure the adhesive side of the thermal pad is attached on the system board if a single-side adhesive thermal pad is in use with the M.2 solid-state drive.

Built-in battery

Follow the instructions to replace the built-in battery.

Before you start, read [Generic Safety and Compliance Notices](#).

CAUTION:

Use only the Lenovo-authorized battery specified for the computer. Any other battery could ignite or explode.

Batteries supplied by Lenovo for use with your product have been tested for compatibility and should only be replaced with approved parts. A battery other than the one specified by Lenovo, or a disassembled or modified battery may not be covered by warranty.

Battery abuse or mishandling can cause overheating, liquid leakage, or an explosion. To avoid possible injury:

- **Do not open, disassemble or service any battery unless you are competent to do so and ensure that you carefully follow all instructions provided by Lenovo.**
- **Do not crush or puncture the battery.**
- **Do not short-circuit the battery, or expose it to water or other liquids.**
- **Keep the battery away from children.**
- **Keep the battery away from fire.**
- **Stop using the battery if it is damaged, or if you notice any discharge or the buildup of foreign materials on the battery leads.**
- **Store the rechargeable batteries or products containing the rechargeable batteries at room temperature, charged to approximately 30 to 50% of capacity. We recommend that the batteries be charged about once per year to prevent overdischarge.**
- **Do not put the battery in trash that is disposed of in landfills. When disposing of the battery, comply with local ordinances or regulations.**
- **If the battery is incorrectly replaced, there is danger of an explosion. The battery contains a small amount of harmful substances.**

Lenovo recommends you use a qualified repair technician or ensure that you carefully follow all instructions provided by Lenovo. The Lenovo-authorized repair facilities or technicians recycle Lenovo batteries according to local laws and regulations. Please do not dispose of your battery with your household waste. For recycling information go to <https://www.lenovo.com/recycling>.

Attention: Lenovo has no responsibility for the performance or safety of unauthorized batteries, and provides no warranties for failures or damage arising out of their use.

The Vantage app provides an automatic battery diagnostic test that determines if the built-in battery is defective. A built-in battery should not be replaced unless this diagnostic test shows that the battery is defective. The only exception to this is if the built-in battery is physically damaged or a customer is reporting a possible safety issue.

If the Vantage app is not installed on the computer, the customer should download and install the program to diagnose the built-in battery, before replacing a non-physically damaged built-in battery. Note that the replacement of a physically damaged built-in battery is not covered by the warranty.

For access, do the following:

1. Disable Fast Startup and the built-in battery. See “Disable the built-in battery” on page 32.
2. Turn off the computer and disconnect the computer from ac power and all connected cables.
3. Close the computer display and turn over the computer.
4. Remove the base cover assembly. See “Base cover assembly” on page 37.

Part location

Note: You can scan the QR code on the built-in battery to view the battery replacement video.

- **ThinkPad T14 Gen 6 / ThinkPad P14s Gen 6 AMD**

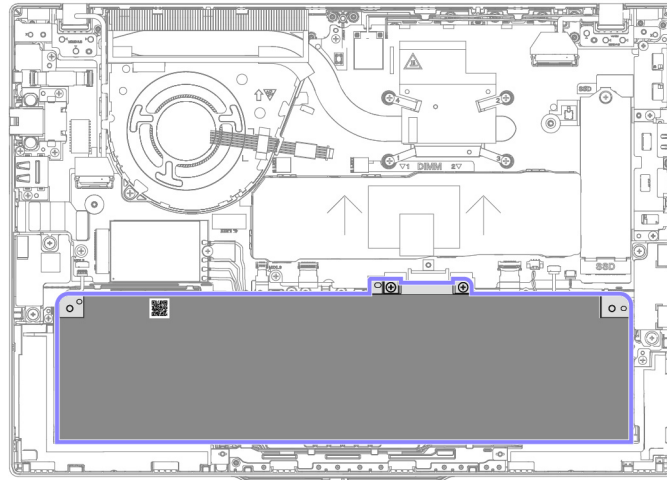

- **ThinkPad T16 Gen 4 / ThinkPad P16s Gen 4 AMD**

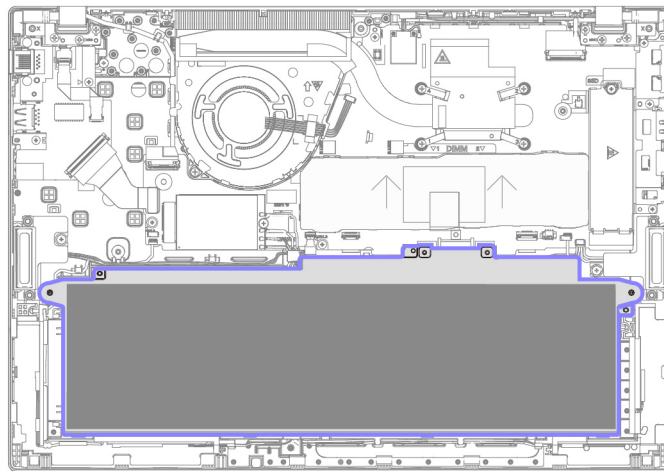

Tools needed: Phillips head screwdriver

- Step 1. Remove the built-in battery as shown below.
ThinkPad T14 Gen 6 / ThinkPad P14s Gen 6 AMD

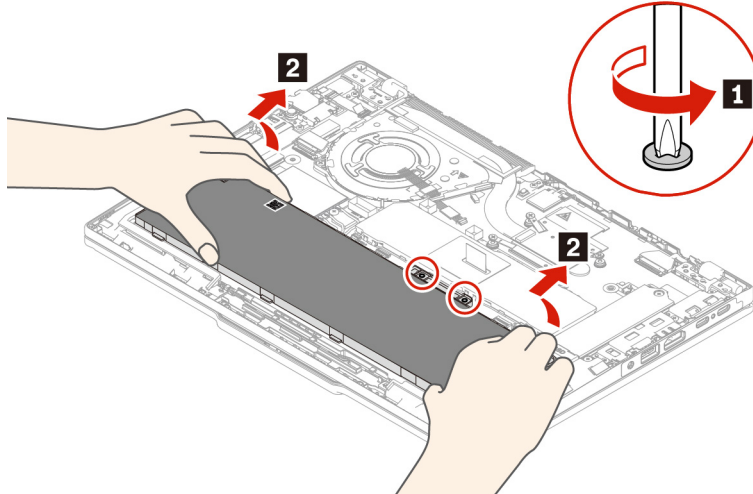

ThinkPad T16 Gen 4 / ThinkPad P16s Gen 4 AMD

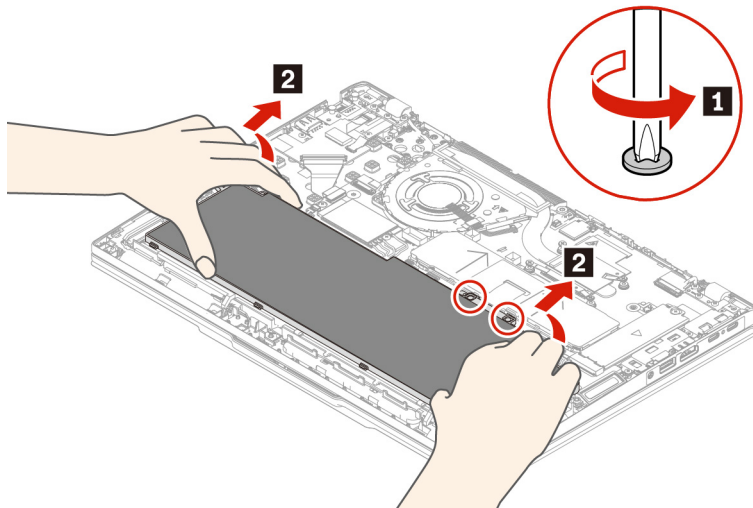

Step 2. Install the built-in battery in reverse order.

CAUTION:
Remove any foreign objects before reassembly.

Ensure that the base cover assembly is secured in place. Otherwise, the battery connection might fail.

Chapter 7. Help and support

Frequently asked questions

Question	Solution
How do I access Settings ?	Open the system menu drop down (top right) and click Settings .
How do I turn off my computer?	From the system menu (top right) click  , and then click Power Off .
What do I do if my computer stops responding.	<ol style="list-style-type: none">1. Press and hold the power button until the computer turns off. Then, restart the computer.2. If step 1 does not work:<ul style="list-style-type: none">• For models with an emergency reset hole: Insert a straightened paper clip into the emergency reset hole to cut off power supply temporarily. Then, restart the computer with ac power connected.• For models without an emergency reset hole:<ul style="list-style-type: none">– For models with the removable battery, remove the removable battery and disconnect all power sources. Then, reconnect to ac power and restart the computer.– For models with the built-in battery, disconnect all power sources. Press and hold the power button for about seven seconds. Then, reconnect to ac power and restart the computer.
What do I do if I spill liquid on the computer?	<ol style="list-style-type: none">1. Carefully unplug the ac power adapter and turn off the computer immediately. The more quickly you stop the current from passing through the computer the more likely you will reduce damage from short circuits. Attention: Although you might lose some data or work by turning off the computer immediately, leaving the computer on might make your computer unusable.2. Do not try to drain out the liquid by turning over the computer. If your computer has keyboard drainage holes on the bottom, the liquid will be drained out through the holes.3. Wait until you are certain that all the liquid is dry before turning on your computer.
How do I enter the UEFI BIOS menu?	Restart the computer. When the logo screen is displayed, press F1 to enter the UEFI BIOS menu.
How do I disable my Trackpad?	<ol style="list-style-type: none">1. Open the system menu, and then click Settings → Mouse & Touchpad.2. In the Touchpad section, turn off the Touchpad control.
Where can I get the latest device drivers and UEFI BIOS?	Use the Software application to check for updates. It should notify when new firmware is available on LVFS (https://fwupd.org/).

Error messages

If you see a message that is not included in the following table, record the error message first, then shut down the computer and call Lenovo for help. See “Lenovo Customer Support Center” on page 66.

Message	Solution
0190: Critical low-battery error	The computer turned off because the battery power is low. Connect the ac power adapter to the computer and charge the batteries.
0191: System Security - Invalid remote change requested	The system configuration change has failed. Confirm the operation and try again.
0199: System Security - Security password retry count exceeded.	This message is displayed when you enter a wrong supervisor password more than three times. Confirm the supervisor password and try again.
0271: Check Date and Time settings.	The date or the time is not set in the computer. Enter the UEFI BIOS menu and set the date and time.
1802: Unauthorized network card is plugged in - Power off and remove the network card.	The wireless network card is not supported on this computer. Replace with a supported wireless network card.
210x/211x: Detection/Read error on HDDx/SSDx	The storage drive is not working. Reinstall the storage drive. If the problem still exists, replace the storage drive.
2202: Brand Name is invalid.	Have the computer serviced.

Note:

This error indicates that the operating system or programs cannot create, modify, or delete data in the non-volatile system UEFI variable storage due to insufficient storage space after POST.

The non-volatile system UEFI variable storage is used by the UEFI BIOS and by the operating system or programs. This error occurs when the operating system or programs store large amounts of data in the variable storage. All data needed for POST, such as UEFI BIOS setup settings, chipset, or platform configuration data, are stored in a separate UEFI variable storage.

Press F1 after the error message is displayed to enter the UEFI BIOS menu. A dialog asks for confirmation to clean up the storage. If you select “Yes”, all data that were created by the operating system or programs will be deleted except global variables defined by the Unified Extensible Firmware Interface Specification. If you select “No”, all data will be kept, but the operating system or programs will not be able to create, modify, or delete data in the storage.

If this error happens at a service center, Lenovo authorized service personnel will clean up the non-volatile system UEFI variable storage using the preceding solution.

Error: The non-volatile system UEFI variable storage is nearly full.

Beep errors

Lenovo SmartBeep technology enables you to decode beep errors with your smartphone when a black screen occurs with beeps from your computer. To decode the beep error with Lenovo SmartBeep technology:

1. Go to <https://support.lenovo.com/smartbeep> or scan the following QR Code.



2. Download the proper diagnostic app and install it on your smartphone.
3. Run the diagnostic app and place the smartphone near the computer.
4. Press Fn on your computer to emit the beep again. The diagnostic app decodes the beep error and shows possible solutions on the smartphone.

Note: We recommend that you speak to our Customer Support Center before attempting to service the computer yourself so that you can be directed to the correct documentation and repair information. It might be recommended to have a Lenovo-authorized service provider repair your computer depending on the complexity of the error or fault.

Self-help resources

Use the following self-help resources to learn more about the computer and troubleshoot problems.

Access product documentation

- *Safety and Warranty Guide*
- *Setup Guide*
- *This User Guide*
- *Regulatory Notice*

Visit the Lenovo support Web site

<https://pcsupport.lenovo.com>

- Drivers and software
- Diagnostic solutions
- Product and service warranty
- Product and parts details
- Knowledge base and frequently asked questions

Access the Lenovo Limited Warranty

This product is covered by the terms of the Lenovo Limited Warranty (LLW), version L505-0010-02 08/2011. You can view the LLW in a number of languages from the following Web site. Read the Lenovo Limited Warranty at:

https://www.lenovo.com/warranty/llw_02

The LLW also is preinstalled on the computer. To access the LLW, go to /opt/Lenovo

If you cannot view the LLW either from the Web site or from your computer, contact your local Lenovo office or reseller to obtain a printed version of the LLW.

Access Linux distributions

Linux is an open-source operating system, and popular Linux distributions include Ubuntu and Fedora.

To learn more about the Ubuntu operating system, go to:

<https://www.ubuntu.com>

To learn more about the Fedora operating system, go to:

<https://getfedora.org/>

Get support information

If you need help, service, technical assistance, or more information about the Linux operating system or other applications, contact the provider of the Linux operating system or the provider of the application. If you need the service and support for hardware components shipped with your computer, contact Lenovo.

To access the latest *User Guide* and *Safety and Warranty Guide*, go to:

<https://pcsupport.lenovo.com>

Access open-source information

This device includes software made publicly available by Lenovo, including software licensed under the General Public License and/or the Lesser General Public License (the open source software).

You may obtain a copy of the corresponding source code for any such open source software licensed under the General Public License and/or the Lesser General Public License (or any other license requiring us to make a written offer to provide corresponding source code to you) from Lenovo for a period of three years without charge except for the cost of media, shipping, and handling, upon written request to Lenovo. This offer is valid to anyone in receipt of this Device.

You may send your request in writing to the address below accompanied by a check or money order for \$15 to:

*Lenovo Legal Department
Attn: Open Source Team / Source Code Requests
8001 Development Dr.
Morrisville, NC 27560*

Please include the version of the OS and the version of the Linux Kernel pre-shipped on this Device as part of your request. Be sure to provide a return address.

The open source software is distributed in hope it will be useful, but WITHOUT ANY WARRANTY; without even the implied warranty of MERCHANTABILITY or FITNESS FOR A PARTICULAR PURPOSE. See for example the GNU General Public License and/or the Lesser General Public License for more information.

To view additional information regarding licenses, acknowledgments and required copyright notices for the open source software shipped on your Device, go to `/usr/share/licences/*`.

Call Lenovo

If you have tried to correct the problem yourself and still need help, you can call Lenovo Customer Support Center.

Before you contact Lenovo

Prepare the following before you contact Lenovo:

1. Record the problem symptoms and details:
 - What is the problem? Is it continuous or intermittent?
 - Any error message or error code?
 - What operating system are you using? Which version?
 - Which software applications were running at the time of the problem?
 - Can the problem be reproduced? If so, how?
2. Record the system information:
 - Product name
 - Machine type and serial number

The following illustration shows where to find the machine type and serial number of your computer.

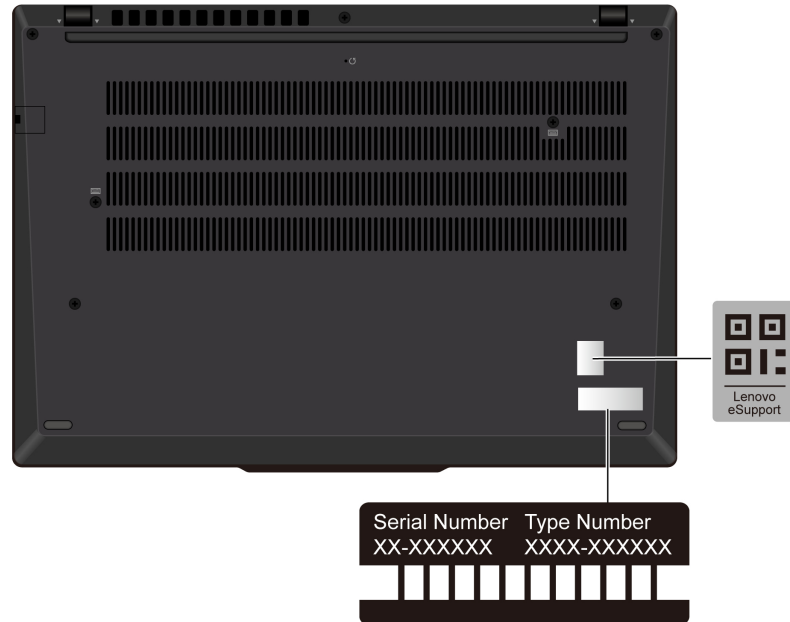

Lenovo Customer Support Center

During the warranty period, you can call Lenovo Customer Support Center for help.

Telephone numbers

For a list of the Lenovo Support phone numbers for your country or region, go to <https://pcsupport.lenovo.com/supportphonenumberlist> for the latest phone numbers.

Note: Phone numbers are subject to change without notice. If the number for your country or region is not provided, contact your Lenovo reseller or Lenovo marketing representative.

Services available during the warranty period

- Problem determination - Trained personnel are available to assist you with determining if you have a hardware problem and deciding what action is necessary to fix the problem.
- Lenovo hardware repair - If the problem is determined to be caused by Lenovo hardware under warranty, trained service personnel are available to provide the applicable level of service.
- Engineering change management - Occasionally, there might be changes that are required after a product has been sold. Lenovo or your reseller, if authorized by Lenovo, will make selected Engineering Changes (ECs) that apply to your hardware available.

Services not covered

- Replacement or use of parts not manufactured for or by Lenovo or nonwarranted parts
- Identification of software problem sources
- Configuration of UEFI BIOS as part of an installation or upgrade
- Changes, modifications, or upgrades to device drivers
- Installation and maintenance of network operating systems (NOS)
- Installation and maintenance of programs

For the terms and conditions of the Lenovo Limited Warranty that apply to your Lenovo hardware product, go to:

- https://www.lenovo.com/warranty/llw_02
- <https://pcsupport.lenovo.com/warrantylookup>

Purchase additional services

During and after the warranty period, you can purchase additional services from Lenovo at <https://pcsupport.lenovo.com/warrantyupgrade>.

Service availability and service name might vary by country or region.

Appendix A. Compliance information

For compliance information, refer to *Regulatory Notice* at <https://pcsupport.lenovo.com> and *Generic Safety and Compliance Notices* at https://pcsupport.lenovo.com/docs/generic_notices.

Certification-related information

This section provides certification-related information, such as product name and machine type.

Table 1. For Intel models

Product name	Compliance ID	Machine type(s)
<ul style="list-style-type: none"> ThinkPad T14 Gen 6 ThinkPad T14 Gen 6 5G⁰ ThinkPad T14 Gen 6 CAT4⁰ 	<ul style="list-style-type: none"> TP00159C TP00159D TP00159D0¹ TP00159D1² 	21QG, 21QH, 21QC, and 21QD
ThinkPad T16 Gen 4	<ul style="list-style-type: none"> TP00160B TP00160B0¹ TP00160B1² 	21QE and 21QF

Table 2. For AMD models

Product name	Compliance ID	Machine type(s)
<ul style="list-style-type: none"> ThinkPad T14 Gen 6 ThinkPad P14s Gen 6 AMD 	<ul style="list-style-type: none"> TP00159E TP00159E0¹ TP00159E1² 	<ul style="list-style-type: none"> 21QJ and 21QK 21QL, 21RV, 21QM, and 21RW
<ul style="list-style-type: none"> ThinkPad T16 Gen 4 ThinkPad P16s Gen 4 AMD 	<ul style="list-style-type: none"> TP00160C TP00160C0¹ TP00160C1² 	<ul style="list-style-type: none"> 21QN and 21QQ 21QR, 21RX, 21QS, and 21RY

⁰ for China mainland only

^{1 2} for India only

Further compliance information related to your product is available at <https://www.lenovo.com/compliance>.

Locate the UltraConnect wireless antennas

Your computer has an UltraConnect™ wireless antenna system. You can enable wireless communication wherever you are.

The following illustration shows the antenna locations on your computer:

ThinkPad T14 Gen 6 and ThinkPad P14s Gen 6 AMD (Black models)



ThinkPad T14 Gen 6 (Silver models)



- 1** Wireless LAN antenna (main)
- 2** Wireless LAN antenna (auxiliary)
- 3** Wireless WAN antenna (main, for selected models)
- 4** Wireless WAN antenna (MIMO1, for selected models)
- 5** Wireless WAN antenna (auxiliary, for selected models)
- 6** Wireless WAN antenna (MIMO2, for selected models)

ThinkPad T16 Gen 4 and ThinkPad P16s Gen 4 AMD



- 1 Wireless LAN antenna (main)
- 2 Wireless LAN antenna (auxiliary)
- 3 Wireless WAN antenna (MIMO1, for selected models)
- 4 Wireless WAN antenna (main, for selected models)
- 5 Wireless WAN antenna (MIMO2, for selected models)
- 6 Wireless WAN antenna (auxiliary, for selected models)

Operating environment

Maximum altitude (without pressurization)

3048 m (10 000 ft)

Temperature

- Operating: 5°C to 35°C (41°F to 95°F)
- Storage and transportation in original shipping packaging: -20°C to 60°C (-4°F to 140°F)
- Storage without packaging: 5°C to 43°C (41°F to 109°F)

Note: When you charge the battery, its temperature must be no lower than 10°C (50°F).

Relative humidity

- Operating: 8% to 95% at wet-bulb temperature 23°C (73°F)
- Storage and transportation: 5% to 95% at wet-bulb temperature 27°C (81°F)

Notice for USB connector name update

The USB Implementers Forum published a revision of the guideline for USB connector names in September, 2022. Lenovo follows the revised guideline and updates USB connector names accordingly. You can refer to the table below for naming update details.

Current name	Previous name
USB-A connector (Hi-Speed USB)	USB-A 2.0 connector
USB-A connector (USB 5Gbps)	USB-A 3.2 Gen 1 connector
USB-A connector (USB 10Gbps)	USB-A 3.2 Gen 2 connector
USB-A connector (USB 5Gbps, Always On USB)	Always on USB-A 3.2 Gen 1 connector
USB-A connector (USB 10Gbps, Always On USB)	Always on USB-A 3.2 Gen 2 connector
USB-C connector (USB 5Gbps)	USB-C (3.2 Gen 1) connector
USB-C connector (USB 10Gbps)	USB-C (3.2 Gen 2) connector
USB-C connector (USB 20Gbps)	USB 3.2 Gen 2x2
USB-C connector (USB4 20Gbps)	USB 4 Gen 2x2
USB-C connector (USB4 40Gbps)	USB-C (USB 4) connector
USB-C connector (Thunderbolt 3)	USB-C (Thunderbolt 3) connector
USB-C connector (Thunderbolt 4)	USB-C (Thunderbolt 4) connector

Appendix B. Accessibility features

Lenovo is committed to making information technology accessible to everyone, including those with hearing, vision, or mobility limitations. Lenovo supports accessibility features in the following ways to help all users better engage with Lenovo products.

Accessible documentation

Lenovo documentation is designed to meet users' accessibility needs. Users can read the documentation with assistance as needed. For example:

- Text and images are in high contrast. Color contrast can enhance the visual experience. In this mode, all contents are highlighted to be more visible.
- Text is logical and readable. Images are also readable with alternative text provided. A screen reader can enhance the hearing or listening experience. In this mode, all contents are clearer and easier to understand.
- Text is large and clear, making it easier to read. A magnifier can enlarge the text to improve readability.

For more information, watch the video at:

https://support.lenovo.com/docs/pc_pub_accessibility

Accessible product design

Lenovo product design also supports accessibility features.

Note: The accessibility features vary by product. Depending on the product model, some accessibility features listed below might not be applicable to the product. To get the most up-to-date accessibility information for the product, go to <https://www.lenovo.com/accessibility>. For additional support from Lenovo, users can find phone numbers for their country or region from <https://support.lenovo.com/supportphonenumber>.

- **Keyboards**

Lenovo keyboards support various accessibility features. For example:

- Consistent layout of keyboards for easier use
- Tactile markings on some keys for easier identification
- Appropriate spacing between keys for typing efficiency
- Sufficient contrast of keys, controls, and labels for better visibility
- On-screen notification or lighted notification for some keys for ease of use
- Keys and controls that can be reached and operated using one hand and require minimal dexterity for ease of use

- **Industry-standard connectors**

The industry-standard connectors on Lenovo products enable better compatibility with peripheral devices.

- **Operating systems**

The accessibility features of the operating systems can be configured to assist users in the following ways:

- Vision features make the screen contents easier to see.
- Hearing features make the screen contents easier to hear.
- Interaction features make the product easier to control.

To access the accessibility features of the Ubuntu or Fedora operating system, go to **Settings** → **Accessibility**.

Appendix C. Notices and trademarks

Notices

Lenovo may not offer the products, services, or features discussed in this document in all countries. Consult your local Lenovo representative for information on the products and services currently available in your area. Any reference to a Lenovo product, program, or service is not intended to state or imply that only that Lenovo product, program, or service may be used. Any functionally equivalent product, program, or service that does not infringe any Lenovo intellectual property right may be used instead. However, it is the user's responsibility to evaluate and verify the operation of any other product, program, or service.

Lenovo may have patents or pending patent programs covering subject matter described in this document. The furnishing of this document does not give you any license to these patents. You can send license inquiries, in writing, to:

*Lenovo (United States), Inc.
8001 Development Drive
Morrisville, NC 27560
U.S.A.
Attention: Lenovo Director of Licensing*

LENOVO PROVIDES THIS PUBLICATION "AS IS" WITHOUT WARRANTY OF ANY KIND, EITHER EXPRESS OR IMPLIED, INCLUDING, BUT NOT LIMITED TO, THE IMPLIED WARRANTIES OF NON-INFRINGEMENT, MERCHANTABILITY OR FITNESS FOR A PARTICULAR PURPOSE. Some jurisdictions do not allow disclaimer of express or implied warranties in certain transactions, therefore, this statement may not apply to you.

Changes are made periodically to the information herein; these changes will be incorporated in new editions of the publication. To provide better service, Lenovo reserves the right to improve and/or modify the products and software programs described in the manuals included with your computer, and the content of the manual, at any time without additional notice.

The software interface and function and hardware configuration described in the manuals included with your computer might not match exactly the actual configuration of the computer that you purchase. For the configuration of the product, refer to the related contract (if any) or product packing list, or consult the distributor for the product sales. Lenovo may use or distribute any of the information you supply in any way it believes appropriate without incurring any obligation to you.

The products described in this document are not intended for use in implantation or other life support applications where malfunction may result in injury or death to persons. The information contained in this document does not affect or change Lenovo product specifications or warranties. Nothing in this document shall operate as an express or implied license or indemnity under the intellectual property rights of Lenovo or third parties. All information contained in this document was obtained in specific environments and is presented as an illustration. The result obtained in other operating environments may vary.

Lenovo may use or distribute any of the information you supply in any way it believes appropriate without incurring any obligation to you.

Any references in this publication to non-Lenovo Web sites are provided for convenience only and do not in any manner serve as an endorsement of those Web sites. The materials at those Web sites are not part of the materials for this Lenovo product, and use of those Web sites is at your own risk.

Any performance data contained herein was determined in a controlled environment. Therefore, the result obtained in other operating environments may vary significantly. Some measurements may have been made on development-level systems and there is no guarantee that these measurements will be the same on generally available systems. Furthermore, some measurements may have been estimated through extrapolation. Actual results may vary. Users of this document should verify the applicable data for their specific environment.

This document is copyrighted by Lenovo and is not covered by any open source license, including any Linux agreement(s) which may accompany software included with this product. Lenovo may update this document at any time without notice.

For the latest information or any questions or comments, contact or visit the Lenovo Web site:

<https://support.lenovo.com>

Trademarks

LENOVO, LENOVO logo, THINKPAD, THINKPAD logo, TRACKPOINT, and ULTRACONNECT are trademarks of Lenovo. Intel, and Thunderbolt are trademarks of Intel Corporation or its subsidiaries in the U.S. and/or other countries. Linux is the registered trademark of Linus Torvalds in the U.S. and other countries. Ubuntu is a registered trademark of Canonical Ltd. “Fedora” is a registered trademark of Red Hat, Inc. The terms HDMI and HDMI High-Definition Multimedia Interface are trademarks or registered trademarks of HDMI Licensing LLC in the United States and other countries. Wi-Fi, Wi-Fi Alliance, and Miracast are registered trademarks of Wi-Fi Alliance. USB4[®] and USB-C[®] are registered trademarks of USB Implementers Forum. All other trademarks are the property of their respective owners.

Lenovo