

# LDE163G-182

## All-in-One Direct View LED Display User Guide

IMPORTANT: Please read this User Guide to obtain important information on installing and using your product in a safe manner, as well as registering your product for future service. Warranty information contained in this User Guide will describe your limited coverage from ViewSonic® Corporation, which is also found on our web site at <http://www.viewsonic.com> in English, or in specific languages using the Regional selection box of our website.

Model No. VS20991  
P/N: LDE163G-182

## **Thank you for choosing ViewSonic®**

As a world-leading provider of visual solutions, ViewSonic® is dedicated to exceeding the world's expectations for technological evolution, innovation, and simplicity. At ViewSonic®, we believe that our products have the potential to make a positive impact in the world, and we are confident that the ViewSonic® product you have chosen will serve you well.

Once again, thank you for choosing ViewSonic®!

# Safety Precautions

Please read the following **Safety Precautions** before you start using the device.

- Keep this user guide in a safe place for later reference.
- Read all warnings and follow all instructions.
- Ensure there is no direct airflow from air conditioning blowing on the display.
- Do not use the device near water. To reduce the risk of fire or electric shock, do not expose the device to moisture.
- Avoid exposing the device to direct sunlight or other sources of sustained heat.
- Do not install near any heat sources such as radiators, heat registers, stoves, or other devices (including amplifiers) that may increase the temperature of the device to dangerous levels.
- When moving the device, be careful not to drop or bump the device on anything.
- Do not place the device on an uneven or unstable surface. The device may fall over resulting in an injury or a malfunction.
- Verify the wall can support the display's weight. If not, reinforce the wall before installation.
- Do not place any heavy objects on the device or connection cables.
- If smoke, an abnormal noise, or a strange odor is present, immediately turn the device off and call your dealer or ViewSonic®. It is dangerous to continue using the device.
- Do not attempt to circumvent the safety provisions of the polarized or grounding-type plug. A polarized plug has two blades with one wider than the other. A grounding-type plug has two blades and a third grounding prong. The wide blade and the third prong are provided for your safety. If the plug does not fit into your outlet, obtain an adapter and do not attempt to force the plug into the outlet.
- When connecting to a power outlet, DO NOT remove the grounding prong. Please ensure grounding prongs are NEVER REMOVED.
- Protect the power cord from being treaded upon or pinched, particularly at the plug, and at the point where it emerges from the equipment. Ensure that the power outlet is located near the equipment so that it is easily accessible.
- Only use attachments/accessories specified by the manufacturer.
- When a cart is used, use with caution when moving the cart/equipment combination to avoid injury from tipping over.



- Disconnect the power plug from the AC outlet if the device is not being used for a long period of time.
- Place the device in a well-ventilated area.
- Do not cover the surface of the display with any material.
- Do not block the air circulation around the display.
- Keep flammable materials away from the display.
- Refer all servicing to qualified service personnel. Service will be required when the unit has been damaged in any way, such as:
  - » if the power supply cord or plug is damaged;
  - » if liquid is spilled onto or objects fall in the unit;
  - » if the unit is exposed to moisture;
  - » if the unit does not operate normally or has been dropped.
- Do not assemble the display by yourself.
- This panel is an advanced product that contains millions of pixels. You may occasionally see pixel spots when viewing the screen. Since these deactivated pixels are not a defect, the performance and reliability of the product is not affected.
- It is recommended that electrical connections, and all associated servicing and adjusting, should only be performed in a safe manner by a qualified electrician approved or licensed as required by the locality.

# Contents

<b>Introduction .....</b>	<b>1</b>
Package Contents .....	1
Product Overview .....	3
Front View .....	3
Rear View .....	3
Bottom View .....	3
System Control Board .....	4
Remote Control .....	5
Overview .....	5
Receiver Range .....	7
Installing the Batteries .....	8
<b>Safety Precautions.....</b>	<b>11</b>
<b>Making Connections.....</b>	<b>16</b>
Connecting to Power .....	16
Connecting Video .....	17
HDMI .....	17
USB Type C .....	17
Connecting to External Devices .....	18
USB .....	18
Control.....	18
Audio .....	18

<b>Using Your Display.....</b>	<b>19</b>
Turning the LED Display On/Off.....	19
Home Screen .....	20
Settings.....	21
Network.....	21
General.....	22
System .....	24
Settings Menu Tree .....	25
On-Screen Display Menu .....	28
Menu Navigation .....	29
Menu Options.....	30
Brightness.....	30
Volume .....	30
Color .....	31
Input Source .....	32
On-Screen Display Menu Tree .....	33
<b>Appendix.....</b>	<b>34</b>
Specifications.....	34
Timing Chart .....	36
HDMI (PC).....	36
HDMI (Video).....	37
Supported File Formats .....	38
Maintenance Tools .....	43
LED Module Removal Tool .....	43
Troubleshooting .....	44
Maintenance.....	46
General Precautions.....	46
Initial Operation .....	46
Front Panel Cleaning Instructions .....	46
Cabinet Cleaning Instructions .....	47
Regular Use .....	47
<b>RS-232 Protocol.....</b>	<b>48</b>
Description .....	48
RS-232 Hardware Specification .....	48
RS-232 Communication Setting.....	48
Command Table.....	49
Get Operation Time Example .....	52

<b>Regulatory and Service Information .....</b>	<b>53</b>
Compliance Information.....	53
FCC Compliance Statement.....	53
IC Warning Statement.....	54
CE Conformity for European Countries.....	54
Declaration of RoHS2 Compliance.....	55
Indian Restriction of Hazardous Substances .....	56
Product Disposal at End of Product Life .....	56
Copyright Information .....	57
Customer Service.....	58
Limited Warranty .....	59
Mexico Limited Warranty.....	62

# Introduction

## Package Contents

Item	Description	Quantity	Note
Quick Start Guide		1	
LED Display	Cabinet Section	6	One Right (A), four Middle (B, C, D, E), and one Left (F)
	LED Module	144	The quantity of spare LED modules varies by country.
Screen Bezel		12	6 x Left 6 x Right
Wall Installation	Wall Mount Brackets	4	1799 mm
	Wall Mount Connector Plate	2	
Accessories	Screws	48 x M8 x 80 mm 62 x M8 x 20 mm 12 x M6 x 10 mm 5 x M2.5 x 4 mm	
	Hand Tools	2 x Cabinet magnet adjustment tools 2 x Cross-head screwdrivers 2 x T-line hex wrenches	
	Anti-Static Gloves	2 pairs	

Item	Description	Quantity	Note
Remote Control		1	With two AAA batteries
Power Cord	AC input	2	5 m
Ethernet Cable		1	3.5 m
Flexible Flat Cables		3 x 30 Pin x 390 mm 3 x 30 Pin x 110 mm 8 x 68 Pin x 530 mm	
RS-232 Cable	3.5 mm Barrel to DSUB 9-Pin Female	1	
USB Type C to HDMI Cable		1	
Maintenance Tool	LED Module Removal Tool	1	P/N: LD-MK-006
USB Thumb Drive		1	

**Note:**

- This product is packed in a wooden crate.
- Due to the size and weight, it is recommended that two or more people handle it.
- The base stand (trolley) is an optional accessory and sold separately.

# Product Overview

## Front View

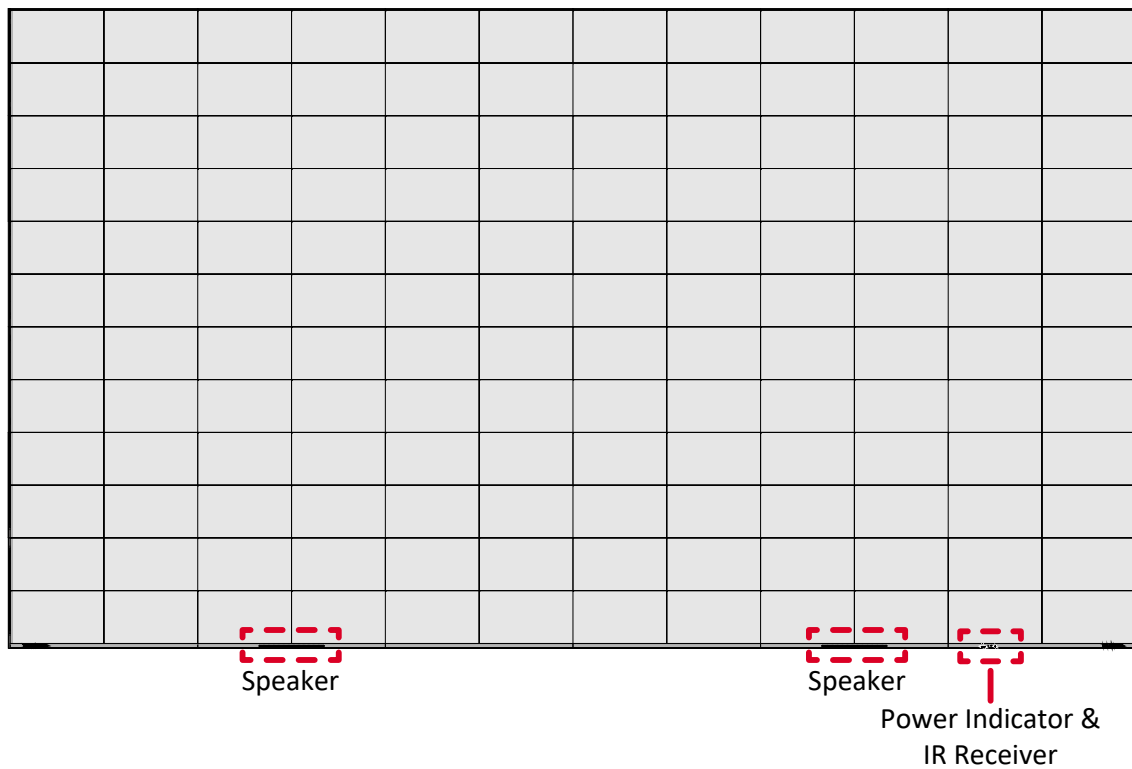

## Rear View

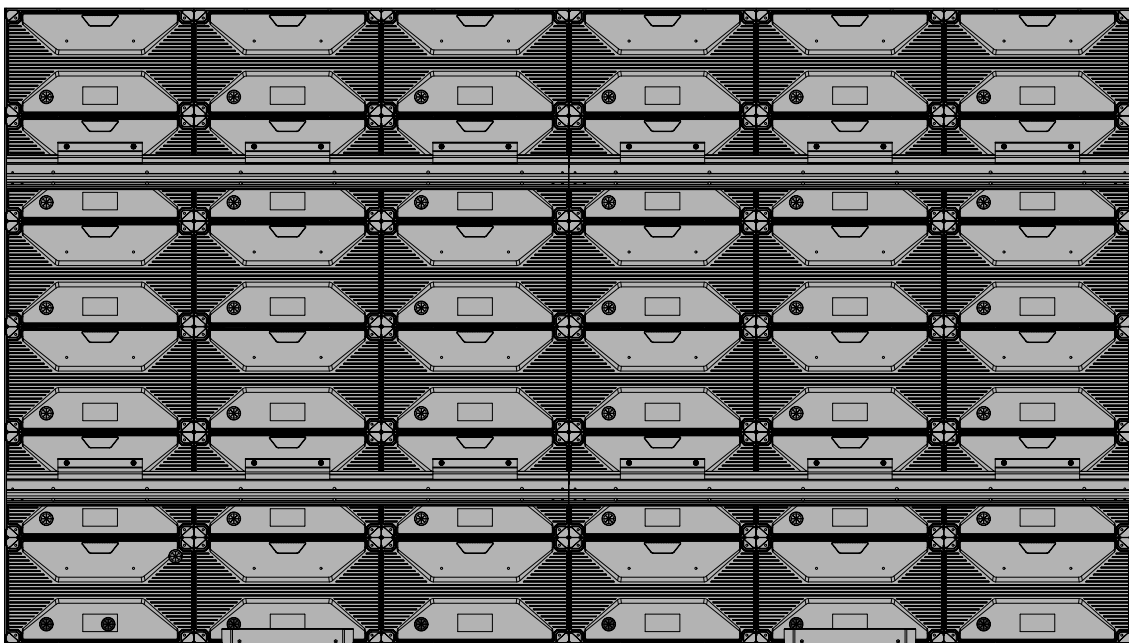

## Bottom View

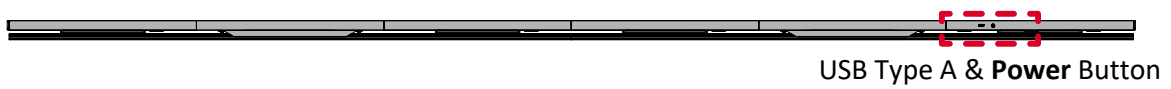

# System Control Board

**Note:**

- The I/O ports on the System Control Board should be connected when installing the display. For any servicing after the installation, contact qualified service personnel.
- The System Control Board is accessed by removing the LED Module at the lower right corner.

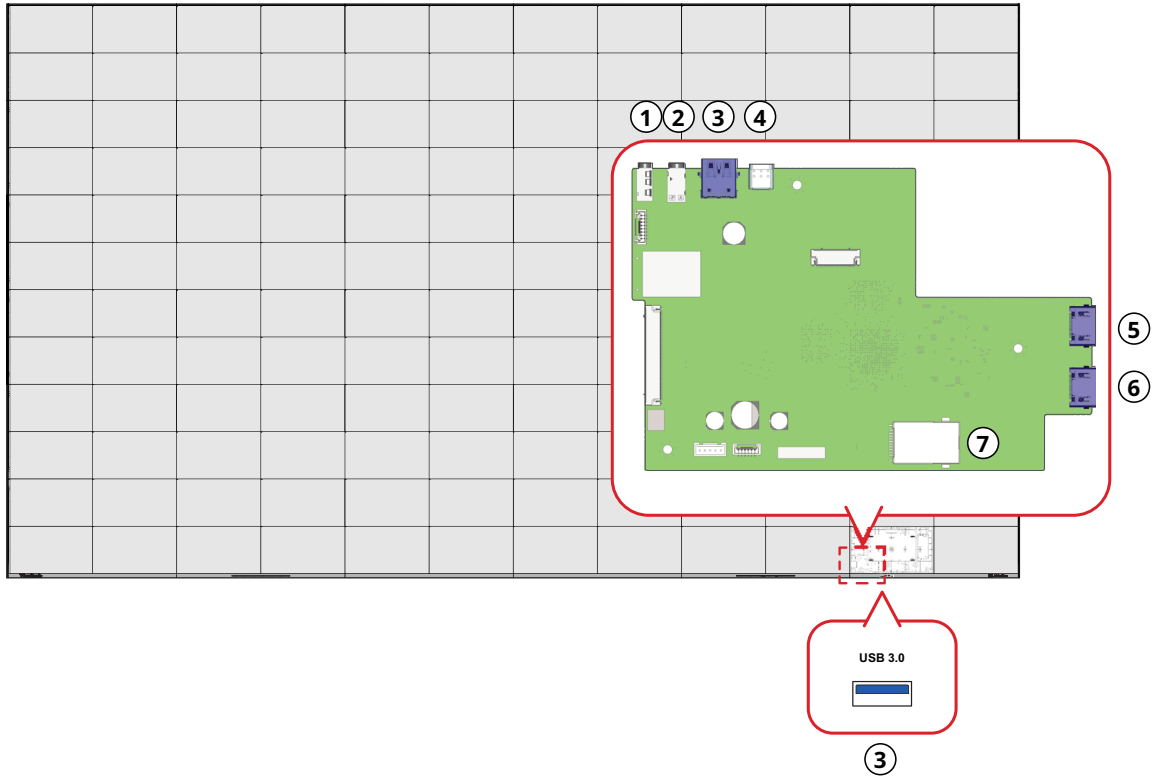

Connection Type		Description
1	RS-232 <sup>1</sup>	For remote operation of the display from an external computer or control system.
2	Audio Out	Analog audio output to external speakers.
3	USB Type A <sup>2</sup>	Reads data from storage devices.
		USB 3.0 standard.
4	USB Type C <sup>1</sup>	USB Type C output for external device input.
5	HDMI 1	HDMI 2.0 input with HDCP 2.2 support.
6	HDMI 2	HDMI 1.4 input with HDCP 1.4 support.
7	RJ45	For remote operation of the display from an external computer or control system.

1– To avoid compatibility issue, use only the supplied cable.

2– The display is equipped with two USB Type A ports. One can be accessed externally, while the other is built on the System Control Board.

# Remote Control

## Overview

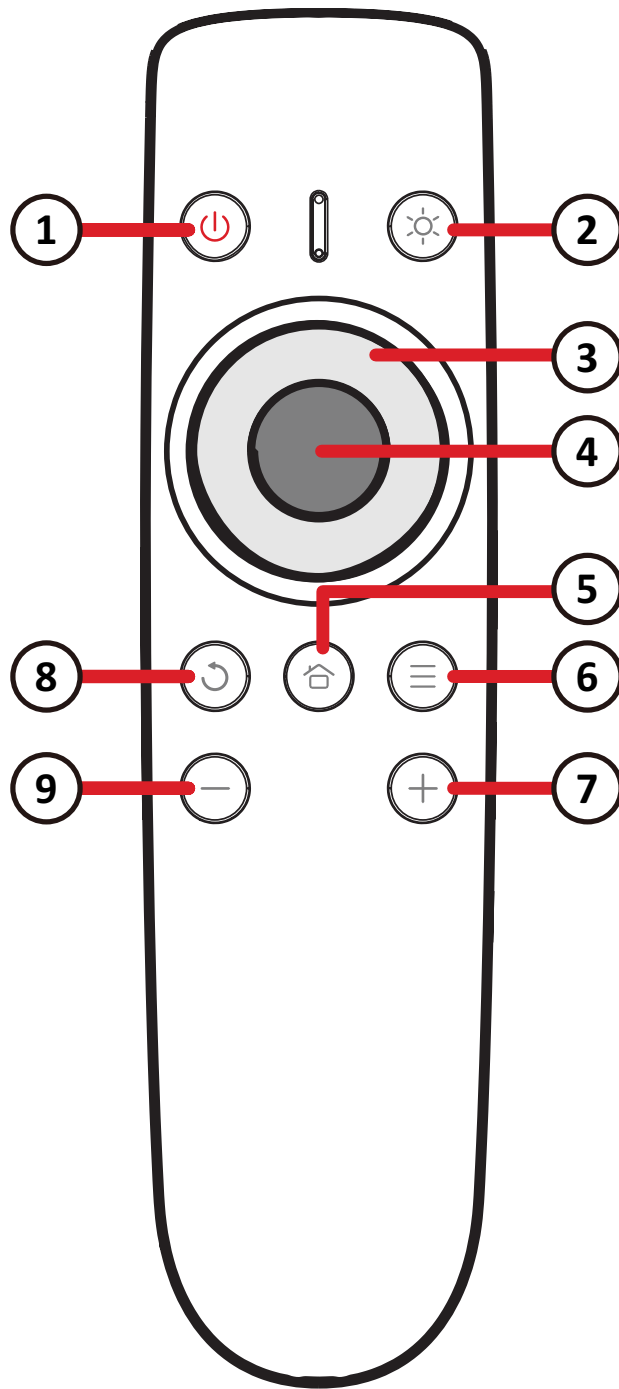

<b>Button</b>		<b>Description</b>
<b>1</b>	Power	Turns the display on or off.
<b>2</b>	Brightness	Adjusts the brightness level.
<b>3</b>	Navigational Pad	Selects an item or adjust the value in the menu.
		Includes up, down, left, and right directional buttons.
<b>4</b>	OK	Confirms the selected item.
<b>5</b>	Home	Goes to the Home screen.
<b>6</b>	Menu	Opens the On-Screen Display Menu.
<b>7</b>	Volume Up	Increases the volume level.
<b>8</b>	Return	Returns to the previous screen.
<b>9</b>	Volume Down	Decreases the volume level.

## Receiver Range

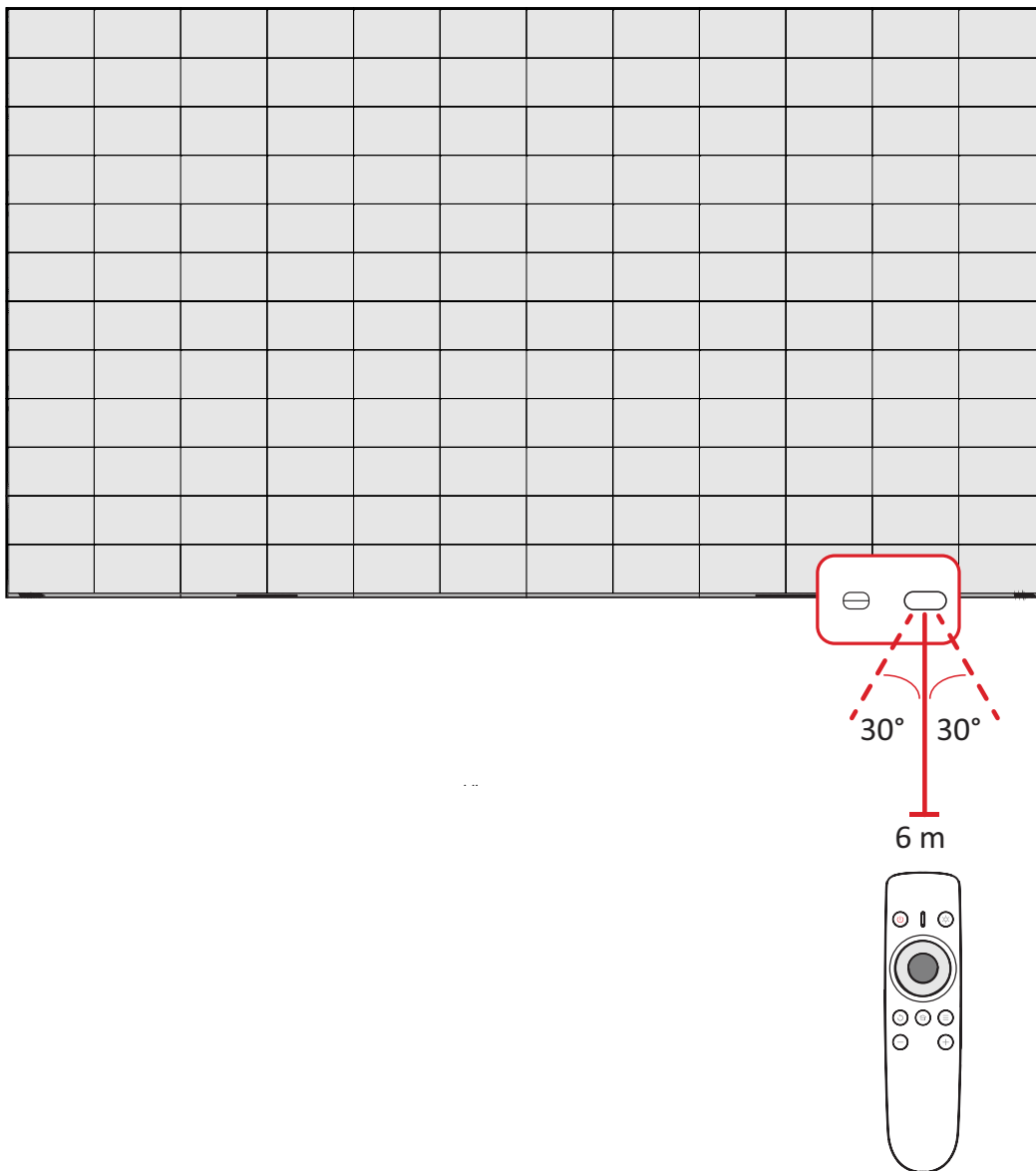

For optimal performance, aim the remote control directly at the IR Receiver. The maximum operation range is 6 m (20 ft) with a horizontal and vertical field of view of  $\pm 30$  degrees.

## Installing the Batteries

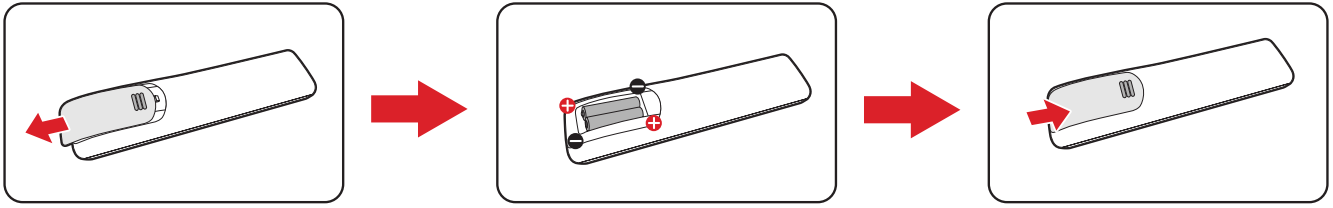

1. Open the battery compartment by removing the battery cover.
2. Insert two AAA batteries, ensuring correct polarity.
3. Replace the battery cover and press it down until it clicks into place.

### Note:

- Use only recommended battery types.
- Store the remote control and batteries away from heat and humidity.
- Remove batteries when not in use for extended periods.
- Dispose of old batteries following the manufacturer's instructions and local regulations.

# Making Connections

## Connecting to Power

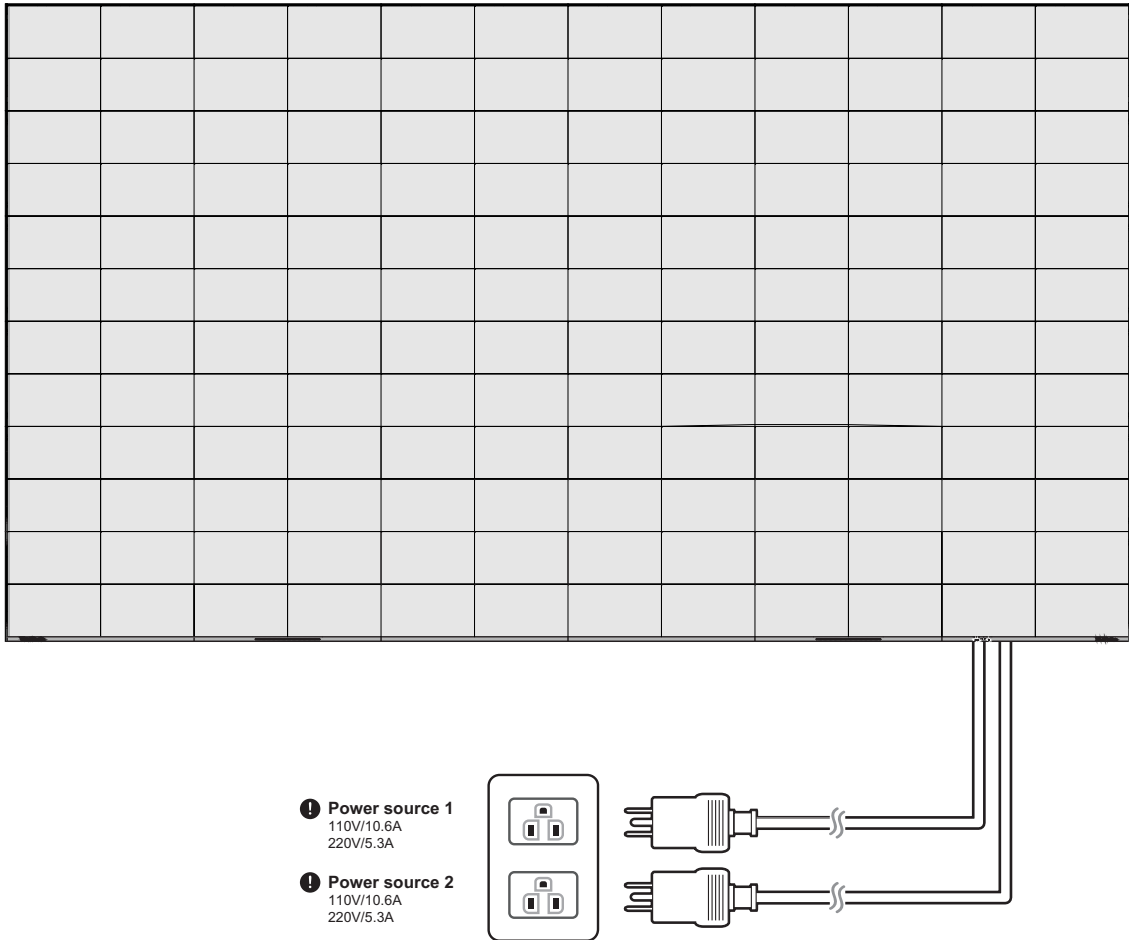

Plug the power cord plug into a power outlet.

# Connecting Video

## HDMI

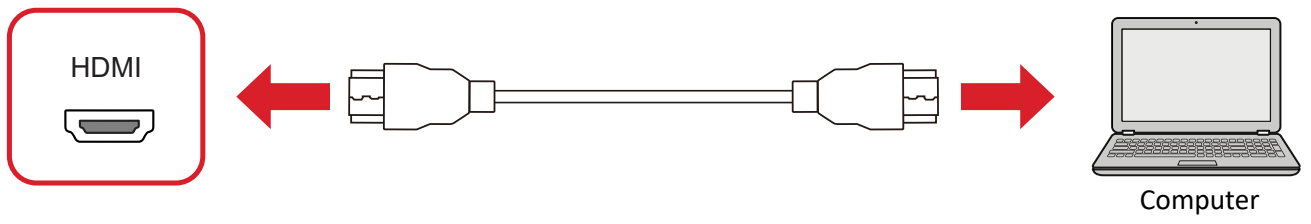

## USB Type C

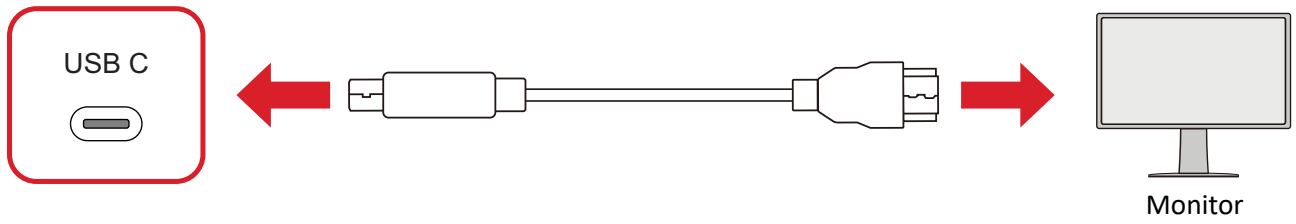

# Connecting to External Devices

## USB

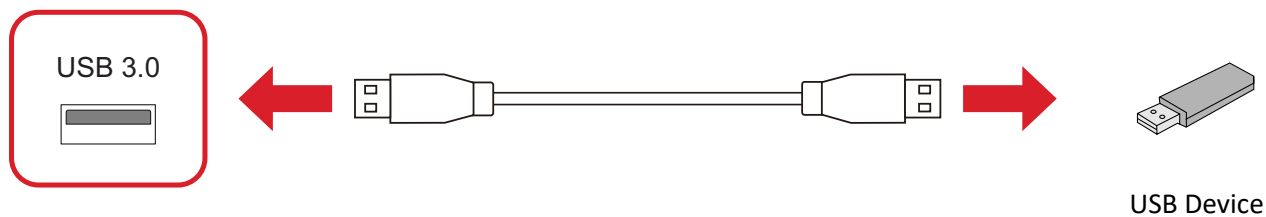

**Note:** Both USB Type A ports are for data (5V/0.9A) only.

## Control

- LAN

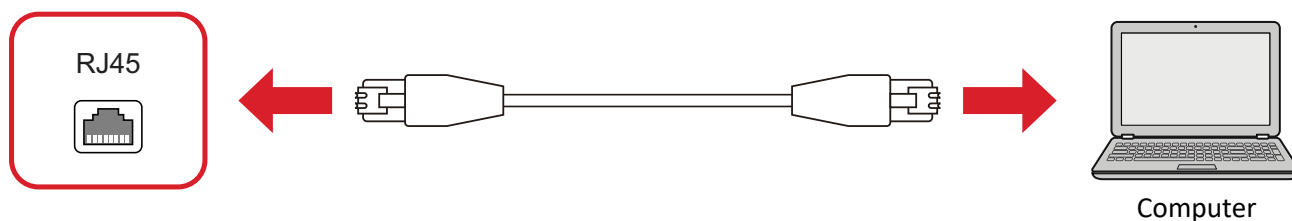

- RS232

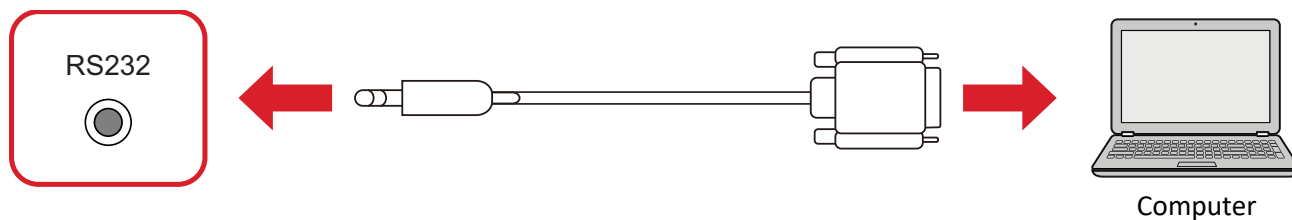

**Note:** For more information about the **RS232**, refer to "RS-232 Protocol".

## Audio

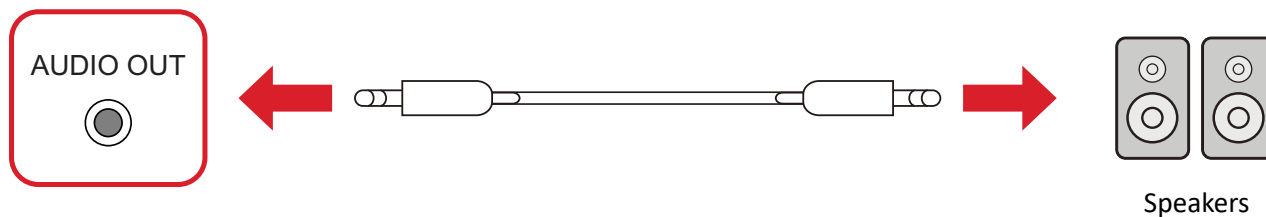

# Using Your Display

## Turning the LED Display On/Off

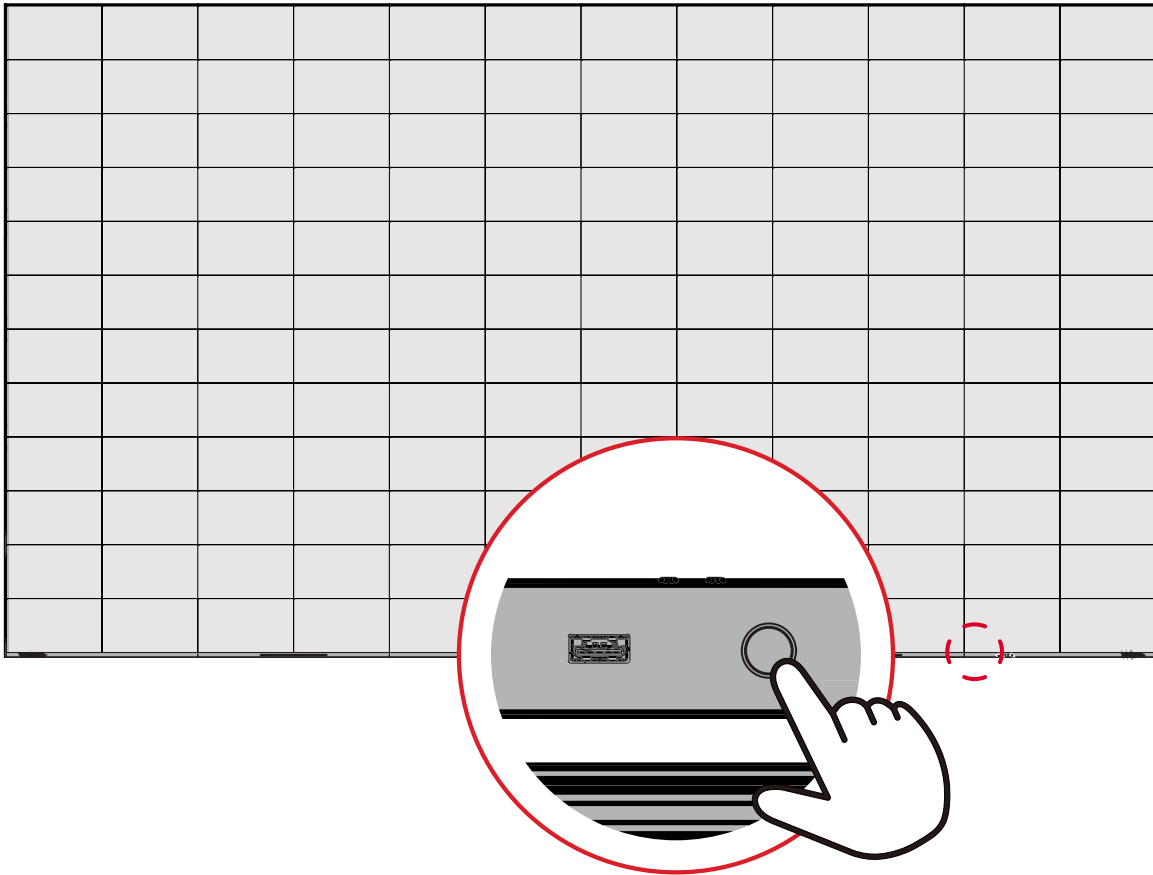

1. Make sure the power cord is connected and plugged into a power outlet.
2. Press the **Power** button on the display or remote control to turn on the display.
3. To turn the display off, press and hold the **Power** button until the on-screen countdown ends.

### Note:

- Pressing the **Power** button only turns off the backlight.
- Do not unplug the power cord before the display completely turns off.

# Home Screen

When you turn on the display or press the **Home** button on the remote control, the Home screen will be displayed.

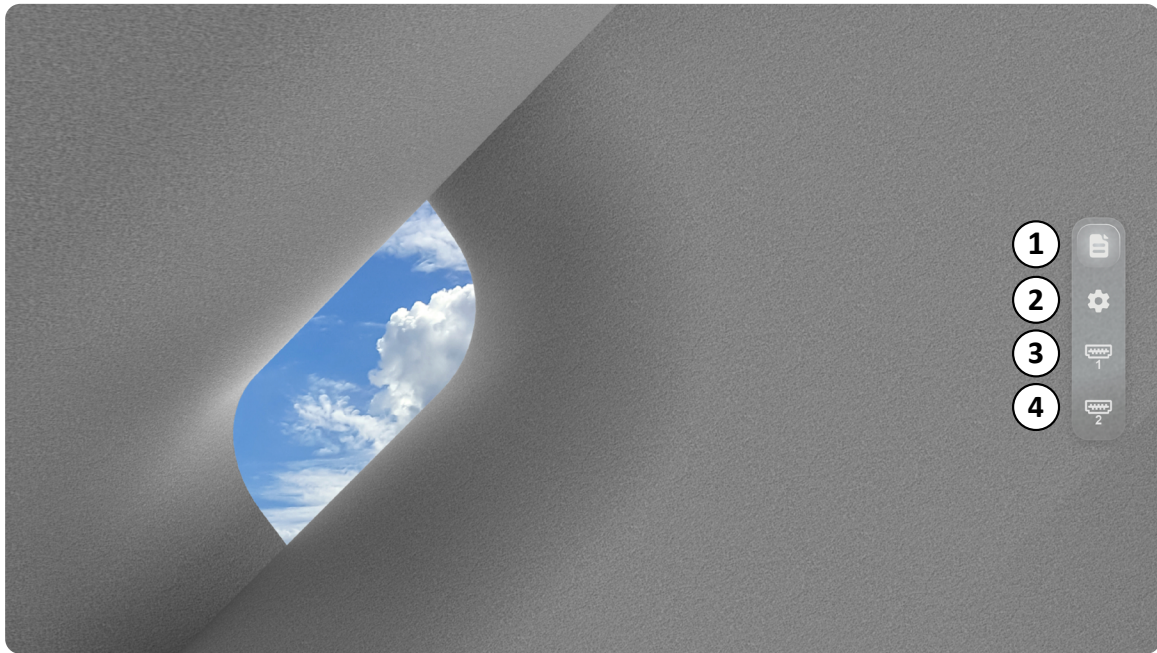

Number	Item	Description
1	File Manager <sup>1</sup>	Allows you to manage local files and folders.
2	Settings	Opens the <b>Settings</b> menu.
3	HDMI 1	Sets HDMI 1 as the input source.
4	HDMI 2	Sets HDMI 2 as the input source.

<sup>1</sup>– On the On-Screen Display Menu, **File Manager** can also be accessed by going to the **Input Source** menu, then select **Home**. For more information about the menu, refer to “Input Source”.

# Settings

## Network

Adjusts the Ethernet network settings.

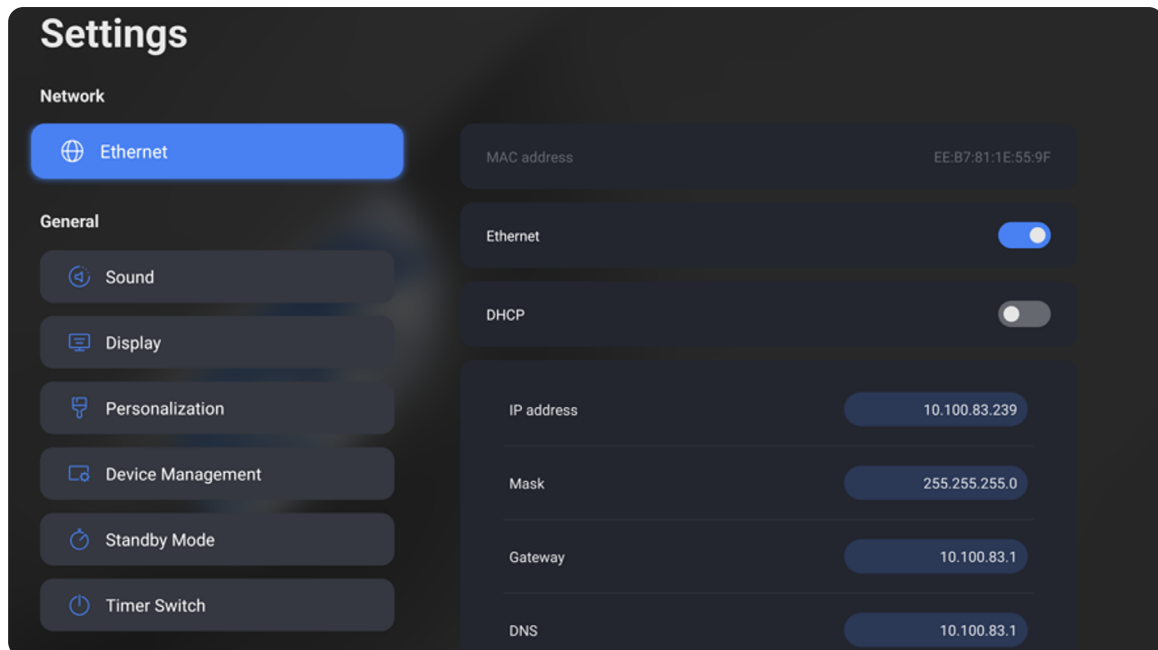

# General

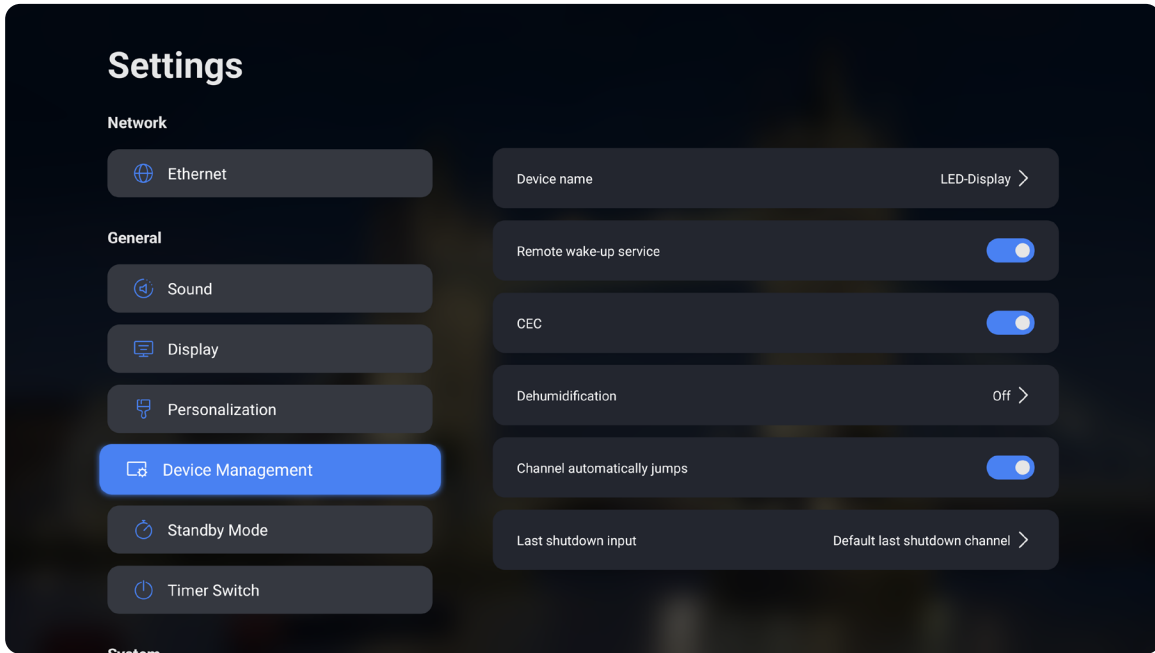

Menu	Description	
Sound	Volume	Adjusts the volume level.
	Speaker	Selects the audio output source: the display's speakers or <b>Audio Out</b> jack.
Display	Image mode	Customizes a color mode to specific needs and preferences: Standard, Soft, Movie, or Meeting.
	Brightness	Adjusts how bright or how dark the image will be.
	Contrast	Adjusts the difference between the brightest and darkest parts of the image.
	Saturation	Adjusts the amount of brilliance and intensity in the image.
	Color temperature	Selects a color temperature: Warm, Normal, or Cool.
	Color hue	Adjusts the overall color tune of the image.
Personalization	Home Page	Changes the background image on the Home screen.
	Boot animation	Select a custom boot logo or animation file.

Menu	Description	
<b>Device Management</b>	Device name	Customizes the display's name.
	Remote wake-up service	Turns the display on remotely using Wake-on-LAN.
	CEC	Turns on or off HDMI CEC-compatible devices connected to the display with a single button press.
	Dehumidification settings	Removes moisture from the display automatically based on your set humidity level.
	Channel automatically jumps	Switches the input source automatically when a display cable is connected.
	Last shutdown input	Sets the default input source when the display is turned on: Last shutdown source, Home, HDMI 1, or HDMI 2.
<b>Standby Mode</b>	Sleep time	Turns the display off automatically after a set period of time once no input signal is detected.
<b>Timer Switch</b>	Add power-on schedule	Turns the display on or off after a set period of time.
	Add power-off schedule	

## System

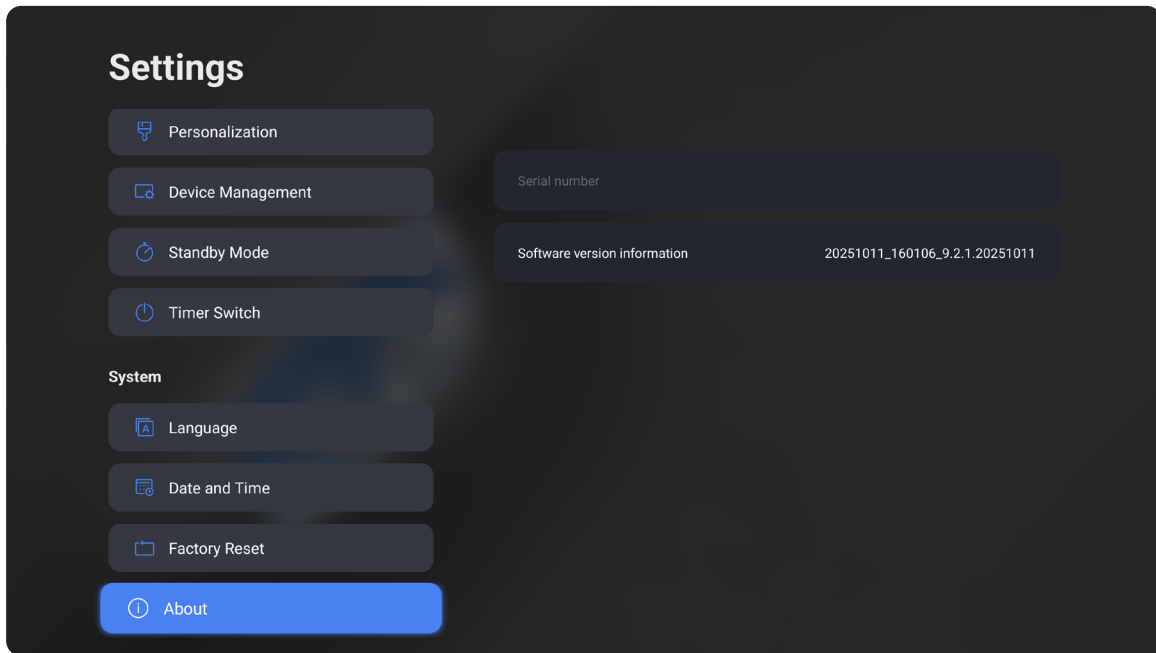

Menu	Description
<b>Language</b>	Sets the language for the On-Screen Display Menu.
<b>Date and Time</b>	Sets the current date and time.
<b>Factory Reset</b>	Returns the display's settings to their default values.
<b>About</b>	Shows the display's serial number and software version information.

## Settings Menu Tree

Main Menu	Sub-menu	Menu Option	
Network	Ethernet	Mac address	
		Ethernet	Disable
			Enable
		DHCP	Disable
			Enable
		Manually configure network settings	IP address
			Mask
			Gateway
DNS			
General	Sound	Volume	(-/+ , 0~100)/1
		Speaker	
	Display	Image mode	Standard
			Soft
			Movie
			Meeting
		Brightness	(-/+ , 0~100)/1
		Contrast	(-/+ , 0~100)/1
		Saturation	(-/+ , 0~100)/1
		Color temperature	Warm
	Normal		
	Cool		
	Color Hue	(-/+ , -50~50)/1	
	Personalization	Home Page	
		Boot animation	

Main Menu	Sub-menu	Menu Option	
General	Device Management	Device name	
		Remote wake-up service	Disable
			Enable
		CEC	Disable
			Enable
		Dehumidification settings	Off
			Low
			Middle
			High
		Channel automatically jumps	Disable
			Enable
		Last shutdown input	Default last shutdown channel
			Home
	HDMI1		
	HDMI2		
	Standby Mode	Sleep time	Disable
			Enable
			1/5/10/30/60 min
	Timer Switch	Add power-on schedule	
		Add power-off schedule	

Main Menu	Sub-menu	Menu Option	
System	Language	English	
		简体中文	
		繁體中文	
		Español	
		Français	
		Italiano	
		日本語	
		한국어	
		Русский	
	Date and Time	24-hour format	Disable
			Enable
		Set date	
	Set time		
	Factory Reset		
	About	Serial number	
Software version information			

# On-Screen Display Menu

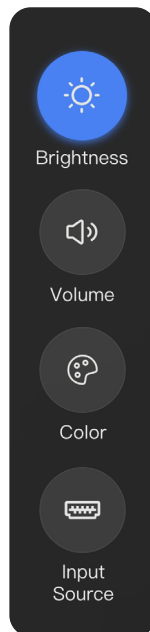

Menu	Description
<b>Brightness</b>	Adjusts how bright or how dark the image will be.
<b>Volume</b>	Adjusts the volume level.
<b>Color<sup>2</sup></b>	Opens the <b>Color</b> menu.
<b>Input Source</b>	Opens the <b>Input Source</b> menu.

2– The **Color** menu is available only when **Home** is the selected input source. To access image settings when **HDMI 1** or **HDMI 2** is selected, go to the Home screen, then select **Settings > General > Display**.

## Menu Navigation

1. To open the On-Screen Display Menu, press the **Menu** button.
2. Press the **Navigational Pad** (↑/↓) to select the main menu, then press the **OK** button to enter the selected menu.
3. Move the **Navigational Pad** (↑/↓) to select the desired menu option. Then, press the **OK** button to enter the sub-menu.
4. Move the **Navigational Pad** (↑/↓) to adjust/select the setting. Then press the **OK** button to confirm.
5. To exit the menu, press the **Menu** button.

## Menu Options

### Brightness

Adjust how bright or how dark the image will be.

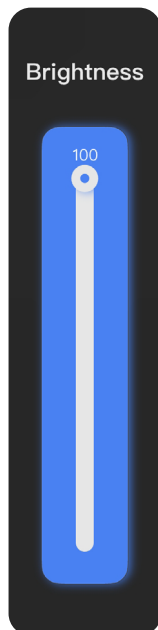

### Volume

Adjust the volume level.

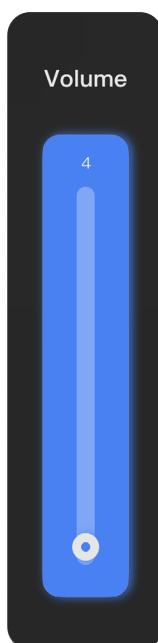

# Color

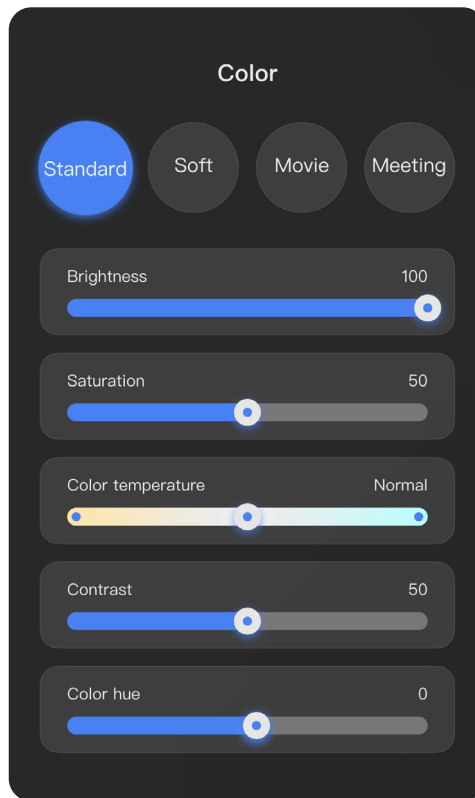

Menu	Description	
Color	Standard	Selects a color mode to specific needs and preferences.
	Soft	
	Movie	
	Meeting	
Brightness	Adjusts how bright or how dark the image will be.	
Saturation	Adjusts the amount of brilliance and intensity in the image.	
Color Temperature	Warm	Selects a color temperature.
	Normal	
	Cool	
Contrast	Adjusts the difference between the brightest and darkest parts of the image.	
Color Hue	Adjusts the overall color tune of the image.	

## Input Source

Select the input source: Home, HDMI 1, or HDMI 2.

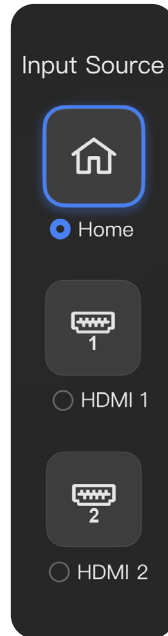

## On-Screen Display Menu Tree

Main Menu	Sub-menu	Menu Option	
Brightness	(-/+ , 0~100)/1		
Volume	(-/+ , 0~100)/1		
Color	Color Mode	Standard	
		Soft	
		Movie	
		Meeting	
	Brightness	(-/+ , 0~100)/1	
	Saturation	(-/+ , 0~100)/1	
	Color Temperature	Warm	
		Normal	
		Cool	
Contrast	(-/+ , 0~100)/1		
Color Hue	(-/+ , -50~50)/1		
Input Source	Home		
	HDMI 1		
	HDMI 2		

# Appendix

## Specifications

Item	Category	Specifications	
Model		LDE163G-182	
LED Screen	Type	Direct View LED Display	
	Size	163"	
	Active Size (H x V)		3,600 mm x 2,025 mm
			141.7" x 79.7"
	Pitch Size	1.88 mm	
	Resolution	FHD, 1920 x 1080	
	Refresh Frequency	3,840 Hz	
	Contrast Ratio	6,500:1 (Typical)	
	Brightness	100-600 cd/m2 (100 levels of adjustment)	
LED Lifespan	100,000 hours		
Input Signal		1 x HDMI 2.0 (3840 x 2160 @ 60Hz, HDCP 2.2)	
		1 x HDMI 1.4 (1920 x 1080, HDCP 1.4)	
		1 x IR Receiver	
		1 x RS-232 (3.5 mm, for control)	
		1 x RJ45 (for LAN control)	
		2 x USB Type A 3.0 (Shared) ( 1 x internal + 1 x external)	
Output Signal		1 x USB Type C (HDMI Out)	
		1 x Audio Out (3.5 mm, headphone/ speakers)	
		2 x USB Type A 3.0 (Shared) [5V/0.9A] (1 x internal + 1 x external)	
Speaker Output		2 x 8W	
Power	Voltage	100-120V/20A ~ 50/60Hz	
		220-240V/10A ~ 50Hz (will vary by country)	
Operating Conditions	Altitude	≤ 5,000 m	
		≤ 16,404 ft	
	Relative Humidity	10%~80% non-condensing	
	Temperature	0° C to 40° C	
32° F to 104° F			

Item	Category	Specifications
Storage Conditions	Altitude	≤ 5,000 m
		≤ 16,404 ft
	Relative Humidity	10%~85% non-condensing
	Temperature	-10° C to 60° C
14° F to 140° F		
Physical Dimensions (W x H x D)	Without Wall Mount	3,612 x 2,046.4 x 52 mm
		142.2" x 80.6" x 2.1"
	With Wall Mount	3,612 x 2,046.4 x 61.7 mm
		142.2" x 80.6" x 2.4"
	With Base Stand	3,612 x 2,844.3 x 897.6 mm
		142.2" x 112.0" x 35.3"
Weight	Without Wall Mount	153 kg
		337.3 lb
	With Wall Mount	170 kg
		374.8 lb
	With Base Stand	217 kg
		478.4 lb
Power Consumption	On	770W (Normal) 2,332W (Maximum)
	Off	< 0.5W

**Note:** Product specifications are subject to change without notice.

# Timing Chart

## HDMI (PC)

Resolution	Refresh Rate
640 x 480	60 Hz
800 x 600	60 Hz
1024 x 768	60 Hz
1280 x 768	60 Hz
1280 x 800	60 Hz
1280 x 960	60 Hz
1280 x 1024	60 Hz
1360 x 768	60 Hz
1366 x 768	60 Hz
1400 x 1050	60 Hz
1440 x 900	60 Hz
1600 x 1200	60 Hz
1680 x 1050	60 Hz
1920 x 1080	60 Hz
3840 x 2160 <sup>1</sup>	60 Hz

<sup>1</sup> – For the **HDMI 1** port only.

## HDMI (Video)

Video	Resolution	Refresh Rate
480p	640 x 480	60 Hz
576p	720 x 576	50 Hz
800 x 600	800 x 600	60 Hz
1024 x 768	1024 x 768	60 Hz
720p	1280 x 720	50, 60 Hz
1080p	1920 x 1080	24, 25, 30, 50, 60 Hz
2560 x 1080 <sup>2</sup>	2560 x 1080	60 Hz
3440 x 1440 <sup>2</sup>	3440 x 1440	60 Hz
2160p <sup>2</sup>	3840 x 2160	24, 25, 30, 50, 60 Hz

### Note:

- The computer text quality is optimal in HD 1080 mode (1920 x 1080, 60 Hz).
- Your computer display screen might appear different depending on the manufacturer and your operating system.
- Consult your computer's instructional manual on how to connect to an external display.
- The display timings conform to VESA and CTA standards.
- For 4:3 content, the screen will display them in the center of the screen and maintain a 4:3 aspect ratio.
- The optimal vertical frequency for each mode is 60 Hz.

---

2 – For the **HDMI 1** port only.

## Supported File Formats

Type	File Type	Codec	Ability
Photo	.jpeg	JFIF file format 1.02	Max Resolution: 8176 x 8176
			Min Resolution: 48 x 48
	.jpg	JFIF file format 1.02	Max Resolution: 8176 x 8176
			Min Resolution: 48 x 48
	.bmp	BMP	Max Resolution: 8176 x 8176
			Min Resolution: 48 x 48
	.gif	GIF	Max Resolution: 8176 x 8176
			Min Resolution: 48 x 48
	.png	PNG	Max Resolution: 8176 x 8176
			Min Resolution: 48 x 48
Audio	.mp3	MPEG 1/2 Layer 1/2/3	Bit rate: 8 kbps~320 kbps, CBR and VBR
			Sampling rate: 8 kHz~48 kHz
	.wav	MS-ADPCM, IMA-ADPCM, PCM	Sampling rate: 8 kHz~48 kHz
			Supported: 4 bit MS-ADPCM, IMA-ADPCM
	.flac	Compress Level 0~8	Sampling rate: 8 kHz~48 kHz
Video	.3gp	MPEG4	Supported Image Size: 48 x 48 pixels to 1920 x 1080 pixels
			Maximum Frame Rate: 30 fps
			Maximum Bit Rate: 38.4 Mbps
			Not supported: MS MPEG4 v1, v2, v3
			Not supported: GMC
		H.263	Supported Image Size: SQCIF (128 x 96), QCIF (176 x 144), CIF (352 x 288), 4CIF (704 x 576)
			Maximum Frame Rate: 30 fps
			Maximum Bit Rate: 38.4 Mbps
			Not supported: H.263+
		H.264/AVC	Supported Image Size: 48 x 48 pixels to 4096 x 2304 pixels
	Maximum Frame Rate: 2304p @ 30 fps, 1080p @ 60 fps		
	Maximum Bit Rate: 100 Mbps		
	Supported: Field Coding		
	Supported: MBAFF		

Type	File Type	Codec	Ability
Video	.avi	MPEG4	Supported Image Size: 48 x 48 pixels to 1920 x 1080 pixels
			Maximum Frame Rate: 30 fps
			Maximum Bit Rate: 38.4 Mbps
			Not supported: MS MPEG4 v1, v2, v3 & GMC
		H.264/AVC	Supported Image Size: 48 x 48 pixels to 4096 x 2304 pixels
			Maximum Frame Rate: 2304p @ 30 fps, 1080p @ 60 fps
			Maximum Bit Rate: 100 Mbps
			Supported: Field Coding & MBAFF
	.flv	H.264/AVC	Supported Image Size: 48 x 48 pixels to 4096 x 2304 pixels
			Maximum Frame Rate: 2304p @ 30 fps, 1080p @ 60 fps
			Maximum Bit Rate: 100 Mbps
			Supported: Field Coding & MBAFF

Type	File Type	Codec	Ability
Video	.mkv	MPEG4	Supported Image Size: 48 x 48 pixels to 1920 x 1080 pixels
			Maximum Frame Rate: 30 fps
			Maximum Bit Rate: 38.4 Mbps
			Not supported: MS MPEG4 v1, v2, v3 & GMC
		H.264/AVC	Supported Image Size: 48 x 48 pixels to 4096 x 2304 pixels
			Maximum Frame Rate: 2304p @ 30 fps, 1080p @ 60 fps
			Maximum Bit Rate: 100 Mbps
			Supported: Field Coding & MBAFF
		H.264/MVC	Supported Image Size: 48 x 48 pixels to 4096 x 2304 pixels
			Maximum Frame Rate: 2304p @ 30 fps, 1080p @ 60 fps
			Maximum Bit Rate: 50 Mbps
			Supported: Stereo High Profile only
		H.265/HEVC	Supported Image Size: 64 x 64 pixels to 4096 x 2304 pixels
			Maximum Frame Rate: 2304p @ 60 fps
			Maximum Bit Rate: 100 Mbps
			Supported: Main Profile & Main10 Profile
			Supported: Tile & SLIC
		VP8	Supported Image Size: 48 x 48 pixels to 1920 x 1080 pixels
			Maximum Frame Rate: 30 fps
			Maximum Bit Rate: 38.4 Mbps
		VP9	Supported Image Size: 48 x 48 pixels to 4096 x 2304 pixels
			Maximum Frame Rate: 2304p @ 60fps
			Maximum Bit Rate: 100 Mbps

Type	File Type	Codec	Ability
Video	.mov	MPEG4	Supported Image Size: 48 x 48 pixels to 1920 x 1080 pixels
			Maximum Frame Rate: 30 fps
			Maximum Bit Rate: 38.4 Mbps
			Not supported: MS MPEG4 v1, v2, v3 & GMC
		H.264/AVC	Supported Image Size: 48 x 48 pixels to 4096 x 2304 pixels
			Maximum Frame Rate: 2304p @ 30 fps, 1080p @ 60 fps
			Maximum Bit Rate: 100 Mbps
			Supported: Field Coding & MBAFF
	H.265/HEVC	Supported Image Size: 64 x 64 pixels to 4096 x 2304 pixels	
		Maximum Frame Rate: 2304p @ 60 fps	
		Maximum Bit Rate: 100 Mbps	
		Supported: Main Profile & Main10 Profile	
	.mp4	MPEG4	Supported Image Size: 48 x 48 pixels to 1920 x 1080 pixels
			Maximum Frame Rate: 30 fps
			Maximum Bit Rate: 38.4 Mbps
			Not supported: MS MPEG4 v1, v2, v3 & GMC
.mpg	MPEG-1/2	Supported Image Size: 48 x 48 pixels to 1920 x 1080 pixels	
		Maximum Frame Rate: 30 fps	
		Maximum Bit Rate: 80 Mbps	
		Supported: Field Coding	

Type	File Type	Codec	Ability
Video	.ts	H.264	Supported Image Size: 48 x 48 pixels to 4096 x 2304 pixels
			Maximum Frame Rate: 2304p @ 30 fps, 1080p @ 60 fps
			Maximum Bit Rate: 100 Mbps
			Supported: Field Coding & MBAFF
		H.265/HEVC	Supported Image Size: 64 x 64 pixels to 4096 x 2304 pixels
			Maximum Frame Rate: 2304p @ 60 fps
			Maximum Bit Rate: 100 Mbps
			Supported: Main Profile & Main10 Profile
	Supported: Tile & SLIC		
	.webm	VP8	Supported Image Size: 48 x 48 pixels to 1920 x 1080 pixels
			Maximum Frame Rate: 30 fps
			Maximum Bit Rate: 38.4 Mbps
		VP9	Supported Image Size: 48 x 48 pixels to 4096 x 2304 pixels
Maximum Frame Rate: 2304p @ 60 fps			
Maximum Bit Rate: 100 Mbps			
.m4v	AVC		

# Maintenance Tools

## LED Module Removal Tool

### Dimensions

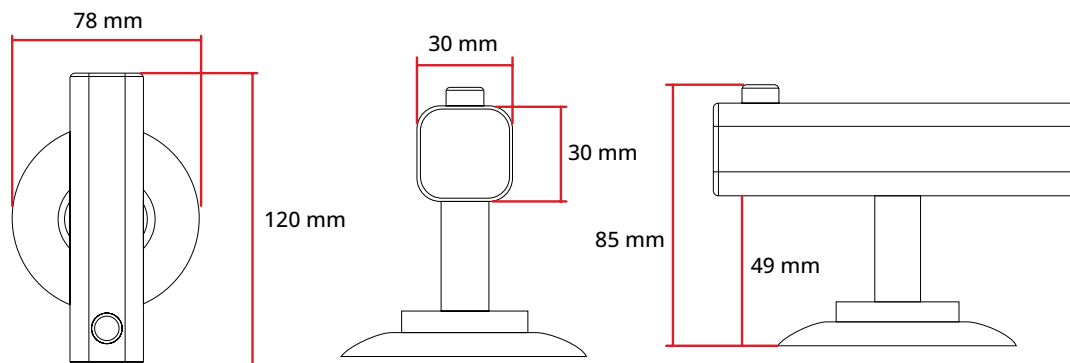

### Specifications

Item	Description
Model	LD-MK-006
Product Dimension (W x H x D)	120 x 87 x 80 mm
	4.7" x 3.4" x 3.2"
Weight	0.2 kg
	0.4 lb

# Troubleshooting

## General

Problem or Issue	Possible Solutions
Remote Control is not working	<ol style="list-style-type: none"><li>1. Check whether something is obstructing the display's remote control receiver.</li><li>2. Check whether the battery polarities in the remote control are installed correctly.</li><li>3. Check whether the batteries need to be replaced.</li></ol>
The unit turns off unexpectedly	<ol style="list-style-type: none"><li>1. Check whether Sleep mode is enabled.</li><li>2. Check if there is a power outage in your area.</li><li>3. Turn on the display, provide an active signal, and see if the problem is with the signal or external control system.</li><li>4. Check whether the flexible flat cables inside the cabinets are connected properly.</li></ol>
The power indicator is off, and there is no response	<ol style="list-style-type: none"><li>1. Ensure the power cable is connected and not loose.</li><li>2. Check that the power outlet is functioning properly and meets the required electrical requirement.</li></ol>
The display does not recognize the USB storage device	<ol style="list-style-type: none"><li>1. Ensure the drive is either formatted for FAT32 or NTFS.</li><li>2. If the USB storage device needs external power, connect its power adapter to an electrical outlet.</li></ol>

## Video Not Working Properly

Problem or Issue	Possible Solutions
No picture/No sound	<ol style="list-style-type: none"><li>1. Check the Power status.</li><li>2. Check the signal cable.</li><li>3. Use the remote control to ensure the input source setting is the same as the connected device.</li></ol>
Picture is unclear or cuts in and out	<ol style="list-style-type: none"><li>1. Check the signal cable.</li><li>2. Check if other electronics or different signal types are interrupting the signal.</li><li>3. An optional active video cable or optional video extender is required for a long distance source.</li></ol>
Poor picture	<ol style="list-style-type: none"><li>1. Adjust chroma and/or brightness settings in the menu.</li><li>2. Check the signal cable.</li><li>3. Use the display's native resolution for the source.</li></ol>

## Audio Not Working Properly

Problem or Issue	Possible Solutions
No sound	<ol style="list-style-type: none"><li>1. Adjust the volume.</li><li>2. Check the audio cable connection (if used).</li><li>3. If using a computer digital video with embedded audio, ensure the computer speakers are set to external speakers.</li></ol>
One speaker only	<ol style="list-style-type: none"><li>1. Check the left and right sound control panel settings of the computer or media player source.</li><li>2. Check the audio cable connection (if used).</li><li>3. Ensure the content has two audio channels and not mono.</li></ol>

# Maintenance

## General Precautions

- The LED lights used in the modules are susceptible to ESD (Electrostatic discharge). To prevent damage to the LED lights, do not touch them with bare hands or with conductive materials when handling.
- Wear anti-static gloves and wrist strap when installing and servicing the display.
- It is recommended to regularly inspect all installed components.
- Do not bring objects close to the ventilation holes of the display. Burns or personal injuries may occur if any body parts are brought too close.
- Be sure to power off and disconnect all cables before moving the display. Moving the display with its cables attached may damage the cables and thus cause fire or electric shock.
- Power off and disconnect the power plug from the wall outlet as a safety precaution before performing any type of cleaning or maintenance.

## Initial Operation

- If a new screen has been stowed for less than three months, it can be used at normal brightness during its first use.
- If a new screen has been stowed for more than three months, the brightness should be set at 30% for its first use and allowed to operate for two hours continuously. After two hours of use, power off for 30 minutes. The new screen is now ready for normal brightness usage.

## Front Panel Cleaning Instructions

- Use cool, compressed air to remove dust when the power is off. If the dust cannot be removed, the LED module should be replaced.
- Do not scratch and do not put pressure on the panel surface with fingers or any abrasive object.
- Do not use volatile substances such as sprays, solvents, or thinners.

## **Cabinet Cleaning Instructions**

- Do not allow water or detergent to come into contact with the surface of the display. If water or moisture gets inside the unit, a system malfunction or electrical shock may occur.
- Do not scratch and do not put pressure on the cabinet with any abrasive objects of any kind.
- Do not use volatile substances such as sprays, solvents, or thinners on the cabinet.
- Do not place anything made from rubber or PVC near the cabinet for any extended periods of time.

## **Regular Use**

- It is recommended to turn on the display at least once a month for more than eight hours. During a wet and rainy season, it is recommended to turn on the display at least once a week.
- Avoid using full white, full red, full blue, or full green content for an extended period to avoid excessive power usage thus affecting the LED lifespan.

# RS-232 Protocol

This document describes the hardware interface and software protocols of RS-232 interface communication between the ViewSonic LED Display and computers or other control units with RS-232 protocol.

## Description

### RS-232 Hardware Specification

ViewSonic RS-232 serial port on the lower left side:

1. Connector type: DB 9-Pin Female.
2. Use of straight-through parallel cable for connection
3. Pin Assignment:

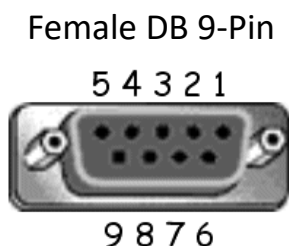

Pin #	Signal	Remark
1	NC	
2	RXD	Input to Display
3	TXD	Output from Display
4	NC	
5	GND	GND
6	NC	
7	NC	
8	NC	
9	NC	
frame	GND	

### RS-232 Communication Setting

- Baud Rate Select: 115200bps (fixed)
- Data bits: 8 bits (fixed)
- Parity: None (fixed)
- Stop Bits: 1 (fixed)

**Note:** Make sure the Control Board Switch is switched to the left for RS-232 control.

# Command Table

Set Function	Command	Description	Command	HEX	Data Range
Power on /off(standby)	s!21	000: STBY	801s!000	38 30 31 73 21 30 30 30 0D	
		001: ON	801s!001	38 30 31 73 21 30 30 31 0D	
Input Select	s"22	00A:HOME	801s"00A	38 30 31 73 22 30 30 33 0D	
		004: HDMI1	801s"004	38 30 31 73 22 30 30 34 0D	
		014: HDMI2	801s"014	38 30 31 73 22 30 31 34 0D	
		024: HDMI3	801s"024	38 30 31 73 22 30 32 34 0D	
		034: HDMI4	801s"034	38 30 31 73 22 30 33 34 0D	
Brightness	s\$24	000 ~ 100	801s\$XXX (XXX:000-100)	38 30 31 73 24 3X 3X 3X 0D	000-100
		900: Bright down (-1)	801s\$900	38 30 31 73 24 39 30 30 0D	
		901: Bright up (+1)	801s\$901	38 30 31 73 24 39 30 31 0D	
Volume	s535	000 ~ 100	801s5XXX (XXX:000-100)	38 30 31 73 35 3X 3X 3X 0D	000-100
		900: Volume down(-1)	801s5900	38 30 31 73 35 39 30 30 0D	
		901:Volume up(+1)	801s5901	38 30 31 73 35 39 30 31 0D	
Mute	s636	000: OFF	801s6000	38 30 31 73 36 30 30 30 0D	
		001: ON (mute)	801s6001	38 30 31 73 36 30 30 31 0D	

Set Function	Command	Description	Command	HEX	Data Range
Key Pad	sA41	000: UP	801sA000	38 30 31 73 41 30 30 30 0D	
		001: DOWN	801sA001	38 30 31 73 41 30 30 31 0D	
		002: LEFT	801sA002	38 30 31 73 41 30 30 32 0D	
		003: RIGHT	801sA003	38 30 31 73 41 30 30 33 0D	
		004: ENTER	801sA004	38 30 31 73 41 30 30 34 0D	
		005: INPUT	801sA005	38 30 31 73 41 30 30 35 0D	
		006: MENU/ (EXIT)	801sA006	38 30 31 73 41 30 30 36 0D	
		007: EXIT	801sA007	38 30 31 73 41 30 30 37 0D	
		008:power on/ off	801sA008	38 30 31 73 41 30 30 38 0D	
		009:input list	801sA009	38 30 31 73 41 30 30 39 0D	
		010:brightness	801sA010	38 30 31 73 41 30 31 30 0D	
		011:blank	801sA011	38 30 31 73 41 30 31 31 0D	
		012:home	801sA012	38 30 31 73 41 30 31 32 0D	
		013:volume+	801sA013	38 30 31 73 41 30 31 33 0D	
		014:volume-	801sA014	38 30 31 73 41 30 31 34 0D	
		015:next	801sA015	38 30 31 73 41 30 31 35 0D	
		016:previous	801sA016	38 30 31 73 41 30 31 36 0D	
		017:mute	801sA017	38 30 31 73 41 30 31 37 0D	
		018:play	801sA018	38 30 31 73 41 30 31 38 0D	
Restore default	s~7E	000	801s~000	38 30 31 73 7E 30 30 30 0D	
Input Select: Cycle	s"22	00Z	801s"00Z	38 30 31 73 22 30 30 5A 0D	
Contrast	s#23	000 ~ 100	801s#XXX (XXX:000-100)	38 30 31 73 23 3X 3X 3X 0D	000-100
Sharpness	s%25	000 ~ 100	801s%XXX (XXX:000-100)	38 30 31 73 25 3X 3X 3X 0D	000-100
Color	s&26	000 ~ 100	801s&XXX (XXX:000-100)	38 30 31 73 26 3X 3X 3X 0D	000-100

Set Function	Command	Description	Command	HEX	Data Range
Tint	s'27	000 ~ 100	801s'XXX (XXX:000-100)	38 30 31 73 27 3X 3X 3X 0D	000-100
Color mode	s)29	000: Normal	801s)000	38 30 31 73 29 30 30 30 0D	
		001: Warm	801s)001	38 30 31 73 29 30 30 31 0D	
		002: Cold	801s)002	38 30 31 73 29 30 30 32 0D	
		003: Personal	801s)003	38 30 31 73 29 30 30 33 0D	
OSD language	s232	000: English	801s2000	38 30 31 73 32 30 30 30 0D	
		001: French	801s2001	38 30 31 73 32 30 30 31 0D	
		002: Spanish	801s2002	38 30 31 73 32 30 30 32 0D	
		004: Russian	801s2004	38 30 31 73 32 30 30 34 0D	
		006: T-Chinese	801s2006	38 30 31 73 32 30 30 36 0D	
		007: S-Chinese	801s2007	38 30 31 73 32 30 30 37 0D	
		00A: Japanese	801s200A	38 30 31 73 32 30 30 41 0D	
		00B: Korean	801s200B	38 30 31 73 32 30 30 42 0D	
		00C: Italian	801s200C	38 30 31 73 32 30 30 43 0D	
Date: Year	sV56	Y17~Y99	801sVYXX (XX:17-99)	38 30 31 73 56 59 3X 3X 0D	17-99
Date: Month	sV56	M01~M12	801sVMXX (XX:01-12)	38 30 31 73 56 4D 3X 3X 0D	
Date: Day	sV56	D01~D31	801sVDXX (XX:01-31)	38 30 31 73 56 44 3X 3X 0D	
Time: Hour	sW57	H00~H23	801sWHXX (XX:00-23)	38 30 31 73 57 48 3X 3X 0D	
Time: Min	sW57	M00~M59	801sWMXX (XX:00-59)	38 30 31 73 57 4D 3X 3X 0D	
Time: Sec	sW57	S00~S59	801sWSXX (XX:00-59)	38 30 31 73 57 53 3X 3X 0D	
Get-Brightness	gb62		801gb000	38 30 31 67 62 30 30 30 0D	
Get-Volume	gf66		801gf000	38 30 31 67 66 30 30 30 0D	
Get-Mute	gg67		801gg000	38 30 31 67 67 30 30 30 0D	
Get-Input select	gj6A		801gj000	38 30 31 67 6A 30 30 30 0D	



# Regulatory and Service Information

## Compliance Information

This section addresses all connected requirements and statements regarding regulations. Confirmed corresponding applications shall refer to nameplate labels and relevant markings on the unit.

### FCC Compliance Statement

This device complies with part 15 of FCC Rules. Operation is subject to the following two conditions: (1) this device may not cause harmful interference, and (2) this device must accept any interference received, including interference that may cause undesired operation. This equipment has been tested and found to comply with the limits for a Class B digital device, pursuant to part 15 of the FCC Rules.

These limits are designed to provide reasonable protection against harmful interference in a residential installation. This equipment generates, uses, and can radiate radio frequency energy, and if not installed and used in accordance with the instructions, may cause harmful interference to radio communications. However, there is no guarantee that interference will not occur in a particular installation. If this equipment does cause harmful interference to radio or television reception, which can be determined by turning the equipment off and on, the user is encouraged to try to correct the interference by one or more of the following measures:

- Reorient or relocate the receiving antenna.
- Increase the separation between the equipment and receiver.
- Connect the equipment into an outlet on a circuit different from that to which the receiver is connected.
- Consult the dealer or an experienced radio/TV technician for help.

The antenna(s) used for this transmitter must not be collocated or operating in conjunction with any other antenna or transmitter.

## IC Warning Statement

This device complies with Industry Canada license- exempt RSS standard(s). Operation is subject to the following two conditions: (1) this device may not cause interference, and (2) this device must accept any interference, including interference that may cause undesired operation of the device.

Le présent appareil est conforme aux CNR d'Industrie Canada applicables aux appareils radio exempts de licence. L'exploitation est autorisée aux deux conditions suivantes : ( 1 ) l'appareil ne doit pas produire de brouillage, et ( 2 ) l'utilisateur de l'appareil doit accepter tout brouillage radioélectrique subi, même si le brouillage est susceptible d'en compromettre le fonctionnement.

## CE Conformity for European Countries

 The device complies with the EMC Directive 2014/30/EU, Low Voltage Directive 2014/35/EU.

### The following information is only for EU-member states:

The mark shown to the right is in compliance with the Waste Electrical and Electronic Equipment Directive 2012/19/EU (WEEE). The mark indicates the requirement NOT to dispose of the equipment as unsorted municipal waste, but use the return and collection systems according to local law.



## Declaration of RoHS2 Compliance

This product has been designed and manufactured in compliance with Directive 2011/65/EU of the European Parliament and the Council on restriction of the use of certain hazardous substances in electrical and electronic equipment (RoHS2 Directive) and is deemed to comply with the maximum concentration values issued by the European Technical Adaptation Committee (TAC) as shown below:

Substance	Proposed Maximum Concentration	Actual Concentration
Lead (Pb)	0.1%	< 0.1%
Mercury (Hg)	0.1%	< 0.1%
Cadmium (Cd)	0.01%	< 0.01%
Hexavalent Chromium (Cr6 <sup>+</sup> )	0.1%	< 0.1%
Polybrominated biphenyls (PBB)	0.1%	< 0.1%
Polybrominated diphenyl ethers (PBDE)	0.1%	< 0.1%
Bis (2-ethylhexyl) phthalate (DEHP)	0.1%	< 0.1%
Butyl benzyl phthalate (BBP)	0.1%	< 0.1%
Dibutyl phthalate (DBP)	0.1%	< 0.1%
Diisobutyl phthalate (DIBP)	0.1%	< 0.1%

**Certain components of products as stated above are exempted under the Annex III of the RoHS2 Directives as noted below. Examples of exempted components are:**

- Copper alloy containing up to 4% lead by weight.
- Lead in high melting temperature type solders (i.e. lead-based alloys containing 85% by weight or more lead).
- Electrical and electronic components containing lead in a glass or ceramic other than dielectric ceramic in capacitors, e.g. piezoelectronic devices, or in a glass or ceramic matrix compound.
- Lead in dielectric ceramic in capacitors for a rated voltage of 125V AC or 250V DC or higher.

## Indian Restriction of Hazardous Substances

Restriction on Hazardous Substances statement (India). This product complies with the “India E-waste Rule 2011” and prohibits use of lead, mercury, hexavalent chromium, polybrominated biphenyls or polybrominated diphenyl ethers in concentrations exceeding 0.1 weight % and 0.01 weight % for cadmium, except for the exemptions set in Schedule 2 of the Rule.

## Product Disposal at End of Product Life

ViewSonic® respects the environment and is committed to working and living green. Thank you for being part of Smarter, Greener Computing. Please visit the ViewSonic® website to learn more.

### USA & Canada:

<https://www.viewsonic.com/us/go-green-with-viewsonic>

### Europe:

<https://www.viewsonic.com/eu/environmental-social-governance/recycle>

### Taiwan:

<https://recycle.moenv.gov.tw/>

**For EU users, please contact us for any safety/accident issue experienced with this product:**

ViewSonic Europe Limited

 Haaksbergweg 75  
1101 BR Amsterdam  
Netherlands

 +31 (0) 650608655

 [EPREL@viewsoniceurope.com](mailto:EPREL@viewsoniceurope.com)

 <https://www.viewsonic.com/eu/>

## Copyright Information

Copyright© ViewSonic® Corporation, 2025. All rights reserved.

Macintosh and Power Macintosh are registered trademarks of Apple Inc.

Microsoft, Windows, and the Windows logo are registered trademarks of Microsoft Corporation in the United States and other countries.

ViewSonic® and the three birds logo are registered trademarks of ViewSonic® Corporation.

VESA is a registered trademark of the Video Electronics Standards Association. DPMS, DisplayPort, and DDC are trademarks of VESA.

**Disclaimer:** ViewSonic® Corporation shall not be liable for technical or editorial errors or omissions contained herein; nor for incidental or consequential damages resulting from furnishing this material, or the performance or use of this product.

In the interest of continuing product improvement, ViewSonic® Corporation reserves the right to change product specifications without notice. Information in this document may change without notice.

No part of this document may be copied, reproduced, or transmitted by any means, for any purpose without prior written permission from ViewSonic® Corporation.

## Customer Service

For technical support or product service, see the table below or contact your reseller.

**Note:** You will need the product's serial number.

Country/ Region	Website	Country/ Region	Website
<b>Asia Pacific &amp; Africa</b>			
Australia	<a href="http://www.viewsonic.com/au/">www.viewsonic.com/au/</a>	Bangladesh	<a href="http://www.viewsonic.com/bd/">www.viewsonic.com/bd/</a>
中国 (China)	<a href="http://www.viewsonic.com.cn">www.viewsonic.com.cn</a>	香港 (繁體中文)	<a href="http://www.viewsonic.com/hk/">www.viewsonic.com/hk/</a>
Hong Kong (English)	<a href="http://www.viewsonic.com/hk-en/">www.viewsonic.com/hk-en/</a>	India	<a href="http://www.viewsonic.com/in/">www.viewsonic.com/in/</a>
Indonesia	<a href="http://www.viewsonic.com/id/">www.viewsonic.com/id/</a>	Israel	<a href="http://www.viewsonic.com/il/">www.viewsonic.com/il/</a>
日本 (Japan)	<a href="http://www.viewsonic.com/jp/">www.viewsonic.com/jp/</a>	Korea	<a href="http://www.viewsonic.com/kr/">www.viewsonic.com/kr/</a>
Malaysia	<a href="http://www.viewsonic.com/my/">www.viewsonic.com/my/</a>	Middle East	<a href="http://www.viewsonic.com/me/">www.viewsonic.com/me/</a>
Myanmar	<a href="http://www.viewsonic.com/mm/">www.viewsonic.com/mm/</a>	Nepal	<a href="http://www.viewsonic.com/np/">www.viewsonic.com/np/</a>
New Zealand	<a href="http://www.viewsonic.com/nz/">www.viewsonic.com/nz/</a>	Pakistan	<a href="http://www.viewsonic.com/pk/">www.viewsonic.com/pk/</a>
Philippines	<a href="http://www.viewsonic.com/ph/">www.viewsonic.com/ph/</a>	Singapore	<a href="http://www.viewsonic.com/sg/">www.viewsonic.com/sg/</a>
臺灣 (Taiwan)	<a href="http://www.viewsonic.com/tw/">www.viewsonic.com/tw/</a>	ประเทศไทย	<a href="http://www.viewsonic.com/th/">www.viewsonic.com/th/</a>
Việt Nam	<a href="http://www.viewsonic.com/vn/">www.viewsonic.com/vn/</a>	South Africa & Mauritius	<a href="http://www.viewsonic.com/za/">www.viewsonic.com/za/</a>
<b>Americas</b>			
United States	<a href="http://www.viewsonic.com/us">www.viewsonic.com/us</a>	Canada	<a href="http://www.viewsonic.com/us">www.viewsonic.com/us</a>
Latin America	<a href="http://www.viewsonic.com/la">www.viewsonic.com/la</a>		
<b>Europe</b>			
Europe	<a href="http://www.viewsonic.com/eu/">www.viewsonic.com/eu/</a>	France	<a href="http://www.viewsonic.com/fr/">www.viewsonic.com/fr/</a>
Deutschland	<a href="http://www.viewsonic.com/de/">www.viewsonic.com/de/</a>	Қазақстан	<a href="http://www.viewsonic.com/kz/">www.viewsonic.com/kz/</a>
Россия	<a href="http://www.viewsonic.com/ru/">www.viewsonic.com/ru/</a>	España	<a href="http://www.viewsonic.com/es/">www.viewsonic.com/es/</a>
Türkiye	<a href="http://www.viewsonic.com/tr/">www.viewsonic.com/tr/</a>	Україна	<a href="http://www.viewsonic.com/ua/">www.viewsonic.com/ua/</a>
United Kingdom	<a href="http://www.viewsonic.com/uk/">www.viewsonic.com/uk/</a>		

## Limited Warranty

### ViewSonic® Commercial Display

#### What the warranty covers:

ViewSonic® warrants its products to be free from defects in material and workmanship during the warranty period. If a product proves to be defective in material or workmanship during the warranty period, ViewSonic® will, at its sole option, and as your sole remedy, repair or replace the product with a similar product. Replacement Product or parts may include remanufactured or refurbished parts or components. The repair or replacement unit or parts or components will be covered by the balance of the time remaining on the customer's original limited warranty and the warranty period will not be extended. ViewSonic® provides no warranty for any third-party software whether included with the product or installed by the customer, installation of any unauthorized hardware parts or components (e.g. Projector Lamps). (Please refer to: "What the warranty excludes and does not cover" section).

#### Who the warranty protects:

This warranty is valid only for the first consumer purchaser.

#### What the warranty excludes and does not cover:

- Any product on which the serial number has been defaced, modified, or removed.
- Damage, deterioration, or malfunction resulting from:
  - » Accident, misuse, neglect, fire, water, lightning, or other acts of nature, unauthorized product modification, or failure to follow instructions supplied with the product.
  - » Repair or attempted repair by anyone not authorized by ViewSonic®.
  - » Damage to or loss of any programs, data, or removable storage media.
  - » Normal wear and tear.
  - » Removal or installation of the product.
- Software or data loss occurring during repair or replacement.
- Any damage of the product due to shipment.
- Causes external to the product, such as electric power fluctuations or failure.
- Use of supplies or parts not meeting ViewSonic's specifications.
- Failure of owner to perform periodic product maintenance as stated in the User Guide.

- Any other cause which does not relate to a product defect.
- Damage caused by static (non-moving) images displayed for lengthy periods of time (also referred to as image burn-in).
- Software - Any third-party software included with the product or installed by the customer.
- Hardware/Accessories/Parts/Components – Installation of any unauthorized hardware, accessories, consumable parts or components (e.g. Projector Lamps).
- Damage to, or abuse of, the coating on the surface of the display through inappropriate cleaning as described in the product User Guide.
- Removal, installation, and set-up service charges, including wall-mounting of the product.

### **How to get service:**

- For information about receiving service under warranty, contact ViewSonic® Customer Support (Please refer to the “Customer Service” page). You will need to provide your product’s serial number.
- To obtain warranty service, you will be required to provide: (a) the original dated sales slip, (b) your name, (c) your address, (d) a description of the problem, and (e) the serial number of the product.
- Take or ship the product, freight prepaid, in the original container to an authorized ViewSonic® service center or ViewSonic®.
- For additional information or the name of the nearest ViewSonic® service center, contact ViewSonic®.

### **Limitation of implied warranties:**

There are no warranties, express or implied, which extend beyond the description contained herein including the implied warranty of merchantability and fitness for a particular purpose.

**Exclusion of damages:**

ViewSonic's liability is limited to the cost of repair or replacement of the product. ViewSonic® shall not be liable for:

- Damage to other property caused by any defects in the product, damages based upon inconvenience, loss of use of the product, loss of time, loss of profits, loss of business opportunity, loss of goodwill, interference with business relationships, or other commercial loss, even if advised of the possibility of such damages.
- Any other damages, whether incidental, consequential or otherwise.
- Any claim against the customer by any other party.
- Repair or attempted repair by anyone not authorized by ViewSonic®.

**Effect of state law:**

This warranty gives you specific legal rights, and you may also have other rights which vary from state to state. Some states do not allow limitations on implied warranties and/or do not allow the exclusion of incidental or consequential damages, so the above limitations and exclusions may not apply to you.

**Sales outside the U.S.A. and Canada:**

For warranty information and service on ViewSonic® products sold outside of the U.S.A. and Canada, contact ViewSonic® or your local ViewSonic® dealer.

The warranty period for this product in mainland China (Hong Kong, Macao, and Taiwan Excluded) is subject to the terms and conditions of the Maintenance Guarantee Card.

For users in Europe and Russia, full details of warranty provided can be found at: <http://www.viewsonic.com/eu/> under "Support/Warranty Information".

## **Mexico Limited Warranty**

### ViewSonic® Commercial Display

#### **What the warranty covers:**

ViewSonic® warrants its products to be free from defects in material and workmanship, under normal use, during the warranty period. If a product proves to be defective in material or workmanship during the warranty period, ViewSonic® will, at its sole option, repair or replace the product with a like product. Replacement product or parts may include remanufactured or refurbished parts or components & accessories.

#### **Who the warranty protects:**

This warranty is valid only for the first consumer purchaser.

#### **What the warranty excludes and does not cover:**

- Any product on which the serial number has been defaced, modified or removed.
- Damage, deterioration, or malfunction resulting from:
  - » Accident, misuse, neglect, fire, water, lightning, or other acts of nature, unauthorized product modification, unauthorized attempted repair, or failure to follow instructions supplied with the product.
  - » Causes external to the product, such as electrical power fluctuations or failure.
  - » Use of supplies or parts not meeting ViewSonic®'s specifications.
  - » Normal wear and tear.
  - » Any other cause which does not relate to a product defect.
- Any product exhibiting a condition commonly known as “image burn-in” which results when a static image is displayed on the product for an extended period of time.
- Removal, installation, insurance, and set-up service charges.

**How to get service:**

For information about receiving service under warranty, contact ViewSonic® Customer Support (Please refer to the attached “Customer Service” page). You will need to provide your product’s serial number, so please record the product information in the space provided below on your purchase for your future use. Please retain your receipt of proof of purchase to support your warranty claim.

**For Your Records**

Product Name: \_\_\_\_\_ Model Number: \_\_\_\_\_  
Document Number: \_\_\_\_\_ Serial Number: \_\_\_\_\_  
Purchase Date: \_\_\_\_\_ Extended Warranty Purchase? \_\_\_\_\_(Y/N)  
If so, what date does warranty expire? \_\_\_\_\_

- To obtain warranty service, you will be required to provide (a) the original dated sales slip, (b) your name, (c) your address, (d) a description of the problem, and (e) the serial number of the product.
- Take or ship the product, in the original container packaging, to an authorized ViewSonic® service center.
- Round trip transportation costs for in-warranty products will be paid by ViewSonic®.

**Limitation of implied warranties:**

There are no warranties, express or implied, which extend beyond the description contained herein including the implied warranty of merchantability and fitness for a particular purpose.

**Exclusion of damages:**

ViewSonic®’s liability is limited to the cost of repair or replacement of the product. ViewSonic® shall not be liable for:

- Damage to other property caused by any defects in the product, damages based upon inconvenience, loss of use of the product, loss of time, loss of profits, loss of business opportunity, loss of goodwill, interference with business relationships, or other commercial loss, even if advised of the possibility of such damages.
- Any other damages, whether incidental, consequential or otherwise.
- Any claim against the customer by any other party.
- Repair or attempted repair by anyone not authorized by ViewSonic®.

Contact Information for Sales & Authorized Service (Centro Autorizado de Servicio) within Mexico:	
<p align="center"><b>Name, address, of manufacturer and importers:</b>  México, Av. de la Palma #8 Piso 2 Despacho 203, Corporativo Interpalmas,  Col. San Fernando Huixquilucan, Estado de México  Tel: (55) 3605-1099 <a href="http://www.viewsonic.com/la/soporte/index.htm">http://www.viewsonic.com/la/soporte/index.htm</a></p>	
NÚMERO GRATIS DE ASISTENCIA TÉCNICA PARA TODO MÉXICO: 001.866.823.2004	
<p align="center"><b>Hermosillo:</b>  Distribuciones y Servicios Computacionales SA de CV.  Calle Juarez 284 local 2  Col. Bugambilias C.P: 83140  Tel: 01-66-22-14-9005  E-Mail: <a href="mailto:disc2@hmo.megared.net.mx">disc2@hmo.megared.net.mx</a></p>	<p align="center"><b>Villahermosa:</b>  Compumantenimietnos Garantizados, S.A. de C.V.  AV. GREGORIO MENDEZ #1504  COL, FLORIDA C.P. 86040  Tel: 01 (993) 3 52 00 47 / 3522074 / 3 52 20 09  E-Mail: <a href="mailto:compumantenimientos@prodigy.net.mx">compumantenimientos@prodigy.net.mx</a></p>
<p align="center"><b>Puebla, Pue. (Matriz):</b>  RENTA Y DATOS, S.A. DE C.V. Domicilio:  29 SUR 721 COL. LA PAZ  72160 PUEBLA, PUE.  Tel: 01(52).222.891.55.77 CON 10 LINEAS  E-Mail: <a href="mailto:datos@puebla.megared.net.mx">datos@puebla.megared.net.mx</a></p>	<p align="center"><b>Veracruz, Ver.:</b>  CONEXION Y DESARROLLO, S.A DE C.V. Av.  Americas # 419  ENTRE PINZÓN Y ALVARADO  Fracc. Reforma C.P. 91919  Tel: 01-22-91-00-31-67  E-Mail: <a href="mailto:gacosta@qplus.com.mx">gacosta@qplus.com.mx</a></p>
<p align="center"><b>Chihuahua:</b>  Soluciones Globales en Computación  C. Magisterio # 3321 Col. Magisterial  Chihuahua, Chih.  Tel: 4136954  E-Mail: <a href="mailto:Cefeo@soluglobales.com">Cefeo@soluglobales.com</a></p>	<p align="center"><b>Cuernavaca:</b>  Compusupport de Cuernavaca SA de CV  Francisco Leyva # 178 Col. Miguel Hidalgo  C.P. 62040, Cuernavaca Morelos  Tel: 01 777 3180579 / 01 777 3124014  E-Mail: <a href="mailto:aquevedo@compusupportcva.com">aquevedo@compusupportcva.com</a></p>
<p align="center"><b>Distrito Federal:</b>  QPLUS, S.A. de C.V.  Av. Coyoacán 931  Col. Del Valle 03100, México, D.F.  Tel: 01(52)55-50-00-27-35  E-Mail : <a href="mailto:gacosta@qplus.com.mx">gacosta@qplus.com.mx</a></p>	<p align="center"><b>Guadalajara, Jal.:</b>  SERVICRECE, S.A. de C.V.  Av. Niños Héroes # 2281  Col. Arcos Sur, Sector Juárez  44170, Guadalajara, Jalisco  Tel: 01(52)33-36-15-15-43  E-Mail: <a href="mailto:mmiranda@servicrece.com">mmiranda@servicrece.com</a></p>
<p align="center"><b>Guerrero Acapulco:</b>  GS Computación (Grupo Sesicomp)  Progreso #6-A, Colo Centro  39300 Acapulco, Guerrero  Tel: 744-48-32627</p>	<p align="center"><b>Monterrey:</b>  Global Product Services  Mar Caribe # 1987, Esquina con Golfo Pérsico  Fracc. Bernardo Reyes, CP 64280  Monterrey N.L. México  Tel: 8129-5103  E-Mail: <a href="mailto:aydeem@gps1.com.mx">aydeem@gps1.com.mx</a></p>
<p align="center"><b>MERIDA:</b>  ELECTROSER  Av Reforma No. 403Gx39 y 41  Mérida, Yucatán, México CP97000  Tel: (52) 999-925-1916  E-Mail: <a href="mailto:rrrb@sureste.com">rrrb@sureste.com</a></p>	<p align="center"><b>Oaxaca, Oax.:</b>  CENTRO DE DISTRIBUCION Y  SERVICIO, S.A. de C.V.  Murguía # 708 P.A., Col. Centro, 68000, Oaxaca  Tel: 01(52)95-15-15-22-22  Fax: 01(52)95-15-13-67-00  E-Mail: <a href="mailto:gpotai2001@hotmail.com">gpotai2001@hotmail.com</a></p>
<p align="center"><b>Tijuana:</b>  STD  Av Ferrocarril Sonora #3780 L-C  Col 20 de Noviembr  Tijuana, Mexico</p>	<p align="center"><b>FOR USA SUPPORT:</b>  ViewSonic® Corporation  381 Brea Canyon Road, Walnut, CA. 91789 USA  Tel: 800-688-6688  E-Mail: <a href="http://www.viewsonic.com">http://www.viewsonic.com</a></p>



**ViewSonic®**