

1.2.51.32.23433-000

Eyeball Network Camera

Installation Guide

V1.0.1

EXAMPLE

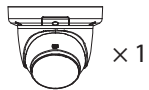

× 1



× 1



× 2



× 1



× 1



× 1

(Optional)



× 1



× 1

1

Optional



1

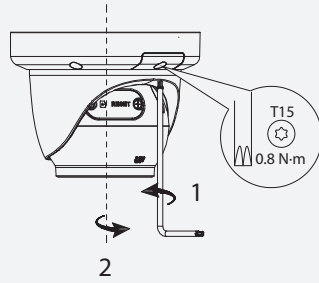

2

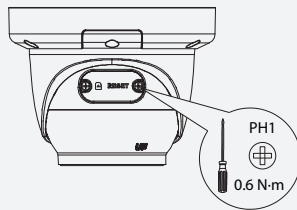

3

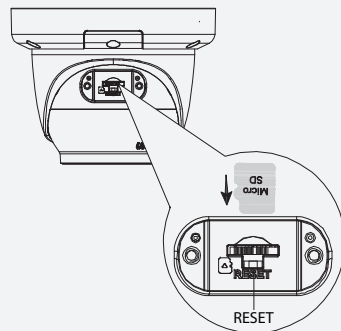

2



1

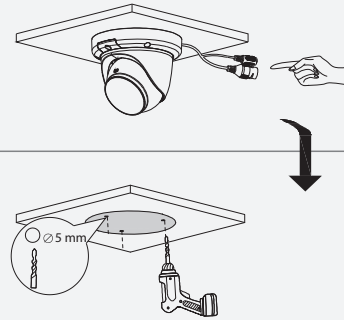

2

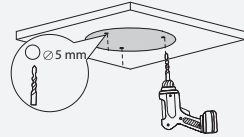

3

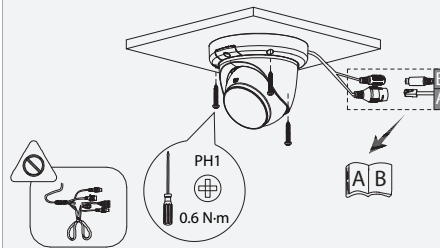

4

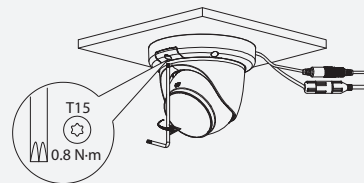

5

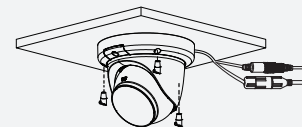

1

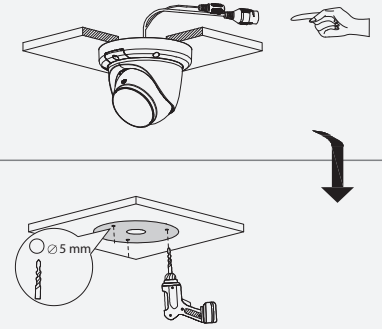

2

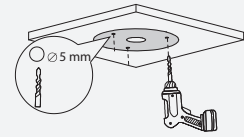

3

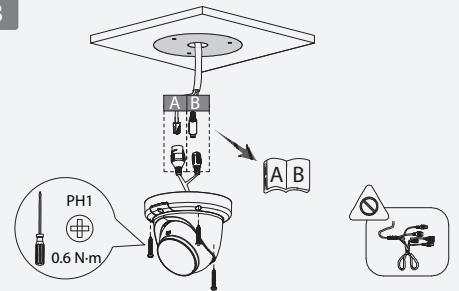

4

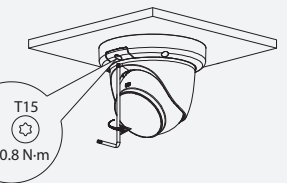

5

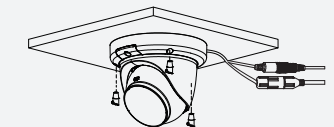

A Optional

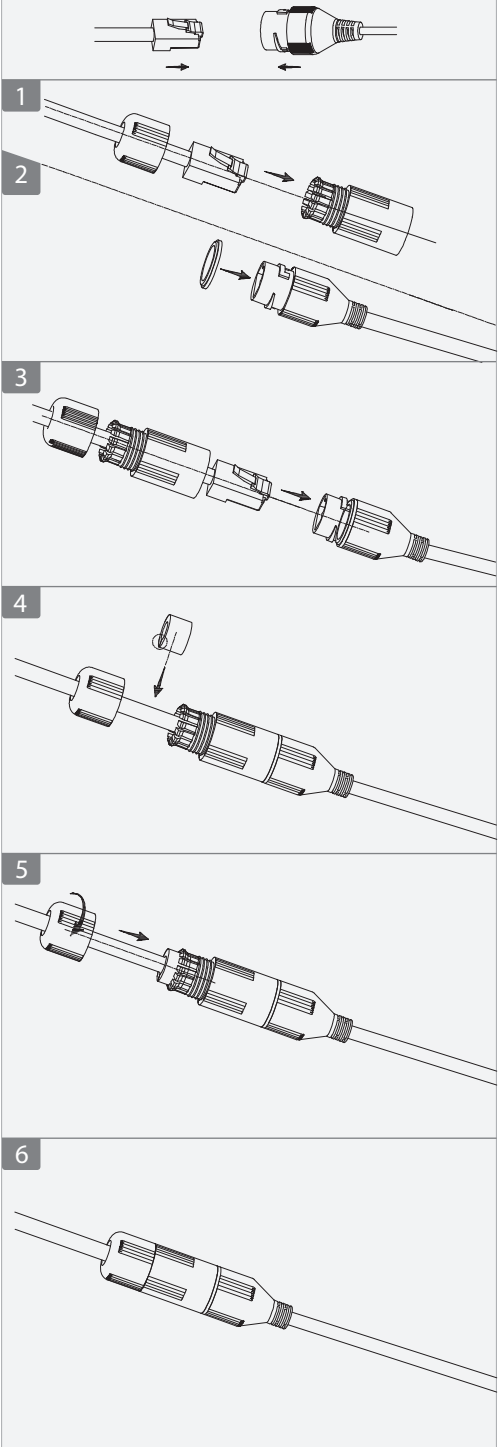

B

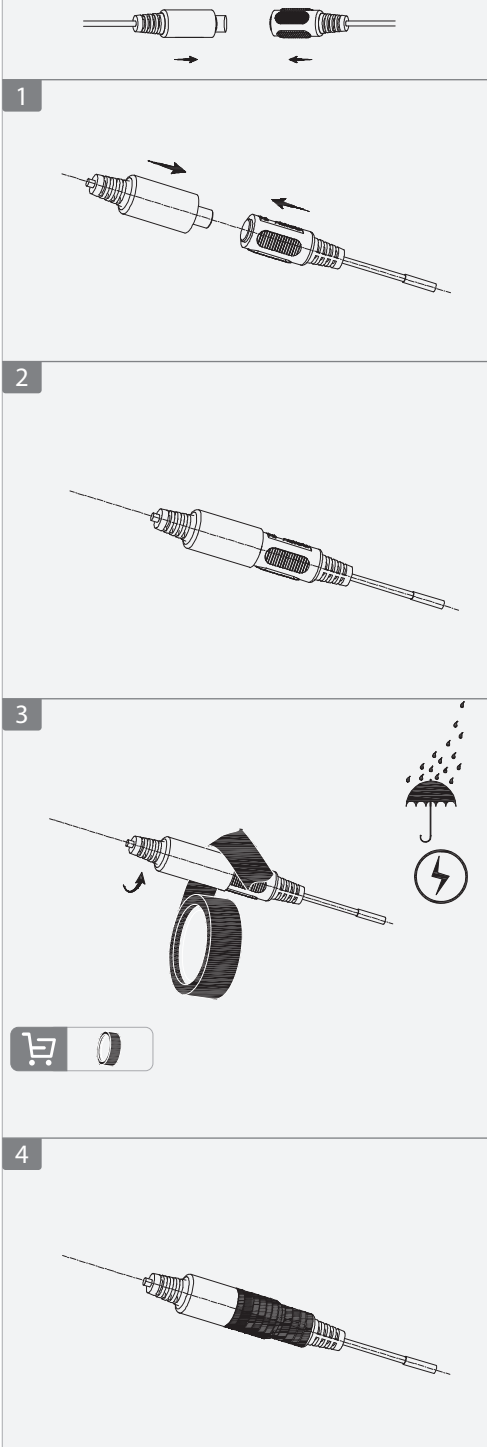

3

