

USER MANUAL

ProLite

LCD Monitor

ENGLISH

ProLite XB2797QSNP
ProLite XB2797QSNPH

Thank you very much for choosing the iiyama LCD monitor.

We recommend that you take a few minutes to read this comprehensive manual carefully before installing and switching on the monitor. Please keep this manual in a safe place for your future reference.



Dear user, we congratulate you on the purchase of your iiyama LCD.

For details on warranty and locally used pixel policies that apply directly after installation of your product please check the iiyama website.

To report a fault, please contact your local support centre found at <https://iiyama.com>

Things to check before you call the iiyama information line

- | if the power cable is connected securely and turned on?
- | if the display has been turned on?
- | if the signal cable is connected securely and the correct input selected?
- | if the computer has been restarted with the display connected?
- | if the graphics card is correctly installed with the latest drivers possible?
- | if the correct native resolution has been selected via 'Display Properties'?
- | If the R/G/B signal configuration is correct?
- | if the displays On Screen Menu is shown?
- | if the correct brightness and contrast settings have been set?
- | if given display tolerances and compatibility have been considered?
- | if via the On Screen Menu you have performed a Factory Reset/Recall?

Before reporting the screen defect, please prepare the following information/evidence:

- | model number *
- | purchase receipt and serial number *
- | name and address for collection
- | telephone/fax number, for availability during the day
- | convenient collection date (date, time)
- | short description of the defect

Important Note:

If there is no fault found in the collected equipment after inspection, the transferring party shall incur charges for transport and administration.

If you have checked all of the above and there is still no picture, call our information line for assistance in your country.

Feedback on health and safety issues

If you have any health and safety concerns or questions about the product (including when using the product), please contact iiyama support through our website. You can also contact us by calling +31 204460404. After receiving your feedback, we will ask the responsible unit to handle it as soon as possible and a dedicated person will get back to you. Your feedback will also be recorded and incorporated into our evaluation for improvements

* see the identification plate on the back of the case.

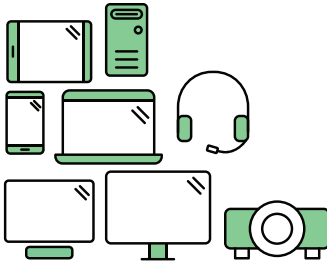

Say hello to a more sustainable product

IT products are associated with a wide range of sustainability risks throughout their life cycle. Human rights violations are common in the factories. Harmful substances are used both in products and their manufacture. Products can often have a short lifespan because of poor ergonomics, low quality and when they are not able to be repaired or upgraded.

This product is a better choice. It meets all the criteria in TCO Certified, the world's most comprehensive sustainability certification for IT products. Thank you for making a responsible product choice, that help drive progress towards a more sustainable future!

Criteria in TCO Certified have a life-cycle perspective and balance environmental and social responsibility. Conformity is verified by independent and approved verifiers that specialize in IT products, social responsibility or other sustainability issues. Verification is done both before and after the certificate is issued, covering the entire validity period. The process also includes ensuring that corrective actions are implemented in all cases of factory non-conformities. And last but not least, to make sure that the certification and independent verification is accurate, both TCO Certified and the verifiers are reviewed regularly.

Want to know more?

Read information about TCO Certified, full criteria documents, news and updates at [tcocertified.com](https://www.tcocertified.com). On the website you'll also find our Product Finder, which presents a complete, searchable listing of certified products.

CE MARKING DECLARATION OF CONFORMITY

This LCD monitor complies with the requirements of the EC/EU Directive 2014/30/EU "EMC Directive", 2014/35/EU "Low Voltage Directive", 2009/125/EC "ErP Directive" and 2011/65/EU "RoHS Directive".

The electro-magnetic susceptibility has been chosen at a level that gives correct operation in residential areas, business and light industrial premises and small-scale enterprises, inside as well as outside of the buildings. All places of operation are characterised by their connection to the public low voltage power supply system.

IYAMA CORPORATION: Taurusavenue 187, 2132 LS Hoofddorp, The Netherlands

Model No. : PL2797QC

Decreasing the blue light emitted by the monitor reduces the blue light exposure to your eyes.

This monitor uses a low blue light panel default setting mode, that when used in the default setting mode, is certified by TÜV to reduce blue light output and create a more relaxing and less stimulating image while reading content on the screen.

Health recommendations:

Looking at something varying distances after a long period focusing on the screen. Conscious Blinking often while you work. Gently closing and rolling your eyes to relax.

Reposition your screen to appropriate height and angle according to your height. Adjusting the brightness and contrast to appropriate level. Adjusting the environment lighting like that of your screen brightness, avoid the fluorescent lighting, and surfaces that don't reflect too much light. Seeing a doctor if your symp-toms.



We recommend recycling of used product. Please contact your dealer or iiyama service center. Recycle information is obtained via the Internet, using the address: <https://iiyama.com>

You can access the Web page of different countries from there.

- We reserve the right to change specifications without notice.
- All trademarks used in this user manual are the property of their respective owners.
- Eprel registration number: XB2797QSNP-B1 : 2547822, XB2797QSNP-W1 : 2547953,

XB2797QSNPH-B1 : 2611656

TABLE OF CONTENTS

FOR YOUR SAFETY.....	1
SAFETY PRECAUTIONS.....	1
SPECIAL NOTES ON LCD MONITORS.....	3
CUSTOMER SERVICE.....	3
CLEANING.....	4
BEFORE YOU OPERATE THE MONITOR.....	5
FEATURES.....	5
CHECKING THE CONTENTS OF THE PACKAGE.....	5
USING ARM OR STAND.....	6
FITTING AND REMOVAL OF STAND.....	8
CONTROLS AND CONNECTORS : ProLite XB2797QSNP.....	10
CONTROLS AND CONNECTORS : ProLite XB2797QSNPH.....	11
CONNECTING YOUR MONITOR.....	12
DISCONNECTING YOUR MONITOR.....	14
COMPUTER SETTING.....	14
ADJUSTING THE HEIGHT AND THE VIEWING ANGLER.....	14
OPERATING THE MONITOR.....	15
MENU CONTENTS.....	16
STANDBY FEATURE.....	27
TROUBLE SHOOTING.....	28
RECYCLING INFORMATION.....	29
APPENDIX.....	30
SPECIFICATIONS : ProLite XB2797QSNP-B1 / W1.....	30
SPECIFICATIONS : ProLite XB2797QSNPH-B1.....	31
DIMENSIONS : ProLite XB2797QSNP.....	32
DIMENSIONS : ProLite XB2797QSNPH.....	32
COMPLIANT TIMING.....	33

FOR YOUR SAFETY

SAFETY PRECAUTIONS

WARNING

STOP OPERATING THE MONITOR WHEN YOU SENSE TROUBLE

If you notice any abnormal phenomena such as smoke, strange sounds or fumes, unplug the monitor and contact your dealer or iiyama service center immediately. Further use may be dangerous and can cause fire or electric shock.

NEVER REMOVE THE CABINET

High voltage circuits are inside the monitor. Removing the cabinet may expose you to the danger of fire or electric shock.

DO NOT PUT ANY OBJECT INTO THE MONITOR

Do not put any solid objects or liquids such as water into the monitor. In case of an accident, unplug your monitor immediately and contact your dealer or iiyama service center. Using the monitor with any object inside may cause fire, electric shock or damage.

INSTALL THE MONITOR ON A FLAT, STABLE SURFACE

The monitor may cause an injury if it falls or is dropped.

DO NOT USE THE MONITOR NEAR WATER

Do not use where water may be splashed or spilt onto the monitor as it may cause fire or electric shock.

OPERATE UNDER THE SPECIFIED POWER SUPPLY

Be sure to operate the monitor only with the specified power supply. Use of an incorrect voltage will cause malfunction and may cause fire or electric shock.

PROTECT THE CABLES

Do not pull or bend the power cable and signal cable. Do not place the monitor or any other heavy objects on the cables. If damaged, the cables may cause fire or electric shock.

ADVERSE WEATHER CONDITIONS

It is advisable not to operate the monitor during a heavy thunder storm as the continual breaks in power may cause malfunction. It is also advised not to touch the plug in these circumstances as it may cause electric shock.

CAUTION

INSTALLATION LOCATION

Do not install the monitor where sudden temperature changes may occur, or in humid, dusty or smoky areas as it may cause fire, electric shock or damage. You should also avoid areas where the sun shines directly on the monitor.

DO NOT PLACE THE MONITOR IN A HAZARDOUS POSITION

The monitor may topple and cause injury if not suitably located. Please also ensure that you do not place any heavy objects on the monitor, and that all cables are routed such that children may not pull the cables and possibly cause injury.

CAUTION

MAINTAIN GOOD VENTILATION

Ventilation slots are provided to keep the monitor from overheating. Covering the slots may cause fire. To allow adequate air circulation, place the monitor at least 10cm (or 4 inches) from any walls. When removing the tilt stand, the ventilation slots on the back side of the monitor can be blocked. This may overheat the monitor and may cause fire or damage. Make sure to allow enough ventilation when removing the tilt stand. Operating the monitor on its back, side, upside down or on a carpet or any other soft material may also cause damage.

DISCONNECT THE CABLES WHEN YOU MOVE THE MONITOR

When you move the monitor, turn off the power switch, unplug the monitor and be sure the signal cable is disconnected. If you do not disconnect them, it may cause fire or electric shock.

UNPLUG THE MONITOR

If the monitor is not in use for a long period of time it is recommended that it is left unplugged to avoid accidents.

HOLD THE PLUG WHEN DISCONNECTING

To disconnect the power cable or signal cable, always pull it by the plug. Never pull on the cable itself as this may cause fire or electric shock.

DO NOT TOUCH THE PLUG WITH WET HANDS

Pulling or inserting the plug with wet hands may cause electric shock.

WHEN YOU INSTALL THE MONITOR ON YOUR COMPUTER

Be sure the computer is strong enough to hold the weight of the monitor, otherwise, you may damage your computer.

CAREFUL! PROTECT YOUR HANDS AND FINGERS

- Be careful not to hurt your fingers or hands when you change the height or the angle.
- Injury can occur if care is not taken to avoid finger contact with the displays base when adjusting the height. (Just for height adjustable model.)

REMARK FOR 24/7 USAGE

This product is not specifically designed for 24/7 usage in all environments.

REMARK SPECIFIC TO DESKTOP USE

This product is designed for desktop use, not for digital signage (electronic signboard) applications such as ceiling hanging or wall mounting.

DO NOT TILT THE MONITOR DOWNWARD TOO FAR

To avoid potential screen damage such as LCD panel peeling from the bezel, ensure that the monitor does not tilt downward beyond its adjustable range.

DO NOT USE ALCOHOL OR DISINFECTANTS ON THE MONITOR

Do not spray alcohol or disinfectants directly onto the monitor or use them near the monitor. Also, do not wipe the monitor with a cloth or sheet that contains alcohol or disinfectants. These may cause discoloration, deterioration, or cracking of the cabinet, damage to the surface treatment of the LCD panel, and deterioration of components.

OTHERS

ERGONOMIC RECOMMENDATIONS

To reduce the risk of eye strain and neck, arm, back, or shoulder pain from using the monitor for long period, we recommend you to:

Do not operate the monitor against a bright background or in a dark room.

For optimal viewing comfort, the monitor should be just below eye level and 50-70 cm (20-28 inches) away from your eyes.

Blink frequently to moisten your eyes or wet your eyes with water after prolonged usage of the monitor. When using the monitor over a prolonged time, a ten minute break every hour is recommended as looking at the screen continuously can cause eye strain.

Look away from your monitor and gaze at a distant object that is 20 feet away for at least 20 seconds during the breaks. Perform stretches to relieve tension in the neck, arm, back, and shoulders during the breaks.

- Adjust the tilt of the monitor, its contrast, and brightness settings.
- Adjust the ambient lighting around you (such as overhead lights, desk lamps, and the curtains or blinds on nearby windows) to minimize reflections and glare on the monitor screen.

SPECIAL NOTES ON LCD MONITORS

The following symptoms are normal with LCD monitors and do not indicate a problem.

NOTE

- When you first turn on the LCD monitor, the picture may not fit in the display area because of the type of computer that is used. In this case, adjust the picture position to the correct position.
- You may find slightly uneven brightness on the screen depending on the desktop pattern you use.
- Due to the nature of the LCD screen, an afterimage of the previous screen may remain after switching the image, when the same image is displayed for hours. In this case, the screen can be recovered slowly by changing the image or turning off the Power Switch for some hours.

CUSTOMER SERVICE

NOTE

- If you have to return your unit for service and the original packaging has been discarded, please contact your dealer or iiyama service center for advice or replacement packaging.

CLEANING

WARNING

- If you drop any materials or liquids such as water into the monitor when cleaning, unplug the power cable immediately and contact your dealer or iiyama service center.
- For safety reasons, turn off the power switch and unplug the monitor before you clean it.

CAUTION

- Do not spray alcohol or disinfectants directly onto the monitor or use them near the monitor. Also, do not wipe the monitor with a cloth or sheet that contains alcohol or disinfectants. These may cause discoloration, deterioration, or cracking of the cabinet, damage to the surface treatment of the LCD panel, and deterioration of components.
- To avoid potential damage on the monitor (LCD panel / cabinet / connector terminals) or accessories, never use the following strong solvents or cleaning sheets. These may cause discoloration, deterioration, or cracking of the cabinet, damage to the surface treatment of the LCD panel, and deterioration of components.

Benzine	Hypochlorous acid water	
Thinner	Acidic or alkaline solvents	
Alcohol	Wax	
Bleach	Abrasives	
Peroxide	Office equipment cleaner	
Acetone	Glass cleaner	
Methylene chloride	Tissue paper	
Toluene	Wet tissue	
Ammonia	Chemical cloth	
Sodium hypochlorite solution (Chlorine bleach)	Cleaning paper	etc.

NOTE

- To protect the LCD panel, do not scratch or rub the screen with a hard object.
- Do not leave the LCD panel wet. If water droplets or the like get on it, immediately wipe it off with a dry, soft cloth. Leaving it on may cause discoloration or stains on the LCD panel. In addition, if moisture gets inside the monitor, it may cause damage.
- Touching the cabinet with any product made from rubber or plastic for a long time may cause degeneration or loss of paint on the cabinet.

Regular care

Gently wipe the cabinet with a soft, dry and clean cloth. If your monitor is particularly dirty, soak the cloth in a mild detergent thoroughly diluted with water, wring it out tightly, and then wipe the dirt off. Then immediately wipe it with a soft, dry cloth.

Alcohol disinfection

Alcohol disinfection may cause discoloration, deterioration, or cracking of the cabinet, damage to the surface treatment of the LCD panel, and deterioration of components. Instead, we recommend disinfecting your hands away from the monitor before and after use.

If you absolutely must disinfect the monitor with alcohol, please understand above warnings and cautions in advance. Also, avoid frequent alcohol disinfection.

BEFORE YOU OPERATE THE MONITOR

FEATURES

- ◆ Supports Resolutions up to 2560 × 1440
- ◆ High Contrast 1000:1 (Typical), Adv. Contrast Function Available
- ◆ Brightness 350cd/m² (Typical)
- ◆ Moving Picture Response Time 1ms
- ◆ USB Type-C / RJ45 / DP Out Connectors
- ◆ USB Power Delivery Supports up to 96W
- ◆ KVM Feature
- ◆ Blue Light Reduce
- ◆ Flicker Free*
- ◆ Eye Comfort*
- ◆ Ergonomic Design : TCO Certified
- ◆ Digital Character Smoothing
- ◆ 2 × 2W Stereo Speakers
- ◆ Windows Hello-compatible Webcam : ProLite XB2797QSNPH
- ◆ Standby Feature
- ◆ VESA Mounting Standard (100mm×100mm) Compliant
- ◆ Keyhole for Security Lock

* This monitor uses a low blue light panel. When the monitor is reset to factory settings or default setting, it is in compliance with TÜV Rheinland's hardware low blue light certification. The monitor adopts Flicker-Free technology, which clears the eye visible flicker, brings comfort viewing experience and preventing users suffer from eye strain and fatigue.

CHECKING THE CONTENTS OF THE PACKAGE

The following accessories are included in your package. Check to see if they are enclosed with the monitor. If anything is missing or damaged, please contact your local iiyama dealer or regional iiyama office.

- | | | |
|-----------------------------|-----------------------------|---------------------------|
| ■ Power Cable* ¹ | ■ HDMI Cable | ■ USB Cable (A-B) |
| ■ USB Cable (C-C) | ■ Stand-Neck | ■ Stand-Base with a screw |
| ■ VESA Plate | ■ Screwdriver* ² | ■ Safety Guide |
| ■ Quick Start Guide | | |

CAUTION

*¹ All guarantees and warranties are void for any problems or damage caused by a power cable not supplied by iiyama.

An approved power cable greater or equal to H05VVf, 3G, 0.75mm² must be used.

*² Located on the back of the VESA Plate.

USING ARM OR STAND

CAUTION

- This product is designed for desktop use, not for digital signage (electronic signboard) applications such as ceiling hanging or wall mounting.
- Before installation, make sure the display arm or desk arm stand is strong enough to hold the necessary weight of the monitor and the mount.
- The monitor angle should be within 23° upward and 5° downward. This product cannot be used facing upward or downward beyond this range.
- If the monitor is used (installed) at an angle more than 5° downward, the LCD may peel off from the bezel and fall, resulting in damage. In addition, such cases will not be covered by support or warranty.
- Regularly check the tightness of the screws. If the screws are not tight enough, the monitor may come off and cause injury or damage.

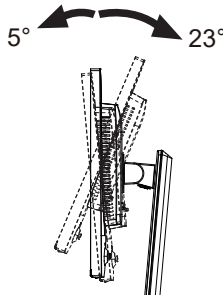

[DISPLAY ARM OR DESK ARM STAND]

CAUTION

- When using a display arm or desk arm stand, consider the thickness of the VESA mounting bracket and use four M4 \times 10mm screws to secure it to the monitor. Ensure all screws are tightened and secured properly. Using screws longer than this may cause electric shock or damage by contacting the electrical parts inside the monitor.

For this product, the thickness of the VESA mounting bracket is assumed to be approx. 2.5mm.

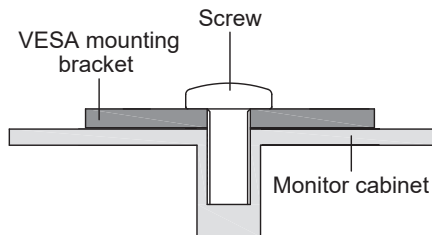

[ROTATING THE MONITOR]

The monitor is designed to be compatible with both landscape and portrait modes. Video card for portrait display will be required for rotating the image on the screen.

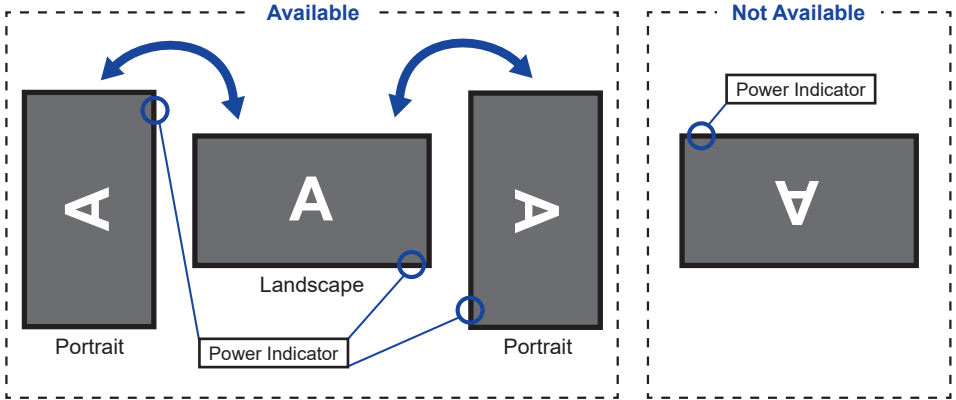

With Stand:

NOTE

- Adjust the monitor's height before panel rotation.
- Attempting to rotate the panel forcibly without adjusting the stand height may cause damage to the panel or the stand.

FITTING AND REMOVAL OF STAND

CAUTION

- Put the monitor on a stable surface. The monitor may cause injury or damage if it falls or is dropped.
- Do not give a strong impact to the monitor. It may cause damage.
- Unplug the monitor before removal or installation to avoid an electric shock or a damage.
- Regularly check the tightness of the screws. If the screws are not tight enough, the monitor may come off and cause injury or damage.

<Installation>

- ① Attach the Stand-Neck to the VESA Plate and then tighten the 'thumb screw' with the provided screwdriver to secure them.

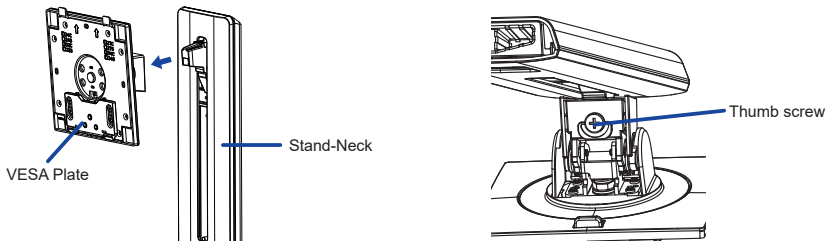

- ② Install the Stand-Base to the Stand-Neck and then tighten the 'thumb screw' with the provided screwdriver to secure them.

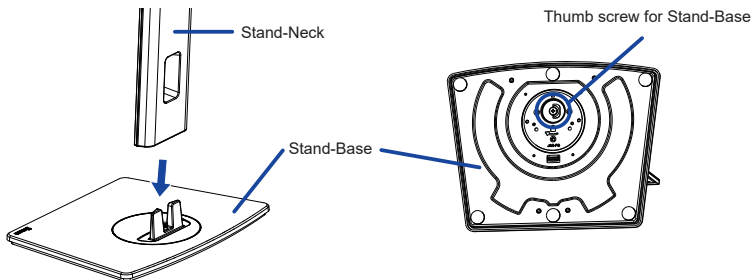

- ③ Put a piece of soft cloth on the table beforehand to prevent the monitor from being scratched. Lay the monitor flat on a table with front face down.
- ④ Hold the monitor and install the assembled stand to the monitor until it clicks to secure.

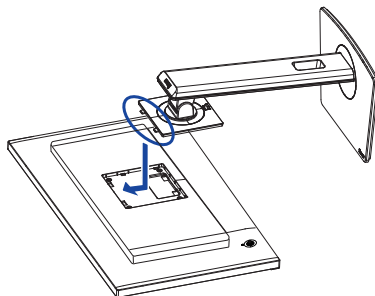

<Removal>

- ① Put a piece of soft cloth on the table beforehand to prevent the monitor from being scratched. Lay the monitor flat on a table with front face down.
- ② Press the release button to remove the stand.

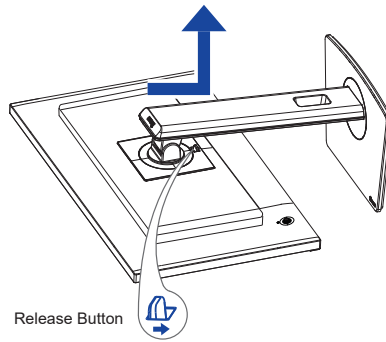

- ③ Loosen the 'thumb screw' with the provided screwdriver to remove the Stand-Neck from the VESA Plate.
- ④ Loosen the 'thumb screw' with the provided screwdriver to remove the Stand-Base from the Stand-Neck.

CONTROLS AND CONNECTORS : ProLite XB2797QSNP

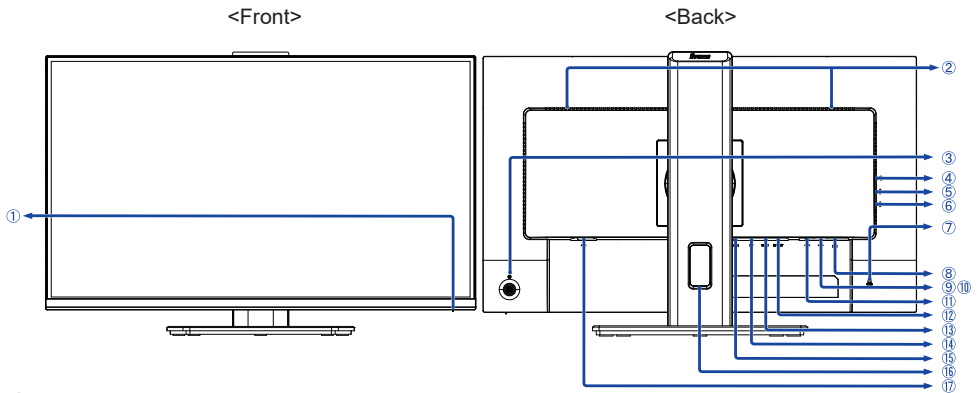

① Power Indicator

NOTE Blue: Normal operation
Orange: Standby mode

② Speakers

③ Joystick ()

Power / Menu [Center]

A short press turns ON the monitor.

A long press for 6 seconds turns OFF the monitor.

Up / Signal Select []

Direct

Down []

Left / Shortcut [] *1,2

Shortcut

Right / Volume [] *1,2.

Shortcut

④ Headphone Connector ()

NOTE Proper operation of connected external devices other than headphones is not guaranteed.

⑤ USB Type-C Downstream Connector ( USB3.2 Gen 1: 5Gbps, 5V, 1.5A)

⑥ USB Type-C Downstream Connector ( USB3.2 Gen 1: 5Gbps, 5V, 1.5A)

⑦ Keyhole for Security Lock

NOTE You can fasten a security lock and cable to prevent the monitor from being removed without your permission.

⑧ LAN(RJ45) Connector ()

⑨ USB Type-A Downstream Connector ( USB3.2 Gen 1: 5Gbps, 5V, 900mA)

⑩ USB Type-A Downstream Connector ( USB3.2 Gen 1: 5Gbps, 5V, 900mA)

⑪ USB Type-B Upstream Connector ( USB3.2 Gen 1: 5Gbps)

⑫ DisplayPort Out Connector (DP OUT) *3

⑬ USB Type-C Upstream Connector (USB C USB3.2 Gen 1: 5Gbps, 5V/3A, 9V/3A, 12V/3A, 15V/3A, 20V/4.8A)

⑭ DisplayPort Connector (DP)

⑮ HDMI Connector (HDMI)

⑯ Cable Hole

⑰ AC Connector ( : Alternating current)

*1 Direction when viewing the screen from the front.

*2 You can skip the Menu items and directly display an option setting screen or an adjustment scale.

*3 DP OUT Connector has a rubber cap already attached. Remove the cap before connection.

CONTROLS AND CONNECTORS : ProLite XB2797QSNPH

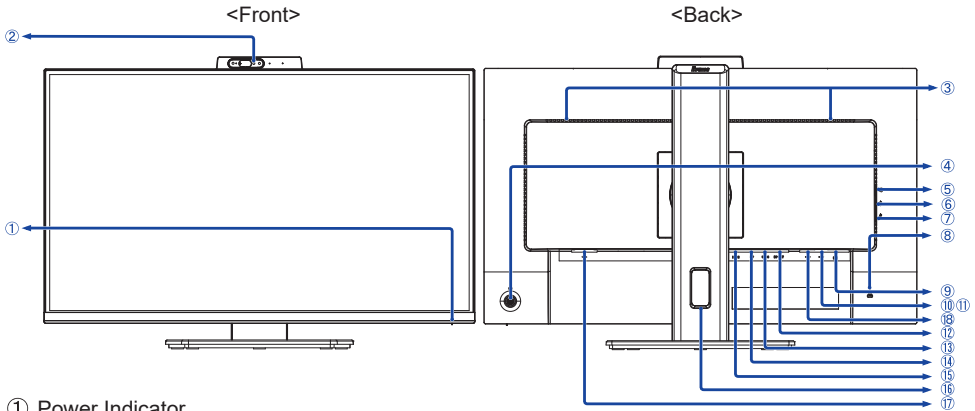

① Power Indicator

NOTE Blue: Normal operation
Orange: Standby mode

② Webcam

NOTE The Webcam will not work if the monitor and computer are not connected with a USB cable. When using any communication app, set as follows.
• Camera: USB2.0 5M 2880x1800P WebCam • Microphone: Realtek USB2.0 Audio

③ Speakers

④ Joystick (⏻)

Power / Menu [Center]

A short press turns ON the monitor.

A long press for 6 seconds turns OFF the monitor.

Up / Signal Select [⬆]

Direct

Down [⬇]

Left / Shortcut [⬅] *1,2

Shortcut

Right / Volume [➡] *1,2.

Shortcut

⑤ Headphone Connector (🎧)

NOTE Proper operation of connected external devices other than headphones is not guaranteed.

⑥ USB Type-C Downstream Connector (🔄 USB3.2 Gen 1: 5Gbps, 5V, 1.5A)

⑦ USB Type-C Downstream Connector (🔄 USB3.2 Gen 1: 5Gbps, 5V, 1.5A)

⑧ Keyhole for Security Lock

NOTE You can fasten a security lock and cable to prevent the monitor from being removed without your permission.

⑨ LAN(RJ45) Connector (📡)

⑩ USB Type-A Downstream Connector (🔄 USB3.2 Gen 1: 5Gbps, 5V, 900mA)

⑪ USB Type-A Downstream Connector (🔄 USB3.2 Gen 1: 5Gbps, 5V, 900mA)

⑫ DisplayPort Out Connector (DP OUT) *3

⑬ USB Type-C Upstream Connector (USB C USB3.2 Gen 1: 5Gbps, 55V/3A, 9V/3A, 12V/3A, 15V/3A, 20V/4.8A)

⑭ DisplayPort Connector (DP)

⑮ HDMI Connector (HDMI)

⑯ Cable Hole

⑰ AC Connector (~ : Alternating current)

⑱ USB Type-B Upstream Connector (🔄 USB3.2 Gen 1: 5Gbps)

*1 Direction when viewing the screen from the front.

*2 You can skip the Menu items and directly display an option setting screen or an adjustment scale.

*3 DP OUT Connector has a black rubber cap already attached. Remove the cap before connection.

CONNECTING YOUR MONITOR

- ① Ensure that both the computer and the monitor are switched off.
- ② Connect the computer to the monitor with the signal cable.
- ③ Connect the computer to the monitor with the USB Cable (Type-A-B).
- ④ Connect the computer to the monitor with the USB Cable (Type-C-C) when viewing images on your monitor through the USB Type-C Connector or when using the monitor's USB hub function
- ⑤ Connect the Power Cable to the monitor first and then to the power source.
- ⑥ Turn on your monitor and computer.

- When charging connected device via USB Type-C Connector, check if the device is equipped with a USB Type-C Connector that supports charging function via USB PD (=Power Delivery).
- The USB power delivery is up to 96W. If the connected device required more than 96W for operation or for boot up (when the battery is drained), use the original power adapter that came with the device.
- If a separately purchased USB Type-C Cable is used, make sure the cable is certified by USB-IF and is full-featured with power delivery and video / audio / data transfer functions.
- If the monitor is in standby mode, it will not display a picture automatically in the following situations:
 1. First boot of the PC
 2. When the PC is resuming from standby modeTo display a picture, press the Joystick / Power Button. This behaviour is normal. To prevent this behaviour, please access the OSD menu and set "USB CHARGE" to "ON".
- USB cable (Type-A-C) is not included with the monitor. If you use a USB cable (Type-A-C), please note that you can only transfer data.
- Compatibility with all connected devices is not guaranteed due to different user environments.

NOTE

- Make sure that the building installation has a circuit breaker of 120/240V, 20A (maximum).
- The signal cables used for connecting the computer and monitor may vary with the type of computer used. An incorrect connection may cause serious damage to both the monitor and the computer. The cable supplied with the monitor is for a standard connector. If a special cable is required please contact your local iiyama dealer or regional iiyama office.
- The Class I pluggable equipment Type A must be connected to protective earth.
- The socket-outlet shall be installed near the equipment and shall be easily accessible.
- Excessive sound pressure from ear-/headphones can cause hearing damage/hearing loss.

[Example of Connection]

<Back>

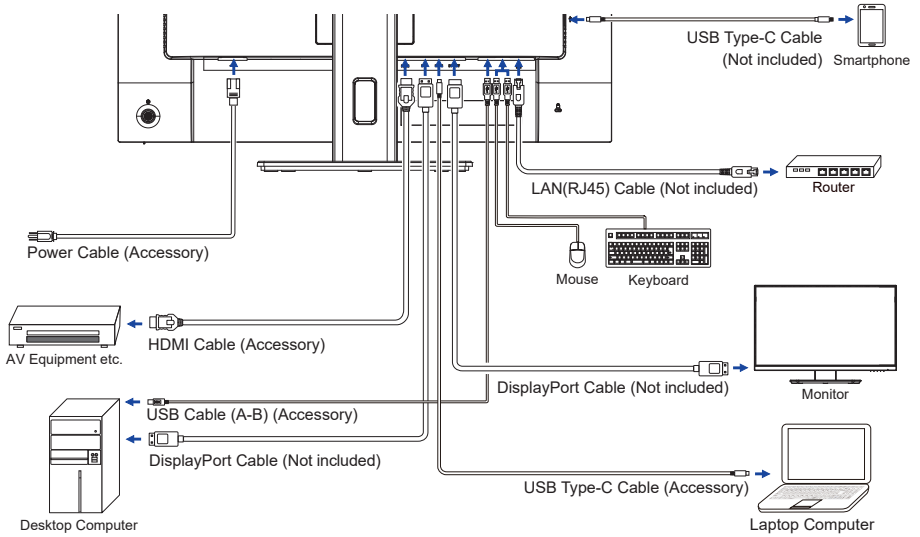

ENGLISH

[Collect Cables]

Put the cables through the cable hole to bundle them.

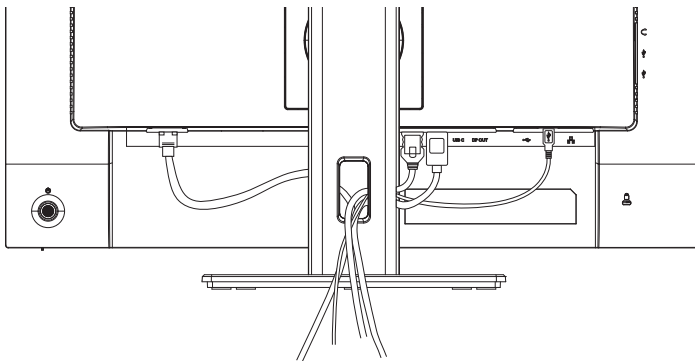

DISCONNECTING YOUR MONITOR

- ① Ensure that both the computer and the monitor are switched off.
- ② Disconnect the power source first and then the Power Cable from the monitor.
- ③ Disconnect the USB cable from the computer and the monitor.
- ④ Disconnect the signal cable from the computer and the monitor.

COMPUTER SETTING

- Signal Timing
Change to the desired signal timing listed on page 33: COMPLIANT TIMING.

ADJUSTING THE HEIGHT AND THE VIEWING ANGLE

- For optimal viewing it is recommended to position yourself directly opposite to the full face of the monitor, then adjust the monitor's height and angle to your own preference.
- Hold the panel so that the monitor does not topple when you change the monitor's height or angle.
- You are able to adjust the monitor's height up to 150mm, angle up to 60° right and left, 23° upward and 5° downward.

NOTE

- Do not touch the LCD screen when you change the height or the angle. It may cause damage or break the LCD screen.
- Careful attention is required not to pinch your fingers or hands into the moving part of the stand when you change the angle.
- Injury can occur if care is not taken to avoid finger contact with the displays base when adjusting the height.

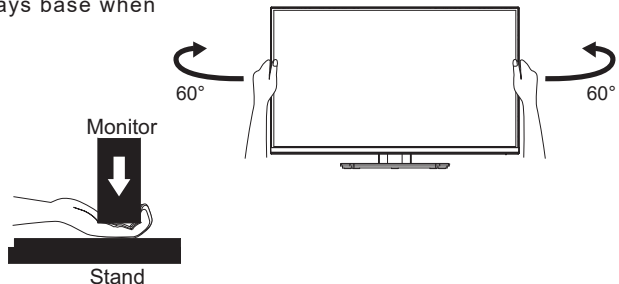
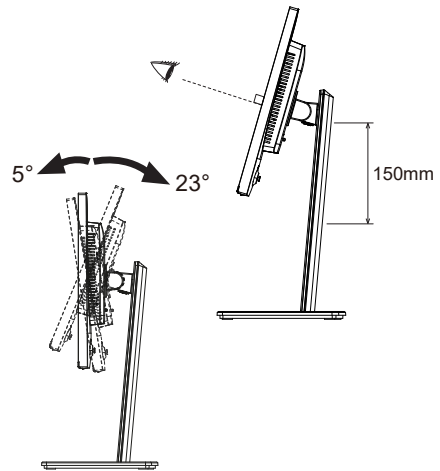

OPERATING THE MONITOR

To create the best picture, your iiyama LCD monitor has been preset at the factory with the COMPLIANT TIMING shown on page 33. You are also able to adjust the picture by following the button operation shown below.

- 1 Press the Joystick [Center] on the monitor to start the On Screen Display feature. There are additional Menu items which can be switched by tilting the Joystick [↔/↕].



- 2 Select the Menu item which contains the adjustment icon relating to the adjustment you want to make. Press the Joystick [Center]. Then, tilting the Joystick [↕/↔] to highlight the desired adjustment icon.
- 3 Press the Joystick [Center] again. Tilting the Joystick [↔/↕] to make the appropriate adjustment or setting.
- 4 Press the Joystick [Center] and then tilt it [↔] to leave the menu, and the settings you just made would be automatically saved.

For example, to correct for OSD vertical position, select Menu item of "OSD" and then press the Joystick [Center]. Then, select "OSD Vertical Position" by tilting the Joystick [↕/↔].

An adjustment scale becomes active after you press the Joystick [Center]. Then, tilt the Joystick [↔/↕] to change the OSD vertical position settings. The OSD vertical position of the overall display should be changing accordingly while you are doing this.

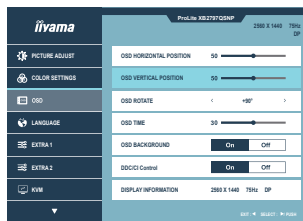

Press or tilt the Joystick [Center] and finally tilt it [↔] to close the On Screen Display feature. All changes are saved in the memory.

NOTE

- When the Joystick operations are aborted during adjustment, On-Screen Display disappears when the time set for the "OSD Time" has passed. Also, tilting the Joystick [↔] can be used to return previous menu and turn off the On Screen Display.
- Any changes are automatically saved in the memory when the On Screen Display disappears. Turning off the power should be avoided while using the Menu.

MENU CONTENTS

Please understand in advance that changing some menu items may affect other adjustments or settings.

Adjustment Item		Problem / Option	Joystick
Brightness *1	Shortcut	Too dark	
		Too bright	
Contrast		Too dull	
		Too intense	
ECO	Shortcut	Off	Normal
		Mode1	Brightness of back-light is reduced.
		Mode2	Brightness of back-light is reduced more than Mode1.
		Mode3	Brightness of back-light is reduced more than Mode2.
Adv. Contrast		On	Increased Contrast Ratio
		Off	Typical Contrast Ratio
NOTE Adv. Contrast adjusts brightness according to the image, and improve the contrast ratio during movie playing.			
Overdrive		Off / 1 / 2 / 3 / 4 / 5 It will improve the gray level response time of the LCD panel. A higher level results in a faster response time.	
Motion Blur Reduction *2		Off / 1 / 2 / 3 / 4 / 5 / 6 / 7 Improve the moving picture response time of the LCD panel.	
Adaptive Sync		On	Enable the Adaptive Sync function.
		Off	The Adaptive Sync function is turned off.

*1 Adjust the Brightness when you are using the monitor in a dark room and feel the screen is too bright.

*2 Motion Blur Reduction is available only when the refresh rate is 75Hz or more.

Shortcut

You can take a shortcut to the specific menu by the following operations.

- Brightness: Tilt the Joystick Left [⇐] when the Menu is not displayed.
- Eco: Tilt the Joystick Left [⇐] when the Menu is not displayed.





Color Settings

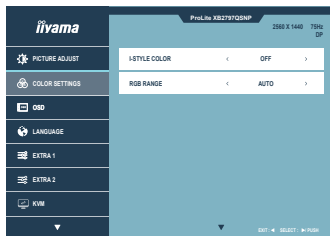

Adjustment Item	Problem / Option		Joystick
i-Style Color Shortcut	Off	Return to a state set by color adjustment except i-Style Color.	
	Standard	For general windows environment and monitor default setting.	
	Game	For PC game environment.	
	Cinema	For Cinema environment.	
	Scenery	For Scenery environment.	
	Text	For text editing and viewing in a word processing environment.	
RGB Range	Auto	Automatically select Limited or Full.	
	Full	For full-range color scale signalscale signal	
	Limited	For limited color scale signal	
Color Temperature	9300K	Cool color	
	7500K	Normal color	
	6500K	Warm color	
	sRGB	sRGB	
User Preset	Red	Too weak	
	Green		
	Blue	Too strong	



Shortcut

You can take a shortcut to the specific menu by the following operations.

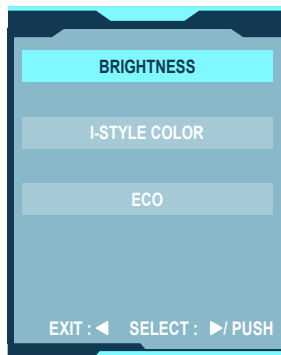
- I-Style Color: Tilt the Joystick Left [\leftarrow] when the Menu is not displayed.

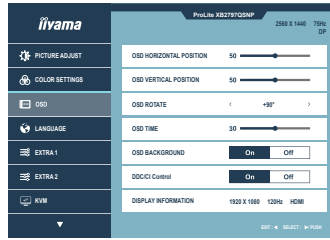



Adjustment Item	Problem / Option		Joystick
OSD Horizontal Position	OSD is too left OSD is too right		
OSD Vertical Position	OSD is too low OSD is too high		
OSD Rotate *	Rotates the OSD. 0° / +90° / -90°		
OSD Time	You can set the OSD display duration time between 5 and 30 seconds.		
OSD Background	On	The background of OSD is made transparent.	
	Off	Return the background of OSD.	
DDC/CI Control	On	DDC/CI is On.	
	Off	DDC/CI is Off.	
Display Information	Displays information regarding the current input signal coming from the graphic card in your computer.		

NOTE See your graphic card user guide for more information about changing the resolution and refresh.

- * +90° : Appropriate for portrait mode with the monitor rotated to the right.
- 90° : Appropriate for portrait mode with the monitor rotated to the left.



Language

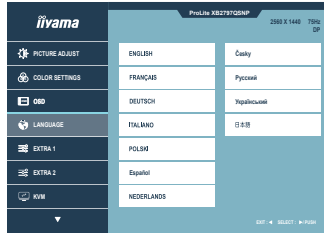

Problem / Option

English	English	Nederlands	Dutch
Français	French	Češky	Czech
Deutsch	German	Русский	Russian
Italiano	Italian	Український	Ukraina
Polski	Polish	日本語	Japanese
Español	Spanish		

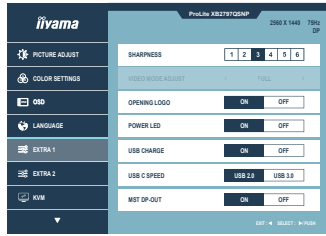

Adjustment Item	Problem / Option		Joystick
Sharpness	1 2 3 4 5 6 You can change the picture quality from 1 to 6 (sharp to soft). Press Right [➡] to change the picture quality in numerical order. Press Left [⬅] to change the picture quality in reverse numerical order.		
Video Mode Adjust *1	Full	Expansion display	
	Aspect	Expansion display of Aspect	
Opening Logo	On	Opening Logo is On.	
	Off	Opening Logo is Off.	
Power LED	On	The Power Indicator is turned On.	
	Off	The Power Indicator is turned Off.	
NOTE Turn Off the Power Indicator when you are bothered by the light.			
USB Charge *2	On	USB devices can be charged even when the monitor is in the standby mode.	
	Off	USB devices can not be charged when the monitor is in the standby mode.	
NOTE When the monitor is turned off, USB devices cannot be charged even when the USB Charge function is on. While this function is off, USB devices do not operate even when the monitor is in standby mode to save standby electricity. When operating USB devices, turn this function on.			
USB C Speed	USB 2.0	Select the data transfer speed when connecting via USB Type-C.	
	USB 3.0		
NOTE When USB 3.0 is selected on USB Type-C input, 2560 × 1440 resolution at 75Hz cannot be supported.			
MST DP-Out	On	MST DP-Out is On.	
	Off	MST DP-Out is Off.	

*1 It can display in the center of the screen with a 4:3, 5:4 or 16:10 aspect ratio when input video resolution is 4:3, 5:4 or 16:10.

*2 For energy standards, USB Ports of this display are disabled during Standby and Power Off modes. To turn on USB ports in Standby mode, please select "USB CHARGE" to "ON".

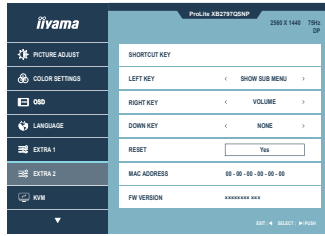

Adjustment Item	Problem / Option		
Shortcut Key	Left Key	Show sub menu	Video Mode Adjust
		Brightness	i-Style Color
		Contrast	Color Temperature
	Right Key	Volume	Video Mode Adjust
		Brightness	i-Style Color
		Contrast	Color Temperature
	Down Key	USB Switch	Video Mode Adjust
		Brightness	i-Style Color
		Contrast	Color Temperature
	Reset	Menu assignments are reset to factory settings.	
<p>NOTE You can assign a menu selected from the options above to the Joystick.</p>			
Mac Address	Show monitor MAC Address		
FW Version	Display the firmware version.		



KVM

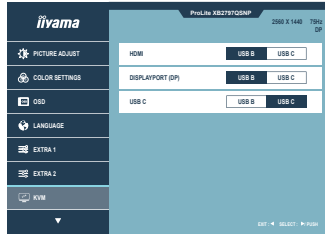

Adjustment Item		Problem / Option	
HDMI	Direct	USB-B	When two or three computers are connected to the monitor, you can link the input source with the USB upstream connector.
		USB-C	
DisplayPort (DP)	Direct	USB-B	
		USB-C	
USB C	Direct	USB-B	
		USB-C	

ENGLISH

Direct

You can skip the Menu items and directly display an option setting screen by using the following operations.

- Tilt the Joystick Downward [⇩] when the Menu is not displayed, it shows following Menu.

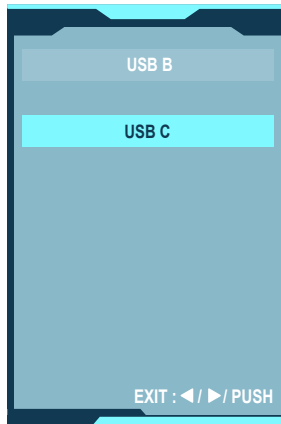

Input Select

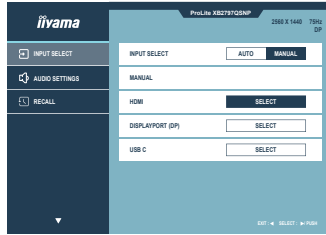

Adjustment Item		Problem / Option		
Input Select	Direct	AUTO	Select the signal input automatically.	
		Manual	HDMI	Select the Digital (HDMI) input.
			DisplayPort (DP)	Select the Digital (DisplayPort) input.
			USB C	Select the Digital (USB C) input.

NOTE At selected the AUTO, it will automatically be selected when just one source is available. If there are more input sources available and you select one of them, the AUTO option is not available. If multiple inputs are connected, the monitor may not recover the last one used after turning it off and on again. It is only possible when you set a specific source.

Direct

You can skip the Menu items and directly display an option setting screen by using the following operations.

- Input Select: Tilt the Joystick Up [⇧] when the Menu is not displayed, it shows following Menu.

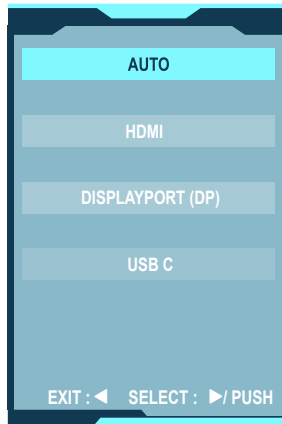

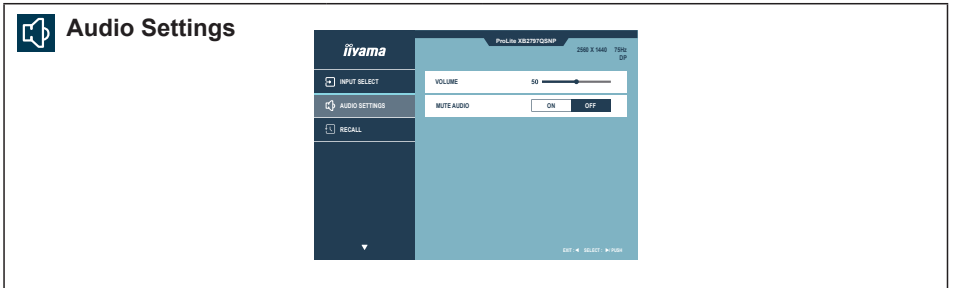

Adjustment Item	Problem / Option	Joystick
Volume Shortcut	Too soft Too loud	
Mute Audio Shortcut	On	Turn off the sound temporarily.
	Off	Return the sound volume to the previous level.

Shortcut

You can take a shortcut to the specific menu by the following operations.

- Volume: Tilt the Joystick Right [↗] when the Menu is not displayed.

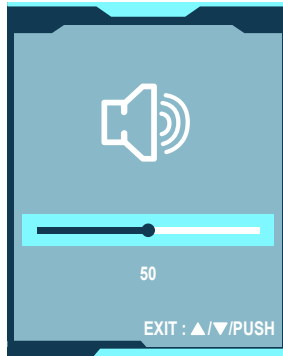

- Mute Audio: Tilt the Joystick Right [↗] for about 3 seconds when the Menu is not displayed.

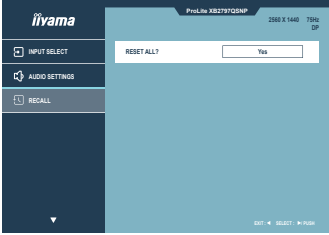
Reset	
	
Sub-menu	Problem / Option
Reset All?	Yes Factory-preset data is restored.

■ Lock Mode

<OSD Menu>

The OSD can be locked to avoid an accidental setting change.

1. Make sure the monitor is turned ON.
2. The OSD lock will be activated by tilting the Joystick [↕] for about 10 seconds. If you try to access the OSD by the Joystick, a message "OSD Locked" will appear on the screen.
3. The OSD lock will be deactivated by tilting the Joystick [↕] again for about 10 seconds.

<Power Button Function>

The Power Button function can be locked to avoid an accidental power operation.

1. Make sure the monitor is turned ON.
2. The Power Button function will be locked by tilting the Joystick [↕] for about 10 seconds. If you try to turn off the monitor by pressing the Joystick, a message "Power Button Locked" will appear on the screen.
3. The Power Button function will be unlocked by tilting the Joystick [↕] again for about 10 seconds.

STANDBY FEATURE

This product features the standby function. When activated, it automatically reduces unnecessary power consumption of the monitor when your computer is not in use.

There is a standby step the monitor takes as described below. The standby function, including any timer settings is configured by the operating system. Check your operating system manual for information on how this can be configured.

■ Standby Mode

When the video signal from the computer is off, the monitor enters into Standby Mode which reduces the power consumption to less than 0.5W*. The screen becomes dark, and the power indicator turns to orange. From Standby Mode, the image reappears in several seconds when either the keyboard or the mouse are touched again.

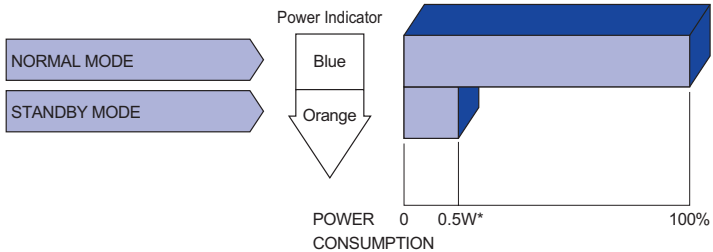

* When the USB devices are not connected.

TROUBLE SHOOTING

If the monitor fails to operate correctly, please follow the steps below for a possible solution.

1. Perform the adjustments described in OPERATING THE MONITOR, depending on the problem you have. If the monitor does not get a picture, skip to 2.
2. Consult the following items if you cannot find an appropriate adjustment item in OPERATING THE MONITOR or if the problem persists.
3. If you are experiencing a problem which is not described below or you cannot correct the problem, discontinue using the monitor and contact your dealer or iiyama service center for further assistance.

Problem

Check

- | | |
|--|--|
| <p>① The picture does not appear.
(Power indicator does not light up.)</p> <p>(Power indicator is blue.)</p> <p>(Power indicator is orange.)</p> | <p><input type="checkbox"/> The Power Cable is firmly seated in the socket.</p> <p><input type="checkbox"/> The Power Switch is turned ON.</p> <p><input type="checkbox"/> The AC socket is live. Please check with another piece of equipment.</p> <p><input type="checkbox"/> If the blank screen saver is in active mode, touch the keyboard or the mouse.</p> <p><input type="checkbox"/> Increase the Contrast and/or Brightness.</p> <p><input type="checkbox"/> The computer is ON.</p> <p><input type="checkbox"/> The Signal Cable is properly connected.</p> <p><input type="checkbox"/> The signal timing of the computer is within the specification of the monitor.</p> <p><input type="checkbox"/> If the monitor is in standby mode, touch the keyboard or the mouse.</p> <p><input type="checkbox"/> The computer is ON.</p> <p><input type="checkbox"/> The Signal Cable is properly connected.</p> <p><input type="checkbox"/> The signal timing of the computer is within the specification of the monitor.</p> |
| <p>② The screen is not synchronized.</p> | <p><input type="checkbox"/> The Signal Cable is properly connected.</p> <p><input type="checkbox"/> The signal timing of the computer is within the specification of the monitor.</p> |
| <p>③ The screen position is not in the center.</p> | <p><input type="checkbox"/> The signal timing of the computer is within the specification of the monitor.</p> |
| <p>④ The screen is too bright or too dark.</p> | <p><input type="checkbox"/> The video output level of the computer is within the specification of the monitor.</p> |
| <p>⑤ The screen is shaking.</p> | <p><input type="checkbox"/> The power voltage is within the specification of the monitor.</p> <p><input type="checkbox"/> The signal timing of the computer is within the specification of the monitor.</p> |
| <p>⑥ No sound.</p> | <p><input type="checkbox"/> The audio equipment (computer etc.) is ON.</p> <p><input type="checkbox"/> The Volume is turned up.</p> <p><input type="checkbox"/> The Mute is OFF.</p> <p><input type="checkbox"/> The audio output level of the audio equipment is within the specification of the monitor.</p> |
| <p>⑦ The sound is too loud or too quiet.</p> | <p><input type="checkbox"/> The audio output level of the audio equipment is within the specification of the monitor.</p> |

RECYCLING INFORMATION

For better environment protection please don't dispose your monitor.
Please visit our web site: <https://iiyama.com> for monitor recycling.

APPENDIX

Design and specifications are subject to change without prior notice.

SPECIFICATIONS : ProLite XB2797QSNP-B1 / W1

ENGLISH

Size Category	27"	
LCD Panel	Panel technology	IPS (In-Plane-Switching)
	Size	Diagonal: 27" (68.5cm)
	Pixel pitch	0.233mm H × 0.233mm V
	Brightness	350cd/m ² (Typical), 155cd/m ² (Default / Energy Saving)
	Contrast ratio	1000 : 1 (Typical), Adv. Contrast Function Available
	Viewable angle	Right / Left : 89 degrees each, Up / Down : 89 degrees each (Typical)
	MPRT	1ms
Display Colors	Approx. 16.7M	
Sync Frequency	HDMI(Adaptive-Sync: Off): Horizontal: 31.0-112.0kHz, Vertical: 55-75Hz HDMI(Adaptive-Sync: On): Horizontal: 31.0-112.0kHz, Vertical: 48-75Hz USB Type-C(Adaptive-Sync: Off): Horizontal: 31.0-112.0kHz, Vertical: 55-75Hz USB Type-C(Adaptive-Sync: On): Horizontal: 112.0-112.0kHz, Vertical: 48-75Hz DisplayPort(Adaptive-Sync: Off): Horizontal: 31.0-112.0kHz, Vertical: 55-75Hz DisplayPort(Adaptive-Sync: On): Horizontal: 112.0-112.0kHz, Vertical: 48-75Hz	
Native Resolution	2560 × 1440, 3,7 MegaPixels	
Support max. resolution	HDMI / USB Type-C / DisplayPort: 2560 × 1440, 75Hz	
Input Connector	HDMI, DisplayPort, USB Type-C	
Input Video Signal	HDMI, DisplayPort, USB Type-C	
USB Standard	USB3.2 Gen 1 (5Gbps), USB Power Delivery (96W)	
Output Video Connector	DP-Out (Daisy chain)	
Number of USB Ports	2 Upstream : Type-C×1, Type-B×1	
Connector shape	4 Downstream : Type-A(DC5V, 900mA)×2, Type-C(DC5V, 1.5A)×2	
LAN Port	RJ45	
Headphone Connector *1	ø 3.5mm mini jack (Stereo)	
Speakers	2W × 2 (Stereo speakers)	
Maximum Screen Size	596.7mm W × 335.7mm H / 23.5" W × 13.2" H	
Power Source	100-240VAC, 50/60Hz, 2.5A	
Power Consumption *2	21W (Default / Energy Saving) Standby mode: 0.5W maximum, Off mode: 0.3W maximum	
Dimensions / Net Weight	613.0 × 403.5 - 547.5 × 209.5mm / 24.1 × 15.9 - 21.6 × 8.2" (W×H×D) 5.9kg / 13.0lbs	
Height Adjustment Range	150mm	
Angle	Tilt: Upward: 23 degrees, Downward: 5 degrees Swivel: Left / Right: 60 degrees each Rotation: Clockwise / Counterclockwise: 90 degrees each	
Environmental Considerations	Operating: Temperature 5 to 35°C / 41 to 95°F Humidity 10 to 80% (No condensation) Storage: Temperature -20 to 60°C / -4 to 140°F Humidity 10 to 90% (No condensation)	
EPEAT Silver	Registration varies by country, go to www.epeat.net for details	
Approvals	TCO Certified, CE, UKCA, TÜV-GS, VCCI, PSE, EAC	

NOTE

*1 Proper operation of connected external devices other than headphones is not guaranteed.

*2 When the USB devices are not connected.

SPECIFICATIONS : ProLite XB2797QSNPH-B1

Size Category	27"	
LCD Panel	Panel technology	IPS (In-Plane-Switching)
	Size	Diagonal: 27" (68.5cm)
	Pixel pitch	0.233mm H × 0.233mm V
	Brightness	350cd/m ² (Typical), 175cd/m ² (Default / Energy Saving)
	Contrast ratio	1000 : 1 (Typical), Adv. Contrast Function Available
	Viewable angle	Right / Left : 89 degrees each, Up / Down : 89 degrees each (Typical)
	MPRT	1ms
Display Colors	Approx. 16.7M	
Sync Frequency	HDMI(Adaptive-Sync: Off): Horizontal: 31.0-112.0kHz, Vertical: 55-75Hz HDMI(Adaptive-Sync: On): Horizontal: 31.0-112.0kHz, Vertical: 48-75Hz USB Type-C(Adaptive-Sync: Off): Horizontal: 31.0-112.0kHz, Vertical: 55-75Hz USB Type-C(Adaptive-Sync: On): Horizontal: 112.0-112.0kHz, Vertical: 48-75Hz DisplayPort(Adaptive-Sync: Off): Horizontal: 31.0-112.0kHz, Vertical: 55-75Hz DisplayPort(Adaptive-Sync: On): Horizontal: 112.0-112.0kHz, Vertical: 48-75Hz	
Native Resolution	2560 × 1440, 3,7 MegaPixels	
Support max. resolution	HDMI / USB Type-C / DisplayPort: : 2560 × 1440, 75Hz	
Input Connector	HDMI, DisplayPort, USB Type-C	
Input Video Signal	HDMI, DisplayPort, USB Type-C	
USB Standard	USB3.2 Gen 1 (5Gbps), USB Power Delivery (96W)	
Output Video Connector	DP-Out (Daisy chain)	
Number of USB Ports Connector shape	2 Upstream : Type-C×1, Type-B×1 4 Downstream : Type-A(DC5V, 900mA)×2, Type-C(DC5V, 1.5A)×2	
LAN Port	RJ45	
Headphone Connector *1	ø 3.5mm mini jack (Stereo)	
Speakers	2W × 2 (Stereo speakers)	
Webcam	Windows Hello compatible, 5 MegaPixels / 30fps, Autofocus, Built-in Mic, Field of View Horizontal: 88.1°	
Maximum Screen Size	596.7mm W × 335.7mm H / 23.5" W × 13.2" H	
Power Source	100-240VAC, 50/60Hz, 2.5A	
Power Consumption *2	21W (Default / Energy Saving) Standby mode: 0.5W maximum, Off mode: 0.3W maximum	
Dimensions / Net Weight	613.0 × 415.5 - 565.5 × 209.5mm / 24.1 × 16.3 - 22.2 × 8.2" (W×H×D) 6.0kg / 13.2lbs	
Height Adjustment Range	150mm	
Angle	Tilt: Upward: 23 degrees, Downward: 5 degrees Swivel: Left / Right: 60 degrees each Rotation: Clockwise / Counterclockwise: 90 degrees each	
Environmental Considerations	Operating: Temperature 5 to 35°C / 41 to 95°F Humidity 10 to 80% (No condensation) Storage: Temperature -20 to 60°C / -4 to 140°F Humidity 10 to 90% (No condensation)	
EPEAT Silver	Registration varies by country, go to www.epeat.net for details	
Approvals	TCO Certified, CE, UKCA, TÜV-GS, VCCI, PSE, EAC	

NOTE

*1 Proper operation of connected external devices other than headphones is not guaranteed.

*2 When the USB devices are not connected.

DIMENSIONS : ProLite XB2797QSNP

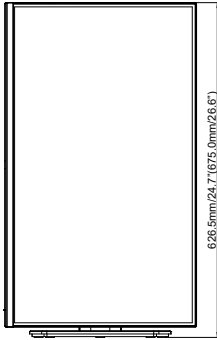
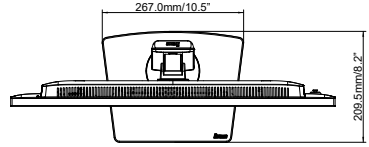
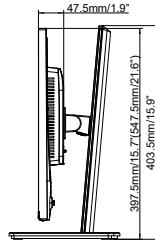
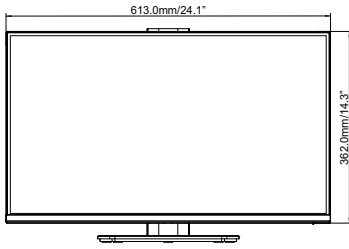

() : Maximum adjustment range

DIMENSIONS : ProLite XB2797QSNPH

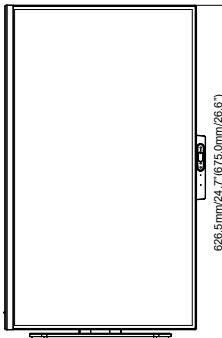
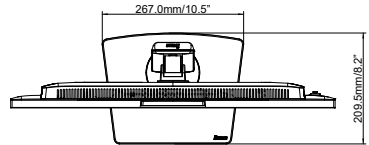
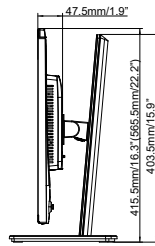
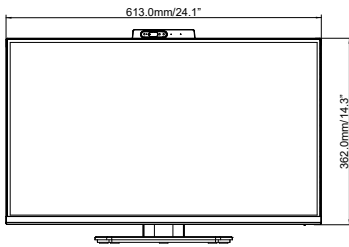

() : Maximum adjustment range

COMPLIANT TIMING

Video Mode	Horizontal Frequency	Vertical Frequency	Dot Clock
800 × 600	37.880kHz	60.320Hz	40.000MHz
	46.880kHz	75.000Hz	49.500MHz
1024 × 768	48.360kHz	60.000Hz	65.000MHz
	60.020kHz	75.030Hz	78.750MHz
1280 × 1024	63.980kHz	60.020Hz	108.000MHz
	79.980kHz	75.020Hz	135.000MHz
1680 × 1050	65.290kHz	59.950Hz	146.250MHz
1920 × 1080	67.500kHz	60.000Hz	148.500MHz
	83.390kHz	74.970Hz	174.500MHz
2560 × 1440	88.787kHz	59.951Hz	241.500MHz
	111.860kHz	74.970Hz	304.250MHz