

Lenovo

ThinkVision

ThinkVision T27QD-4v

User Guide

Machine Types: 64B8

Think

Product numbers

A25270QT0
64B8UAR1WW

First Edition (July 2025)

© Copyright Lenovo 2025.

LENOVO products, data, computer software, and services have been developed exclusively at private expense and are sold to governmental entities as commercial items as defined by 48 C.F.R. 2.101 with limited and restricted rights to use, reproduction and disclosure.

LIMITED AND RESTRICTED RIGHTS NOTICE: If products, data, computer software, or services are delivered pursuant a General Services Administration "GSA" contract, use, reproduction, or disclosure is subject to restrictions set forth in Contract No. GS-35F-05925.

Contents

Safety information	iv
General Safety guidelines	iv
TCO Information	v
Chapter 1. Getting started	1-1
Shipping contents	1-1
Notice for use	1-2
Product overview	1-3
Setting up your monitor	1-10
Registering your option	1-19
Chapter 2. Adjusting and using your monitor	2-1
Comfort and accessibility	2-1
Adjusting your monitor image	2-3
Feature	2-12
Selecting a supported display mode	2-21
Understanding power management	2-22
Caring for your monitor	2-23
Detaching the monitor base and stand	2-23
Wall Mounting (Optional)	2-23
Chapter 3. Reference information	3-1
Monitor specifications	3-1
The recommendation for DP Daisy Chain	3-3
Troubleshooting	3-4
Manually installing the monitor driver	3-6
Service information	3-7

Appendix A. Service and Support..... A-1
 Registering your option A-1
 Online technical support..... A-1
 Telephone technical supportA-1

Appendix B.Notices..... B-1
 Recycling information B-2
 Trademarks..... B-3
 Power cords and power adapters B-3
 Zambia B-3

Safety information

General Safety guidelines

For tips to help you use your computer safely, go to:
<http://www.lenovo.com/safety>

Before installing this product, read the Safety Information.

الرجاء قراءة معلومات السلامة قبل تركيب هذا المنتج.

Преди инсталиране на продукта, прочетете Информация за безопасност.

Před instalací tohoto produktu si přečtěte bezpečnostní informace.

Før du dette tages i brug produkt, skal du læse sikkerhedsoplysningerne.

Lesen Sie die Sicherheitshinweise, bevor Sie das Gerät installieren.

Πριν εγκαταστήσετε αυτό το προϊόν, διαβάστε τις Πληροφορίες για την ασφάλεια.

Antes de instalar este producto, lea la Información de seguridad.

Ennen kuin asennat tämän tuotteen, lue Turvallisuustiedot.

Avant d'installer ce produit, lisez les Informations de sécurité.

לפני התקנת המוצר, חשוב לקרוא את המידע בנושא בטחונות.

Prije ugradnje proizvoda pročitajte obavijesti o sigurnosti.

A termék használatba vétele előtt olvassa el a biztonsági tudnivalókat.

Sebelum memasang produk ini, baca Informasi Keselamatan.

Prima di installare il prodotto, leggere le informazioni sulla sicurezza.

本製品を設置する前に、安全に関する情報をお読みください。

본 제품을 설치하기 전에 안전 정보를 숙지하십시오.

Lees de veiligheidsinformatie voorafgaand aan het installeren van dit product.

Les sikkerhetsinformasjonen før du installerer produktet.

Przed instalacją tego produktu należy przeczytać Informacje dotyczące bezpieczeństwa.

Antes de instalar este produto, leia as Informações de segurança.

Antes de instalar este produto, leia as Informações de Segurança.

Înainte de a instala acest produs, citiți informațiile privind siguranța.

Перед установкой продукта прочтите раздел "Информация о безопасности".

Pred inštaláciou tohto výrobku si prečítajte bezpečnostné informácie.

Pred namestitvijo tega izdelka preberite varnostne informacije.

Pre instaliranja ovog proizvoda, pročitajte Bezbednosne informacije.

Läs säkerhetsinformation innan du installerar den här produkten.

โปรดอ่านข้อมูลด้านความปลอดภัยก่อนที่จะติดตั้งผลิตภัณฑ์นี้

Bu ürünü kurmadan önce Güvenlik Bilgilerini okuyun.

Перш ніж встановлювати пристрій, прочитайте інформацію з техніки безпеки.

在安装本产品之前，请阅读“安全事项”。

安裝本產品前，請閱讀安全資訊。

This equipment is not suitable for use in locations where children are likely to be present, avoid hurting your child when machine falling down.

TCO Information

A third-party certification according to ISO 14024



Toward sustainable IT products

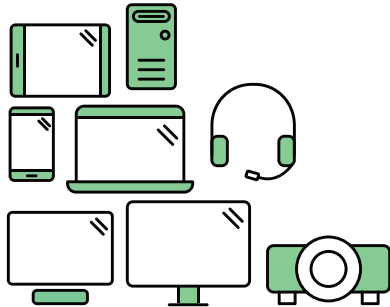

Say hello to a more sustainable product

IT products are associated with a wide range of sustainability risks throughout their life cycle. Human rights violations are common in the factories. Harmful substances are used both in products and their manufacture. Products can often have a short lifespan because of poor ergonomics, low quality and when they are not able to be repaired or upgraded.

This product is a better choice. It meets all the criteria in TCO Certified, the world's most comprehensive sustainability certification for IT products. Thank you for making a responsible product choice, that help drive progress towards a more sustainable future!

Criteria in TCO Certified have a life-cycle perspective and balance environmental and social responsibility. Conformity is verified by independent and approved verifiers that specialize in IT products, social responsibility or other sustainability issues. Verification is done both before and after the certificate is issued, covering the entire validity period. The process also includes ensuring that corrective actions are implemented in all cases of factory non-conformities. And last but not least, to make sure that the certification and independent verification is accurate, both TCO Certified and the verifiers are reviewed regularly.

Want to know more?

Read information about TCO Certified, full criteria documents, news and updates at [tcocertified.com](https://www.tcocertified.com). On the website you'll also find our Product Finder, which presents a complete, searchable listing of certified products.

Congratulations!

This product is TCO Certified – for Sustainable IT



TCO Certified is an international third party sustainability certification for IT products. TCO Certified ensures that the manufacture, use and recycling of IT products reflect environmental, social and economic responsibility. Every TCO Certified product model is verified by an accredited independent test laboratory.

Along with meeting all requirements in TCO Certified, this product also meets the exclusive TCO Certified Edge certification, recognizing best in class products in a specific sustainability attribute.

Summary of TCO Certified Criteria:

Corporate Social Responsibility

Socially responsible production - working conditions and labor law in manufacturing country

Energy Efficiency

Energy efficiency of product and power supply. Energy Star compliant, where applicable

Environmental Management System

Manufacturer must be certified according to either ISO 14001 or EMAS

Minimization of Hazardous Substances

Limits on cadmium, mercury, lead & hexavalent chromium including requirements for mercury-free products, halogenated substances and hazardous flame retardants

Design for Recycling

Coding of plastics for easy recycling. Limit on the number of different plastics used.

Product Lifetime, Product Take Back

Minimum one-year product warranty. Minimum three-year availability of spare parts. Product takeback

Packaging

Limits on hazardous substances in product packaging. Packaging prepared for recycling

Ergonomic, User-centered design

Visual ergonomics in products with a display. Adjustability for user comfort (displays, headsets)

Acoustic performance – protection against sound spikes (headsets) and fan noise (projectors, computers)

Ergonomically designed keyboard (notebooks)

Electrical Safety, minimal electro-magnetic Emissions

Third Party Testing

All certified product models have been tested in an independent, accredited laboratory.

A detailed criteria set is available for download at www.tcodevelopment.com, where you can also find a searchable database of all TCO Certified IT products.

TCO Development, the organization behind TCO Certified, has been an international driver in the field of Sustainable IT for 20 years. Criteria in TCO Certified are developed in collaboration with scientists, experts, users and manufacturers. Organizations around the world rely on TCO Certified as a tool to help them reach their sustainable IT goals. We are owned by TCO, a non-profit organization representing office workers. TCO Development is headquartered in Stockholm, Sweden, with regional presence in North America and Asia.

For more information, please visit
www.tcodevelopment.com

Chapter 1. Getting started

This User's Guide provides detailed operation instructions for the user. For quick instruction overview, please see the Setup Poster for brief information.

ThinkVision T27QD-4v supports Lenovo Display Control Center - **ThinkColour**.

Shipping contents

The product package should include the following items:

- Information Flyer
- Stand
- Base
- Flat Panel Monitor
- Power Cord
- USB Type C-C Cable
- HDMI Cable
- DisplayPort Cable

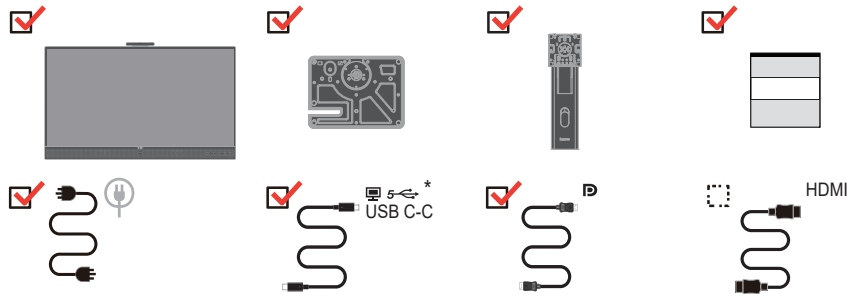

*: Depending on many factors such as the processing capability of peripheral devices, file attributes, and other factors related to system configuration and operating environments, the actual transfer rate using the various USB connectors on this device will vary and is typically slower than the data rates as defined by the respective USB specifications: - 5 Gbit/s for USB 3.1 Gen 1; 10 Gbit/s for USB 3.1 Gen 2 & 20 Gbit/s for USB 3.2.

Notice for use

To set up your monitor, please see the illustrations below.

Note: Do not touch the monitor within the screen area. The screen area is glass and can be damaged by rough handling or excessive pressure.

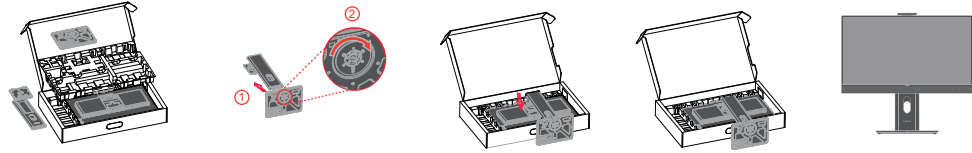

1. Place your monitor with the screen face down on a soft flat surface.
2. Align the stand assembly bracket to the monitor.
3. Insert the base towards monitor until it locks in place.

Note: To install a VESA mount, please see "Wall Mounting (Optional)" on page 2-24.

Product overview

This section will provide information on adjusting monitor positions, setting user controls, and using the cable lock slot.

Side and top view

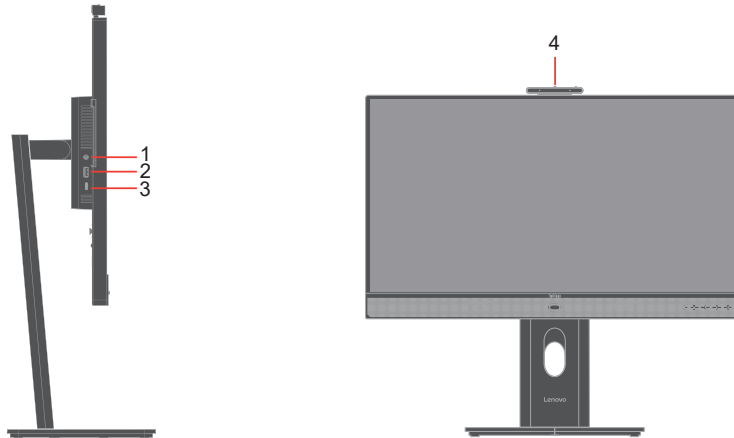

No.	Name
1	Audio jack
2	USB 3.2 Gen 1 Type-A downstream port
3	USB-C downstream port
4	Camera*

*: Preventing Oil Residue on Camera Lens

To ensure optimal image quality, please avoid touching the camera lens directly with your fingers. Oil and dirt from skin contact may accumulate on the surface, causing blurring, glare, or reduced clarity in photos/videos.

*: Very bright environments or fast-moving subjects will impact HDR Performance.

Back View

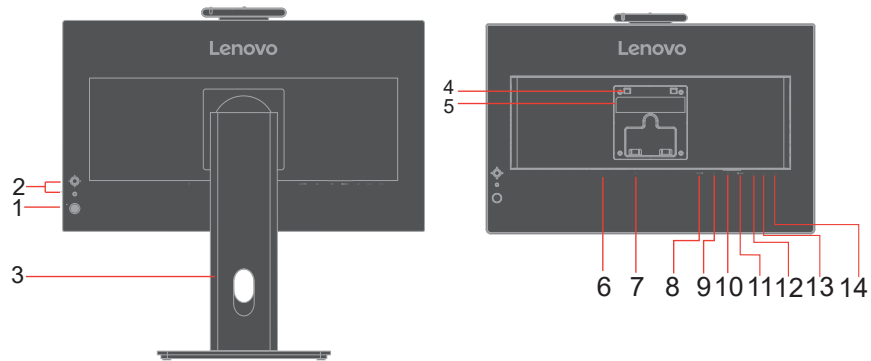

No.	Name
1	Power On/Off button
2	Function buttons
3	Cable management slot
4	VESA mounting holes (100 mm x 100 mm)
5	Regulatory label
6	Power connector
7	Cable lock slot
8	HDMI2.1 port
9	DP1.4 port
10	DP OUT port
11	USB 3.2 Gen 1 Type-C upstream port
12	Ethernet port
13	USB 3.2 Gen 1 Type-A downstream port
14	USB 3.2 Gen 1 Type-A downstream port

Types of adjustments

Tilt

Please see the illustration below for an example of the tilt range.



Swivel

With the built-in pedestal, you can tilt and swivel the monitor for the most comfortable viewing angle.

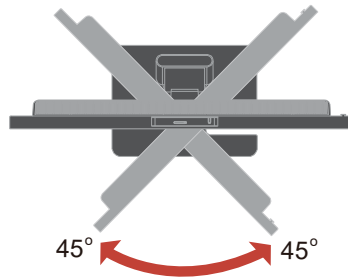

Height Adjustment

For height adjustment, user needs to press down or lift up the monitor.

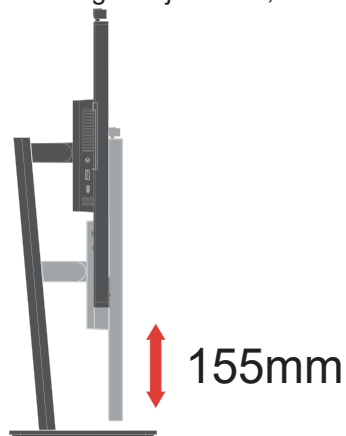

Monitor

- Adjust the screen position before rotating the monitor screen. (Make sure that the monitor screen ascent to its highest point, and it inclines backward at 45°.)
- then rotate clockwise until the monitor stops at 90°.

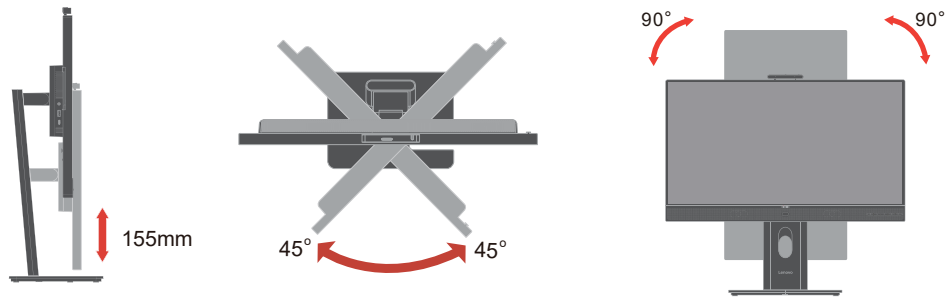

Monitor controls

The keypad controls on the panel frame are accesses to various functions.

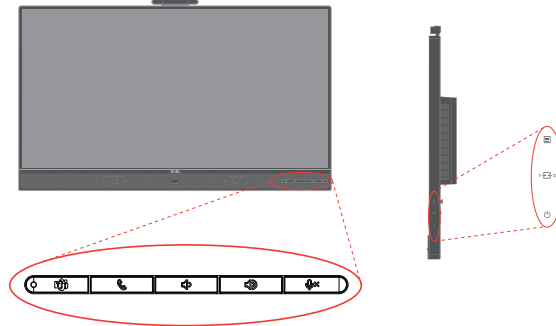

For information on how to utilize these keypad controls, please see “Adjusting your monitor image” on page 2-3.

Cable lock slot

Your monitor is equipped with a cable lock slot located on the rear of your monitor

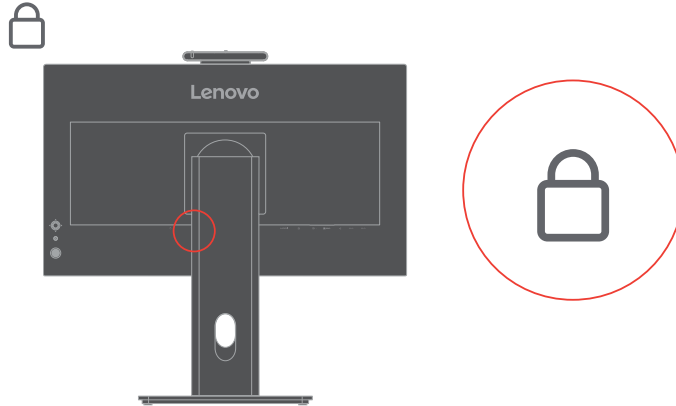

IR-Camera

Your monitor has embedded integrated IR Camera Module; it can be used as a normal web-camera.

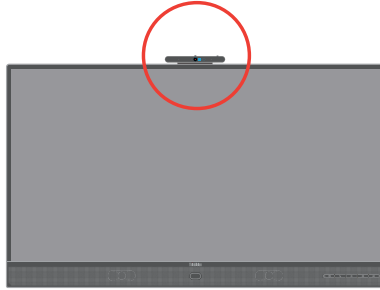

Slide the camera shutter open or close to enable/disable the camera.

a. Slide to open.

b. Slide to close.

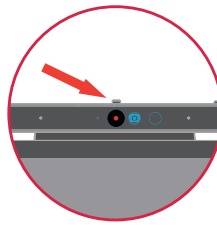
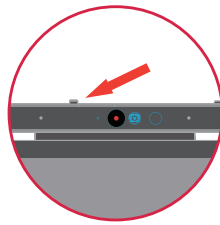

Note: Camera function only support window 10/window 11.

Camera Swivel

Please see the illustration below for an example of camera swivel range.

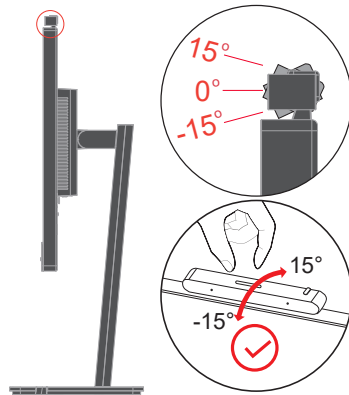

Windows hello

After setting up the “Windows hello” application, you can login your Window 10 operating system with the function of face-recognition.

Note: To set up “windows hello”, please see “Windows Hello setup (Windows 10)”on page 1-17.

Webcam face tracking function

The camera supports facial tracking function. After enabling it in the OSD, it will use the camera's own ROI function to search for the facial position, and then enlarge and display the face.

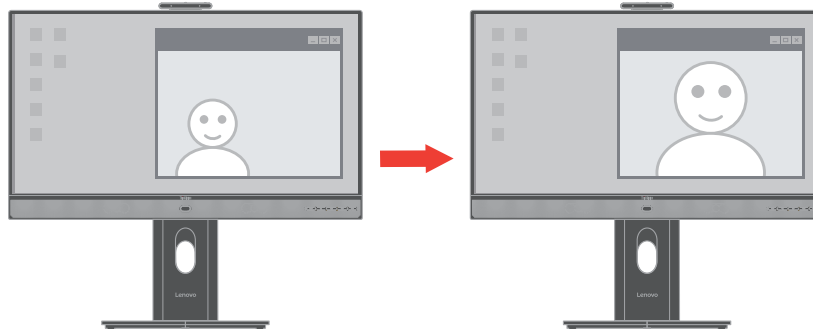

Note:

Sometimes you might find the face can be enlarged, not be centralized when your face is in the edge of the image that camera captured, please move your face close to centre.

Video/Audio Icon on/off

Connect USB cable from PC/NB to Monitor, set Advanced Settings->Video/Audio Icon on, Video/Audio ICON will display on left bottom when Camera / Microphone is enable.



Note:

1. If USB cable is disconnected, Video/Audio ICON in OSD Advanced Settings will gray out. You can't select this function.
2. Video/Audio ICON is conflict with Smart Energy (Dynamic contrast ratio) , it will be turn off & gray out once Smart energy turn on.
3. Video/Audio Icon switch will sync with the mic mute voice prompt.

Speaker

Your monitor has embedded a pair of speakers with 5W, and it can support DP or HDMI audio output and USB audio output. The USB cable need plug in when you use USB audio channel (picture2). DP or HDMI audio output doesn't need USB cable but DP or HDMI cable (picture 1).

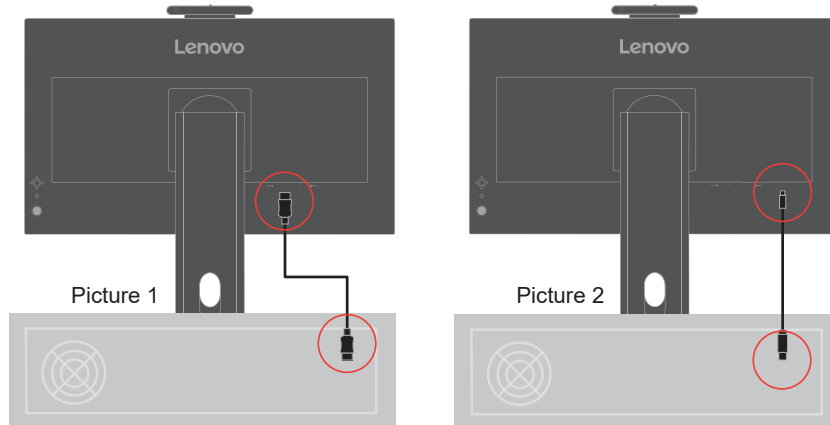

Use Volume control button to adjust volume.

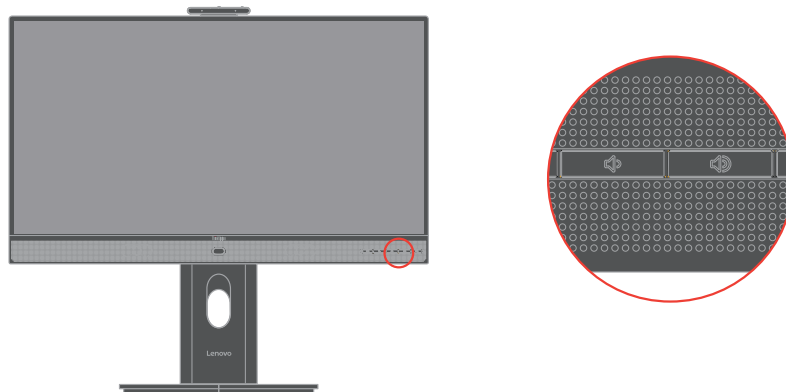

Note:

1. To prevent possible hearing damage, do not listen at high volume levels for long periods. Warning for excessive sound pressure from earphones and headphones. Excessive sound pressure from earphones and headphones can cause hearing loss. Adjustment of the equalizer to maximum increases the earphones and headphones output voltage and therefore the sound pressure level.
2. Volume OSD synchronization support Window 10/Window 11.

Setting up your monitor

This section provides information on how to set up your monitor.

Connecting and turning on your monitor

Note: Be sure to read the Safety information on page iv before carrying out this procedure.

1. Power off your computer and all attached devices, and unplug the computer power cord.



2. Connect the cables according to below icon indication.

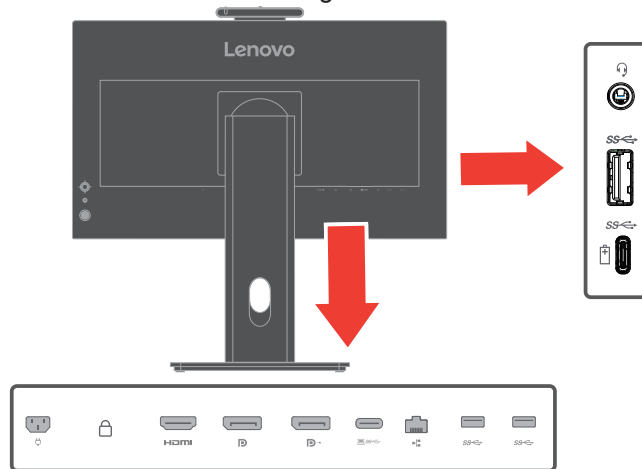

3. For computer in DisplayPort connecting.

Note: For other regions Lenovo recommends that customers who require to use the DP Cable on their monitor purchase the "Lenovo DisplayPort to DisplayPort Cable 0A36537" www.lenovo.com/support/monitoraccessories.

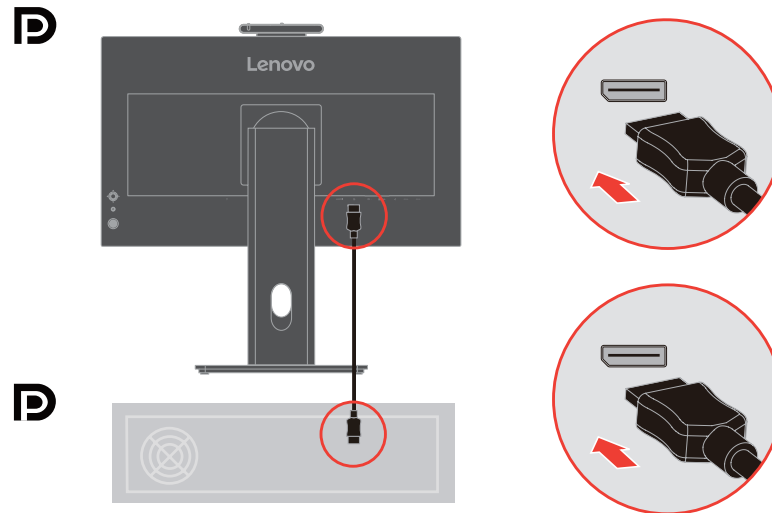

4. For computer in HDMI connecting.

Lenovo recommends that customers who require to use the HDMI input on their monitor purchase the "Lenovo HDMI to HDMI cable OB47070" www.lenovo.com/support/monitoraccessories.

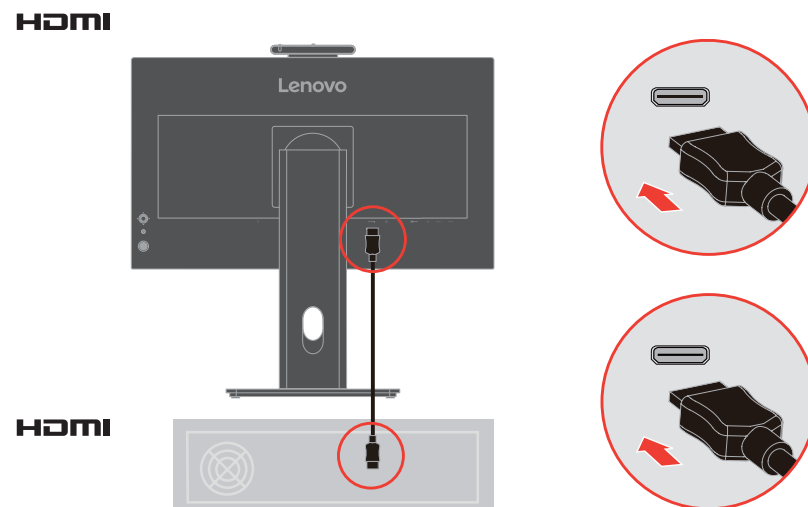

5. For computer in USB type C-C connecting.

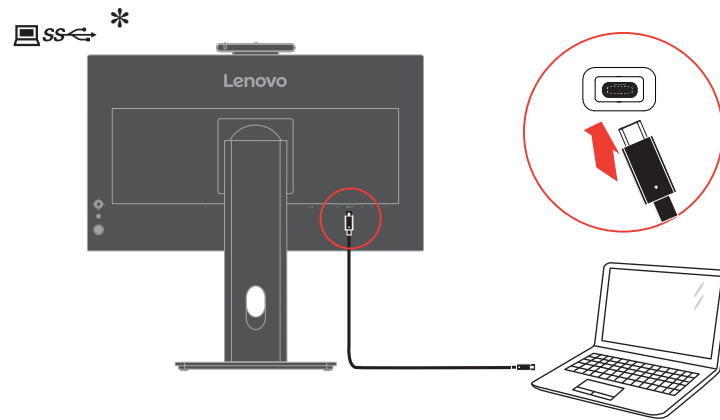

If there are any * tag, you can consult the comments on page 1-1.

-
6. Connect one end of the DP cable to the DP input on the back of another monitor, and the other end to the DP output connector (for daisy chain) on the monitor.

Note: For other regions Lenovo recommends that customers who require to use the Display Port input on their monitor purchase the "Lenovo Display Port to Display Port cable 0A36537". For more information, go to one of the following: www.lenovo.com/support/monitoraccessories.

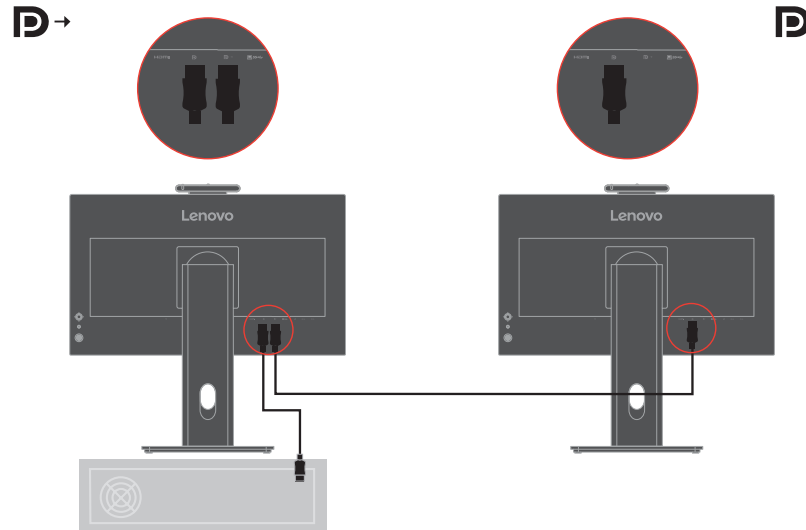

7. Connect one end of the network cable connector to the Ethernet interface of the monitor and the other end to the router.

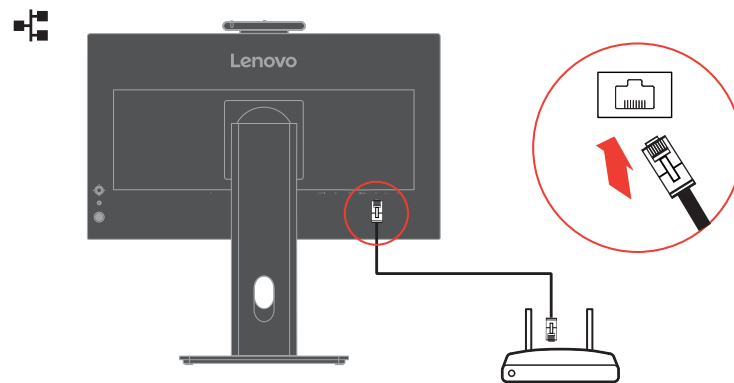

Note1: To connect USB cable to enable the function.

Note2: The USB-C mode always stay in the networked standby mode , there is no standby&sleep in this mode.

Note3: This product can support 10M/100M/1000M Ethernet .Please be sure the setting is correct in OS if the network cannot work well.

-
8. Connect one end of the USB cable to the USB downstream terminal of the monitor, and connect the other end of the USB cable to an appropriate USB port on your device.

Note: The USB downstream port does not provide power while the monitor switch is off.

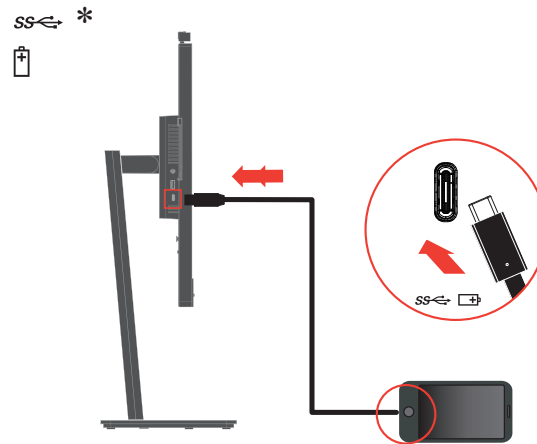

9. Connect your USB device to the USB port on the monitor.



If there are any * tag, you can consult the comments on page 1-1.

10. Connect the speaker's audio cable and audio jack of monitor to transfer audio source from Display Port, HDMI, Type-C or USB.

Note: The audio output in Display Port, HDMI or Type-C modes.

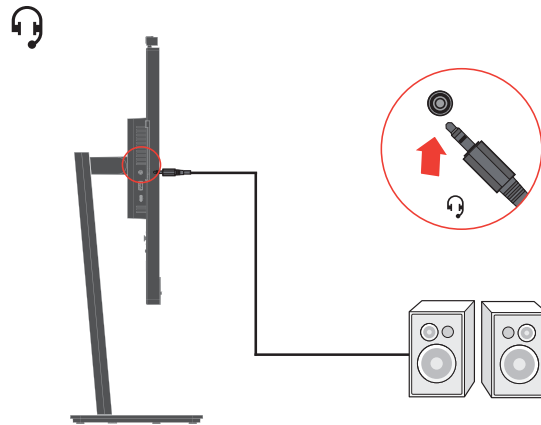

11. The place of hanging a headset.

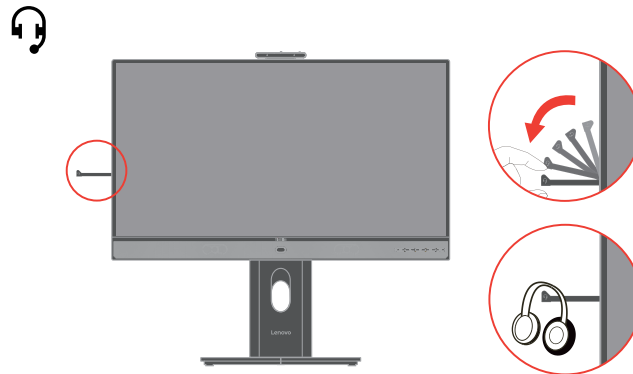

12. Insert the power cord into the monitor, then plug the monitor power cord and the computer cord into grounded electrical outlets.

Note: A certified power supply cord has to be used with this equipment. The relevant national installation and or equipment regulations shall be considered. A certified power supply cord not lighter than ordinary polyvinyl chloride flexible cord according to IEC 60227 (designation H05VV-F 3G 0.75mm² or H05VVH2-F2 3G 0.75mm²) shall be used. Alternative a flexible cord be of synthetic rubber according to IEC 60245 (designation H05RR-F 3G 0.75mm²) shall be used.

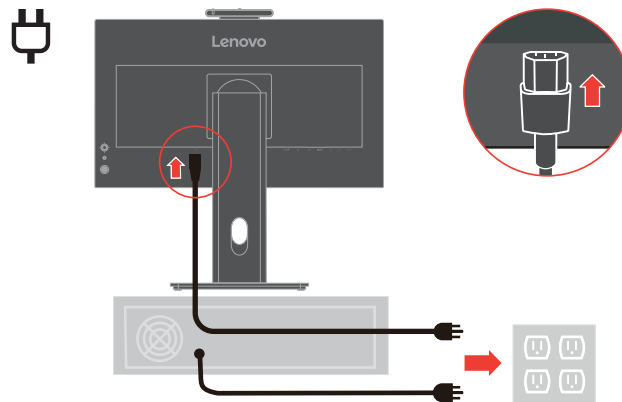

13. Assembled cables with Line Cleaner as shown below.

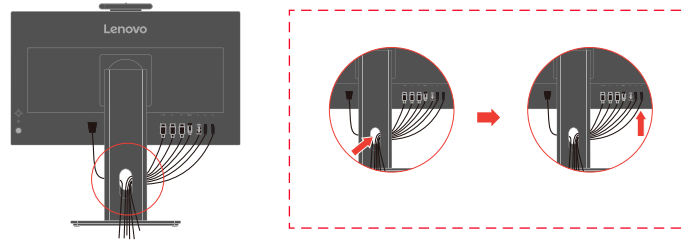

14. Power on the monitor and the computer.

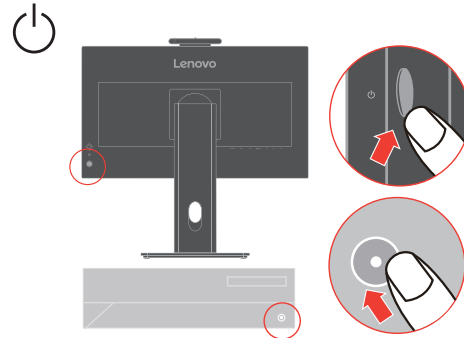

15. When you install the monitor driver, download the driver that corresponds to your monitor model from the Lenovo website https://pcsupport.lenovo.com/solutions/t27qd_4v. Refer to the “Manually installing the monitor driver” on page 3-6 section to install the driver.



Windows Hello setup (Windows 10)

Note: To set up “Windows Hello”, do the following:

1. Press “Windows” + “I” and then click Accounts, choose “Sign-in options”.

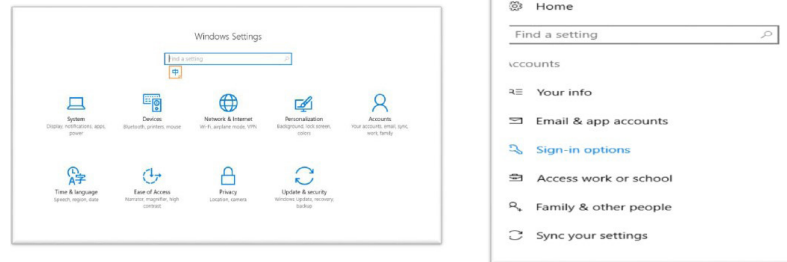

2. Setup PIN number.

3. Establish face-recognition by clicking Set up, Get started.

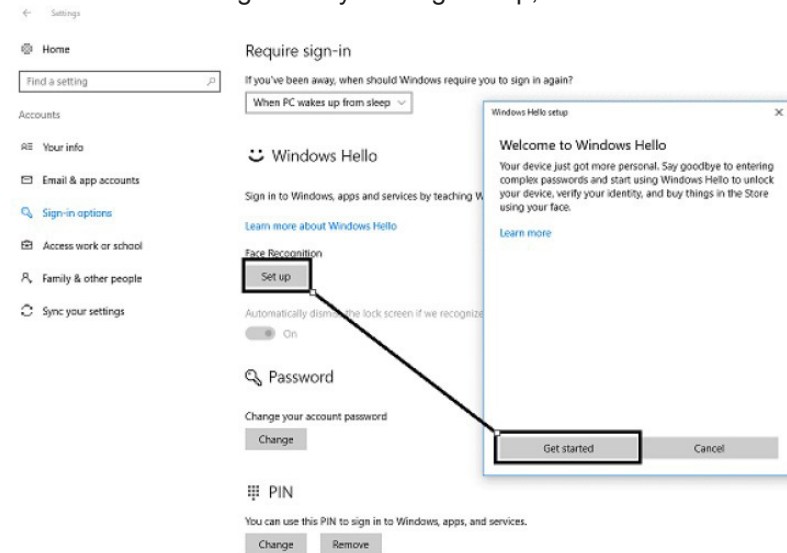

4. Scanning your face information and enable face-recognition to unlock your computer.

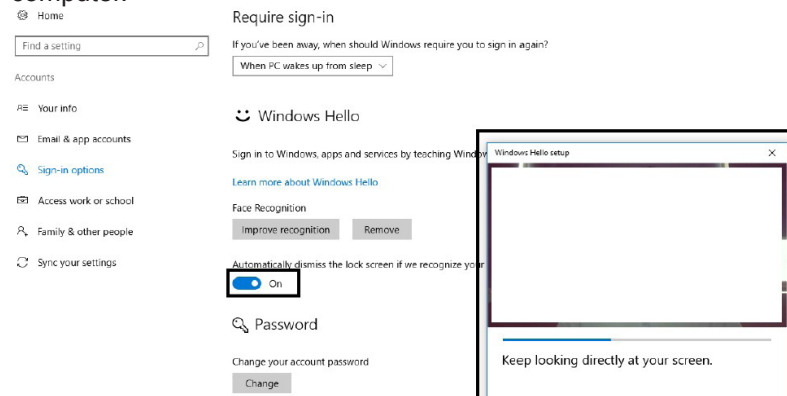

Windows Hello setup (Windows 11)

Note: To set up “Windows Hello”, do the following:

1. Press “Windows” + “I” to enter system configuration.
2. Press “Windows” + “I” and then click Accounts, choose “Sign-in options”.

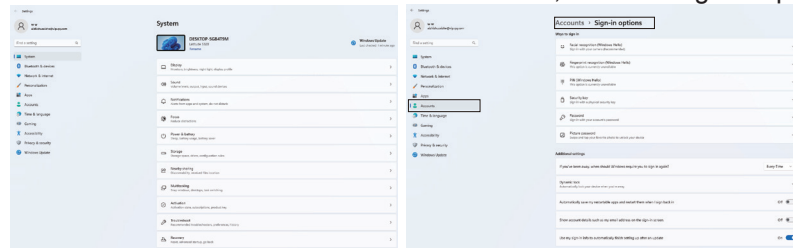

3. Setup PIN number.
4. Establish face-recognition by clicking Set up, Get started.

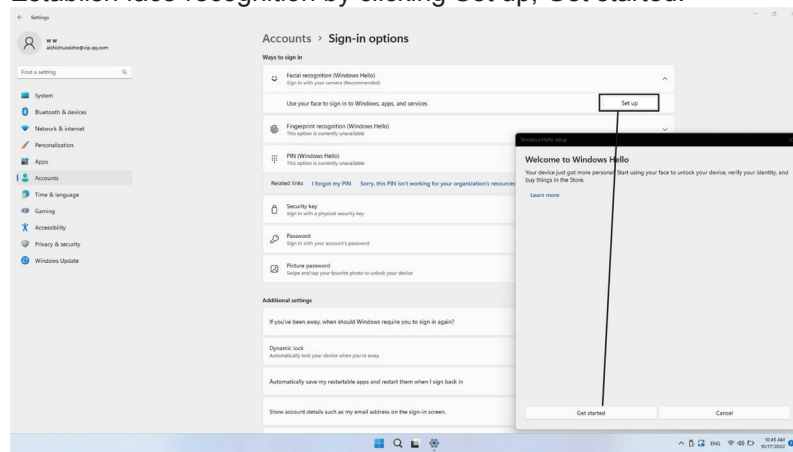

5. Scanning your face information and enable face-recognition to unlock your computer.

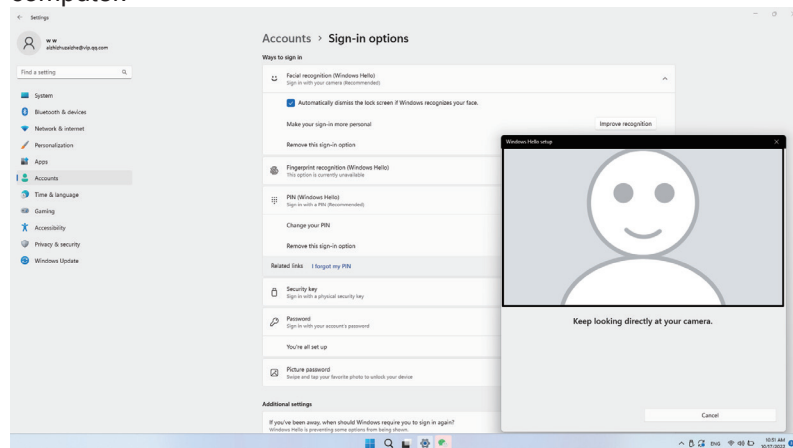

Registering your option

Thank you for purchasing this Lenovo™ product. Please take a few moments to register your Product and provide us with information that will help Lenovo to better serve you in the future. Your feedback is valuable to us in developing product and services that are important to you, as well as in developing better ways to communicate with you. Register your option on the following Web site:

<http://www.lenovo.com/register>

Lenovo will send you information and updates on your registered product unless you indicate on the Web site questionnaire that you do not want to receive further information.

Chapter 2.Adjusting and using your monitor

This section will give you information on adjusting and using your monitor.

Comfort and accessibility

Good ergonomic practice is important to get the most from your personal computer and to avoid discomfort. Arrange your workplace and the equipment you use to suit your individual needs and the kind of work that you perform. In addition, use healthy work habits to maximize your performance and comfort while using your computer. For more detailed information on any of these topics, visit the Healthy Computing Web site at:

<http://www.lenovo.com/healthycomputing/>.

Arranging your work area

Use a work surface of appropriate height and available working area to allow you to work in comfort.

Organize your work area to match the way you use materials and equipment. Keep your work area clean and clear for the materials that you typically use and place the items that you use most frequently, such as the computer mouse or telephone, within the easiest reach.

Equipment layout and setup play a large role in your working posture. The following topics describe how to optimize equipment setup to achieve and maintain good working posture.

Positioning and viewing your monitor

Position and adjust your computer monitor for comfortable viewing by considering the following items:

- **Viewing distance:** Recommended viewing distance between the eye and the monitor screen is 1.5 x the diagonal of the screen. Solutions in meeting this required distance in cramped office situations include pulling desk away from wall or divider to make room for monitor, using flat panel or compact displays placing the monitor in the desk corner, or placing the keyboard in an adjustable drawer to create a deeper working surface.
- **Monitor height:** Position the monitor so your head and neck are in a comfortable and neutral (vertical, or upright) position. If your monitor does not have height adjustments, you might have to place books or other sturdy objects under the base of the monitor to achieve the desired height. A general guideline is to position the monitor such that the top of the screen is at or slightly below your eye-height when you are comfortably seated. However, be sure to optimize your monitor height so the line of site between your eyes and the center the monitor suits your preferences for visual distance and comfortable viewing when your eye muscles are in a relaxed state.
- **Tilt:** Adjust the tilt of your monitor to optimize the appearance of the screen content and to accommodate your preferred head and neck posture.
- **General location:** Position your monitor to avoid glare or reflections on the screen from overhead lighting or nearby windows.

The following are some other tips for comfortable viewing of your monitor:

- Use adequate lighting for the type of work you are performing.
- Use the monitor brightness, contrast, and image adjustment controls, if equipped, to optimize the image on your screen to meet your visual preferences.
- Keep your monitor screen clean so you can focus on the screen's contents.

Any concentrated and sustained visual activity can be tiring for your eyes. Be sure to periodically look away from your monitor screen and focus on a far object to allow your eye muscles to relax. If you have questions on eye fatigue or visual discomfort, consult a vision care specialist for advice.

Quick tips for healthy work habits

The following information is a summary of some important factors to consider to help you remain comfortable and productive while you use your computer.

- **Good posture starts with equipment setup:** The layout of your work area and the setup of your computer equipment have a large effect on your posture while using your computer. Be sure to optimize the position and orientation of your equipment by following the tips outlined in "Arranging your work area" on page 2-1 so you can maintain a comfortable and productive posture. Also, be sure to use the adjustment capabilities of your computer components and office furniture to best suit your preferences now and as your preferences change over time.
- **Minor changes in posture can help avoid discomfort:** The longer you sit and work in front of your computer, the more important it is to observe your working posture. Avoid assuming any one posture for an extended period of time. Periodically make minor modifications in your posture to help deter any discomforts that might arise. Make use of any adjustments that your office furniture or equipment provide to accommodate changes in posture.
- **Short, periodic breaks help ensure healthy computing:** Because computing is primarily a static activity, it is particularly important to take short breaks from your work. Periodically, stand up in front of your work area, stretch, walk for a drink of water, or otherwise take a short break from using your computer. A short break from work gives your body a welcome change in posture and helps to ensure you remain comfortable and productive while you do work.

Accessibility information

Lenovo is committed to providing greater access to information and technology to people with disabilities. With assistive technologies, users can access information in the way most appropriate to their disability. Some of these technologies are already provided in your operating system; others can be purchased through vendors or accessed at:

https://lenovo.sbbartgroup.com/lenovo/request_vpat.php









Adjusting your monitor image





This section describes the user control features used to adjust your monitor image.

Using the direct access controls

The direct access controls can be used when the On Screen Display (OSD) is not displayed.

Table 2-1. Direct access controls

	Icon	Name	Description
 		Menu/OK:	<ul style="list-style-type: none"> • Press to open main menu while there is no OSD on the screen. • Press to enter next level on main menu or sub menu , or move backwards through the sub menus. • Press and hold for 10 seconds to Lock/un-Lock all menu.
		Right key	<ul style="list-style-type: none"> • It is a shortcut for adjusting Color mode while there is no OSD on the screen. • Press to enter sub menu. • Press to adjust current values on adjustment bar.
		Left Key	<ul style="list-style-type: none"> • Return to the previous menu page or exit OSD menu. • Press to adjust current values on adjustment bar.
		Down Key	<ul style="list-style-type: none"> • It is a shortcut for adjusting Scenario mode (Default, User also can setup to other function in OSD quick setting)while there is no OSD on the screen. • Press to move lighting-indicator on main menu down to next one. • Press to decrease current values on adjustment bar • Press and hold for 3 seconds to Enable/Disable Conference/ Meeting indicator.
		Up Key	<ul style="list-style-type: none"> • Press to move lighting-indicator on main menu up to last one. • Press to choose last OSD item When lighting-indicator is on the first OSD item. • Press to increase current values on adjustment bar. • It is a shortcut for adjusting Brightness while there is no OSD on the screen.
	Source-selecting		It is a shortcut for changing input signal while there is no OSD on the screen or on power-saving mode.
	DDC-CI		Press and hold for 10 seconds to Enable/Disable the "DDC/ CI".
	Power button		Turns the monitor on/off. White indicates power on. Orange indicates standby/ power saving mode.



	Icon	Control	Description
1		Teams button & LED	<ul style="list-style-type: none"> • LED will light in static white when Microsoft Teams® is signed in and running. • LED will blink when there is a Teams notification. • Short press on the button to bring up Teams and open notification. Ensure that the Teams application is signed in and is already running at the background. • Teams button Long Press in a meeting only will Raise/ Lower hand. <p>Note: Requires a Teams APP version with this feature.</p>
2		Telephone switch & LED	<ul style="list-style-type: none"> • LED will blink in green when there is an incoming call. • LED will light up in static green during call. • Short press to answer / end call. • Long press to reject incoming call. <p>Note: This feature can only be used with the Teams app.</p>
3		Volume down & LED	<ul style="list-style-type: none"> • Short press to decrease volume. LED will blink when short press. • Long press the volume to continuously decrease. LED will light when long press.
4		Volume up & LED	<ul style="list-style-type: none"> • Short press to increase the volume. LED will blink when short press. • Long press to keep volume up. LED will light when long press.
5		Microphone mute & LED	<ul style="list-style-type: none"> • Press to mute and unmute the microphone. • When the microphone is muted, the LED lights up static red. • LED switches off when microphone is enabled/ unmuted.
<p>Note:</p> <ol style="list-style-type: none"> 1. To learn more about Teams button features, please visit the following link Use the Teams button on your certified Teams device (microsoft.com) 2. To enable Teams, Mute and Call buttons, you need to: <ul style="list-style-type: none"> • Go to Settings in Teams app and select from Audio devices the Audio Echo Cancelling Speakerphone (Lenovo T27QD-4v). • Connect the monitor with your computer with USB-C cable. 			

Using the On-Screen Display(OSD) controls

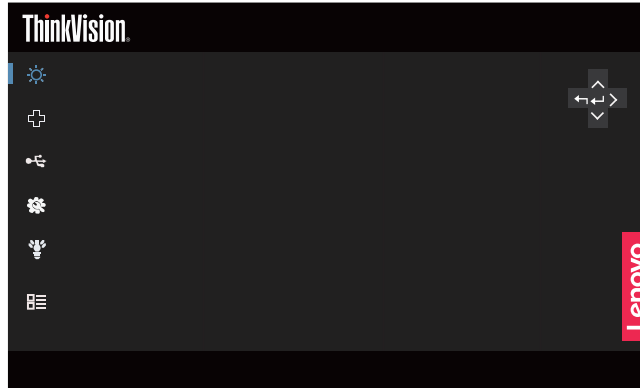
To adjust the settings, the user controls can be viewed through the OSD.



To use the controls:

1. Press  to open the main OSD menu.
2. Use Δ or ∇ to move among the icons. Select an icon and press \leftarrow to access the selected function. If there is a sub-menu, you can move between options using Δ or ∇ , then press \leftarrow to select that function. Use Δ or ∇ to make adjustments then press \leftarrow to save.
3. Press \leftarrow to move backwards through the sub-menus and exit from the OSD.
4. Press and hold \leftarrow for 10 seconds to lock the OSD. This will prevent accidental adjustments to the OSD. Press and hold \leftarrow for 10 seconds to unlock the OSD and allow adjustments to the OSD.
5. Enables DDC/CI by default. Use OSD Exit Key, Press and hold  for 10 seconds to disable/enable DDC/CI function. A message "DDC/CI disable" is shown on the screen.
6. The ENERGY STAR option resets all user settings to default values so that the monitor can meet the requirements of Energy Star.



Energy Star is an energy saving program for consumer electronics led by the U.S. government. It was launched in 1992 by EPA and DOE to reduce energy consumption and greenhouse gas emissions. Energy Star logo is a symbol of energy conservation and environmental protection. It improves the concept of energy efficiency of consumers and manufacturers, and effectively guides the market.

The regulation of Energy Star improves energy efficiency and reduces air pollution by using more energy-efficient equipment in homes, offices and factories. One way to achieve this goal is to use management to reduce energy consumption when products are not in use. The default settings for monitors conform to Energy Star certification. Any changes by users for more features and functionalities may increase power consumption, which will exceed the limitation of Energy Star's standard. If the user changes the options related to energy efficiency when using, such as brightness, color mode, etc., select All Reset Factory or choose the Energy Star option, the power consumption will be restored to the energy efficiency with Energy Star standard.

For more information, please refer to (www.energystar.gov/products). All products of Energy Star will be posted online and can be accessed directly by governments, public institutions and consumers.

Table 2-2. OSD functions

OSD Icon on Main Menu	Sub menu	Description	Note	
Monitor Controls	Brightness	0-100	Adjusts the overall brightness.	
	Color mode	sRGB	Select the color mode.	Red: Increases or decreases the saturation of 'red' in the image. Green: Increases or decreases the saturation of 'green' in the image. Blue: Increases or decreases the saturation of 'blue' in the image. Note: This function will be grayed out and unselectable. When the Scenario mode is set to E-Book mode.
		BT.709		
		Neutral		
		Warm		
		Cool		
		Custom		
	Contrast	0-100	Adjusts the contrast ratio. Note: This function will be grayed out and unavailable in sRGB/BT.709/E-Book mode.	
	Dynamic Contrast	On	When enabled, the monitor automatically assesses the overall brightness of the image and restores various color levels by reducing brightness in darker areas. This enhancement produces a clearer and more distinct image. Note: 1. When the Dynamic contrast is turn on, Brightness/Contrast/Color mode must be grayed out and cannot be selected. 2. When Dynamic contrast is turn on, HDR remains at the original setting (If the original setting is Auto, DCR will be automatically turn off once the HDR signal comes in).	
		Off		
	Over Drive	Off	Over drive improves a monitor's GtG (Grey-to-Grey) response time, a critical metric for assessing the responsiveness of a monitor. A shorter GtG time facilitates quicker screen transitions, resulting in smoother and clearer motion visuals. Note: This function will be grayed out and unavailable once the HDR signal comes in.	
		Normal		
		Extreme		
	Aspect ratio	Full Screen	Adjusts the ratio of the horizontal to vertical dimensions of the display image on the monitor, relative to the resolution signal transmitted by the device.	Note: This function will be grayed out and unavailable when the Panel resolution is a geometric Multiple of the Input signal resolution.
Orginal AR				
Button repeat rate	Default	Select the response speed of the button.		
	Slow			
	Off			
LED indicator	On/Off	When disabled, the LED remains off when the monitor is powered on.		
Power button lock	On/Off	When enabled, the power button is locked to prevent accidental pressing.		

OSD Icon on Main Menu	Sub menu	Description	Note
Quick settings	Right key	Brightness	Assigns the shortcut keys to user preferences. Options include Brightness, Color mode, Contrast, Scenario mode, Language.
	Down key	Color mode	
	Up key	Contrast Scenario mode Language	
Port Settings	Input Signal	Auto	Selects the input signal.
		USB-C	
		DisplayPort	
		HDMI	
	USB always On	On/Off	Please refer to Table 2-3 below for specific details.
	USB Select	USB 3.0/USB 2.0	Select either USB 3.0 or USB 2.0. When operating in USB 2.0 mode, the video bandwidth is maximized. However, switching to USB 3.0 mode reduces the effective bandwidth by 50%, which in turn limits the monitor's maximum supported resolution.
	USB-C Charging	Smart Power charging	When enabled, the monitor adaptively adjusts power output according to its load. The output ranges from 65W to 96W.
		Priority USB-C charging	When the priority USB-C charging function is enabled, the maximum output power is 96W.
	DP Daisy Chain	Auto	The Daisy Chain function of monitors allows for the connection of multiple displays in a chain. When this function is enabled, multiple monitors can be managed through a single DisplayPort on the computer.
		On	
		Off	
	Video range	Auto	The video range refers to the standard color spectrum of a video, specifically the value range of the Y component (brightness component) in a digital video signal. This feature processes the input HDMI signal and is available exclusively via HDMI.
		Full range 0-255	
Limited range 16-235			
Ethernet setting	On/Off	When this function is enabled, the PC or laptop connected to the monitor can access the network to which the monitor is connected.	
DP select	DP 1.4/DP 1.2	Select either DP 1.4 or DP 1.2. Note: This function will be grayed out and unselectable When PxF/True split/DP daisy chain is enabled or HDR/Panel replay is running.	

OSD Icon on Main Menu	Sub menu	Description	Note
Advanced settings	Scenario mode	Panel native	Select the scenario mode.
		Image creation (default sRGB)	
		Video creation (default BT.709)	
		E-Book mode	
	Mirrored power button	On/Off	<p>When this function is enabled, the monitor's power button can turn devices connected to the USB-C port on or off.</p> <p>This function works only when a USB-C connection is established, and the connected device must be a Lenovo device that supports VDM (Vendor Defined Messages) .</p> <p>The function is unavailable when the monitor's power button lock is enabled or when in PIP (Picture-in-Picture) or PBP (Picture-by-Picture) mode.</p> <p>The USB Always On function will be activated simultaneously.</p> <p>If USB Always On is toggled from On to Off, the power button will automatically turn off the mirror.</p> <p>If USB Always On is toggled from Off to On, it will not impact the functionality of the power button for the mirror.</p>
	VRR(HDMI2.1)	Auto/Off	<p>VRR (Variable Refresh Rate) , When this function is enabled, the monitor refresh rate will adapt to the source.</p> <p>Note: Only available under HDMI 2.1 Source.</p>
	Conference/ Meeting indicator	Auto/On/Off	<p>The indicator at the top of the display lights up to notify others that you are currently occupied.</p> <p>Auto: when the camera is activated or the headset is plugged in, the top indicator lights up.</p>
Video/Audio Icon	On/Off		
Ambient light sensor	On/Off	<p>When enabled, the monitor's brightness adjusts automatically based on ambient light.</p> <p>Note: This function will be grayed out and unselectable When AI Power saving is enabled or HDR is running.</p>	

OSD Icon on Main Menu	Sub menu	Description	Note
Smart Feature	Presence Detection	Off	The response time from the time the person leaves the monitor to the time the screen is dimmed. (Fast: 15s/Normal: 40s/Slow: 70s) Attention: 1, the best working distance between the user and the front of the monitor is 300-1000mm (12 to 40 inches) 2, dazzling lights may affect the normal operation of the sensor. 3. Some materials may trigger sensors. 4. Do not touch the sensor. Fingerprints, scratches, or any damage may impair its performance. Additionally, ESD can disrupt the sensor's normal operation.
		Fast	
		Normal	
		Slow	
	Sitting Reminder	On	The monitor can detect the time the user uses the monitor. If the value is set to ON, a prompt icon will appear in the upper left corner of the screen every 20 minutes after the user uses the monitor. The prompt will blink at a 1s frequency for 20s. Prompt priority: Sitting Reminder>Distance Warning>Video/Audio Icon
		Off	
	Distance Warning	On	The monitor can detect the distance between the user and the monitor. When the user reaches a certain distance from the monitor, a prompt icon will appear in the upper left corner of the screen. The prompt will blink at a frequency of 1s for 20 seconds.
		Off	
	Multi-person detection	On	When the monitor detects more than two individuals observing, an icon is displayed.
		Off	
	Smart face framing	On	Digital zoom ensures that the face remains in the middle.
		Off	
	Smart volume control	On	The volume level is automatically adjusted based on distance, and the transition between sound devices does not produce a noticeable difference.
		Off	
Smart Audio	On	When this function is enabled, the microphone prioritizes capturing sound in front of the monitor. Speech outside the capture area is significantly suppressed, but not completely eliminated.	
	Off		

OSD Icon on Main Menu	Sub menu	Description	Note
Menu settings	DP power saving mode	Panel replay/Off	After a specified period of inactivity, the monitor automatically reduces its refresh rate to 48Hz to conserve energy.
	Information	Model name Refresh Rate Firmware Serial number	Display the main information of the model.
	Language	English/ 简体中文 / 繁體中文 / 日本語 / Français / Italiano / Español / Deutsch / Русский / ไทย / Українська	Change the language of the OSD menu. Note: The selected language only affects the language of the OSD. It has no effect on any software running on the computer.
	OSD rotation	Normal	Adjust the rotation of OSD.
		90	
		180	
		270	
	OSD position	0~100 (H,V)	Adjust the position of OSD.
OSD timeout	5~115	Set time of the OSD will remain active after the last time a button is pressed.	
Transparency	0~100	Adjust the transparency of OSD.	
Factory reset	Reset	Resets monitor to the original factory settings. The ENERGY STAR logo indicates resetting all user settings to default values to ensure the monitor can meet Energy Star requirements.	
	No		
<p>*The use of Extreme Mode (response time) may result in reduced display quality when fast moving video graphics are displayed. Users should check Extreme Mode (response time) to verify if it is compatible with any applications they would like to use it with.</p> <p>*Low Blue Light: The display uses the low blue light panel. It complies with TÜV Rheinland Low Blue Light Hardware Solution certification under factory reset/default setting.</p>			

Table 2-3 for "USB always On"

OSD option "USB always On"		On		Off(Default)	
Upstream status		Connected	Unconnected	Connected	Unconnected
Monitor DC On mode	Power Delivery (upstream)	Enable	N/A	Enable	N/A
	USB Data (downstream)	Enable	N/A	Enable	N/A
	USB charge (downstream)	Enable	Enable	Enable	Disable
	LAN	Enable	N/A	Enable	N/A
Monitor standby mode	Power Delivery (upstream)	Enable	N/A	Enable	N/A
	USB Data (downstream)	Enable	N/A	Enable	N/A
	USB charge (downstream)	Enable	Enable	Enable	Disable
	LAN	Enable	N/A	Enable	N/A
Monitor DC Off mode	Power Delivery (upstream)	Enable	N/A	Disable	N/A
	USB Data (downstream)	Enable	N/A	Disable	N/A
	USB charge (downstream)	Enable	Enable	Disable	Disable
	LAN	Enable	N/A	Disable	N/A

Feature

This section describes how to use the Smart Features of this monitor.

Conference/Meeting indicator

1. There are On/Off/Auto modes for the light.
2. Press the Down key for 3 seconds can easily switch On/Off.
3. The Conference/Meeting indicator the monitor working status of camera and microphone at "Auto" mode.
4. USB upstream must be connected for it to work.



Press the Menu key to access the OSD menu, select **Advanced settings** to access the sub-menu of the next level, and then select the **Conference/Meeting indicator** option to access the function interface, as shown in the following figure OSD menu:



Note: To connect USB Type-C port to enable the function.

Presence Detection

The screen will dim when it is detected that the user is away. The screen will be turned off gradually 10 seconds after the function is triggered. The power indicator will start blinking for notice.

Fast / Normal / Slow: Refers to the response speed from when the user is away to when the screen starts dimming

Presence Detection: After "Presence Detection" is enabled, the monitor can detect whether the user is sitting in front of the monitor. The backlight will be turned off if the user is not sitting in front of the monitor.

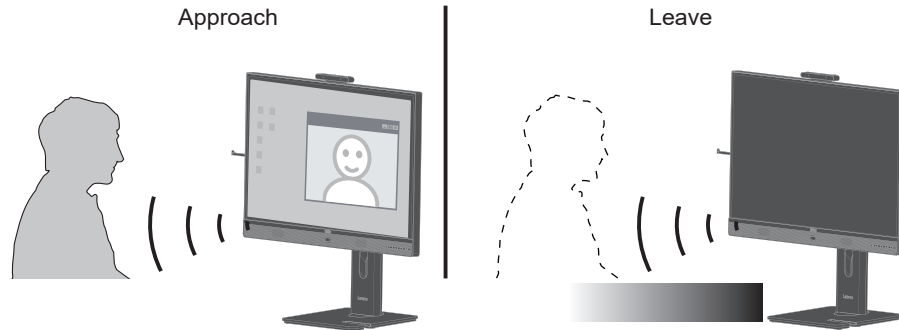

Press the Menu key to access the OSD menu, select **Smart Feature** to access the sub-menu of the next level, and then select the **Presence Detection** option to access the function interface, as shown in the following figure OSD menu:

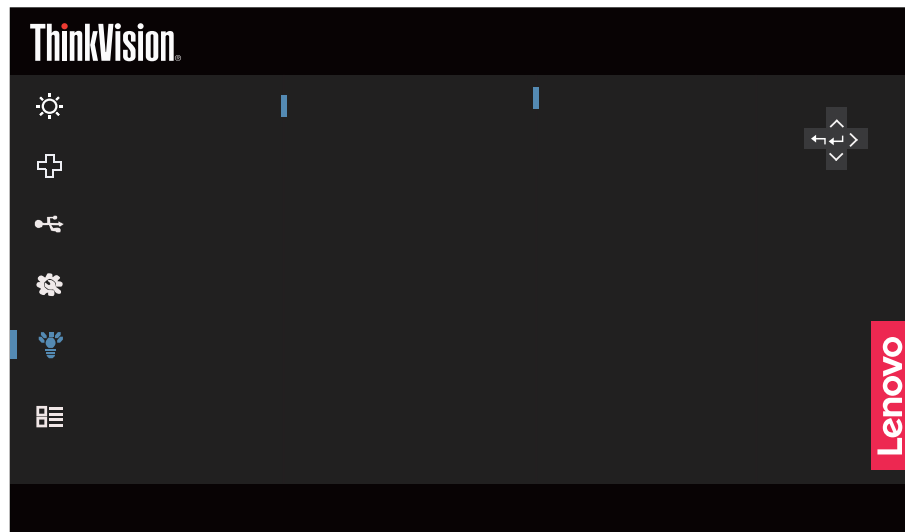

Note:

1. The optimal distance between the user and the front of the monitor is 300 - 1,000 mm (about 12 - 40 inches)
2. The sensor might not work correctly due to bright lights.
3. The sensor might be triggered by the material of some chairs.
4. Do not touch the fingerprint, scratch, or damage of the sensor, which might affect the performance of the sensor. ESD might affect the normal operation of the sensor.

Sitting Reminder

The monitor can detect how long the user has been using itself. If the user enables this feature, a prompt icon will appear and blink on the upper-left corner of the screen around 20 minutes when the user is using the monitor.



Press the Menu key to access the OSD menu, select **Smart Feature** to access the sub-menu of the next level, and then select the **Sitting Reminder** option to access the function interface, as shown in the following figure OSD menu:



Note:

Before enabling the Sitting Reminder function, you must first enable Presence Detection so that the detection function can work normally.

Distance Warning

The monitor can detect the distance between the user and itself. When the distance reaches a specific range, a prompt icon will appear on the upper-left corner of the screen. The icon blinks at the frequency of 1 second for 20 seconds. The prompt will continue if the distance remains unchanged.

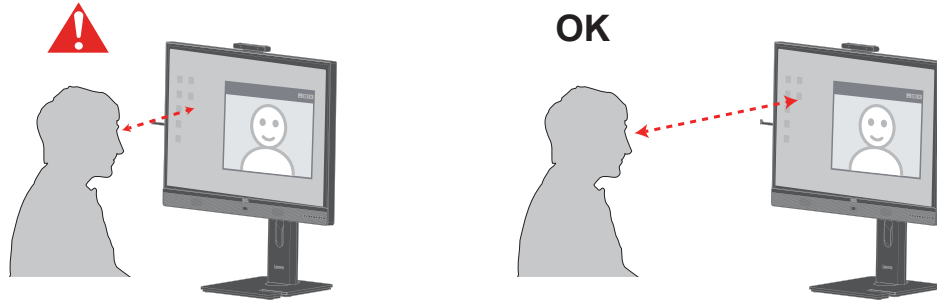

Press the Menu key to access the OSD menu, select **Smart Feature** to access the sub-menu of the next level, and then select the **Distance Warning** option to access the function interface, as shown in the following figure OSD menu:

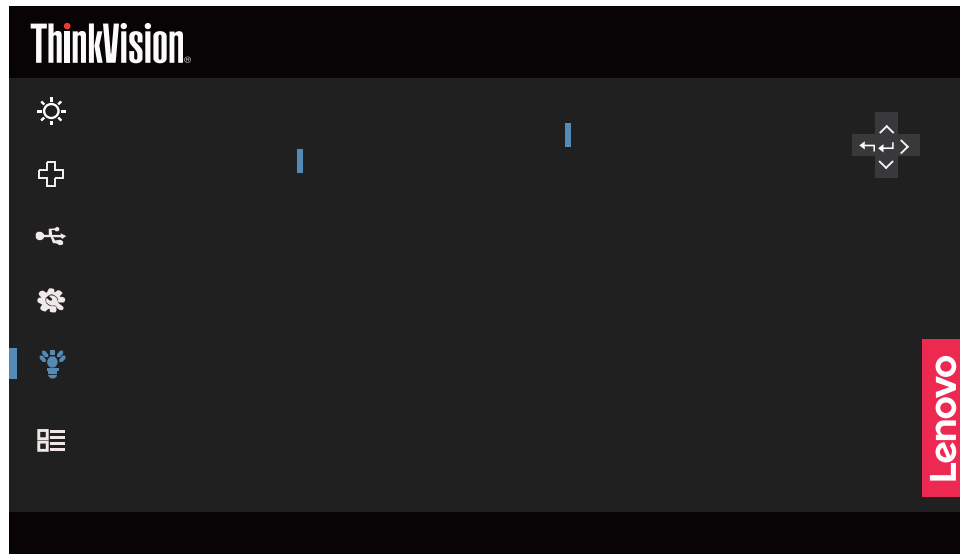

Note:

Before enabling the Distance Warning function, you must first enable Presence Detection so that the detection function can work normally.

Multi-person detection

When the function is turned on and multiple personal are detected, a prompt icon will appear in the upper left corner of the screen and flash.

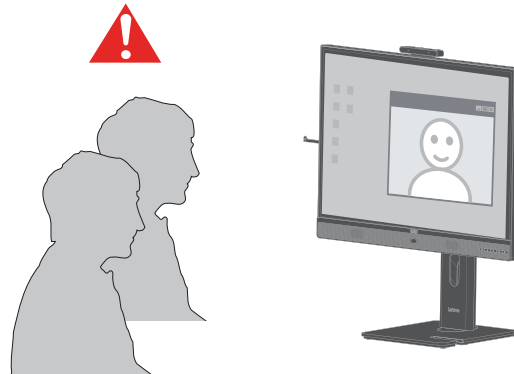

Press the Menu key to access the OSD menu, select **Smart Feature** to access the sub-menu of the next level, and then select the **Multi-person detection** option to access the function interface, as shown in the following figure OSD menu:



Note:

1. The function may not work properly in low-light environments.
2. The face must not be obscured.
3. There is a chance of false detection for face-like objects.

Smart face framing

When the function is turned on and person's faces are not in the center of the camera, the monitor will use digital zoom to keep person's face in the center of the screen.

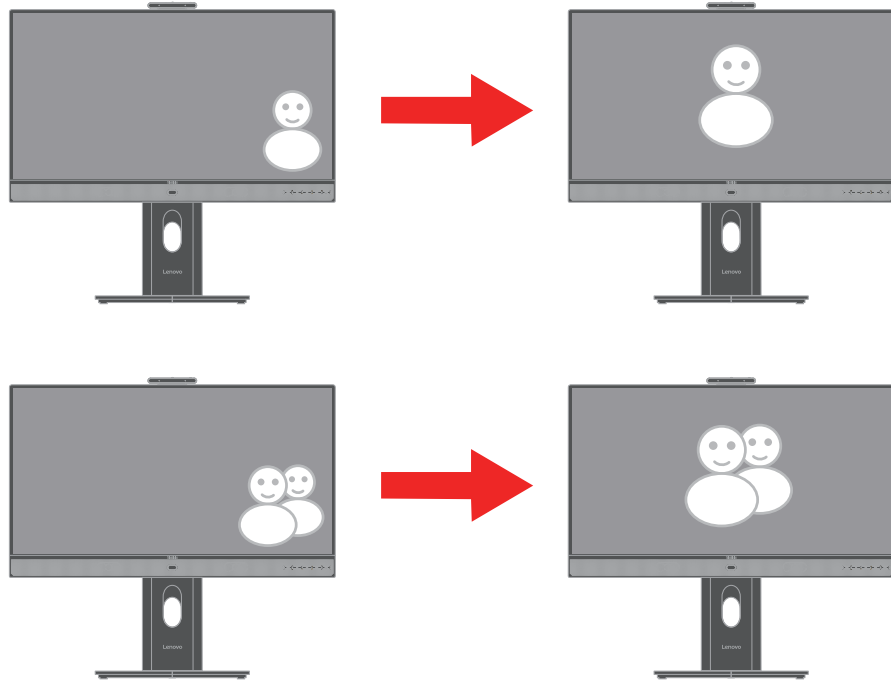

Press the Menu key to access the OSD menu, select Smart Feature to access the sub-menu of the next level, and then select the Smart face framing option to access the function interface, as shown in the following figure OSD menu:



Note:

1. If it's too close to the border. The camera cannot focus successfully. So the image may not be centered.
2. If the character is constantly moving fast, the camera may not work because of a focus failure.
3. If there are multiple faces in the picture, the camera will select some faces for zoom amplification

according to the algorithm, and you can readjust the position facing the display screen to meet the use expectations.

4. Check your CPU of NB/PC to keep high efficiency (Please use adapter instead of internal Battery when using NB).

5. Sometimes you might find the face can be enlarged, not be centralized when your face is in the edge of the image that camera captured, please move your face close to centre.

Smart volume control

When the function is turned on, monitor will control the volume according to the distance automatically. And it does not give people the feeling of a particularly large sound difference. when switching between sound devices.

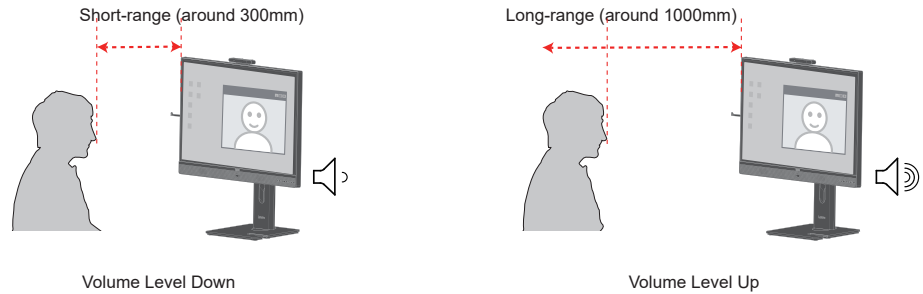

Press the Menu key to access the OSD menu, select Smart Feature to access the sub-menu of the next level, and then select the Smart volume control option to access the function interface, as shown in the following figure OSD menu:



Note:

1. When the function is turned on, VOLUME CONTROL can still be operated. The actual operation of the VOLUME CONTROL will not take effect until the VOLUME CONTROL BAR disappears.
2. When the function is turned on and the earphone is plugged in, the function will be disabled. (OSD function display will not be grayed out. It will Keep on). And the earphone volume level starts at 0 and then returns to the actual volume level after three seconds.
3. When you plug out the earphone, the speak volume level starts at 0 and then returns to the actual volume after three seconds.
4. The Monitor automatically lowers speaker volume during near-field operation (~300mm).
5. The Monitor increases speaker volume automatically for far-field use (~1000mm)

Smart Audio

Off: No sound suppression around the microphone.

On: Microphone mainly catch the sound of the front area.

The speech out of catching area will be suppressed obviously but not disappear totally.

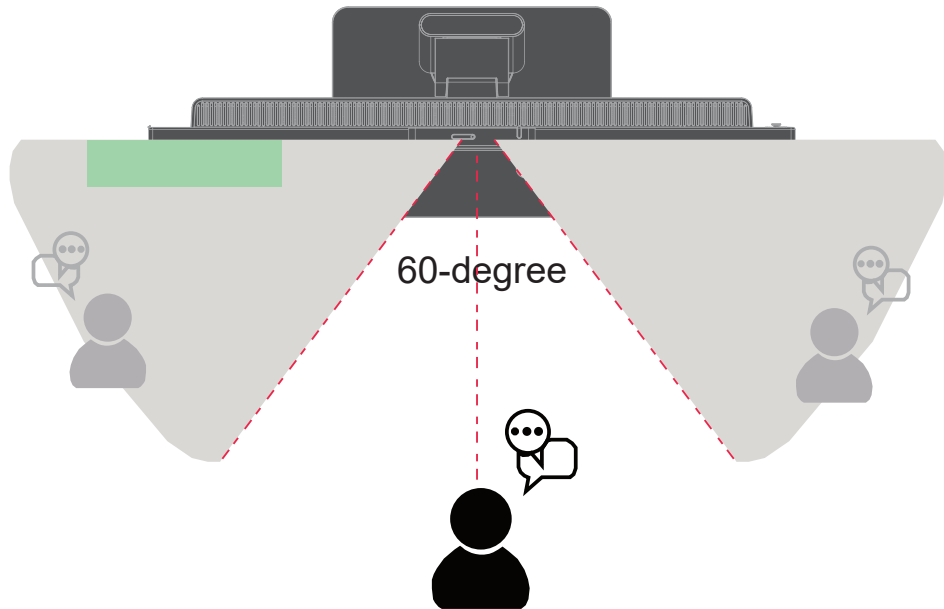

Press the Menu key to access the OSD menu, select **Smart Feature** to access the sub-menu of the next level, and then select the **Smart Audio** option to access the function interface, as shown in the following figure OSD menu:



Note:

1. To connect USB Type-C port to enable the function.
2. The environment, sound reflection or noise volume, will impact the function quality.

DP Power Saving Mode

DP(DisplayPort) Power Saving is a Lenovo-unique feature that uses Panel Replay technology to lower refresh rate (e.g. to 48Hz) to save power

Panel Replay

Panel Replay is an advanced display power-saving technology.

After Panel replay is enabled, under static image condition, the monitor will automatically drop from high refresh rate to low refresh rate , thus achieving power saving effect.

Enable Panel Replay

This feature is applicable when connecting USB-C or DisplayPort to the source.

Press the Menu key to access the OSD menu, select Advanced settings to access the sub-menu of the next level, and then select the DP power saving mode/Panel replay option to access.

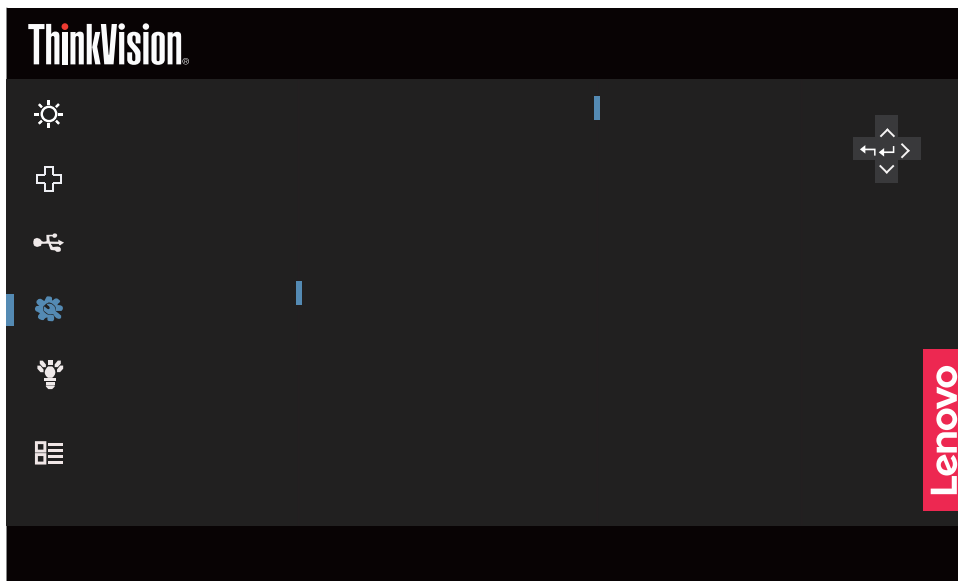

Support PC list

DP Power Saving (Panel Replay) can only be enabled with compatible PCs, please refer to <https://pcsupport.lenovo.com> for details.

Notes:

DP Power Saving (Panel Replay) is NOT supported when using the following features: PBP (Picture-by-Picture), PIP (Picture-in-Picture), True Split or Daisy Chain. When any of these features are enabled, the Panel Replay function will be grayed out (disabled) in the settings.

Selecting a supported display mode

The display mode of the monitor uses is controlled by the computer. Therefore, refer to your

computer documentation on how to change display modes.

The image size, position and shape might be changed when the display mode changes. This is normal and the image can be re-adjusted using automatic image setup and the image controls. Unlike CRT monitors, which require a high refresh rate to minimize flicker, LCD or Flat Panel technology is inherently flicker-free.

Note: If your system has previously been used with a CRT monitor and is currently configured to a display mode outside the range of this monitor, you may need to reattach the CRT monitor temporarily until you have re-configured the system; preferably to 2560 x 1440 at 60 Hz, which is a common display mode.

The display modes shown below have been optimized at the factory.

Table 2-3 Factory set display modes

Timing	Refresh rate(Hz)
640x480	60 Hz
640x480	67 Hz
640x480	72 Hz
640x480	75 Hz
720x400	70 Hz
800x600	60 Hz
800x600	72 Hz
800x600	75 Hz
832x624	75 Hz
1024x768	60 Hz
1024x768	70 Hz
1024x768	75 Hz
1280x800	60 Hz
1280x1024	60 Hz
1280x1024	75 Hz
1440x900	60 Hz
1600x900	60 Hz
1680x1050	60 Hz
1920x1080	60 Hz
1920x1080	100 Hz
1920x1080	120 Hz
2560x1440	60 Hz
2560x1440	75 Hz
2560x1440	100 Hz
2560x1440	120 Hz
480p	60 Hz
576p	50 Hz

720p	50 Hz, 60 Hz
1080p	50 Hz, 60 Hz, 120 Hz

Understanding power management

Power management is invoked when the computer recognizes that you have not using your mouse or keyboard for a user-definable period. There are several states as described in the table below.

For optimal performance, switch off your monitor at the end of each working day, or whenever you expect to leave it unused for long periods during the day.

Table 2-4. Power indicator

State	Power Indicator	Screen	Restoring Operation	Compliance
On	White	Normal		
Standby/ Suspend	Amber	Blank	Press a key or move the mouse. There may be a slight delay reappears. Note: Standby also occurs if there is no image output to the monitor.	ENERGY STAR
Off	Off	Blank	Press power key to switch on There may be a slight delay before the image reappears.	ENERGY STAR

Power Management Modes

VESA Modes	Horizontal Sync	Vertical Sync	Video	Power Indicator	Power Consumption
Normal operation	Active	Active	Active	White	173 W (maximum)* 23.4 W (typical)
Active-off mode	Inactive	Inactive	Off	Amber	Less than 0.5 W
Switch off	-	-	-	Off	Less than 0.3 W

Energy Star	Power Consumption
P_{ON}	20.4 W
E_{TEC}	67.4 kWh

*** Maximum power consumption with max luminance.**

This document is informational only and reflects laboratory performance. Your product may perform differently, depending on the software, components and peripherals you ordered and shall have no obligation to update such information. Accordingly, the customer should not rely upon this information in making decisions about electrical tolerances or otherwise. No warranty as to accuracy or completeness is expressed or implied.

Caring for your monitor

Be sure to turn off the power before you perform any maintenance on the monitor.

Do not:

- Apply water or liquid directly to your monitor.
- Use solvents or abrasives.
- Use flammable cleaning materials to clean your monitor or any other electrical equipment.
- Touch the screen area of your monitor with sharp or abrasive items. This type of contact may cause permanent damage to your screen.
- Use any cleaner which contains an anti-static solution or similar additives. This may harm the coating of the screen area.

Do:

- Lightly dampen a soft cloth with water and use this to gently wipe the covers and the screen.
- Remove grease or finger marks with a damp cloth and a little mild detergent.

Detaching the monitor base and stand

Step 1: Place the monitor on a soft and flat surface.

Step 2: Press and hold the stand release button.

Step 3: Lift the stand up and away from the monitor.

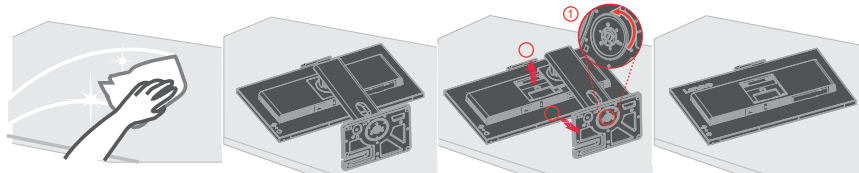

Wall Mounting (Optional)

Refer to the instructions that come with the base mounting kit. To convert your LCD display from a desk-mounted to a wall-mounted display, do the following:

Step 1: Verify that the Power button is turned Off, then disconnect the power cord.

Step 2: Lay the LCD display face down on a towel or blanket.

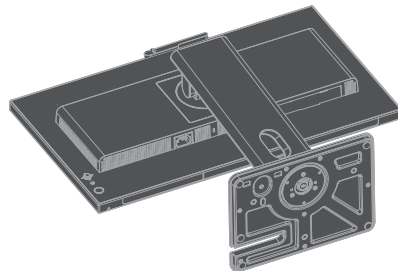

Step 3: Remove the base and stand from the monitor, refer to “Detaching the monitor base and stand” on page 2-24.

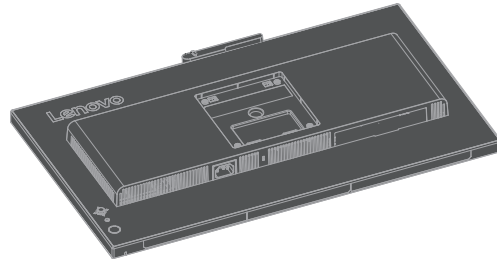

Step 4: Attach the mounting bracket from the VESA compatible wall mounting kit. (100mm x100mm distance), the type of VESA mounting screw is M4 x 10 mm.

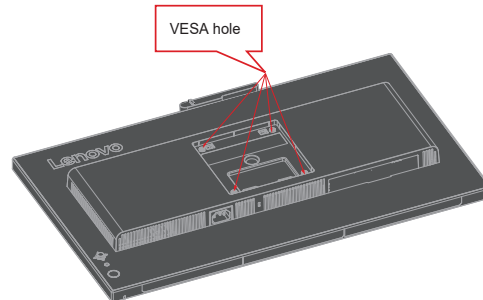

Step 5: Attach the LCD display to the wall, and follow the instructions in the wall-mounting kit.
For use only with UL Listed Wall Mount Bracket with minimum weight/load: 8kg

Chapter 3. Reference information

This section contains monitor specifications, instructions to manually install the monitor driver, troubleshooting information.

Monitor specifications

Table 3-1. Monitor specifications for type-model A25270QT0/T27QD-4v/64B8UAR1WW

Dimensions	Depth	208 mm (8.19 in.)
	Height	473.6mm (18.65 in.)
	Width	613.6 mm (24.16 in.)
Stand	Tilt	Range: -5°~23.5°
VESA mount	Supported	100 mm x 100 mm (3.94 in. x 3.94 in.)
Image	Viewable image size	686 mm (27 in.)
	Maximum height	335.664 mm (13.22 in.)
	Maximum width	596.736 mm (24.49 in.)
	Pixel pitch	0.2331mm (0.01 in.)
Power input	Supply voltage	100-240V AC
	Max supply current	2.5A
Power consumption Note: Power consumption figures are for the monitor and the power supply combined. Note: Typical power consumption is tested under OSD default setting.	Normal operation	<173 W (Max) <23.4 W (Typical)
	Standby/Suspend	<0.5 W * (The USB-C port is not included)
	Off	<0.3 W at 100VAC and 240VAC
DP	Interface	DP*
	Input signal	DP 1.4 (HBR2)
	Horizontal addressability	2560 pixels (max)
	Vertical addressability	1440 lines (max)
	Clock frequency	500 MHz (max)

HDMI	Interface	HDMI
	Input signal	VESA TMDS (Panel Link™)
	Horizontal addressability	2560 pixels (max)
	Vertical addressability	1440 lines (max)
	Clock frequency	500 MHz (max)
Type-C	Interface	Type-C
	Input signal	DP 1.4 (HBR2)
	Horizontal addressability	2560 pixels (max)
	Vertical addressability	1440 lines (max)
	Clock frequency	500 MHz (max)
	Power deliver	Support SPR 100W 20V(3.75A-4.8A/5A**) 15V3A&9V3A&5V3A Smart Power max up to 100W
	Deliver speed	USB3.2 Gen1 5G
Communications	VESA DDC/CI	
Supported Display Modes	Horizontal frequency	30 kHz – 183 kHz
	Vertical frequency	48 Hz – 120 Hz
	Native Resolution	2560 x 1440 at 60 Hz
Temperature	Operating	0° to 40°C (32°F to 104° F)
	Storage	-20° to 60°C (-4°F to 140° F)
	Shipping	-20° to 60°C (-4° F to 140° F)
Humidity	Operating	10% to 80% non-condensing
	Storage	5% to 95% non-condensing
	Shipping	5% to 95% non-condensing
Weight	Net Weight	7.17kg
Webcam	Resolution	Support QHD@30 fps, 1080p@30 fps, 720p@30 fps

* : DP1.4(HBR2: 21.6Gbit/s) HBR2: High Bit Rate2

** : The output rating(100W, 20V/5A) is designed based on the Lenovo VDM developed by Lenovo. This product can achieve the output rating(100W, 20V/5A) when it connects products that support Lenovo VDM developed by Lenovo.

The recommendation for DP Daisy Chain

1st video source	Timing / Color Depth	Maximum number of total monitors in Daisy Chain mode
DisplayPort	2560 x 1440 60Hz / 8bits	1

Note:

1. It is based on the DisplayPort 1.4/HBR2
2. The capability will be different based on the USB setting in USB C
3. The scenario will be different according to the OS and the capability of the GPU
4. The color depth will be different according to the OS and the capability of the GPU in HDR mode.
5. Daisy Chain & HDR Daisy Chain performance is controlled by graphic card.

Troubleshooting

If you have a problem setting up or using your monitor, you might be able to solve it yourself. Before calling your dealer or Lenovo, try the suggested actions that are appropriate to your problem.

Table 3-2. Troubleshooting

Problem	Possible cause	Suggested action	Reference
The words "Out of Range" are shown on the screen, and the power indicator is flashing white.	The system is set to a display mode which is not supported by the monitor	<ul style="list-style-type: none"> • If you are replacing an old monitor, reconnect it and adjust the display mode to within the specified range for your new monitor. • If using a Windows system, restart the system in safe mode, then select a supported display mode for your computer. • If these options do not work, contact the Customer Support Centre. 	"Selecting a supported display mode" on page 2-21
The image quality is unacceptable	The video signal cable is not connected with the monitor or system completely.	Be sure the signal cable is firmly plugged into the system and monitor.	"Connecting and turning on your monitor" on page 1-10
	The color settings may be incorrect.	Select another color setting from the OSD menu.	"Adjusting your monitor image" on page 2-3
	The automatic image setup function was not performed.	Perform automatic image setup.	"Adjusting your monitor image" on page 2-3
The power indicator is not lit and there is no image.	<ul style="list-style-type: none"> • The monitor's power switch is not switched on. • The power cord is loose or disconnected. • There is no power at the outlet. 	<ul style="list-style-type: none"> • Be sure the power cord is connected properly. • Be sure the outlet has power. • Power on the monitor. • Try using another power cord. • Try using another electrical outlet. 	"Connecting and turning on your monitor" on page 1-10
Screen is blank and power indicator is amber.	The monitor is in Standby / Suspend mode	<ul style="list-style-type: none"> • Press any key on the keyboard or move the mouse to restore operation. • Check the Power options settings on your computer. 	"Understanding power management" on page 2-23
The power indicator is amber, but there is no image	The video signal cable is loose or disconnected from the system or monitor	Be sure the video cable is connected with the system properly	"Connecting and turning on your monitor" on page 1-10
	The monitor brightness and contrast are at the lowest setting.	Adjust the brightness and contrast setting on the OSD menu.	"Adjusting your monitor image" on page 2-3

Problem	Possible cause	Suggested action	Reference
One or more of the pixels appear discolored	This is a characteristic of the LCD technology and is not an LCD defect	If there are more than five pixels missing, contact the Support Center	"Appendix A. Service and Support" on page A-1
<ul style="list-style-type: none"> • Fuzzy lines in text or a blurry image • Horizontal or vertical lines through the image. 	<ul style="list-style-type: none"> • Image setup has not been optimized • Your system Display Properties setting have not been optimized. 	Adjust the resolution settings on your system to match the native resolution for this monitor: 2560 x 1440 at 60 Hz.	"Adjusting your monitor image" on page 2-3
		Perform automatic image setup. If automatic image setup does not help, perform manual image setup.	"Feature" on page 2-12
		When working in the native resolution, you may find additional improvements by adjusting the Dots Per Inch (DPI) setting on your system.	See the Advanced section of your system's display properties.

Manually installing the monitor driver

Below are steps for manually installing the monitor driver in Microsoft Windows 10, Microsoft Windows 11.

1. Turn off the computer, all attached devices.
2. Ensure that the monitor is connected correctly.
3. Turn on the monitor and then the system unit. Allow your computer to start the Windows operating system.
4. From the Lenovo website https://pcsupport.lenovo.com/solutions/t27qd_4v, find the corresponding monitor driver and download it to a PC to which this monitor is connected (such as a desktop).
5. Right-click the Windows **Start** button on the desktop, then click **Device Manager**, and double click **Monitor**.
6. Double-click **Generic Monitor**.
7. Click the **Driver** tab.
8. Click **Update Driver**, and then click **Browse Computer to find the driver**.
9. Click **Let me pick from a list of available drivers on my computer**.
10. Click the **Have Disk...** button. By clicking the **Browse** button, browse and point to the following path: **X:\Monitor Drivers\Windows** (where X indicates “the folder in which the downloaded driver is located” (such as a desktop)).
11. Select **t27QD-4v.inf** file, Click **Open** button. Click **OK** button.
12. In the new window, select **T27QD-4v** and click **Next**.
13. After the installation is complete, delete all downloaded files and close all Windows.
14. Restart the system. The system will automatically select the refresh rate and the corresponding color matching profile.

Note: On LCD monitors, unlike CRTs, a faster refresh rate does not improve display quality. Lenovo recommends using either 2560 x 1440 at a refresh rate of 60 Hz, or 640 x 480 at a refresh rate of 60 Hz.

Getting further help

If you still can't solve your problem, please contact the Lenovo Support Center. For more information on contacting the Support Center, please see “Appendix A. Service and Support” on page A-1

Service information

Customer responsibilities

The warranty does not apply to a product which has been damaged due to accident, misuse, abuse, improper installation, usage not in accordance with product specifications and instructions, natural or personal disaster, or unauthorized alterations, repairs or modifications.

The following are examples of misuse or abuse and not covered by warranty:

- Images burned on to the screen of a CRT monitor. Burned image is preventable by utilizing a moving screen saver or power management.
- Physical damage to covers, bezel, base and cables.
- Scratches or punctures on monitor screens.

Service parts

The following parts are for use by Lenovo service, or Lenovo authorized dealers to support the customer warranty. Parts are for service use only. The table below shows information for model (A25270QT0/ T27QD-4v / 64B8UAR1WW).

Table 3-3. List of service parts

FRU (Field Replaceable Unit) Part number	Description	Machine Type Model (MTM)	colour
5C11P37221	USB-C Gen1 1.8m FRU--TPV	64B8	Raven Black
5C11S25075	DP1.2 cable 1.8m FRU--TPV	64B8	Raven Black
5CF1S60147	T27QD-4v - FRU Carton	64B8	Raven Black
5D11P36244	T27QD-4v - 27 inch FRU Monitor	64B8	Raven Black
5SE1P38248	T27QD-4v - FRU Stand and Base	64B8	Raven Black

Appendix A. Service and Support

The following information describes the technical support that is available for your product, during the warranty period or throughout the life of the product. Refer to your Lenovo Statement of Limited Warranty for a fully explanation of Lenovo warranty terms.

Registering your option

Register to receive product service and support updates, as well as free and discounted computer Accessories and content. Go to:
<http://www.lenovo.com/support>

Online technical support

Online technical support is available during the life of your product through the Lenovo Support Web site at <http://www.lenovo.com/support>

Product replacement assistance or exchange of defective components also is available during the warranty period, assistance for replacement or exchange of defective components is available. In addition, if your option is installed in a Lenovo computer, you might be entitled to service at your location. Your technical support representative can help you determine the best alternative.

Quebec Disclaimer

Quebec Disclaimer: English

IMPORTANT NOTICE FOR QUEBEC CONSUMERS:

In regard to section 79.18 of Quebec's Regulation respecting the application of the Consumer Protection Act, Lenovo in no way guarantees the availability of (a) replacement parts; (b) repair services; and (c) information necessary to maintain or repair the goods. For up-to-date information on the technical support and parts available for your purchase, please consult <https://support.lenovo.com/ca/en>.

Quebec Disclaimer: Canadian French

AVIS IMPORTANT POUR LES CONSOMMATEURS DU QUÉBEC:

En ce qui concerne l'article 79.18 du Règlement d'application de la Loi sur la protection du consommateur du Québec, Lenovo ne garantit en aucune façon la disponibilité des éléments suivants : (a) les pièces de rechange; (b) les services de réparation; et (c) les renseignements nécessaires à l'entretien à la réparation du bien. Pour obtenir des renseignements à jour sur le soutien technique et les pièces disponibles pour votre achat, veuillez consulter <https://support.lenovo.com/ca/fr>.

Telephone technical support

Installation and configuration support through the Customer Support Center will be available until 90 days after the option has been withdrawn from marketing. After that time, the support is cancelled, or made available for a fee, at Lenovo's discretion. Additional support is also available for a nominal fee.

Before contacting a Lenovo technical support representative, please have the following information available: option name and number, proof of purchase, computer manufacturer, model, serial number and manual, the exact wording of any error message, description of the problem, and the hardware and software configuration information for your system.

Your technical support representative might want to walk you through the problem while you are at your computer during the call.

Telephone numbers are subject to change without notice. The most up-to-date telephone list for Lenovo Support is always available at: <http://consumersupport.lenovo.com>

Country or Region	Telephone Number
Argentina	0800-666-0011 (Spanish, English)
Australia	1-800-041-267 (English)
Austria	0810-100-654 (local phone) (German)
Belgium	Warrant service and support: 02-339-36-11 (Dutch, French)
Bolivia	0800-10-0189 (Spanish)
Brazil	Calls made from within the Sao Paulo region: 11-3889-8986 Calls made from outside the Sao Paulo region: 0800-701-4815 (Portuguese)
Brunei Darussalam	800-1111 (English)
Canada	1-800-565-3344 (English, French)
Chile	800-361-213(Spanish)
China	Technical Support Line: 400-990-8888 (Mandarin)
China (Hong Kong S.A.R.)	(852) 3516-8977 (Cantonese, English, Mandarin)
China (Macau S.A.R.)	0800-807 / (852) 3071-3559 (Cantonese, English, Mandarin)
Colombia	1-800-912-3021 (Spanish)
Costa Rica	0-800-011-1029(Spanish)
Croatia	385-1-3033-120(Croatian)
Cyprus	800-92537(Greek)
Czech Republic	800-353-637(Czech)
Denmark	Warranty service and support: 7010-5150 (Danish)
Dominican Republic	1-866-434-2080(Spanish)
Ecuador	1-800-426911 (OPCION 4) (Spanish)
Egypt	Primary: 0800-0000-850 Secondary:0800-0000-744 (Arabic, English)
El Salvador	800-6264 (Spanish)
Estonia	372-66-0-800 (Estonian, Russian, English)

Country or Region	Telephone Number
Finland	Warranty service and support: +358-800-1-4260(Finnish)
France	Warranty service and support (hardware): 0810-631-213(French)
Germany	Warranty service and support: 0800-500-4618 (toll-free)(German)
Greece	Lenovo Business Partner (Greek)
Guatemala	Dial 999-9190, wait for operator, and request to reach 877-404-9661 (Spanish)
Honduras	Dial 800-0123(Spanish)
Hungary	+36-13-825-716 (English, Hungarian)
India	Primary: 1800-419-4666 (Tata) Secondary: 1800-3000-8465 (Reliance) Email: commercialts@lenovo.com (English and Hindi)
Indonesia	1-803-442-425 62 213-002-1090 (Standard Charges Apply) (English, Bahasa Indonesia)
Ireland	Warranty service and support: 01-881-1444 (English)
Israel	Givat Shmuel Service and Center: +972-3-531-3900 (Hebrew, English)
Italy	Warranty service and support: +39-800-820094 (Italian)
Japan	0120-000-817 (Japanese, English)
Kazakhstan	77-273-231-427(Standard charges Apply) (Russian , English)
Korea	1670-0088 (Collect Call) 02-3483-2829 (Toll Call) (Korean)
Latvia	371-6707-360(Latvian, Russian, English)
Lithuania	370 5278 6602(Italian, Russian, English)
Luxembourg	ThinkServer and ThinkStation: 352-360-385-343 ThinkCentre and ThinkPad: 352-360-385-222 (French)
Malaysia	1-800-88-0013 03-7724-8023 (Standard Charges Apply) (English)
Malta	356-21-445-566(English, Italian, Maltese Arabic)
Mexico	001-866-434-2080(Spanish)
Netherlands	020-513-3939 (Dutch)
New Zealand	0508-770-506 (English)
Nicaragua	001-800-220-2282 (Spanish)
Norway	8152-1550(Norwegian)
Panama	Lenovo Customer Support Center: 001-866-434(Toll-Free) (Spanish)
Peru	0-800-50-866 (OPCION 2) (Spanish)

Country or Region	Telephone Number
Philippines	1-800-8908-6454 (GLOBE subscribers) 1-800-1441-0719 (PLDT subscribers) (Tagalog, English)
Poland	Laptops and tablets branded with logo Think: 48-22-273-9777 ThinkStation and ThinkServer: 48-22-878-6999 (Polish, English)
Portugal	808-225-115 (Standard Charges Apply) (Portuguese)
Romania	4-021-224-4015(Romanian)
Russia	+7-499-705-6204 +7-495-240-8558 (Standard Charges Apply)(Russian)
Singapore	1-800-415-5529 6818-5315 (Standard Charges Apply) (English, Mandarin, Bahasa Malaysia)
Slovakia	ThinkStation and ThinkServer: 421-2-4954-5555
Slovenia	386-1-2005-60 (Slovenian)
Spain	34-917-147-833(Spanish)
Sri Lanka	+9477-7357-123 (Sumathi Information systems) (English)
Sweden	Warranty service and support: 077-117-1040 (Swedish)
Switzerland	Warranty service and support: 0800-55-54-54 (German, French, Italian)
Taiwan Region	0800-000-702 (Mandarin)
Thailand	001-800-4415-734 (+662) 787-3067 (Standard Charges Apply)(Thai, English)
Turkiye	0 212 912 01 34 (Turkish)
United Kingdom	Standard warranty support: 03705-500-900 (local rate) Standard warranty support: 08705-500-900(English)
United States	1-800-426-7378 (English)
Uruguay	000-411-005-6649 (Spanish)
Venezuela	0-800-100-2011 (Spanish)
Vietnam	120-11072 (Toll Free) 84-8-4458-1042 (Standard Charges Apply) (Vietnamese, English)

Appendix B. Notices

Lenovo may not offer the products, services, or features discussed in this document in all countries. Consult your local Lenovo representative for information on the products and services currently available in your area. Any reference to a Lenovo product, program, or service is not intended to state or imply that only that Lenovo product, program, or service may be used. Any functionally equivalent product, program, or service that does not infringe any Lenovo intellectual property right may be used instead. However, it is the user's responsibility to evaluate and verify the operation of any other product, program, or service.

Lenovo may have patents or pending patent applications covering subject matter described in this document. The furnishing of this document does not give you any license to these patents. You can send license inquiries, in writing to:

*Lenovo (United States), Inc.
1009 Think Place - Building One
Morrisville, NC 27560
U.S.A.
Attention: Lenovo Director of Licensing*

LENOVO PROVIDES THIS PUBLICATION "AS IS" WITHOUT WARRANTY OF ANY KIND, EITHER EXPRESS OR IMPLIED, INCLUDING, BUT NOT LIMITED TO THE IMPLIED WARRANTIES OF NON-INFRINGEMENT, MERCHANTABILITY OR FITNESS FOR A PARTICULAR PURPOSE.

Some jurisdictions do not allow disclaimer of express or implied warranties in certain transactions, therefore, this statement may not apply to you.

This information could include technical inaccuracies or typographical errors. Changes are periodically made to the information herein; these changes will be incorporated in new editions of the publication. Lenovo may make improvements and/or changes in the product(s) and/or the program(s) described in this publication at any time without notice.

The products described in this document are not intended for use in implantation or other life support applications where malfunction may result in injury or death to persons. The information contained in this document does not affect or change Lenovo product specifications or warranties. Nothing in this document shall operate as an express or implied license or indemnity under the intellectual property rights of Lenovo or third parties. All information contained in this document was obtained from specific environments and presented as an illustration. The result obtained in other operating environments may vary.

Lenovo may use or distribute any of the information you supply in any way it believe appropriate without incurring any obligation to you.

Any references in this publication to non-Lenovo Web sites are provided for convenience only and do not in any manner serve as an endorsement of those Web sites. The materials at those Web sites are not part of the materials for this Lenovo product, and use of those Web sites is at your own risk.

Any performance data contained herein was determined in a controlled environment. Therefore, the result obtained in other operating environments may vary significantly. Some measurements may have been made on development-level systems and there is no guarantee that these measurements will be the same on generally available systems. Furthermore, some measurements may have been estimated through extrapolation. Actual results may vary. Users of this

document should verify the applicable data for their specific environment.

Recycling information

Lenovo encourages owners of information technology (IT) equipment to responsibly recycle their equipment when it is no longer needed. Lenovo offers a variety of programs and services to assist equipment owners in recycling their IT products. For information on recycling Lenovo products, go to:

<http://www.lenovo.com/recycling>

環境配慮に関して

本機器またはモニターの回収リサイクルについて

企業のお客様が、本機器が使用済みとなり廃棄される場合は、資源有効利用促進法の規定により、産業廃棄物として、地域を管轄する県知事あるいは、政令市長の許可を持った産業廃棄物処理業者に適正処理を委託する必要があります。また、弊社では資源有効利用促進法に基づき使用済みパソコンの回収および再利用・再資源化を行う「PC回収リサイクル・サービス」を提供しています。詳細は、https://www.lenovo.com/jp/ja/services_warranty/recycle/pcrecycle/をご参照ください。

また、同法により、家庭で使用済みとなったパソコンのメーカー等による回収再資源化が2003年10月1日よりスタートしました。詳細は、https://www.lenovo.com/jp/ja/services_warranty/recycle/pcrecycle/をご参照ください。

重金属を含む内部部品の廃棄処理について

本機器のプリント基板等には微量の重金属（鉛など）が使用されています。使用後は適切な処理を行うため、上記「本機器またはモニターの回収リサイクルについて」に従って廃棄してください。

Collecting and recycling a disused Lenovo computer or monitor

If you are a company employee and need to dispose of a Lenovo computer or monitor that is the property of the company, you must do so in accordance with the Law for Promotion of Effective Utilization of Resources. Computers and monitors are categorized as industrial waste and should be properly disposed of by an industrial waste disposal contractor certified by a local government. In accordance with the Law for Promotion of Effective Utilization of Resources, Lenovo Japan provides, through its PC Collecting and Recycling Services, for the collecting, reuse, and recycling of disused computers and monitors. For details, visit the Lenovo Web site at

https://www.lenovo.com/jp/ja/services_warranty/recycle/pcrecycle/. Pursuant to the Law for Promotion of Effective Utilization of Resources, the collecting and recycling of home-used computers and monitors by the manufacturer was begun on October 1, 2003. This service is provided free of charge for home-used computers sold after October 1, 2003. For details, visit the Lenovo Web site at https://www.lenovo.com/jp/ja/services_warranty/recycle/personal/.

Disposing of Lenovo computer components

Some Lenovo computer products sold in Japan may have components that contain heavy metals or other environmental sensitive substances. To properly dispose of disused components, such as a printed circuit board or drive, use the methods described above for collecting and recycling a disused computer or monitor.

Turkish statement of compliance

The Lenovo product meets the requirements of the Republic of Turkey Directive on the Restriction of the Use of Certain Hazardous Substances in Electrical and Electronic Equipment (EEE).

Türkiye AEEE yönetmeliğine Uygunluk Beyanı

Bu Lenovo ürünü, T.C. Çevre Şehircilik ve İklim Değişikliği Bakanlığı'nın Atık Elektrikl ve Elektronik Eşyaların Kontrolü Yönetmeliğine (AEEE)" uygundur.

Lenovo and the Lenovo logo are trademarks of Lenovo in the United States, other countries, or both.

Ukraine RoHS

Цим підтверджуємо, що продукція Леново відповідає вимогам нормативних актів України, які обмежують вміст небезпечних речовин.

India RoHS

RoHS compliant as per E-Waste (Management & Handling) Rules, 2011.

Trademarks

The following terms are trademarks of Lenovo in the United States, other countries, or both:

Lenovo
The Lenovo logo
ThinkCentre
ThinkPad
ThinkVision

Microsoft, Windows, and Windows NT are trademarks of the Microsoft group of companies.

Other company, product, or service names may be trademarks or service marks of others.

Power cords and power adapters

Use only the power cords and power adapters supplied by the product manufacturer. Do not use the ac power cord for other devices.

Zambia

