



ThinkVision

ThinkVision E27-40

User Guide

Machine Type: 64BCMAR4WW



Product No.

H25270FE0

64BCMAR4WW

Version 1 (June 2025)

© All rights reserved Lenovo 2025

LENOVO products, data, computer software, and services are developed on earmarked funds and are sold to government agencies as commodities as defined in 48 C.F.R. 2.101, with limited restricted rights of use, duplication, and disclosure granted to the government agencies.

Restricted limited rights statement: If products, data, computer software, or services are delivered under a General Services Manager "GSA" contract, their use, duplication, or disclosure is subject to the restrictions outlined in Contract No. GS-35F-05925.

Contents

Safety Matters.....	iv
General Safety Principles.....	iv
TCO Certified	v
Chapter 1. New Member Guide.....	1-1
Items List.....	1-1
Precautions For Use.....	1-2
Product Overview.....	1-2
Set Up the Display.....	1-5
Chapter 2. Adjusting and Using the Display.....	2-1
Comfort and Assistance Functions.....	2-1
Arrange Your Working Area.....	2-1
Placing and Viewing the Display.....	2-1
Tips on Healthy Work Habits.....	2-2
Auxiliary function Information.....	2-2
Adjusting the Display Image.....	2-3
Select Supported Display Modes.....	2-7
Understanding Power Management.....	2-8
Maintaining the Display.....	2-9
Remove the monitor base and bracket	2-9
Wall-mounted (optional).....	2-9
Chapter 3. Reference Information.....	3-1
Display Specifications.....	3-1
Troubleshooting.....	3-3
Manually Install the Driver for the Display.....	3-5
Appendix A. Services and Support.....	A-1
Quebec Disclaimer.....	A-1
Telephone Technical Support.....	A-1
Appendix B. Declaration.....	B-1
Trademark.....	B-2
Power Cord.....	B-2

Safety Matters

General Safety Principles

For tips on safe computer use, please go to:

<http://www.lenovo.com/safety>

Before installing this product, please read the safety matters.

Avant d'installer ce produit, lisez les consignes de sécurité.

Vor der Installation dieses Produkts die Sicherheitshinweise lesen.

Πριν εγκαταστήσετε το προϊόν αυτό, διαβάστε τις πληροφορίες ασφάλειας (safety information).

לפני שהתקינו מוצר זה, קראו את הוראות הבטיחות.

A termék telepítés előtt olvassa el a Biztonsági Tudnivalókat!

Prima di installare questo prodotto, leggere le Informazioni sulla Sicurezza.

Antes de instalar este produto, leia as Informações de Segurança.

Läs säkerhetsinformationen innan du installerar den här produkten.

Prije instaliranja ovog produkta obavezno pročitajte Sigurnosna Upute.

Les sikkerhetsinformasjonen (Safety Information) før du installerer dette produktet.

Przed zainstalowaniem tego produktu, należy zapoznać się z książką "Informacje dotyczące bezpieczeństwa" (Safety Information).

Пред да се инсталира овој продукт, прочитајте информацијата за безбедност

Pred inštaláciou tohto zariadenia si prečítajte Bezpečnostné predpisy.

Pred namestitvijo tega proizvoda preberite Varnostne informacije.

Ennen kuin asennat tämän tuotteen, lue turvaohjeet.

Před instalací tohoto produktu si přečtěte příslušné bezpečnostní instrukci.

在安装本产品之前，请仔细阅读 Safety Information (安全信息)。

安装本产品之前,请先阅读「安全信息」。

Before installing this product, please read the Safety Information carefully.

Bacalah informasi keselamatan dengan saksama sebelum memasang produk ini.

Vă rugăm să citiți cu atenție informațiile de siguranță înainte de a instala acest produs.

Pažljivo pročitajte bezbednosne informacije pre nego što instalirate ovaj proizvod.

โปรดอ่านข้อมูลความปลอดภัยอย่างละเอียดก่อนติดตั้งก้อนนี้

Bu ürünü kurmadan önce lütfen güvenlik bilgilerini dikkatlice okuyun.

Будь ласка, уважно прочитайте інформацію про безпеку перед встановленням цього виробу.

يجب قراءة إرشادات السلامة قبل تشغيل هذا المنتج.

Læse sikkerhedsforskrifterne, før du installerer dette produkt.

製品の設置の前に、安全情報をお読みください。

본 제품을 설치하기 전에 안전 정보를 읽으십시오。

Antes de instalar este producto lea la Información de seguridad.

Antes de instalar este produto, leia as Informações de Segurança.

Перед установкой продукта прочтите инструкции по безопасности.

Lees voordat u dit product installeert eerst de veiligheidsvoorschriften.

Note: This equipment is not suitable for use in locations where children are likely to be present.

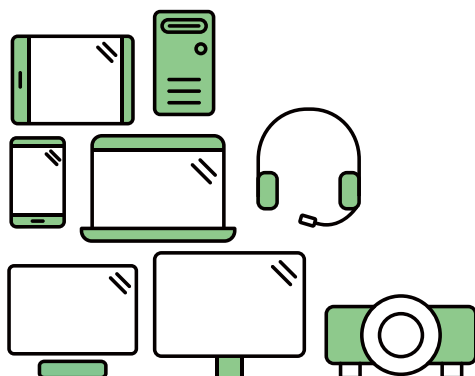

Say hello to a more sustainable product

IT products are associated with a wide range of sustainability risks throughout their life cycle. Human rights violations are common in the factories. Harmful substances are used both in products and their manufacture. Products can often have a short lifespan because of poor ergonomics, low quality and when they are not able to be repaired or upgraded.

This product is a better choice. It meets all the criteria in TCO Certified, the world's most comprehensive sustainability certification for IT products. Thank you for making a responsible product choice, that help drive progress towards a more sustainable future!

Criteria in TCO Certified have a life-cycle perspective and balance environmental and social responsibility. Conformity is verified by independent and approved verifiers that specialize in IT products, social responsibility or other sustainability issues. Verification is done both before and after the certificate is issued, covering the entire validity period. The process also includes ensuring that corrective actions are implemented in all cases of factory non-conformities. And last but not least, to make sure that the certification and independent verification is accurate, both TCO Certified and the verifiers are reviewed regularly.

Want to know more?

Read information about TCO Certified, full criteria documents, news and updates at tcocertified.com. On the website you'll also find our Product Finder, which presents a complete, searchable listing of certified products.

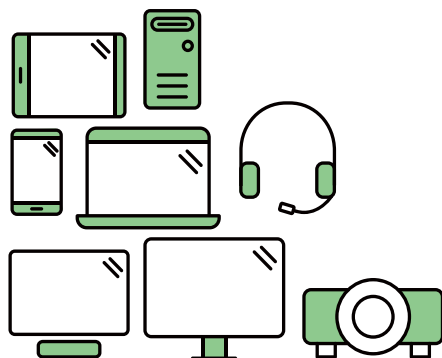

Say hello to a more sustainable product

IT products are associated with a wide range of sustainability risks throughout their life cycle. Human rights violations occur in the supply chain. Harmful substances are used both in products and their manufacture. Products can often have a short lifespan because of poor ergonomics, low quality and when they are not able to be repaired or upgraded.

This product is a better choice. It meets all the criteria in TCO Certified, the world's most comprehensive sustainability certification for IT products. Additionally, it fulfills the requirements of TCO Certified Edge, the supplemental certification that recognizes leading-edge products that exceed typical performance in a particular sustainability attribute. At our Product Finder (tcocertified.com/product-finder) you can find out which TCO Certified Edge criterion or criteria this product meets.

Criteria in TCO Certified have a life-cycle perspective and balance environmental and social responsibility. Compliance is verified by independent verification organizations that specialize in IT products, social responsibility or other sustainability issues. Verification is done both before and after the certificate is issued, covering the entire validity period. The process also includes ensuring that corrective actions are implemented in all cases of factory non-conformities.

Thank you for making a responsible product choice, that help drive progress towards a more sustainable future!

Want to know more?

Read information about TCO Certified, full criteria documents, news and updates at tcocertified.com. On the website you'll also find our Product Finder, which presents a complete, searchable listing of certified products.

Chapter 1. New Member Guide

This user guide provides users with detailed operating instructions. For a quick overview of the instructions, please refer to the Setup coloring page for brief information.

Items List

The following items should be included in the package of this product:

- Quick Start Guide
- Display
- Stand
- Base
- Power Cord
- Signal Line (Subject to the practice)
- Package of screws (Screws *4PCS)



Note: Total 4 screws.



Note: The signal cable is subject to actual conditions.

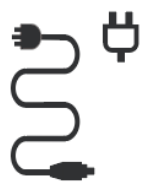

Precautions For Use

To set up your display, please refer to the following illustration.

Note: Do not touch the screen area of the display. The screen area is a glass product and can be easily damaged by friction or pressure.



1. Place the display screen down on a soft flat surface.
2. Align the stand with the base, and then tighten the screws clockwise.
3. Align the support base with the VESA hole on the back of the monitor and tighten the screws clockwise.

Note: To install the VESA mount, see "Wall-mounted (optional)" on pages 2-9.

Product Overview

This section describes how to adjust the display position, set the user controls, and use the cable lock slot.

Adjustment Types

Tilt

See the figure below for an example of the tilt range.

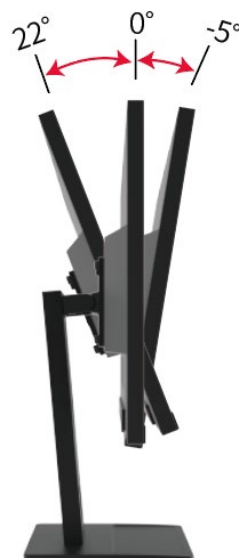

Height Adjustment

155mm



Pivot

Before the display is shown in the vertical direction, it should be fully lift up and fully tilted to avoid collisions.



Pivot: $-90^{\circ} \sim 90^{\circ}$

Swivel

You can tilt and rotate the display to get the best viewing angle.

Swivel: $-360^{\circ} \sim 360^{\circ}$

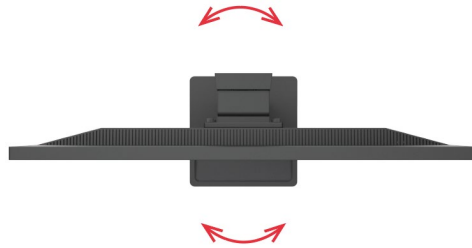

Display Control

Different functions can be used through the key controls on the panel frame.



For information on how to use these key controls, see "Adjusting the Display Image" on pages 2-3.

Kensington anti-theft lock

Your display is equipped with a Kensington anti-theft lock, which is located on the back of the display.

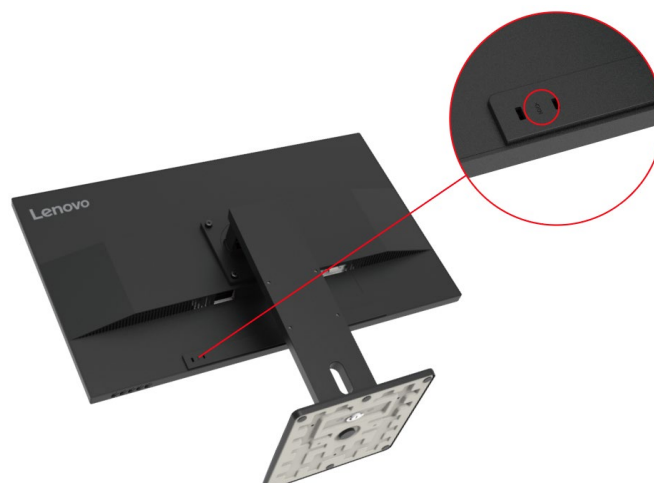

Set Up the Display

This section describes how to set up the display.

Connecting and Powering on the Display

Note: Before performing this procedure, be sure to read the "Safety Matters" on page iv.

1. Turn off the power to the computer and all connected devices, and then unplug the computer's power cord.



2. Connect the cables as shown in the figure below.

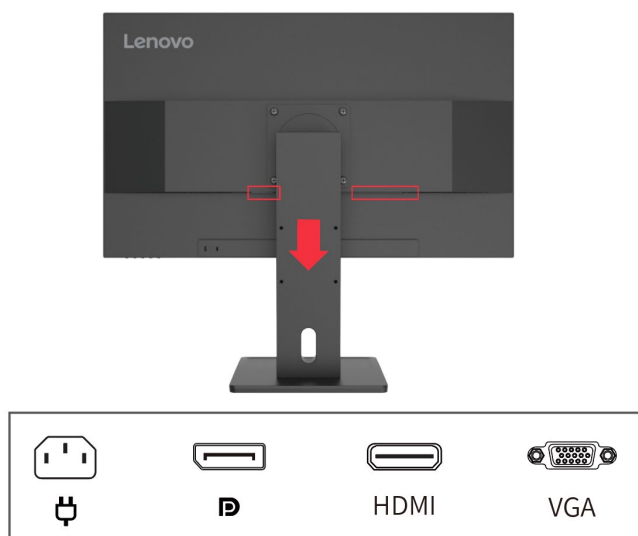

3. For computers with VGA connections.

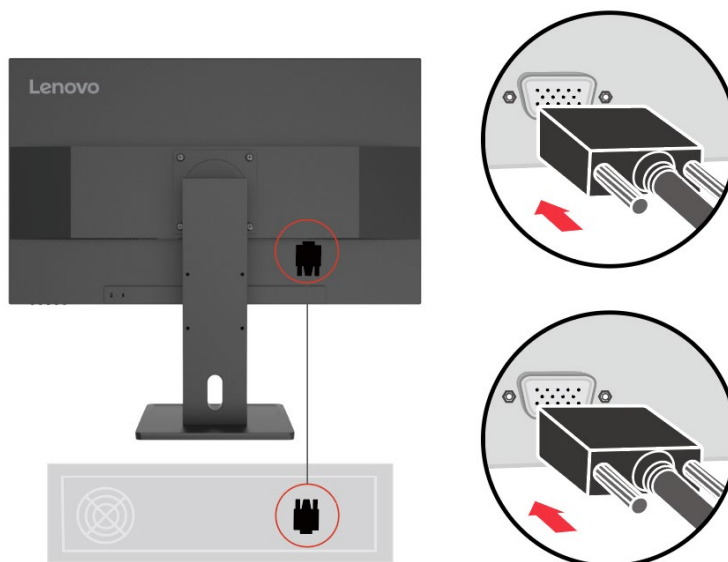

4. For computers with HDMI connections.

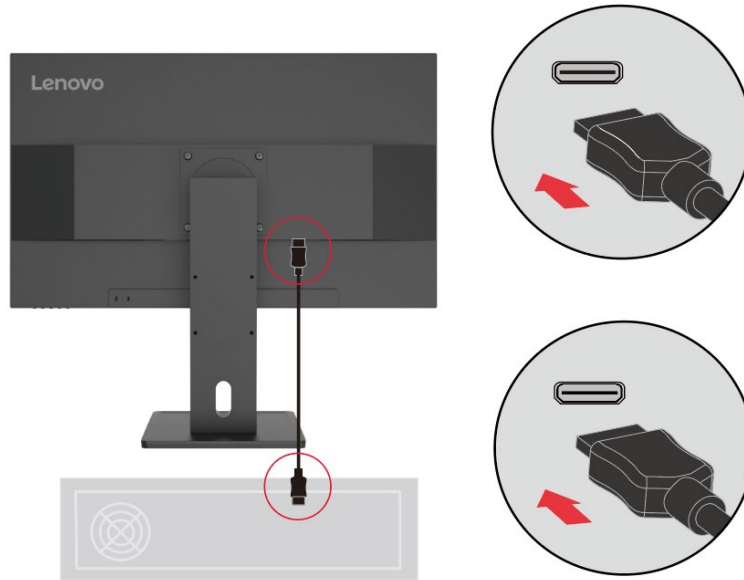

5. For computers with DP connections.

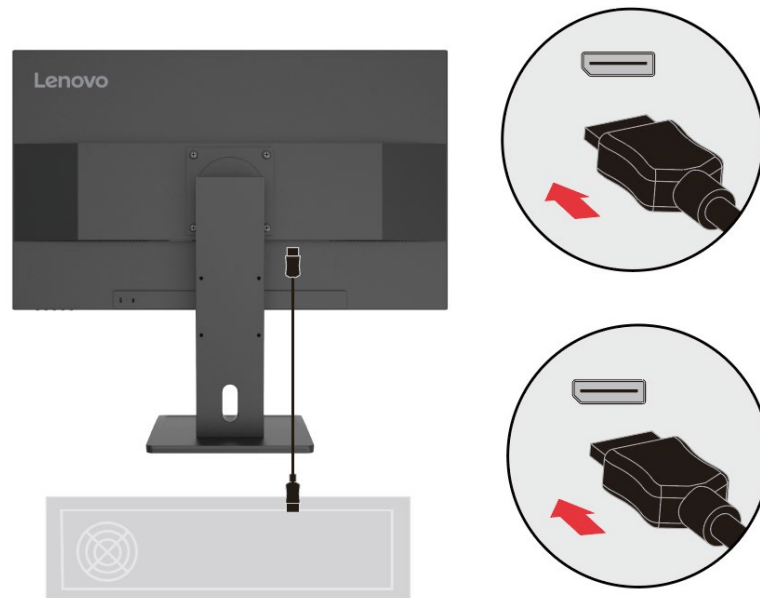

6. Plug the power cord into the display, and then plug the display power cord and computer cord into a grounded power outlet.

Note: A certified power cord must be used for this equipment. The installation and/or equipment regulations of the country concerned should be taken into account. The certified power cable used should not be lighter than the normal PVC cable (marked H05VV-F 3G 0.75mm² or H05VVH2-F2 3G 0.75mm²) as specified in IEC 60227. In addition, synthetic rubber cords as specified in IEC 60245 (marked H05RR-F 3G 0.75mm²) should be used.

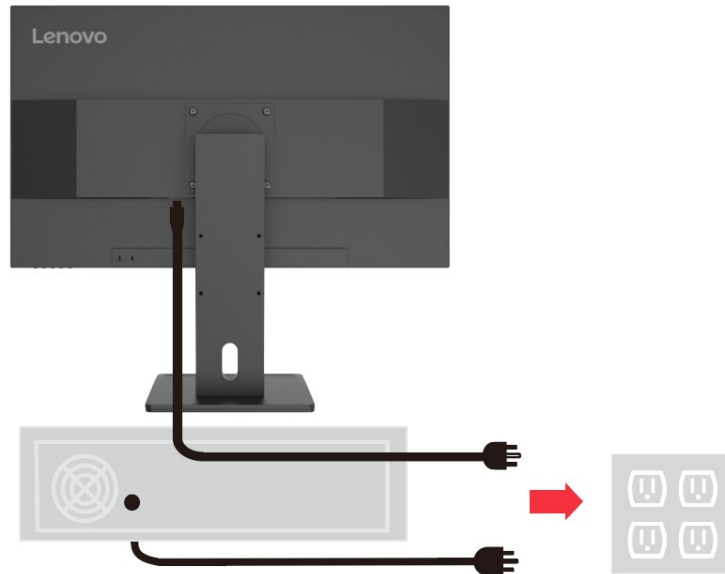

7. Use cable clamps when connecting cables

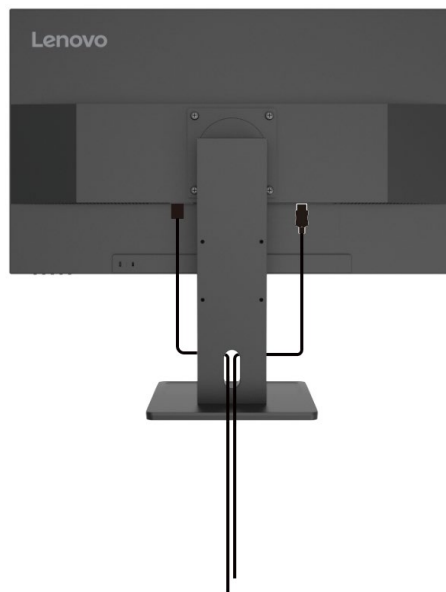

8. Turn on the power to the display and computer.

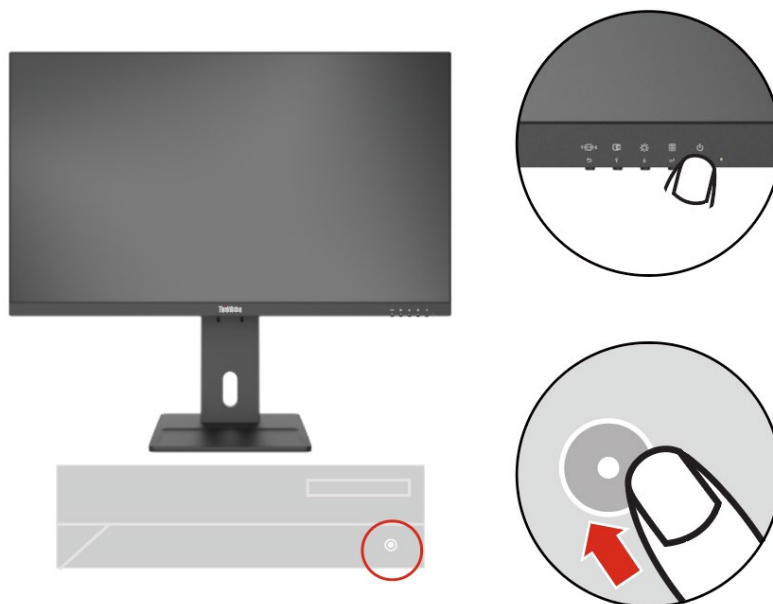

9. When you install the display driver, download the driver that corresponds to your display model from the Lenovo website at <http://support.lenovo.com.cn>. To install the driver, see the "Manually Install the Driver for the Display" section on pages 3-5.



Chapter 2. Adjusting and Using the Display

This section describes how to adjust and use this display.

Comfort and Assistance Functions

Good ergonomic designs are important for the comfortable use of your personal computer. Your workplace and the equipment you use should be arranged appropriately for your personal needs and the type of work you do. In addition, healthy work habits can help you achieve optimal efficiency and comfort when using a computer.

Arrange Your Working Area

Use a work surface of the right height and enough work area so that you can work comfortably. Arrange your work area according to the way you use materials and equipment. Keep frequently used materials neatly organized in your work area, and place frequently used items (such as a computer mouse or telephone) in an easily accessible location. The placement and setup of equipment are very important to your work posture. The following topics describe how to optimize equipment settings to achieve and maintain a good working posture.

Placing and Viewing the Display

For comfortable viewing of the display, the following factors should be considered when placing and adjusting computer displays:

- **Viewing Distance:** The recommended viewing distance between your eyes and the display screen is 1.5X the screen diagonal. Solutions to meet this required distance in a small office include: keeping the desk a certain distance from the wall or partition to allow space for the display, using a flat panel or smaller display and keeping the display in the corner of the desk, or placing the keyboard in an adjustable drawer board to create a deeper work surface.
- **Display Height:** If your display is not height-adjustable, place your head and neck in a natural, comfortable (vertical or upright) position. If your display is not height-adjustable, you can place a book or other sturdy object under the base of the display to achieve the desired height. The general rule is to sit comfortably with the top of the display screen at eye level or slightly lower. However, it is important to optimize the height of the display so that the relative position between the eyes and the center of the display provides the right visual distance and a comfortable viewing experience when the eye muscles are relaxed.
- **Tilt:** Adjusting the tilt of your display optimizes the appearance of your screen content and keeps your head and neck in the best possible position.
- **Regular Location:** Place the display in such a way that overhead lighting or nearby windows do not cause glare or reflection on the screen.

Here are some additional tips for comfortable viewing of your display:

- Use adequate lighting for the type of work you do.
- Use display brightness, contrast, and image controls (if available) to optimize the image on the screen for your visual needs.
- Keep the display screen clean so that you can see the content clearly.

Long periods of focused visual activity tend to strain the eyes. Be sure to periodically move away from the display screen and gaze at a distant object to relax your eye muscles. If you have any questions about eye strain or visual discomfort, consult vision care professional for advice.

Tips on Healthy Work Habits

The following is a summary of some important factors that are useful to keep you comfortable and productive while using your computer.

- **Good posture comes from equipment placement:** The layout of your work area and the placement of your computer equipment can have a significant impact on your posture while using the computer. Be sure to follow the tips listed in "Arrange Your Working Area" on pages 2-1 to optimize the placement and orientation of your equipment so you can maintain comfortable posture and efficiency. In addition, be sure to use the adjustment features of your computer components and office furniture to meet your needs, and adjust them over time as your needs change.
- **Slight changes in posture help keep you comfortable:** the longer you sit in front of a computer, the more important it becomes to pay attention to your work posture. Avoid maintaining one posture for long periods. Regular slight changes in posture can help prevent possible discomfort. Use the adjustment function provided by office furniture or equipment to adapt to changes in posture.
- **Regular short breaks help ensure healthy computing:** Because computing is primarily a static activity, it is especially important to take short breaks during the workday. Take regular breaks to stand in front of your work area, stretch your limbs, walk around or have a drink, or otherwise take a short break from using the computer. Taking short breaks during work allows for changes in body posture that can help you stay comfortable and productive while working.

Auxiliary function Information

Lenovo is committed to providing greater access to information and technology for people with disabilities. With assistive technologies, users with disabilities can access information most appropriate for their specific situation. Some of these technologies are already available in the operating system; others can be purchased through resellers or by visiting the following website: <https://lenovo.ssbartgroup.com>





Low Blue Light: This monitor features a low blue light panel. Under factory reset/default settings, it complies with TÜV Rheinland's Low Blue Light hardware solution certification.

Adjusting the Display Image

This section describes the functions of the user controls used to adjust the display image.

Using Direct Access Controls

When On Screen Display (OSD) is not displayed, you can use direct access controls.







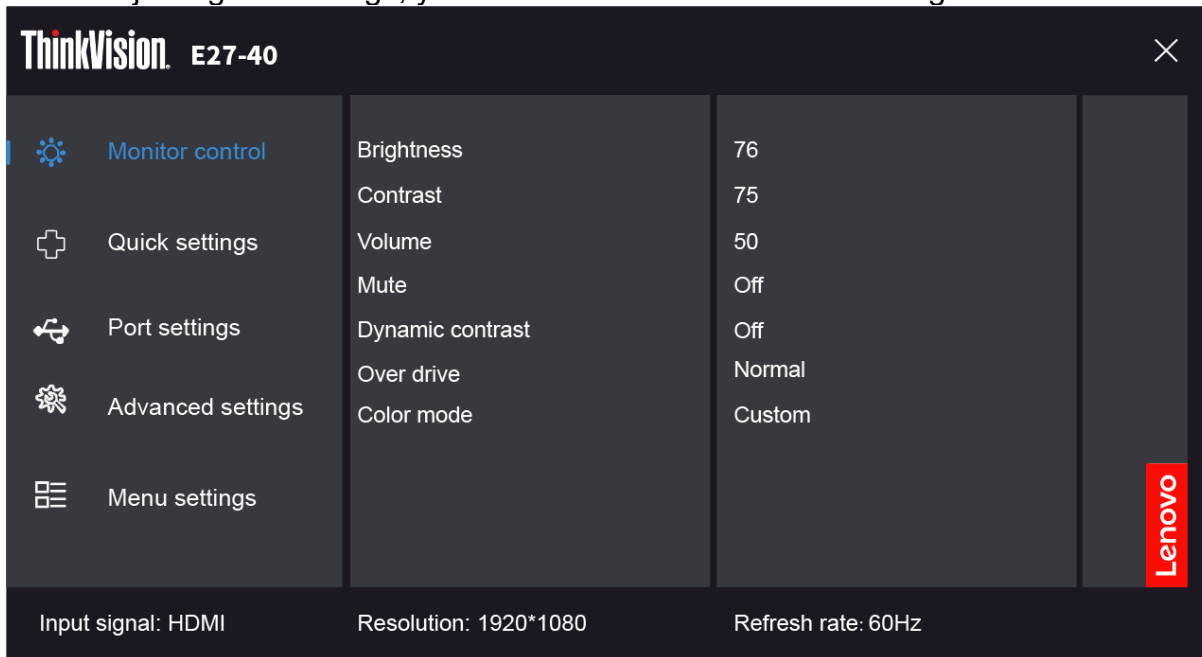







Icon	Control	Description
	Power	Power on/off.
	Menu/Confirm	Open the OSD Menu; Enter the next level menu; Press and hold for 10s to lock/unlock the menu.
	Down	Performs the OSD menu brightness shortcut function; When the OSD menu is opened, it serves to move the cursor downwards; In the adjustment bar, it acts as a value reduction.
	Up	It is a shortcut for Automatic while there is no OSD on the screen; When the OSD menu is opened, it serves to move the cursor upwards; In the adjustment bar, it acts as a value increase.
	Exit	It is a shortcut for changing input signal while there is no OSD on the screen or on power-saving mode; Returns to the OSD upper level menu; When a signal is present, press and hold for 10 seconds to enable or disable the DDC-CI function.

Use the On-Screen Display (OSD) Control

When adjusting the settings, you can view the user controls through the OSD.



Use controls:





1. Press  to open the OSD Main Menu.
2. Use  or  to move between icons. Select an icon and press  to access the feature. If there is a submenu, use  or  to move between options, and then press  to select the feature. Use  or  to make adjustments, and then press  to save.
3. Press  to exit the submenu in sequence, and then exit the OSD.
4. When OSD is not displayed, press  and hold for 10 seconds to lock the OSD. In this way, you can prevent accidental adjustment of the OSD. Press  and hold for 10 seconds to unlock the OSD for OSD adjustment.
5. DDC/CI is enabled by default. Press  and hold for 10 seconds to disable/enable the DDC/CI function. The message "DDC/CI disable (DDC/CI enable)" is displayed on the screen.
6. The "Energy Star" option can be used to reset all user Settings to their default values, enabling the display to meet the requirements of Energy Star.



ENERGY STAR is a consumer electronics energy efficiency program led by the U.S. government. It was launched at the Department of Energy to reduce energy consumption and greenhouse gas emissions. The ENERGY STAR logo is a symbol of energy efficiency and environmental protection. It has improved the concept of energy efficiency among consumers and manufacturers, and effectively guided the market. The "ENERGY STAR Regulations" improve energy efficiency and reduce air pollution through the use of more energy-efficient equipment in homes, offices, and factories. One way to achieve this goal is to use management to reduce energy consumption when products are not in use. The default settings of the monitor are ENERGY STAR qualified. Any changes made by the user to more features and functions can increase power consumption, which would exceed the limits of the ENERGY STAR standard. If the user changes options related to energy efficiency while in use, such as brightness, color mode, etc., selecting Reset Factory All or selecting the ENERGY STAR option will restore energy consumption to ENERGY STAR-compliant energy efficiency.

For more information, see (www.energystar.gov/products). All ENERGY STAR products will be posted online and directly accessible to governments, public agencies, and consumers.

Table 2-1. OSD Functions

Main Menu	Submenu	Description	Controls and Adjustment	
 Monitor control	Brightness	Adjust the overall brightness of the screen		
	Contrast	Adjusts the degree of difference between bright and dark areas		
	Volume	Volume adjustment		
	Mute	On		
		Off		
	Dynamic contrast	On		
		Off		
	Over drive	Off		
		Normal		
		Extreme		
Color mode	sRGB			
	Neutral			
	Warm			
	Cool			
	Custom	Red 0-100		
		Green 0-100		
Blue 0-100				
 Quick settings	Up Key	Brightness	Users can choose the quick functions by themselves from it.	
		Contrast		
		Color Mode		
		Language		
		Automatic		
	Down Key	Brightness		
		Contrast		
		Color Mode		
		Language		
		Automatic		
 Port settings	Input signal	Auto	Signal source switch	
		DisplayPort		
		HDMI		
		VGA		
	Video range	Auto	Note: Refers to RGB range of HDMI input.	
		Full range 0-255		
		Limited range 16-235		
	 Advanced Settings	Image Position	H.Position	Under VGA signal
V.Position				
Image setup		Automatic		
		Manual		

	Button repeat rate	Default	
		Slow	
		Off	
	Aspect ratio	Full screen	Non-16:9 signal adjustable
		Original AR	
	LED indicator	On	
		Off	
	Power button lock	On	
Off			
 Menu settings	Information	Model name	
		E27-40	
		Refresh rate	
		60Hz	
		Firmware	
	L01		
	Serial number		
	Language	English	Default English
		Français	
		Italiano	
		简体中文	
		Español	
		日本語	
		Deutsch	
		Русский	
ไทย			
Українська			
繁體中文			
OSD time out	5-60	Set the OSD display time	
OSD position	(0-100, 0-100)	Setting the OSD Location	
OSD rotation	Normal		
	90		
	270		
Transparency	0-100	Setting OSD Transparency	
Factory reset	Reset	Restore factory settings	
	No	except for language	

Select Supported Display Modes

The display mode used by the display is controlled by the computer. Therefore, you should refer to the computer's documentation for detailed information on how to change the display mode.

When the display mode is changed, the image size, position, and shape may change. This is normal and the image can be readjusted using the automatic image settings and image controls.

Unlike CRT displays, which require high refresh rates to minimize flicker, LCD or flat panel technology is inherently flicker-free.

Note: If the system has previously been used in conjunction with a CRT display and is currently configured for a display mode outside the range of that display, you may need to temporarily reconnect the CRT display until the system has been reconfigured; it is best to set it to 1920 x 1080 (60 Hz), the normal display mode.

The display modes shown below are factory optimized.

Table 2-2. Display modes set by the manufacturer

Timing sequence	Refresh rate	Signal Channel
640 x 480	60 Hz	VGA/HDMI/DP
640 x 480	67 Hz	
640 x 480	72 Hz	
640 x 480	75 Hz	
720 x 400	70 Hz	
800 x 600	60 Hz	
800 x 600	72 Hz	
800 x 600	75 Hz	
832 x 624	75 Hz	
1024 x 768	60 Hz	
1024 x 768	70 Hz	
1024 x 768	75 Hz	
1280 x 1024	60 Hz	
1280 x 1024	75 Hz	
1280 x 800	60 Hz	
1440 x 900	60 Hz	
1600 x 900	60 Hz	
1680 x 1050	60 Hz	
1920 x 1080	60 Hz	
1920 x 1080	75 Hz	
1920 x 1080	100 Hz	

Understanding Power Management

The power management function is activated when the computer detects that the mouse or keyboard has not been used for a user-defined time interval. There are several states as described in the table below.

For best performance, it is best to turn off the display at the end of the day, or when it is not in use for a longer period during the day.

Table 2-3. Power Indicators

Status	Power indicator	Screen	Recovery Operation
On	White	Normal	
Standby/Hang up	Amber	Blank	Press any key or move the mouse. The response time may be slightly delayed. Note: When there is no image output to the display, it will also enter standby mode.
Off	Off	Blank	Press the power button to power on. There may be a slight delay before the image is redisplayed.

Power Management Mode

VESA Mode	Horizontal Synchronization	Vertical Synchronization	Video	Power indicator	Power consumption
Normal Operation	Active	Active	Events	White	34 W (max)* 16.25 W (typical)
Active-Off Mode	Inactive	Inactive	Close	Amber	Less than 0.5 W
Off	-	-	-	Off	Less than 0.3 W

ENERGY STAR	Power consumption
P _开	12.61 W
ETEC	39.23 kWh

* Maximum power consumption for maximum brightness.

This document is for reference only and reflects laboratory performance. Your product performance will vary depending on the software, components, and peripherals you order, and it should not be your responsibility to update this information. Accordingly, customers should not rely on this information to make decisions regarding electronic fault tolerance or similar items. We make no express or implied warranties as to accuracy or completeness.

Maintaining the Display

Always turn off the power to the display before performing any maintenance work on the display.

Do not:

- Let water or liquids spill onto the display.
- Use solvents or abrasive substances.
- Use flammable cleaning materials to clean the display or any other electronic device.
- Touch the screen area of the display with sharp or abrasive objects. Such contact may cause permanent damage to the screen.
- Use any cleaner that contains an anti-static solution or similar additive. Otherwise, the coating of the screen area may be damaged.

Be sure to:

- Wipe the case and screen gently with a soft cloth lightly dampened in water.
 - Use a damp cloth and a little flexible cleaner to remove fingerprints and grease.
-

Remove the display base and bracket

Step 1: Place the monitor on a flat surface.

Step 2: Turn the screws on the back of the bracket and the monitor counterclockwise to separate the bracket from the monitor.

Step 3: Turn the screws at the connection point of the base and support counterclockwise to separate the base from the support.

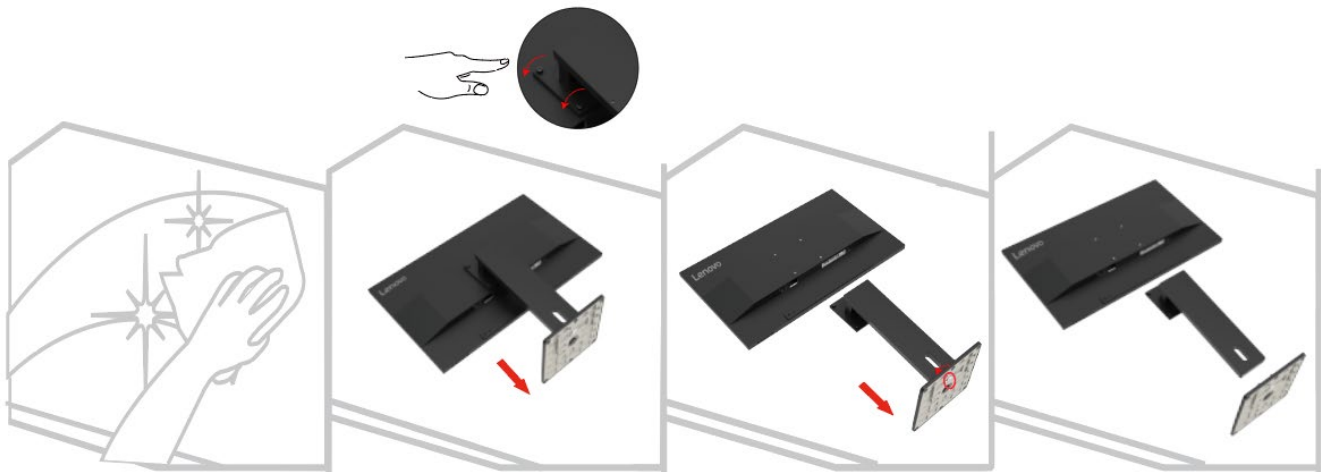

Wall-mounted (optional)

Refer to the instructions attached with the base assembly. To convert the LCD from a desktop to a wall mount, perform the following steps:

Step 1: Make sure the power button is off and unplug the power cord.

Step 2: Place the LCD face down on a towel or blanket.



Step 3: Remove the base and stand from the display, see "Remove the display base and bracket" on pages 2-9.



Step 4: Install the assembly bracket for the VESA compatible wall mount. (100 mm x 100 mm distance), VESA assembly screws M4 x 10 mm.

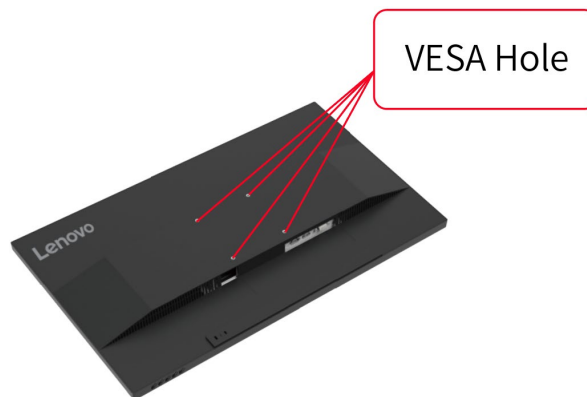

Step 5: Mount the LCD to the wall following the instructions for the wall mount. Only the lightest weight/weight-bearing wall mount from the UL list should be used: 8 kg.

Note: When using the flexible arm, the display should not be tilted downward by more than 5 degrees.

Chapter 3. Reference Information

This section provides display specifications, instructions for manual installation of the display driver, and troubleshooting information.

Display Specifications

Table 3-1. Display Specifications - Model H25270FE0

Size	Thickness	220.0 mm (8.66 in.)
	Height	538.5 mm (21.20 in.)
	Width	613.1 mm (24.14 in.)
Support Arm	Tilt	Range: -5°~22°
	Swivel	Range: 360°
	Pivot	Range: -90°~90°
	Lift	Range: 155 mm
VESA mount	Support	100 mm x 100 mm (3.94 in. x 3.94 in.)
Image	Viewable image size	685.8 mm (27 in.)
	Maximum height	336.3 mm (13.24 in.)
	Maximum width	597.9 mm (23.53 in.)
	Pixel pitch	0.3114(H) x 0.3114(V) mm
Power input	Supply voltage	100-240V AC
	Max. power supply current	0.8 A
Power Consumption Note: The power consumption value is the power consumption of both the display and the power supply.	Normal operation	<34 W (max) <16.25 W (standard)
	Standby/Hang Up	<0.5 W
	Off Note: No USB/camera/external speakers	<0.3 W
Video input (analog)	Input Signal	VGA
	Horizontal Addressing Capability	1920 pixels (max)
	Vertical Addressing Capability	1080 pixels (max)
	Clock frequency	170 MHz (max)
HDMI/DP	Input Signal	HDMI/DP
	Horizontal Addressing Capability	1920 pixels (max)
	Vertical Addressing Capability	1080 pixels (max)
	Clock frequency	240 MHz (max)
Communication	VESA DDC/CI	

Supported display modes	Horizontal frequency	30 kHz - 81 kHz (VGA)
		30 kHz - 120 kHz (HDMI/DP)
	Vertical frequency	50 Hz - 75 Hz (VGA)
		48 Hz - 100 Hz (HDMI/DP)
Self-resolution	1920 x 1080 @ 60 Hz	
Temperature	At working time	0° to 40°C (32°F to 104°F)
	During storage	-20° to 60°C (-4°F to 140°F)
	During transport	-20° to 60°C (-4°F to 140°F)
Humidity	At working time	10% to 80% (non-condensing)
	During storage	5% to 95% (non-condensing)
	During transport	5% to 95% (non-condensing)

Troubleshooting

If you encounter problems setting up or using your display, you may be able to solve the problem. Before contacting your dealer or Lenovo, please try the following suggested actions depending on the problem you are experiencing.

Table 3-2. Troubleshooting

Problem	Possible Causes	Recommended Operations	Refer to
"Out of Range" is displayed on the screen and the power indicator flashes amber.	This display does not support the display mode set by the system	<ul style="list-style-type: none"> •If you are replacing an old display, reconnect it and adjust the display mode to the range supported by the new display. •If you are using a Windows system, restart the system in safe mode and select a supported display mode for your computer. •If these options do not work, please contact Customer Support. 	"Select Support Display Modes" on pages 2-7
Poor image quality	The video signal cable is not well connected to the display or the system.	Make sure the signal cable is securely plugged into the system and display.	"Connecting and Powering on the Display" on pages 1-5
	The color setting may be incorrect.	Select another color setting in the OSD menu.	"Adjusting the Display Image" on pages 2-3
	The automatic image setting function is not performed.	Perform automatic image setup.	"Adjusting the Display Image" on pages 2-3
The power indicator does not light up and no images are displayed.	<ul style="list-style-type: none"> •The display's power switch is not turned on. •The power cord is loose or not connected. •The outlet has no electricity. 	<ul style="list-style-type: none"> •Make sure the power cord is well connected. •Make sure the outlet has power. •Power on the display. •Change the power cord. •Change the power outlet. 	"Connecting and Powering on the Display" on pages 1-5
The screen is blank and the power indicator shows amber.	The display is in standby/hang-up mode	<ul style="list-style-type: none"> •Press any key on the keyboard or move the mouse to resume operation. •Check the power options settings on the computer. 	"Understanding Power Management" on pages 2-8
The power indicator shows amber and no images are displayed	Video signal cable is loose or disconnected from the system or display.	Make sure the video cable is well connected to the system.	"Connecting and Powering on the Display" on pages 1-5
	The display brightness and contrast are at their lowest settings.	Adjust the Brightness and Contrast settings in the OSD menu.	"Adjusting the Display Image" on pages 2-3
One or more pixels change color	This is an inherent characteristic of LCD technology and is not an LCD defect.	If more than five pixels are missing, please contact Support Center	"Appendix A. Service and Support" on pages A-1

Problem	Possible Causes	Recommended Operations	Refer to
<ul style="list-style-type: none"> •Blurred lines or images in text •Horizontal or vertical lines are present in the image. 	<ul style="list-style-type: none"> •Image settings are not optimized •The system's display property settings are not optimized. 	Adjust the system's resolution setting to the resolution of this display: 1920 x 1080 @ 60 Hz.	"Adjusting the Display Image" on pages 2-3
		Perform the automatic image setting. If the automatic image setting does not work, perform the manual image setting.	"Select Support Display Modes" on pages 2-7
		When using its resolution, adjusting the Dots Per Inch (DPI, dots per inch) setting on the system can further improve it.	See the Advanced section of System Display Properties.





Manual Image Settings





If the automatic picture setting does not provide a picture you are satisfied with, you can perform a manual picture setting. (VGA [Analog] only)

Note: Turn on the power to the display and wait for about 15 minutes to allow the display to warm up.

1. Press  to open the OSD menu.

2. Use  or  to select "Advanced Settings", and press .

3. Use  or  to select "Image Settings" and press  to confirm, then press "Auto Settings" and then press  to access.

4. Press  or  to select "Manual setting", then press  to select Clock or Phase, and then use  or  to adjust the value.

- Clock: (pixel frequency) adjusts the number of pixels that can be scanned in one horizontal scan. If the frequency is incorrect, vertical bars may appear on the screen and the picture width may be incorrect.
- Phase: adjusts the phase of the pixel clock signal. When the phase is not adjusted correctly, horizontal disturbances may appear in the bright picture.

5. When the image no longer looks distorted, press Enter to save the Clock and Phase adjustments.

6. Press  to exit the OSD menu.

Manually Install the Driver for the Display

Below are steps for manually installing the monitor driver in Microsoft Windows 10, Microsoft Windows 11.

1. Turn off the computer, all attached devices.
2. Ensure that the monitor is connected correctly.
3. Turn on the monitor and then the system unit. Allow your computer to start the Windows operating system.
4. From the Lenovo website https://pcsupport.lenovo.com/solutions/E27_40, find the corresponding monitor driver and download it to a PC to which this monitor is connected (such as a desktop).
5. Right-click the Windows Start button on the desktop, then click Device Manager, and double click Monitor.
6. Double-click Generic Monitor.
7. Click the Driver tab.
8. Click Update Driver, and then click Browse Computer to find the driver.
9. Click Let me pick from a list of available drivers on my computer.
10. Click the Have Disk... button. By clicking the Browse button, browse and point to the following path: X:\Monitor Drivers\Windows (where X indicates "the folder in which the downloaded driver is located" (such as a desktop)).
11. Select E27-40 inf. file, Click Open button. Click OK button.
12. In the new window, select E27-40 and click Next.
13. After the installation is complete, delete all downloaded files and close all Windows.
14. Restart the system. The system will automatically select the refresh rate and the corresponding color matching profile.

Note: Unlike CRTs, LCD displays do not improve display quality by increasing the refresh rate. Lenovo recommends using a 1920 x 1080 @ 60 Hz refresh rate.

Get further help

If you are still unable to resolve the issue, please contact Lenovo Support. For more information on contacting the Support Center, see "Appendix A. Service and Support" on page A-1.

Appendix A. Services and Support

Quebec Disclaimer

Quebec Disclaimer: English

IMPORTANT NOTICE FOR QUEBEC CONSUMERS:

In regard to section 79.18 of Quebec's Regulation respecting the application of the Consumer Protection Act, Lenovo in no way guarantees the availability of (a) replacement parts; (b) repair services; and (c) information necessary to maintain or repair the goods. For up-to-date information on the technical support and parts available for your purchase, please consult <https://support.lenovo.com/ca/en>

Quebec Disclaimer: Canadian French

AVIS IMPORTANT POUR LES CONSOMMATEURS DU QUÉBEC:

En ce qui concerne l'article 79.18 du Règlement d'application de la Loi sur la protection du consommateur du Québec, Lenovo ne garantit en aucune façon la disponibilité des éléments suivants : (a) les pièces de rechange; (b) les services de réparation; et (c) les renseignements nécessaires à l'entretien à la réparation du bien. Pour obtenir des renseignements à jour sur le soutien technique et les pièces disponibles pour votre achat, veuillez consulter <https://support.lenovo.com/ca/fr>.

Telephone Technical Support

Country or Region	Telephone Number
Argentina	0800-666-0011 (Spanish, English)
Australia	1-800-041-267 (English)
Austria	0810-100-65 (For local rate) (German)
Belgium	Warranty service and support: 02-339-36-11 (Dutch, French)
Bolivia	0800-10-0189 (Spanish)
Brazil	Calls made from within the Sao Paulo region: 11-3889-8986 Calls made from outside the Sao Paulo region: 0800-701-4815 (Portuguese)
Brunei Darussalam	Dial 800-1111 (English)
Canada	1-800-565-3344 (English, French)
Chile	800-361-213 (Spanish)
China	400-990-8888
China (Hong Kong S.A.R.)	(852) 3516-8977 (Cantonese, English, Mandarin)
China (Macau S.A.R.)	0800-807 / (852) 3071-3559 (Cantonese, English, Mandarin)
Colombia	1-800-912-3021 (Spanish)
Costa Rica	0-800-011-1029 (Spanish)
Croatia	385-1-3033-120 (Croatian)
Cyprus	800-92537 (Greek)

Czech Republic	800-353-637 (Czech)
Denmark	Warranty service and support: 7010-5150 (Danish)
Dominican Republic	1-866-434-2080 (Spanish)
Ecuador	1-800-426911-OPCION 4 (Spanish)
Egypt	Primary: 0800-0000-850 Secondary: 0800-0000-744 (Arabic,English)
El Salvador	800-6264 (Spanish)
Estonia	372-66-0-800 (Estonian, Russian, English)
Finland	Warranty service and support: +358-800-1-4260 (Finnish)
France	Warranty service and support: 0810-631-213 (hardware) (French)
Germany	Warranty service and support: 0800-500-4618 (toll-free) (German)
Greece	Lenovo Business Partner (Greek)
Guatemala	Dial 999-9190, wait for operator, and request to reach 877-404-9661 (Spanish)
Honduras	Dial 800-0123 (Spanish)
Hungary	+36-13-825-716 (English, Hungarian)
India	Primary: 1800-419-4666 (Tata) Secondary: 1800-3000-8465 (Reliance) Email: commercialts@lenovo.com (English and Hindi)
Indonesia	1-803-442-425 62 213-002-1090 (Standard Charges Apply) (English, Bahasa Indonesia)
Ireland	Warranty service and support: 01-881-1444 (English)
Israel	Givat Shmuel Service Center: +972-3-531-3900 (Hebrew, English)
Italy	Warranty service and support: +39-800-820094 (Italian)
Japan	0120-000-817 (Japanese, English)
Kazakhstan	77-273-231-427 (Standard Charges Apply) (Russian, English)
Korea	080-513-0880 (Collect call) 02-3483-2829 (Toll Call) (Korean)
Latvia	371-6707-360 (Latvian, Russian, English)
Lithuania	370 5278 6602 (Italian, Russian, English)
Luxembourg	ThinkServer and ThinkStation: 352-360-385-343 ThinkCentre and ThinkPad: 352-360-385-222 (French)
Malaysia	1-800-88-0013 03-7724-8023 (Standard Charges Apply) (English)
Malta	356-21-445-566 (English, Italian, Maltese Arabic)
Mexico	001-866-434-2080 (Spanish)
Netherlands	020-513-3939 (Dutch)

New Zealand	0508-770-506 (English)
Nicaragua	001-800-220-2282 (Spanish)
Norway	8152-1550 (Norwegian)
Panama	Lenovo Customer Support Center: 001-866-434 (toll-free) (Spanish)
Peru	0-800-50-866 OPCION 2 (Spanish)
Philippines	1-800-8908-6454 (GLOBE subscribers) 1-800-1441-0719 (PLDT subscribers) (Tagalog, English)
Poland	Laptops and tablets branded with logo Think: 48-22-273-9777 ThinkStation and ThinkServer: 48-22-878-6999 (Polish, English)
Portugal	808-225-115 (Standard Charges Apply) (Portuguese)
Romania	4-021-224-4015 (Romanian)
Russia	+7-499-705-6204 +7-495-240-8558 (Standard Charges Apply) (Russian)
Singapore	1-800-415-5529 6818-5315 (Standard Charges Apply)
Slovakia	ThinkStation and ThinkServer: 421-2-4954-5555
Slovenia	386-1-2005-60 (Slovenian)
Spain	34-917-147-833 (Spanish)
Sri Lanka	9477-7357-123 (Sumathi Information systems) (English)
Sweden	Warranty service and support: 077-117-1040 (Swedish)
Switzerland	Warranty service and support: 0800-55-54-54 (German, French, Italian)
Taiwan	0800-000-702 (Mandarin)
Thailand	001-800-4415-734 (+662) 787-3067 (Standard Charges Apply) (Thai, English)
Turkiye	444-04-26 (Turkish)
United Kingdom	Standard warranty support: 03705-500-900 (local rate) Standard warranty support: 08705-500-900 (English)
United States	1-800-426-7378 (English)
Uruguay	000-411-005-6649 (Spanish)
Venezuela	0-800-100-2011 (Spanish)
Vietnam	120-11072 (Toll Free) 84-8-4458-1042 (Standard Charges Apply) (Vietnamese, English)

Appendix B. Declaration

Lenovo may not offer the products, services, or features discussed in this document in all countries (regions). For information about products and services that may be available in your region, please consult your local Lenovo representative. Any reference to Lenovo products, programs, or services does not express or imply that only Lenovo's products, programs, or services may be used. Any product, program, or service with equivalent functionality may be used as long as it does not infringe any of Lenovo's intellectual property rights. However, it is the responsibility of the user to evaluate and verify the operation of any other product, program, or service.

Lenovo may own or be applying for patents on the items mentioned in this document. The distribution of this document does not give you a license to use these patents. You may make inquiries in writing by sending a license to the following address:

Lenovo (United States), Inc.

1009 Think Place - Building One

Morrisville, NC 27560

U.S.A

Attention: Lenovo Director of Licensing

Lenovo provides this publication "as is" without warranty of any kind, either express or implied, including, but not limited to, any implied warranties of non-infringement, merchantability, or fitness for a particular purpose.

Some jurisdictions do not allow the exclusion of express or implied warranties in certain transactions, so this disclaimer may not apply to you.

The information in this publication may contain technical inaccuracies or typographical errors. The information in this manual is subject to periodic change; such changes will be included in subsequent editions of this publication. Lenovo may make improvements and/or changes to the products and/or procedures described in this publication at any time without notice.

The products described in this document are not suitable for use in applications such as porting or other life support. In these applications, personal injury or even death may result if they do not work properly. The information contained in this document does not affect or change Lenovo product specifications or warranties. No information in this document is intended as an express or implied license or disclaimer of Lenovo or third-party intellectual property rights. All information in this document has been obtained in a specific environment and is provided as an explanatory note only. Results obtained in other operating environments may differ.

Lenovo may use or publish any information you provide in any manner it deems appropriate that does not infringe your rights.

Any references to non-Lenovo websites in this publication are for convenience purposes only and do not in any way constitute an endorsement of those websites. The information on these sites is not part of this Lenovo product literature and the use of these sites is at your own risk.

The performance data provided herein was obtained in a controlled environment. Therefore, results obtained in other operating environments may vary significantly. Some measurements may have been obtained on development-level systems and therefore cannot be guaranteed to be identical on conventional systems. In addition, some measurements may have been obtained by inferential evaluation. Actual results may vary. Users of this document should verify the appropriate data for their particular environment.

Trademark

The following terms are trademarks of Lenovo in the United States and/or other countries (regions):

Lenovo

Lenovo Logo

ThinkCentre

ThinkPad

ThinkVision

Microsoft, Windows, and Windows NT are trademarks of Microsoft Group, Inc.

Other company, product, or service names may be trademarks or service marks of other owners.

Power Cord

Only the power cord provided by the product manufacturer should be used. Do not use AC power cords from other devices.