

GS700TR Series Hardware Installation Guide

NETGEAR®

NETGEAR, Inc.
4500 Great America Parkway
Santa Clara, CA 95054 USA

202-10304-01
December 2007
v1.0

Trademarks

NETGEAR, the NETGEAR logo, and Auto Uplink are trademarks or registered trademarks of NETGEAR, Inc. Microsoft, Windows, and Windows NT are registered trademarks of Microsoft Corporation. Other brand and product names are registered trademarks or trademarks of their respective holders. Portions of this document are copyright Intoto, Inc.

Statement of Conditions

In the interest of improving internal design, operational function, and/or reliability, NETGEAR reserves the right to make changes to the products described in this document without notice.

NETGEAR does not assume any liability that may occur due to the use or application of the product(s) or circuit layout(s) described herein.

Certificate of the Manufacturer/Importer

It is hereby certified that the GS700TR Series Smart Switch has been suppressed in accordance with the conditions set out in the BMPT-AmtsblVfg 243/1991 and Vfg 46/1992. The operation of some equipment (for example, test transmitters) in accordance with the regulations may, however, be subject to certain restrictions. Please refer to the notes in the operating instructions.

The Federal Office for Telecommunications Approvals has been notified of the placing of this equipment on the market and has been granted the right to test the series for compliance with the regulations.

Product and Publication Details

Model Number:	GS700TR
Publication Date:	December 2007
Product Family:	Smart Switch
Product Name:	GS700TR Series Smart Switch
Home or Business Product:	Business
Language:	English
Publication Part Number:	202-10304-01
Publication Version Number:	1.0

Contents

GS700TR Series Hardware Installation Guide

About This Manual

Conventions, Formats and Scope	v
How to Use This Manual	vi
How to Print this Manual	vi
Revision History	vii

Chapter 1

Introduction

Overview	1-1
Features	1-2
Package Contents	1-3

Chapter 2

Physical Description

GS724TR Front and Back Panel Configuration	2-5
GS748TR Front and Back Panel Configuration	2-6
LED Designations	2-7
Port LEDs	2-7
System LEDs	2-8
Device Hardware Interfaces	2-8
RJ-45 Ports	2-8
SFP GBIC Module	2-9
Factory Defaults Button	2-9

Chapter 3

Applications

Desktop Switching	3-11
-------------------------	------

Chapter 4

Installation

Step 1: Preparing the Site	4-13
----------------------------------	------

Step 2: Installing the Switch	4-14
Installing the Switch on a Flat Surface	4-14
Installing the Switch in a Rack	4-14
Step 3: Checking the Installation	4-15
Step 4: Connecting Devices to the Switch	4-16
Step 5: Installing an SFP GBIC Module	4-16
Step 6: Applying AC Power	4-17
Step 7: Managing the Switch using a Web Browser or the PC Utility	4-18

Appendix A

Troubleshooting

Troubleshooting Chart	A-19
Additional Troubleshooting Suggestions	A-20
Network Adapter Cards	A-20
Configuration	A-20
Switch Integrity	A-20
Auto-Negotiation	A-21

Appendix B

Technical Specifications

Index

About This Manual

The *NETGEAR® GS700TR Series Hardware Installation Guide* describes how to install, configure and troubleshoot the GS700TR Series Smart Switch. The information in this manual is intended for readers with intermediate computer and Internet skills.

Conventions, Formats and Scope

The conventions, formats, and scope of this manual are described in the following paragraphs:

- **Typographical Conventions.** This manual uses the following typographical conventions:

<i>Italic</i>	Emphasis, books, CDs, file and server names, extensions
Bold	User input, IP addresses, GUI screen text
Fixed	Command prompt, CLI text, code
<i>italic</i>	URL links

- **Formats.** This manual uses the following formats to highlight special messages:

	Note: This format is used to highlight information of importance or special interest.
---	--

	Tip: This format is used to highlight a procedure that will save time or resources.
---	--

	Warning: Ignoring this type of note may result in a malfunction or damage to the equipment.
---	--



Danger: This is a safety warning. Failure to take heed of this notice may result in personal injury or death.

- **Scope.** This manual is written for the GS700TR Series Smart Switch according to these specifications:





Product Version	GS700TR Series Smart Switch
Manual Publication Date	December 2007



Note: Product updates are available on the NETGEAR, Inc. website at <http://kbserver.netgear.com/main.asp>.

How to Use This Manual

The HTML version of this manual includes the following:

- Buttons,  and , for browsing forwards or backwards through the manual one page at a time
- A  button that displays the table of contents and an  button. Double-click on a link in the table of contents or index to navigate directly to where the topic is described in the manual.
- A  button to access the full NETGEAR, Inc. online knowledge base for the product model.
- Links to PDF versions of the full manual and individual chapters.

How to Print this Manual

To print this manual you can choose one of the following several options, according to your needs.

- **Printing a Page in the HTML View.** Each page in the HTML version of the manual is dedicated to a major topic. Use the *Print* button on the browser toolbar to print the page contents.
- **Printing a Chapter.** Use the *PDF of This Chapter* link at the top left of any page.

- Click the *PDF of This Chapter* link at the top right of any page in the chapter you want to print. The PDF version of the chapter you were viewing opens in a browser window.
- Your computer must have the free Adobe Acrobat reader installed in order to view and print PDF files. The Acrobat reader is available on the Adobe Web site at <http://www.adobe.com>.
- Click the print icon in the upper left of the window.



Tip: If your printer supports printing two pages on a single sheet of paper, you can save paper and printer ink by selecting this feature.

- **Printing the Full Manual.** Use the *Complete PDF Manual* link at the top left of any page.
 - Click the Complete PDF Manual link at the top left of any page in the manual. The PDF version of the complete manual opens in a browser window.
 - Click the print icon in the upper left of the window.



Tip: If your printer supports printing two pages on a single sheet of paper, you can save paper and printer ink by selecting this feature.

Revision History

Part Number	Version Number	Date	Description
202-10304-01	1.0	December 2007	Initial release

Chapter 1

Introduction

Congratulations on the purchase of the NETGEAR Smart Switch. The NETGEAR Smart Switch is a state-of-the-art, high-performance, IEEE-compliant network solution designed for users who require a large number of ports and want the power of Gigabit connectivity to eliminate bottlenecks, boost performance, and increase productivity. To simplify installation, the switch is shipped ready for use out of the box.

This chapter serves as an introduction to the GS700TR Series Smart Switch and provides the following information:

- [Overview](#)
- [Features](#)
- [Package Contents](#)

Overview

This Installation Guide is for the following NETGEAR Smart Switches:

- GS724TR – This product offers support for 24 ports of 10/100/1000 and two Form-factor slots which support 1000 (1000Base-SX/LX)/100M SFP.
- GS748TR – This product offers support for 48 ports of 10/100/1000 and four Form-factor slots which support 1000 (1000Base-SX/LX)/100M SFP.

Using Gigabit ports, high-speed connections can be made to a server or network backbone. For example:

- Linking to high-speed servers
- Providing 10/100/1000 copper and fiber connectivity

The GS700TR Series Smart Switch also provides the benefit of administrative management with a complete package of features for the observation, configuration, and control of the network. With a Web-based Graphical User Interface (GUI), the switch's many capabilities can be viewed and used in a simple and intuitive manner. The switch's management features include configuration for port and switch information, VLAN for traffic control, port trunking for increased bandwidth, and

Class of Service (CoS) for traffic prioritization. These features provide better understanding and control of the network. Initial discovery of the switch on the network requires the Smart Wizard Discovery program, a utility that runs on a PC.

The GS700TR Series Smart Switch can be free-standing, or rack mounted in a wiring closet or equipment room. It is IEEE-compliant and offers low latency for high-speed networking. All ports can automatically negotiate to the highest speed. This capability makes the switch ideal for environments that have a mix of Ethernet, Fast Ethernet, or Gigabit Ethernet devices. In addition, all RJ-45 ports operate in half- or full-duplex mode. The maximum segment length is 328 feet (100 meters) over Category 5 Unshielded Twisted-Pair (UTP) cable, but much longer for fiber connections using SFP GBIC modules.

Features

The following list identifies the key features of the NETGEAR Smart Switch.

- 24/48 RJ-45 10/100/1000M auto sensing Giga switching ports.
- 2/4 Small Form-factor Pluggable (SFP) GBIC slots which function as combo ports. Combo ports are single ports with two physical connections, SFP fiber and RJ-45 copper. The RJ-45 copper ports corresponding to the Combo ports are the last four 10/100/1000M auto sensing Giga switching ports on each device. If both devices are plugged in, the fiber connection is active, with fiber port taking priority if both are connected. The following SFP types are supported:
 - 1000Base-SX
 - 1000Base-LX
 - 100Base-FX
- The devices support full Netgear Smart Switch functionality.
- The devices provide full compatibility with IEEE standards:
 - IEEE 802.3i, (10BASE-T)
 - IEEE 802.3u (100BASE-TX, 100BASE-FX)
 - IEEE 802.3x (Full-duplex flow control)
 - IEEE 802.3ab (1000BASE-T)
 - IEEE 802.3z (1000BASE-X)
- Auto-sensing and auto-negotiating capabilities for all ports.

- Auto Uplink™ on all ports to make the right connection.
- Automatic address learning function to build the packet-forwarding information table. The table contains up to 4K Media Access Control (MAC) addresses.
- Full- and Half-duplex functions for all 10/100/1000 Mbps ports.
- Store-and-Forward transmission to remove bad packets from the network.
- Full-duplex IEEE 802.3x pause frame flow control.
- Active flow control to minimize packet loss/frame drops.
- Half-duplex back-pressure control.
- Per port LEDs, System LEDs.
- Standard 1U high, rack mountable 17” chassis.
- Fan speed control supported.

Package Contents

Figure 1-1 shows the package contents of the NETGEAR GS700TR Series Smart Switch.

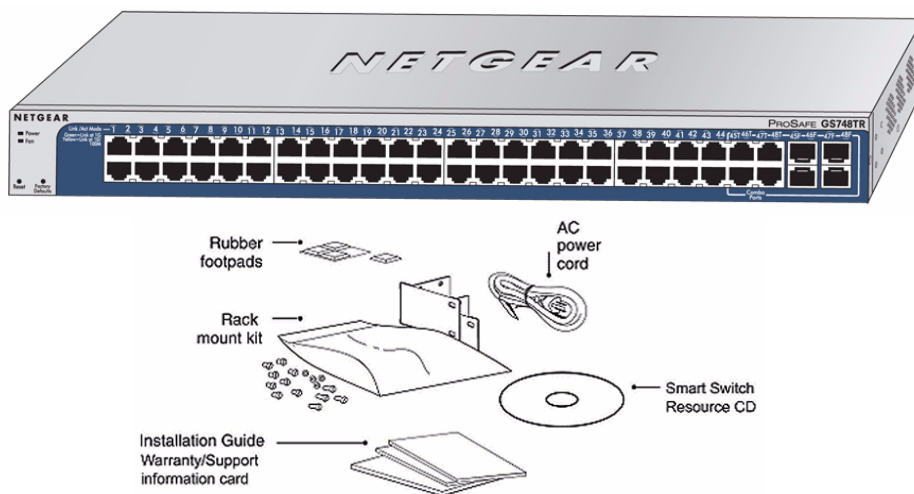

Figure 1-1

Verify that the package contains the following:

- NETGEAR Smart Switch

- Rubber footpads for tabletop installation
- Power cord
- Rack-mount kit for installing the switch in a 19-inch rack
- Installation guide
- Smart Switch Resource CD with Smart Wizard Discovery and User's manual
- Warranty/Support Information Card

If any item is missing or damaged, contact the place of purchase immediately.

Chapter 2

Physical Description

This chapter describes the NETGEAR Smart Switch hardware features. Topics include:

- [GS724TR Front and Back Panel Configuration](#)
- [GS748TR Front and Back Panel Configuration](#)
- [LED Designations](#)
- [Device Hardware Interfaces](#)

GS724TR Front and Back Panel Configuration

The GS724TR is a 24-Port 10/100/1000M + 2 SFP Combo ports Smart Switch with Static Routing. Every RJ45 port is capable of sensing the line speed and negotiating the operation duplex mode with the link partner automatically

[Figure 2-1](#) illustrates the NETGEAR GS724TR Smart Switch front panel:

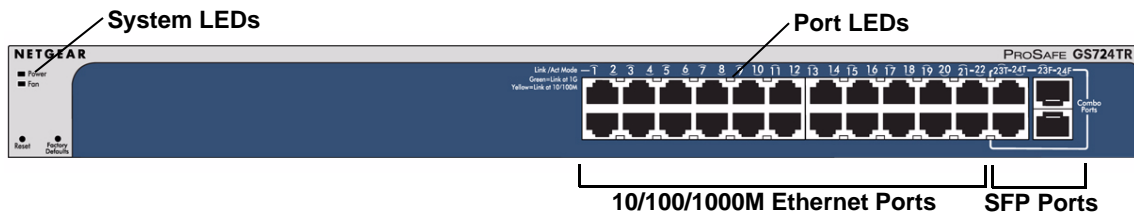

Figure 2-1

The front panel contains the following:

- 24 RJ-45 connectors for 10/100/1000Mbps auto sensing Gigabit Ethernet switching ports.
- Two SFP slots for SFP modules supporting 1000(1000Base-SX/LX)/100M SFP.
- Reset button to restart the device.
- Recessed default reset button to restore the device back to the factory defaults.
- Port LEDs

- System LEDs

Figure 2-2 illustrates the NETGEAR GS724TR Smart Switch back panel:

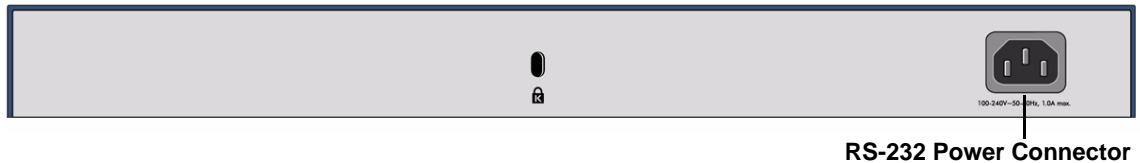

Figure 2-2

The back panel contains the following:

- A 100-240VAC/50-60 Hz universal input, which is a standard AC power receptacle for accommodating the supplied power cord.

GS748TR Front and Back Panel Configuration

The GS748TR is a 48-Port 10/100/1000M Smart Static Routing switch + 4 SFP Combo port switch. Every RJ45 port is capable of sensing the line speed and negotiating the operation duplex mode with the link partner automatically

Figure 2-3 illustrates the NETGEAR GS748TR Smart Switch front panel:

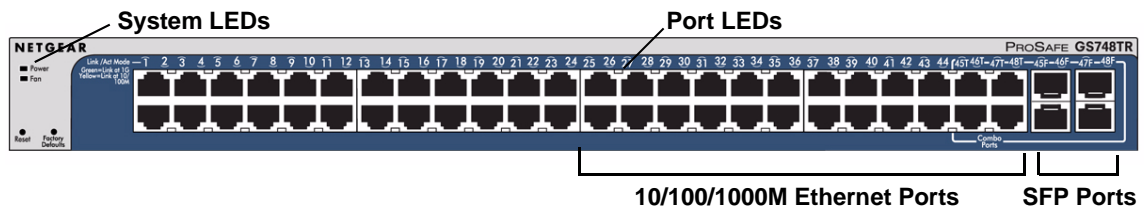

Figure 2-3

The front panel contains the following:

- 48 RJ-45 connectors for 10/100/1000Mbps auto sensing Gigabit Ethernet switching ports.
- Four SFP slots for SFP modules supporting 1000(1000Base-SX/LX)/100M SFP.
- Reset button to restart the device.
- Recessed default reset button to restore the device back to the factory defaults.
- Port LEDs

- System LEDs

Figure 2-4 illustrates the NETGEAR GS748TR Smart Switch back panel:



RS-232 Power Connector

Figure 2-4

The back panel contains the following:

- A 100-240VAC/50-60 Hz universal input, which is a standard AC power receptacle for accommodating the supplied power cord.

LED Designations

Port LEDs

The following table describes the port LED designations.

Table 2-1. Port LEDs

Port	LED	Designation
24/48-10/100/1000 Ports - One LED/Port	SPD/Link/ACT LED	<ul style="list-style-type: none"> • Solid Green - A valid 1000Mbps link is established on the port. • Flashing Green - Packet transmission or reception is occurring on the port at 1000Mbps. • Solid Yellow - A valid 10/100Mbps link is established on the port. • Flashing Yellow - Packet transmission or reception is occurring on the port at 10/100Mbps. • Off - No 10/100Mbps link is established on the port.

Table 2-1. Port LEDs (continued)

Port	LED	Designation
2/4-SFP Ports - One LED/ Port	SFP Link/ACT LED	<ul style="list-style-type: none">• Solid Green - A valid 1000Mbps SFP module link is established on the port.• Flashing Green - Packets transmission or reception is occurring on the port at 1000Mbps.• Solid Yellow - A valid 100Mbps SFP module link is established on the port.• Flashing Yellow - Packets transmission or reception is occurring on the port at 100Mbps.• Off - No SPD link is established on the port.

System LEDs

The following table describes the system LED designations.

Table 2-2. System LEDs

LED	Designation
Power LED	<ul style="list-style-type: none">• Solid Green - Power is supplied to the switch and is operating normally.• Off - Power is disconnected.
Fan LED	<ul style="list-style-type: none">• Yellow - The fan is not operating normally.• Off - The fan is operating normally.

Device Hardware Interfaces

RJ-45 Ports

RJ-45 ports are auto-sensing ports. When inserting a cable into an RJ-45 port, the switch automatically ascertains the maximum speed (10, 100 or 1000 Mbps) and duplex mode (half- or full-duplex) of the attached device. All ports support only unshielded twisted-pair (UTP) cable terminated with an 8-pin RJ-45 plug.

To simplify the procedure for attaching devices, all RJ-45 ports support Auto Uplink. This technology allows attaching devices to the RJ-45 ports with either straight-through or crossover cables. When inserting a cable into the switch's RJ-45 port, the switch automatically:

- Senses whether the cable is a straight-through or crossover cable.

- Determines whether the link to the attached device requires a “normal” connection (such as when connecting the port to a PC) or an “uplink” connection (such as when connecting the port to a router, switch, or hub).
- Configures the RJ-45 port to enable communications with the attached device, without requiring user intervention. In this way, the Auto Uplink technology compensates for setting uplink connections, while eliminating concern about whether to use crossover or straight-through cables when attaching devices.

SFP GBIC Module

The GBIC module bays accommodate standard SFP GBIC modules, such as the AGM731F, AGM732F, or AGM733 from NETGEAR, allowing fiber connections on the network. The module bay is a combo port, sharing a connection with an RJ-45 port. Being a combo port, only one type of connection can be active at any given time. For example, both copper and fiber port cannot be used at the same time. If both connectors are plugged in at the same time, the fiber port will be active.

The SFP GBIC bay accommodates a standard SFP GBIC module.

Factory Defaults Button

The Smart Switch has a Factory Default button so that you can remove the current configuration and return the device to its factory settings. When you enable the Factory Default button, all settings, including the password, VLAN settings and port configurations will be removed.

Chapter 3

Applications

Your NETGEAR Smart Switch is designed to provide flexibility in configuring your network connections. It can be used as a stand-alone device or with 10 Mbps, 100 Mbps, and 1000 Mbps hubs and switches.

Desktop Switching

The NETGEAR Smart Switch can be used as a desktop switch to build a small network that enables users to have 1000 Mbps access to a file server. With full-duplex enabled, the switch port connected to the server or PC can provide 2000 Mbps throughput.

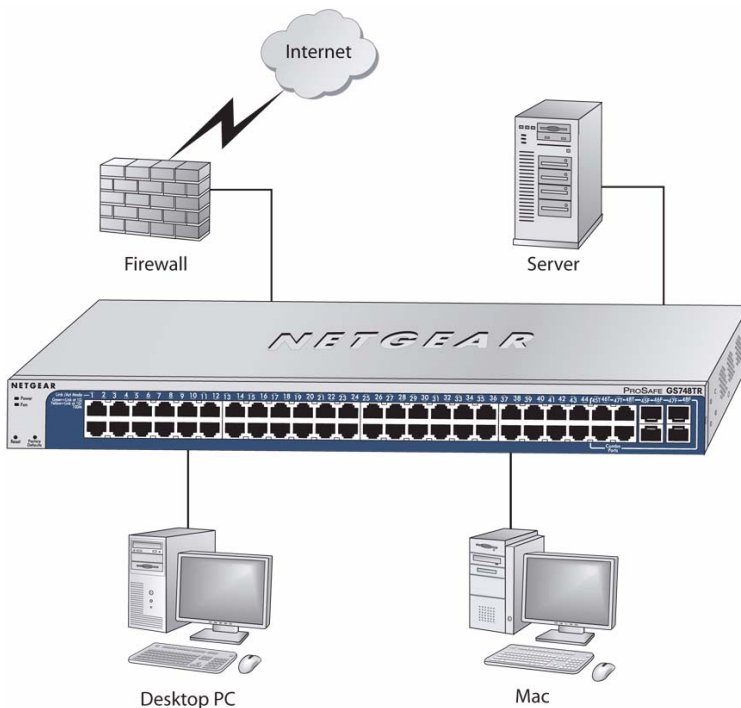

Figure 3-1

Chapter 4 Installation

This chapter describes the installation procedures for your NETGEAR Smart Switch. Switch installation involves the following steps:

[Step 1: Preparing the Site](#)

[Step 2: Installing the Switch](#)

[Step 3: Checking the Installation](#)

[Step 4: Connecting Devices to the Switch](#)

[Step 5: Installing an SFP GBIC Module](#)

[Step 6: Applying AC Power](#)

[Step 7: Managing the Switch using a Web Browser or the PC Utility](#)

Step 1: Preparing the Site

Before you installing the switch, ensure the operating environment meets the operating environment requirements in the following table.

Table 4-1. Site Requirements

Characteristics	Requirements
Mounting	<ul style="list-style-type: none">• Desktop installations - Provide a flat table or shelf surface.• Rack-mount installations - Use a 17-inch (48.3-centimeter) EIA standard equipment rack that is grounded and physically secure. The rack-mount kit supplied with the switch is also required.
Access	Locate the switch in a position that allows access to the front panel RJ-45 ports, view the front panel LEDs, and access power connector.

Table 4-1. Site Requirements (continued)

Characteristics	Requirements
Power source	Provide a power source within 6 feet (1.8 meters) of the installation location. Power specifications for the switch are shown in Appendix A . Ensure the AC outlet is not controlled by a wall switch, which can accidentally turn off power to the outlet and the switch.
Environmental	<ul style="list-style-type: none">• Temperature - Install the switch in a dry area, with ambient temperature between 0 and 55°C (32 and 131°F). Keep the switch away from heat sources such as direct sunlight, warm air exhausts, hot-air vents, and heaters.• Operating humidity - The installation location should have a maximum relative humidity of 90%, non-condensing.• Ventilation - Do not restrict airflow by covering or obstructing air inlets on the sides of the switch. Keep at least 2 inches (5.08 centimeters) free on all sides for cooling. Be sure there is adequate airflow in the room or wiring closet where the switch is installed.• Operating conditions - Keep the switch at least 6 ft. (1.83 m) away from nearest source of electromagnetic noise, such as a photocopy machine.

Step 2: Installing the Switch

The NETGEAR Smart Switch can be installed on a flat surface or in a standard 19-inch rack.

Installing the Switch on a Flat Surface

The switch ships with four self-adhesive rubber footpads. Stick one rubber footpad on each of the four concave spaces on the bottom of the switch. The rubber footpads cushion the switch against shock/vibrations.

Installing the Switch in a Rack

To install the switch in a rack, use the following procedure (and refer to [Figure 4-1](#)). To perform this procedure, the 17-inch rack-mount kit supplied with switch is required.

1. Attach the supplied mounting brackets to the side of the switch.
2. Insert the screws provided in the rack-mount kit through each bracket and into the bracket mounting holes in the switch.
3. Tighten the screws with a #1 Phillips screwdriver to secure each bracket.
4. Align the mounting holes in the brackets with the holes in the rack, and insert two pan-head screws with nylon washers through each bracket and into the rack.

5. Tighten the screws with a #2 Phillips screwdriver to secure the switch in the rack.

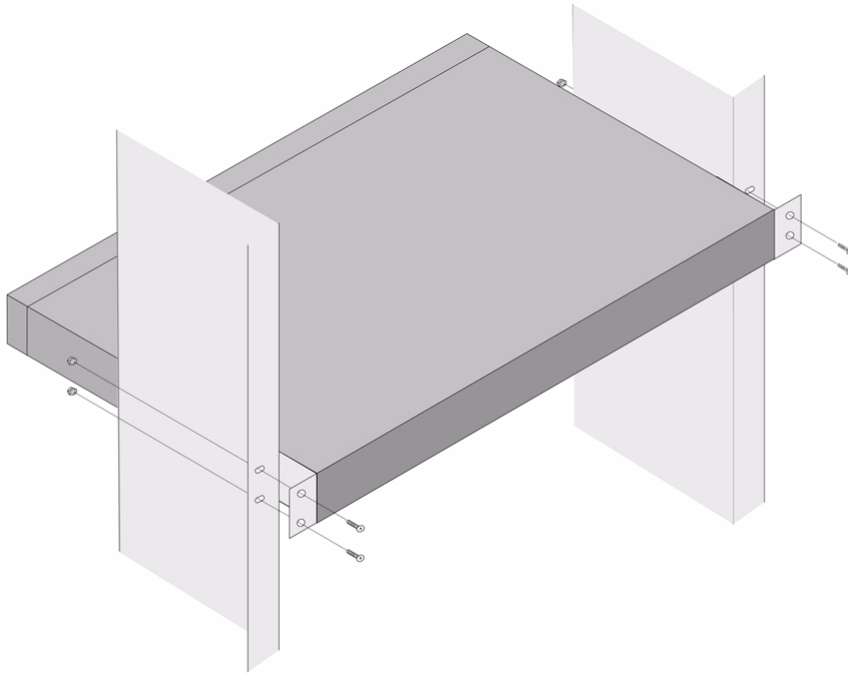

Figure 4-1

Step 3: Checking the Installation

Before applying power perform the following:

- Inspect the equipment thoroughly.
- Verify that all cables are installed correctly.
- Check cable routing to make sure cables are not damaged or creating a safety hazard.
- Ensure all equipment is mounted properly and securely.

Step 4: Connecting Devices to the Switch

The following procedure describes how to connect PCs to the switch's RJ-45 ports. The NETGEAR Smart Switch contains Auto Uplink™ technology, which allows the attaching of devices using either straight-through or crossover cables.

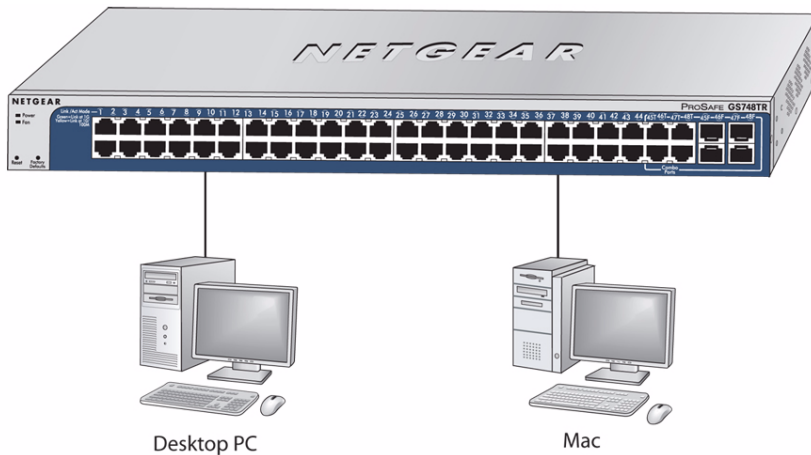

Figure 4-2

Connect each PC to an RJ-45 network port on the Switch front panel (Figure 4-2). Use Category 5 (Cat5) Unshielded Twisted-Pair (UTP) cable terminated with an RJ-45 connector to make these connections.



Note: Ethernet specifications limit the cable length between the switch and the attached device to 100 m (328 ft.).

Step 5: Installing an SFP GBIC Module

The following procedure describes how to install an SFP Gigabit Ethernet module in the switch's Gigabit module bay. Standard SFP GBIC modules are sold separately from the Smart Switch. If an SFP GBIC module is not being installed at this time, skip this procedure.

To install an SFP GBIC module:

Insert the SFP module into the SFP module bay. Press firmly to ensure the module seats into the connector.

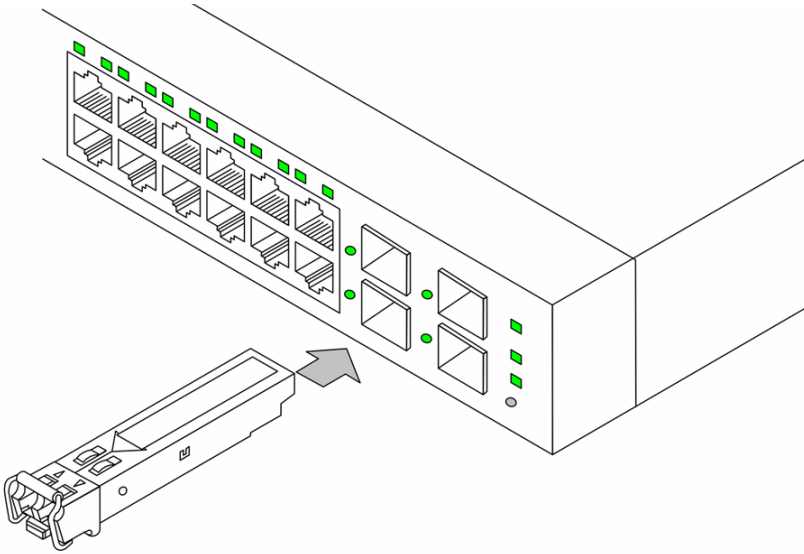

Figure 4-3

Step 6: Applying AC Power

NETGEAR Smart Switch does not have an ON/OFF switch. The method of applying or removing AC power is by connecting or disconnecting the power cord. Before connecting the power cord, select an AC outlet that is not controlled by a wall switch, which can turn off power to the switch. After selecting an appropriate outlet, use the following procedure to apply AC power.

1. Connect the female end of the supplied AC power adapter cable to the power receptacle on the back of the switch.
2. Connect the 3-pronged end of the AC power adapter cable to a grounded 3-pronged AC outlet.

When applying power, the Power LED on the switch's front panel is Green.

If the Power LED does not go on, check that the power cable is plugged in correctly and that the power source is good. If this does not resolve the problem, refer to [Appendix A](#).

Step 7: Managing the Switch using a Web Browser or the PC Utility

The NETGEAR Smart Switch contains software for viewing, changing, and monitoring the way it works. This management software is not required for the switch to work. The ports can be used without using the management software. However, the management software enables the setup of VLAN and Trunking features, and also improves the efficiency of the switch, which results in the improvement of its overall performance as well as the performance of the network.

After powering up the switch for the first time, the Smart Switch can be configured using a Web browser or a utility program called Smartwizard Discovery. For more information about managing the switch, see the *GS700TR Series Software Administration Manual* on the Smart Switch *Resource CD*.



Note: When the device powers up, there is a default IP address already configured on the device. The default IP address is 192.168.0.239 and subnet mask 255.255.255.0.

Appendix A

Troubleshooting

This chapter provides information about troubleshooting the NETGEAR Smart Switch. Topics include the following:

- [Troubleshooting Chart](#)
- [Additional Troubleshooting Suggestions](#)

Troubleshooting Chart

The following table lists symptoms, causes, and solutions of possible problems.

Table A-1. Troubleshooting Chart

Symptom	Cause	Solution
Power LED is off.	No power is received.	Check the power cord connections for the switch at the switch and the connected device. Ensure all cables used are correct and comply with Ethernet specifications.
Link LED is off or intermittent.	Port connection is not working.	Check the crimp on the connectors and make sure that the plug is properly inserted and locked into the port at both the switch and the connecting device. Ensure all cables used are correct and comply with Ethernet specifications. Check for a defective adapter card, cable, or port by testing them in an alternate environment where all products are functioning.
File transfer is slow or performance degradation is a problem.	Half- or full-duplex setting on the switch and the connected device are not the same.	Make sure the attached device is set to auto-negotiate.

Table A-1. Troubleshooting Chart

Symptom	Cause	Solution
A segment or device is not recognized as part of the network.	One or more devices are not properly connected, or cabling does not meet Ethernet guidelines.	Verify that the cabling is correct. Ensure all connectors are securely positioned in the required ports. Equipment may have been accidentally disconnected.
ACT LED is flashing continuously on all connected ports and the network is disabled.	A network loop (redundant path) has been created.	Break the loop by ensuring that there is only one path from any networked device to any other networked device.

Additional Troubleshooting Suggestions

If the suggestions in Troubleshooting Chart do not resolve the problem, refer to the troubleshooting suggestions in this section.

Network Adapter Cards

Ensure the network adapter cards installed in the PCs are in working condition and the software driver has been installed.

Configuration

If problems occur after altering the network configuration, restore the original connections and determine the problem by implementing the new changes, one step at a time. Ensure that cable distances, repeater limits, and other physical aspects of the installation do not exceed the Ethernet limitations.

Switch Integrity

If required, verify the integrity of the switch by resetting the switch. To reset the switch, remove the AC power from the switch and then reapply AC power. If the problem continues, contact NETGEAR technical support. In North America, call 1-888-NETGEAR. If you are outside of North America, please refer to the support information card included with your product.

Auto-Negotiation

The RJ-45 ports negotiate the correct duplex mode and speed if the device at the other end of the link supports auto negotiation. If the device does not support auto negotiation, the switch only determines the speed correctly and the duplex mode defaults to half-duplex.

The gigabit port on the Gigabit module negotiates speed, duplex mode, and flow control, provided that the attached device supports auto-negotiation.

Appendix B

Technical Specifications

Network Protocol and Standards Compatibility

IEEE 802.3i 10Base-T

IEEE 802.3u 100Base-TX,FX

IEEE 802.3ab 1000Base-T

IEEE 802.3z 1000Base-X

IEEE 802.3x flow control

Management

Windows 2000 + XP; Microsoft Explorer 6.0

IEEE 802.1p Class of Service (CoS)

SNTP (Simple Network Time Protocol) 2 servers. Disabled by default.

Interface

24/48 RJ-45 connectors for 10BASE-T, 100BASE-TX and 1000BASE-T (Auto Uplink™ on all ports).

2/4 Small Form-factor Pluggable (SFP) slots for SFP module.

LEDs

Per port (Gigabit): Link/Activity, Speed

Per device: Power, Fan Status

Performance Specifications

Forwarding modes: Store-and-forward

Bandwidth: 48 Gbps (for GS724TR); 96 Gbps (for GS748TR)

Address database size: 4K media access control (MAC) addresses per system

Mean Time Between Failure (MTBF): 265,404 hours for GS724TR; 196,908 hours for GS748TR

Power Supply

Power Consumption: 36.8W for GS724TR, 71.2W for GS748TR

100-240VAC/50-60 Hz universal input

Physical Specifications

Dimensions (H x W x D): GS724TR: 1.7 x 17.32 x 8.1/43 x 440 x 205 (in/mm);
GS748TR: 1.7 x 17.32 x 10.1 /43 x 440 x 257 (in/mm)

Weight: GS724TR: 5.51/2.50 (lbs/kg), GS748TR: 7.94/3.60 (lbs/kg)

Environmental Specifications

Operating temperature: 0 to 55°C (32 to 131°F)

Storage temperature: -20 to 70°C (28 to 158°F)

Operating humidity: 10-90% maximum relative humidity, non-condensing

Storage humidity: 5-95% maximum relative humidity, non-condensing

Operating altitude: 3,000 m (10,000 ft.) maximum

Storage altitude: 3,000 m (10,000 ft.) maximum

Electromagnetic Emissions

CE mark, commercial

FCC Part 15 Class A

VCCI Class A

C-Tick

Electromagnetic Immunity

EN 55022 (CISPR 22), Class A

Safety

CE mark, commercial

UL listed (UL 1950) / cUL IEC950 / EN60950

Modules

AGM731F 1000BASE-SX SFP GBIC for multimode fiber

AGM732F 1000BASE-LX SFP GBIC for single mode fiber

AGM733 1000BASE-LZ GBIC for long haul single mode fiber

Numerics

1000Base-LX [1-2](#)
1000Base-SX [1-2](#)
1000BASE-T [1-2](#)
1000BASE-X [1-2](#)
100-240VAC/50-60 [2-6](#)
100BASE-TX [1-2](#)
10BASE-T [1-2](#)
1U [1-3](#)
8-pin [2-8](#)

A

AC Power [2-6, 2-7](#)
AGM731F [2-9](#)
AGM732F [2-9](#)
AGM733 [2-9](#)
Applying AC Power [4-17](#)
Attaching Switch to a Rack [4-15](#)
Auto Sensing [1-2](#)
Auto Uplink [2-8, 2-9](#)
Auto-negotiating [1-2](#)
Auto-sensing [2-8](#)

B

Back-pressure [1-3](#)
Brackets [4-14](#)

C

Category 5 Unshielded Twisted-Pair [1-2](#)
Checking the Installation [4-15](#)

Class of Service [1-2](#)
Combo Port [2-9](#)
Combo Ports [1-2](#)
Connecting Devices to the Switch [4-16](#)
Copper [1-1](#)
Crossover [2-8](#)

D

Default IP Address [4-18](#)
Default Reset Button [2-5, 2-6](#)
Device Hardware Interfaces [2-8](#)
Duplex Mode [2-8](#)

E

Example of Desktop Switching [3-11](#)

F

Factory Default Button [2-9](#)
Factory Defaults [2-5](#)
Fan LED [2-8](#)
Fiber Connectivity [1-1](#)
Flat Surface [4-14](#)
Full-duplex [1-2](#)

G

GBIC [1-2, 2-9](#)
Gigabit Ports [1-1](#)

H

High-speed Servers [1-1](#)

Hz 2-6, 2-7

I

IEEE 802.3ab 1-2

IEEE 802.3i 1-2

IEEE 802.3u 1-2

IEEE 802.3x 1-2, 1-3

IEEE 802.3z 1-2

IEEE Standards 1-2

IEEE-compliant 1-2

Installation Guide 1-4

Installing an SFP GBIC Module 4-16

Installing the Switch 4-14

L

LED Designations 2-7

Link/ACT LED 2-7

Low Latency 1-2

M

MAC 1-3

Media Access Control 1-3

Mounting Holes 4-14

N

Nylon Washers 4-14

O

ON/OFF switch 4-17

Operating Conditions 4-14

Operating Environment 4-13

Operating humidity 4-14

Overview 1-1

P

Package Contents 1-3

Pause Frame Flow Control 1-3

Phillips Screwdriver 4-14

Port LEDs 2-7

Power cord 1-4

Preparing the Site 4-13

R

Rack 4-14

Rack-mount Kit 1-4, 4-14

Reset Button 2-5, 2-6

RJ-45 1-2

RJ-45 Ports 2-8

Rubber Footpad 4-14

Rubber footpads 1-4

S

SFP GBIC Module 2-9

SFP Link/ACT LED 2-8

SFP Module Bay 4-17

Site Requirements 4-13

Small Form-factor Pluggable (SFP) 1-2

Smart Switch Resource CD 1-4

Smart Wizard Discovery 1-2

Straight-through 2-8

Support Information Card 1-4

System LEDs 2-8

T

Temperature 4-14

Traffic Control 1-1

Troubleshooting Chart A-19

U

User Intervention 2-9

User's Manual 1-4

UTP 4-16

V

Ventilation [4-14](#)

VLAN [1-1](#)

W

Warranty [1-4](#)

Web-based Graphical User Interface [1-1](#)

