

Dell Pro 24 All-in-One QC24250

Owner's Manual

Notes, cautions, and warnings

 **NOTE:** A NOTE indicates important information that helps you make better use of your product.

 **CAUTION:** A CAUTION indicates either potential damage to hardware or loss of data and tells you how to avoid the problem.

 **WARNING:** A WARNING indicates a potential for property damage, personal injury, or death.

Chapter 1: Views of Dell Pro 24 All-in-One QC24250.....	7
Right.....	7
Left.....	8
Front.....	9
Retractable camera	10
Bottom.....	12
Back panel.....	13
Chapter 2: Set up your computer.....	15
Chapter 3: Specifications of Dell Pro 24 All-in-One QC24250.....	20
Dimensions and weight.....	20
Processor.....	20
Chipset.....	21
Operating system.....	22
Memory.....	22
External ports and slots.....	23
Internal slots.....	23
Ethernet.....	23
Wireless module.....	24
Audio.....	24
Storage.....	25
Media-card reader.....	25
Camera.....	25
Power ratings.....	26
Power supply connector.....	26
Display.....	27
GPU—Integrated.....	28
Hardware security.....	28
Environmental.....	28
Regulatory compliance.....	29
Operating and storage environment.....	29
Chapter 4: Working inside your computer.....	30
Safety instructions.....	30
Before working inside your computer.....	30
Safety precautions.....	31
Electrostatic discharge—ESD protection.....	31
ESD Field Service kit	32
Transporting sensitive components.....	33
After working inside your computer.....	33
BitLocker.....	33
Information on reparability for Québec - From Dell Canada Inc. - to Quebec consumers.....	33
Recommended tools.....	34

Screw list.....	34
Major components of your Dell Pro 24 All-in-One QC24250.....	35
Chapter 5: Removing and installing Customer Replaceable Units (CRUs).....	38
Stand.....	38
Removing the stand.....	38
Installing the stand.....	39
Back cover.....	41
Removing the back cover.....	41
Installing the back cover.....	41
Memory.....	42
Removing the memory.....	42
Installing the memory.....	43
System-board shield.....	44
Removing the system-board shield.....	44
Installing the system-board shield.....	45
Wireless card.....	46
Removing the wireless card.....	46
Installing the wireless card.....	47
Solid-state drive in M.2 slot 0.....	49
Removing the M.2 2230 solid-state drive in M.2 slot 0.....	49
Installing the M.2 2230 solid-state drive in M.2 slot 0.....	49
Location of the screw mount on M.2 slot 0.....	50
Solid-state drive in M.2 slot 1.....	51
Removing the M.2 2230 solid-state drive in M.2 slot 1.....	51
Installing the M.2 2230 solid-state drive in M.2 slot 1.....	52
Location of the screw mount on M.2 slot 1.....	53
Coin-cell battery.....	54
Removing the coin-cell battery.....	54
Installing the coin-cell battery.....	55
I/O cover.....	56
Removing the I/O cover.....	56
Installing the I/O cover.....	57
Bottom cover.....	58
Removing the bottom cover.....	58
Installing the bottom cover.....	59
Retractable-camera assembly.....	59
Removing the retractable-camera assembly.....	59
Installing the retractable-camera assembly.....	60
Fan.....	61
Removing the fan.....	61
Installing the fan.....	62
Power-supply unit.....	63
Removing the power-supply unit.....	63
Installing the power-supply unit.....	64
Chapter 6: Removing and installing Field Replaceable Units (FRUs).....	66
Power-supply fan.....	66
Removing the power-supply fan.....	66

Installing the power-supply fan.....	67
I/O bracket.....	69
Removing the I/O bracket.....	69
Installing the I/O bracket.....	69
Speakers.....	70
Removing the speakers.....	70
Installing the speakers.....	71
Heat sink.....	72
Removing the heat sink.....	72
Installing the heat sink.....	73
Processor.....	74
Removing the processor.....	74
Installing the processor.....	75
System board.....	76
Removing the system board.....	76
Installing the system board.....	79
Power-button and I/O board.....	83
Removing the power-button and I/O board.....	83
Installing the power-button and I/O board.....	84
Audio board.....	85
Removing the audio board.....	85
Installing the audio board.....	86
Display-assembly base.....	87
Removing the display-assembly base.....	87
Installing the display-assembly base.....	88
Chapter 7: Software.....	90
Operating system.....	90
Drivers and downloads.....	90
Chapter 8: BIOS Setup.....	91
Entering BIOS Setup program.....	91
Navigation keys.....	91
F12 One Time Boot menu.....	91
System setup options.....	92
Updating the BIOS.....	103
Updating the BIOS in Windows.....	103
Updating the BIOS in Linux and Ubuntu.....	103
Updating the BIOS using the USB drive in Windows.....	104
Updating the BIOS from the One-Time boot menu.....	104
System and setup password.....	104
Assigning a System Setup password.....	105
Deleting or changing an existing system password or setup password.....	105
Clearing CMOS settings.....	105
Clearing system and setup passwords.....	106
Chapter 9: Troubleshooting.....	107
Dell SupportAssist Pre-boot System Performance Check diagnostics.....	107
Running the SupportAssist Pre-Boot System Performance Check.....	107

Power-Supply Unit Built-in Self-Test	107
System-diagnostic lights.....	107
Recovering the operating system.....	108
Real-Time Clock—RTC reset.....	108
Backup media and recovery options.....	109
Network power cycle.....	109
Chapter 10: Getting help and contacting Dell.....	110
Chapter 11: Revision history.....	111

Views of Dell Pro 24 All-in-One QC24250

Right



Figure 1. Right view

1. USB 3.2 Gen 2 (10 Gbps) port with PowerShare

Connect devices such as external storage devices, printers, and external displays. Provides a data transfer speed of up to 10 Gbps.

Supports Power Delivery that enables two-way power supply between devices. Provides up to 10 W power output that enables faster charging.

NOTE: PowerShare enables you to charge your USB devices even when your computer is turned off.

NOTE: If a USB device is connected to the PowerShare port before the computer is turned off or in hibernate state, you must disconnect and connect it again to enable charging.

Left



Figure 2. Left view

1. Storage drive activity light

The activity light turns on when the computer reads from or writes to storage drives.

2. Global headset jack

Connect headphones or a headset (headphone and microphone combo).

Front



Figure 3. Front view

1. Left microphone

Provides digital sound input for audio recording and voice calls.

2. Right microphone

Provides digital sound input for audio recording and voice calls.

3. Retractable camera

Enables you to video-chat, capture photos, and record videos. To protect your privacy, this camera can be retracted when it is not in use.

4. Right speaker

Provides audio output.

5. Left speaker

Provides audio output.

Retractable camera

Locating the retractable camera

NOTE: To access your retractable camera, press down on the retractable camera located at the top of your computer. To conceal your retractable camera and protect your privacy, press down on the retractable camera until it clicks into place.



Figure 4. Locating the retractable camera

NOTE: Depending on the configuration ordered your computer may have a 5MP RGB + Infrared camera or a FHD RGB camera.

5MP RGB + Infrared camera

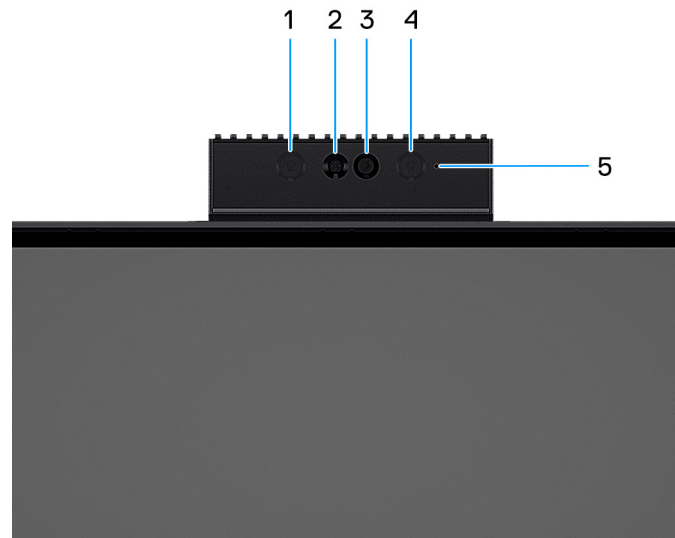

Figure 5. Retractable camera with a 5MP RGB + Infrared camera

1. Infrared emitter

Emits infrared light, which enables the infrared camera to sense and track motion.

2. Infrared camera

Enhances security when paired with Windows Hello face authentication.

3. Camera

Enables you to video chat, capture photos, and record videos.

4. Infrared emitter

Emits infrared light, which enables the infrared camera to sense and track motion.

5. Camera-status light

Turns on when the camera is in use.

FHD RGB camera

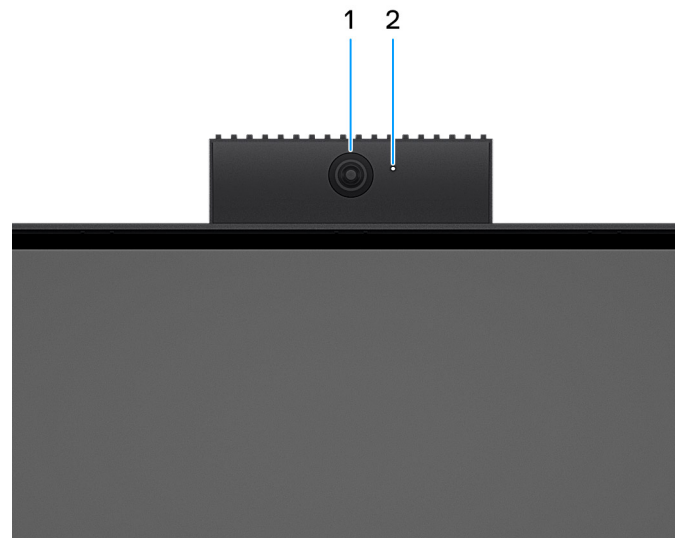

Figure 6. Retractable camera with FHD RGB camera

- 1. Camera**
Enables you to video chat, capture photos, and record videos.
- 2. Camera-status light**
Turns on when the camera is in use.

Bottom

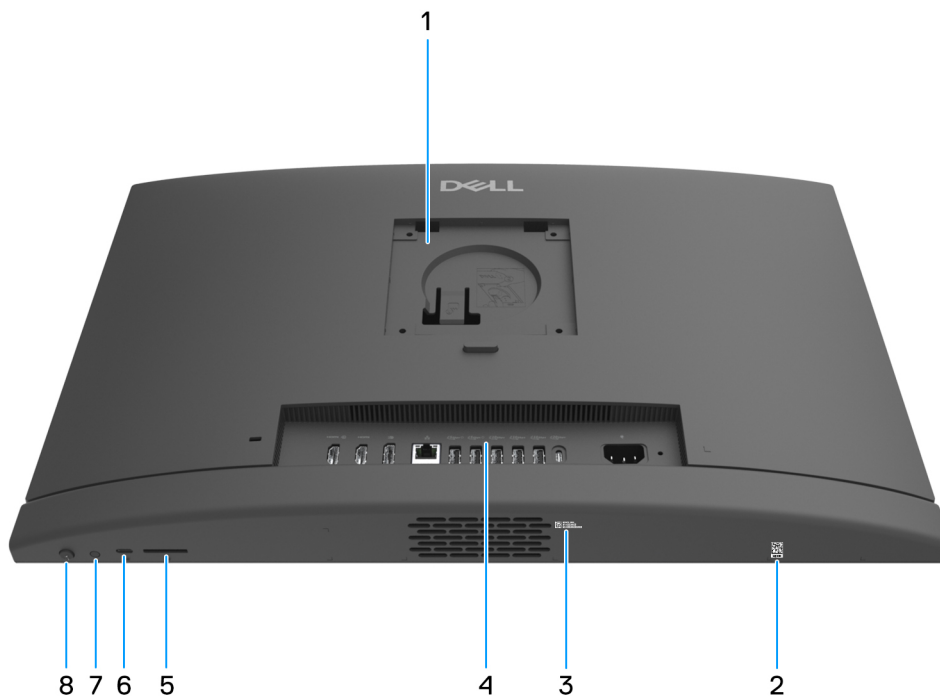

Figure 7. Bottom view

1. Stand/VESA mount location

Enables to install a 100 mm x 100 mm screw-pitch VESA connection for use in standard environmental conditions, or one of the stands offered by Dell for your computer.

2. MyDell QR code

MyDell is your hub for content personalized to your Dell Pro 24 All-in-One QC24250, including videos, articles, manuals, and easy access to support.

3. Service Tag label

The Service Tag is a unique alphanumeric identifier that enables Dell service technicians to identify the hardware components in your computer and access warranty information.

4. Back panel

Connect USB, audio, video, and other devices.

5. SD-card slot

Insert an SD card to read from and write to the SD card.

6. USB 3.2 Gen 2 (10 Gbps) Type-C port

Connect devices such as external storage devices and printers. Provides a data transfer rate of up to 10 Gbps.

7. Display Built-in Self Test (BIST)/Display input button

Press and hold this button until your computer initiates the Built-in Self Test (BIST).

Press to switch display input to and from the device connected to the HDMI-in port on the back panel.

8. Power button

Press to turn on the computer if it is turned off, in sleep state, or in hibernate state.

When the computer is turned on, press the power button to put the computer into sleep state; press and hold the power button for 10 seconds to force shut-down the computer.

 **NOTE:** You can customize the power-button behavior in Windows.

Back panel

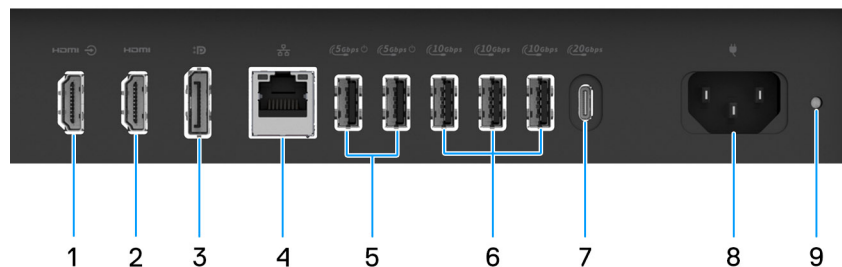

Figure 8. Back panel

1. HDMI-in 1.4 FHD/HDCP 1.4 port

Connect a gaming console, Blu-ray player, or other HDMI-out enabled device.

2. HDMI-out 2.1 TMDS 4k/HDCP2.3 port

Connect to a TV, external display, or another HDMI-in enabled device. Provides video and audio output and supports video output of up to 4096 x 2160 at 60 Hz.

3. DisplayPort++ 1.4a HBR3/HDCP 2.3 port

Connect an external display or a projector. Can support video output of up to 5120 x 3200 at 60 Hz.

4. RJ45 ethernet port (1 Gbps)

Connect an Ethernet (RJ45) cable from a router or a broadband modem for network or Internet access.

5. USB 3.2 Gen 1 (5 Gbps) ports with SmartPower On

Connect devices such as external storage devices and printers. Provides a data transfer speed of up to 5 Gbps.

 **NOTE:** When USB wake is enabled in the BIOS, the computer powers on or wakes from hibernation whenever a USB mouse or keyboard that is connected to this port is used.

6. USB 3.2 Gen 2 (10 Gbps) ports

Connect devices such as external storage devices and printers. Provides a data transfer speed of up to 10 Gbps.

7. USB 3.2 Gen 2x2 (20 Gbps) Type-C port

Connect devices such as external storage devices and printers. Provides a data transfer speed of up to 20 Gbps.

8. Power-cable connector

Connect a power cable to provide power to your computer.

9. Power-supply diagnostics light

Indicates the power-supply state.

Set up your computer

Steps

1. Connect the stand base to the stand.

i **NOTE:** You can use these instructions to install any of the stand configurations offered on your computer.

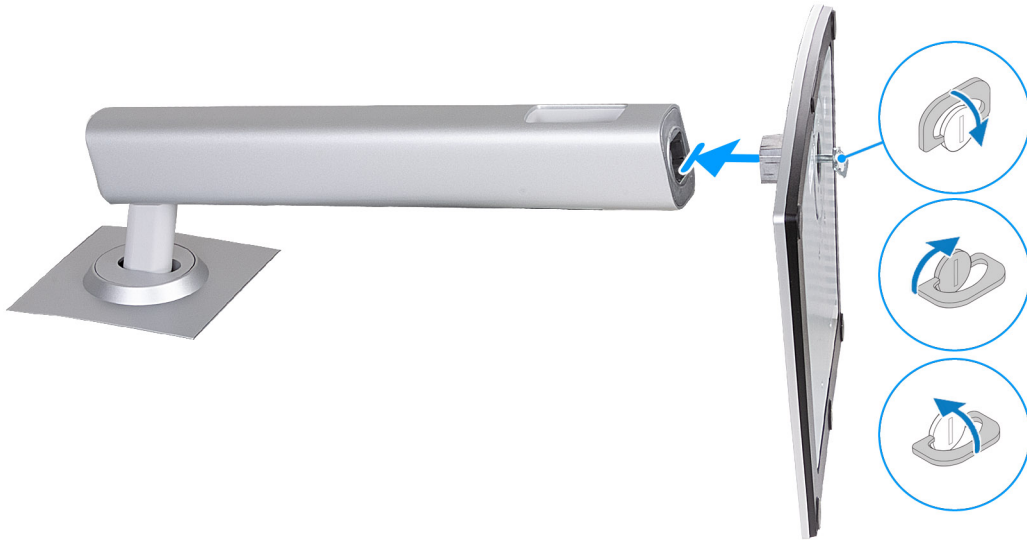

Figure 9. Installing the stand base

2. Insert the stand into the slot on the back cover and press downwards until it snaps into place.

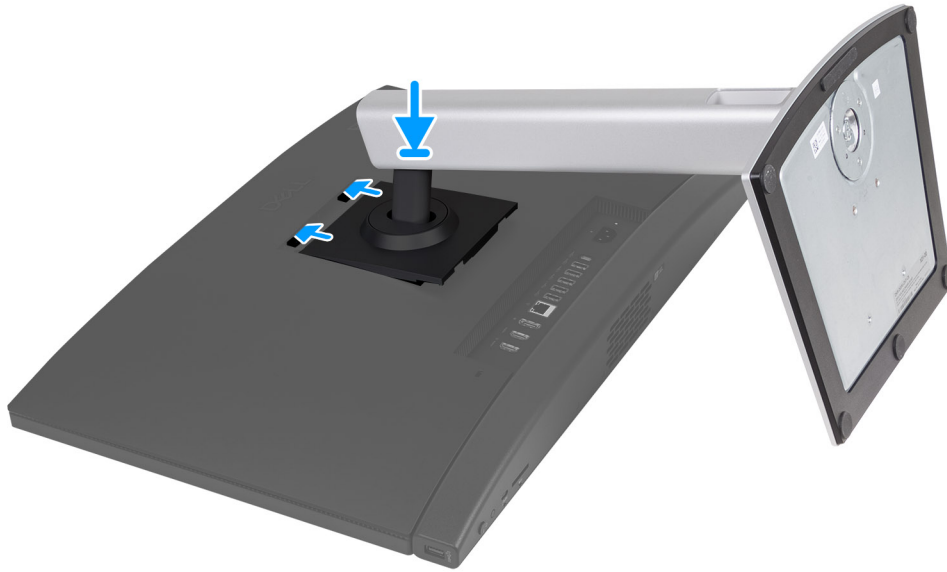

Figure 10. Installing the stand

3. Set up the keyboard and mouse.

i **NOTE:** For setup instructions, see the documentation shipped with the keyboard and mouse.

4. Connect the power cable.



Figure 11. Connecting the power cable

5. Press the power button to turn on your computer.



Figure 12. Pressing the power button

6. Finish the operating system setup.

For Ubuntu:

Follow the on-screen instructions to complete the setup. For more information about installing and configuring Ubuntu, see the knowledge base articles at [Dell Support Site](#).

For Windows:

Follow the on-screen instructions to complete the setup. When setting up, Dell Technologies recommends that you:

- Connect to a network for Windows updates.

NOTE: If connecting to a secured wireless network, enter the password for the wireless network access when prompted.





- If connected to the internet, sign-in with or create a Microsoft account. If not connected to the internet, create an offline account.

NOTE: Depending on the version of Windows installed, an internet connection may be required to set up your computer in order to sign-in to your Microsoft account or to create a Microsoft account.

- On the **Support and Protection** screen, enter your contact details.

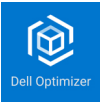
7. Locate and use Dell apps from the Windows Start menu—Recommended.

Table 1. Locate Dell apps

Resources	Description
	<p>Dell Optimizer is an application designed to enhance computer performance and productivity by optimizing settings for power, battery, display, collaboration touchpad, and presence detection. It also provides access to applications purchased with your new computer.</p> <p>For more information, see Dell Optimizer User's Guide at Dell Support Site</p>
	<p>Dell Product Registration</p> <p>Register your computer with Dell.</p>
	<p>Dell Help & Support</p> <p>Access help and support for your computer.</p>
	<p>SupportAssist</p> <p>SupportAssist is a proactive and predictive technology that offers automated technical support for Dell computers. It proactively monitors both hardware and software, addressing performance issues, preventing security threats, and automating engagement with Dell Technical Support.</p> <p>For more information, see SupportAssist documentation at Dell Support Site.</p> <p> NOTE: In SupportAssist, click the warranty expiry date to renew or upgrade your warranty.</p>

Specifications of Dell Pro 24 All-in-One QC24250

Dimensions and weight

The following table lists the height, width, depth, and weight of your Dell Pro 24 All-in-One QC24250.

Table 2. Dimensions and weight

Description	Values
Height:	
Front height	354.30 mm (13.95 in.)
Rear height	354.30 mm (13.95 in.)
Width	540 mm (21.26 in.)
Depth	57.90 mm (2.28 in.)
Weight  NOTE: The weight of your computer depends on the configuration that you ordered.	<ul style="list-style-type: none"> • Minimum (Fixed stand): 7.12 kg (15.69 lb) • Maximum (Fixed stand): 8.43 kg (18.57 lb) • Minimum (HAS stand): 8.09 kg (17.83 lb) • Maximum (HAS stand): 9.40 kg (20.71 lb) • Minimum (without stand): 5.22 kg (11.49 lb) • Maximum (without stand): 6.53 kg (14.38 lb)

Processor

The following table lists the details of the processors supported by your Dell Pro 24 All-in-One QC24250.

Table 3. Processor

Description	Option one	Option two	Option three
Processor type	Intel Core Ultra 5 235 vPro	Intel Core Ultra 5 245 vPro	Intel Core Ultra 7 265 vPro
Processor wattage	65 W	65 W	65 W
Processor total core count	14	14	20
Performance-cores	6	6	8
Efficient-cores	8	8	12
Processor total thread count i NOTE: Intel Hyper-Threading Technology is only available on Performance-cores.	14	14	20
Processor speed	Up to 5.00 GHz	Up to 5.10 GHz	Up to 5.30 GHz
Performance-cores frequency			
Processor base frequency	3.40 GHz	3.50 GHz	2.40 GHz
Maximum turbo frequency	5.00 GHz	5.10 GHz	5.30 GHz
Efficient-cores frequency			
Processor base frequency	2.90 GHz	3.00GHz	1.80 GHz
Maximum turbo frequency	4.40 GHz	4.50 GHz	4.60 GHz
Processor cache	24 MB	24 MB	30 MB
Integrated graphics	Intel Graphics	Intel Graphics	Intel Graphics
AI technology	Intel AI Boost	Intel AI Boost	Intel AI Boost
Neural Processing Unit (NPU) performance	Up to 13 TOPS	Up to 13 TOPS	Up to 13 TOPS
i NOTE: Tera Operations Per Second (TOPS) is an AI performance metric that measures how many trillions of operations per second an AI processor can perform.			

Chipset

The following table lists the details of the chipset that is supported by your Dell Pro 24 All-in-One QC24250.

Table 4. Chipset

Description	Values
Chipset	Intel Q870
Processor	Intel Core Ultra 5/7
DRAM bus width	64-bit
Flash EPROM	32 MB + 32 MB
PCIe bus	Up to Gen4

Operating system

Your Dell Pro 24 All-in-One QC24250 supports the following operating systems:

- Windows 11 Home
- Windows 11 Professional
- Windows 11 Pro National Academic
- Ubuntu Linux 24.04 LTS

Memory

The following table lists the memory specifications that are supported by your Dell Pro 24 All-in-One QC24250.

Table 5. Memory specifications

Description	Values
Memory slots	Two SoDIMM slots
Memory type	DDR5
Memory speed	<ul style="list-style-type: none"> • up to 6400 MT/s • up to 5600 MT/s
Maximum memory configuration	64 GB
Minimum memory configuration	8 GB
Memory size per slot	8 GB, 16 GB, or 32 GB
Memory configurations supported	<ul style="list-style-type: none"> • 8 GB: 1 x 8 GB, DDR5, 5600 MT/s, SoDIMM, single-channel • 16 GB: 2 x 8 GB, DDR5, 5600 MT/s, SoDIMM, dual-channel • 16 GB: 1 x 16 GB, DDR5, 5600 MT/s, SoDIMM, single-channel • 32 GB: 2 x 16 GB, DDR5, 5600 MT/s, SoDIMM, dual-channel • 32 GB: 1 x 32 GB, DDR5, 5600 MT/s, SoDIMM, single-channel • 64 GB: 2 x 32 GB, DDR5, 5600 MT/s, SoDIMM, dual-channel • 8 GB: 1 x 8 GB, DDR5, 6400 MT/s, SoDIMM, single-channel • 16 GB: 2 x 8 GB, DDR5, 6400 MT/s, SoDIMM, dual-channel • 16 GB: 1 x 16 GB, DDR5, 6400 MT/s, SoDIMM, single-channel • 32 GB: 2 x 16 GB, DDR5, 6400 MT/s, SoDIMM, dual-channel

External ports and slots

The following table lists the external ports and slots on your Dell Pro 24 All-in-One QC24250.

Table 6. External ports and slots

Description	Values
Network port	One RJ45 ethernet port (1 Gbps)
USB ports	<ul style="list-style-type: none"> One USB 3.2 Gen 2 (10 Gbps) port with PowerShare One USB 3.2 Gen 2x2 (20 Gbps) Type-C port Three USB 3.2 Gen 2 (10 Gbps) ports Two USB 3.2 Gen 1 (5 Gbps) ports with SmartPower On One USB 3.2 Gen 2 (10 Gbps) Type-C port
Audio port	One global headset jack
Video port(s)	<ul style="list-style-type: none"> One DisplayPort++ 1.4a HBR3/HDCP 2.3 port One HDMI-out 2.1 TMDS 4k/HDCP 2.3 port One HDMI-in 1.4 FHD/HDCP 1.4 port
Media-card reader	One SD-card 4.0 slot
Power-adaptor port	One power-cable connector
Security-cable slot	One security-cable slot (3 mm x 7 mm, T-Bar design)

Internal slots

The following table lists the internal slots on your Dell Pro 24 All-in-One QC24250.

Table 7. Internal slots

Description	Values
M.2	<ul style="list-style-type: none"> One M.2 2230 slot for Wi-Fi and Bluetooth combo card Two M.2 2230/2280 slot for solid-state drive <p> NOTE: To learn more about the features of different types of M.2 cards, search Dell Support Site.</p>
SATA	NA

Ethernet

The following table lists the wired ethernet Local Area Network (LAN) specifications of your Dell Pro 24 All-in-One QC24250.

Table 8. Ethernet specifications

Description	Values
Model	Intel i219-LM
Transfer rate	10/100/1000 Mbps

Wireless module

The following table lists the Wireless Local Area Network (WLAN) module specifications of your Dell Pro 24 All-in-One QC24250.

Table 9. Wireless module specifications

Description	Option one	Option two	Option three
Model number	Intel Wi-Fi 6E AX211	Intel Wi-Fi 7 BE200	MediaTek Wi-Fi 6 MT7920
Transfer rate	Up to 2400 Mbps	Up to 5760 Mbps	Up to 1200 Mbps
Frequency bands supported	2.4 GHz/5 GHz/6 GHz	2.4 GHz/5 GHz/6 GHz	2.4 GHz/5 GHz
Wireless standards	<ul style="list-style-type: none"> • Wi-Fi 802.11a/b/g • Wi-Fi 4 (Wi-Fi 802.11n) • Wi-Fi 5 (Wi-Fi 802.11ac) • Wi-Fi 6E (Wi-Fi 802.11ax) 	<ul style="list-style-type: none"> • Wi-Fi 802.11a/b/g • Wi-Fi 4 (Wi-Fi 802.11n) • Wi-Fi 5 (Wi-Fi 802.11ac) • Wi-Fi 6 (Wi-Fi 802.11ax) • Wi-Fi 7 (Wi-Fi 802.11be) 	<ul style="list-style-type: none"> • Wi-Fi 802.11a/b/g • Wi-Fi 4 (Wi-Fi 802.11n) • Wi-Fi 5 (Wi-Fi 802.11ac) • Wi-Fi 6 (Wi-Fi 802.11ax)
Encryption	<ul style="list-style-type: none"> • 64-bit/128-bit WEP • AES-CCMP • TKIP 	<ul style="list-style-type: none"> • 64-bit/128-bit WEP • AES-CCMP • TKIP 	<ul style="list-style-type: none"> • 64-bit/128-bit WEP • AES-CCMP • TKIP
Bluetooth wireless card  NOTE: The functionality of the Bluetooth wireless card may vary based on the operating system.	Bluetooth 5.3	Bluetooth 5.4	Bluetooth 5.4

Audio

The following table lists the audio specifications of your Dell Pro 24 All-in-One QC24250.

Table 10. Audio specifications

Description	Values
Audio controller	Realtek ALC3289
Stereo conversion	Supported
Internal audio interface	High Definition Audio (HDA) interface
External audio interface	One global headset jack
Number of speakers	Two stereo speakers
Internal-speaker amplifier	Supported
External volume controls	Not applicable
Speaker output:	
Average	2 W x 2 = 4 W
Microphone	Two microphones in the retractable-camera assembly

Storage

This section lists the storage options on your Dell Pro 24 All-in-One QC24250.

Your Dell Pro 24 All-in-One QC24250 supports a combination of :

- Up to two M.2 2230 solid-state drive

The primary drive of your Dell Pro 24 All-in-One QC24250 varies with the storage configuration. For computers, with a M.2 drive, the M.2 drive is the primary drive.

Table 11. Storage specifications

Storage type	Interface type	Capacity
M.2 2230 Solid State Drive	QLC PCIe Gen4 NVMe, up to 64 Gbps	Up to 2 TB
M.2 2230 Solid State Drive	TLC PCIe Gen4 NVMe, up to 64 Gbps	Up to 512 GB

Media-card reader

The following table provides the specification of media cards that are supported by your Dell Pro 24 All-in-One QC24250.

Table 12. Media-card reader specifications

Description	Values
Media-card slot type	One SD-card 4.0 slot
Media-cards supported	<ul style="list-style-type: none"> • Secure Digital (SD) • Secure Digital High Capacity (SDHC) • Secure Digital Extended Capacity (SDXC)
<p>NOTE: The maximum capacity of the media-card reader varies depending on the standard of the media card that is inserted in your computer.</p>	

Camera

The following table lists the camera specifications of your Dell Pro 24 All-in-One QC24250.

Table 13. Camera specifications

Description	Values
Number of cameras	One
Camera type	<ul style="list-style-type: none"> • FHD RGB camera • 5MP RGB + Infrared camera, ExpressSign-in with Presence Detection and Intelligent Privacy
Camera location	Retractable camera at the top of the computer
Camera sensor type	CMOS sensor technology
Camera resolution:	
Still image	<ul style="list-style-type: none"> • FHD RGB Camera: 2.07 megapixels • 5MP RGB Camera: 5.18 megapixels
Video	<ul style="list-style-type: none"> • FHD RGB Camera: 1920 x 1080 (FHD) at 30 fps • 5MP RGB Camera: 2880 x 1800 (5MP) at 30 fps

Table 13. Camera specifications (continued)

Description	Values
Diagonal viewing angle	<ul style="list-style-type: none"> FHD RGB Camera: 82 degrees 5MP RGB Camera: 91.20 degrees

Power ratings

The following table lists the power rating specifications of Dell Pro 24 All-in-One QC24250.

Table 14. Power ratings

Description	Option one
Type	160 W internal power supply unit (80PLUS Bronze Certified)
Input voltage	90 VAC–264 VAC
Input frequency	47 Hz–63 Hz
Input current (maximum)	2.80 A
Output current (continuous)	Operating: <ul style="list-style-type: none"> 19.50 VA: 7 A 19.50 VB: 5 A Standby: <ul style="list-style-type: none"> 19.50 VA: 0.50 A 19.50 VB: 1.75 A
Rated output voltage	<ul style="list-style-type: none"> 19.50 VA 19.50 VB
Temperature range:	
Operating	5°C to 42°C (41°F to 107.6°F)
Storage	-40°C to 70°C (-40°F to 158°F)

Power supply connector

The following table lists the Power supply connector specifications of your Dell Pro 24 All-in-One QC24250.

Table 15. Power supply connector

Power supply	Connectors
160 W internal power supply unit (80PLUS Bronze Certified)	<ul style="list-style-type: none"> One 8-pin connector for processor One 6-pin connector for system board One 6-pin connector for control signal One 2-pin connector for LED
240 W internal power supply unit (80PLUS Platinum Certified)	<ul style="list-style-type: none"> One 8-pin connector for processor One 6-pin connector for system board One 6-pin connector for control signal One 2-pin connector for LED

Display

The following table lists the display specifications of your Dell Pro 24 All-in-One QC24250.

Table 16. Display specifications

Description	Option one	Option two
Display type	Full High Definition (FHD), ComfortView Plus	Full High Definition (FHD), ComfortView Plus
Touch options	Non-touch	Touch
Display-panel technology	In-Plane Switching (IPS)	In-Plane Switching (IPS)
Display-panel dimensions (active area):		
Height	296.46 mm (11.67 in.)	296.46 mm (11.67 in.)
Width	527.04 mm (20.75 in.)	527.04 mm (20.75 in.)
Diagonal	604.70 mm (23.81 in.)	604.70 mm (23.81 in.)
Display-panel native resolution	1920 x 1080	1920 x 1080
Luminance (typical)	250 nits	300 nits
Megapixels	2.07	2.07
Color gamut	99% (sRGB)	99% (sRGB)
Pixels Per Inch (PPI)	92	92
Contrast ratio (minimum)	<ul style="list-style-type: none"> ● 1050:1, minimum ● 1500:1, typical 	<ul style="list-style-type: none"> ● 700:1, minimum ● 1000:1, typical
Response time (maximum)	<ul style="list-style-type: none"> ● 20 ms, minimum ● 14 ms, typical 	<ul style="list-style-type: none"> ● 20 ms, minimum ● 14 ms, typical
Refresh rate	100 Hz (maximum)	75 Hz (maximum)
Horizontal view angle	<ul style="list-style-type: none"> ● +/- 85 degrees, minimum ● +/- 89 degrees, typical 	<ul style="list-style-type: none"> ● +/- 85 degrees, minimum ● +/- 89 degrees, typical
Vertical view angle	<ul style="list-style-type: none"> ● +/- 85 degrees, minimum ● +/- 89 degrees, typical 	<ul style="list-style-type: none"> ● +/- 85 degrees, minimum ● +/- 89 degrees, typical
Pixel pitch	0.27 mm	0.27 mm
Power consumption (maximum)	15.18 W	17.26 W
Anti-glare vs glossy finish	Anti-glare	Anti-glare

GPU—Integrated

The following table lists the specifications of the integrated Graphics Processing Unit (GPU) supported by your Dell Pro 24 All-in-One QC24250.

Table 17. GPU—Integrated

Controller	External display support	Memory size	Processor
Intel Graphics	<ul style="list-style-type: none"> One DisplayPort++ 1.4a HBR3/HDCP 2.3 port (5120 x 3200@60 Hz) One HDMI-out 2.1 TMDS 4k/HDCP2.3 port (4096 x 2160@60 Hz) 	Shared system memory	Intel Core Ultra 5/7

Hardware security

The following table lists the hardware security of your Dell Pro 24 All-in-One QC24250.

Table 18. Hardware security

Hardware security
Kensington security-cable slot
Chassis intrusion switch
Trusted Platform Module TPM 2.0
SPI Flash Tamper Detection Circuit
FIPs 140-2 certification
Dell SafeBIOS including Dell Off-host BIOS Verification
BIOS Resilience
BIOS Recovery and additional BIOS Controls
SafelD including Trusted Platform Module (TPM) 2.0
Self-Encrypting Drives (SED)
D-Pedigree (Secure Supply Chain Functionality)

Environmental

The following table lists the environmental specifications of your Dell Pro 24 All-in-One QC24250.

Table 19. Environmental

Feature	Values
Recyclable packaging	Yes
BFR/PVC-free chassis	Yes
Vertical orientation packaging support	Yes
Multi-Pack packaging	No
Energy-efficient power supply	Yes
ENV0424 compliant	Yes

NOTE: As per the anticipated required criteria for EPEAT 2018/2025, wood-based fiber packaging contains a minimum of 35% recycled content by total weight of wood-based fiber.

Regulatory compliance

The following table lists the regulatory compliance of your Dell Pro 24 All-in-One QC24250.

Table 20. Regulatory compliance

Regulatory compliance
Product Safety, EMC and Environmental Datasheets
Dell Regulatory Compliance Home page
Responsible Business Alliance policy

Operating and storage environment

This table lists the operating and storage specifications of your Dell Pro 24 All-in-One QC24250.

Airborne contaminant level: G1 as defined by ISA-S71.04-1985

Table 21. Computer environment

Description	Operating	Storage
Temperature range	10°C to 35°C (50°F to 95°F)	-40°C to 65°C (-40°F to 149°F)
Relative humidity (maximum)	20% to 80% (non-condensing)	5% to 95% (non-condensing)
Vibration (maximum)*	0.26 GRMS	1.37 GRMS
Shock (maximum)	40 G†	105 G†
Altitude range	-15.2 m to 3048 m (-49.87 ft to 10000 ft)	-15.2 m to 10668 m (-49.87 ft to 35000 ft)
CAUTION: Operating and storage temperature ranges may differ among components, so operating or storing the device outside these ranges may impact the performance of specific components.		









* Measured using a random vibration spectrum that simulates the user environment.

† Measured using a 2 ms half-sine pulse.

Working inside your computer

Safety instructions

Use the following safety guidelines to protect your computer from potential damage and to ensure your personal safety. Unless otherwise noted, each procedure in this document assumes that you have read the safety information that shipped with your computer.



-  **WARNING:** Before working inside your computer, read the safety information that is shipped with your computer. For more safety best practices, see [Dell Regulatory Compliance Home Page](#).
-  **WARNING:** Disconnect your computer from all power sources before opening the computer cover or panels. After you finish working inside the computer, replace all covers, panels, and screws before connecting your computer to an electrical outlet.
-  **WARNING:** For laptops, discharge the battery completely before removing it. Disconnect the AC power adapter from the computer and operate the computer solely on battery power—the battery is fully discharged when the computer no longer turns on when the power button is pressed.
-  **CAUTION:** To avoid damaging the computer, ensure that the work surface is flat, dry, and clean.
-  **CAUTION:** You should only perform troubleshooting and repairs as authorized or directed by the Dell technical support team. Damage due to servicing that is not authorized by Dell is not covered by your warranty.
-  **CAUTION:** Before touching anything inside your computer, ground yourself by touching an unpainted metal surface, such as the metal at the back of the computer. While you work, periodically touch an unpainted metal surface to dissipate static electricity which could harm internal components.
-  **CAUTION:** To avoid damaging the components and cards, handle them by their edges, and avoid touching the pins and the contacts.
-  **CAUTION:** When you disconnect a cable, pull it by its connector or its pull tab, not the cable itself. Some cables have connectors with locking tabs or thumbscrews that you must disengage before disconnecting the cable. When disconnecting cables, keep them evenly aligned to avoid bending the connector pins. When connecting cables, ensure that the connector on the cable is correctly oriented and aligned with the port.
-  **CAUTION:** Press and eject any installed card from the media-card reader.

Before working inside your computer

About this task

 **NOTE:** The images in this document may differ from your computer depending on the configuration you ordered.

Steps

1. Save and close all open files and exit all open applications.
2. Shut down your computer. For Windows operating system, click **Start** >  **Power** > **Shut down**.
 -  **NOTE:** If you are using a different operating system, see the documentation of your operating system for shut-down instructions.
3. Turn off all the attached peripherals.
4. Disconnect your computer from the electrical outlet.

5. Disconnect all attached network devices and peripherals, such as keyboard, mouse, and monitor from your computer.

 **CAUTION: To disconnect a network cable, unplug the cable from your computer.**

6. Remove any media card and optical disc from your computer, if applicable.

Safety precautions

This section details the primary steps to be followed before disassembling any device or component.

Observe the following safety precautions before any installation or break-fix procedures involving disassembly or reassembly:

- Turn off the computer and all attached peripherals.
- Disconnect the computer from AC power.
- Disconnect all network cables and peripherals from the computer.
- Use an ESD field service kit when working inside your computer to avoid electrostatic discharge (ESD) damage.
- Place the removed component on an anti-static mat after removing it from the computer.
- Press and hold the power button for 15 seconds to discharge the residual power in the system board.

Bonding

Bonding is a method for connecting two or more grounding conductors to the same electrical potential. This is done by using a field service electrostatic discharge (ESD) kit. When connecting a bonding wire, ensure that it is connected to bare metal and never to a painted or nonmetal surface. Ensure that the wrist strap is secure and in full contact with your skin. Remove all jewelry, watches, bracelets, or rings before grounding yourself and the equipment.

Electrostatic discharge—ESD protection

ESD is a major concern when you handle electronic components, especially sensitive components such as expansion cards, processors, memory modules, and system boards. A slight charge can damage circuits in ways that may not be obvious, such as intermittent problems or a shortened product life span. As the industry pushes for lower power requirements and increased density, ESD protection is an increasing concern.

Two recognized types of ESD damage are catastrophic and intermittent failures.

- **Catastrophic** – Catastrophic failures represent approximately 20 percent of ESD-related failures. The damage causes an immediate and complete loss of device functionality. An example of catastrophic failure is a memory module that has received a static shock and immediately generates a "No POST/No Video" symptom with a beep code that is emitted for missing or nonfunctional memory.
- **Intermittent** – Intermittent failures represent approximately 80 percent of ESD-related failures. The high rate of intermittent failures means that most of the time when damage occurs, it is not immediately recognizable. The memory module receives a static shock, but the tracing is merely weakened and does not immediately produce outward symptoms that are related to the damage. The weakened trace may take weeks or months to melt, and in the meantime may cause degradation of memory integrity, intermittent memory errors, and so on.

Intermittent failures that are also called latent or "walking wounded" are difficult to detect and troubleshoot.

Perform the following steps to prevent ESD damage:

- Use a wired ESD wrist strap that is properly grounded. Wireless anti-static straps do not provide adequate protection. Touching the chassis before handling parts does not ensure adequate ESD protection on parts with increased sensitivity to ESD damage.
- Handle all static-sensitive components in a static-safe area. If possible, use anti-static floor pads and workbench pads.
- When unpacking a static-sensitive component from its shipping carton, do not remove the component from the anti-static packing material until you are ready to install the component. Before unwrapping the anti-static packaging, use the anti-static wrist strap to discharge the static electricity from your body.

 **NOTE:** You can protect against ESD and discharge static electricity from your body by touching a metal-grounded object before you interact with anything electronic, for example, an unpainted metal surface on your computer's I/O panel. When connecting a peripheral (including handheld digital assistants) to your computer, you should always ground both yourself and the peripheral before connecting it to the computer. In addition, as you work inside the computer, periodically touch a metal-grounded object to remove any static charge that your body may have accumulated.

For more information about the wrist strap and ESD wrist strap tester, see [Components of an ESD Field Service Kit](#).

- Before transporting a static-sensitive component, place it in an anti-static container or packaging.

ESD Field Service kit

The unmonitored field service kit is the most commonly used service kit. Each Field Service kit includes three main components: anti-static mat, wrist strap, and bonding wire.

 **CAUTION:** It is critical to keep ESD-sensitive devices away from internal parts that are insulated and often highly charged, such as plastic heat sink casings.

Working environment

Before the ESD Field Service kit is deployed, conduct an evaluation of the site to ensure proper setup and readiness. For example, deploying the kit for a server environment is different than for a desktop or laptop environment. Servers are typically installed in a rack within a data center; desktops or laptops are typically placed on office desks or cubicles. Always look for a large open flat work area that is free of clutter and large enough to deploy the ESD kit with additional space to accommodate the type of computer that is being repaired. The workspace should also be free of insulators that can cause an ESD event. On the work area, insulators such as styrofoam and other plastics should always be moved at least 12 inches or 30 centimeters away from sensitive parts before physically handling any hardware components.

ESD packaging

All ESD-sensitive devices must be shipped and received in static-safe packaging. Metal, static-shielded bags are preferred. However, you should always return the damaged component using the same ESD bag and packaging that the new part arrived in. The ESD bag should be folded over and taped shut and all the same foam packing material should be used in the original box that the new part arrived in. ESD-sensitive devices should be removed from packaging only at an ESD-protected work surface, and parts should never be placed on top of the ESD bag because only the inside of the bag is shielded. Always place parts in your hand, on the anti-static mat, in the computer, or inside an ESD bag.

Components of an ESD Field Service kit

The components of an ESD Field Service kit are:

- **Anti-Static Mat** – The anti-static mat is dissipative and parts can be placed on it during service procedures. When using an anti-static mat, your wrist strap should be snug and the bonding wire should be connected to the anti-static mat and to any bare metal on the computer being worked on. Once deployed properly, service parts can be removed from the ESD bag and placed directly on the anti-static mat. ESD-sensitive items are safe in your hand, on the anti-static mat, in the computer, or inside an ESD bag.
- **Wrist Strap and Bonding Wire** – If an anti-static mat is not being used, the wrist strap and bonding wire should be connected directly between your wrist and an exposed metal part of the hardware. If you are using an anti-static mat, connect the wrist strap and bonding wire to the anti-static mat to ensure protection for any hardware placed on the mat. The physical connection of the wrist strap and bonding wire between your skin, the anti-static mat, and the hardware is known as bonding. Use only Field Service kits with a wrist strap, anti-static mat, and bonding wire. Never use wireless wrist straps. Always be cautious that the internal wires of a wrist strap are prone to damage from normal wear and tear, and must be checked regularly with a wrist strap tester in order to avoid accidental ESD hardware damage. It is recommended to test the wrist strap and bonding wire at least once per week.
- **ESD Wrist Strap Tester** – The wires inside an ESD strap are prone to damage over time. When using an unmonitored ESD kit, it is recommended to test the wrist strap regularly—ideally before each service session, and at a minimum, once per week. The most reliable method for testing is with a wrist strap tester. To perform the test, connect the bonding wire of the wrist strap to the tester while wearing the strap. Press the test button to initiate the check. A green LED indicates a successful test, while a red LED and audible alarm signal a failure.

 **NOTE:** It is recommended to always use the traditional wired ESD grounding wrist strap and protective anti-static mat when servicing Dell products. In addition, it is critical to keep sensitive parts separate from all insulator parts while servicing the computer.

Transporting sensitive components

When transporting ESD sensitive components such as replacement parts or parts to be returned to Dell, it is critical to place these parts in anti-static bags for safe transport.

Lifting equipment

Adhere to the following guidelines when lifting heavy equipment:

 **CAUTION: Do not lift greater than 50 pounds. Always obtain additional resources or use a mechanical lifting device.**

1. Get a firm balanced footing. Keep your feet apart for a stable base, and point your toes out.
2. Tighten stomach muscles. Abdominal muscles support your spine when you lift, offsetting the force of the load.
3. Lift with your legs, not your back.
4. Keep the load close. The closer it is to your spine, the less force it exerts on your back.
5. Keep your back upright, whether lifting or setting down the load. Do not add the weight of your body to the load. Avoid twisting your body and back.
6. Follow the same technique in reverse to set the load down.

After working inside your computer

About this task

 **CAUTION: Leaving stray or loose screws inside your computer may severely damage your computer.**

Steps

1. Replace all screws and ensure that no stray screws remain inside your computer.
2. Connect any external devices, peripherals, or cables you removed before working on your computer.
3. Replace any media cards, discs, or any other components that you removed before working on your computer.
4. Connect your computer and all attached devices to their electrical outlets.
5. Turn on your computer.

BitLocker

When updating the BIOS on a computer with BitLocker enabled, consider the following precautions.

 **CAUTION: If BitLocker is not suspended before updating the BIOS, the BitLocker key will not be recognized the next time that you reboot the computer. You are prompted to enter the recovery key to progress, and the computer displays a prompt for the recovery key on each reboot. If the recovery key is not known, this can result in data loss or an operating system reinstall. For more information, see Knowledge Article: [updating the BIOS on Dell computers with BitLocker enabled](#).**

The installation of the following components triggers BitLocker:

- Hard disk drive or solid state drive
- System board

Information on repairability for Québec - From Dell Canada Inc. - to Quebec consumers

Dell does not guarantee the availability of replacement parts, repair services, or information necessary for maintenance or repair.

Recommended tools

The procedures in this document may require the following tools:

- Phillips screwdriver #2
- Plastic scribe

Screw list

NOTE: When removing screws from a component, it is recommended to note the screw type, the quantity of screws, and then place them in a screw storage box. This is to ensure that the correct number of screws and correct screw type is restored when the component is replaced.

NOTE: Some computers have magnetic surfaces. Ensure that the screws are not left attached to such surfaces when replacing a component.

NOTE: Screw color may vary depending on the configuration ordered.

Table 22. Screw list



















Component	Screw type	Quantity	Screw image
System-board shield	M3x5	6	
Wireless card	M2x3.5	1	
M.2 2230/2280 solid-state drive in M.2 slot 0	M2x3.5	1	
M.2 2230/2280 solid-state drive in M.2 slot 1	M2x3.5	1	
I/O cover	M3x5	2	
Bottom cover	M3x5	3	
Retractable-camera assembly	M3x5	4	
Fan	M3x5	3	
I/O bracket	M3x5	2	
Heat sink	Captive	5	
Power-supply unit	M3x5	3	

Table 22. Screw list (continued)

Component	Screw type	Quantity	Screw image
Power-supply unit connector	M3x5	2	
Power-supply fan	M3x5	2	
System board	M3x5	7	
	M3x12	1	
Power-button and I/O board shield	M3x5	3	
Power-button and I/O board	M3x5	2	
Audio board shield	M3x5	3	
Audio board	M3x5	2	

Major components of your Dell Pro 24 All-in-One QC24250

The following image shows the major components of your Dell Pro 24 All-in-One QC24250.

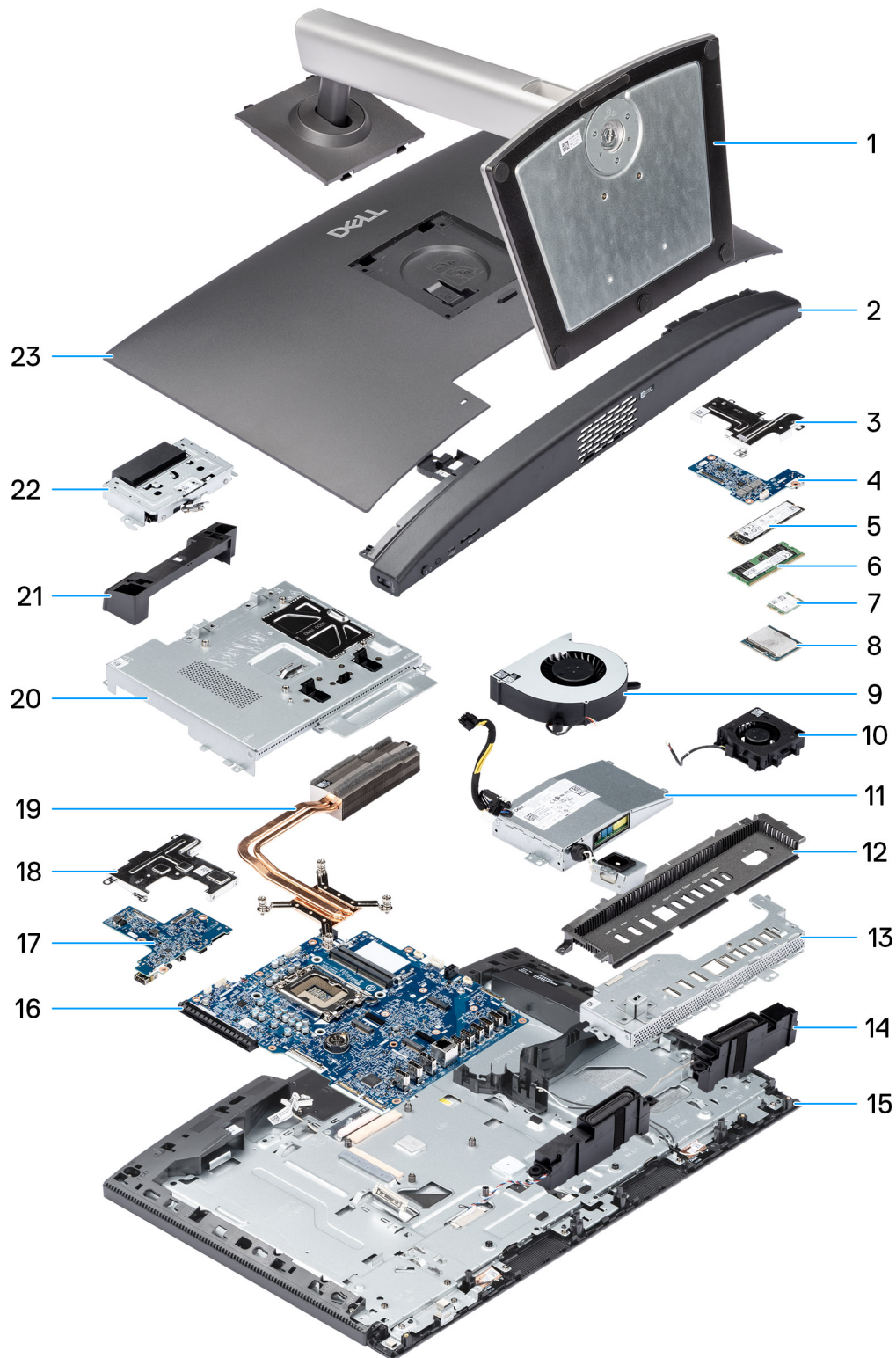



Figure 13. Major components of your Dell Pro 24 All-in-One QC24250

- 1. Stand
- 2. Bottom cover
- 3. Audio board shield
- 4. Audio board

5. M.2 2280 solid-state drive
6. Memory module
7. Wireless card
8. Processor
9. Fan
10. Power-supply fan
11. Power-supply unit (PSU)
12. I/O cover
13. I/O bracket
14. Speakers
15. Display assembly
16. System board
17. Power-button and I/O board
18. Power-button and I/O board shield
19. Heat sink
20. System board shield
21. Camera-assembly cover
22. Retractable-camera assembly
23. Back cover

 **NOTE:** Dell provides a list of components and their part numbers for the original configuration purchased. These parts are available according to warranty coverage purchased by the customer. Contact your Dell sales representative for purchase options.

Removing and installing Customer Replaceable Units (CRUs)

The replaceable components in this chapter are Customer Replaceable Units (CRUs).

CAUTION: Customers can replace only the Customer Replaceable Units (CRUs) following the safety precautions and replacement procedures.

NOTE: The images in this document may differ from your computer depending on the configuration you ordered.

Stand

Removing the stand

Prerequisites

1. Follow the procedure in [Before working inside your computer](#).

About this task

NOTE: Depending on the stand installed on your computer, refer to the corresponding image shown in the procedure.

The following images indicate the location of the stand and provide a visual representation of the removal procedure.



Figure 14. Removing the Height Adjustable Stand (HAS)



Figure 15. Removing the Fixed Stand

Steps

1. Place the display-assembly base on a clean and flat surface.
2. To release the stand, gently press and hold the tab that secures the stand to the display-assembly base.
3. Slide and lift the stand off the display-assembly base.

Installing the stand

Prerequisites

If you are replacing a component, remove the existing component before performing the installation process.

About this task

i **NOTE:** Depending on the stand you are installing onto your computer, refer to the corresponding image shown in the procedure.

The following images indicate the location of the stand and provide a visual representation of the installation procedure.



Figure 16. Installing the Height Adjustable Stand (HAS)



Figure 17. Installing the Fixed Stand

Steps

1. At an angle, align the tabs on the stand with the slots on the display-assembly base.
2. Slide the tabs on the stand into the slots on the display-assembly base and press downwards until it snaps into place.

Next steps

1. Follow the procedure in [After working inside your computer](#).

Back cover

Removing the back cover

Prerequisites

1. Follow the procedure in [Before working inside your computer](#).
2. Remove the [stand](#).

About this task

The following image indicates the location of the back cover and provides a visual representation of the removal procedure.

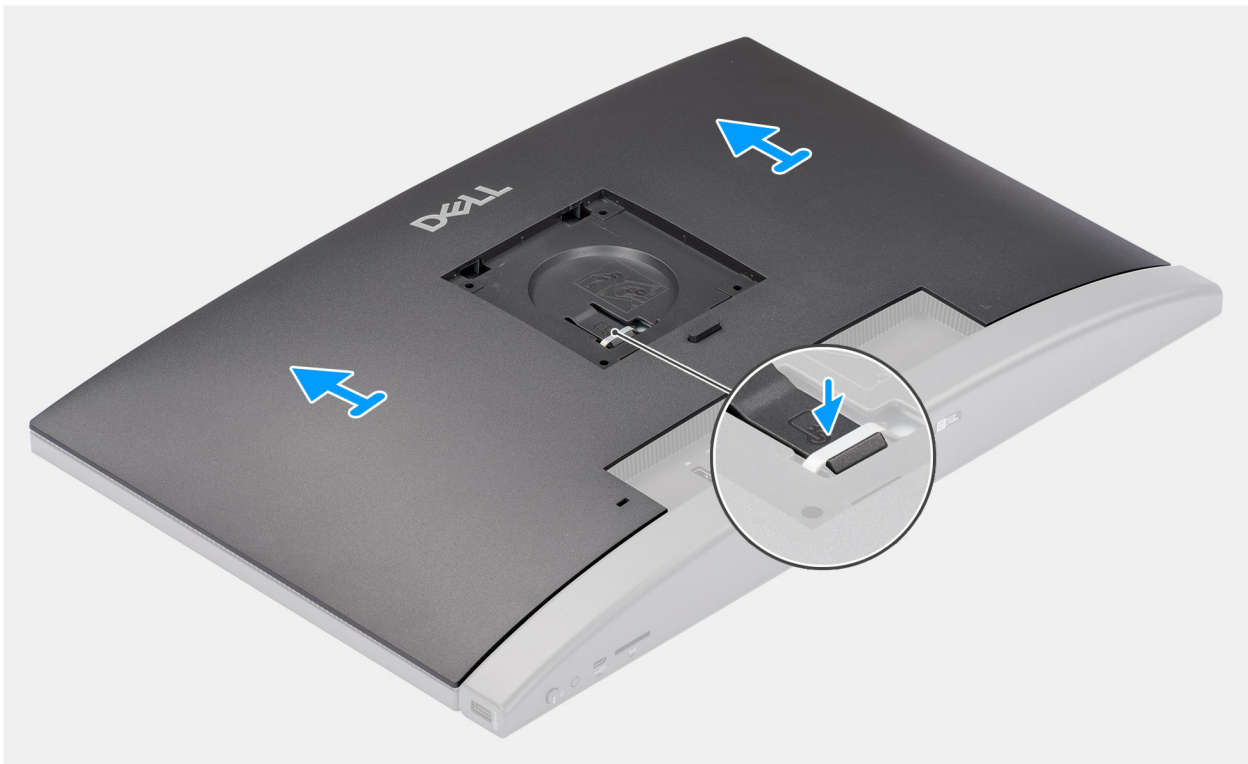

Figure 18. Removing the back cover

Steps

1. Press down on the tab that secures the back cover to the display-assembly base.
2. Slide the back cover upward and lift it off the display-assembly base.

Installing the back cover

Prerequisites

If you are replacing a component, remove the existing component before performing the installation process.

About this task

The following image indicates the location of the back cover and provides a visual representation of the installation procedure.



Figure 19. Installing the back cover

Steps

1. Align the back cover to the display-assembly base.
2. Place and slide the back cover into place on the display assembly base.

Next steps

1. Install the [stand](#).
2. Follow the procedure in [After working inside your computer](#).

Memory

Removing the memory

Prerequisites

1. Follow the procedure in [Before working inside your computer](#).
2. Remove the [stand](#).
3. Remove the [back cover](#).

About this task

The following image indicates the location of the memory and provides a visual representation of the removal procedure.

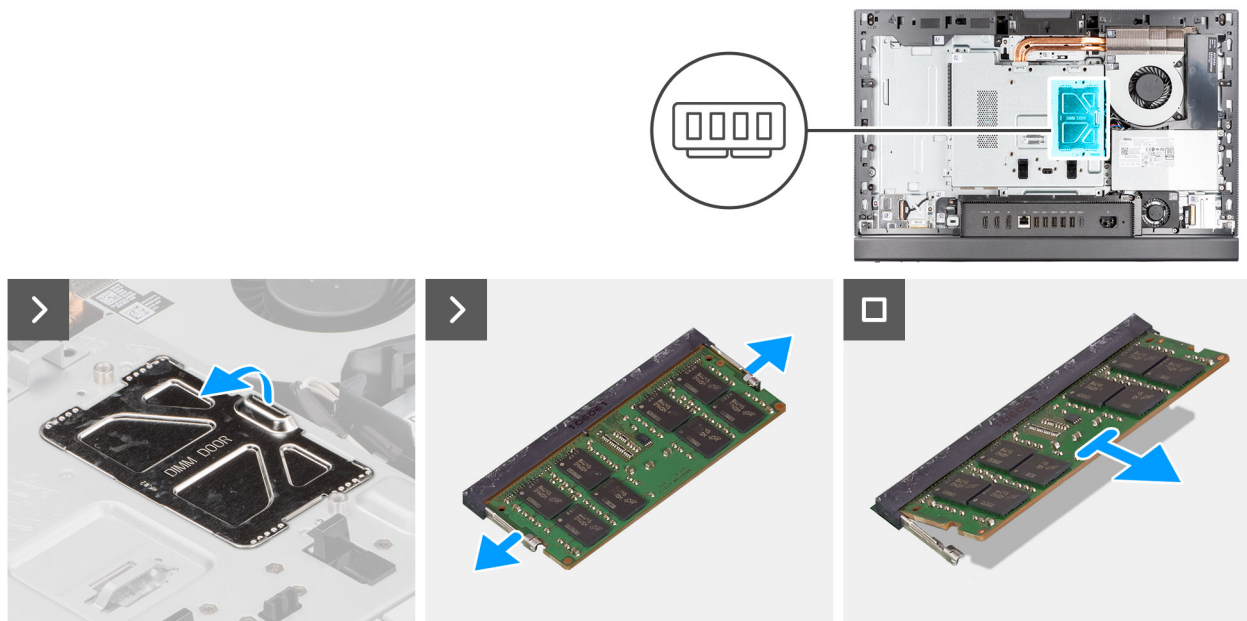

Figure 20. Removing the memory

Steps

1. Using the tab on the DIMM door, pry open and lift the DIMM door on the system-board shield to access the memory slots.
2. Using your fingertips, carefully spread apart the securing clips on each end of the memory-module slot until the memory module pops out.
3. Remove the memory module from the memory-module slot.

i **NOTE:** Repeat steps 2 to 3 for each memory module installed on your computer.

Installing the memory

Prerequisites

If you are replacing a component, remove the existing component before performing the installation process.

About this task

The following image indicates the location of the memory and provides a visual representation of the installation procedure.

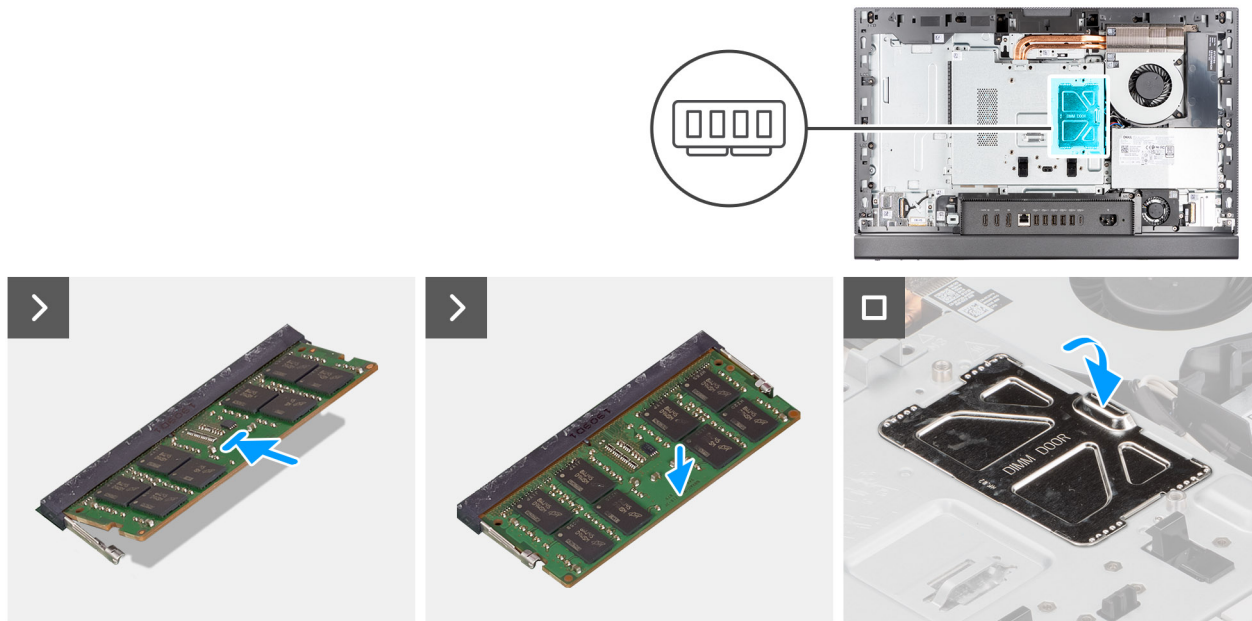

Figure 21. Installing the memory

Steps

1. Align the notch on the memory module with the tab on the memory-module slot.
2. Slide the memory module firmly into the slot at an angle and press down on the memory module down until it clicks into place.
 - NOTE:** If you do not hear the click, remove the memory module and reinstall it.
 - NOTE:** Repeat steps 1 to 2 for each memory module to be installed on your computer.
3. Close the DIMM door and press it into place to secure it.

Next steps

1. Install the [back cover](#).
2. Install the [stand](#).
3. Follow the procedure in [After working inside your computer](#).

System-board shield

Removing the system-board shield

Prerequisites

1. Follow the procedure in [Before working inside your computer](#).
2. Remove the [stand](#).
3. Remove the [back cover](#).

About this task

The following image indicates the location of the system-board shield and provides a visual representation of the removal procedure.



6x
M3x5

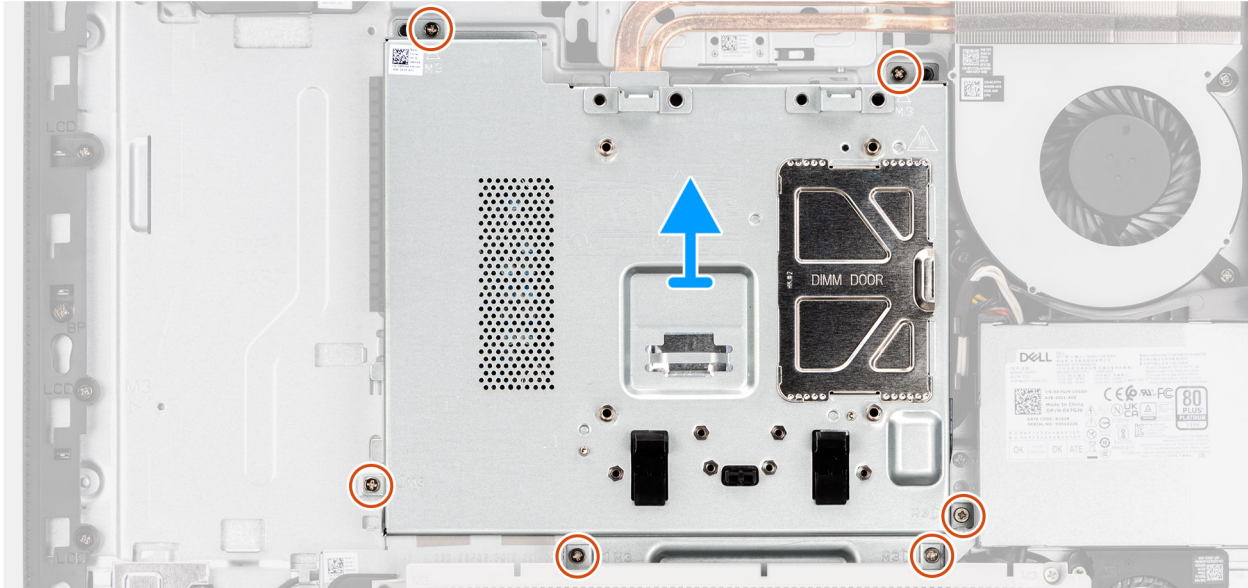
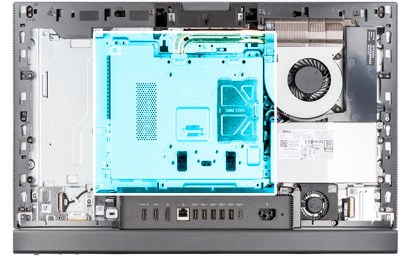

Figure 22. Removing the system-board shield

Steps

1. Remove the six screws (M3x5) that secure the system-board shield to the display-assembly base.
2. Lift the system-board shield off the display-assembly base.

Installing the system-board shield

Prerequisites

If you are replacing a component, remove the existing component before performing the installation process.

About this task

The following image indicates the location of the system-board shield and provides a visual representation of the installation procedure.



6x
M3x5

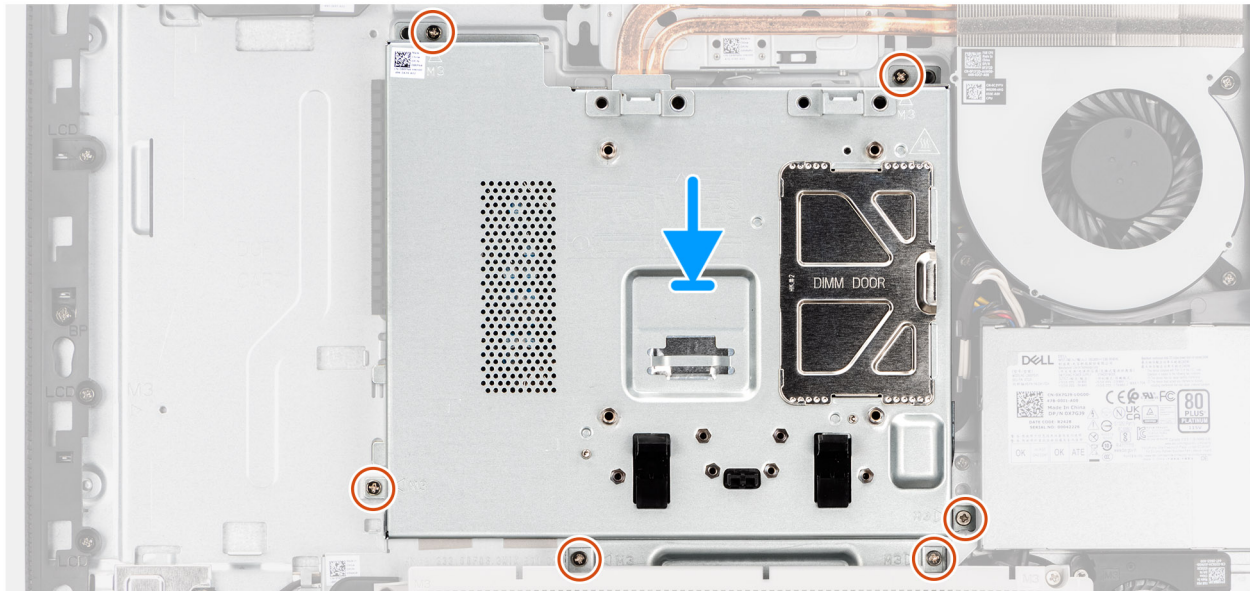
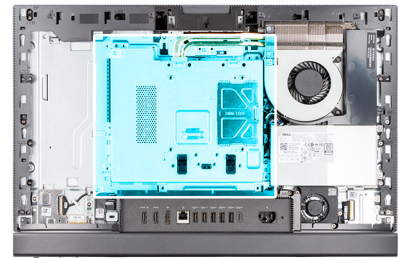

Figure 23. Installing the system-board shield

Steps

1. Place the system-board shield on the display-assembly base.
2. Align the screw holes on the system-board shield with the screw holes on the display-assembly base.
3. Replace the six screws (M3x5) to secure the system-board shield to the display-assembly base.

Next steps

1. Install the [back cover](#).
2. Install the [stand](#).
3. Follow the procedure in [After working inside your computer](#).

Wireless card

Removing the wireless card

Prerequisites

1. Follow the procedure in [Before working inside your computer](#).
2. Remove the [stand](#).
3. Remove the [back cover](#).
4. Remove the [system-board shield](#).

About this task

The following image indicates the location of the wireless card and provides a visual representation of the removal procedure.



1x
M2x3.5

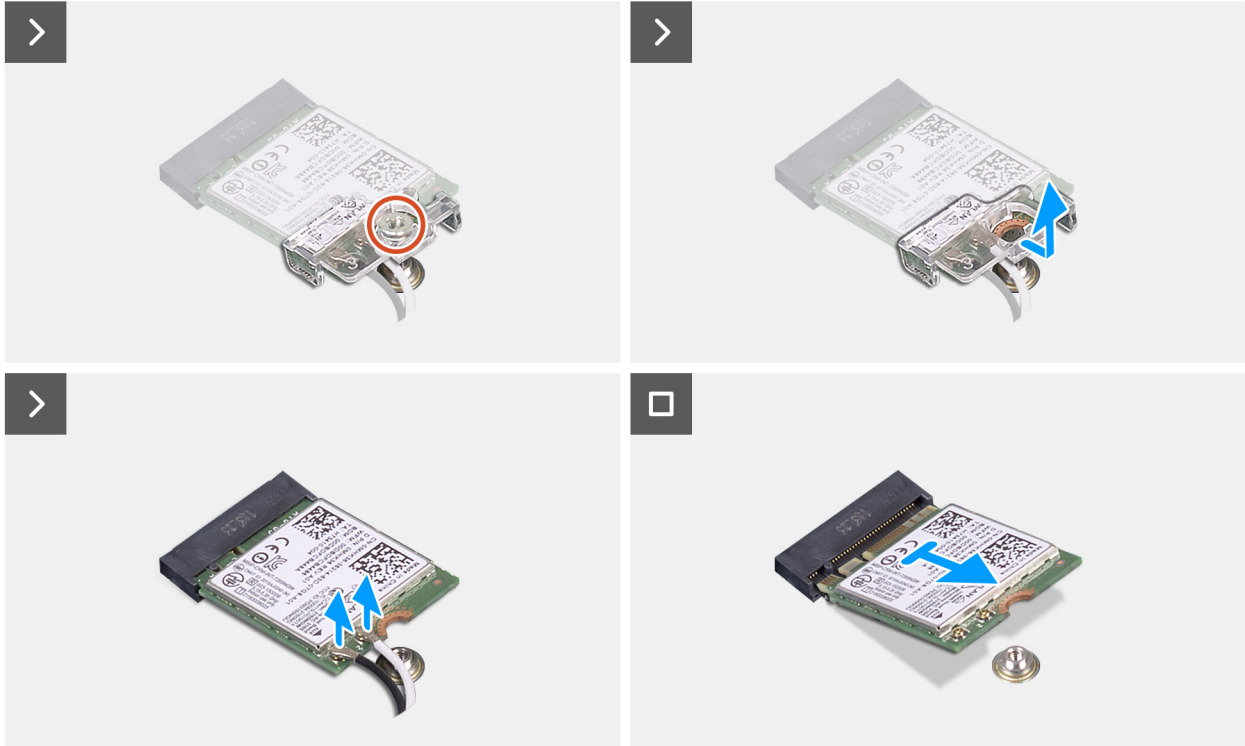
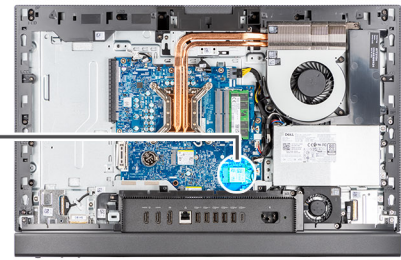

Figure 24. Removing the wireless card

Steps

1. Remove the screw (M2x3.5) that secures the wireless-card bracket to the wireless card.
2. Lift the wireless-card bracket off the wireless card.
3. Disconnect the antenna cables from the wireless card.
4. Slide and lift the wireless card from the wireless-card slot (M.2 WLAN).

Installing the wireless card

Prerequisites

If you are replacing a component, remove the existing component before performing the installation process.

About this task

The following image indicates the location of the wireless card and provides a visual representation of the installation procedure.



1x
M2x3.5

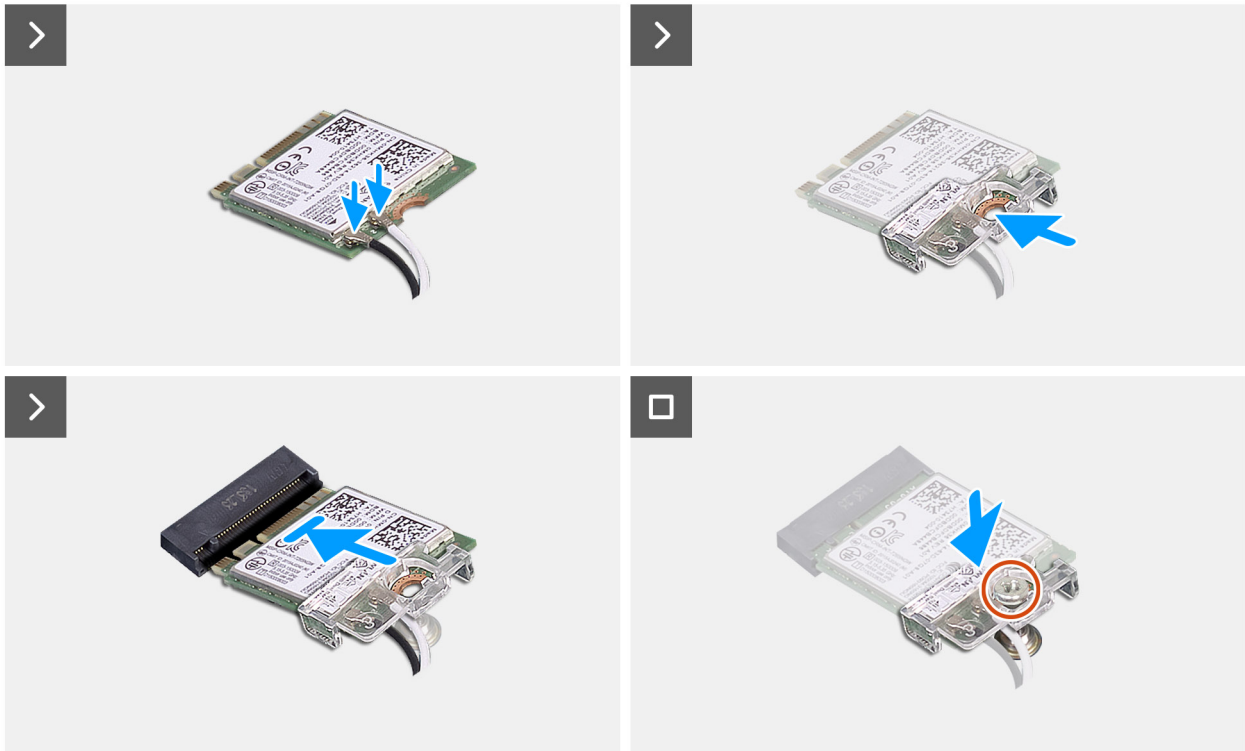
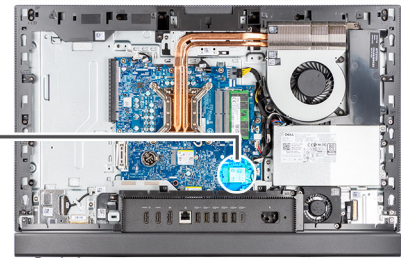

Figure 25. Installing the wireless card

Steps

1. Connect the antenna cables to the wireless card.

Table 23. Antenna-cable color scheme

Connector on the wireless card	Antenna-cable color	Silkscreen marking	
Main	White	MAIN	△ (white triangle)
Auxiliary	Black	AUX	▲ (black triangle)

2. Place the wireless-card bracket on the wireless card.
3. Align the notch on the wireless card with the tab on the wireless-card slot (M.2 WLAN).
4. Slide the wireless card at an angle into the wireless-card slot (M.2 WLAN).
5. Replace the screw (M2x3.5) that secures the wireless-card bracket to the wireless card.

Next steps

1. Install the [system-board shield](#).
2. Install the [back cover](#).
3. Install the [stand](#).
4. Follow the procedure in [After working inside your computer](#).

Solid-state drive in M.2 slot 0

Removing the M.2 2230 solid-state drive in M.2 slot 0

Prerequisites

1. Follow the procedure in [Before working inside your computer](#).
2. Remove the [stand](#).
3. Remove the [back cover](#).
4. Remove the [system-board shield](#).

About this task

- NOTE:** Depending on the configuration ordered, your computer may have up to two M.2 2230 or 2280 solid-state drives installed in the solid-state drive slots on the system board.
- NOTE:** This procedure is applicable for computers where an M.2 2230 solid-state drive is installed in the solid-state drive slot (M.2 PCIe SSD 0) on the system board.

The following image indicates the location of the M.2 2230 solid-state drive in M.2 slot 0 and provides a visual representation of the removal procedure.

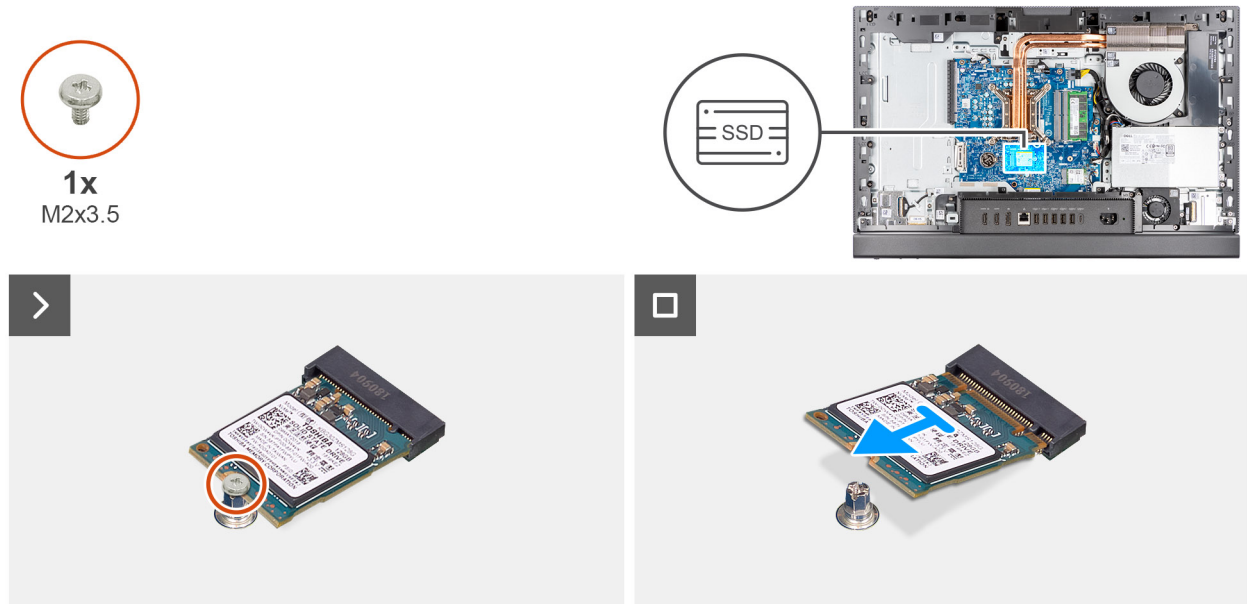

Figure 26. Removing the M.2 2230 solid-state drive in M.2 slot 0

Steps

1. Remove the screw (M2x3.5) that secures the M.2 2230 solid-state drive to the system board.
2. Slide and lift the M.2 2230 solid-state drive from the solid-state drive slot (M.2 PCIe SSD 0) on the system board.

Installing the M.2 2230 solid-state drive in M.2 slot 0

Prerequisites

If you are replacing a component, remove the existing component before performing the installation process.

About this task

- NOTE:** This procedure is only applicable if you are installing an M.2 2230 solid-state drive into the solid-state drive slot (M.2 PCIe SSD 0) on the system board.

NOTE: Ensure that the M.2 screw mount is in the proper location to install the M.2 2230 solid-state drive, refer to [Location of the screw mount on M.2 slot 0](#).

The following image indicates the location of the M.2 2230 solid-state drive in M.2 slot 0 and provides a visual representation of the installation procedure.

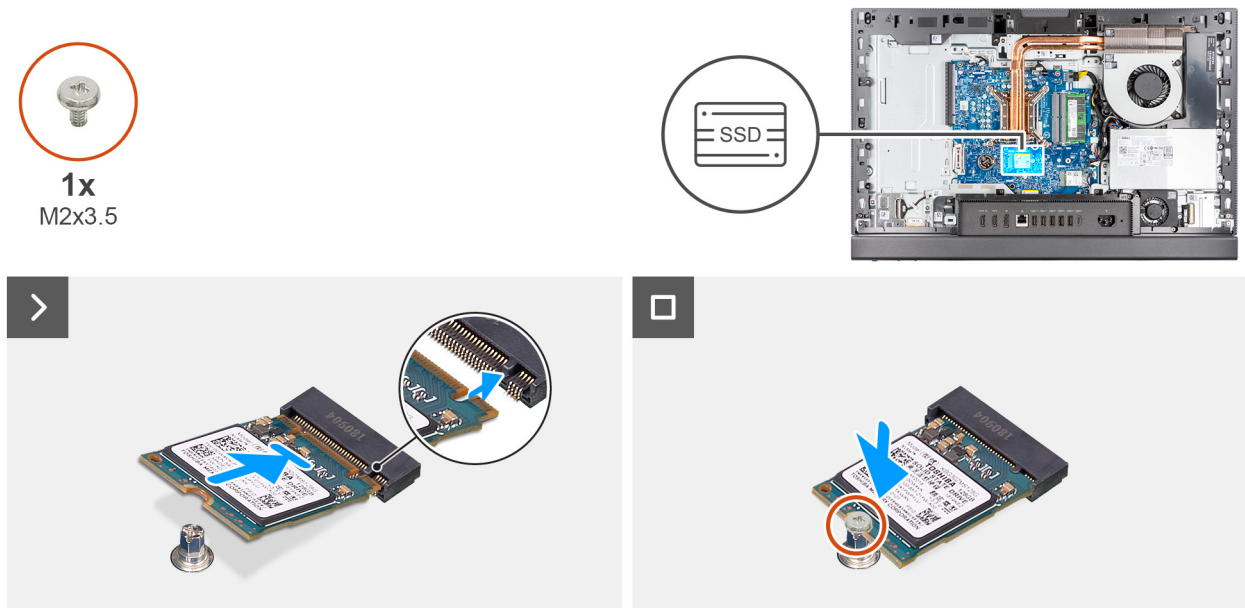

Figure 27. Installing the M.2 2230 solid-state drive in M.2 slot 0

Steps

1. Align the notch on the M.2 2230 solid-state drive with the tab on the solid-state drive slot (M.2 PCIe SSD 0).
2. Slide the M.2 2230 solid-state drive into the solid-state drive slot (M.2 PCIe SSD 0) on the system board.
3. Replace the screw (M2x3.5) that secures the M.2 2230 solid-state drive to the system board.

Next steps

1. Install the [system-board shield](#).
2. Install the [back cover](#).
3. Install the [stand](#).
4. Follow the procedure in [After working inside your computer](#).

Location of the screw mount on M.2 slot 0

Prerequisites

To install a M.2 solid-state drive of a different form factor in M.2 slot 0, the location of the screw mount on M.2 slot 0 must be changed.

About this task

NOTE: This procedure only applies to the screw mount located for M.2 slot 0.

The following image indicates the location of the screw mount for M.2 slot 0 and provides a visual representation of the procedure to change the position of the screw mount.

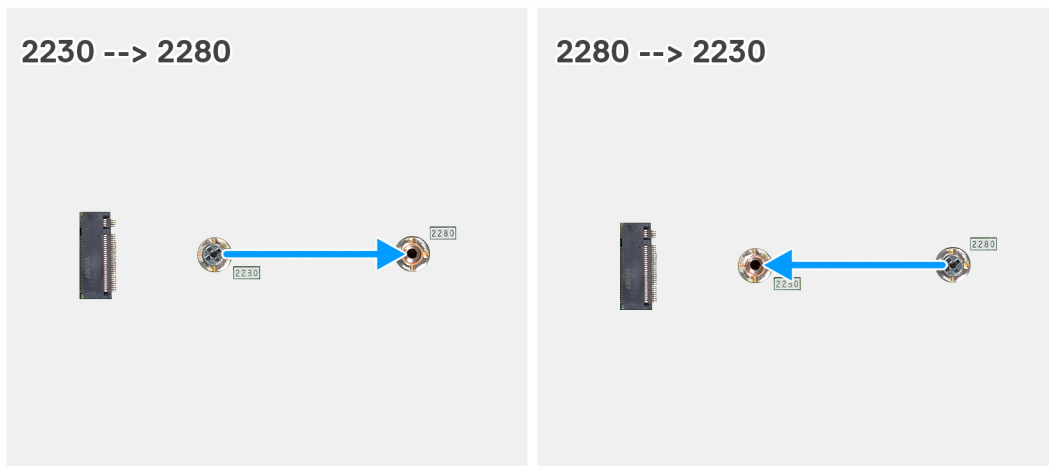

Figure 28. Moving the solid-state screw mount for M.2 slot 0

Steps

1. Remove the screw mount on the system board.
2. Install the screw mount on the system board.

Next steps

1. Install the [M.2 2230 solid-state drive](#) in slot 0.
2. Install the [system-board shield](#).
3. Install the [back cover](#).
4. Install the [stand](#).
5. Follow the procedure in [After working inside your computer](#).

Solid-state drive in M.2 slot 1

Removing the M.2 2230 solid-state drive in M.2 slot 1

Prerequisites

1. Follow the procedure in [Before working inside your computer](#).
2. Remove the [stand](#).
3. Remove the [back cover](#).
4. Remove the [system-board shield](#).
5. Remove the [I/O cover](#).

About this task

- NOTE:** Depending on the configuration ordered, your computer may have up to two M.2 2230 or 2280 solid-state drives installed in the solid-state drive slots on the system board.
- NOTE:** This procedure is applicable for computers where an M.2 2230 solid-state drive is installed in the solid-state drive slot (M.2 PCIe SSD 1) on the system board.

The following image indicates the location of the M.2 2230 solid-state drive in M.2 slot 1 and provides a visual representation of the removal procedure.

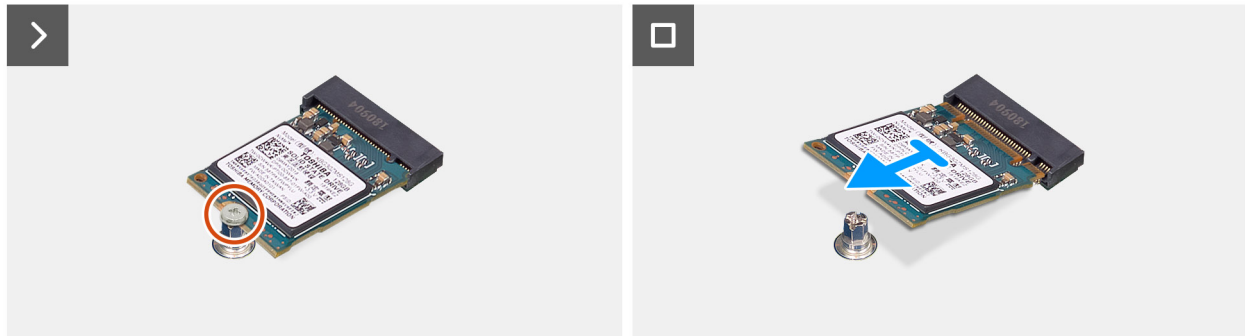
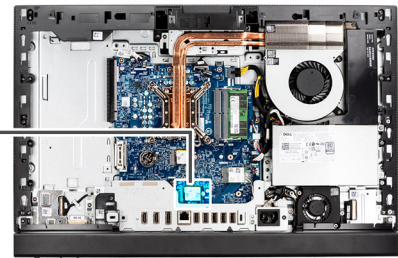

Figure 29. Removing the M.2 2230 solid-state drive in M.2 slot 1

Steps

1. Remove the screw (M2x3.5) that secures the M.2 2230 solid-state drive to the system board.
2. Slide and lift the M.2 2230 solid-state drive from the solid-state drive slot (M.2 PCIe SSD 1) on the system board.

Installing the M.2 2230 solid-state drive in M.2 slot 1

Prerequisites

If you are replacing a component, remove the existing component before performing the installation process.

About this task

- NOTE:** This procedure is only applicable if you are installing an M.2 2230 solid-state drive into the solid-state drive slot (M.2 PCIe SSD 1) on the system board.
- NOTE:** Ensure that the M.2 screw mount is in the proper location to install the M.2 2230 solid-state drive, refer to [Location of the screw mount on M.2 slot 1](#).

The following image indicates the location of the M.2 2230 solid-state drive in M.2 slot 1 and provides a visual representation of the installation procedure.

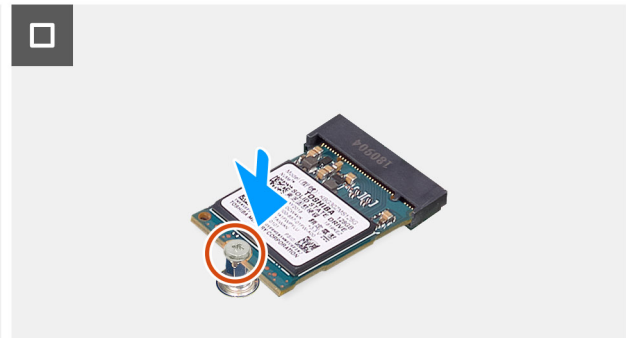
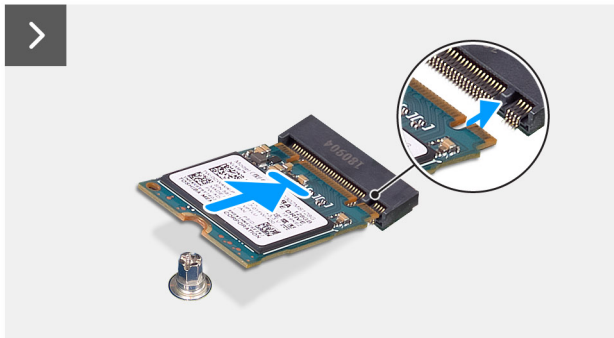
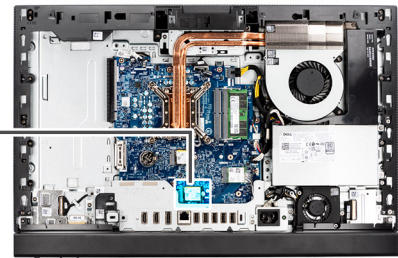

Figure 30. Installing the M.2 2230 solid-state drive in M.2 slot 1

Steps

1. Align the notch on the M.2 2230 solid-state drive with the tab on the solid-state drive slot (M.2 PCIe SSD 1).
2. Slide the M.2 2230 solid-state drive into the solid-state drive slot (M.2 PCIe SSD 1) on the system board.
3. Replace the screw (M2x3.5) that secures the M.2 2230 solid-state drive to the system board.

Next steps

1. Install the [I/O cover](#).
2. Install the [system-board shield](#).
3. Install the [back cover](#).
4. Install the [stand](#).
5. Follow the procedure in [After working inside your computer](#).

Location of the screw mount on M.2 slot 1

Prerequisites

To install an M.2 solid-state drive of a different form factor on M.2 slot 1, the location of the screw mount on M.2 slot 1 has to be changed in order to install the M.2 solid-state drive of a different form factor.

About this task

NOTE: This procedure only applies to the screw mount located on M.2 slot 1.

The following image indicates the location of the screw mount on M.2 slot 1 and provides a visual representation of the procedure to change the position of the screw mount.

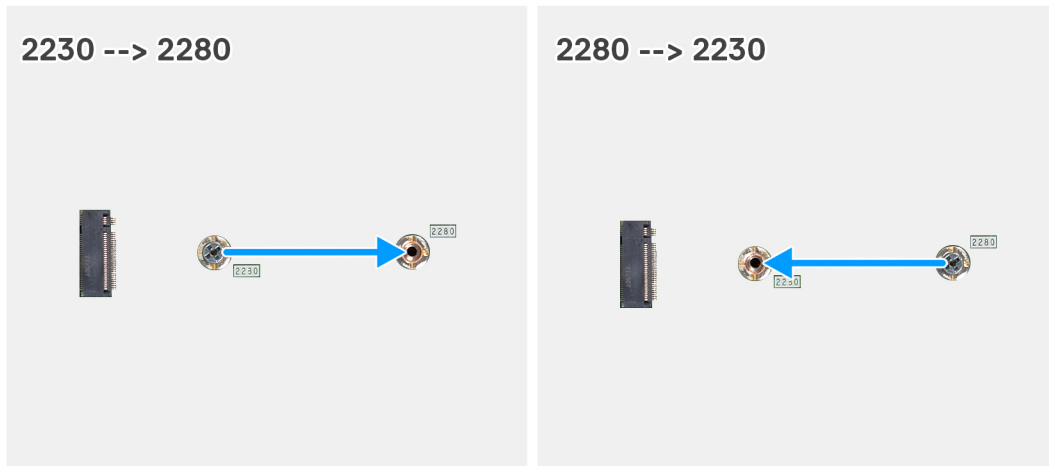

Figure 31. Moving the solid-state screw mount on M.2 slot 1

Steps

1. Remove the screw mount on the system board.
2. Install the screw mount on the system board.

Next steps

1. Install the [M.2 2230](#) solid-state drive in slot 1.
2. Install the [I/O cover](#).
3. Install the [system-board shield](#).
4. Install the [back cover](#).
5. Install the [stand](#).
6. Follow the procedure in [After working inside your computer](#).

Coin-cell battery

Removing the coin-cell battery

Prerequisites

1. Follow the procedure in [Before working inside your computer](#).
2. Remove the [stand](#).
3. Remove the [back cover](#).
4. Remove the [system-board shield](#).

About this task

The following image indicates the location of the coin-cell battery and provides a visual representation of the removal procedure.

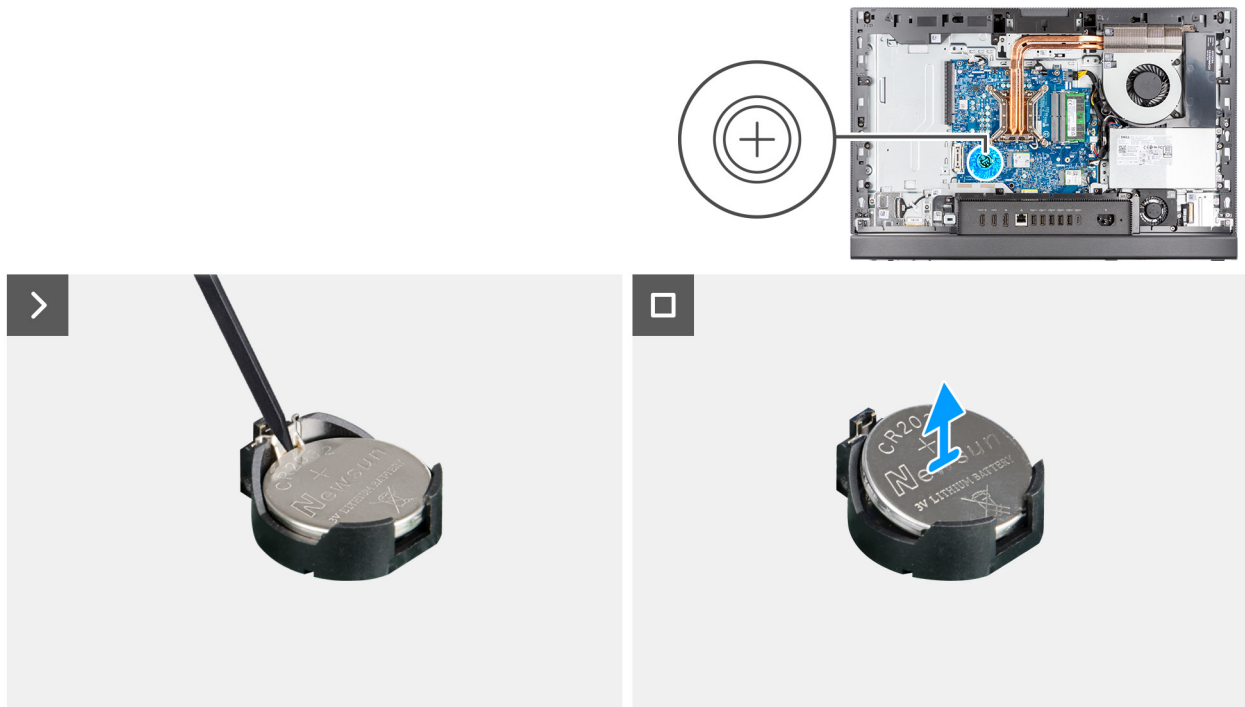

Figure 32. Removing the coin-cell battery

Steps

1. Using a plastic scribe, push the release lever on the coin-cell battery socket (RTC) to release the coin-cell battery out of the socket.
2. Lift the coin-cell battery from the coin-cell battery socket.

Installing the coin-cell battery

Prerequisites

If you are replacing a component, remove the existing component before performing the installation process.

About this task

The following image indicates the location of the coin-cell battery and provides a visual representation of the installation procedure.

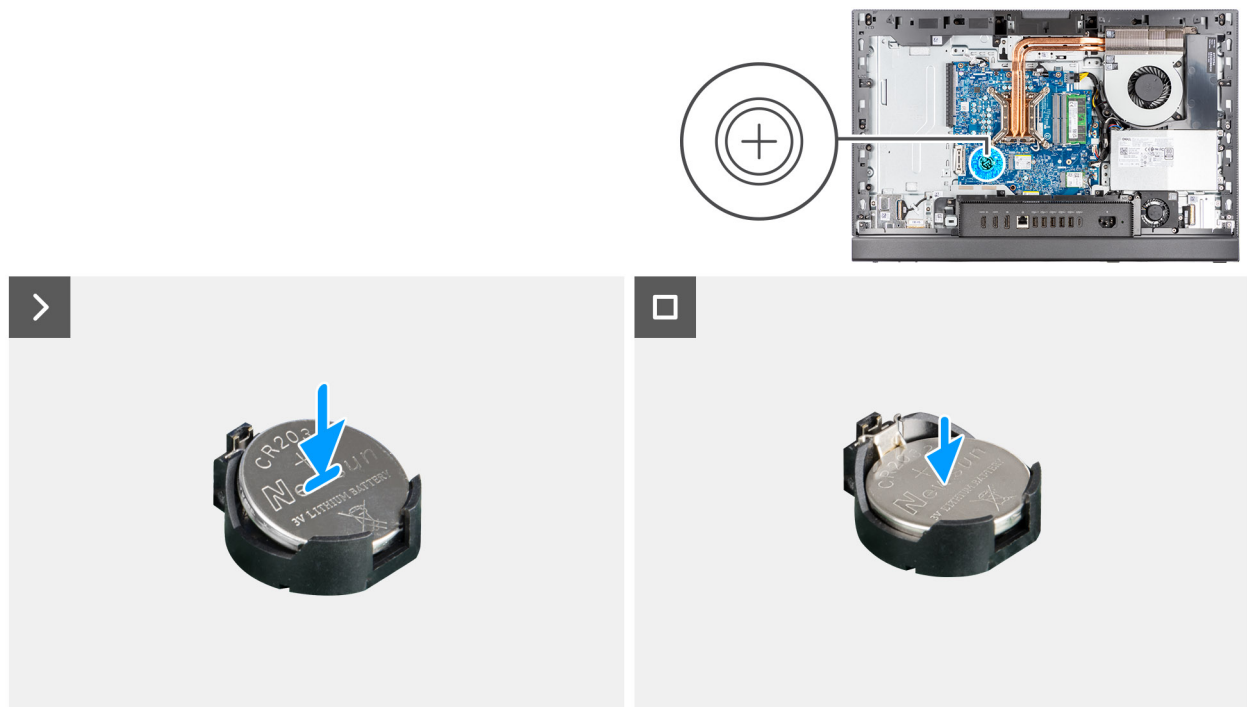

Figure 33. Installing the coin-cell battery

Steps

With the positive side (+) facing up, insert the coin-cell battery into the battery socket (RTC) on the system board and snap the battery into place.

Next steps

1. Install the [system-board shield](#).
2. Install the [back cover](#).
3. Install the [stand](#).
4. Follow the procedure in [After working inside your computer](#).

I/O cover

Removing the I/O cover

Prerequisites

1. Follow the procedure in [Before working inside your computer](#).
2. Remove the [stand](#).
3. Remove the [back cover](#).
4. Remove the [system-board shield](#).

About this task

The following image indicates the location of the I/O cover and provides a visual representation of the removal procedure.



2x
M3x5

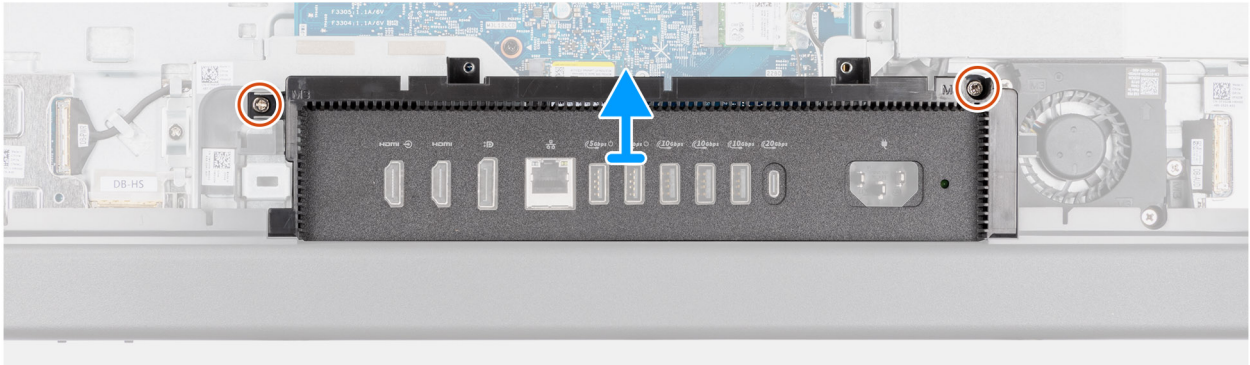
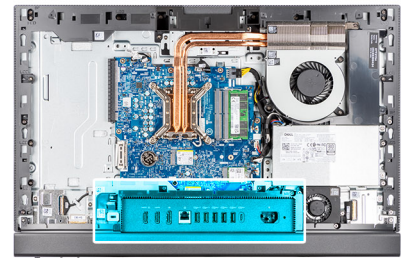

Figure 34. Removing the I/O cover

Steps

1. Remove the two screws (M3x5) that secure the I/O cover to the display-assembly base.
2. Lift the I/O cover off the display-assembly base.

Installing the I/O cover

Prerequisites

If you are replacing a component, remove the existing component before performing the installation process.

About this task

The following image indicates the location of the I/O cover and provides a visual representation of the installation procedure.



2x
M3x5

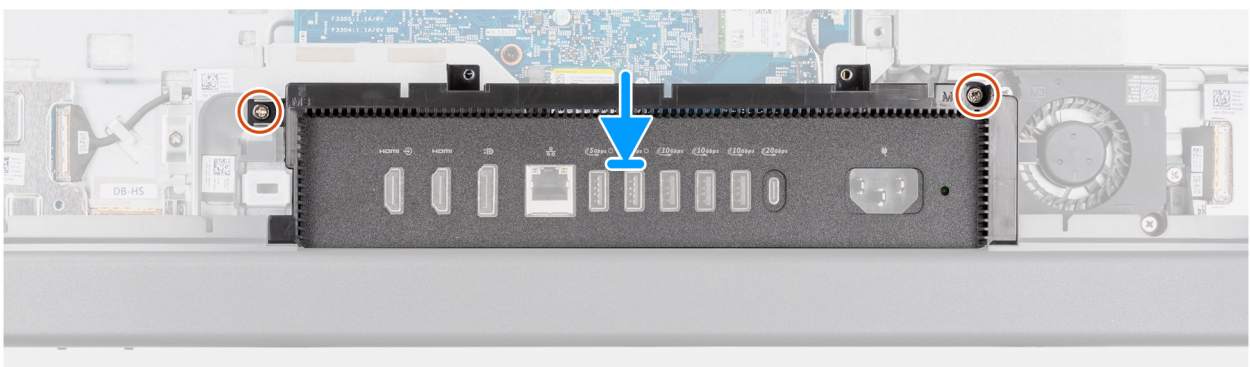
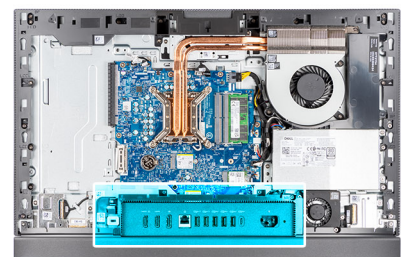

Figure 35. Installing the I/O cover

Steps

1. Place the I/O cover on the display-assembly base.
2. Align the I/O slots with the I/O ports and the screw holes on the I/O cover with the screw holes on the display-assembly base.
3. Replace the two screws (M3x5) that secure the I/O cover to the display-assembly base.

Next steps

1. Install the [system-board shield](#).
2. Install the [back cover](#).
3. Install the [stand](#).
4. Follow the procedure in [After working inside your computer](#).

Bottom cover

Removing the bottom cover

Prerequisites

1. Follow the procedure in [Before working inside your computer](#).
2. Remove the [stand](#).
3. Remove the [back cover](#).
4. Remove the [system-board shield](#).
5. Remove the [I/O cover](#).

About this task

The following image indicates the location of the bottom cover and provides a visual representation of the removal procedure.



3x
M3x5

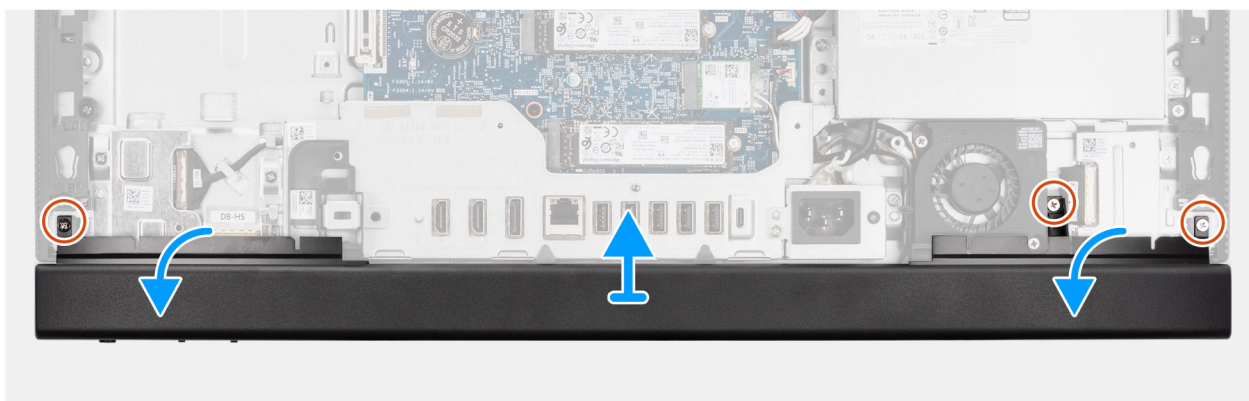
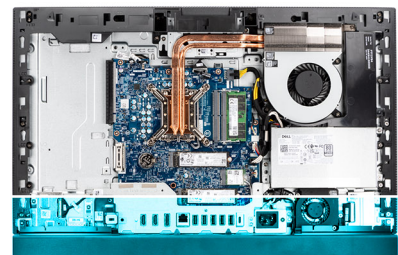

Figure 36. Removing the bottom cover

Steps

1. Remove the three screws (M3x5) that secure the bottom cover to the display-assembly base.
2. Release the tabs in the bottom cover from the slots on the display-assembly base.
3. Lift the bottom cover off the display-assembly base.

Installing the bottom cover

Prerequisites

If you are replacing a component, remove the existing component before performing the installation process.

About this task

The following image indicates the location of the bottom cover and provides a visual representation of the installation procedure.



3x
M3x5

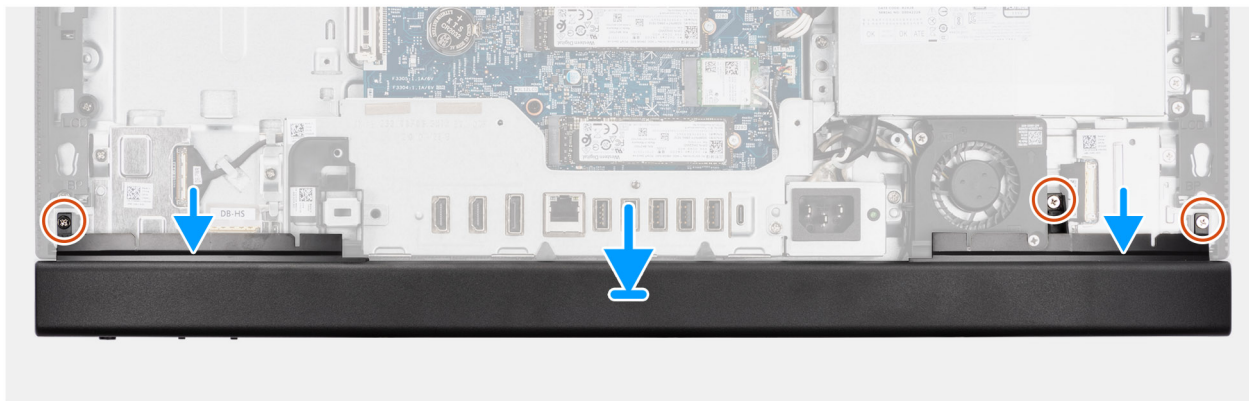
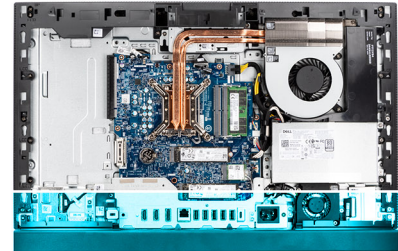

Figure 37. Installing the bottom cover

Steps

1. Align the tabs in the bottom cover with the slots on the display-assembly base.
2. Place the bottom cover in its slot on the display-assembly base.
3. Align and replace the three screws (M3x5) to secure the bottom cover to the display-assembly base.

Next steps

1. Install the [I/O cover](#).
2. Install the [system-board shield](#).
3. Install the [back cover](#).
4. Install the [stand](#).
5. Follow the procedure in [After working inside your computer](#).

Retractable-camera assembly

Removing the retractable-camera assembly

Prerequisites

1. Follow the procedure in [Before working inside your computer](#).
2. Remove the [stand](#).
3. Remove the [back cover](#).

4. Remove the [system-board shield](#).

About this task

NOTE: The retractable-camera assembly consists of the following components:

- Camera
- Microphones

The following image indicates the location of the retractable-camera assembly and provides a visual representation of the removal procedure.

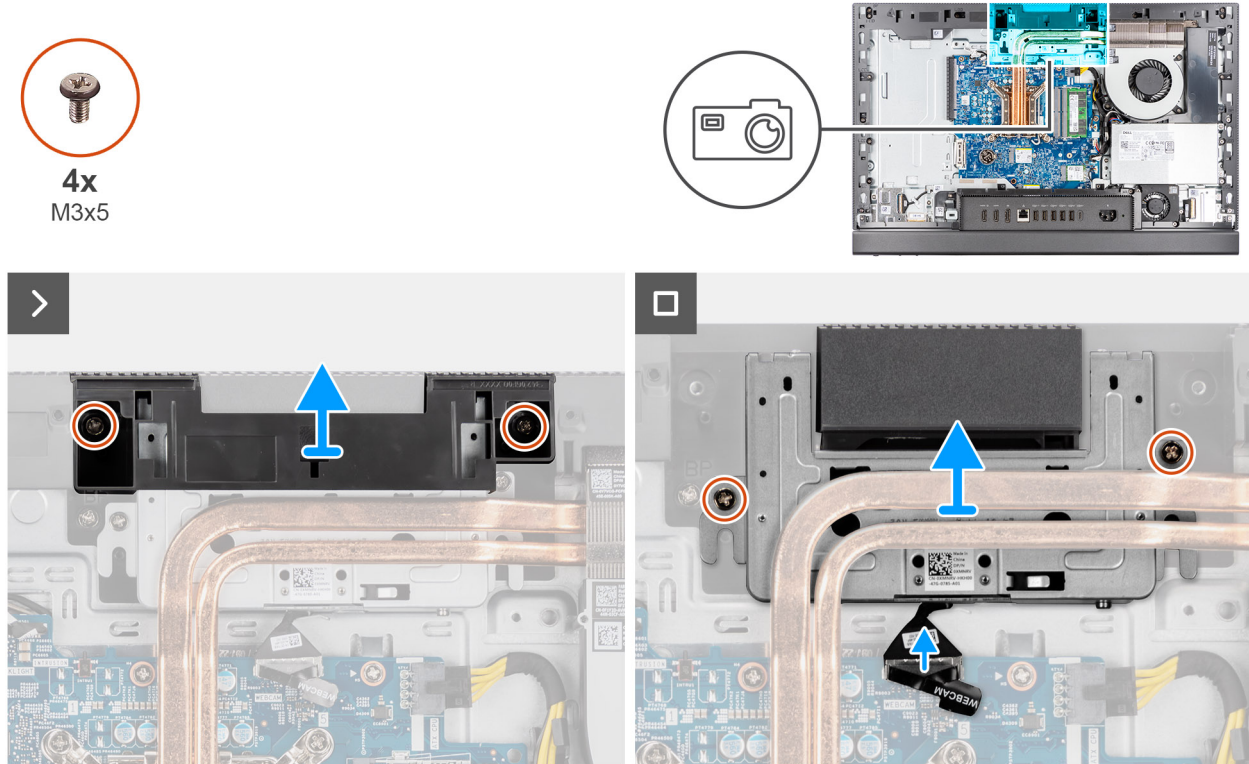

Figure 38. Removing the retractable-camera assembly

Steps

1. Remove the two screws (M3x5) that secure the camera-assembly bracket to the display-assembly base.
2. Lift the camera-assembly bracket off the display-assembly base.
3. Using the pull tab, disconnect the camera cable from its connector (WEBCAM) on the system board.
4. Remove the two screws (M3x5) that secure the retractable-camera assembly to the display-assembly base.

NOTE: The non-touch configuration has a plastic mid-frame on one of the screw mounts of the camera assembly.

5. Slide the retractable-camera assembly from its slot and under the heat sink and remove the retractable-camera assembly from the display-assembly base.

Installing the retractable-camera assembly

Prerequisites

If you are replacing a component, remove the existing component before performing the installation process.

About this task

The following image indicates the location of the retractable-camera assembly and provides a visual representation of the installation procedure.



4x
M3x5

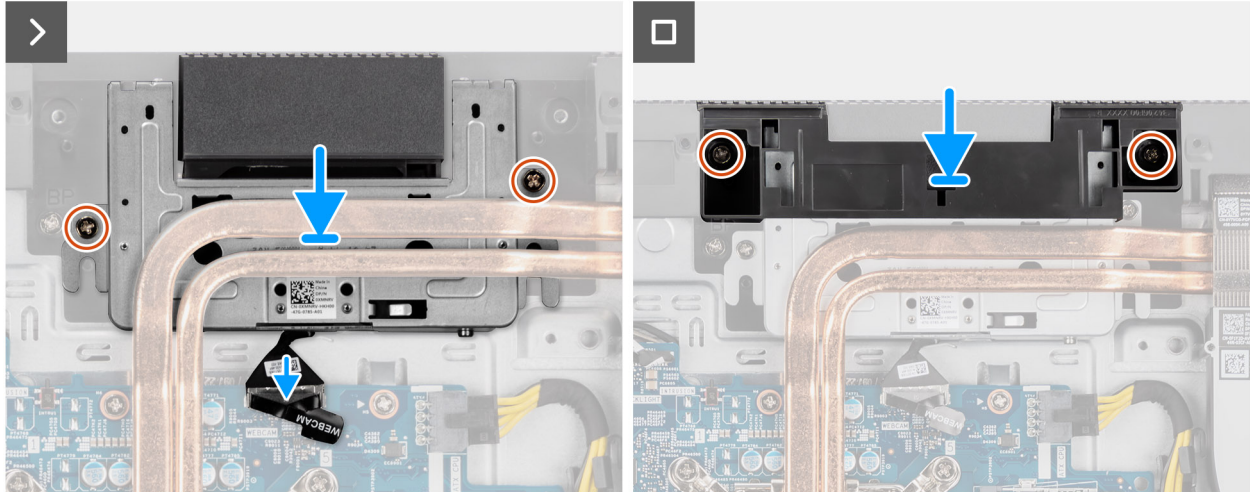
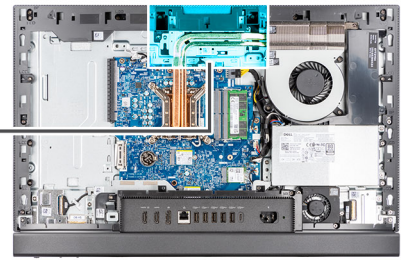
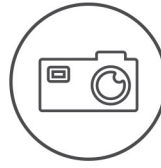

Figure 39. Installing the retractable-camera assembly

Steps

1. Slide the retractable-camera assembly under the heat sink into its slot on the display-assembly base.
2. Align the screw holes on the retractable-camera assembly with the screw holes on the display-assembly base.
3. Replace the two screws (M3x5) that secure the retractable-camera assembly to the display-assembly base.
i **NOTE:** The non-touch configuration has a plastic mid-frame on one of the screw mounts of the camera assembly.
4. Connect the camera cable to its connector (WEBCAM) on the system board.
5. Place the camera-assembly bracket over retractable-camera assembly.
6. Align the screw holes on the camera-assembly bracket with the screw holes on the display-assembly base.
7. Replace the two screws (M3x5) that secure the camera-assembly bracket to the display-assembly base.

Next steps

1. Install the [system-board shield](#).
2. Install the [back cover](#).
3. Install the [stand](#).
4. Follow the procedure in [After working inside your computer](#).

Fan

Removing the fan

Prerequisites

1. Follow the procedure in [Before working inside your computer](#).
2. Remove the [stand](#).
3. Remove the [back cover](#).
4. Remove the [system-board shield](#).

About this task

The following image indicates the location of the fan and provides a visual representation of the removal procedure.

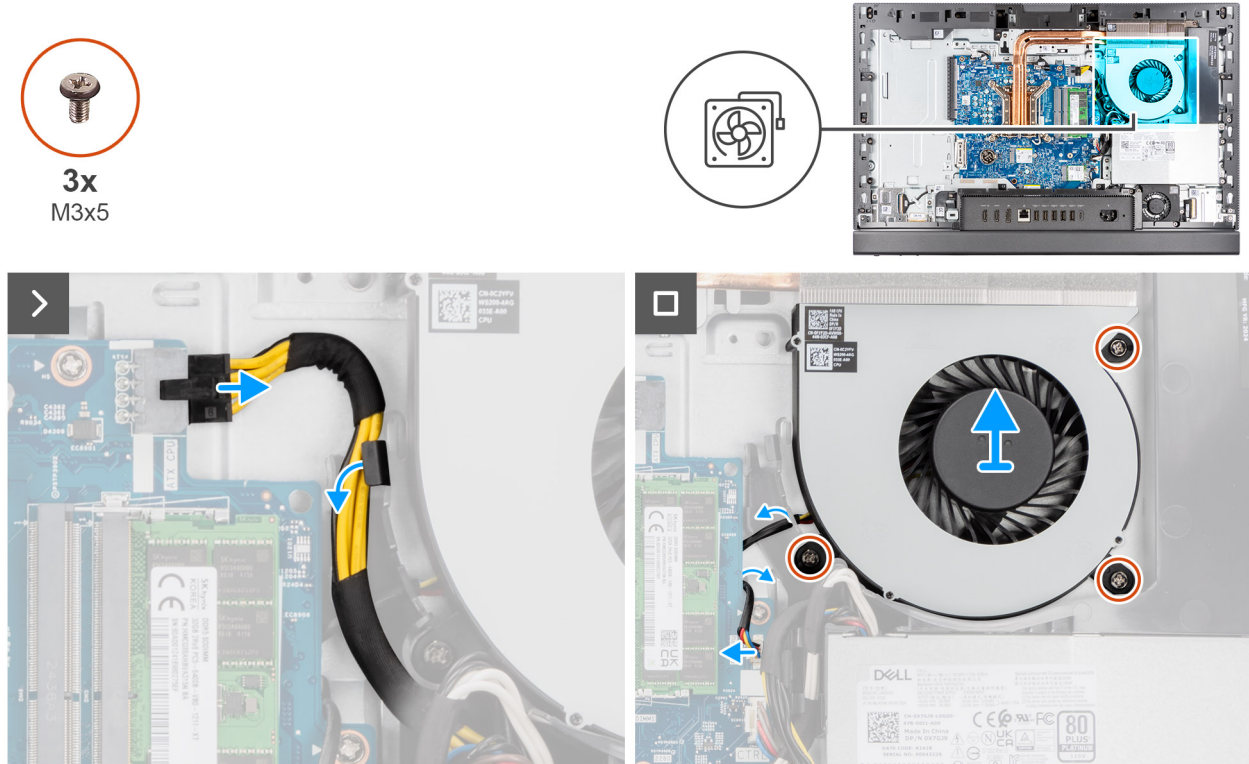

Figure 40. Removing the fan

Steps

1. Press and hold the securing clip and disconnect the processor-power cable from its connector (ATX CPU) on the system board.
2. Unroute the processor-power cable from the routing guide on the display-assembly base.
3. Lift the processor-power cable from the system board to access the fan cable.
4. Disconnect the fan cable from its connector (CPU FAN) on the system board.
5. Remove the three screws (M3x5) that secure the fan to the display-assembly base.
6. Lift the fan off the display-assembly base.

Installing the fan

Prerequisites

If you are replacing a component, remove the existing component before performing the installation process.

About this task

The following image indicates the location of the fan and provides a visual representation of the installation procedure.



3x
M3x5

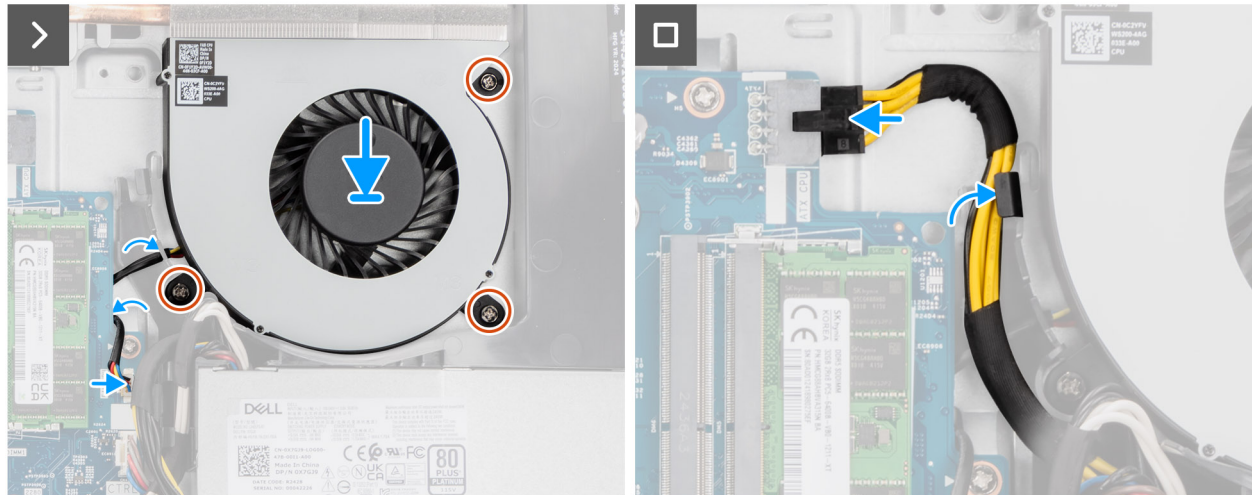
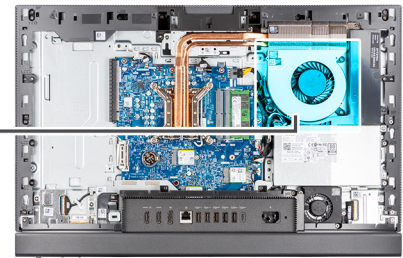
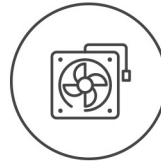

Figure 41. Installing the fan

Steps

1. Place the fan on the display-assembly base.
2. Align the screw holes on the fan with the screw holes on the display-assembly base.
3. Replace the three screws (M3x5) that secure the fan to the display-assembly base.
4. Connect the fan cable to its connector (CPU FAN) on the system board.
5. Route the processor-power cable through the routing guide on the display-assembly base.
6. Connect the processor-power cable to its connector (ATX CPU) on the system board.

Next steps

1. Install the [system-board shield](#).
2. Install the [back cover](#).
3. Install the [stand](#).
4. Follow the procedure in [After working inside your computer](#).

Power-supply unit

Removing the power-supply unit

Prerequisites

1. Follow the procedure in [Before working inside your computer](#).
2. Remove the [stand](#).
3. Remove the [back cover](#).
4. Remove the [system-board shield](#).
5. Remove the [I/O cover](#).

About this task

The following image indicates the location of the power-supply unit and provides a visual representation of the removal procedure.

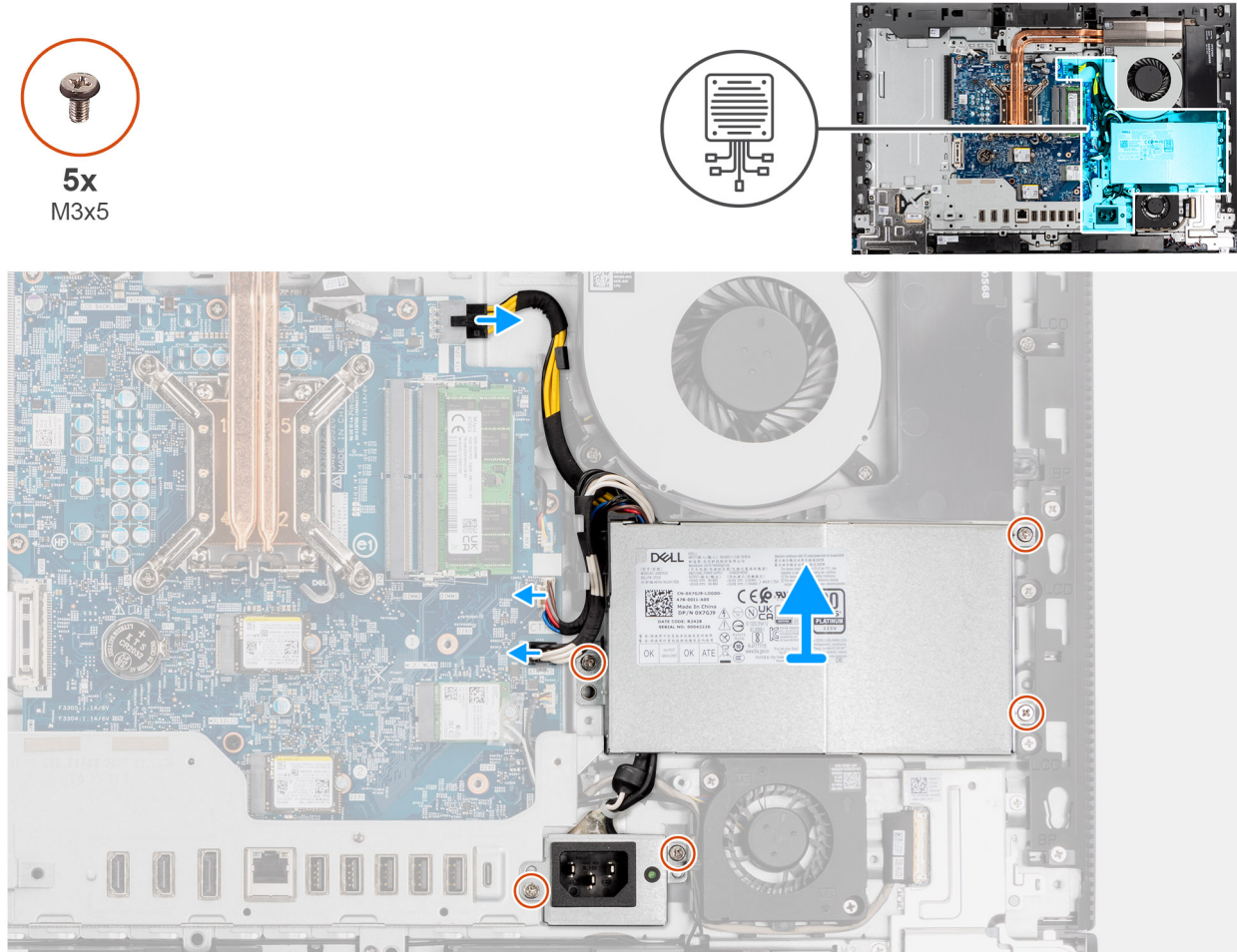

Figure 42. Removing the power-supply unit

Steps

1. Press and hold the securing clip and disconnect the processor-power cable from its connector (ATX CPU) on the system board.
2. Disconnect the control-signal cable from its connector (CTRL) on the system board.
3. Disconnect the system-board power cable from its connector (ATX SYS) on the system board.
4. Remove the three screws (M3x5) that secure the power-supply unit to the display-assembly base.
5. Remove the two screws (M3x5) that secure the power-supply unit connector to the display-assembly base.
6. Lift the power-supply unit, its cables, and the power-supply unit connector off the display-assembly base.

Installing the power-supply unit

Prerequisites

If you are replacing a component, remove the existing component before performing the installation process.

About this task

The following image indicates the location of the power-supply unit and provides a visual representation of the installation procedure.



5x
M3x5

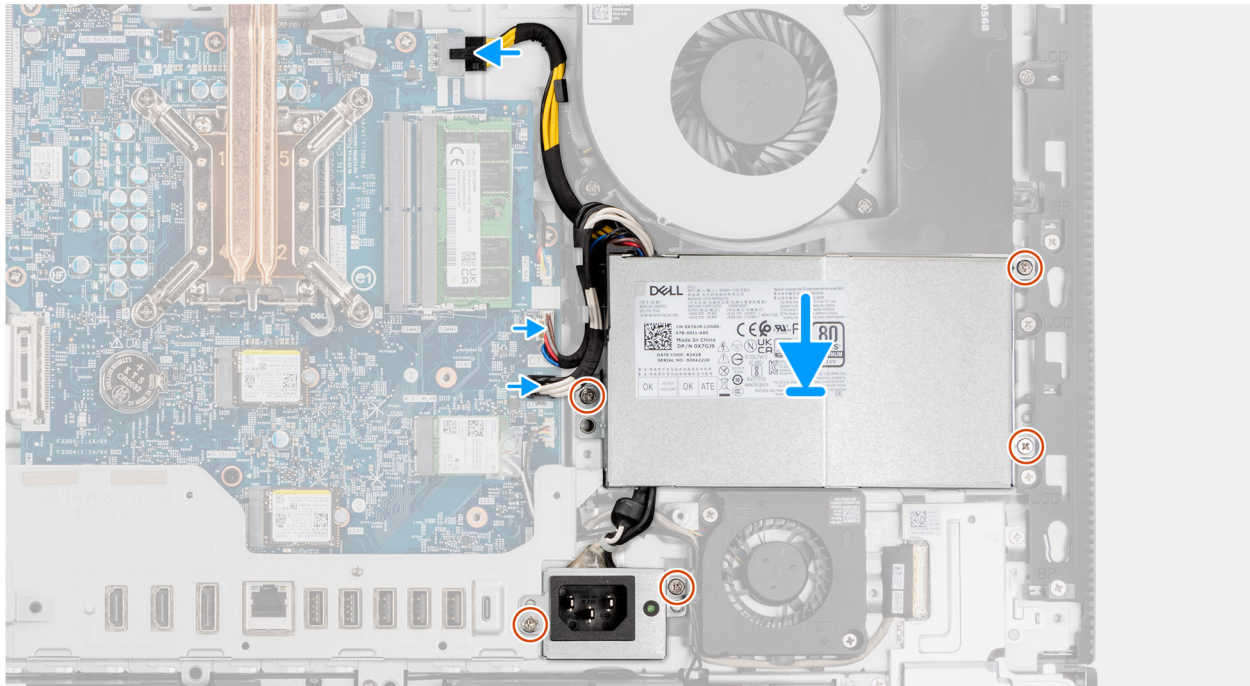
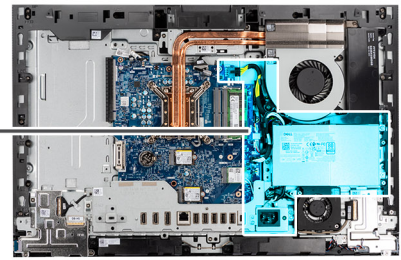
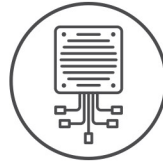

Figure 43. Installing the power-supply unit

Steps

1. Place the power-supply unit and the power-supply unit connector on the display-assembly base.
2. Align the screw holes on the power-supply unit with the screw holes on the display-assembly base.
3. Replace the three screws (M3x5) to secure the power-supply unit to the display-assembly base.
4. Align the screw holes on the power-supply connector with the screw holes on the display-assembly base.
5. Replace the two screws (M3x5) to secure the power-supply connector to the display-assembly base.
6. Connect the processor-power cable to its connector (ATX CPU) on the system board.
7. Connect the control-signal cable to its connector (CTRL) on the system board.
8. Connect the system-board power cable to its connector (ATX SYS) on the system board.

Next steps

1. Install the [I/O cover](#).
2. Install the [system-board shield](#).
3. Install the [back cover](#).
4. Install the [stand](#).
5. Follow the procedure in [After working inside your computer](#).

Removing and installing Field Replaceable Units (FRUs)

The replaceable components in this chapter are Field Replaceable Units (FRUs).

CAUTION: The information in this removing and installing FRUs section is intended for authorized service technicians only.

CAUTION: To avoid any potential damage to the component or loss of data, Dell Technologies recommends that an authorized service technician replaces the Field Replaceable Units (FRUs).

CAUTION: Your warranty does not cover damages that may occur during FRU repairs that are not authorized by Dell Technologies.

NOTE: The images in this document may differ from your computer depending on the configuration you ordered.

Power-supply fan

Removing the power-supply fan

Prerequisites

1. Follow the procedure in [Before working inside your computer](#).
2. Remove the [stand](#).
3. Remove the [back cover](#).
4. Remove the [system-board shield](#).
5. Remove the [I/O cover](#).
6. Remove the [power-supply unit](#).

About this task

The following images indicate the location of the power-supply fan and provide a visual representation of the removal procedure.



2x
M3x5

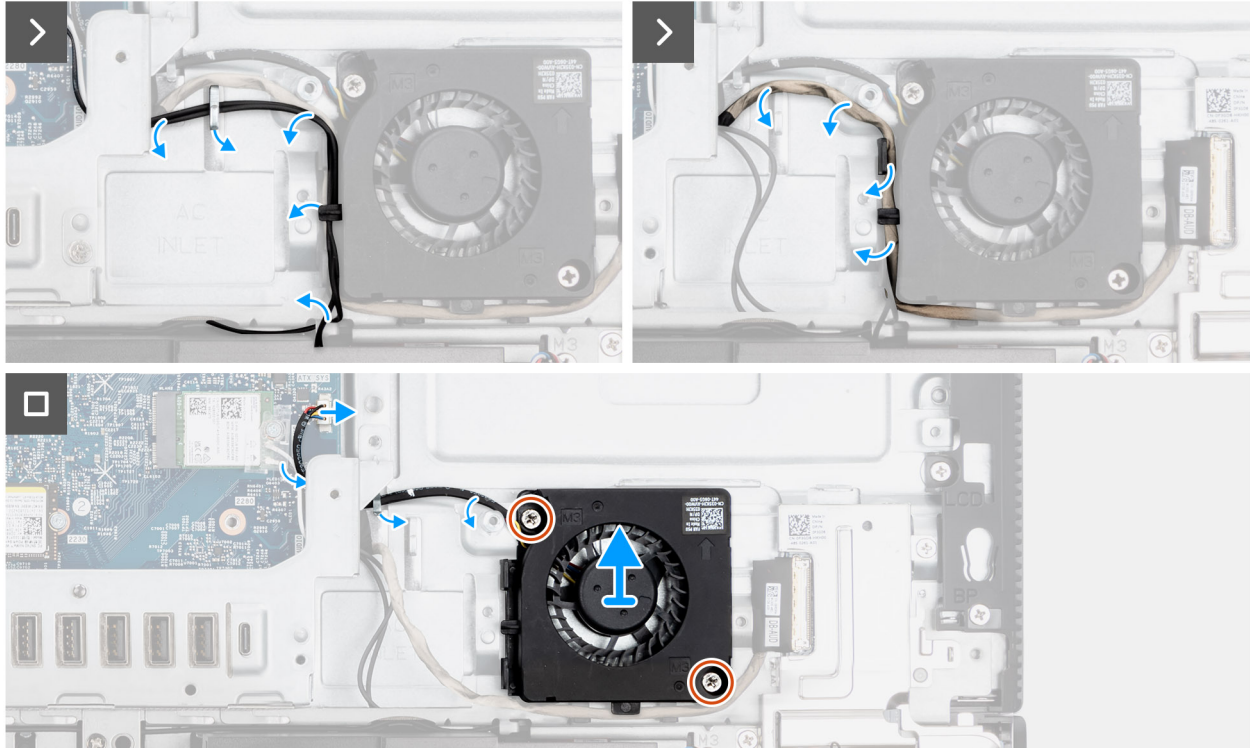
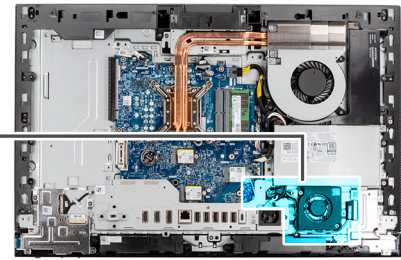
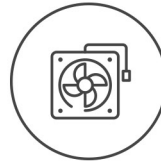

Figure 44. Removing the power-supply fan

Steps

1. Unroute the antenna cables from the routing guides on the display-assembly base and the power-supply fan.
2. Unroute the audio-board cable from the routing guides on the display-assembly base and the power-supply fan.
3. Disconnect the power-supply fan cable from its connector (FAN SYS) on the system board.
4. Unroute the power-supply fan cable from the routing guides on the display-assembly base.
5. Remove the two screws (M3x5) that secure the power-supply fan to the display-assembly base.
6. Lift the power-supply fan off the display-assembly base.

Installing the power-supply fan

Prerequisites

If you are replacing a component, remove the existing component before performing the installation process.

About this task

The following images indicate the location of the power-supply fan and provide a visual representation of the installation procedure.



2x
M3x5

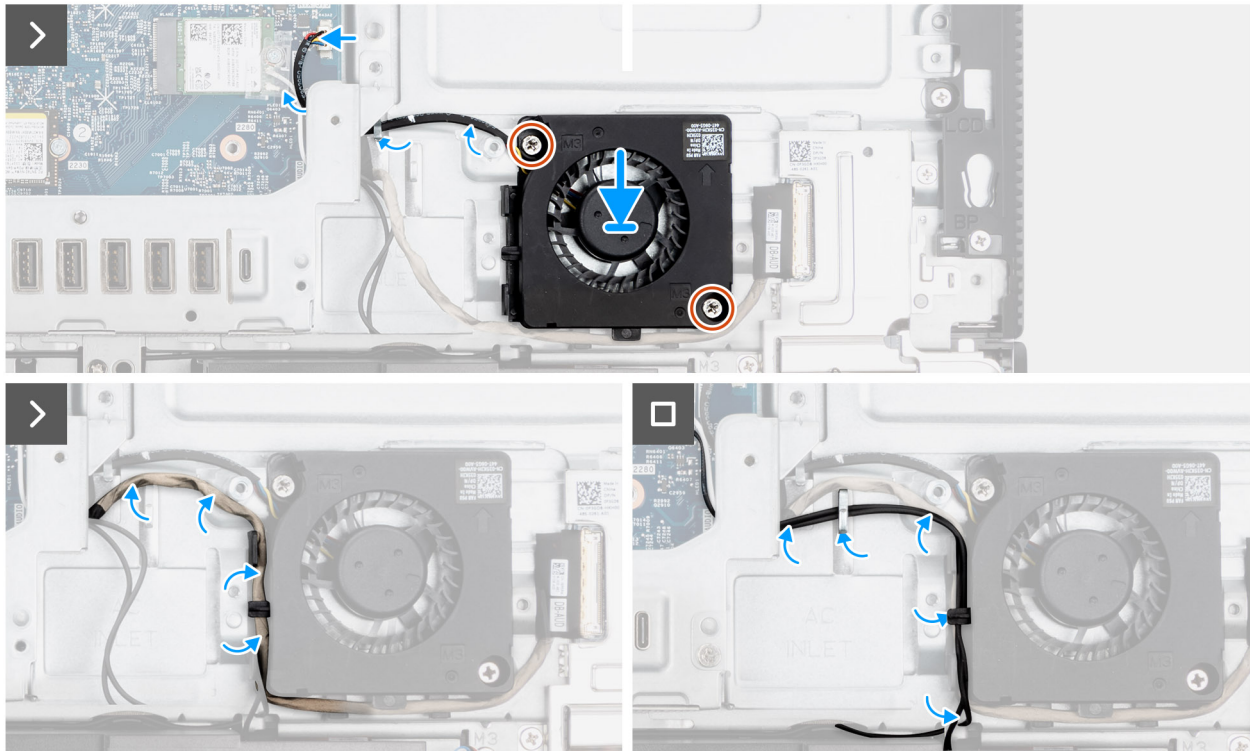
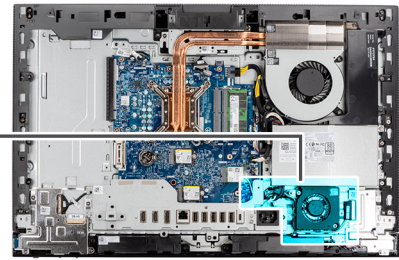
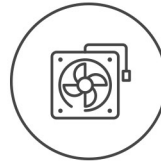

Figure 45. Installing the power-supply fan

Steps

1. Place the power-supply fan on the display-assembly base.
2. Align the screw holes on the power-supply fan with the screw holes on the display-assembly base.
3. Replace the two screws (M3x5) to secure the power-supply fan to the display-assembly base.
4. Connect the power-supply fan cable to its connector (FAN SYS) on the system board.
5. Route the power-supply fan cable through the routing guide on the display-assembly base.
6. Route the audio-board cable through the routing guides on the display-assembly base and the power-supply fan.
7. Route the antenna cables through the routing guides on the display-assembly base and the power-supply fan.

Next steps

1. Install the [power-supply unit](#).
2. Install the [I/O cover](#).
3. Install the [system-board shield](#).
4. Install the [back cover](#).
5. Install the [stand](#).
6. Follow the procedure in [After working inside your computer](#).

I/O bracket

Removing the I/O bracket

Prerequisites

1. Follow the procedure in [Before working inside your computer](#).
2. Remove the [stand](#).
3. Remove the [back cover](#).
4. Remove the [system-board shield](#).
5. Remove the [I/O cover](#).
6. Remove the [bottom cover](#).

About this task

The following image indicates the location of the I/O bracket and provides a visual representation of the removal procedure.

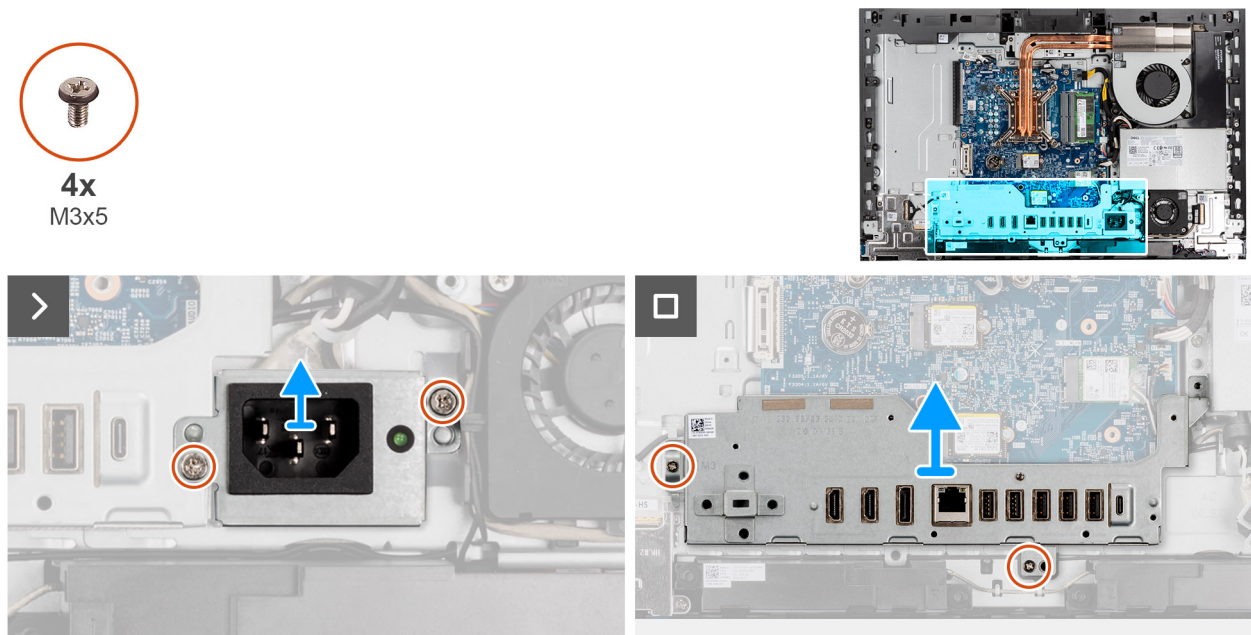

Figure 46. Removing the I/O bracket

Steps

1. Remove the two screws (M3x5) that secure the power-supply unit connector to the display-assembly base.
2. Lift the power-supply unit connector off the display-assembly base.
3. Remove the two screws (M3x5) that secure the I/O bracket to the display-assembly base.
4. Lift the I/O bracket off the display-assembly base.

Installing the I/O bracket

Prerequisites

If you are replacing a component, remove the existing component before performing the installation process.

About this task

The following image indicates the location of the I/O bracket and provides a visual representation of the installation procedure.



4x
M3x5

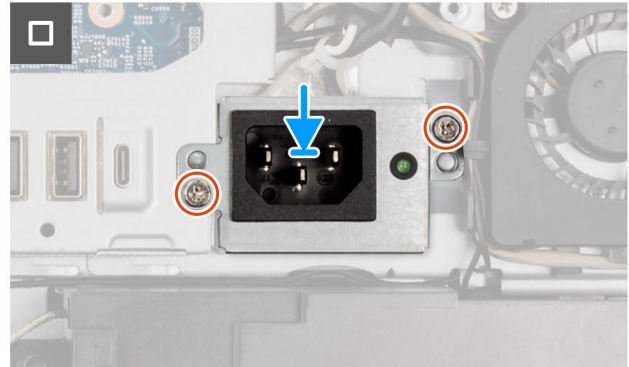
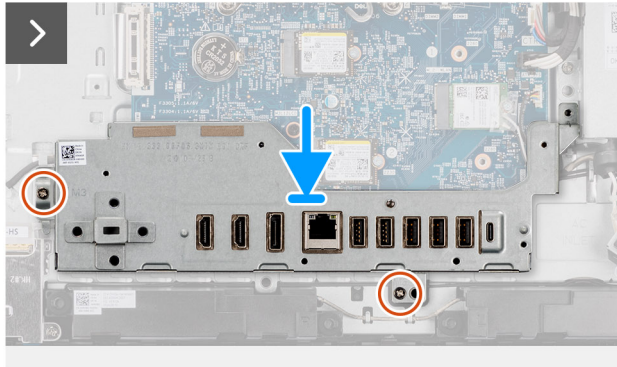
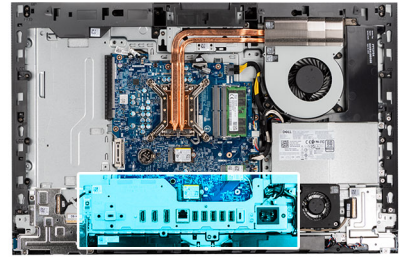

Figure 47. Installing the I/O bracket

Steps

1. Place and align the I/O bracket with the display-assembly base.
2. Align the I/O slots with the I/O ports and the screw holes on the I/O bracket with the screw holes on the display-assembly base.
3. Replace the two screws (M3x5) that secure the I/O bracket to the display-assembly base.
4. Place the power-supply unit connector on the display-assembly base.
5. Align the power-supply unit connector screw holes with the screw holes on the display-assembly base.
6. Replace the two screws (M3x5) that secure the power-supply cable connector bracket to the display-assembly base.

Next steps

1. Install the [bottom cover](#).
2. Install the [I/O cover](#).
3. Install the [system-board shield](#).
4. Install the [back cover](#).
5. Install the [stand](#).
6. Follow the procedure in [After working inside your computer](#).

Speakers

Removing the speakers

CAUTION: The information in this removal section is intended for authorized service technicians only.

Prerequisites

1. Follow the procedure in [Before working inside your computer](#).
2. Remove the [stand](#).
3. Remove the [back cover](#).
4. Remove the [system-board shield](#).
5. Remove the [I/O cover](#).
6. Remove the [bottom cover](#).

About this task

The following image indicates the location of the speakers and provides a visual representation of the removal procedure.

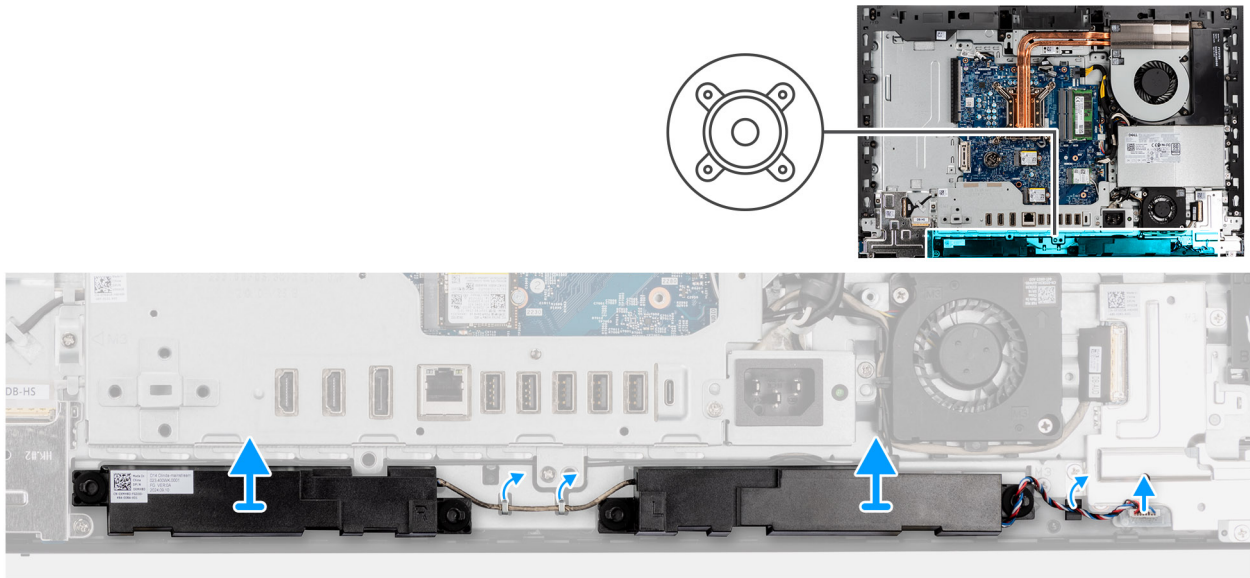

Figure 48. Removing the speakers

Steps

1. Disconnect the speaker cable from its connector (INT SPKR) on the audio board.
2. Remove the speaker cable from its routing guides on the display-assembly base.
3. Lift the speakers and its cable off the display-assembly base.

Installing the speakers

CAUTION: The information in this installation section is intended for authorized service technicians only.

Prerequisites

If you are replacing a component, remove the existing component before performing the installation process.

About this task

The following image indicates the location of the speakers and provides a visual representation of the installation procedure.

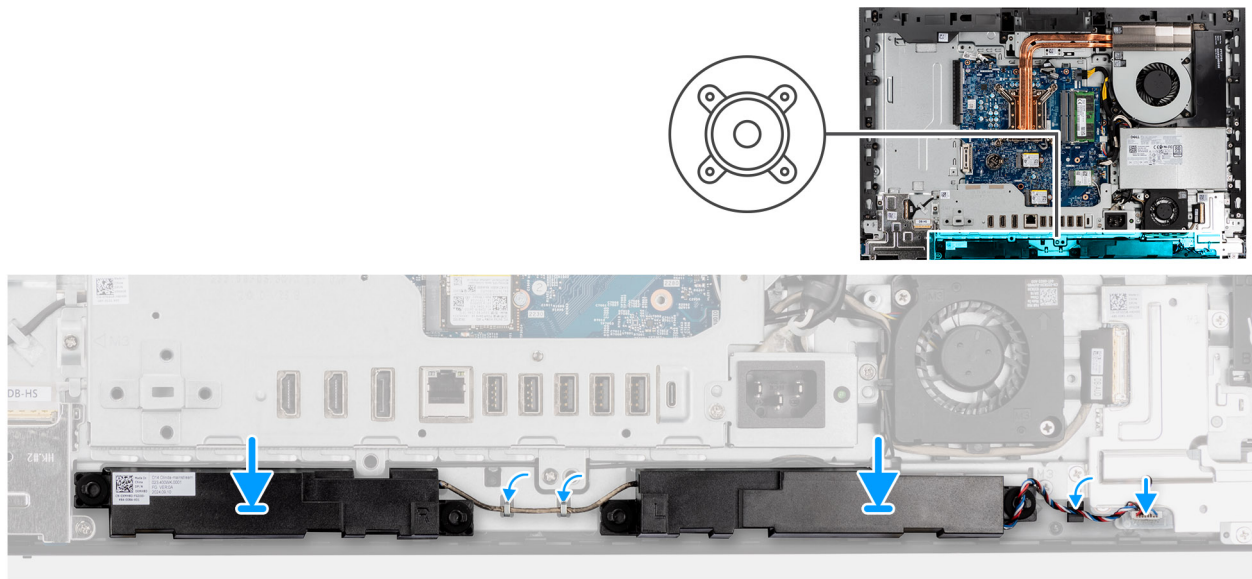

Figure 49. Installing the speakers

Steps

1. Insert the speakers into their slots on the display-assembly base.
2. Route the speaker cable through the routing guides on the display-assembly base.
3. Connect the speaker cable to its connector (INT SPKR) on the audio board.

Next steps

1. Install the [bottom cover](#).
2. Install the [I/O cover](#).
3. Install the [system-board shield](#).
4. Install the [back cover](#).
5. Install the [stand](#).
6. Follow the procedure in [After working inside your computer](#).

Heat sink

Removing the heat sink

⚠ CAUTION: The information in this removal section is intended for authorized service technicians only.

Prerequisites

1. Follow the procedure in [Before working inside your computer](#).
2. Remove the [stand](#).
3. Remove the [back cover](#).
4. Remove the [system-board shield](#).

About this task

- i NOTE:** The heat sink may become hot during normal operation. Allow sufficient time for the heat sink to cool before you touch it.
- i NOTE:** For maximum cooling of the processor, do not touch the heat transfer areas on the heat sink. The oils in your skin can reduce the heat transfer capability of the thermal grease.

The following image indicates the location of the heat sink and provides a visual representation of the removal procedure.



5x

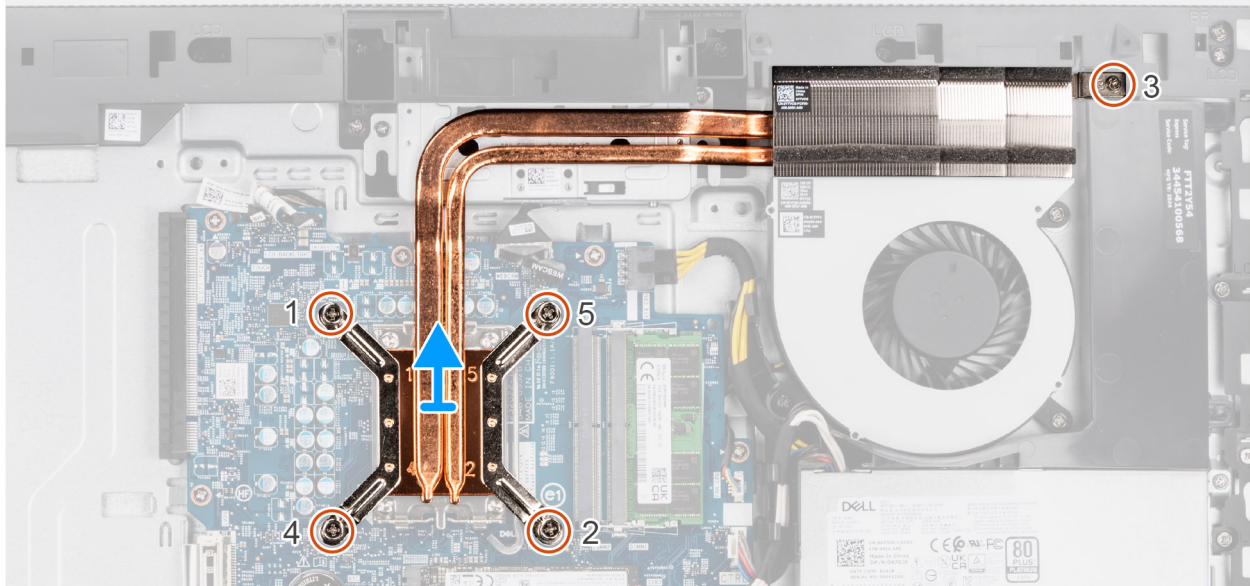
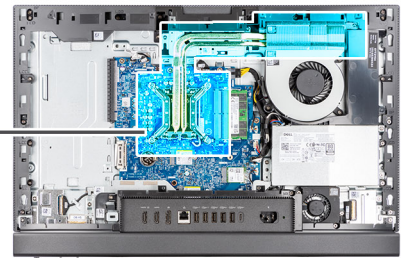

Figure 50. Removing the heat sink

Steps

1. In reverse sequential order (5>4>3>2>1) loosen the five captive screws that secure the heat sink to the system board and the display-assembly base.
2. Lift the heat sink off the display-assembly base.

Installing the heat sink

CAUTION: The information in this installation section is intended for authorized service technicians only.

Prerequisites

If you are replacing a component, remove the existing component before performing the installation process.

About this task

NOTE: If the processor and the heat sink are replaced, use the thermal grease provided in the kit to ensure optimal thermal conductivity.

The following image indicates the location of the heat sink and provides a visual representation of the installation procedure.



5x

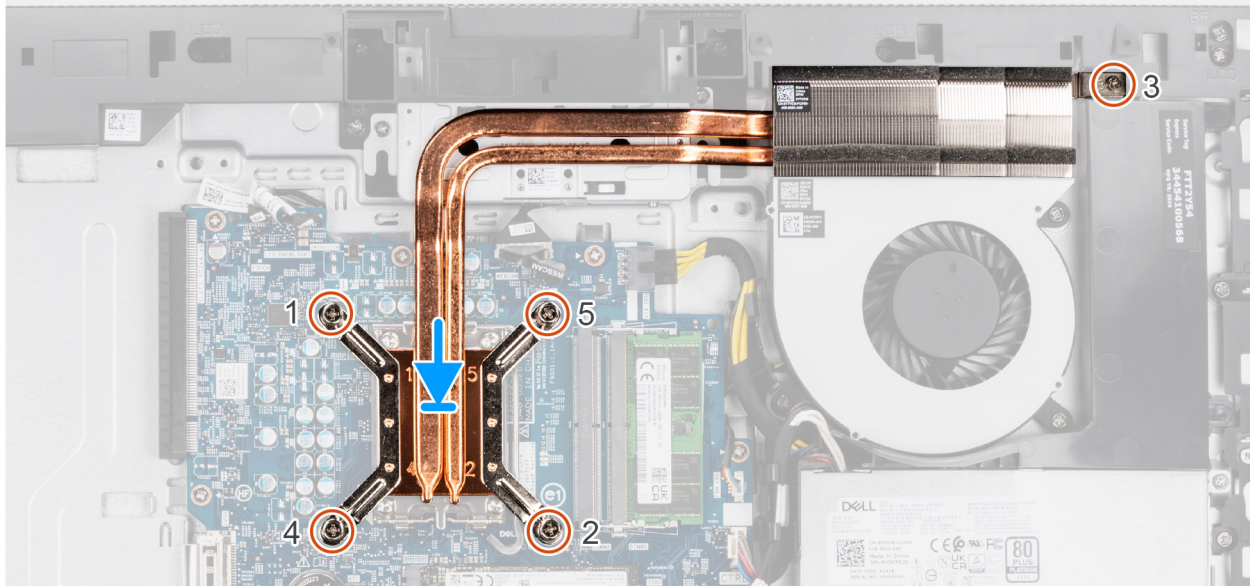
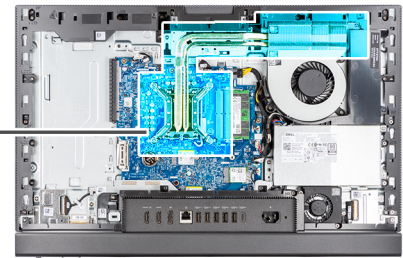

Figure 51. Installing the heat sink

Steps

1. Place the heat sink on the system board and the display-assembly base.
2. Align the screws on the heat sink with the screw holes on the system board and the display-assembly base.
3. In sequential order (1>2>3>4>5) tighten the five captive screws to secure the heat sink to the system board and the display-assembly base.

Next steps

1. Install the [system-board shield](#).
2. Install the [back cover](#).
3. Install the [stand](#).
4. Follow the procedure in [After working inside your computer](#).

Processor

Removing the processor

CAUTION: The information in this removal section is intended for authorized service technicians only.

Prerequisites

1. Follow the procedure in [Before working inside your computer](#).
2. Remove the [stand](#).
3. Remove the [back cover](#).
4. Remove the [system-board shield](#).
5. Remove the [heat sink](#).

About this task

- NOTE:** The processor may become hot during normal operation. Allow sufficient time for the processor to cool before you touch it.
- NOTE:** For maximum cooling of the processor, do not touch the heat transfer areas on the processor. The oils in your skin can reduce the heat transfer capability of the thermal grease.

The following image indicates the location of the processor and provides a visual representation of the removal procedure.

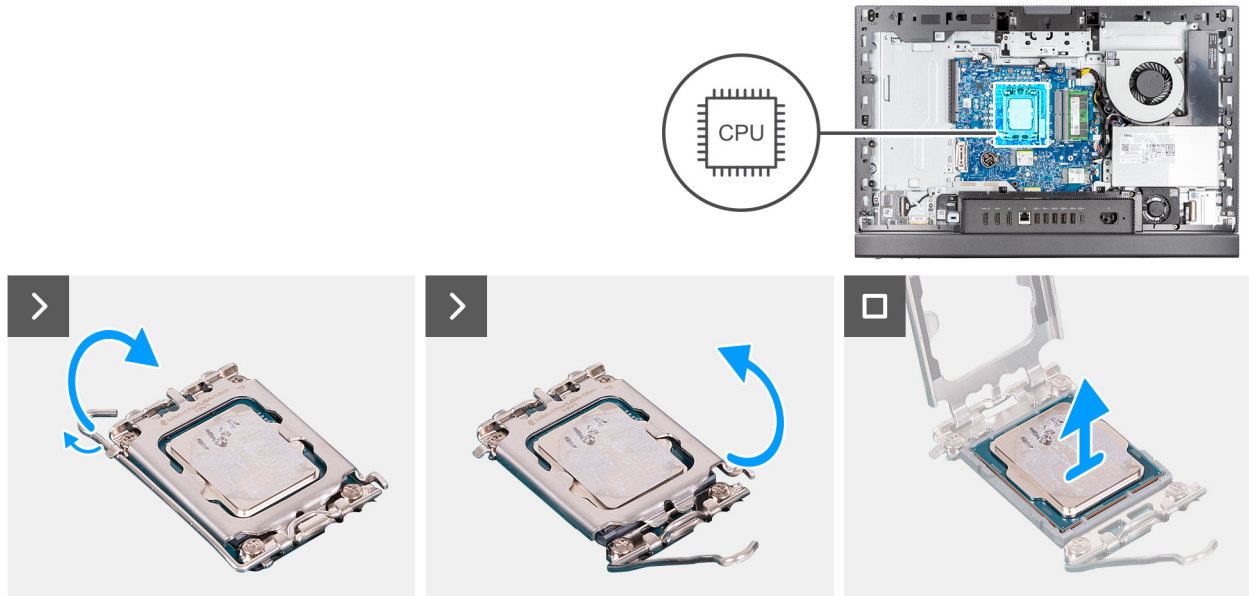

Figure 52. Removing the processor

Steps

1. Press the release lever down and then push it away from the processor to release it from the securing tab.
2. Extend the release lever completely and open the processor cover.

CAUTION: When removing the processor, do not touch any of the pins inside the socket or allow any objects to fall on the pins in the socket.

3. Gently lift the processor from the processor socket (CPU).

Installing the processor

CAUTION: The information in this installation section is intended for authorized service technicians only.

Prerequisites

If you are replacing a component, remove the existing component before performing the installation process.

About this task

- NOTE:** If either the processor or the heat sink are replaced, use the thermal grease provided in the kit to ensure optimal thermal conductivity.

The following image indicates the location of the processor and provides a visual representation of the installation procedure.

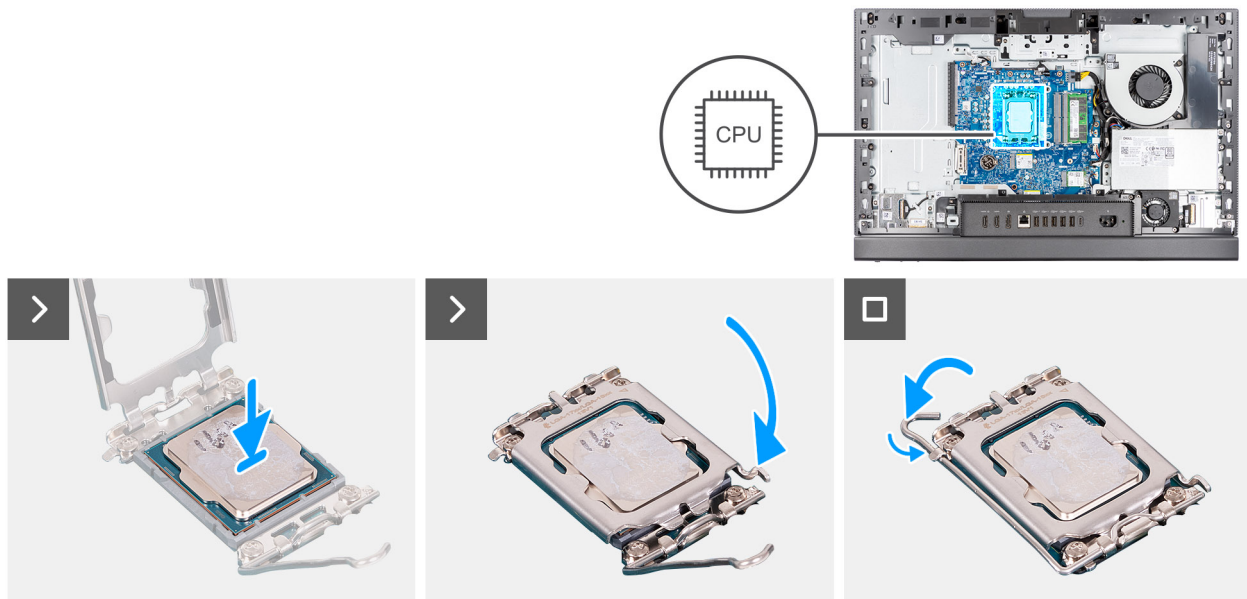

Figure 53. Installing the processor

Steps

1. Ensure that the release lever on the processor socket is fully extended in the open position.

i NOTE: The pin-1 corner of the processor has a triangle that aligns with the triangle on the pin-1 corner on the processor socket. When the processor is properly seated, all four corners are aligned at the same height. If one or more corners of the processor is higher than the others, the processor is not seated properly.

2. Align the notches on the processor with the tabs on the processor socket and place the processor in the processor socket (CPU).

⚠ CAUTION: Ensure that the processor-cover notch is positioned underneath the alignment post.

3. When the processor is fully seated in the socket, pivot the release-lever down and place it under the tab on the processor cover.

Next steps

1. Install the [heat sink](#).
2. Install the [system-board shield](#).
3. Install the [back cover](#).
4. Install the [stand](#).
5. Follow the procedure in [After working inside your computer](#).

System board

Removing the system board

⚠ CAUTION: The information in this removal section is intended for authorized service technicians only.

Prerequisites

1. Follow the procedure in [Before working inside your computer](#).
2. Remove the [stand](#).
3. Remove the [back cover](#).
4. Remove the [memory](#).
5. Remove the [system-board shield](#).

6. Remove the I/O cover.
7. Remove the bottom cover.
8. Remove the I/O bracket.
9. Remove the M.2 2230 solid-state drive in slot 0.
10. Remove the M.2 2230 solid-state drive in slot 1.
11. Remove the wireless card.
12. Remove the heat sink.
13. Remove the processor.

About this task

NOTE: Replacing the system board removes any changes that you have made to the BIOS using the BIOS setup program. Make the appropriate changes again after you replace the system board.

The following image indicates the connectors on your system-board.

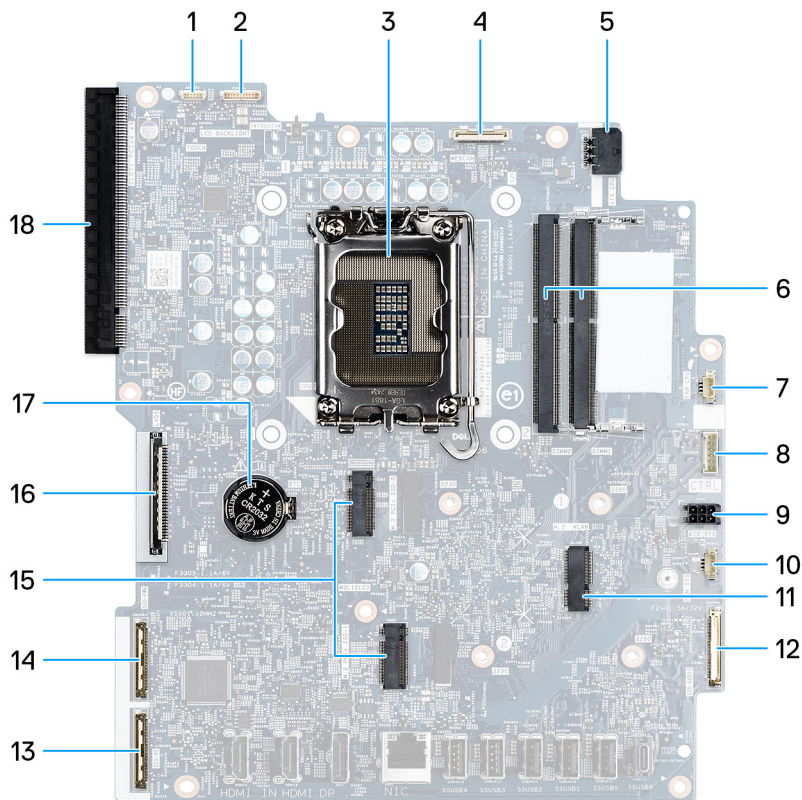

Figure 54. System board callouts

- | | |
|---|---|
| 1. Touchscreen cable (TOUCH) | 2. Display-backlight cable (LCD BACKLIGHT) |
| 3. Processor socket (CPU) | 4. Camera cable (WEBCAM) |
| 5. Processor-power cable (ATX CPU) | 6. Memory slots (DIMM1 + DIMM2) |
| 7. Fan cable (FAN CPU) | 8. Control-signal cable (CTRL) |
| 9. System-board power cable (ATX SYS) | 10. Power-supply fan cable (FAN SYS) |
| 11. Wireless-card slot (M.2 WLAN) | 12. Audio cable (MB-AUDIO) |
| 13. High-speed cable (MB-HS) | 14. Power cable (MB-PWR) |
| 15. Solid-state drive slots (M.2 PCIe SSD 1 + M.2 PCIe SSD 0) | 16. Display cable (LVDS) |
| 17. Coin-cell battery socket (RTC) | 18. PCIe x 16 expansion slot (SLOT1 PCIe4 x8) |

The following images indicate the location of the system board and provide a visual representation of the removal procedure.

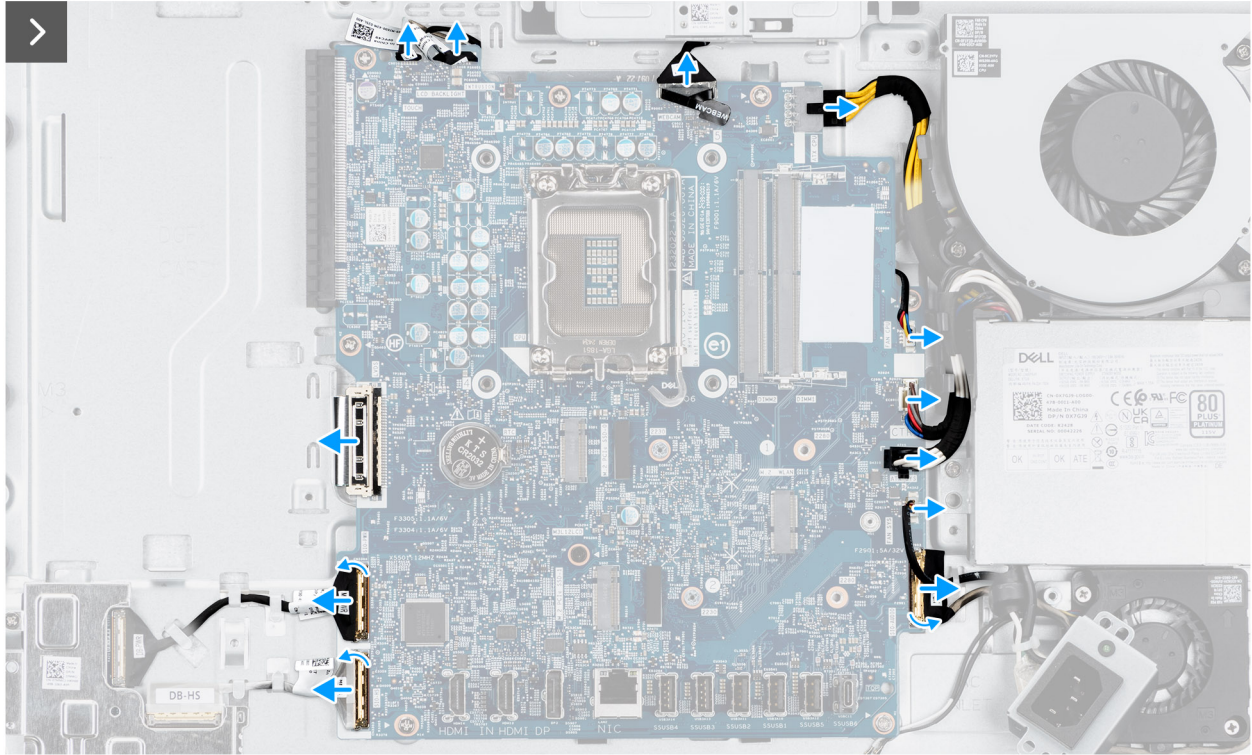
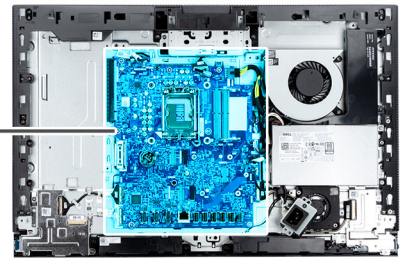

Figure 55. Removing the system board

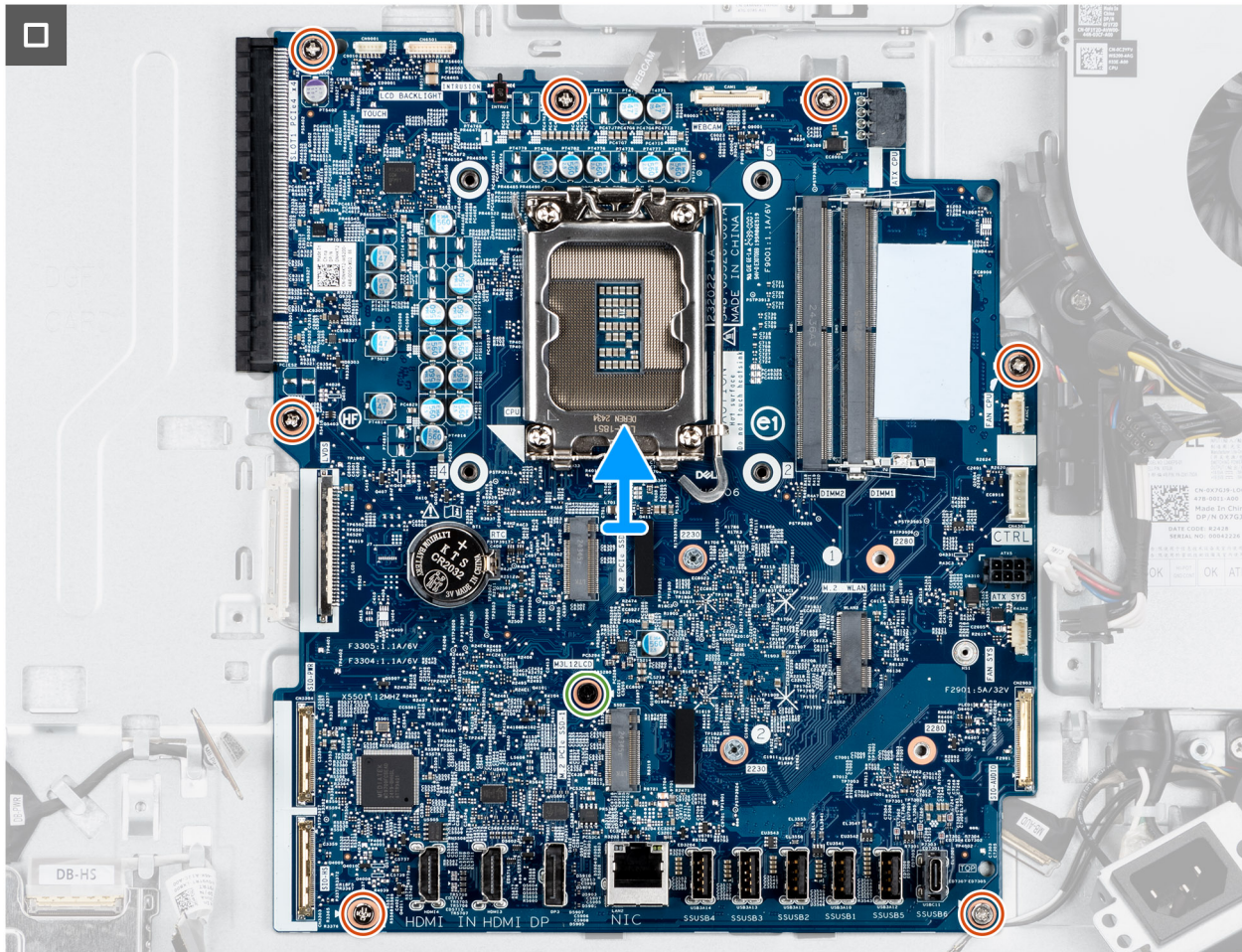

Figure 56. Removing the system board

Steps

1. Disconnect the touchscreen cable from its connector (TOUCH) on the system board.
2. Disconnect the display-backlight cable from its connector (LCB BACKLIGHT) on the system board.
3. Using the pull tab, disconnect the camera cable from its connector (WEBCAM) on the system board.
4. Press and hold the securing clip and disconnect the processor-power cable from its connector (ATX CPU) on the system board.
5. Disconnect the fan cable from its connector (FAN CPU) on the system board.
6. Disconnect the control-signal cable from its connector (CTRL) on the system board.
7. Disconnect the system-board power cable from its connector (ATX SYS) on the system board.
8. Disconnect the power-supply fan cable from its connector (FAN SYS) on the system board.
9. Lift the latch and disconnect the audio cable from its connector (MB-AUDIO) on the system board.
10. Lift the latch and disconnect the high-speed cable from its connector (MB-HS) on the system board.
11. Lift the latch and disconnect the power cable from its connector (MB-PWR) on the system board.
12. Pinching the securing clips on either side of the display-cable connector, disconnect the display cable from its connector (LVDS) on the system board.
13. Remove the seven screws (M3x5) that secure the system board to the display-assembly base.
14. Remove the screw (M3x12) that secures the system board to the display-assembly base.
15. Gently lift the system board off the display-assembly base.

Installing the system board

CAUTION: The information in this installation section is intended for authorized service technicians only.

Prerequisites

If you are replacing a component, remove the existing component before performing the installation process.

About this task

i **NOTE:** Replacing the system board removes any changes that you have made to the BIOS using the BIOS setup program. Make the appropriate changes again after you replace the system board.

The following image indicates the connectors on your system-board.

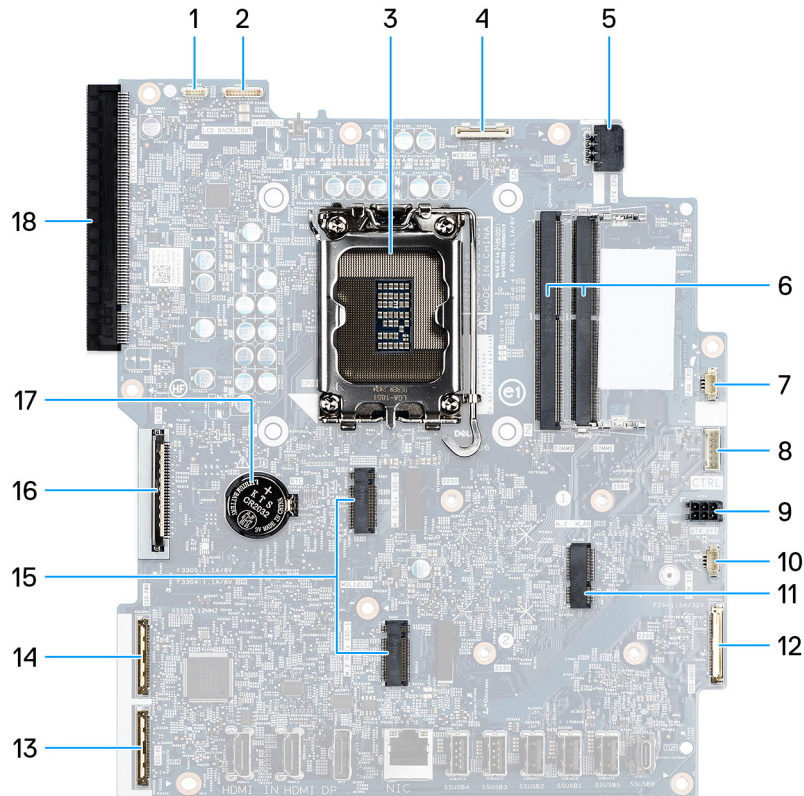

Figure 57. System board callouts

- | | |
|---|---|
| 1. Touchscreen cable (TOUCH) | 2. Display-backlight cable (LCD BACKLIGHT) |
| 3. Processor socket (CPU) | 4. Camera cable (WEBCAM) |
| 5. Processor-power cable (ATX CPU) | 6. Memory slots (DIMM1 + DIMM2) |
| 7. Fan cable (FAN CPU) | 8. Control-signal cable (CTRL) |
| 9. System-board power cable (ATX SYS) | 10. Power-supply fan cable (FAN SYS) |
| 11. Wireless-card slot (M.2 WLAN) | 12. Audio cable (MB-AUDIO) |
| 13. High-speed cable (MB-HS) | 14. Power cable (MB-PWR) |
| 15. Solid-state drive slots (M.2 PCIe SSD 1 + M.2 PCIe SSD 0) | 16. Display cable (LVDS) |
| 17. Coin-cell battery socket (RTC) | 18. PCIe x 16 expansion slot (SLOT1 PCIe4 x8) |

The following images indicate the location of the system board and provide a visual representation of the installation procedure.



7x
M3x5



1x

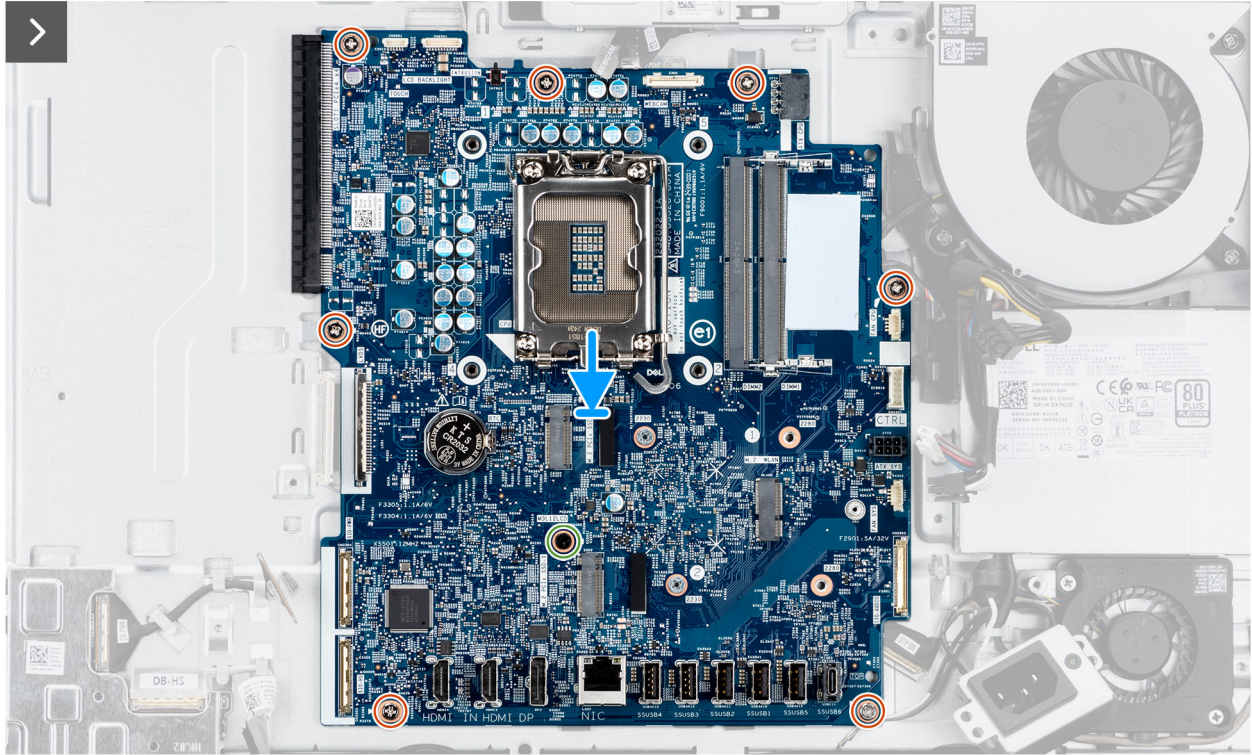
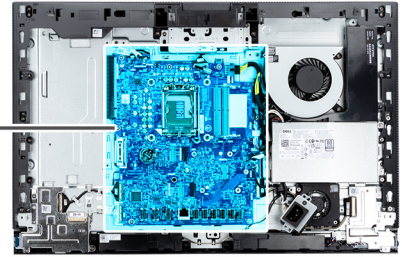

Figure 58. Installing the system board

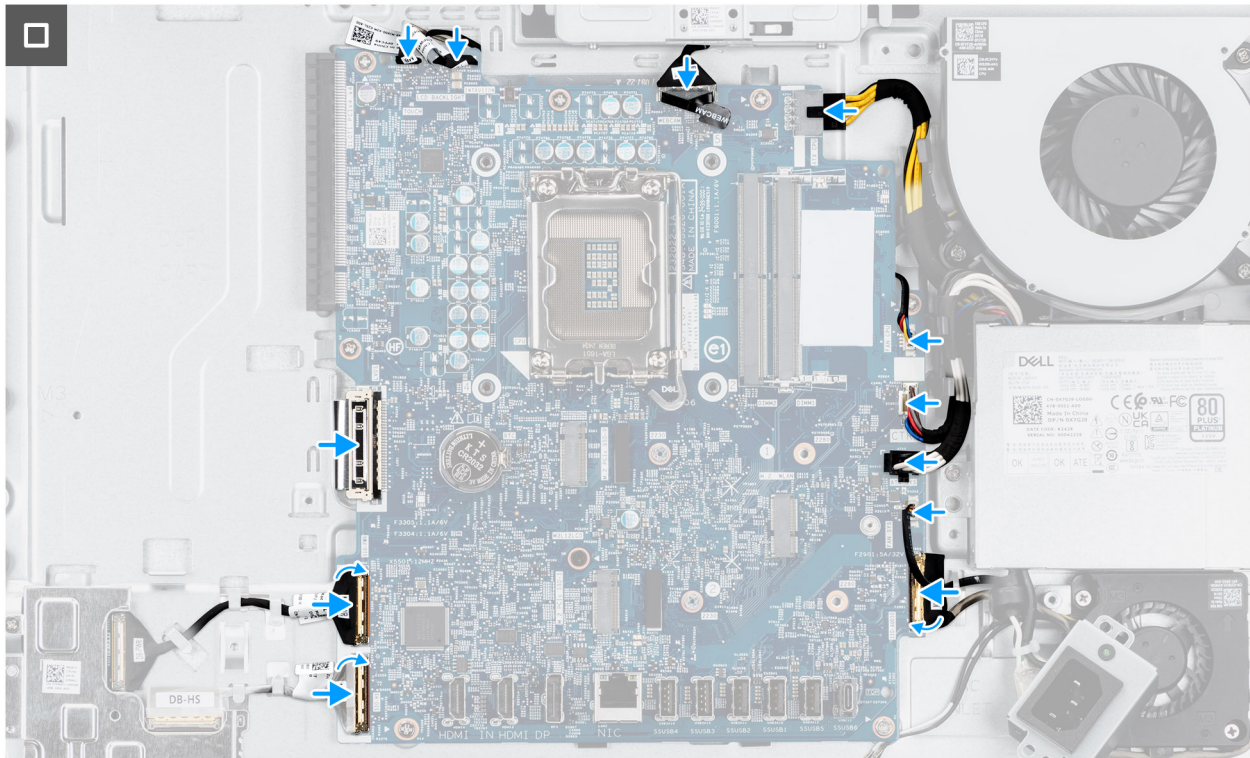

Figure 59. Installing the system board

Steps

1. Gently place the system board on the display-assembly base.
2. Align the screw holes on the system board with the screw holes on the display-assembly base.
3. Replace the seven screws (M3x5) to secure the system board to the display-assembly base.
4. Replace the screw (M3x12) to secure the system board to the display-assembly base.
5. Connect the touchscreen cable to its connector (TOUCH) on the system board.
6. Connect the display-backlight cable to its connector (LCB BACKLIGHT) on the system board.
7. Connect the camera cable to its connector (WEBCAM) on the system board.
8. Connect the processor-power cable to its connector (ATX CPU) on the system board.
9. Connect the fan cable to its connector (FAN CPU) on the system board.
10. Connect the control-signal cable to its connector (CTRL) on the system board.
11. Connect the system-board power cable to its connector (ATX SYS) on the system board.
12. Connect the power-supply fan cable to its connector (FAN SYS) on the system board.
13. Connect the audio cable to its connector (MB-AUDIO) on the system board and close the latch.
14. Connect the high-speed cable to its connector (MB-HS) on the system board and close the latch.
15. Connect the power cable to its connector (MB-PWR) on the system board and close the latch.
16. Connect the display cable to its connector (LVDS) on the system board.

Next steps

1. Install the [processor](#).
2. Install the [heat sink](#).
3. Install the [wireless card](#).
4. Install the [M.2 2230 solid-state drive in slot 0](#).
5. Install the [M.2 2230 solid-state drive in slot 1](#).
6. Install the [I/O bracket](#).
7. Install the [bottom cover](#).
8. Install the [I/O cover](#).
9. Install the [system-board shield](#).

10. Install the [memory](#).
11. Install the [back cover](#).
12. Install the [stand](#).
13. Follow the procedure in [After working inside your computer](#).

Power-button and I/O board

Removing the power-button and I/O board

CAUTION: The information in this removal section is intended for authorized service technicians only.

Prerequisites

1. Follow the procedure in [Before working inside your computer](#).
2. Remove the [stand](#).
3. Remove the [back cover](#).
4. Remove the [system-board shield](#).
5. Remove the [I/O cover](#).
6. Remove the [bottom cover](#).
7. Remove the [I/O bracket](#).

About this task

The following image indicates the location of the power-button and I/O board and provides a visual representation of the removal procedure.

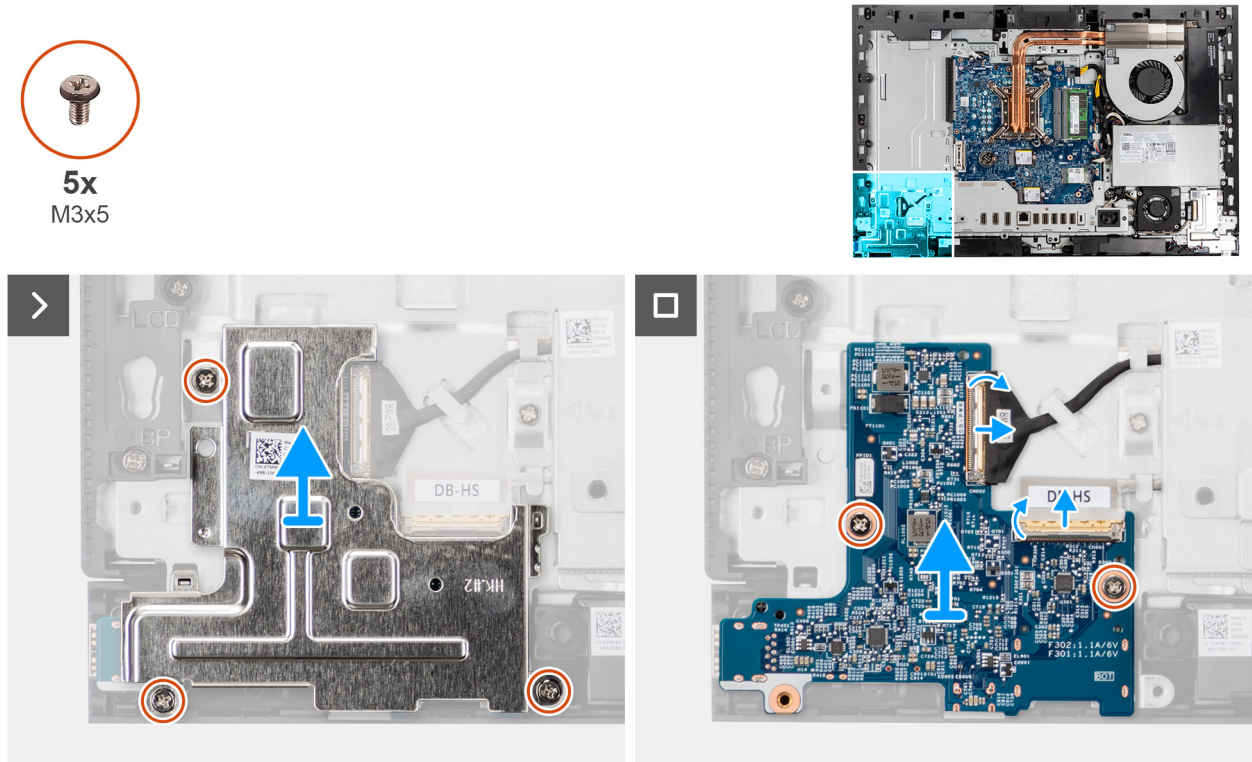

Figure 60. Removing the power-button and I/O board

Steps

1. Remove the three screws (M3x5) that secure the power-button and I/O board shield to the display-assembly base.
2. Lift the power-button and I/O board shield off the display-assembly base.

3. Lift the latch and disconnect the power cable from its connector (DB-PWR) on the power-button and I/O board.
4. Lift the latch and disconnect the high-speed cable from its connector (DB-HS) on the power-button and I/O board.
5. Remove the two screws (M3x5) that secure the power-button and I/O board to the display-assembly base.
6. Lift the power-button and I/O board off the display-assembly base.

Installing the power-button and I/O board

CAUTION: The information in this installation section is intended for authorized service technicians only.

Prerequisites

If you are replacing a component, remove the existing component before performing the installation process.

About this task

The following image indicates the location of the power-button and I/O board and provides a visual representation of the installation procedure.

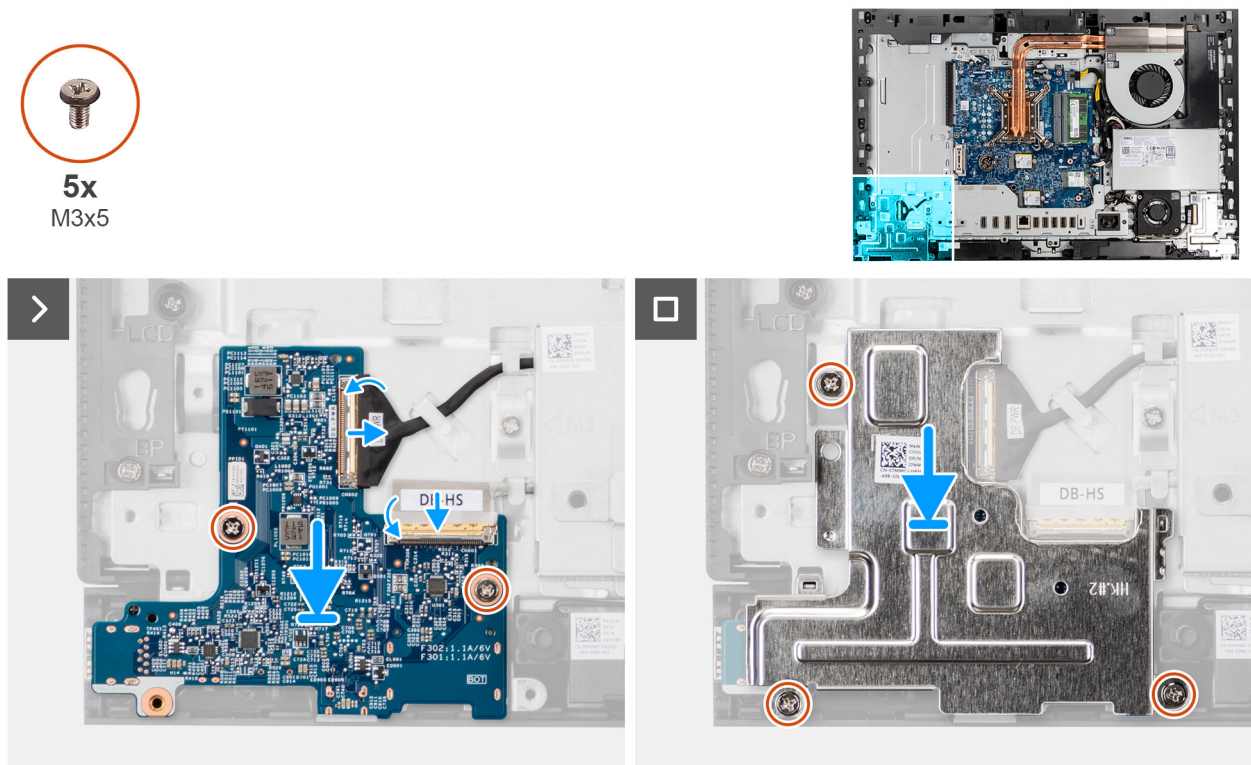

Figure 61. Installing the power-button and I/O board

Steps

1. Place the power-button and I/O board on the display-assembly base.
2. Align the screw holes on the power-button and I/O board with the screw holes on the display-assembly base.
3. Replace the two screws (M3x5) to secure the power-button and I/O board to the display-assembly base.
4. Connect the power cable to its connector (DB-PWR) on the power-button and I/O board and close the latch.
5. Connect the high-speed cable to its connector (DB-PWR) on the power-button and I/O board and close the latch.
6. Place the power-button and I/O board shield on the display-assembly base.
7. Align the screw holes on the power-button and I/O board shield with the screw holes on the display-assembly base.
8. Replace the three screws (M3x5) to secure the power-button and I/O board shield to the display-assembly base.

Next steps

1. Install the [I/O bracket](#).
2. Install the [bottom cover](#).
3. Install the [I/O cover](#).
4. Install the [system-board shield](#).
5. Install the [back cover](#).
6. Install the [stand](#).
7. Follow the procedure in [After working inside your computer](#).

Audio board

Removing the audio board

CAUTION: The information in this removal section is intended for authorized service technicians only.

Prerequisites

1. Follow the procedure in [Before working inside your computer](#).
2. Remove the [stand](#).
3. Remove the [back cover](#).
4. Remove the [system-board shield](#).
5. Remove the [I/O cover](#).
6. Remove the [bottom cover](#).
7. Remove the [I/O bracket](#).

About this task

The following image indicates the location of the audio board and provides a visual representation of the removal procedure.

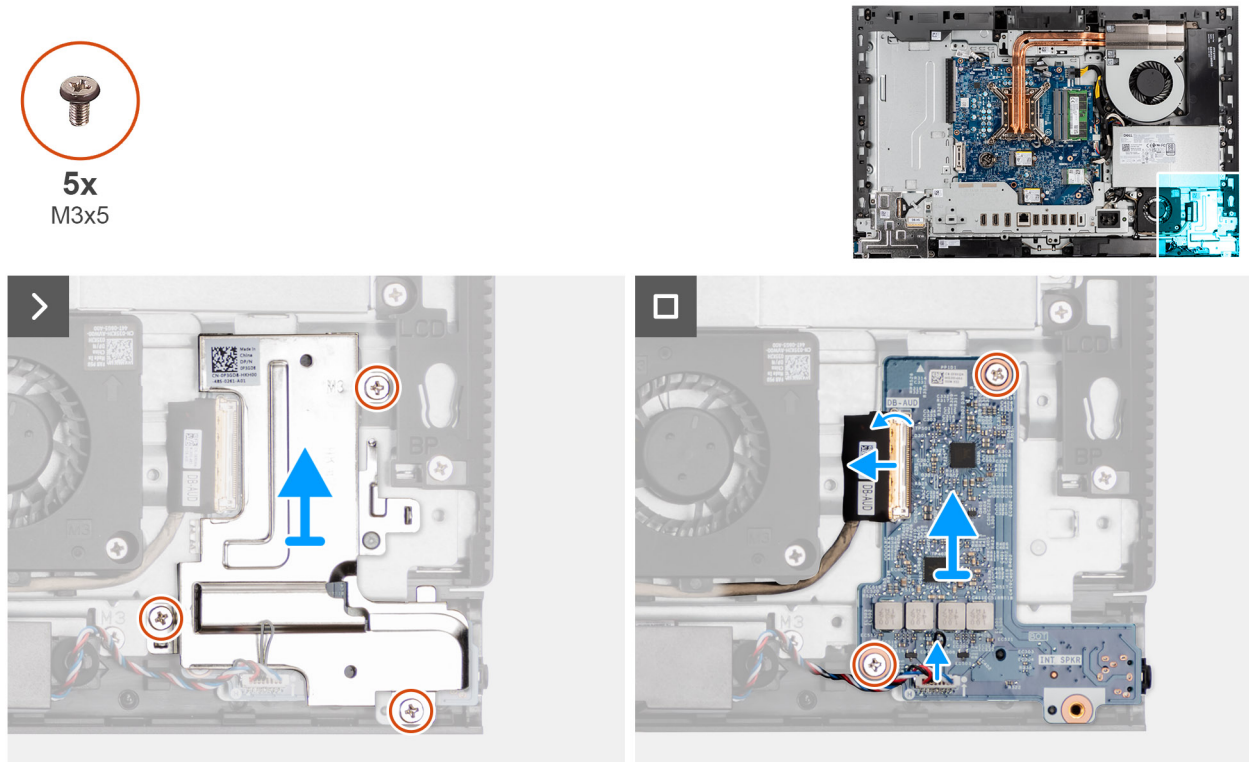

Figure 62. Removing the audio board

Steps

1. Remove the three screws (M3x5) that secure the audio-board shield to the display-assembly base.
2. Lift the audio-board shield off the display-assembly base.
3. Lift the latch and disconnect the audio cable from its connector (DB-AUDIO) on the audio board.
4. Disconnect the speaker cable from its connector (INT SPKR) on the audio board.
5. Remove the two screws (M3x5) that secure the audio board to the display-assembly base.
6. Lift the audio board off the display-assembly base.

Installing the audio board

CAUTION: The information in this installation section is intended for authorized service technicians only.

Prerequisites

If you are replacing a component, remove the existing component before performing the installation process.

About this task

The following image indicates the location of the audio board and provides a visual representation of the installation procedure.



5x
M3x5

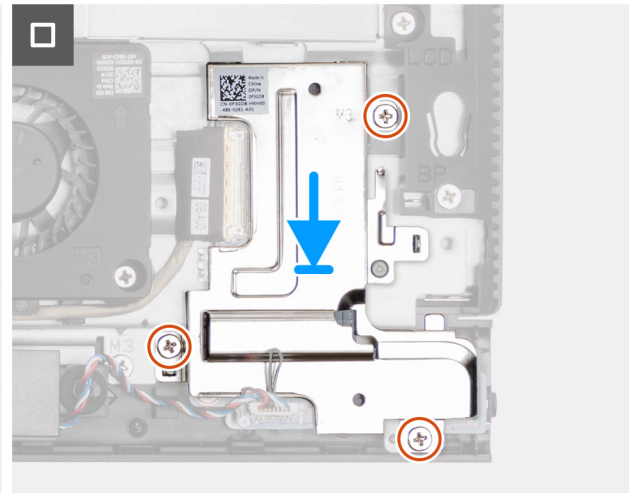
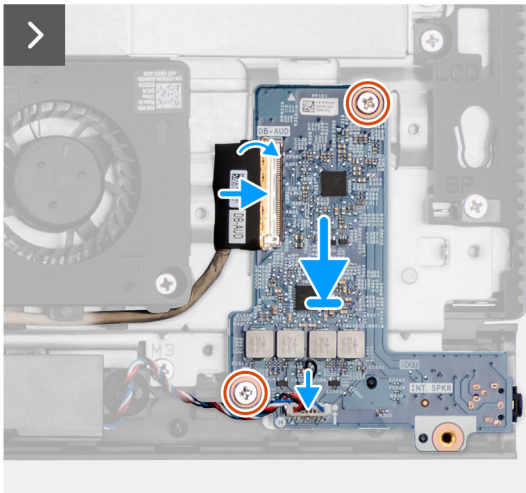
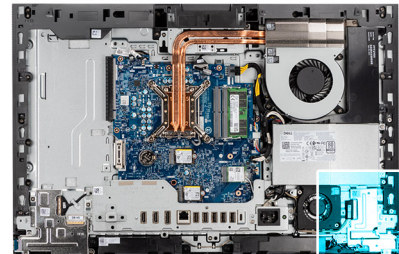

Figure 63. Installing the audio board

Steps

1. Place the audio board on the display-assembly base.
2. Align the screw holes on the audio board with the screw holes on the display-assembly base.
3. Replace the two screws (M3x5) to secure the audio board to the display-assembly base.
4. Connect the audio cable to its connector (DB-AUDIO) on the audio board and close the latch.
5. Connect the speaker cable to its connector (INT SPKR) to the audio board.
6. Place the audio-board shield on the display-assembly base.
7. Align the screw holes on the audio-board shield with the screw holes on the display-assembly base.
8. Replace the three screws (M3x5) to secure the audio-board shield to the display-assembly base.

Next steps

1. Install the [I/O bracket](#).
2. Install the [bottom cover](#).
3. Install the [I/O cover](#).
4. Install the [system-board shield](#).
5. Install the [back cover](#).
6. Install the [stand](#).
7. Follow the procedure in [After working inside your computer](#).

Display-assembly base

Removing the display-assembly base

 **CAUTION:** The information in this removal section is intended for authorized service technicians only.

Prerequisites

1. Follow the procedure in [Before working inside your computer](#).
2. Remove the [stand](#).
3. Remove the [back cover](#).
4. Remove the [system-board shield](#).
5. Remove the [wireless card](#).
6. Remove the [I/O cover](#).
7. Remove the [bottom cover](#).
8. Remove the [retractable-camera assembly](#).
9. Remove the [fan](#).
10. Remove the [power-supply unit](#).
11. Remove the [power-supply fan](#).
12. Remove the [I/O bracket](#).
13. Remove the [speakers](#).
14. Remove the [heat sink](#).
15. Remove the [system board](#).

 **NOTE:** The system board can be removed with the memory, solid-state drive(s), coin-cell battery, and processor attached.

16. Remove the [audio board](#).
17. Remove the [power-button and I/O board](#).

About this task

 **NOTE:** The display-assembly base includes the following components:

- Antenna modules
- Display panel
- Middle frame

To replace any of these components, replace the entire display-assembly base.

The following image indicates the location of the display-assembly base.

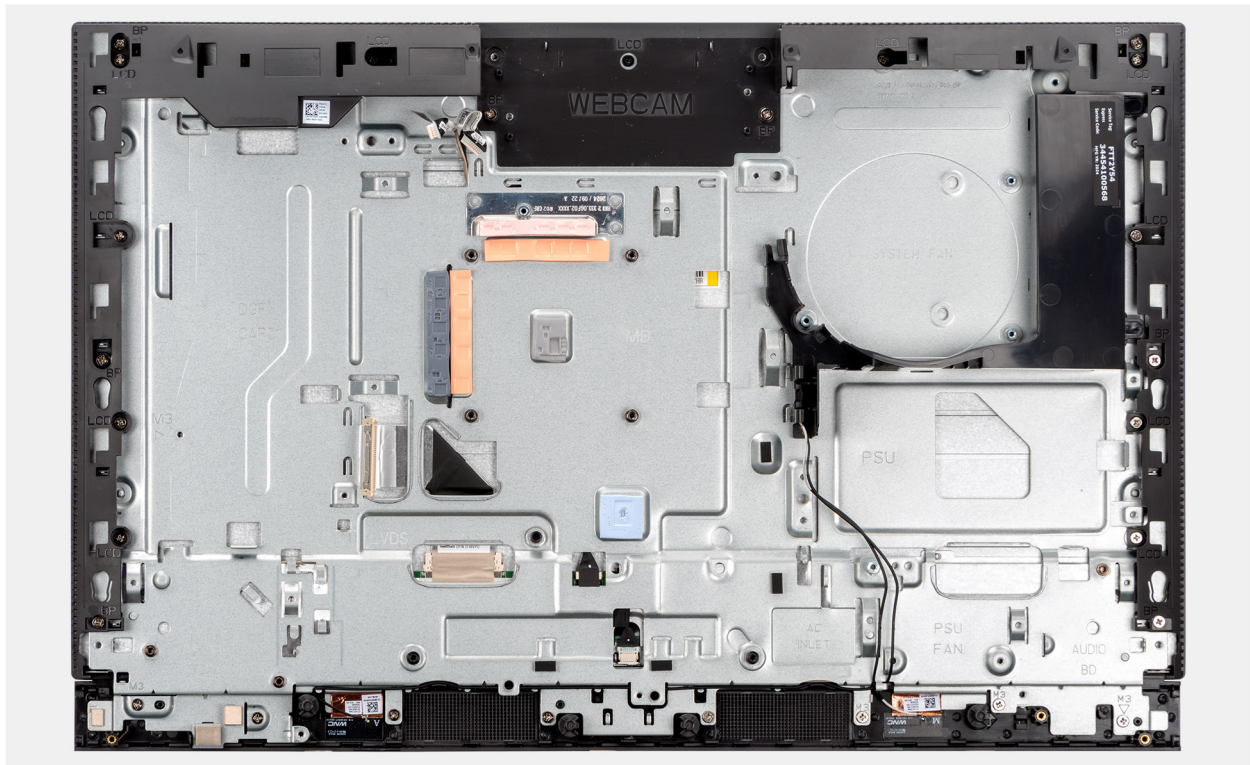

Figure 64. Removing the display-assembly base

Steps

After performing the pre-requisites, you are left with the display-assembly base.

Installing the display-assembly base

CAUTION: The information in this installation section is intended for authorized service technicians only.

Prerequisites

If you are replacing a component, remove the existing component before performing the installation process.

About this task

NOTE: The display-assembly base includes the following components:

- Antenna modules
- Display panel
- Middle frame

To replace any of these components, replace the entire display-assembly base.

The following image indicates the location of the display-assembly base.

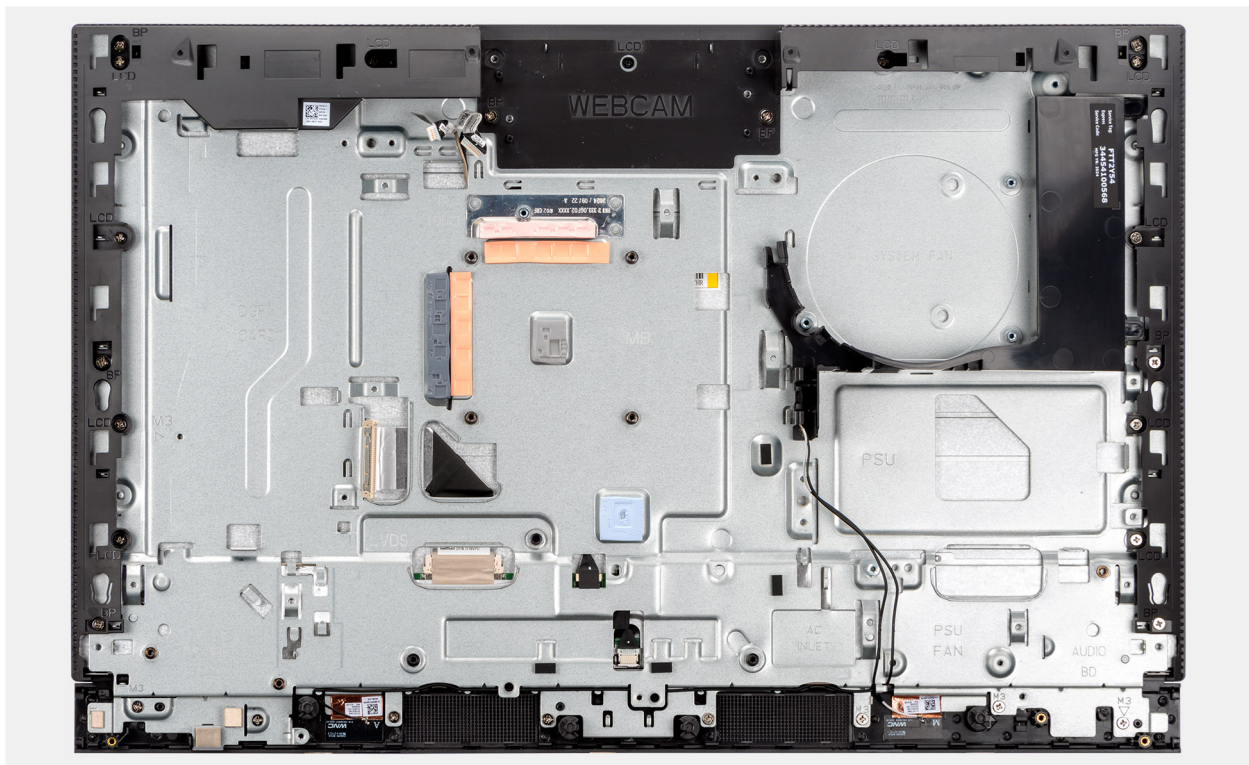

Figure 65. Removing the display-assembly base

Steps

To install the display-assembly base, perform all the post-requisite procedures.

Next steps

1. Install the [power-button and I/O board](#).
2. Install the [audio board](#).
3. Install the [system board](#).

NOTE: The system board can be installed with the memory, solid-state drive(s), coin-cell battery, and processor pre-attached.

4. Install the [heat sink](#).
5. Install the [speakers](#).
6. Install the [I/O bracket](#).
7. Install the [power-supply fan](#).
8. Install the [power-supply unit](#).
9. Install the [fan](#).
10. Install the [retractable-camera assembly](#).
11. Install the [bottom cover](#).
12. Install the [I/O cover](#).
13. Install the [wireless card](#).
14. Install the [system-board shield](#).
15. Install the [back cover](#).
16. Install the [stand](#).
17. Follow the procedure in [After working inside your computer](#).

Software

This chapter details the supported operating systems along with instructions on how to install the drivers.

Operating system

Your Dell Pro 24 All-in-One QC24250 supports the following operating systems:

- Windows 11 Home
- Windows 11 Professional
- Windows 11 Pro National Academic
- Ubuntu Linux 24.04 LTS

Drivers and downloads

When troubleshooting, downloading, or installing drivers, it is recommended that you read the [Dell Knowledge Base article Drivers and Downloads FAQs](#).

BIOS Setup

CAUTION: Certain changes can make your computer work incorrectly. Before you change the settings in BIOS Setup, it is recommended that you note down the original settings for future reference.

NOTE: Depending on the computer and the installed devices, the options that are listed in this section may differ.

Use BIOS Setup for the following purposes:

- Get information about the hardware installed in your computer, such as the amount of RAM and the capacity of the storage device.
- Change the system configuration information.
- Set or change user-selectable options such as the user password, enabling or disabling base devices, and configuring hard drive settings.

Entering BIOS Setup program

About this task

Turn on (or restart) your computer and press F2 immediately.

Navigation keys

NOTE: For most of the BIOS Setup options, changes that you make are recorded but do not take effect until you restart the computer.

Table 24. Navigation keys

Keys	Navigation
Up arrow	Moves to the previous field.
Down arrow	Moves to the next field.
Enter	Selects a value in the selected field (if applicable) or follows the link in the field.
Spacebar	Expands or collapses a drop-down list, if applicable.
Tab	Moves to the next focus area.
Esc	Moves to the previous page until you view the main screen. Pressing Esc in the main screen displays a message that prompts you to save any unsaved changes and restart the computer.

F12 One Time Boot menu

To enter the One Time Boot menu, turn on or restart your computer, and then press F12 immediately.

NOTE: If you are unable to enter the One Time Boot menu, repeat the above action.

The One Time Boot menu displays the devices that you can boot from and also display the options to start diagnostics. The boot menu options are:

- Removable Drive (if available)

- STXXXX Drive (if available)

i **NOTE:** XXXX denotes the SATA drive number.

- Optical Drive (if available)
- SATA Hard Drive (if available)
- Diagnostics

The One Time Boot menu screen also displays the option to access BIOS Setup.

System setup options

i **NOTE:** Depending on your computer and its installed devices, the items listed in this section may or may not appear.

Table 25. System setup options—System information menu

Overview	
BIOS Version	Displays the BIOS version number.
Service Tag	Displays the Service Tag of the computer.
Asset Tag	Displays the Asset Tag of the computer.
Manufacture Date	Displays the manufacture date of the computer.
Ownership Date	Displays the ownership date of the computer.
Express Service Code	Displays the express service code of the computer.
Ownership Tag	Displays the Ownership Tag of the computer.
Processor Information	
Processor Type	Displays the processor type.
Maximum Clock Speed	Displays the maximum processor clock speed.
Core Count	Displays the number of cores on the processor.
Processor ID	Displays the processor identification code.
Processor L2 Cache	Displays the processor L2 Cache size.
Processor L3 Cache	Displays the processor L3 Cache size.
Microcode Version	Displays the microcode version.
Intel Hyper-Threading Capable	Displays whether the processor is Hyper-Threading (HT) capable.
Intel vPro Technology	Displays whether vPro technology is used.
Memory Information	
Memory Installed	Displays the total computer memory installed.
Memory Available	Displays the total computer memory available.
Memory Speed	Displays the memory speed.
Memory Technology	Displays the technology used for the memory.
DIMM 1 Size	Displays the DIMM 1 memory size.
DIMM 2 Size	Displays the DIMM 2 memory size.
Devices Information	
Panel Type	Displays the Panel Type of the computer.
Video Controller	Displays the video controller type of the computer.
Video Memory	Displays the video memory information of the computer.
Wi-Fi Device	Displays the wireless device information of the computer.

Table 25. System setup options—System information menu (continued)

Overview	
Native Resolution	Displays the native resolution of the computer.
Video BIOS Version	Displays the video BIOS version of the computer.
Audio Controller	Displays the audio controller information of the computer.
Bluetooth Device	Displays the Bluetooth device information of the computer.
LOM MAC Address	Displays the LAN On Motherboard (LOM) MAC address of the computer.
Slot1 PCIe4 x4	Displays the M.2 PCIe information of the computer

Table 26. System setup options—Boot Configuration menu

Boot Configuration	
Boot Sequence	
Boot Sequence	Displays the boot sequence.
Enable PXE Boot Priority	Enables a new PXE boot option, if detected, to be added to the top of the Boot Sequence.
Force PXE On Next Boot	Enable or disable the Force PXE feature on next boot. By default, the Enable Force PXE On Next Boot option is not enabled.
Secure Digital (SD) Card Boot	Enable or disable the SD card read-only boot. By default, the Secure Digital (SD) Card Boot option is not enabled.
Secure Boot	
	Secure Boot is a method of guaranteeing the integrity of the boot path by performing additional validation of the operating system and PCI add-in cards. The computer stops booting to the operating system when a component is not authenticated during the boot process.
Enable Secure Boot	Enables the computer to boot using only validated boot software. By default, the Enable Secure Boot option is enabled. For additional security, Dell Technologies recommends keeping the Secure Boot option enabled to ensure that the UEFI firmware validates the operating system during the boot process. NOTE: For Secure Boot to be enabled, the computer is required to be in UEFI boot mode and the Enable Legacy Option ROMs option is required to be turned off.
Enable Microsoft UEFI CA	Include or remove the Microsoft UEFI CA in the BIOS UEFI Secure Boot DB database by enabling or disabling this option. By default, the Enable Microsoft UEFI CA option is disabled.
Secure Boot Mode	Enables or disables the Secure Boot operation mode. By default, the Deployed Mode is selected. NOTE: Deployed Mode should be selected for normal operation of Secure Boot.
Expert Key Management	
Enable Custom Mode	Enables the PK, KEK, db, and dbx security key databases to be modified. By default, this option is disabled.

Table 27. System setup options—Integrated Devices menu

Integrated Devices	
Date/Time	Displays the current date in MM/DD/YYYY format and current time in HH:MM:SS AM/PM format.
Camera	Enables or disable the camera. By default, the Enable Camera option is selected
Audio	
Enable Audio	Enable or disable the integrated audio controller, microphone and the internal speaker separately. By default, all the options are enabled.
USB Configuration	Enable or disable booting from USB mass storage devices through the boot sequence or boot menu. By default, all the options are enabled.
Side USB Configuration	Enable or disable the individual side USB ports. By default, the Side USB Port 1 (Bottom TypeC) and Side USB Port 2 (Right) option are enabled. <div style="border-left: 1px solid black; padding-left: 10px;"> <p>i NOTE: Despite the description shown in the BIOS Side USB Port 1 (Bottom TypeC) refers to the USB port on the right side view of the computer and Side USB Port 2 (Right) refers to the USB port on the bottom view of the computer.</p> </div>
Rear USB Configuration	Enable or disable the individual rear USB ports. By default, all the options are enabled.

Table 28. System setup options—Storage menu

Storage	
SATA/NVMe Operation	Enable or disable the operating mode of the integrated SATA hard drive controller. By default, the RAID On option is enabled.
Storage Interface	
Port Enablement	Enable or disable the onboard drives. By default M.2 PCIe SSD-0 and M.2 PCIe SSD-1 options are enabled.
SMART Reporting	
Enable SMART Reporting	Enable or disable Self-Monitoring, Analysis, and Reporting Technology (SMART) during computer startup. By default, the Enable SMART Reporting option is not enabled.
Drive Information	
M.2 PCIe SSD-0	
Type	Displays the M.2 PCIe SSD-0 type information of the computer.
Device	Displays the M.2 PCIe SSD-0 device information of the computer.
M.2 PCIe SSD-1	
Type	Displays the M.2 PCIe SSD-1 type information of the computer.
Device	Displays the M.2 PCIe SSD-1 device information of the computer.
Enable MediaCard	
Secure Digital (SD) Card	Enable or disable the SD card.

Table 28. System setup options—Storage menu (continued)

Storage	
	By default, the Secure Digital (SD) Card option is enabled.
Secure Digital (SD) Card Read-Only Mode	Enable or disable the SD card read-only mode. By default, the Secure Digital (SD) Card Read-Only Mode option is not enabled.

Table 29. System setup options—Display menu

Display	
Touchscreen	Enable or disable the touchscreen.
OSD Button Management	
Disable OSD Buttons	Enable or disable the OSD (On-Screen Display) buttons on the computer.
Full Screen Logo	Enable or disable full screen logo. By default, the option is not enabled.

Table 30. System setup options—Connection menu

Connection	
Network Controller Configuration	
Integrated NIC	Controls the on-board LAN controller. By default, the Enabled with PXE option is enabled.
Wireless Device Enable	
WLAN	Enable or disable the internal WLAN device By default, the option enabled.
Bluetooth	Enable or disable the internal Bluetooth device By default, the option enabled.
Enable UEFI Network Stack	Enable or disable UEFI Network Stack and controls the on-board LAN Controller. By default, the option is enabled.
HTTPs Boot Feature	
HTTPs Boot	Enable or disable the HTTPs Boot feature. By default, the HTTPs Boot option is enabled.
HTTPs Boot Mode	With Auto Mode, the HTTPs Boot extracts Boot URL from the DHCP. With Manual Mode, the HTTPs Boot reads Boot URL from the user-provided data. By default, the Auto Mode option is enabled.

Table 31. System setup options—Power menu

Power	
USB PowerShare	
Enable USB PowerShare	Enable or disable the USB PowerShare. By default, the Enable USB PowerShare option is disabled
USB Wake Support	
Enable USB Wake Support	When enabled, you can use the USB devices like a mouse or keyboard to wake your computer from standby.

Table 31. System setup options—Power menu (continued)

Power	
	By default, the option is enabled.
AC Behavior	
AC Recovery	Enables the system to turn on automatically, when AC is inserted. By default, the Power Off option is enabled.
Block Sleep	Enables to block entering sleep (S3) mode in the operating system. By default, the Block Sleep option is disabled.
Deep Sleep Control	Enable or disable the Deep Sleep mode support. By default, the Enabled in S4 and S5 option is enabled.
Fan Control Override	Enable or disable the fan control override feature. By default, the option is disabled.

Table 32. System setup options—Security menu



Security	
TPM 2.0 Security	Trusted Platform Module (TPM) is a security device that stores computer-generated keys for encryption and features such as BitLocker, Virtual Secure Mode, remote Attestation. By default, the Trusted Platform Module (TPM) option is enabled. For additional security, Dell Technologies recommends keeping Trusted Platform Module (TPM) enabled to allow these security technologies to fully function.
TPM 2.0 Security On	Enables you to enable or disable TPM. By default, the TPM 2.0 Security On option is enabled. For additional security, Dell Technologies recommends keeping TPM enabled to allow these security technologies to fully function.
Attestation Enable	The Attestation Enable option controls the endorsement hierarchy of TPM. Disabling the Attestation Enable option prevents TPM from being used to digitally-sign certificates. By default, the Attestation Enable option is enabled. For additional security, Dell Technologies recommends keeping the Attestation Enable option enabled.
Key Storage Enable	 NOTE: When disabled, this feature may cause compatibility issues or loss of functionality in some operating systems. The Key Storage Enable option controls the storage hierarchy of TPM, which is used to store digital keys. Disabling the Key Storage Enable option restricts the ability of TPM to store owner's data. By default, the Key Storage Enable option is enabled. For additional security, Dell Technologies recommends keeping the Key Storage Enable option enabled.  NOTE: When disabled, this feature may cause compatibility issues or loss of functionality in some operating systems.
Clear	Clears the TPM owner information and returns the TPM to the default state. By default, this option is disabled.
Physical Presence Interface (PPI) Bypass for Clear Commands	By default, the PPI Bypass for Clear Commands option is disabled.

Table 32. System setup options—Security menu (continued)





Security	
Intel Total Memory Encryption	<p>For additional security, Dell Technologies recommends keeping the PPI Bypass for Clear Commands option disabled.</p> <p>Enables system memory encryption by the TME block attached to the memory controller.</p> <p>By default, the Multi-Key Total Memory Encryption (Up to 16 keys) option is disabled.</p>
Chassis intrusion	
Chassis Intrusion	<p>Enables you to control the chassis intrusion feature. This feature notifies the user when the base cover has been removed from the computer.</p> <p>When set to Enabled, a notification is displayed on the next boot and the event is logged in the BIOS Events log.</p> <p>When set to On-Silent, the event is logged in the BIOS Events log, but no notification is displayed.</p> <p>When set to Disabled, no notification is displayed and no event is logged in the BIOS Events log.</p> <p>By default, the Chassis Intrusion option is enabled.</p> <p>For additional security, Dell Technologies recommends keeping the Chassis Intrusion Detection option enabled.</p>
Data Wipe on Next Boot	
Start Data Wipe	<p> CAUTION: Secure Data Wipe operation deletes information in a way that it cannot be reconstructed.</p> <p>Commands such as delete and format in the operating system may remove files from showing up in the file system, however they can be reconstructed through forensic means as they are still represented on the physical media. Data Wipe prevents this reconstruction and is not recoverable.</p> <p>When enabled, the BIOS will queue up a data wipe cycle for storage devices that are connected to the motherboard on the next reboot.</p> <p>By default, the Start Data Wipe option is disabled.</p>
Absolute	<p>Enables, disables, or permanently disables the BIOS module interface of the optional Absolute Persistence Module service from Absolute software.</p> <p>By default, the Absolute option is enabled.</p> <p>For additional security, Dell Technologies recommends keeping the Absolute option enabled.</p> <p> WARNING: The 'Permanently Disabled' option can only be selected once. When 'Permanently Disabled' is selected, Absolute Persistence cannot be re-enabled. No further changes to the Enable/Disable states are allowed.</p> <p> NOTE: The Enable/Disable options are unavailable while the computer is in the activated state.</p> <p> NOTE: When the Absolute features are activated, the Absolute integration cannot be disabled from the BIOS setup screen.</p>
UEFI Boot Path Security	<p>Enables or disables the computer to prompt the user to enter the Administrator password (if set) when booting to a UEFI boot path device from the F12 boot menu.</p> <p>By default, the Always Except Internal HDD option is enabled.</p>
Authenticated BIOS Interface	

Table 32. System setup options—Security menu (continued)

Security	
Enable Authenticated BIOS Interface	By default, this option is disabled.
Legacy Manageability Interface Access	Enables the platform administrator to control access via the Legacy Manageability Interface.
Firmware Device Tamper Detection	<p>Enables you to control the firmware device tamper detection feature. This feature notifies the user when the firmware device is tampered. When enabled, a screen warning messages are displayed on the computer and a tamper detection event is logged in the BIOS Events log. The computer fails to reboot until the event is cleared.</p> <p>For additional security, Dell Technologies recommends keeping the Firmware Device Tamper Detection option enabled.</p>
Clear Firmware Device Tamper Detection	<p>Enables booting by clearing the event.</p> <p>By default, the Clear Firmware Device Tamper Detection option is disabled.</p>

Table 33. System setup options—Passwords menu

Passwords	
Admin Password	<p>The Administrator Password prevents unauthorized access to the BIOS Setup options. Once the administrator password is set, the BIOS setup options can only be modified after providing the correct password.</p> <p>The following rules and dependencies apply to the Administrator Password -</p> <ul style="list-style-type: none"> • The administrator password cannot be set if system and/or internal hard drive passwords are previously set. • The administrator password can be used in place of the system and/or internal hard drive passwords. • When set, the administrator password must be provided during a firmware update. • Clearing the administrator password also clears the system password (if set). <p>Dell Technologies recommends using an administrator password to prevent unauthorized changes to BIOS setup options.</p>
System Password	<p>The System Password prevents the system from booting to an operating system without entering the correct password.</p> <p>The following rules and dependencies apply when the System Password is used -</p> <ul style="list-style-type: none"> • The computer shuts down when idle for approximately 10 minutes at the system password prompt. • The computer shuts down after three incorrect attempts to enter the system password. • The computer shuts down when the Esc key is pressed at the System Password prompt. • The system password is not prompted when the computer resumes from standby mode. <p>Dell Technologies recommends using the system password in situations where it is likely that a system may be lost or stolen.</p>
M.2 PCIe SSD-0	<p>The M.2 PCIe SSD-0 can be set to prevent unauthorized access of the data stored on the solid-state drive. The computer prompts for the solid-state drive password during boot in order to unlock the drive. A password secured solid-state drive stays locked even when removed from the computer or placed into another computer. It prevents an attacker from accessing data on the drive without authorization.</p> <p>The following rules and dependencies apply when the M.2 PCIe SSD-0 is used -</p> <ul style="list-style-type: none"> • The ssd password option cannot be accessed when ssd is disabled in the BIOS setup.

Table 33. System setup options—Passwords menu (continued)

Passwords	
	<ul style="list-style-type: none"> • The computer shuts down when idle for approximately 10 minutes at the ssd password prompt. • The computer shuts down after three incorrect attempts to enter the ssd password and treats the ssd as not available. • The ssd does not accept password unlock attempts after five incorrect attempts to enter the ssd password from the BIOS Setup. The ssd password must be reset for the new password unlock attempts. • The computer treats the ssd as not available when the Esc key is pressed at the ssd password prompt. • The ssd password is not prompted when the computer resumes from standby mode. When the ssd is unlocked by the user before the computer goes into standby mode, it remains unlocked after the computer resumes from standby mode. • If the system and ssd passwords are set to the same value, the ssd unlocks after the correct system password is entered. <p>Dell Technologies recommends using a ssd password to protect unauthorized data access.</p>
<p>M.2 PCIe SSD-1</p>	<p>The M.2 PCIe SSD-1 can be set to prevent unauthorized access of the data stored on the solid-state drive. The computer prompts for the solid-state drive password during boot in order to unlock the drive. A password secured solid-state drive stays locked even when removed from the computer or placed into another computer. It prevents an attacker from accessing data on the drive without authorization.</p> <p>The following rules and dependencies apply when the M.2 PCIe SSD-1 is used -</p> <ul style="list-style-type: none"> • The ssd password option cannot be accessed when ssd is disabled in the BIOS setup. • The computer shuts down when idle for approximately 10 minutes at the ssd password prompt. • The computer shuts down after three incorrect attempts to enter the ssd password and treats the ssd as not available. • The ssd does not accept password unlock attempts after five incorrect attempts to enter the ssd password from the BIOS Setup. The ssd password must be reset for the new password unlock attempts. • The computer treats the ssd as not available when the Esc key is pressed at the ssd password prompt. • The ssd password is not prompted when the computer resumes from standby mode. When the ssd is unlocked by the user before the computer goes into standby mode, it remains unlocked after the computer resumes from standby mode. • If the system and ssd passwords are set to the same value, the ssd unlocks after the correct system password is entered. <p>Dell Technologies recommends using a ssd password to protect unauthorized data access.</p>
<p>Password Configuration</p>	<p>The Password configuration page includes several options for changing the requirements of BIOS passwords. You can modify the minimum and maximum length of the passwords as well as require passwords to contain certain character classes (upper case, lower case, digit, special character).</p> <p>Dell Technologies recommends setting the minimum password length to at least 8 characters.</p>
<p>Password Bypass</p>	<p>The Password Bypass option allows the computer to reboot from the operating system without entering the system or hard drive password. If the computer has already booted to the operating system, it is presumed that the user has already entered the correct system or hard drive password.</p>

Table 33. System setup options—Passwords menu (continued)

Passwords	
	<p>i NOTE: This option does not remove the requirement to enter the password after shutting down.</p> <p>By default, the Password Bypass option is enabled.</p> <p>For additional security, Dell Technologies recommends keeping the Password Bypass option enabled.</p>
Password Changes	
Allow Non-Admin Password Changes	<p>The Allow Non-Admin Password Changes option in BIOS setup allows an end user to set or change the system or hard drive passwords without entering the administrator password. This gives an administrator control over the BIOS settings but enables an end user to provide their own password.</p> <p>By default, the Allow Non-Admin Password Changes option is disabled.</p> <p>For additional security, Dell Technologies recommends keeping the Allow Non-Admin Password Changes option disabled.</p>
Admin Setup Lockout	
Enable Admin Setup Lockout	<p>The Enable Admin Setup Lockout option prevents an end user from even viewing the BIOS setup configuration without first entering the administrator password (if set).</p> <p>By default, the Enable Admin Setup Lockout option is disabled.</p> <p>For additional security, Dell Technologies recommends keeping the Admin Setup Lockout option disabled.</p>
Master Password Lockout	
Enable Master Password Lockout	<p>The Master Password Lockout setting allows you to disable the Recovery Password feature. If the system, administrator, or hard drive password is forgotten, the system becomes unusable.</p> <p>i NOTE: When the owner password is set, the Master Password Lockout option is not available.</p> <p>i NOTE: When an internal hard drive password is set, it must first be cleared before Master Password Lockout can be changed.</p> <p>By default, the Enable Master Password Lockout option is disabled.</p> <p>Dell Technologies does not recommend enabling the Master Password Lockout unless you have implemented your own password recovery system.</p>
Allow Non-Admin PSID Revert	
Enable Allow Non-Admin PSID Revert	<p>The Allow Non-Admin PSID Revert setting controls access to the Physical Security ID (PSID) revert of NVMe hard drives from the Dell Security Manager Prompt.</p> <p>i NOTE: When disabled: If a BIOS Admin password is set, PSID revert is protected by the BIOS Admin password and the user will be prompted to enter the BIOS Admin password before performing the revert.</p> <p>i NOTE: When enabled: PSID revert is allowed to proceed without providing the BIOS Admin password.</p> <p>By default, the Enable Allow Non-Admin PSID Revert option is disabled.</p>

Table 34. System setup options—Update, Recovery menu

Update, Recovery	
BIOS Recovery from Hard Drive	<p>Enables the user to recover from certain corrupted BIOS conditions from a recovery file on the user primary hard drive or an external USB key.</p>

Table 34. System setup options—Update, Recovery menu (continued)

Update, Recovery	
	By default, the option is enabled.
BIOS Downgrade	
Allow BIOS Downgrade	Enable or disable the flashing of the computer firmware to previous revision is blocked. By default, the option is enabled.
SupportAssist OS Recovery	Enable or disable the boot flow for SupportAssist OS Recovery tool in the event of certain computer errors. By default, the option is enabled.
BIOSConnect	Enables cloud Service OS recovery if the main operating system fails to boot with the number of failures equal to or greater than the value specified by the Auto OS Recovery Threshold setup option. By default, the option is enabled.
Dell Auto OS Recovery Threshold	Controls the automatic boot flow for SupportAssist System Resolution Console and for Dell OS Recovery Tool. By default, the threshold value is set to 2.

Table 35. System setup options—System Management menu

System Management	
Service Tag	Display the Service Tag of the computer.
Asset Tag	Create a computer Asset Tag.
Wake on LAN/WLAN	Enable or disable the computer to power on by special LAN signals when it receives a wakeup signal from the WLAN. By default, the Disabled option is selected.
Auto on Time	Enable to set the computer to turn on automatically every day or on a preselected date and time. This option can be configured only if the Auto On Time is set to Everyday, Weekdays, or Selected Days. By default, the option is disabled.
Intel AMT Capability	
Enable Intel AMT Capability	Enable or disable the Intel AMT capability. By default, the Restrict MEBx Access option is enabled.
SERR Messages	Enable or disable SERR messages. By default, the option is enabled.
First Power On Date	
Set Ownership date	Enables to set the ownership date. By default, the option is disabled.
Diagnostics	
OS Agent Requests	Enable or disable scheduling of onboard diagnostics on a subsequent. By default, the option is enabled.
Power-on-Self-Test Automatic Recovery	Enables or disables BIOS automatic recovery of the computer if the computer becomes unresponsive before completing the BIOS Power-On-Self-Test. By default, the option is enabled.

Table 36. System setup options—Keyboard menu

Keyboard	
Numlock LED	
Enable Numlock LED	Enable or disable Numlock LED. By default, the option is enabled.
Device Configuration Hotkey Access	
	Enables users to access device configuration screens using hotkeys during system start up. By default, the option is enabled.

Table 37. System setup options—Pre-boot Behavior menu

Pre-boot Behavior	
Warning and Errors	
	Enable or disable the action to be done when a warning or error is encountered. By default, the Prompt on Warnings and Errors option is enabled.
Extend BIOS POST Time	
	Set the BIOS POST time. By default, the 0 seconds option is enabled.

Table 38. System setup options—Virtualization menu

Virtualization	
Intel Trusted Execution Technology (TXT)	
Enable Intel Trusted Execution Technology (TXT)	Specify whether a Measured Virtual Machine Monitor (MVMM) can utilize the additional hardware capabilities provided by Intel Trusted Execution Technology. By default, the option is enabled.
DMA Protection	
Enable Pre-Boot DMA Support	Controls the Pre-boot DMA protection for both internal and external ports. By default, the option is enabled.
Enable OS Kernal DMA Support	Controls the Kernal DMA protection for both internal and external ports. This setting doesnot directly enable DMA protection. The OS that supports DMA protection, the setting will indicate that the BIOS supports the feature. By default, the option is enabled.
Internal Port DMA Compatibility Mode	Enables BIOS to notify the OS that the internal ports are not DMA capable. This setting does not affect external port DMA or Pre-boot DMA support. By default, the option is disabled.

Table 39. System setup options—Performance menu

Performance	
Intel SpeedStep	
Enable Intel SpeedStep Technology	Enables the computer to dynamically adjust processor voltage and core frequency, decreasing average power consumption and heat production. By default, the option is enabled.
PCIe Resizable Base Address Register (BAR)	
Enable PCIe Resizable BAR support	Enable or disable PCIe Resizable Base Address Register (BAR) support. By default, the option is disabled.

Table 40. System setup options—System Logs menu

System Logs	
BIOS Event Log	
Clear BIOS Event Log	Display BIOS events. By default, the Keep Log option is enabled.
Power Event Log	
Clear Power Event Log	Display Power events. By default, the Keep Log option is enabled.

Updating the BIOS

Updating the BIOS in Windows

About this task

 **CAUTION:** If BitLocker is not suspended before updating the BIOS, the BitLocker key is not recognized the next time you reboot the computer. You will then be prompted to enter the recovery key to proceed, and the computer displays a prompt for the recovery key on each reboot. Failure to provide the recovery key can result in data loss or an operating system reinstall. For more information, refer [Updating the BIOS on Dell systems with BitLocker enabled](#).

 **CAUTION:** Do not turn off the computer during the BIOS flash update process. The computer may not boot if you turn off your computer.

Steps

1. Go to [Dell Support Site](#).
2. Go to **Identify your product or ask support**. In the box, enter the product identifier, model, service request or describe what you are looking for, and then click **Search**.
 -  **NOTE:** If you do not have the Service Tag, click **Detect This PC**. The site automatically detects your device, and you can then click **Explore Product Support** to go to the support page for your device. You can also use the product ID or manually browse for your computer model.
3. Click **Drivers & Downloads**.
4. Select the operating system installed on your computer.
5. In the **Category** drop-down list, select **BIOS**.
6. Select the latest version of BIOS, and click **Download** to download the BIOS file for your computer.
7. After the download is complete, navigate to the folder where the BIOS update file has been saved.
8. Double-click the BIOS update file and follow the on-screen instructions.
For more information, search [Dell Support Site](#).

Updating the BIOS in Linux and Ubuntu

To update the system BIOS on a computer that is installed with Linux or Ubuntu, see [How to Update the Dell BIOS in the Ubuntu or Linux Environment](#) at [Dell Support Site](#).

Updating the BIOS using the USB drive in Windows

About this task

CAUTION: If BitLocker is not suspended before updating the BIOS, the BitLocker key is not recognized the next time you reboot the computer. You will then be prompted to enter the recovery key to proceed, and the computer displays a prompt for the recovery key on each reboot. Failure to provide the recovery key can result in data loss or an operating system reinstall. For more information, refer [Updating the BIOS on Dell systems with BitLocker enabled](#).

CAUTION: Do not turn off the computer during the BIOS flash update process. The computer may not boot if you turn off your computer.

Steps

1. Go to [Dell Support Site](#).
2. Go to **Identify your product or ask support**. In the box, enter the product identifier, model, service request or describe what you are looking for, and then click **Search**.
NOTE: If you do not have the Service Tag, click **Detect This PC**. The site automatically detects your device, and you can then click **Explore Product Support** to go to the support page for your device. You can also use the product ID or manually browse for your computer model.
3. Click **Drivers & Downloads**.
4. Select the operating system installed on your computer.
5. In the **Category** drop-down list, select **BIOS**.
6. Select the latest version of BIOS, and click **Download** to download the BIOS file for your computer.
7. Create a bootable USB drive. For more information, search [Dell Support Site](#).
8. Copy the BIOS setup program file to the bootable USB drive.
9. Connect the bootable USB drive to the computer that needs the BIOS update.
10. Restart the computer and press **F12**.
11. Select the USB drive from the **One Time Boot Menu**.
12. Type the BIOS setup program filename and press **Enter**.
The **BIOS Update Utility** appears.
13. Follow the on-screen instructions to complete the BIOS update.

Updating the BIOS from the One-Time boot menu

To update the BIOS from the One-Time boot menu, see [Updating the BIOS from the One Time Boot Menu](#) at [Dell Support Site](#).

System and setup password

CAUTION: The password features provide a basic level of security for the data on your computer.

CAUTION: Ensure that your computer is locked when it is not in use. Anyone can access the data that is stored on your computer, when left unattended.

Table 41. System and setup password

Password type	Description
System password	Password that you must enter to boot to your operating system.
Setup password	Password that you must enter to access and change the BIOS settings of your computer.

You can create a system password and a setup password to secure your computer.

 **NOTE:** The System and setup password feature is disabled by default.

Assigning a System Setup password

Prerequisites

You can assign a new System or Admin Password only when the status is set to **Not Set**. To enter BIOS System Setup, press F2 immediately after a power-on or reboot.

Steps

1. To enter the **System Setup**, press **F2** immediately after a power-on or reboot.
2. In the **System BIOS** or **System Setup** screen, select **Security** and press Enter.
The **Security** screen is displayed.
3. Select **System/Admin Password** and create a password in the **Enter the new password** field.
Use the following guidelines to create the system password:
 - Password can be up to 32 characters.
 - Password must contain at least one special character: "(! " # \$ % & ' * + , - . / : ; < = > ? @ [\] ^ _ ` { | })"
 - The password can contain numbers from 0 to 9.
 - The password can contain alphabets A to Z and a to z.
4. Type the system password that you entered earlier in the **Confirm new password** field and click **OK**.
5. Press Y to save the changes.
The computer restarts.

Deleting or changing an existing system password or setup password

Prerequisites

Ensure that the **Password Status** is Unlocked in the System Setup before attempting to delete or change the existing system password and/or setup password. You cannot delete or change an existing system password or setup password if the **Password Status** is Locked. To enter the System Setup, press F2 immediately after a power-on or reboot.

Steps

1. To enter the **System Setup**, press **F2** immediately after a power-on or reboot.
2. In the **System BIOS** or **System Setup** screen, select **System Security** and press Enter.
The **System Security** screen is displayed.
3. In the **System Security** screen, verify that the **Password Status** is Unlocked.
4. Select **System Password**. Update or delete the existing system password, and press Enter or Tab.
5. Select **Setup Password**. Update or delete the existing setup password, and press Enter or Tab.
 **NOTE:** If you change the system password and/or setup password, reenter the new password when prompted. If you delete the system password and/or setup password, confirm the deletion when prompted.
6. Press Esc. A message prompts you to save the changes.
7. Press Y to save the changes and exit from **System Setup**.
The computer restarts.

Clearing CMOS settings

About this task

 **CAUTION:** Clearing CMOS settings will reset the BIOS settings on your computer.

Steps

1. Follow the pre-requisites and procedures in [Removing the coin-cell battery](#).
2. Wait for one minute.
3. Follow the procedures and post-requisites in [Installing the coin-cell battery](#).

Clearing system and setup passwords

About this task

To clear the system or setup passwords, contact Dell technical support as described at [Contact Support](#).

 **NOTE:** For information about how to reset Windows or application passwords, see the documentation accompanying Windows or your application.

Troubleshooting

Dell SupportAssist Pre-boot System Performance Check diagnostics

About this task

SupportAssist diagnostics (also known as system diagnostics) performs a complete check of your hardware. The Dell SupportAssist Pre-boot System Performance Check diagnostics is embedded within the BIOS and launched by the BIOS internally. The embedded system diagnostics provides options for particular devices or device groups allowing you to:

- Run tests automatically or in an interactive mode.
- Repeat the tests.
- Display or save test results.
- Run thorough tests to add more options and obtain details about any failed devices.
- View status messages that inform you when the tests are completed successfully.
- View error messages that inform you of problems encountered during testing.

NOTE: Some tests for specific devices require user interaction. Always ensure that you are present at the computer when the diagnostic tests are performed.

For more information, see [How to Run Dell Preboot Diagnostics and Hardware Tests on Your Dell Computer](#).

Running the SupportAssist Pre-Boot System Performance Check

Steps

1. Turn on your computer.
2. As the computer boots, press the F12 key.
3. On the boot menu screen, select **Diagnostics**.
The diagnostic quick test begins.

NOTE: For more information about running the SupportAssist Pre-Boot System Performance Check on a specific device, see [Dell Support Site](#).

4. If there are any issues, error codes are displayed.
Note the error code and validation number and contact Dell.

Power-Supply Unit Built-in Self-Test

Built-in Self-Test (BIST) helps determine if the power-supply unit is working. To run self-test diagnostics on the power-supply unit of a desktop or all-in-one computer, search in the Knowledge Base Resource at [Dell Support Site](#).

System-diagnostic lights

This section lists the system-diagnostic lights of your Dell Pro 24 All-in-One QC24250.

Table 42. System-diagnostic lights

Blinking pattern		Problem description
Amber	White	
1	1	TPM detection failure

Table 42. System-diagnostic lights (continued)

Blinking pattern		Problem description
Amber	White	
1	2	Unrecoverable SPI Flash Failure
1	5	EC unable to program i-Fuse
1	6	Generic catch-all for ungraceful EC code flow errors
2	1	CPU failure
2	2	System board failure (included BIOS corruption or ROM error)
2	3	No memory/RAM detected
2	4	Memory/RAM failure
2	5	Invalid memory installed
2	6	System board/Chipset Error
2	7	LCD failure (SBIOS message)
2	8	LCD failure (EC detection of power rail failure)
3	1	CMOS battery failure
3	2	PCI or Video card/chip failure
3	3	BIOS Recovery image not found
3	4	BIOS Recovery image found but invalid
3	5	Power rail failure
3	6	Flash corruption detected by SBIOS.
3	7	Timeout waiting on ME to reply to HECI message.

Recovering the operating system

When your computer is unable to boot to the operating system even after repeated attempts, it automatically starts Dell SupportAssist OS Recovery.

Dell SupportAssist OS Recovery is a stand-alone tool that is preinstalled on Dell computers running the Windows operating system. It consists of tools to diagnose and troubleshoot issues that may occur before your computer boots to the operating system. It enables you to diagnose hardware issues, repair your computer, back up your files, and restore your computer to its factory state.

You can also download it from the Dell Support website to troubleshoot and fix your computer when it fails to boot into the primary operating system due to software or hardware failures.

For more information about the Dell SupportAssist OS Recovery, see *Dell SupportAssist OS Recovery User's Guide* at [Serviceability Tools at the Dell Support Site](#). Click **SupportAssist** and then click **SupportAssist OS Recovery**.

NOTE: Windows 11 IoT Enterprise LTSC 2024 and Dell ThinOS 10 do not support Dell SupportAssist. For more information about recovering ThinOS 10, see [Recovery mode using R-Key](#).

Real-Time Clock—RTC reset

The Real-Time Clock (RTC) reset function allows you or the service technician to recover the recently launched model Dell Pro and Pro Max computers from **No POST/No Boot/No Power** situations. You can initiate the RTC reset on the computer from

a power-off state only if it is connected to AC power. Press and hold the power button for 25 seconds. The system RTC reset occurs after you release the power button.

i **NOTE:** If AC power is disconnected from the computer during the process or the power button is held longer than 40 seconds, the RTC reset process gets aborted.

The RTC reset will reset the BIOS to its default settings, disable Intel vPro, and reset the computer date and time. The following items are not affected by the RTC reset:

- Service Tag
- Asset Tag
- Ownership Tag
- Admin Password
- System Password
- Storage Password
- Key Databases
- System Logs

i **NOTE:** The IT administrator's vPro account and password on the computer will be unprovisioned. The computer must go through the setup and configuration process again to reconnect it to the vPro server.

The below items may or may not be reset based on your custom BIOS setting selections:

- Boot List
- Enable Legacy Option ROMs
- Secure Boot Enable
- Allow BIOS Downgrade

Backup media and recovery options

It is recommended to create a recovery drive to troubleshoot and fix problems that may occur with Windows. Dell provides multiple options for recovering the Windows operating system on your Dell computer. For more information, see [Dell Windows Backup Media and Recovery Options](#).

Network power cycle

About this task

If your computer is unable to access the Internet due to network connectivity issues, reset your network devices by performing the following steps:

Steps

1. Turn off the computer.
2. Turn off the modem.

i **NOTE:** Some Internet service providers (ISPs) provide a modem and router combo device.

3. Turn off the wireless router.
4. Wait for 30 seconds.
5. Turn on the wireless router.
6. Turn on the modem.
7. Turn on the computer.

Getting help and contacting Dell

Self-help resources

You can get information and help on Dell products and services using these self-help resources:

Table 43. Self-help resources

Self-help resources	Resource location
Information about Dell products and services	Dell Site
Contact Support	In Windows search, type <code>Contact Support</code> , and press Enter.
Online help for operating system	Windows Support Site Linux Support Site
Access top solutions, diagnostics, drivers and downloads, and learn more about your computer through videos, manuals, and documents.	Your Dell computer is uniquely identified using a Service Tag or Express Service Code. To view relevant support resources for your Dell computer, enter the Service Tag or Express Service Code at Dell Support Site . For more information about how to find the Service Tag for your computer, see Locate the Service Tag on your computer .
Dell knowledge base articles	<ol style="list-style-type: none"> 1. Go to Dell Support Site. 2. On the menu bar at the top of the Support page, select Support > Support Library. 3. In the Search field on the Support Library page, type the keyword, topic, or model number, and then click or tap the search icon to view the related articles.

Contacting Dell

To contact Dell for sales, technical support, or customer service issues, see [Dell Support Site](#).

 **NOTE:** Availability of the services may vary depending on the country or region, and product.

 **NOTE:** If you do not have an active Internet connection, you can find contact information in your purchase invoice, packing slip, bill, or Dell product catalog.

Revision history

Tracks all updates that are made to the document. It typically includes the date of change, version number, and a brief description of the modification. This log helps maintain transparency, accountability, and a clear timeline of progress.

Table 44. Revision history

Revision	Date	Description
A02	April 2026	Added Quebec requirement information.
A01	October 2025	Updated average speed in Audio.
A00	March 2025	Original publish date.