

Dell Pro 14 Plus/Dell Pro 14 Plus 2-in-1

PB14255/PB14255 2-in-1

Owner's Manual

Notes, cautions, and warnings

 **NOTE:** A NOTE indicates important information that helps you make better use of your product.

 **CAUTION:** A CAUTION indicates either potential damage to hardware or loss of data and tells you how to avoid the problem.

 **WARNING:** A WARNING indicates a potential for property damage, personal injury, or death.

Chapter 1: Views of Dell Pro 14 Plus/Dell Pro 14 Plus 2-in-1	8
Right	8
Left	9
Top	10
Front	11
Bottom	12
Modes	13
Battery-charge status light	14
Service Tag	14
Chapter 2: Set up your Dell Pro 14 Plus/Dell Pro 14 Plus 2-in-1	16
Chapter 3: Specifications of Dell Pro 14 Plus/Dell Pro 14 Plus 2-in-1	18
Dimensions and weight	18
Processor	18
Chipset	19
Operating system	20
Memory	20
External ports and slots	20
Internal slots	21
Ethernet	21
Wireless module	22
WWAN module	22
Audio	24
Storage	24
Keyboard	24
Keyboard function keys of Dell Pro 14 Plus/Dell Pro 14 Plus 2-in-1	25
Camera (optional)	27
Touchpad	27
Fingerprint reader (optional)	28
Power adapter	28
Power adapter requirements (computers shipped with 3-cell, 45 Wh battery)	29
Power adapter requirements (computers shipped with 3-cell, 55 Wh battery)	29
Battery	30
Power requirements (for computers shipped with 3-cell, 45 Wh battery)	31
Power requirements (for computers shipped with 3-cell, 55 Wh battery)	32
Display	32
Hardware security	34
GPU—Integrated	34
Smart-card reader	35
Contactless smart card reader	35
Contacted smart card reader	38
Operating and storage environment	39
Dell support policy	40

Chapter 4: Working inside your computer.....	41
Safety instructions.....	41
Before working inside your computer.....	41
Safety precautions.....	42
Electrostatic discharge—ESD protection.....	42
ESD Field Service kit	43
Transporting sensitive components.....	44
After working inside your computer.....	44
Information on reparability for Québec - From Dell Canada Inc. - to Quebec consumers.....	44
BitLocker.....	44
Recommended tools.....	45
Screw list.....	45
Major components of Dell Pro 14 Plus/Dell Pro 14 Plus 2-in-1.....	46
Chapter 5: Removing and installing Customer Replaceable Units (CRUs).....	49
SIM-card tray (optional).....	49
Removing the SIM-card tray (optional).....	49
Installing the SIM-card tray (optional).....	50
Base cover.....	51
Removing the base cover.....	51
Installing the base cover.....	54
Battery.....	57
Battery.....	57
Rechargeable Li-ion battery precautions.....	57
Removing the battery.....	57
Installing the battery.....	58
Battery cable.....	59
Removing the battery cable.....	59
Installing the battery cable.....	60
Wireless Wide Area Network (WWAN) card.....	61
Removing the 5G WWAN card.....	61
Installing the 5G WWAN card.....	62
Removing the 4G WWAN card.....	63
Installing the 4G WWAN card.....	64
Solid State Drive (SSD).....	66
Removing the M.2 2230 solid state drive.....	66
Installing the M.2 2230 solid state drive.....	67
Removing the M.2 2280 solid state drive.....	68
Installing the M.2 2280 solid state drive.....	68
Speakers.....	69
Removing the speakers.....	69
Installing the speakers.....	70
Chapter 6: Removing and installing Field Replaceable Units (FRUs).....	72
Fan.....	72
Removing the fan	72
Installing the fan.....	73
Heat sink.....	74

Removing the heat sink	74
Installing the heat sink.....	75
USH board.....	76
Removing the USH board.....	76
Installing the USH board	77
Smart card reader.....	78
Removing the smart card reader	78
Installing the smart card reader	80
System board.....	81
Removing the system board.....	81
Installing the system board	84
Wireless Local Area Network (WLAN) antenna modules.....	87
Removing the WLAN antenna modules.....	87
Installing the WLAN antenna modules.....	88
USB Type-C connector module.....	90
Removing the USB Type-C connector module.....	90
Installing the USB Type-C connector module.....	91
I/O board.....	92
Removing the I/O board.....	92
Installing the I/O board.....	94
Power-button with optional fingerprint reader.....	95
Removing the power button with optional fingerprint reader.....	95
Installing the power button with optional fingerprint reader.....	96
Display assembly.....	97
Removing the display assembly	97
Installing the display assembly	99
Display bezel.....	101
Removing the display bezel	101
Installing the display bezel	106
Display panel.....	108
Removing the display panel.....	108
Installing the display panel.....	111
Display hinge caps.....	114
Removing the display hinge caps	114
Installing the display hinge caps	115
RGB/IR camera.....	117
Removing the RGB/IR camera.....	117
Installing the RGB/IR camera.....	118
MIPI camera.....	120
Removing the MIPI camera.....	120
Installing the MIPI camera.....	121
Display cable for RGB/IR camera.....	122
Removing the display cable for RGB/IR camera	122
Installing the display cable for RGB/IR camera.....	123
Display cable for MIPI camera.....	125
Removing the display cable for MIPI camera.....	125
Installing the display cable for MIPI camera.....	126
Middle-board cable.....	127
Removing the middle-board cable	127
Installing the middle-board cable	128

Middle board.....	129
Removing the middle board	129
Installing the middle board	130
Display back-cover and antenna assembly.....	131
Removing the display back-cover and antenna assembly.....	131
Installing the display back-cover and antenna assembly	132
Keyboard.....	133
Removing the keyboard.....	133
Installing the keyboard.....	135
Palm-rest assembly.....	137
Removing the palm-rest assembly.....	137
Installing the palm-rest assembly.....	138
Chapter 7: Software.....	140
Operating system.....	140
Drivers and downloads.....	140
Chapter 8: BIOS Setup.....	141
Entering BIOS Setup program.....	141
Navigation keys.....	141
F12 One Time Boot menu.....	141
View Advanced Setup options.....	142
View Service options.....	142
BIOS Setup options.....	142
Updating the BIOS.....	156
Updating the BIOS in Windows.....	156
Updating the BIOS in Linux and Ubuntu.....	157
Updating the BIOS using the USB drive in Windows.....	157
Updating the BIOS from the One-Time boot menu.....	158
System and setup password.....	158
Assigning a System Setup password.....	158
Deleting or changing an existing system password or setup password.....	159
Clearing system and setup passwords.....	159
Chapter 9: Troubleshooting.....	160
Handling swollen rechargeable Li-ion batteries.....	160
Dell SupportAssist Pre-boot System Performance Check diagnostics.....	160
Running the SupportAssist Pre-Boot System Performance Check.....	161
Built-in self-test (BIST).....	161
Motherboard Built-In Self-Test (M-BIST).....	161
Logical Built-in Self-test (L-BIST).....	162
LCD Built-in Self-Test (LCD-BIST).....	162
System-diagnostic lights.....	162
Recovering the operating system.....	163
Real-Time Clock (RTC Reset).....	164
Backup media and recovery options.....	164
Network power cycle.....	164
Drain flea power (perform hard reset).....	164
LAN connectivity issue with Dell Pro Smart Docks and Thunderbolt Docks.....	165

Chapter 10: Getting help and contacting Dell.....	166
Chapter 11: Revision history.....	167

Views of Dell Pro 14 Plus/Dell Pro 14 Plus 2-in-1

2-in-1

Right

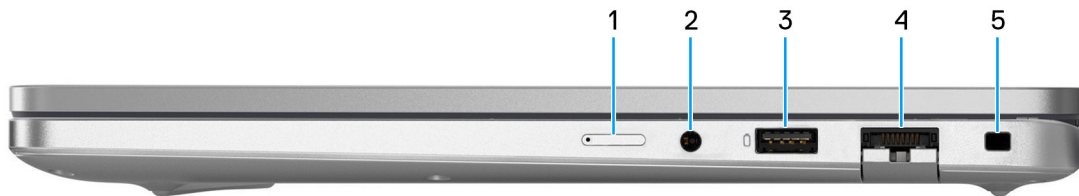

Figure 1. Right view of Dell Pro 14 Plus/Dell Pro 14 Plus 2-in-1

1. Nano-SIM card slot (optional)

Insert a nano-SIM card to connect to a mobile broadband network.

NOTE: Availability of the nano-SIM card slot depends on the region and configuration ordered.

2. Global headset jack

Connect headphones or a headset (headphone and microphone combo).

3. USB 3.2 Gen 1 port with PowerShare

Connect devices such as external storage devices and printers. It provides data transfer speeds up to 5 Gbps. PowerShare enables you to charge your USB devices even when your computer is turned off.

NOTE: If your computer is turned off or in a hibernate state, you must connect the power adapter to charge your devices using the PowerShare port. You must enable this feature in the BIOS setup program.

NOTE: Certain USB devices may not charge when the computer is turned off or in a sleep state. In such cases, turn on the computer to charge the device.

4. Optional RJ45 ethernet port (1 Gbps)

Connect an RJ45 ethernet cable from a router or a broadband modem for network or Internet access, with a transfer rate of 10/100/1000 Mbps (maximum 1 Gbps).

5. Security-cable slot (wedge-shaped)

Connect a security cable to prevent unauthorized movement of your computer.

Left

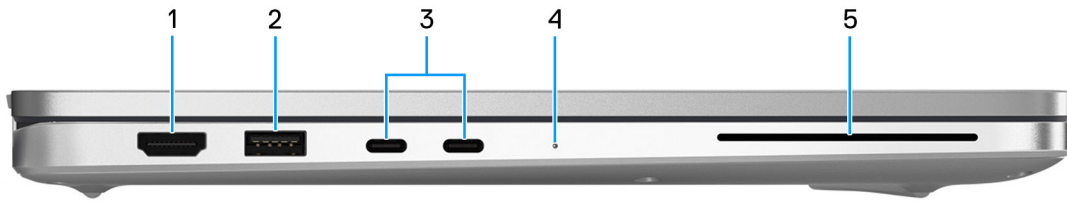

Figure 2. Left view of Dell Pro 14 Plus/Dell Pro 14 Plus 2-in-1

1. HDMI 2.1 TMDS port

Connect to a TV, external display or another HDMI-in enables device. Provides video and audio output.

2. USB 3.2 Gen 1 port

Connect devices such as external storage devices and printers. Provides data transfer rate of up to 5 Gbps.

3. Thunderbolt 4.0 (40 Gbps) with DisplayPort Alt Mode/USB Type-C/USB4/Power Delivery ports

Supports USB4, DisplayPort 2.1, Thunderbolt 4 and also enables you to connect to an external display using a display adapter. Provides data transfer rates of up to 40 Gbps for USB4 and Thunderbolt 4.

NOTE: You can connect a Dell Docking Station to these ports. For more information, search in the Knowledge Base Resource at [Dell Support Site](#).

NOTE: A USB Type-C to DisplayPort adapter (sold separately) is required to connect a DisplayPort device.

NOTE: USB4 is backward compatible with USB 3.2, USB 2.0, and Thunderbolt 3.

NOTE: Thunderbolt 4 supports two 4K displays or one 8K display.

NOTE: For 8K monitors, AMD Ryzen AI series support maximum resolution 7680 x 4320, 60 Hz, with Display Stream Compression. For 4K monitors, AMD Ryzen series support maximum resolution 3840 x 2160, 240 Hz, with Display Stream Compression.

NOTE: The AMD Ryzen 200 Series processors support DisplayPort version 1.4a, whereas the AMD Ryzen AI 300 Series processors are compatible with DisplayPort version 2.1.

4. Battery-charge status light

Indicates the battery-charge status.

- Solid white — Battery is charging.
- Solid amber — Battery charge is low.
- Off — Battery is fully charged.

5. Smart card reader slot (optional)

Using smart card provides authentication in corporate networks.

Top

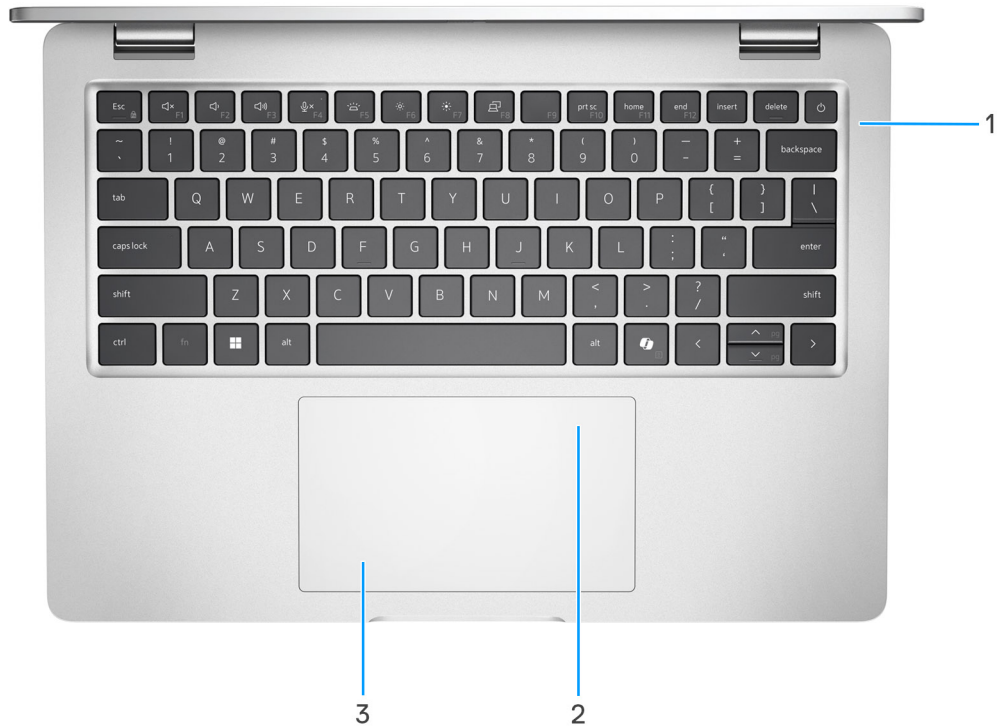

Figure 3. Top view of Dell Pro 14 Plus/Dell Pro 14 Plus 2-in-1

1. Power button with optional fingerprint reader

Press to turn on the computer if it is turned off, in sleep state, or in hibernate state.

NOTE: When the computer is turned on, press the power button to put the computer into sleep state; press and hold the power button for 10 seconds to force shut-down the computer.

NOTE: You can customize the power-button behavior in Windows.

2. NFC/Contactless smart card reader (optional)

Enables NFC-enabled devices to connect to your computer and supports data transfer across the devices.

3. Touchpad

Move your finger on the touchpad to move the mouse pointer. Tap to left-click, and tap with two fingers to right-click.

Front

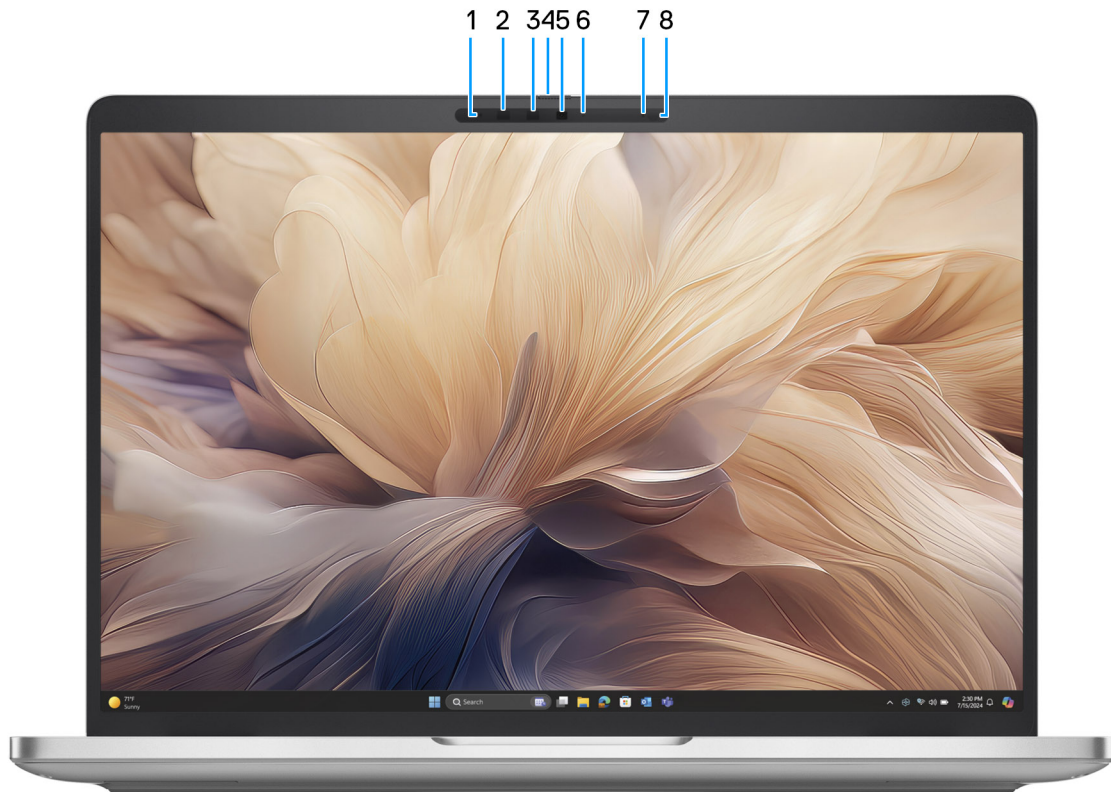

Figure 4. Front view of Dell Pro 14 Plus/Dell Pro 14 Plus 2-in-1

1. Left microphone

Provides digital sound input for audio recording and voice calls.

2. Infrared camera (optional)

Enhances security when paired with Windows Hello face authentication.

3. Infrared emitter (optional)

Emits infrared light, which enables the infrared camera to sense and track motion.

4. Camera shutter

Slide the privacy shutter to the left to access the camera lens.

5. Camera

A camera enables you to video chat, capture photos, and record videos.

6. Camera-status light

Turns on when the camera is in use.

7. Right microphone

Provides digital sound input for audio recording and voice calls.

8. Ambient-light sensor (optional)

The sensor detects the ambient light and automatically adjusts the display brightness.

Bottom

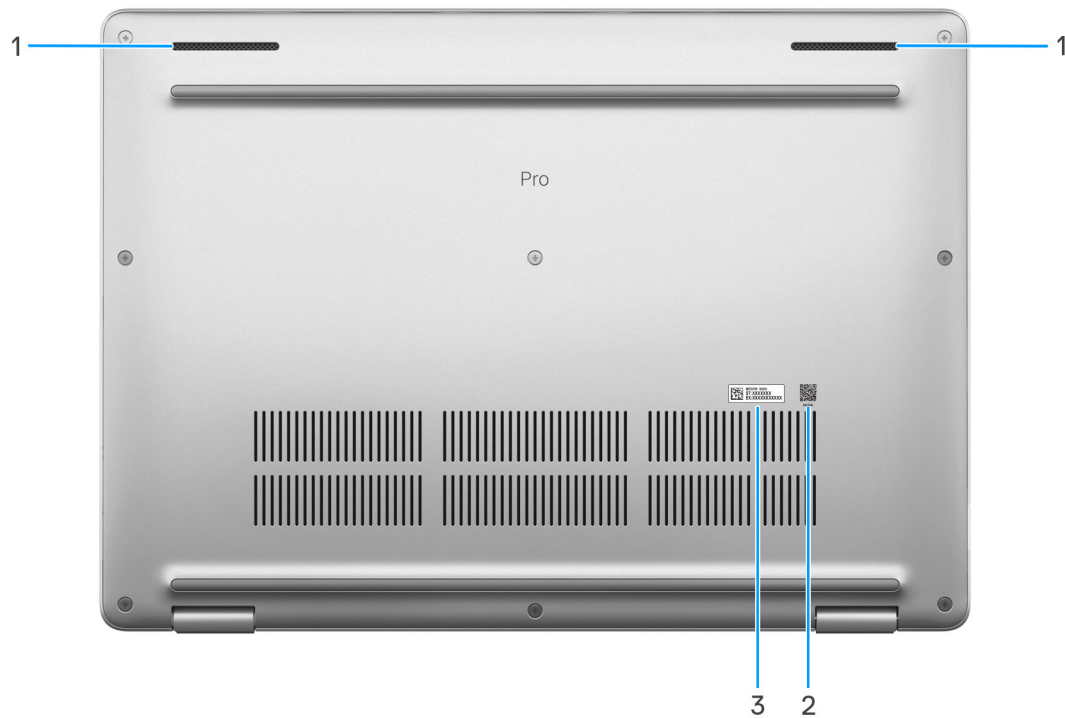

Figure 5. Bottom view of Dell Pro 14 Plus/Dell Pro 14 Plus 2-in-1

1. Speakers

Provide audio output.

2. MyDell QR Code

MyDell is your hub for content personalized to your Dell Pro 14 Plus/Dell Pro 14 Plus 2-in-1, including videos, articles, manuals, and easy access to support.

3. Service Tag label

The Service Tag is a unique alphanumeric identifier that enables Dell service technicians to identify the hardware components in your computer and access warranty information.

Modes

The following modes are supported only on Dell Pro 14 Plus 2-in-1 configuration.

Notebook



Figure 6. Notebook mode

Tablet



Figure 7. Tablet Mode

Stand



Figure 8. Stand mode

Tent



Figure 9. Tent mode

Battery-charge status light

The following table lists the battery-charge status light of your Dell Pro 14 Plus/Dell Pro 14 Plus 2-in-1.

Table 1. Battery-charge status light behavior

Power source	LED behavior	System power state	Battery charge level
AC adapter	Off	S0 or S5	Fully charged
AC adapter	Solid white	S0 or S5	< Fully charged
Battery	Off	S0 or S5	11-100%
Battery	Solid amber (590+/-3 nm)	S0 or S5	< 10%

- S0 (ON): Computer is turned on.
- S4 (Hibernate): The computer consumes the least power in the Hibernate state than in the ON or OFF state. The computer is almost in the OFF state. The context data is written to a storage device, allowing you to resume from where you left when the computer is turned on.
- S5 (OFF): The computer is in a shutdown state.

Service Tag

The service tag is a unique alphanumeric identifier that allows Dell service technicians to identify the hardware components in your computer and access warranty information.

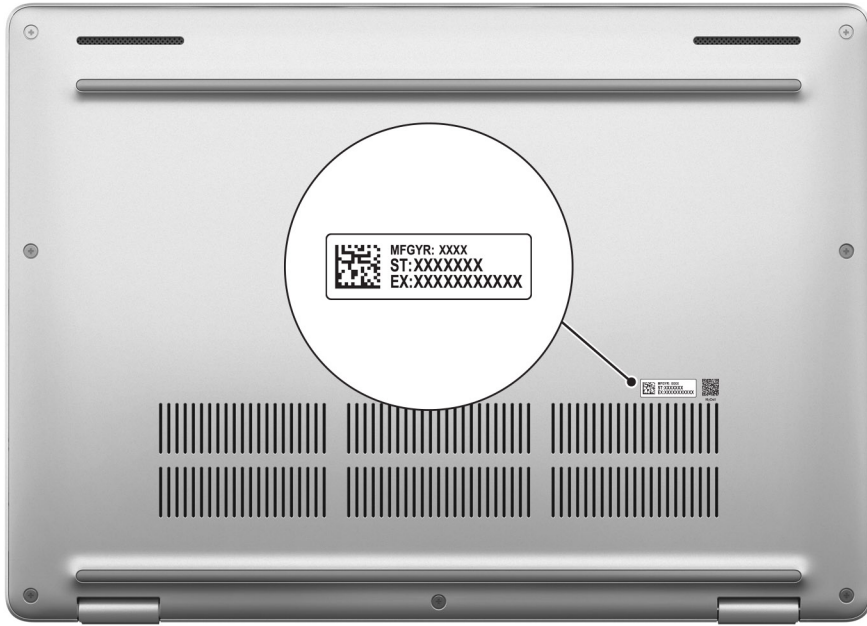

Figure 10. Service tag location

Set up your Dell Pro 14 Plus/Dell Pro 14 Plus 2-in-1

About this task

NOTE: The images in this document may differ from your computer depending on the configuration you ordered.

Steps

1. Connect the power adapter and press the power button.



Figure 11. Connect the power adapter and press the power button

NOTE: The battery may go into power-saving mode during shipment to conserve charge on the battery. Ensure that the power adapter is connected to your computer when it is turned on for the first time.

2. Finish the operating system setup.

For Ubuntu:

Follow the on-screen instructions to complete the setup. For more information about installing and configuring Ubuntu, search in the Knowledge Base Resource at [Dell Support Site](#).

For Windows:

Follow the on-screen instructions to complete the setup. When setting up, it is recommended that you:





- Connect to a network for Windows updates.

NOTE: If connecting to a secured wireless network, enter the password for the wireless network access when prompted.

- If connected to the Internet, sign-in with an existing Microsoft account or create an account. If not connected to the Internet, create an offline account.

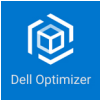
- On the **Support and Protection** screen, enter your contact details.
3. Locate and use Dell apps from the Windows Start menu—Recommended.

Table 2. Locate Dell apps

Resources	Description
	<p>Dell Optimizer is an application that is designed to enhance computer performance and productivity by optimizing settings for power, battery, display, collaboration touchpad, and presence detection. It also provides access to applications purchased with your new computer.</p> <p>For more information, see Dell Optimizer User's Guide at Dell Support Site.</p>
	<p>Dell Product Registration</p> <p>Register your computer with Dell.</p>
	<p>Dell Help & Support</p> <p>Access help and support for your computer.</p>
	<p>SupportAssist</p> <p>SupportAssist is a proactive and predictive technology that offers automated technical support for Dell computers. It proactively monitors both hardware and software, addressing performance issues, preventing security threats, and automating engagement with Dell Technical Support.</p> <p>For more information, see SupportAssist documentation at Dell Support Site.</p> <p>NOTE: In SupportAssist, click the warranty expiry date to renew or upgrade your warranty.</p>

Specifications of Dell Pro 14 Plus/Dell Pro 14 Plus 2-in-1

Dimensions and weight

The following table lists the height, width, depth, and weight of your Dell Pro 14 Plus/Dell Pro 14 Plus 2-in-1.

Table 3. Dimensions and weight

Description	400 nits thin & light non-touch screen laptop	300 nits touch screen and non-touch screen laptop/400 nits touch screen and non-touch screen laptop	300 nits touch screen 2-in-1	500 nits touch screen laptop
Height:				
Front height	19.78 mm (0.78 in.)	19.50 mm (0.77 in.)	19.92 mm (0.78 in.)	19.50 mm (0.77 in.)
Rear height	19.77 mm (0.77 in.)	19.98 mm (0.79 in.)	20.17 mm (0.79 in.)	19.98 mm (0.79 in.)
Maximum height	19.95 mm (0.79 in.)	21.20 mm (0.83 in.)	20.25 mm (0.80 in.)	21.20 mm (0.83 in.)
Width	313.50 mm (12.34 in.)	313.50 mm (12.34 in.)	313.50 mm (12.34 in.)	313.50 mm (12.34 in.)
Depth	224.00 mm (8.82 in.)	224.00 mm (8.82 in.)	224.00 mm (8.82 in.)	224.00 mm (8.82 in.)
Weight (maximum) NOTE: The weight of your computer depends on the configuration ordered and manufacturing variability.	1.43 kg (3.15 lb)	1.56 kg (3.44 lb)	1.59 kg (3.51 lb)	1.50 kg (3.31 lb)

Processor

The following table lists the details of the processors that are supported in your Dell Pro 14 Plus/Dell Pro 14 Plus 2-in-1.

Table 4. Processor (For computers shipped with AMD Ryzen AI 300 series)

Description	Option one	Option two	Option three
Processor type	AMD Ryzen AI 5 PRO 340	AMD Ryzen AI 7 PRO 350	AMD Ryzen AI 9 HX PRO 370
Configurable Thermal Design Power (cTDP)	15 W–54 W	15 W–54 W	15 W–54 W
Thermal Mode/Thermal Design Power (TDP)			
Optimized	17 W	17 W	17 W
Performance	19 W	19 W	19 W
Processor core count	6	8	12
Processor thread count	12	16	24

Table 4. Processor (For computers shipped with AMD Ryzen AI 300 series) (continued)

Description	Option one	Option two	Option three
Processor speed	Up to 4.8 GHz	Up to 5.0 GHz	Up to 5.1 GHz
Processor cache L2	6 MB	8 MB	12 MB
Processor cache L3	16 MB	16 MB	24 MB
Integrated graphics	AMD Radeon 840M Graphics	AMD Radeon 860M Graphics	AMD Radeon 890M Graphics
Neural Processing Units (NPU) Performance	Up to 50 TOPS	Up to 50 TOPS	Up to 50 TOPS

Table 5. Processor (For computers shipped with AMD Ryzen 200 series)

Description	Option one	Option two	Option three	Option four	Option five	Option six
Processor type	AMD Ryzen 3 210	AMD Ryzen 5 220	AMD Ryzen 5 PRO 215	AMD Ryzen 5 PRO 220	AMD Ryzen 5 PRO 230	AMD Ryzen 7 PRO 250
Configurable Thermal Design Power (cTDP)	15 W–30 W	15 W–30 W	15 W–30 W	15 W – 30 W	15 W–30 W	15 W–30 W
Thermal Mode/Thermal Design Power (TDP)						
Optimized	17 W	17 W	17 W	17 W	17 W	17 W
Performance	19 W	19 W	19 W	19 W	19 W	19 W
Processor core count	4	6	6	6	6	8
Processor thread count	8	12	12	12	12	16
Processor speed	Up to 4.7 GHz	Up to 4.9 GHz	Up to 4.7 GHz	Up to 4.9 GHz	Up to 4.9 GHz	Up to 5.1 GHz
Processor cache L2	4 MB	6 MB	6 MB	6 MB	6 MB	8 MB
Processor cache L3	8 MB	16 MB	16 MB	16 MB	16 MB	16 MB
Integrated graphics	AMD Radeon 740M Graphics	AMD Radeon 740M Graphics	AMD Radeon 740M Graphics	AMD Radeon 740M Graphics	AMD Radeon 760M Graphics	AMD Radeon 780M Graphics
Neural Processing Units (NPU) Performance	Not applicable	Not applicable	Not applicable	Not applicable	Up to 16 TOPS	Up to 16 TOPS

Chipset

The following table lists the details of the chipset that is supported by your Dell Pro 14 Plus/Dell Pro 14 Plus 2-in-1.

Table 6. Chipset

Description	Values
Chipset	Integrated in the processor
Processor	<ul style="list-style-type: none"> • AMD Ryzen 3/5 • AMD Ryzen 5/7 PRO • AMD Ryzen AI 5/7 PRO • AMD Ryzen AI 9 HX PRO
DRAM bus width	64-bit
Flash EPROM	64 MB

Table 6. Chipset (continued)

Description	Values
PCIe bus	Up to Gen4

Operating system

Your Dell Pro 14 Plus/Dell Pro 14 Plus 2-in-1 supports the following operating systems:

- Windows 11 Home
- Windows 11 Pro
- Windows 10 Home
- Windows 10 Pro
- Ubuntu Linux 24.04 LTS

i **NOTE:** Ubuntu is supported only on Dell Pro 14 Plus.

i **NOTE:** If you downgrade your computer from Windows 11 to Windows 10 22H2, Dell Technologies support follows the Microsoft Windows 10 End of Support plan.

i **NOTE:** Windows 10 Home and Windows 10 Pro is supported only on computers shipped with AMD Ryzen 200 series processors.

Memory

The following table lists the memory specifications of your Dell Pro 14 Plus/Dell Pro 14 Plus 2-in-1.

Table 7. Memory specifications

Description	Values
Memory slots	On-board memory i NOTE: The memory is integrated on the system board and is not upgradeable.
Memory type	LPDDR5X
Memory speed	7500 MT/s
Maximum memory configuration	64 GB
Minimum memory configuration	16 GB
Memory configurations supported	<ul style="list-style-type: none"> • 16 GB: LPDDR5X, 7500 MT/s • 32 GB: LPDDR5X, 7500 MT/s • 64 GB: LPDDR5X, 7500 MT/s

External ports and slots

The following table lists the external ports and slots on your Dell Pro 14 Plus/Dell Pro 14 Plus 2-in-1.

Table 8. External ports and slots

Description	Values
Network port	One optional RJ45 ethernet port (1 Gbps)

Table 8. External ports and slots (continued)

Description	Values
USB ports	<ul style="list-style-type: none"> Two Thunderbolt 4.0 (40 Gbps) with DisplayPort Alt Mode/USB Type-C/USB4/Power Delivery ports <p>i NOTE: You can connect a Dell Docking Station to these ports. For more information, search in the Knowledge Base Resource at Dell Support Site.</p> <ul style="list-style-type: none"> One USB 3.2 Gen 1 (5 Gbps) port with PowerShare One USB 3.2 Gen 1 (5 Gbps) port
Audio port	One Global headset jack
Video port(s)	One HDMI 2.1 TMDS port
Media-card reader	One smart card reader slot (optional)
Power-adaptor port	USB Type-C power input
Security-cable slot	One wedge-shaped security slot
SIM-card slot	One Nano-SIM card slot (optional)

Internal slots

The following table lists the internal slots of your Dell Pro 14 Plus/Dell Pro 14 Plus 2-in-1.

Table 9. Internal slots

Description	Values
M.2	<ul style="list-style-type: none"> One M.2 2230 or M.2 2280 solid-state drive slot One M.2 3042 for 4G WWAN slot (optional) <p>i NOTE: To learn more about the features of different types of M.2 cards, search Dell Support Site.</p>

Ethernet

Table 10. Ethernet specifications

Description	Values
Model number	<ul style="list-style-type: none"> Realtek RTL8111EPP Integrated 10/100/1000M ethernet controller DASH configuration Realtek RTL8111HS Integrated 10/100/1000M ethernet controller Non-DASH configuration
Transfer rate	10/100/1000 Mbps

Wireless module

The following table lists the Wireless Local Area Network (WLAN) module that is supported on your Dell Pro 14 Plus/Dell Pro 14 Plus 2-in-1.

Table 11. Wireless module specifications

Description	Values
Model number	MediaTek MT7925 i NOTE: The wireless module is integrated on the system board.
Transfer rate	Up to 2882 Mbps
Frequency bands supported	2.4 GHz/5 GHz/6 GHz
Wireless standards	<ul style="list-style-type: none"> • Wi-Fi 802.11a/b/g • Wi-Fi 4 (Wi-Fi 802.11n) • Wi-Fi 5 (Wi-Fi 802.11ac) • Wi-Fi 6E (Wi-Fi 802.11ax) • Wi-Fi 7 (Wi-Fi 802.11be)
Encryption	<ul style="list-style-type: none"> • 128-bit AES-CCMP • 256-bit AES-GCMP • 256-GMAC
Bluetooth wireless card i NOTE: The functionality of the Bluetooth wireless card may vary based on the operating system.	Bluetooth 5.4 wireless card

WWAN module



The following table lists the Wireless Wide Area Network (WWAN) modules that are supported in your Dell Pro 14 Plus/Dell Pro 14 Plus 2-in-1.

- i** **NOTE:** The WWAN module is available only on certain configurations and in certain regions.
- i** **NOTE:** Availability of the eSIM feature on this module may vary depending on your region and the support that is offered by your mobile carrier.
- i** **NOTE:** For instructions on how to setup SIM or eSIM connections on your computer, see the *SIM/eSIM Setup Guide for Windows* available with your product documentation at [Dell Support Site](#).

Table 12. WWAN module specifications

Description	Option one	Option two
Model number	DW5826e, Qualcomm Snapdragon SDX12 Global LTE-Advanced, CAT12	DW5934e Qualcomm Snapdragon X72 Global 5G Modem
Form factor	M.2 3042 Key-B	M.2 3052 Key-B
Host interface	USB 3.0/2.0	PCIe Gen3
Network standard	<ul style="list-style-type: none"> • LTE FDD/TDD • WCDMA • GPS/BDS/GLONASS/Galileo/BeiDou/QZSS 	<ul style="list-style-type: none"> • NR FR1 (Sub6) FDD/TDD • LTE FDD/TDD • WCDMA/HSPA+ • GPS/GLONASS/Galileo/BeiDou

Table 12. WWAN module specifications (continued)

Description	Option one	Option two
Transfer data rate	<ul style="list-style-type: none"> ● Up to 600 Mbps DL(CAT12) ● Up to 150 Mbps UL 	<ul style="list-style-type: none"> ● 5G NR: DL 4.14Gbps/ UL 900Mbps ● LTE: DL 2.0Gbps (CAT20)/ UL 211Mbps (CAT18) ● UMTS: DL DC-HSPA+ Rel8:42 Mbps / UL 5.76 Mbps
Operating frequency bands	<ul style="list-style-type: none"> ● LTE (B1, B2, B3, B4, B5, B7, B8, B12, B13, B14, B18, B19, B20, B25, B26, B28, B29, B32, B38, B39, B40, B41, B42, B43, B48, B66, B71) ● WCDMA (1, 2, 4, 5, 6, 8, 9, 19) 	<ul style="list-style-type: none"> ● NR (n1, n2, n3, n5, n7, n8, n12, n13, n14, 18, n20, n25, n26, n28, n29, n30, n38, n40, n41, n48, n66, n67, n70, n71, n75, n76, n77, n78, n79, n91, n92, n93, n94) ● LTE (B1, B2, B3, B4, B5, B7, B8, B12, B13, B14, B17, B18, B19, B20, B25, B26, B28, B29, B30, B32, B34, B38, B39, B40, B41, B42, B43, B46, B48, B66, B67, B68, B70, B71) ● WCDMA/HSPA+ (1, 2, 4, 5, 8)
Power supply	DC 3.135 V to 4.4 V, Typical 3.3 V	DC 3.135V to 3.63V, typical 3.3V
SIM card	Supported through external SIM slot	Supported through external SIM slot
eSIM with dual SIM (DSSA)	Supported  NOTE: The availability of eSIM functionality embedded on the module is dependent on the region and specific carrier requirements.	Supported (The availability of eSIM functionality embedded on the module is dependent on the region and specific carrier requirements)
Antenna diversity	Supported	Supported
Radio on/off	Supported	Supported
Wake on wireless WAN	Supported	Not supported
Operating temperature	<ul style="list-style-type: none"> ● Normal operating temperature: – 30°C to +70°C ● Extended operating temperature: – 40°C to +85°C ● Storage temperature: –40°C to +85°C 	<ul style="list-style-type: none"> ● Normal operating temperature: – 30°C to +70°C ● Extended operating temperature: – 40°C to +85°C ● Storage temperature: –40°C to +85°C
Antenna connector	<ul style="list-style-type: none"> ● WWAN Main Antenna x 1 ● WWAN Diversity Antenna x 1 	<ul style="list-style-type: none"> ● WWAN Main Antenna X 1 ● WWAN Diversity Antenna X 1 ● 4 x 4 MIMO Antenna x 2
 NOTE: For instructions to find your computer's International Mobile Equipment Identity (IMEI) number, search Dell Support Site .		

Audio

The following table lists the audio specifications of your Dell Pro 14 Plus/Dell Pro 14 Plus 2-in-1.

Table 13. Audio specifications

Description		Values
Audio controller		Realtek ALC3329 SoundReal
Stereo conversion		Supported
Internal audio interface		Soundwire interface
External audio interface		Global headset jack
Number of speakers		Two
Internal-speaker amplifier		Not supported
External volume controls		Keyboard shortcut controls
Speaker output:		
	Average	2 W
	Peak	2.5 W
Microphone		Digital-array microphones

Storage

This section lists the storage options on your Dell Pro 14 Plus/Dell Pro 14 Plus 2-in-1.

Your computer supports one of the following solid state drive.

Table 14. Storage specifications

Storage type	Interface type	Capacity
M.2 2280 solid state drive, self-encrypting drive	PCIe Gen4 NVMe, up to 64 Gbps	Up to 2 TB
M.2 2230 solid state drive	PCIe Gen4 NVMe, up to 64 Gbps	Up to 1 TB



Keyboard

The following table lists the keyboard specifications of your Dell Pro 14 Plus/Dell Pro 14 Plus 2-in-1.

Table 15. Keyboard specifications

Description	Values
Keyboard lighting technology	<ul style="list-style-type: none">• Standard non-backlit keyboard• Standard backlit keyboard
Keyboard layout	QWERTY

Table 15. Keyboard specifications (continued)

Description	Values
Number of keys	<ul style="list-style-type: none"> Arabic, English International, English US, Thai, French (Canadian), Canada Bilingual (MUI), Chinese Traditional, Greek, Hebrew, Korean, Russian, and Ukrainian: 79 keys Portuguese Iberian, English UK, Belgian, Bulgarian, Czech/Slovak (MUI), Danish, Estonian, French European, German, Hungarian, Icelandic, Italian, Nordic (MUI), Norwegian, Spanish (Castilian), Swedish/Finnish, Swiss/European (MUI), Turkish, Turkish (F), Slovenian, Spanish (Latin America): 80 keys Portuguese (Brazil): 81 keys French Canadian Quebec (ACNOR): 81 keys Japanese: 83 keys
Key pitch	X=19.05 mm key pitch Y=18.05 mm key pitch
Keyboard shortcuts	<p>Some keys on your keyboard have two symbols on them. These keys can be used to type alternate characters or to perform secondary functions. To type the alternate character, press Shift and the desired key. To perform secondary functions, press Fn and the desired key.</p> <p> NOTE: Press Fn+Esc to switch the primary behavior of the function keys (F1-F12) between two modes - multimedia key mode and function key mode.</p> <p> NOTE: You can define the primary behavior of the function keys (F1-F12) by changing Function Key Behavior in BIOS setup program.</p> <p>For more information, see Keyboard function keys.</p>

Keyboard function keys of Dell Pro 14 Plus/Dell Pro 14 Plus 2-in-1

 **NOTE:** Keyboard characters may differ depending on the keyboard language configuration. Keys that are used for shortcuts remain the same across all language configurations.

Some keys on your keyboard have two symbols on them. These keys can be used to type alternate characters or to perform secondary functions. The symbol that is shown on the lower part of the key refers to the character that is typed out when the key is pressed. If you press shift and the key, the symbol that is shown on the upper part of the key is typed out. For example, if you press **2**, 2 is typed out; if you press **Shift + 2**, @ is typed out.

The keys F1-F12 at the top row of the keyboard are function keys for multimedia control, as indicated by the icon on the key. Press the function key to enable the task represented by the icon. For example, pressing F1 mutes the audio (see the table below).

However, if the function keys F1-F12 are needed for specific software applications, multimedia functionality can be disabled by pressing **fn + Esc**. Later, multimedia control can be invoked by pressing **fn** and the respective function key. For example, mute audio by pressing **fn + F1**.

 **NOTE:** You can also define the primary behavior of the function keys (F1–F12) by changing **Function Key Behavior** in the BIOS setup program.

Table 16. Function key primary behavior

Function key	Primary behavior
F1	Mute or unmute audio
F2	Decrease volume
F3	Increase volume

Table 16. Function key primary behavior (continued)

Function key	Primary behavior
F4	Mute or unmute microphone
F5	Turn on or turn off backlit keyboard (optional). <i>i</i> NOTE: Non-backlit keyboards have the F10 function key without the backlit icon and do not support the toggle backlit keyboard function. <i>i</i> NOTE: Toggle the backlit keyboard status through off, low, and high.
F6	Decrease display brightness
F7	Increase display brightness
F8	Switch to external display
F10	Print screen
F11	Home
F12	End
Copilot	Launch Copilot in Windows <i>i</i> NOTE: If Copilot in Windows is not available on your computer, the Copilot key launches Windows Search. For more information about Copilot in Windows, search in the Knowledge Base Resource at the Dell Support Site .

The **fn** key is also used with selected keys on the keyboard to invoke secondary functions.

Table 17. Secondary behavior

Function key	Secondary behavior
fn + F1	Operating system and application-specific F1 behavior
fn + F2	Operating system and application-specific F2 behavior
fn + F3	Operating system and application-specific F3 behavior
fn + F4	Operating system and application-specific F4 behavior
fn + F5	Operating system and application-specific F5 behavior
fn + F6	Operating system and application-specific F6 behavior
fn + F7	Operating system and application-specific F7 behavior
fn + F8	Operating system and application-specific F8 behavior
fn + F10	Operating system and application-specific F10 behavior
fn + F11	Operating system and application-specific F11 behavior
fn + F12	Operating system and application-specific F12 behavior
fn + Copilot	Context menu behavior
fn + Esc	Toggle Function key lock
fn + PgUp (cursor up)	Scroll up the document or page
fn + PgDn (cursor down)	Scroll down the document or page
fn + P	Toggle privacy screen

Camera (optional)

The following table lists the camera specifications of your Dell Pro 14 Plus/Dell Pro 14 Plus 2-in-1

NOTE: These specifications are applicable only for computers shipped with a camera module.

Table 18. Camera specifications

Description		Values
Number of cameras		One
Camera type		<ul style="list-style-type: none"> FHD RGB HDR camera FHD RGB-IR HDR camera 5MP RGB-IR MIPI HDR camera
Camera location		Front
Camera sensor type		CMOS sensor technology
Camera resolution:		
	Still image	<ul style="list-style-type: none"> 2.07 megapixels 5.20 megapixels
	Video	<ul style="list-style-type: none"> 1920 x 1080 at 30 fps 2560 x 1440 at 30 fps
Infrared camera resolution:		
	Still image	0.23 megapixels
	Video	640 x 360 at 15 fps
Diagonal viewing angle:		
	Camera	<ul style="list-style-type: none"> 80.20 degrees 91.20 degrees
	Infrared camera	86.60 degrees

Touchpad

The following table lists the touchpad specifications of your Dell Pro 14 Plus/Dell Pro 14 Plus 2-in-1.

Table 19. Touchpad specifications

Description		Values
Touchpad resolution:		>=300dpi
Touchpad dimensions:		
	Horizontal	124.40 mm (4.90 in.)
	Vertical	72.40 mm (2.85 in.)
Touchpad gestures		For more information about the touchpad gestures that are available on: <ul style="list-style-type: none"> Windows, search Microsoft Support Site. Ubuntu, search Ubuntu Support Site.

Fingerprint reader (optional)

The following table lists the specifications of the optional fingerprint-reader of your Dell Pro 14 Plus/Dell Pro 14 Plus 2-in-1.

Table 20. Fingerprint reader specifications

Description	Values
Sensor technology	Trans-capacitive sensing
Sensor resolution	500 dpi
Sensor pixel size	<ul style="list-style-type: none"> • X: 108 • Y: 88

Power adapter

The following table lists the power adapter specifications of your Dell Pro 14 Plus/Dell Pro 14 Plus 2-in-1.

Table 21. Power adapter specifications

Description	Option one	Option two	Option three	
Type	60 W Blackchin adapter, USB-C	65 W Pecos adapter, USB-C	100 W Miami Beach adapter, USB-C	
Power-adapter dimensions:				
	Height	22 mm (0.87 in.)	28 mm (1.10 in.)	26.50 mm (1.04 in.)
	Width	55 mm (2.16 in.)	51 mm (2.01 in.)	60 mm (2.36 in.)
	Depth	66 mm (2.60 in.)	112 mm (4.41 in.)	122 mm (4.80 in.)
Input voltage	100 VAC to 240 VAC	100 VAC to 240 VAC	100 VAC to 240 VAC	
Input frequency	50 Hz to 60 Hz	50 Hz to 60 Hz	50 Hz to 60 Hz	
Input current (maximum)	1.70 A	1.70 A	1.70 A	
Output current (continuous)	<ul style="list-style-type: none"> • 20 V/3 A (continuous) • 15 V/3 A (continuous) • 9 V/3 A (continuous) • 5 V/3 A (continuous) 	<ul style="list-style-type: none"> • 20 V/3.25 A (continuous) • 15 V/3 A (continuous) • 9 V/3 A (continuous) • 5 V/3 A (continuous) 	<ul style="list-style-type: none"> • 20 V/5 A (continuous) • 15 V/3 A (continuous) • 9 V/3 A (continuous) • 5 V/3 A (continuous) 	
Rated output voltage	<ul style="list-style-type: none"> • 20 VDC • 15 VDC • 9 VDC • 5 VDC 	<ul style="list-style-type: none"> • 20 VDC • 15 VDC • 9 VDC • 5 VDC 	<ul style="list-style-type: none"> • 20 VDC • 15 VDC • 9 VDC • 5 VDC 	
Temperature range:				
	Operating	0°C to 40°C (32°F to 104°F)	0°C to 40°C (32°F to 104°F)	0°C to 35°C (32°F to 95°F)

Table 21. Power adapter specifications (continued)

Description		Option one	Option two	Option three
	Storage	-20°C to 70°C (-4°F to 158°F)	-40°C to 70°C (-40°F to 158°F)	-40°C to 70°C (-40°F to 158°F)
 CAUTION: Operating and storage temperature ranges may differ among components, so operating or storing the device outside these ranges may impact the performance of specific components.				

Power adapter requirements (computers shipped with 3-cell, 45 Wh battery)

This section contains the power adapter requirements for the Dell Pro 14 Plus/Dell Pro 14 Plus 2-in-1.





 **NOTE:** If you did not purchase the Dell-branded power adapter that is recommended for your computer, ensure that the power adapter you use meets the following requirements:

Table 22. Power adapter requirements for Dell Pro 14 Plus/Dell Pro 14 Plus 2-in-1

Description	Value
Power that is required from a power adapter to achieve optimal performance.	65 W
Power that is required to charge the computer at a slower speed.  NOTE: A warning message may appear informing you about the use of a lower-powered adapter and slower charging speed.	Less than 60 W
Minimum power that is required from a power adapter to operate the computer and charge the battery.  NOTE: A warning message appears informing you about the use of a lower-powered adapter and slower charging speed.	45 W
USB Power Delivery (PD) fast charging	Supported
ExpressCharge mode	Supported  NOTE: The ExpressCharge mode is supported only when the computer with a 45 Wh battery is connected to a power adapter rated at 65 W or higher.

Power adapter requirements (computers shipped with 3-cell, 55 Wh battery)

This section contains the power adapter requirements for the Dell Pro 14 Plus/Dell Pro 14 Plus 2-in-1.

 **NOTE:** If you did not purchase the Dell-branded power adapter that is recommended for your computer, ensure that the power adapter you use meets the following requirements:

Table 23. Power adapter requirements for Dell Pro 14 Plus/Dell Pro 14 Plus 2-in-1

Description	Value
Power that is required from a power adapter to achieve optimal performance.	100 W
Power that is required to charge the computer at a slower speed.	Less than 60 W

Table 23. Power adapter requirements for Dell Pro 14 Plus/Dell Pro 14 Plus 2-in-1 (continued)

Description	Value
<p>i NOTE: A warning message may appear informing you about the use of a lower-powered adapter and slower charging speed.</p>	
<p>Minimum power that is required from a power adapter to operate the computer and charge the battery.</p> <p>i NOTE: A warning message appears informing you about the use of a lower-powered adapter and slower charging speed.</p>	45 W
USB Power Delivery (PD) fast charging	Supported
ExpressCharge mode	<p>Supported</p> <p>i NOTE: The ExpressCharge mode is supported only when the computer with a 55 Wh battery is connected to a power adapter rated at 65 W or higher.</p>

Battery

The following table lists the battery specifications of your Dell Pro 14 Plus/Dell Pro 14 Plus 2-in-1.

Table 24. Battery specifications

Description	Option one	Option two	Option three	Option four
Battery type	3-cell, 45 Wh, ExpressCharge, ExpressCharge Boost	3-cell, 55 Wh, ExpressCharge, ExpressCharge Boost	3-cell, 45 Wh, Long Life Cycle, ExpressCharge, ExpressCharge Boost	3-cell, 55 Wh, Long Life Cycle, ExpressCharge, ExpressCharge Boost
Battery voltage	11.25 VDC	11.70 VDC	11.25 VDC	11.70 VDC
Battery weight (minimum)	0.20 kg (0.44 lb)	0.22 kg (0.48 lb)	0.20 kg (0.44 lb)	0.22 kg (0.48 lb)
Battery dimensions:				
	Height	72.80 mm (2.83 in.)	72.80 mm (2.83 in.)	72.80 mm (2.83 in.)
	Width	254.80 mm (10.03 in.)	254.80 mm (10.03 in.)	254.80 mm (10.03 in.)
	Depth	6.30 mm (0.25 in.)	6.30 mm (0.25 in.)	6.30 mm (0.25 in.)
Temperature range:				
	Operating	<ul style="list-style-type: none"> Charge: 0°C to 45°C (32°F to 113°F) Discharge: 0°C to 70°C (32°F to 158°F) 	<ul style="list-style-type: none"> Charge: 0°C to 45°C (32°F to 113°F) Discharge: 0°C to 70°C (32°F to 158°F) 	<ul style="list-style-type: none"> Charge: 0°C to 45°C (32°F to 113°F) Discharge: 0°C to 70°C (32°F to 158°F)
	Storage	-20°C to 65°C (-4°F to 149°F)	-20°C to 65°C (-4°F to 149°F)	-20°C to 65°C (-4°F to 149°F)
Battery operating time	Varies depending on operating conditions and can	Varies depending on operating conditions and can	Varies depending on operating conditions and can	Varies depending on operating conditions and can

Table 24. Battery specifications (continued)

Description	Option one	Option two	Option three	Option four
	significantly reduce under certain power-intensive conditions.	significantly reduce under certain power-intensive conditions.	significantly reduce under certain power-intensive conditions.	significantly reduce under certain power-intensive conditions.
<p>Battery charging time (approximate)</p> <p>i NOTE: Control the charging time, duration, start and end time, and so on using the Dell Power Manager application. For more information about Dell Power Manager, search in the Knowledge Base Resource at Dell Support Site.</p>	<p>Standard charge/ Predominately AC User Charge Method:</p> <ul style="list-style-type: none"> 0°C to 15°C maximum allowable charge time from 0% to 100% RSOC is 4 hours 16°C to 45°C maximum allowable charge time from 0% to 100% RSOC is 3 hours <p>Express Charge Method:</p> <ul style="list-style-type: none"> 16°C to 45°C maximum allowable charge time from 0% to 80% RSOC is 1 hour 16°C to 45°C maximum allowable charge time from 0% to 100% RSOC is 2 hours <p>Express Charge Boost charge Method:</p> <ul style="list-style-type: none"> 16°C to 45°C maximum allowable charge time from 0% to 35% RSOC is 20 min 	<p>Standard charge/ Predominately AC User Charge Method:</p> <ul style="list-style-type: none"> 0°C to 15°C maximum allowable charge time from 0% to 100% RSOC is 4 hours 16°C to 45°C maximum allowable charge time from 0% to 100% RSOC is 3 hours <p>Express Charge Method:</p> <ul style="list-style-type: none"> 16°C to 45°C maximum allowable charge time from 0% to 80% RSOC is 1 hour 16°C to 45°C maximum allowable charge time from 0% to 100% RSOC is 2 hours <p>Express Charge Boost charge Method:</p> <ul style="list-style-type: none"> 16°C to 45°C maximum allowable charge time from 0% to 35% RSOC is 20 min 	<p>Standard charge/ Predominately AC User Charge Method:</p> <ul style="list-style-type: none"> 0°C to 15°C maximum allowable charge time from 0% to 100% RSOC is 4 hours 16°C to 45°C maximum allowable charge time from 0% to 100% RSOC is 3 hours <p>Express Charge Method:</p> <ul style="list-style-type: none"> 16°C to 45°C maximum allowable charge time from 0% to 80% RSOC is 1 hour 16°C to 45°C maximum allowable charge time from 0% to 100% RSOC is 2 hours <p>Express Charge Boost charge Method:</p> <ul style="list-style-type: none"> 16°C to 45°C maximum allowable charge time from 0% to 35% RSOC is 20 min 	<p>Standard charge/ Predominately AC User Charge Method:</p> <ul style="list-style-type: none"> 0°C to 15°C maximum allowable charge time from 0% to 100% RSOC is 4 hours 16°C to 45°C maximum allowable charge time from 0% to 100% RSOC is 3 hours <p>Express Charge Method:</p> <ul style="list-style-type: none"> 16°C to 45°C maximum allowable charge time from 0 to 80% RSOC is 1 hour 16°C to 45°C maximum allowable charge time from 0 to 100% RSOC is 2 hours <p>Express Charge Boost charge Method:</p> <ul style="list-style-type: none"> 16°C to 45°C maximum allowable charge time from 0% to 35% RSOC is 20 min
Coin-cell battery	Not supported	Not supported	Not supported	Not supported
<p>⚠ CAUTION: Operating and storage temperature ranges may differ among components, so operating or storing the device outside these ranges may impact the performance of specific components.</p> <p>⚠ CAUTION: Dell recommends that you charge the battery regularly for optimal power consumption. If your battery charge is completely depleted, connect the power adapter, turn on your computer, and then restart your computer to reduce the power consumption.</p>				

Power requirements (for computers shipped with 3-cell, 45 Wh battery)

i **NOTE:** The information in this section is applicable to the European Union (EU) countries.

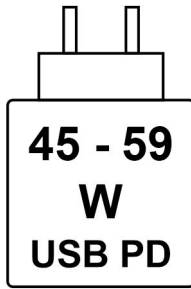

Figure 12. Pictogram for power charging requirements

The power that is delivered by the charger must be between a minimum of 45 Watts that is required by the radio equipment, and a maximum of 59 Watts in order to achieve the maximum charging speed.

This computer supports USB Power Delivery (PD) fast charging.

Power requirements (for computers shipped with 3-cell, 55 Wh battery)

NOTE: The information in this section is applicable to the European Union (EU) countries.

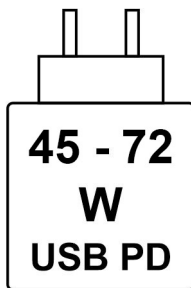

Figure 13. Pictogram for power charging requirements

The power that is delivered by the charger must be between a minimum of 45 Watts that is required by the radio equipment, and a maximum of 72 Watts in order to achieve the maximum charging speed.

This computer supports USB Power Delivery (PD) fast charging.

Display

The following table lists the display specifications of your Dell Pro 14 Plus/Dell Pro 14 Plus 2-in-1.

Table 25. Display specifications

Description	Option one	Option two	Option three	Option four	Option five	Option six	Option seven	Option eight
Display type	14-inch Full High Definition (FHD+)	14-inch Full High Definition (FHD+)	14-inch (QHD+)	14-inch Full High Definition (FHD+) NOTE: For 2-in-1 laptops only.	14-inch Full High Definition (FHD+)	14-inch Full High Definition (FHD+) NOTE: For laptops only.	14-inch Full High Definition Plus (FHD+) NOTE: For laptops only.	14-inch Full High Definition Plus (FHD+) NOTE: For laptops only.

Table 25. Display specifications (continued)

Description	Option one	Option two	Option three	Option four	Option five	Option six	Option seven	Option eight
Touch options	No	Yes	No	Yes	No	Yes	No	Yes
Privacy option	No	No	No	No	No	Yes	No	No
Anti-glare vs glossy finish	Anti-glare	Anti-glare	Anti-glare	Anti-reflection	Anti-glare	Anti-glare	Anti-glare	Anti-glare
Display-panel technology	Wide Viewing Angle (WVA)	Wide Viewing Angle (WVA)	Wide Viewing Angle (WVA)	Wide Viewing Angle (WVA)	Wide Viewing Angle (WVA)	In-Plane Switching (IPS)	In-Plane Switching (IPS)	In-Plane Switching (IPS)
Display-panel dimensions (active area):								
Height	188.50 mm (7.42 in.)	188.50 mm (7.42 in.)	188.50 mm (7.42 in.)	188.50 mm (7.42 in.)	188.50 mm (7.42 in.)	188.50 mm (7.42 in.)	188.50 mm (7.42 in.)	188.50 mm (7.42 in.)
Width	301.59 mm (11.87 in.)	301.59 mm (11.87 in.)	301.59 mm (11.87 in.)	301.59 mm (11.87 in.)	301.59 mm (11.87 in.)	301.59 mm (11.87 in.)	301.59 mm (11.87 in.)	301.59 mm (11.87 in.)
Diagonal	355.60 mm (14 in.)	355.60 mm (14 in.)	355.60 mm (14 in.)	355.60 mm (14 in.)	355.60 mm (14 in.)	355.60 mm (14 in.)	355.60 mm (14 in.)	355.60 mm (14 in.)
Display-panel native resolution	1920 x 1200	1920 x 1200	2560 x 1600	1920 x 1200	1920 x 1200	1920 x 1200	1920 x 1200	1920 x 1200
Luminance (typical)	300 nits	300 nits	300 nits	300 nits	400 nits	500 nits	400 nits	400 nits
Megapixels	2.3	2.3	4.1	2.3	2.3	2.3	2.3	2.3
Color gamut	45% NTSC	100% sRGB	100% sRGB	100% sRGB	100% sRGB	100% sRGB	45% NTSC	100% sRGB
Pixels Per Inch (PPI)	162	162	215.6	162	162	162	162	162
Contrast ratio (typical)	800:1	800:1	1200:1	1200:1	1200:1	1500:1	800:1	800:1
Response time (maximum)	35 ms	35 ms	35 ms	35 ms	35 ms	35 ms	35 ms	35 ms
Refresh rate	60 Hz	60 Hz	<ul style="list-style-type: none"> • 90 Hz • 120 Hz 	60 Hz	30 Hz to 60 Hz	60 Hz	60 Hz	60 Hz
Horizontal view angle	+/- 80 degrees (min)	+/- 80 degrees (min)	+/- 80 degrees (min)	+/- 88 degrees (min)	+/- 88 degrees (min)	+/- 80 degrees (minimum)	+/- 80 degrees (minimum)	+/- 80 degrees (minimum)
Vertical view angle	+/- 80 degrees (min)	+/- 80 degrees (min)	+/- 80 degrees (min)	+/- 88 degrees (min)	+/- 88 degrees (min)	+/- 80 degrees (minimum)	+/- 80 degrees (minimum)	+/- 80 degrees (minimum)
Pixel pitch	0.157 mm	0.157 mm	0.157 mm	0.157 mm	0.157 mm	0.157 mm	0.157 mm	0.157 mm

Table 25. Display specifications (continued)

Description	Option one	Option two	Option three	Option four	Option five	Option six	Option seven	Option eight
Power consumption (maximum)	3.68 W	4.40 W	<ul style="list-style-type: none"> 4.63 W (for panels with 90 Hz refresh rate) 4.80 W (for panels with 120 Hz refresh rate) 	3.10 W	2.50 W	<ul style="list-style-type: none"> Sharing mode: 7.14 W Privacy mode: 7.18 W 	4.64 W	5.50 W
 NOTE: The refresh rate for QHD+ display panel varies depending on the configuration ordered.								

Hardware security

The following table lists the hardware security of your Dell Pro 14 Plus/Dell Pro 14 Plus 2-in-1.

Table 26. Hardware security

Hardware security
Noble Lock
Trusted Platform Module (TPM) 2.0 discrete
FIPS 140-2 certification for TPM
TCG Certification for TPM (Trusted Computing Group)
Touch fingerprint reader in the power button available with ControlVault 3+
Contacted Smart Card with ControlVault 3+
Contactless Smart Card and NFC with ControlVault 3+
SED SSD NVMe, SSD and HDD (Opal and non-Opal) per SDL
Chassis Intrusion Detection
BIOS - TPM clear and/or system boot lock after chassis intrusion detection

GPU—Integrated

The following table lists the specifications of the integrated Graphics Processing Unit (GPU) supported by your Dell Pro 14 Plus/Dell Pro 14 Plus 2-in-1.

Table 27. GPU—Integrated

Controller	Memory size	Processor
AMD Radeon 740M Graphics	Shared system memory	<ul style="list-style-type: none"> AMD Ryzen 3 210 AMD Ryzen 5 220 AMD Ryzen 5 PRO 220
AMD Radeon 760M Graphics	Shared system memory	AMD Ryzen 5 PRO 230

Table 27. GPU—Integrated (continued)

Controller	Memory size	Processor
AMD Radeon 780M Graphics	Shared system memory	AMD Ryzen 7 PRO 250
AMD Radeon 840M Graphics	Shared system memory	AMD Ryzen AI 5 PRO 340
AMD Radeon 860M Graphics	Shared system memory	AMD Ryzen AI 7 PRO 350
AMD Radeon 890M Graphics	Shared system memory	AMD Ryzen AI 9 HX PRO 370

Smart-card reader

Contactless smart card reader

This section lists the contactless smart card reader specifications of your Dell Pro 14 Plus/Dell Pro 14 Plus 2-in-1. This module is only available in computers shipped with smart card readers.

Table 28. Contactless smart card reader specifications

Title	Description	Dell ControlVault 3 Plus Contactless smart card reader with NFC
FeliCa Card Support	Reader and software capable of supporting FeliCa contactless cards	Yes
Prox (Proximity) (125 KHz) Card support	Reader and software capable of supporting Prox/Proximity/125 KHz contactless cards	No
ISO 14443 Type A Card Support	Reader and software capable of supporting ISO 14443 Type A contactless cards	Yes
ISO 14443 Type B Card Support	Reader and software capable of supporting ISO 14443 Type B contactless cards	Yes
ISO/IEC 21481	Reader and software capable of supporting ISO/IEC 21481 compliant contactless cards and tokens	Yes
ISO/IEC 18092	Reader and software capable of supporting ISO/IEC 18092 compliant contactless cards and tokens	Yes
ISO 15693 Card Support	Reader and software capable of supporting ISO15693 contactless cards	Yes
NFC Tag Support	Supports reading and processing of NFC compliant tag information	Yes
NFC Reader Mode	Support for NFC Forum Defined Reader mode	Yes
NFC Writer Mode	Support for NFC Forum Defined Writer mode	Yes
NFC Peer-to-Peer Mode	Support for NFC Forum Defined Peer to Peer mode	Yes
NFC Proximity OS Interface	Enumerates NFP (Near Field Proximity) device for operating system to utilize	Yes
PC/SC operating system interface	Personal Computer/Smart Card specification for integration of hardware	Yes

Table 28. Contactless smart card reader specifications (continued)

Title	Description	Dell ControlVault 3 Plus Contactless smart card reader with NFC
	readers into personal computer environments	
CCID driver compliance	Common driver support for Integrated Circuit Card Interface Device for operating system level drivers	Yes
Dell ControlVault support	The device connects to Dell ControlVault for usage and processing	Yes

i | **NOTE:** 125 KHz proximity cards are not supported.

Table 29. Contactless card types supported

Interface	Card type	Supported functionality
NFC Forum (Microsoft Proximity Device)	Type 1 tag	Read/Write NDEF
	Type 2 tag	Read/Write NDEF
	Type 3 tag	Read/Write NDEF
	Type 4 tag	Read/Write NDEF
	Type 5 tag	Read/Write NDEF
	P2P	Exchange NDEF
RFID (Microsoft Smartcard Device)	ISO14443A	Read UUID and APDU Exchange (ISO7816)
	ISO14443B	Read UUID and APDU Exchange (ISO7816)
	Sony FeliCa	Read UUID only
	Legacy iClass (ISO15693)	Read UUID only
	MIFARE Classic	Read UUID only
	Low Frequency (125 KHz)	Not supported

Table 30. Supported cards

Manufacturer	Card
HID	JCOP readertest3 A card (14443a)
	1430 1L
	MIFARE DESFire D8H
	DESFIRE 4K Standard - 1450NGGNN
	iClass 16K/16 - 2002PGGMN
	iClass SR 16K/16 - 2002HPGGMN
	iCLASS 2K tag
	iCLASS GP - 2003 PGGMN
	iClass Clamshell - 2080PMSMV
	iClass Prox 16K/16 - 2022BGGMNN
	MIFARE M1P 1430 NGGNN
	iclass Prox 2020BGGMNM

Table 30. Supported cards (continued)

Manufacturer	Card
	DesFire D8P 1456CSGMN
	iCLASS MIFARE Px GM49Y 2623BNPGGBNAB
	iCLASS MIFARE Px 8M1L
	iClass SEOS JW 5006PGGMN
	Crescendo iCLASS Px G8H
	iCLASS Seos IY
	SEOS JMC4 J1Y 5806VNG1NNN4
	SEOS Key FOB 5266PNNA
	SEOS Clamshell 5656PMSAV
	SEOS + Prox 5106RGGMNN
	SEOS + DESFire 5906PNG1ANN7
	SEOS iClass 5006PGGMN7
	Seos Essential + Prox 551PPGGANN
	iCLASS 2K 2000PGGMN
	iCLASS 2K 3000PGGMN
	MIFARE DESFire 3700CPGGAN
	iCLASS DP
	DESFire 1Y
NXP/Mifare	MIFARE DESFire 8K White PVC card
	MIFARE Classic 1K White PVC card
	NXP Mifare Classic S50 ISO card
	MIFARE DESFire 2K
	MIFARE Plus S 2K/4K
	MIFARE Plus X 4K
G&D	idOnDemand - SCE3.2 144K
	SCE6.0 FIPS 80K Dual + 1K MIFARE
	SCE6.0 nonFIPS 80K Dual + 1K MIFARE
	SCE6.0 FIPS 144K Dual + 1K MIFARE
	SCE6.0 nonFIPS 144K Dual + 1K MIFARE
	SCE7.0 FIPS 144K
Oberthur	idOnDemand - OCS5.2 80K
	ID-One Cosmo 64 RSA D V5.4 T = 0 card
	ID-One Cosmo 128K V5.5 card
Gemalto	TOP DL GX4 144K card
Sony	FeliCa RC-S962
	FeliCa RC-S965
	FeliCa RC-S966

Table 30. Supported cards (continued)

Manufacturer	Card
PIVKey	C910 PKI
NIST	PIV1
IDENTIV	PIV programmed cards
	uTrust
Transport cards	Oyster (London) MIFARE DESFire
	T-Money (Korea)
	Octopus Card (Hong Kong)
	SUICA (Japan)

Table 31. Qualified NFC tags

NFC tag	Supported
Tap and do - NFC Forum Type 1 Tag - Topaz 512 (BCM920203)	Yes
Tap and do - NFC Forum Type 1 Tag - Topaz 512 (BCM20203T512)	Yes
Tap and do - NFC Forum Type 1 Tag - Topaz (BCM20203T96)	Yes
Tap and do - NFC Forum Type 2 Tag - MIFARE UltraLight	Yes
Tap and do - NFC Forum Type 2 Tag - MIFARE UltraLight C	Yes
Tap and do - NFC Forum Type 2 Tag - NTAG203	Yes
Tap and do - NFC Forum Type 3 Tag - FeliCa Lite RC-S965	Yes
Tap and do - NFC Forum Type 3 Tag - FeliCa RC-S962	Yes
Tap and do - NFC Forum Type 4 Tag - MIFARE DESFire EV1Card 2K	Yes
Tap and do - NFC Forum Type 4 Tag - MIFARE DESFire EV1Card 4K	Yes
Tap and do - NFC Forum Type 4 Tag - MIFARE DESFire EV1Card 8K	Yes
Tap and do - ISO 15693 - Tag-it Plus	Yes
HID I-code ISO card	Yes

Contacted smart card reader

The following table lists the contacted smart card reader specifications of your Dell Pro 14 Plus/Dell Pro 14 Plus 2-in-1.

Table 32. Contacted smart card reader specifications

Title	Description	Dell ControlVault 3 Plus Contacted smart card reader
ISO 7816-3 Class A Card Support	Reader capable of reading 5 V powered smart card	Yes
ISO 7816-3 Class B Card Support	Reader capable of reading 3 V powered smart card	Yes
ISO 7816-3 Class C Card support	Reader capable of reading 1.8 V powered smart card	Yes

Table 32. Contacted smart card reader specifications (continued)

Title	Description	Dell ControlVault 3 Plus Contacted smart card reader
T = 0 support	Cards support character level transmission	Yes
T = 1 support	Cards support block level transmission	Yes
EMVCo Certified	Formally certified based on EMVCo smart card standards	Yes
PC/SC operating system interface	Personal Computer/Smart Card specification for integration of hardware readers into personal computer environments	Yes
CCID driver compliance	Common driver support for Integrated Circuit Card Interface Device for operating system level drivers	Yes
Windows Certified	Certified by the Windows Hardware Certification program	Yes
FIPS 201 (PIV/HSPD-12) Compliant	Device compliant with FIPS 201/PIV/HSPD-12 requirements	Yes
ISO 7816-1 Compliant	Specification for the physical characteristics of integrated circuit cards with contacts	Yes
ISO 7816-2 Compliant	Specification for the dimensions and location of the contacts	Yes
ISO 7816-3 Compliant	Specification for electrical interface and transmission protocols	Yes
ISO 7816-4 Compliant	Specification for organization, security and commands for interchange	Yes
Dell ControlVault support	Device connects to Dell ControlVault for usage and processing	Yes

Operating and storage environment

This table lists the operating and storage specifications of your Dell Pro 14 Plus/Dell Pro 14 Plus 2-in-1.

Airborne contaminant level: G1 as defined by ISA-S71.04-1985

Table 33. Computer environment

Description	Operating	Storage
Temperature range	0°C to 35°C (32°F to 95°F)	-40°C to 65°C (-40°F to 149°F)
Relative humidity (maximum)	10% to 90% (non-condensing)	0% to 95% (non-condensing)
Vibration (maximum)*	0.66 GRMS	1.30 GRMS
Shock (maximum)	110 G†	160 G†
Altitude range	-15.20 m to 3048 m (-49.87 ft to 10000 ft)	-15.20 m to 10668 m (-49.87 ft to 35000 ft)

 **CAUTION:** Operating and storage temperature ranges may differ among components, so operating or storing the device outside these ranges may impact the performance of specific components.

* Measured using a random vibration spectrum that simulates the user environment.

† Measured using a 2 ms half-sine pulse.









Dell support policy

For information about Dell support policy, search [Dell Support Site](#).

Working inside your computer

Safety instructions

Use the following safety guidelines to protect your computer from potential damage and to ensure your personal safety. Unless otherwise noted, each procedure in this document assumes that you have read the safety information that shipped with your computer.



-  **WARNING:** Before working inside your computer, read the safety information that is shipped with your computer. For more safety best practices, see [Dell Regulatory Compliance Home Page](#).
-  **WARNING:** Disconnect your computer from all power sources before opening the computer cover or panels. After you finish working inside the computer, replace all covers, panels, and screws before connecting your computer to an electrical outlet.
-  **WARNING:** For laptops, discharge the battery completely before removing it. Disconnect the AC power adapter from the computer and operate the computer solely on battery power—the battery is fully discharged when the computer no longer turns on when the power button is pressed.
-  **CAUTION:** To avoid damaging the computer, ensure that the work surface is flat, dry, and clean.
-  **CAUTION:** You should only perform troubleshooting and repairs as authorized or directed by the Dell technical support team. Damage due to servicing that is not authorized by Dell is not covered by your warranty.
-  **CAUTION:** Before touching anything inside your computer, ground yourself by touching an unpainted metal surface, such as the metal at the back of the computer. While you work, periodically touch an unpainted metal surface to dissipate static electricity which could harm internal components.
-  **CAUTION:** To avoid damaging the components and cards, handle them by their edges, and avoid touching the pins and the contacts.
-  **CAUTION:** When you disconnect a cable, pull it by its connector or its pull tab, not the cable itself. Some cables have connectors with locking tabs or thumbscrews that you must disengage before disconnecting the cable. When disconnecting cables, keep them evenly aligned to avoid bending the connector pins. When connecting cables, ensure that the connector on the cable is correctly oriented and aligned with the port.
-  **CAUTION:** Press and eject any installed card from the media-card reader.

Before working inside your computer

About this task

 **NOTE:** The images in this document may differ from your computer depending on the configuration you ordered.

Steps

1. Save and close all open files and exit all open applications.
2. Shut down your computer. For Windows operating system, click **Start** >  **Power** > **Shut down**.
 **NOTE:** If you are using a different operating system, see the documentation of your operating system for instructions.
3. Turn off all the attached peripherals.
4. Disconnect your computer from the electrical outlet.

5. Disconnect all attached network devices and peripherals, such as keyboard, mouse, and monitor from your computer.
6. Remove any media card and optical drive from your computer, if applicable.
7. To clean the air vents, use a soft brush and move vertically.

 **NOTE:** Do not remove the base cover or use any blower to clean the vents.

8. Enter the Service Mode.

Service Mode

Service Mode is used to cut off power without disconnecting the battery cable from the system board before conducting repairs in the computer.

 **CAUTION:** If you are unable to turn on the computer to put it into Service Mode, disconnect the battery cable. To disconnect the battery cable, follow the steps in [Removing the battery](#).

 **NOTE:** Ensure that your computer is shut down and the power adapter is disconnected.

- a. Press and hold the B key and the power button for 3 seconds, or until the Dell logo appears on the screen.
- b. If the **Owner Tag** is set, it is displayed on the screen. Press any key to continue.

 **NOTE:** If the **Owner Tag** information is not already set, the computer automatically skips this step and proceeds to enter Service Mode.

- c. If the power adapter is still connected, a message appears on the screen prompting you to disconnect it. Disconnect the power adapter, then press any key to continue.
- d. When the **System Ready For Service** message appears on the screen, press any key to proceed. The computer emits three short beeps and shuts down immediately. The computer shuts down and enters the Service Mode.

Safety precautions

This section details the primary steps to be followed before disassembling any device or component.

Observe the following safety precautions before any installation or break-fix procedures involving disassembly or reassembly:

- Turn off the computer and all attached peripherals.
- Disconnect the computer from AC power.
- Disconnect all network cables and peripherals from the computer.
- Use an ESD field service kit when working inside your computer to avoid electrostatic discharge (ESD) damage.
- Place the removed component on an anti-static mat after removing it from the computer.
- Press and hold the power button for 15 seconds to discharge the residual power in the system board.

Bonding

Bonding is a method for connecting two or more grounding conductors to the same electrical potential. This is done by using a field service electrostatic discharge (ESD) kit. When connecting a bonding wire, ensure that it is connected to bare metal and never to a painted or nonmetal surface. Ensure that the wrist strap is secure and in full contact with your skin. Remove all jewelry, watches, bracelets, or rings before grounding yourself and the equipment.

Electrostatic discharge—ESD protection

ESD is a major concern when you handle electronic components, especially sensitive components such as expansion cards, processors, memory modules, and system boards. A slight charge can damage circuits in ways that may not be obvious, such as intermittent problems or a shortened product life span. As the industry pushes for lower power requirements and increased density, ESD protection is an increasing concern.

Two recognized types of ESD damage are catastrophic and intermittent failures.

- **Catastrophic** – Catastrophic failures represent approximately 20 percent of ESD-related failures. The damage causes an immediate and complete loss of device functionality. An example of catastrophic failure is a memory module that has received a static shock and immediately generates a "No POST/No Video" symptom with a beep code that is emitted for missing or nonfunctional memory.

- **Intermittent** – Intermittent failures represent approximately 80 percent of ESD-related failures. The high rate of intermittent failures means that most of the time when damage occurs, it is not immediately recognizable. The memory module receives a static shock, but the tracing is merely weakened and does not immediately produce outward symptoms that are related to the damage. The weakened trace may take weeks or months to melt, and in the meantime may cause degradation of memory integrity, intermittent memory errors, and so on.

Intermittent failures that are also called latent or "walking wounded" are difficult to detect and troubleshoot.

Perform the following steps to prevent ESD damage:

- Use a wired ESD wrist strap that is properly grounded. Wireless anti-static straps do not provide adequate protection. Touching the chassis before handling parts does not ensure adequate ESD protection on parts with increased sensitivity to ESD damage.
- Handle all static-sensitive components in a static-safe area. If possible, use anti-static floor pads and workbench pads.
- When unpacking a static-sensitive component from its shipping carton, do not remove the component from the anti-static packing material until you are ready to install the component. Before unwrapping the anti-static packaging, use the anti-static wrist strap to discharge the static electricity from your body.

i **NOTE:** You can protect against ESD and discharge static electricity from your body by touching a metal-grounded object before you interact with anything electronic, for example, an unpainted metal surface on your computer's I/O panel. When connecting a peripheral (including handheld digital assistants) to your computer, you should always ground both yourself and the peripheral before connecting it to the computer. In addition, as you work inside the computer, periodically touch a metal-grounded object to remove any static charge that your body may have accumulated.

For more information about the wrist strap and ESD wrist strap tester, see [Components of an ESD Field Service Kit](#).

- Before transporting a static-sensitive component, place it in an anti-static container or packaging.

ESD Field Service kit

The unmonitored field service kit is the most commonly used service kit. Each Field Service kit includes three main components: anti-static mat, wrist strap, and bonding wire.

⚠ CAUTION: It is critical to keep ESD-sensitive devices away from internal parts that are insulated and often highly charged, such as plastic heat sink casings.

Working environment

Before the ESD Field Service kit is deployed, conduct an evaluation of the site to ensure proper setup and readiness. For example, deploying the kit for a server environment is different than for a desktop or laptop environment. Servers are typically installed in a rack within a data center; desktops or laptops are typically placed on office desks or cubicles. Always look for a large open flat work area that is free of clutter and large enough to deploy the ESD kit with additional space to accommodate the type of computer that is being repaired. The workspace should also be free of insulators that can cause an ESD event. On the work area, insulators such as styrofoam and other plastics should always be moved at least 12 inches or 30 centimeters away from sensitive parts before physically handling any hardware components.

ESD packaging

All ESD-sensitive devices must be shipped and received in static-safe packaging. Metal, static-shielded bags are preferred. However, you should always return the damaged component using the same ESD bag and packaging that the new part arrived in. The ESD bag should be folded over and taped shut and all the same foam packing material should be used in the original box that the new part arrived in. ESD-sensitive devices should be removed from packaging only at an ESD-protected work surface, and parts should never be placed on top of the ESD bag because only the inside of the bag is shielded. Always place parts in your hand, on the anti-static mat, in the computer, or inside an ESD bag.

Components of an ESD Field Service kit

The components of an ESD Field Service kit are:

- **Anti-Static Mat** – The anti-static mat is dissipative and parts can be placed on it during service procedures. When using an anti-static mat, your wrist strap should be snug and the bonding wire should be connected to the anti-static mat and to any bare metal on the computer being worked on. Once deployed properly, service parts can be removed from the ESD bag and

placed directly on the anti-static mat. ESD-sensitive items are safe in your hand, on the anti-static mat, in the computer, or inside an ESD bag.

- **Wrist Strap and Bonding Wire** – If an anti-static mat is not being used, the wrist strap and bonding wire should be connected directly between your wrist and an exposed metal part of the hardware. If you are using an anti-static mat, connect the wrist strap and bonding wire to the anti-static mat to ensure protection for any hardware placed on the mat. The physical connection of the wrist strap and bonding wire between your skin, the anti-static mat, and the hardware is known as bonding. Use only Field Service kits with a wrist strap, anti-static mat, and bonding wire. Never use wireless wrist straps. Always be cautious that the internal wires of a wrist strap are prone to damage from normal wear and tear, and must be checked regularly with a wrist strap tester in order to avoid accidental ESD hardware damage. It is recommended to test the wrist strap and bonding wire at least once per week.
- **ESD Wrist Strap Tester** – The wires inside an ESD strap are prone to damage over time. When using an unmonitored ESD kit, it is recommended to test the wrist strap regularly—ideally before each service session, and at a minimum, once per week. The most reliable method for testing is with a wrist strap tester. To perform the test, connect the bonding wire of the wrist strap to the tester while wearing the strap. Press the test button to initiate the check. A green LED indicates a successful test, while a red LED and audible alarm signal a failure.

NOTE: It is recommended to always use the traditional wired ESD grounding wrist strap and protective anti-static mat when servicing Dell products. In addition, it is critical to keep sensitive parts separate from all insulator parts while servicing the computer.

Transporting sensitive components

When transporting ESD sensitive components such as replacement parts or parts to be returned to Dell, it is critical to place these parts in anti-static bags for safe transport.

After working inside your computer

About this task

CAUTION: Leaving stray or loose screws inside your computer may severely damage your computer.

Steps

1. Replace all screws and ensure that no stray screws remain inside your computer.
2. Connect any external devices, peripherals, or cables you removed before working on your computer.
3. Replace any media cards, disks, or any other parts that you removed before working on your computer.
4. Connect your computer to their electrical outlets.

NOTE: To exit service mode, ensure to connect the AC adapter to the power-adapter port on your computer.

5. Press the power button to turn on the computer.

Information on repairability for Québec - From Dell Canada Inc. - to Quebec consumers

Dell does not guarantee the availability of replacement parts, repair services, or information necessary for maintenance or repair.

BitLocker

When updating the BIOS on a computer with BitLocker enabled, consider the following precautions.

CAUTION: If BitLocker is not suspended before updating the BIOS, the BitLocker key will not be recognized the next time that you reboot the computer. You are prompted to enter the recovery key to progress, and the computer displays a prompt for the recovery key on each reboot. If the recovery key is not known, this can

result in data loss or an operating system reinstall. For more information, see Knowledge Article: [updating the BIOS on Dell computers with BitLocker enabled.](#)

The installation of the following components triggers BitLocker:

- Hard disk drive or solid state drive
- System board

Recommended tools

The procedures in this document may require the following tools:

- Phillips screwdriver #0
- Phillips screwdriver #1
- Flat-head screwdriver (<4mm)
- Plastic scribe

Screw list

NOTE: When removing screws from a component, it is recommended to note the screw type and the quantity of screws, and then place them in a screw storage box. This is to ensure that the correct number of screws and correct screw type is restored when the component is replaced.

NOTE: Some computers have magnetic surfaces. Ensure that the screws are not left attached to such surfaces when replacing a component.

NOTE: Screw color may vary depending on the configuration ordered.

Table 34. Screw list









Component	Screw type	Quantity	Screw image
Base cover	M2x8.5 captive screws	6	
	M2x6 captive screws	2	
Battery	M2x5 captive screws	4	
WWAN-card thermal shield	M2x4	3	
Solid state drive	M2x4	4	
Speakers	M1.6x1.5	6	
Fan	M2x4	2	
Heat sink	M2x3 captive screws	4	
USH board	M1.6x1.5	2	

Table 34. Screw list (continued)

Component	Screw type	Quantity	Screw image
Smart card reader	M1.6x1.5	2	
WLAN card bracket	M2x3	1	
System board	M2x3	6	
	M2x4	4	
WLAN antenna module	M2x3	1	
	M1.6x2.5	4	
USB Type-C connector module	M2x5	3	
I/O board	M2x3	4	
Power button with optional fingerprint reader	M1.6x1.7	2	
Display-cable bracket	M2x3	2	
Display assembly	M2.5x4	4	
	M2x3	3	
Display panel	M1.6x1.4	4	
Display hinge cap and hinge assembly	M2x3	2	
	M2.5x3.5	4	
Display cable for MIPI camera	M1.6x1.4	2	
Middle-board cable	M1.6x1.4	2	
Keyboard assembly	M1.6x1.7	20	

Major components of Dell Pro 14 Plus/Dell Pro 14 Plus 2-in-1

The following image shows the major components of Dell Pro 14 Plus/Dell Pro 14 Plus 2-in-1.

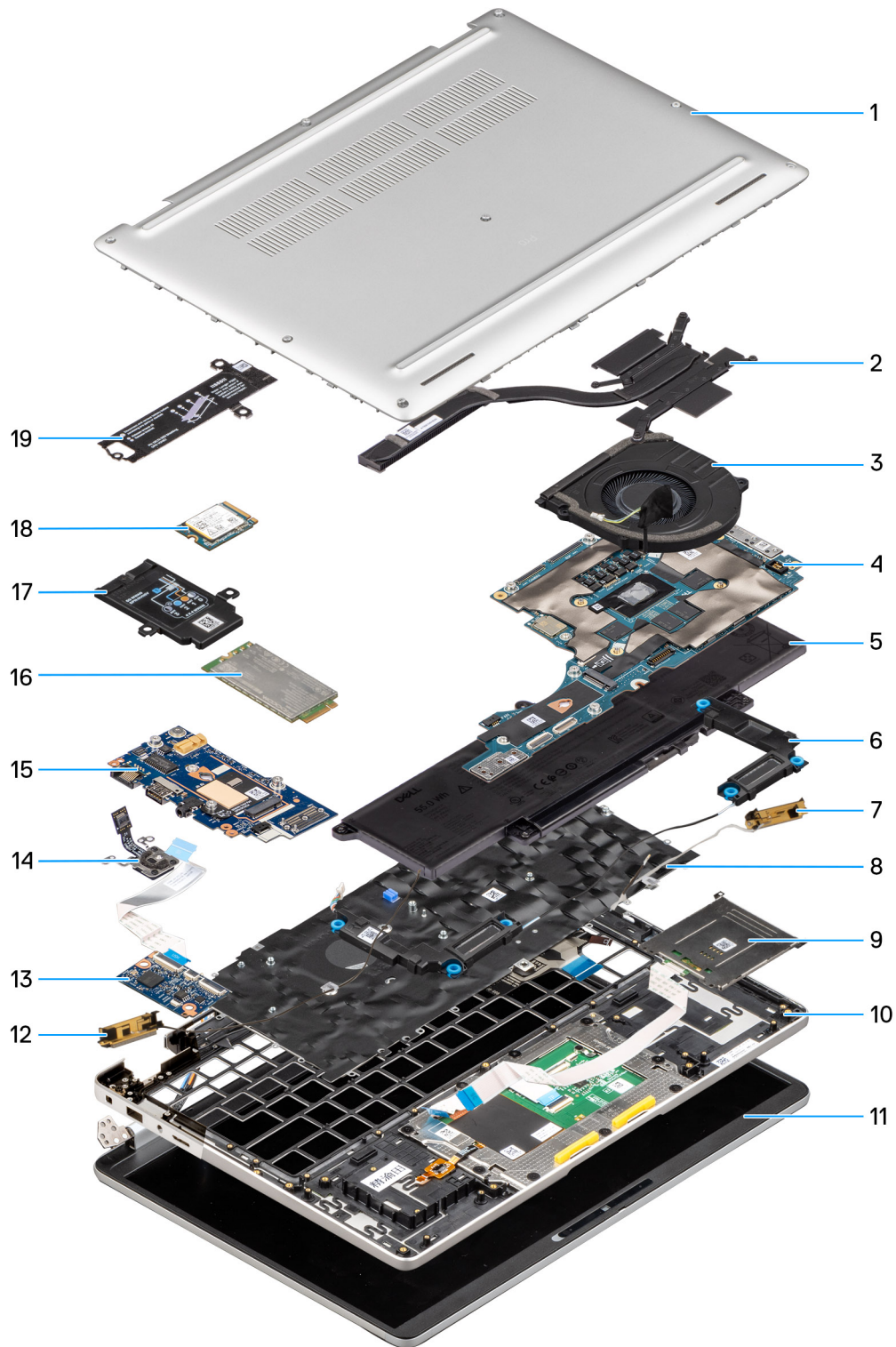



Figure 14. Major components of Dell Pro 14 Plus/Dell Pro 14 Plus 2-in-1

1. Base cover
2. Heat sink
3. Fan
4. System board
5. Battery
6. Speakers
7. WLAN antenna

8. Keyboard assembly
9. Smart card reader (optional)
10. Palmrest assembly
11. Display assembly
12. WLAN antenna
13. USH board
14. Power button with optional fingerprint reader
15. I/O board
16. WWAN card
17. WWAN-card thermal shield
18. Solid state drive (SSD)
19. Solid state drive (SSD) thermal shield

 **NOTE:** Dell provides a list of components and their part numbers for the original computer configuration purchased. These parts are available according to warranty coverage purchased by the customer. Contact your Dell sales representative for purchase options.

Removing and installing Customer Replaceable Units (CRUs)

The replaceable components in this chapter are Customer Replaceable Units (CRUs).

CAUTION: Customers can replace only the Customer Replaceable Units (CRUs) following the safety precautions and replacement procedures.

NOTE: The images in this document may differ from your computer depending on the configuration you ordered.

SIM-card tray (optional)

Removing the SIM-card tray (optional)

Prerequisites

NOTE: The procedure for SIM-card tray removal is only applicable for computers that are shipped with a WWAN module.

1. Follow the procedure in [Before working inside your computer](#).

About this task

The following image indicates the location of the SIM-card tray and provides a visual representation of the removal procedure.

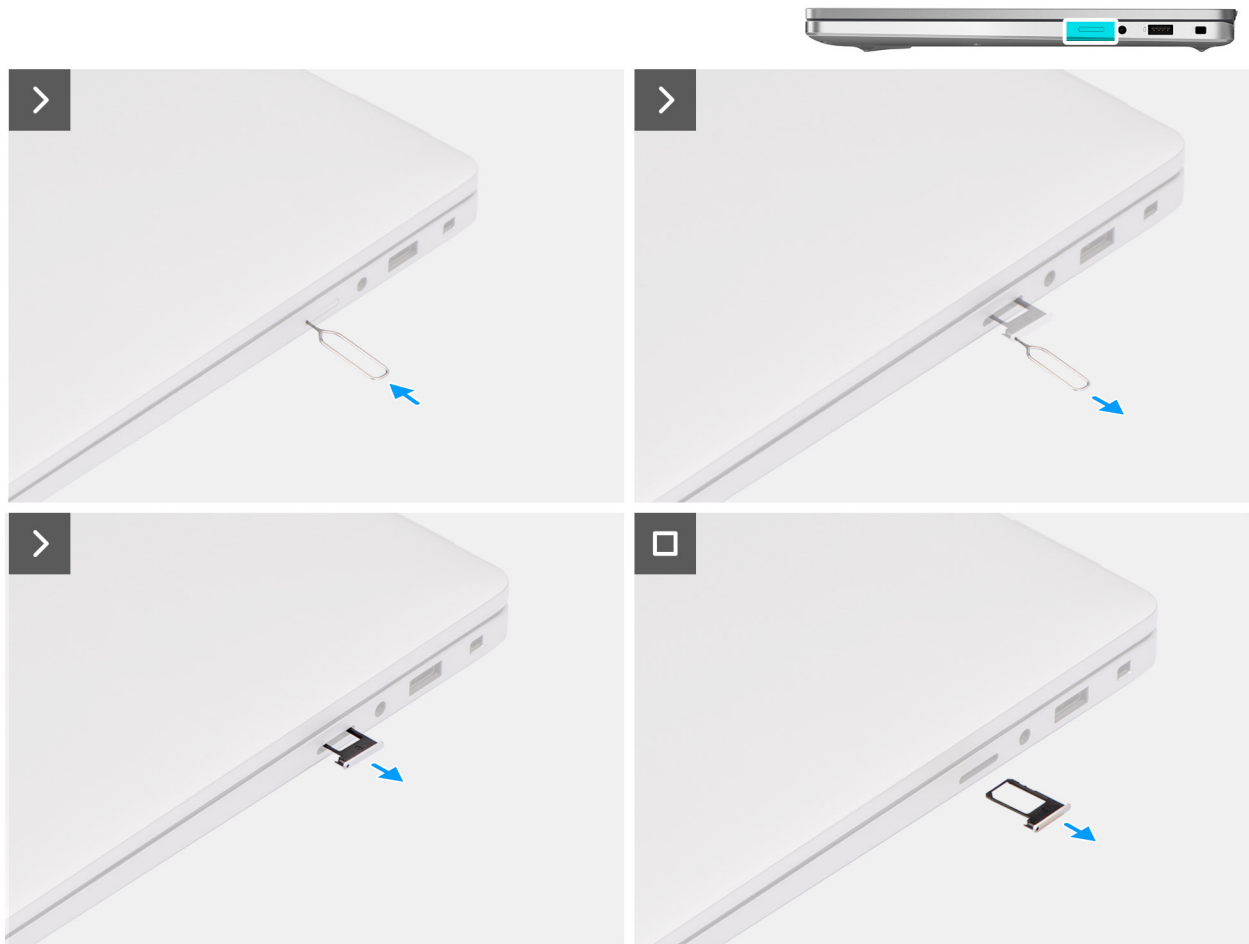

Figure 15. Removing the SIM-card tray

Steps

1. Insert a SIM-ejector pin into the release hole to release the SIM-card tray.
2. Push the pin to disengage the lock, and eject the SIM-card tray.
3. Slide the SIM-card tray out of the slot on the computer.

NOTE: Remove the SIM card from the SIM-card tray if applicable.

Installing the SIM-card tray (optional)

Prerequisites

If you are replacing a component, remove the existing component before performing the installation procedure.

NOTE: The procedure for SIM-card tray removal is only applicable for computers that are shipped with a WWAN module.

About this task

The following image indicates the location of the SIM-card tray and provides a visual representation of the installation procedure.

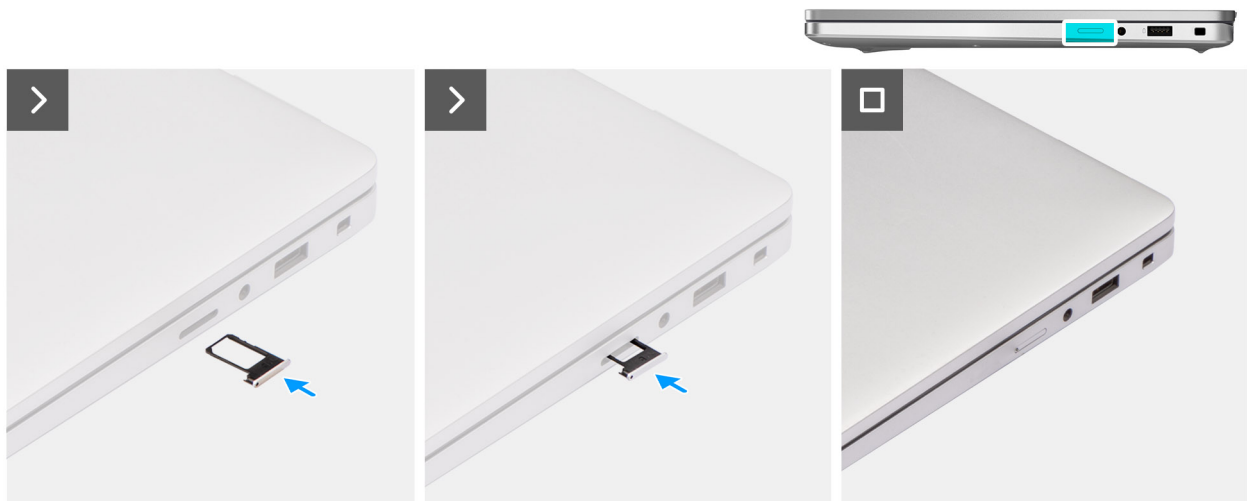

Figure 16. Installing the SIM-card tray

Steps

1. Align the SIM-card tray with the slot on the computer and carefully slide it in.
2. Slide the SIM-card tray into the slot, until it clicks into place.

Next steps

1. Follow the procedure in [After working inside your computer](#).

Base cover

Removing the base cover

Prerequisites

1. Follow the procedure in [Before working inside your computer](#).

CAUTION: If the computer does not turn on, does not enter Service Mode, or does not support Service mode, disconnect the battery cable.

NOTE: Ensure that your computer is in Service Mode. For more information, see [Before working inside your computer](#).

2. Remove the [SIM-card tray](#), if applicable.

The following images indicate the location of the base cover and provide a visual representation of the removal procedure.

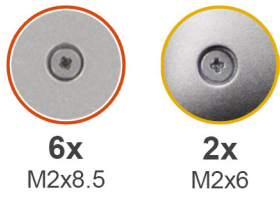

Figure 17. Removing the base cover

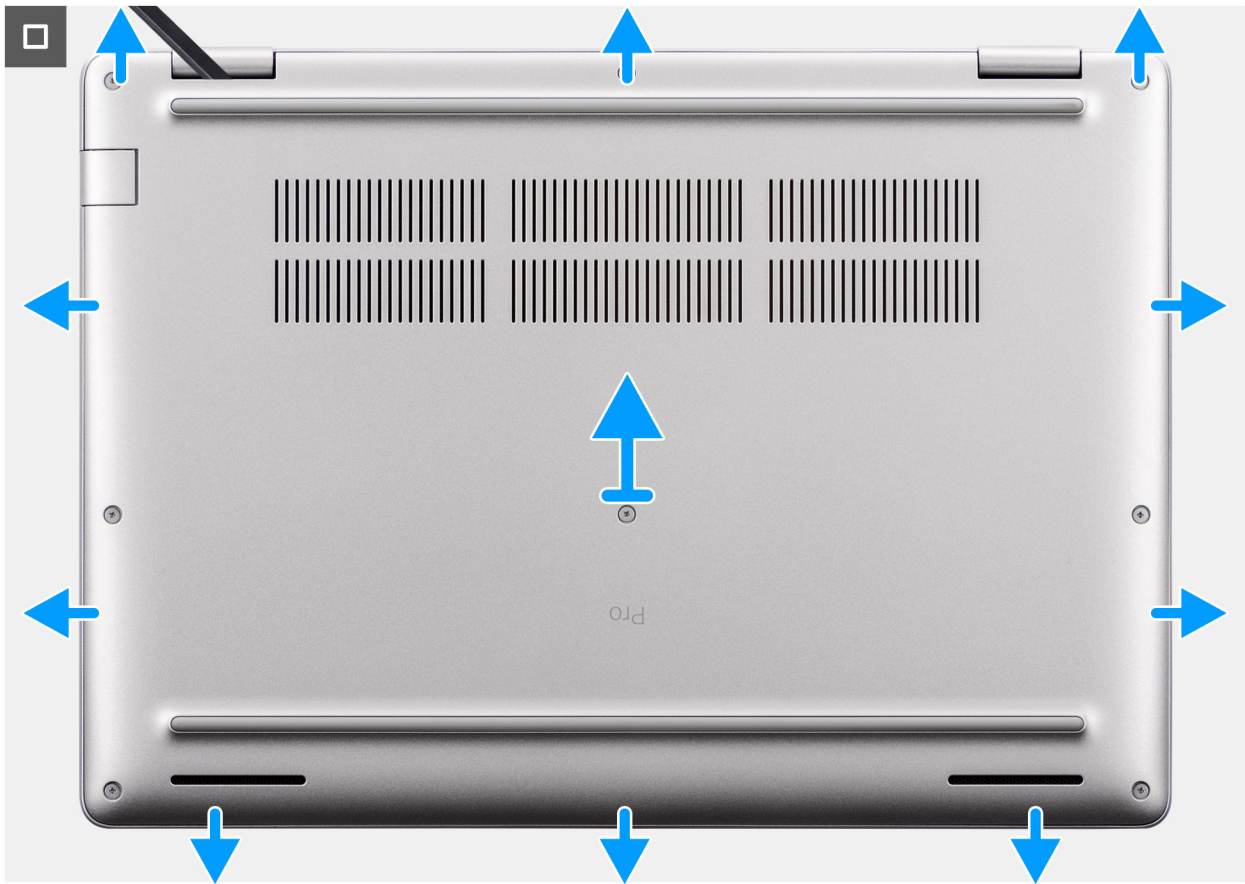

Figure 18. Removing the base cover

Steps

1. Loosen the six captive screws (M2x8.5) and two captive screws (M2x6) that secure the base cover to the palm-rest assembly.
2. Using a plastic scribe, pry open the base cover from the recesses that are located in the U-shaped indents at the top edge of the base cover near the hinges.
3. Lift the base cover off the palm-rest assembly.

i NOTE: Ensure that your computer is in [Service Mode](#). If your computer is unable to enter Service Mode, peel off the tape and disconnect the battery cable from the battery-cable connector (BATT1) on the system board. Press and hold the power button for five seconds to ground the computer and drain the flea power.

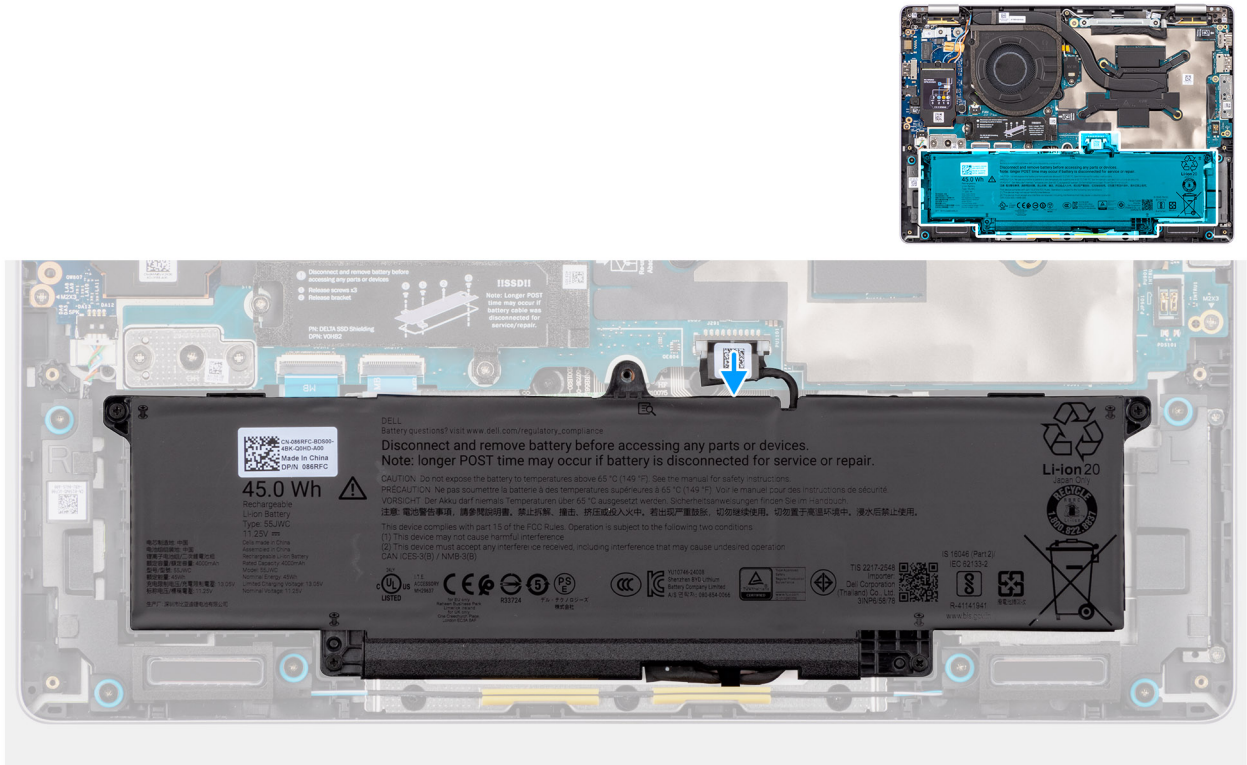

Figure 19. Disconnecting the battery cable

Installing the base cover

Prerequisites

If you are replacing a component, remove the existing component before performing the installation procedure.

The following images indicate the location of the base cover and provide a visual representation of the installation procedure.

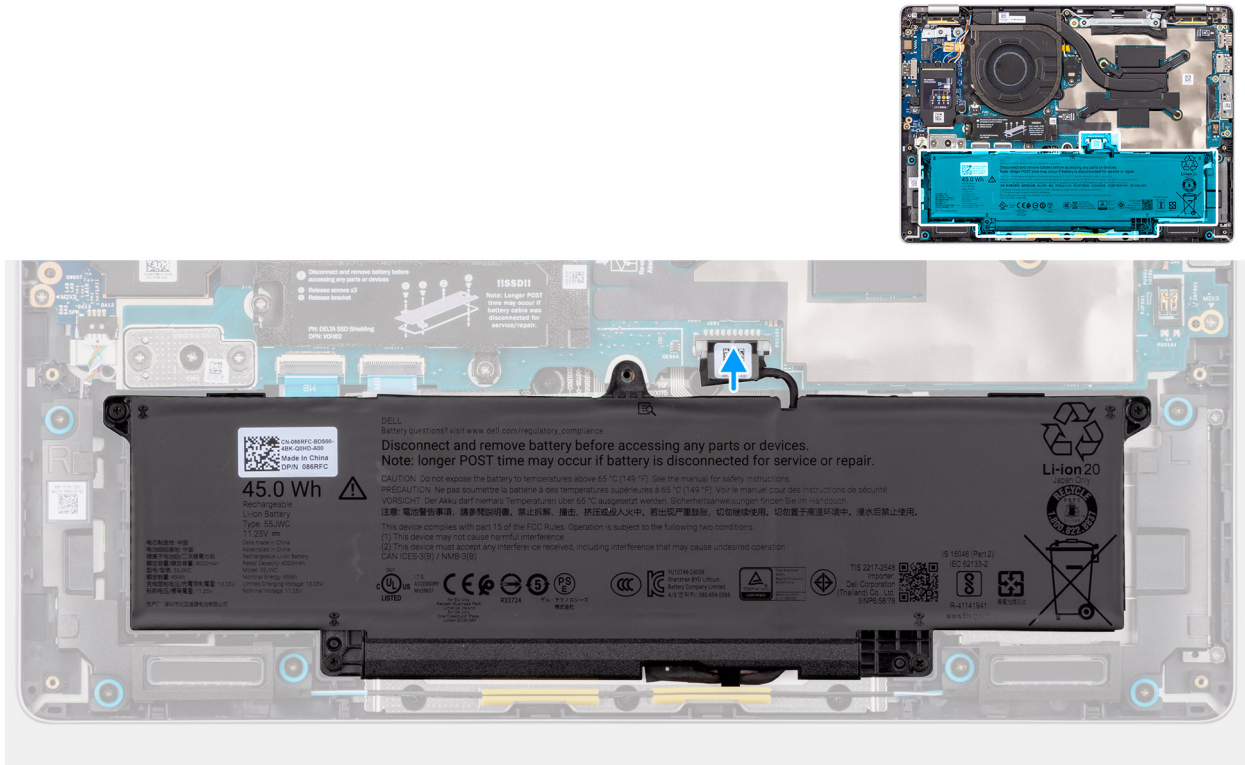

Figure 20. Connecting the battery cable

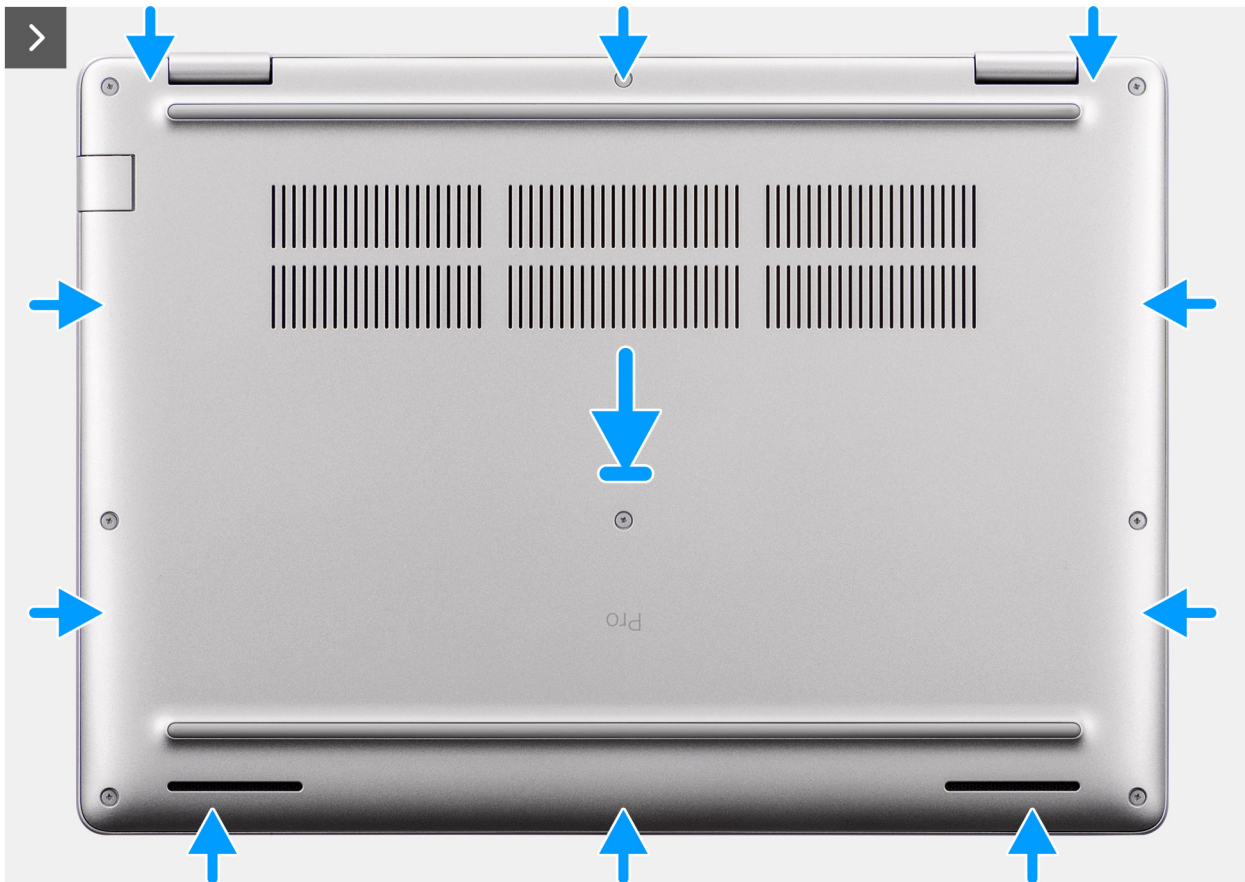

Figure 21. Installing the base cover

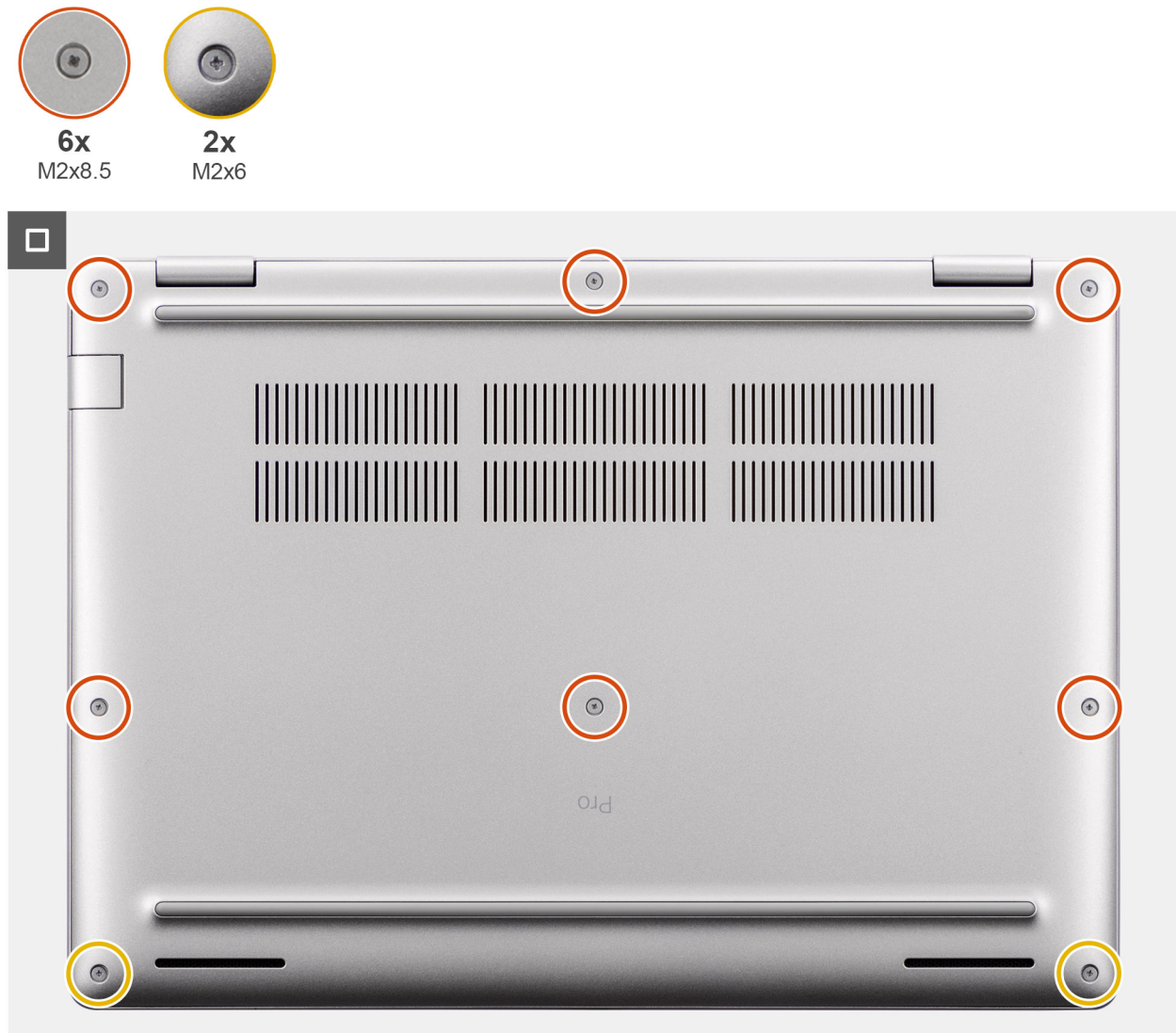

Figure 22. Installing the base cover

NOTE: If you have disconnected the battery cable, ensure to connect the battery cable. To connect the battery cable, follow step 1 in the procedure.

Steps

1. Connect the battery cable to the battery-cable connector (BATT1) on the system board.
2. Adhere the tape on the battery cable to the battery.
3. Align the screw holes on the base cover with the screw holes on the palm-rest assembly, and then snap the base cover into place.
4. Tighten the six captive screws (M2x8.5) and two captive screws (M2x6) that secure the base cover to the palm-rest assembly.

Next steps

1. Install the [SIM-card tray](#), if applicable.
2. Follow the procedure in [After working inside your computer](#).

Battery

Battery

Rechargeable Li-ion battery precautions

WARNING:

- Exercise caution when handling rechargeable Li-ion batteries.
- Discharge the battery completely before removing it. Disconnect the AC power adapter from the computer and operate the computer solely on battery power—the battery is fully discharged when the computer no longer turns on when the power button is pressed.
- Do not crush, drop, mutilate, or penetrate the battery with foreign objects.
- Do not expose the battery to high temperatures, or disassemble battery packs and cells.
- Do not apply pressure to the surface of the battery.
- Do not bend the battery.
- Do not use tools of any kind to pry on or against the battery.
- To prevent accidental puncture or damage to the battery and other components, ensure that no screws are lost or misplaced during the servicing of the computer.
- Always purchase genuine batteries from [Dell Site](#) or authorized Dell partners and resellers.
- Swollen batteries should not be used and should be replaced and disposed properly. For guidelines on how to handle and replace swollen rechargeable Li-ion batteries, see [Handling swollen rechargeable Li-ion batteries](#).

Removing the battery

Prerequisites

1. Follow the procedure in [Before working inside your computer](#).
2. Remove the [SIM-card tray](#), if applicable.
3. Remove the [base cover](#).

About this task

 **CAUTION:** Removing the battery resets the BIOS settings to default values. It is recommended that you note the BIOS settings before removing the battery.

The following images indicate the location of the battery and provide a visual representation of the removal procedure.

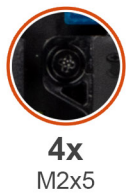

4x
M2x5

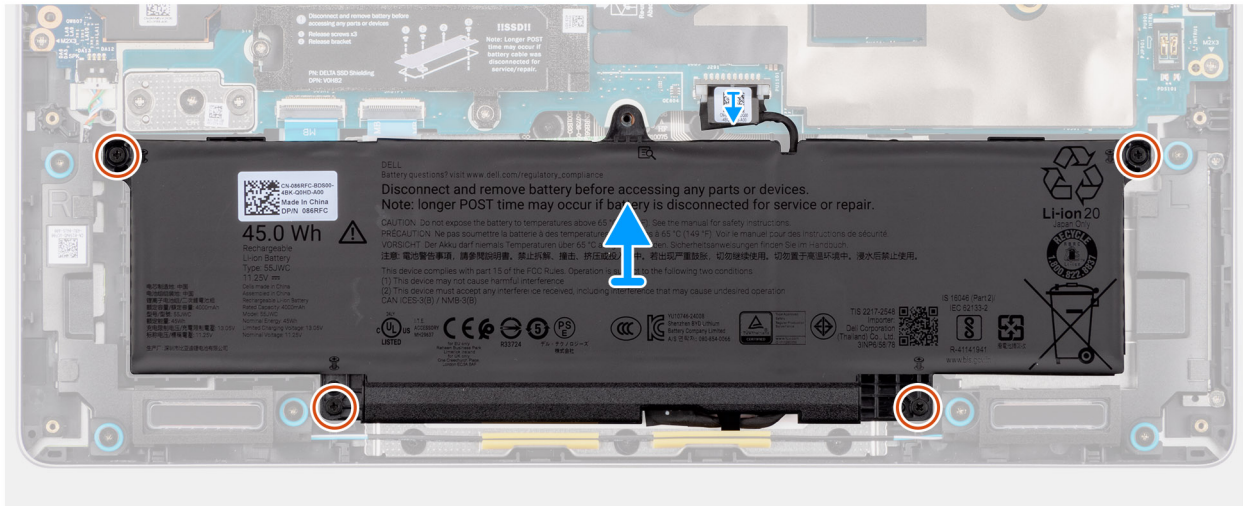
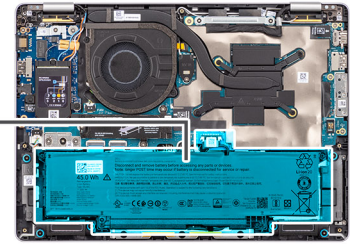
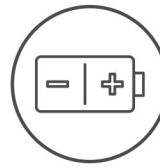

Figure 23. Removing the battery

Steps

1. Disconnect the battery cable from the battery cable connector (PBATT1) on the system board.
2. Loosen the four captive screws (M2x5) that secure the battery to the palm-rest assembly.
3. Lift the battery off the palm-rest assembly.
4. If you are replacing the battery, remove the battery cable to transfer it to the replacement battery. For more information, see [Removing the battery cable](#).

Installing the battery

Prerequisites

If you are replacing a component, remove the existing component before performing the installation procedure.

About this task

The following images indicate the location of the battery and provide a visual representation of the installation procedure.



4x
M2x5

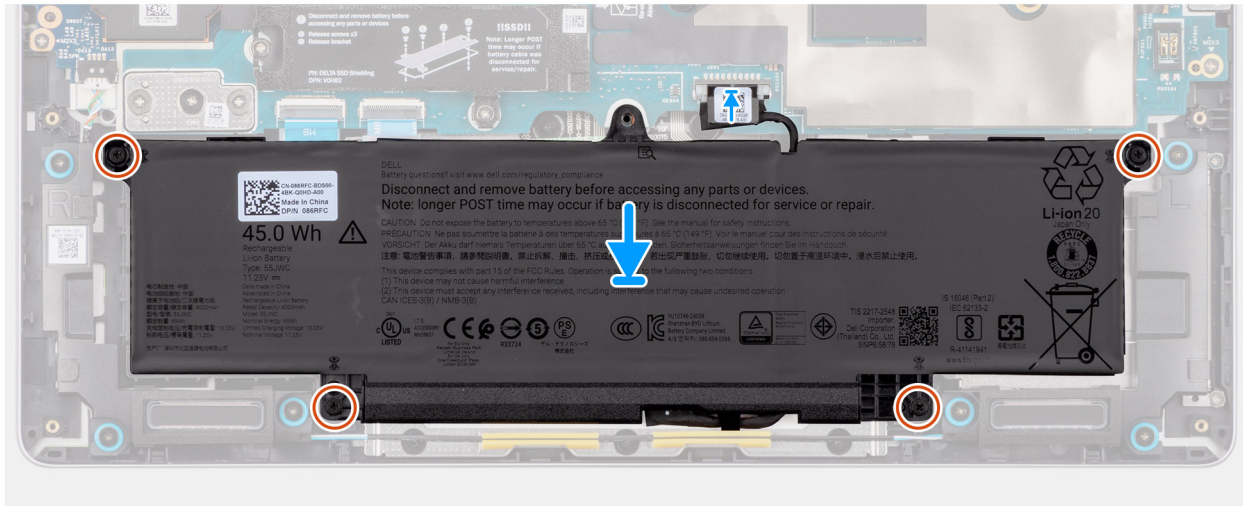
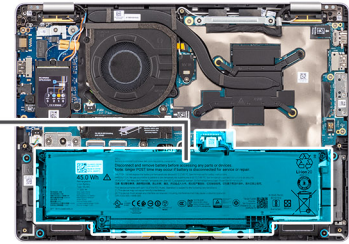
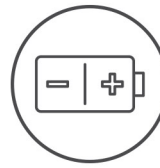

Figure 24. Installing the battery

Steps

1. If the battery cable was removed for replacing the battery, you must transfer the battery cable from the old battery to the replacement battery. For more information, see [Installing the battery cable](#).
2. Using the alignment posts, place the battery on the palm-rest assembly.
3. Align the screw holes on the battery with the screw holes on the palm-rest assembly.
4. Tighten the four captive screws (M2x5) that secure the battery to the palm-rest assembly.
5. Connect the battery cable to the battery cable connector (PBATT1) on the system board.

Next steps

1. Install the [base cover](#).
2. Install the [SIM-card tray](#), if applicable.
3. Follow the procedure in [After working inside your computer](#).

Battery cable

Removing the battery cable

Prerequisites

1. Follow the procedure in [Before working inside your computer](#).
2. Remove the [SIM-card tray](#), if applicable.
3. Remove the [base cover](#).
4. Remove the [battery](#).

About this task

The following images indicate the location of the battery cable and provide a visual representation of the removal procedure.

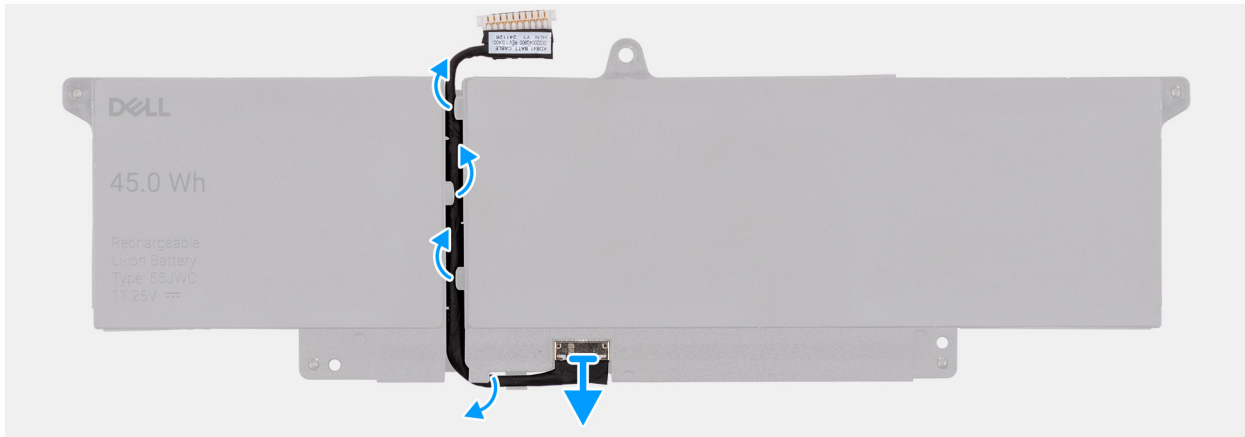

Figure 25. Removing the battery cable

Steps

1. Turn the battery over.
2. Remove the battery cable from the routing guides on the battery.
3. Disconnect the battery cable from the connector on the battery and lift the battery cable off the battery.

Installing the battery cable

Prerequisites

If you are replacing a component, remove the existing component before performing the installation procedure.

About this task

The following images indicate the location of the battery cable and provide a visual representation of the installation procedure.

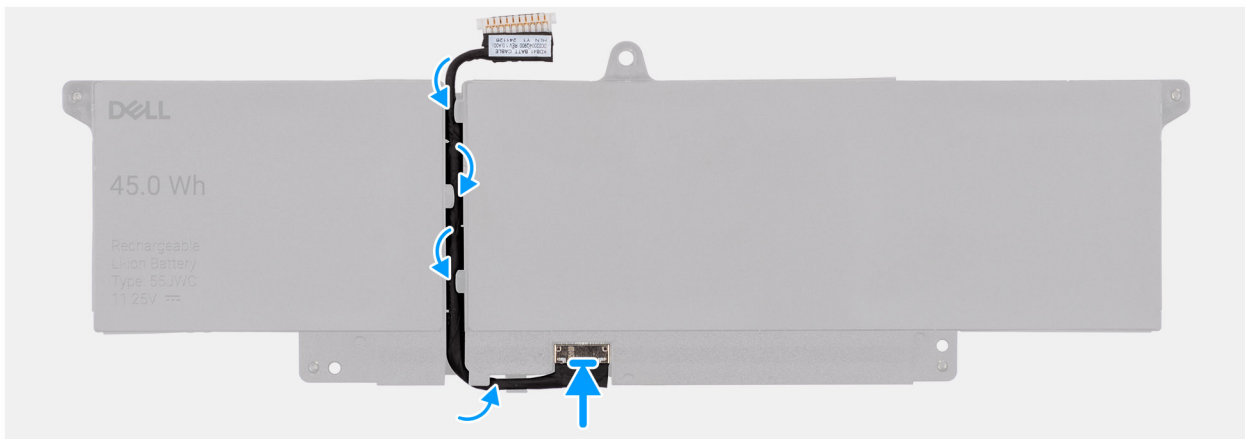

Figure 26. Replacing the battery cable

Steps

1. Connect the battery cable to the connector on the battery.
2. Route the battery cable through the routing guides on the battery.

NOTE: When installing the battery cable, ensure that the cable is properly routed under the securing tabs.

Next steps

1. Install the [battery](#).
2. Install the [base cover](#).

3. Install the SIM-card tray, if applicable.
4. Follow the procedure in [After working inside your computer](#).

Wireless Wide Area Network (WWAN) card

Removing the 5G WWAN card

NOTE: The 5G WWAN card is available only on certain configurations. It is connected to the computer with four antenna cables.

Prerequisites

1. Follow the procedure in [Before working inside your computer](#).
2. Remove the SIM-card tray, if applicable.
3. Remove the [base cover](#).

About this task

The following images indicate the location of the 5G WWAN card and provide a visual representation of the removal procedure.

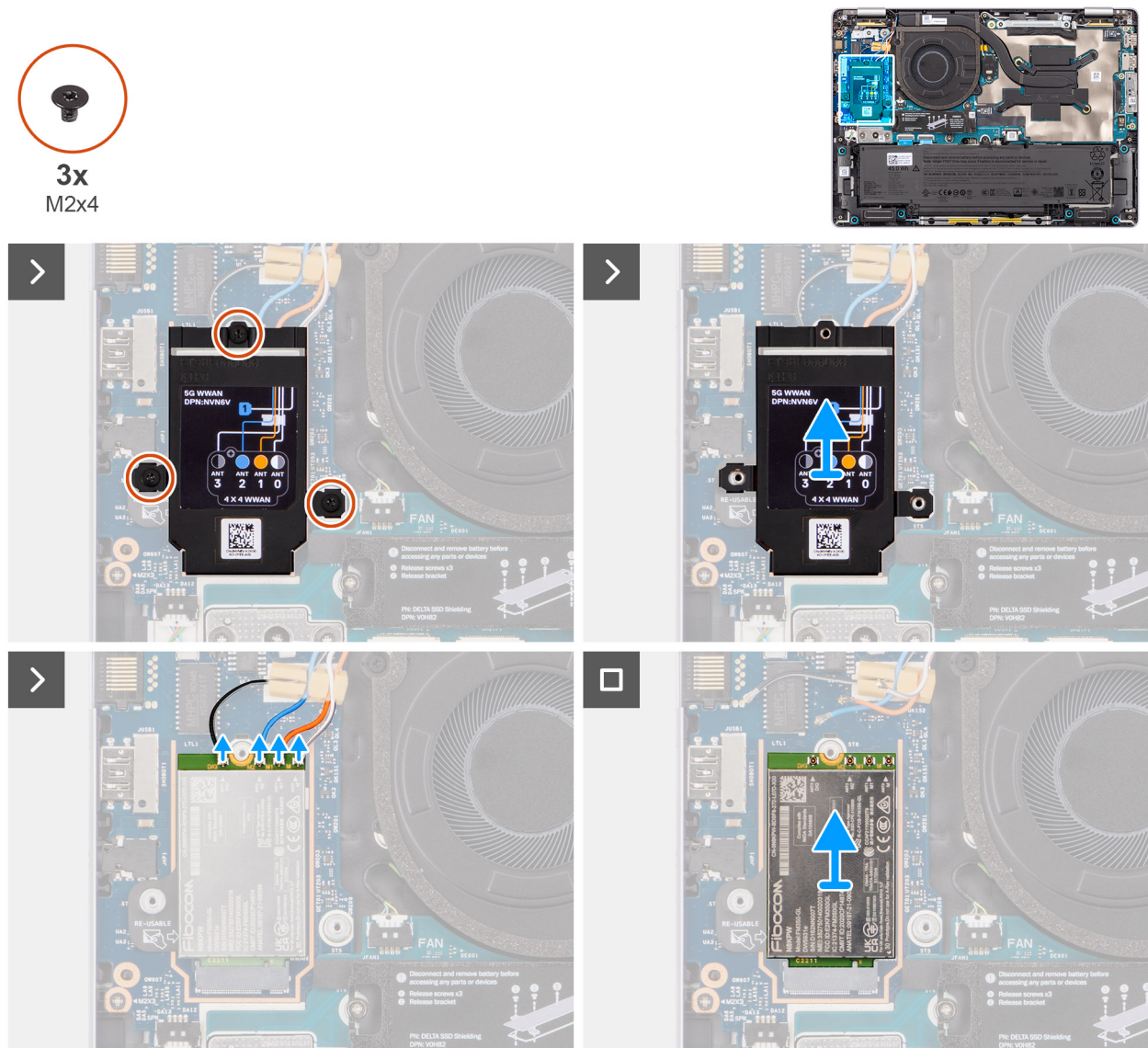

Figure 27. Removing the 5G WWAN card

Steps

1. Remove the three screws (M2x4) that secure the WWAN-card thermal shield to the I/O board.
2. Remove the WWAN-card thermal shield off the WWAN card.
3. Disconnect the antenna cables from the WWAN card.
4. Remove the WWAN card from the WWAN-card slot on the I/O board.

Installing the 5G WWAN card

Prerequisites

If you are replacing a component, remove the existing component before performing the installation procedure.

About this task

The following images indicate the location of the 5G WWAN card and provide a visual representation of the installation procedure.

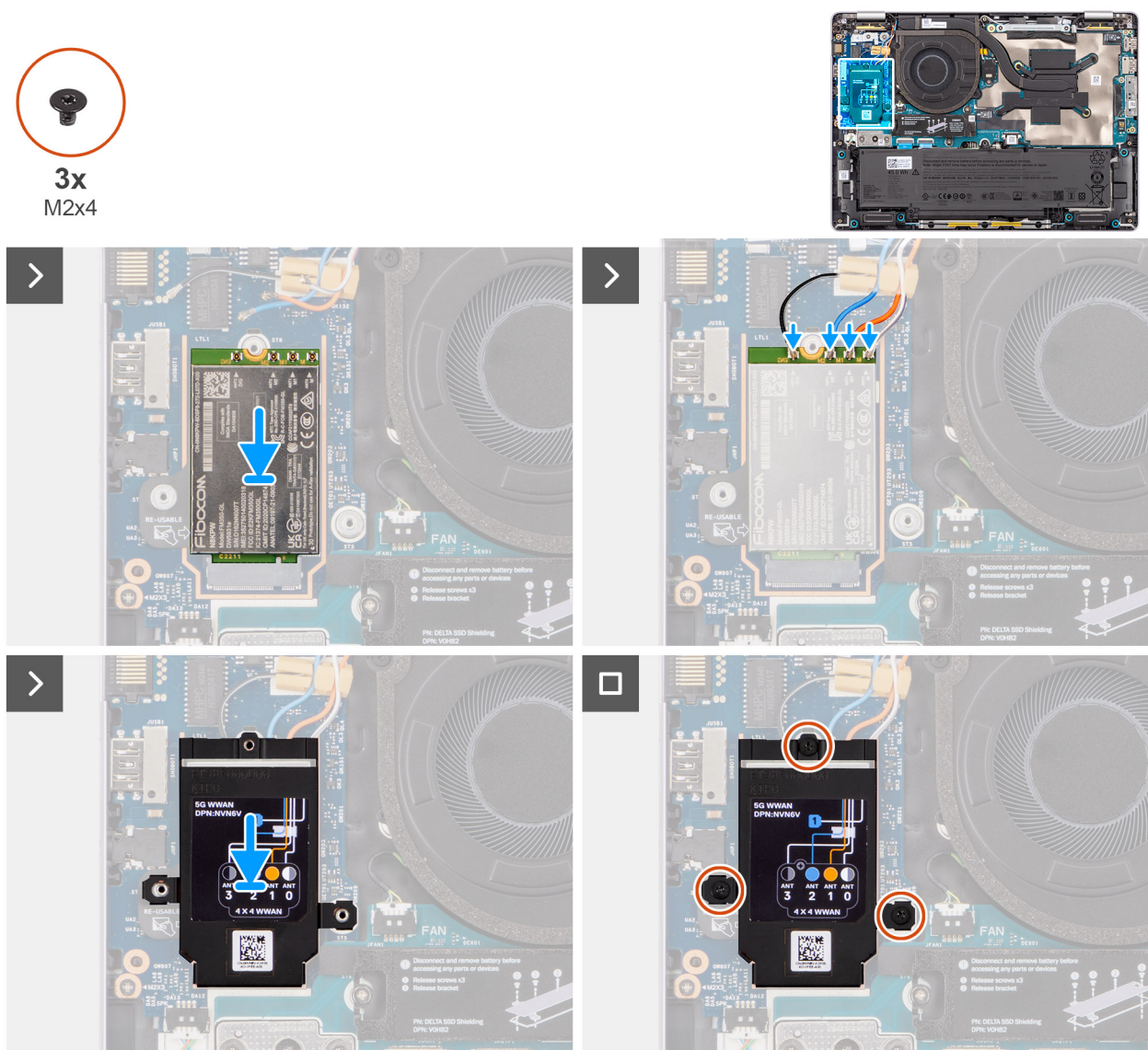

Figure 28. Installing the 5G WWAN card

Steps

1. Insert the WWAN card at an angle into the WWAN-card slot on the I/O board.

NOTE: If you are replacing the WWAN card, ensure that the thermal pad is in place.

NOTE: If the thermal pad is damaged, peel the thermal pad from the system board and replace it with a new thermal pad. The thermal pad must be purchased separately.

2. Connect the antenna cables to their respective connectors on the WWAN card.

The following table provides the antenna-cable color scheme for the WWAN card that is supported on your computer.

Table 35. Antenna-cable color scheme for 5G WWAN card

Connectors on the WWAN card	Antenna-cable color
D/G	Black with a thin gray stripe
M2	Blue
M1	Orange
M	White with a thin gray stripe

3. Align the screw holes on the WWAN-card thermal shield with the screw hole on the I/O board.
4. Replace the three screws (M2x4) that secure the WWAN-card thermal shield to the I/O board.

Next steps

1. Install the [base cover](#).
2. Install the [SIM-card tray](#), if applicable.
3. Follow the procedure in [After working inside your computer](#).

Removing the 4G WWAN card

Prerequisites

1. Follow the procedure in [Before working inside your computer](#).
2. Remove the [SIM-card tray](#), if applicable.
3. Remove the [base cover](#).

About this task

The following images indicate the location of the 4G WWAN card and provide a visual representation of the removal procedure.



3x
M2x4

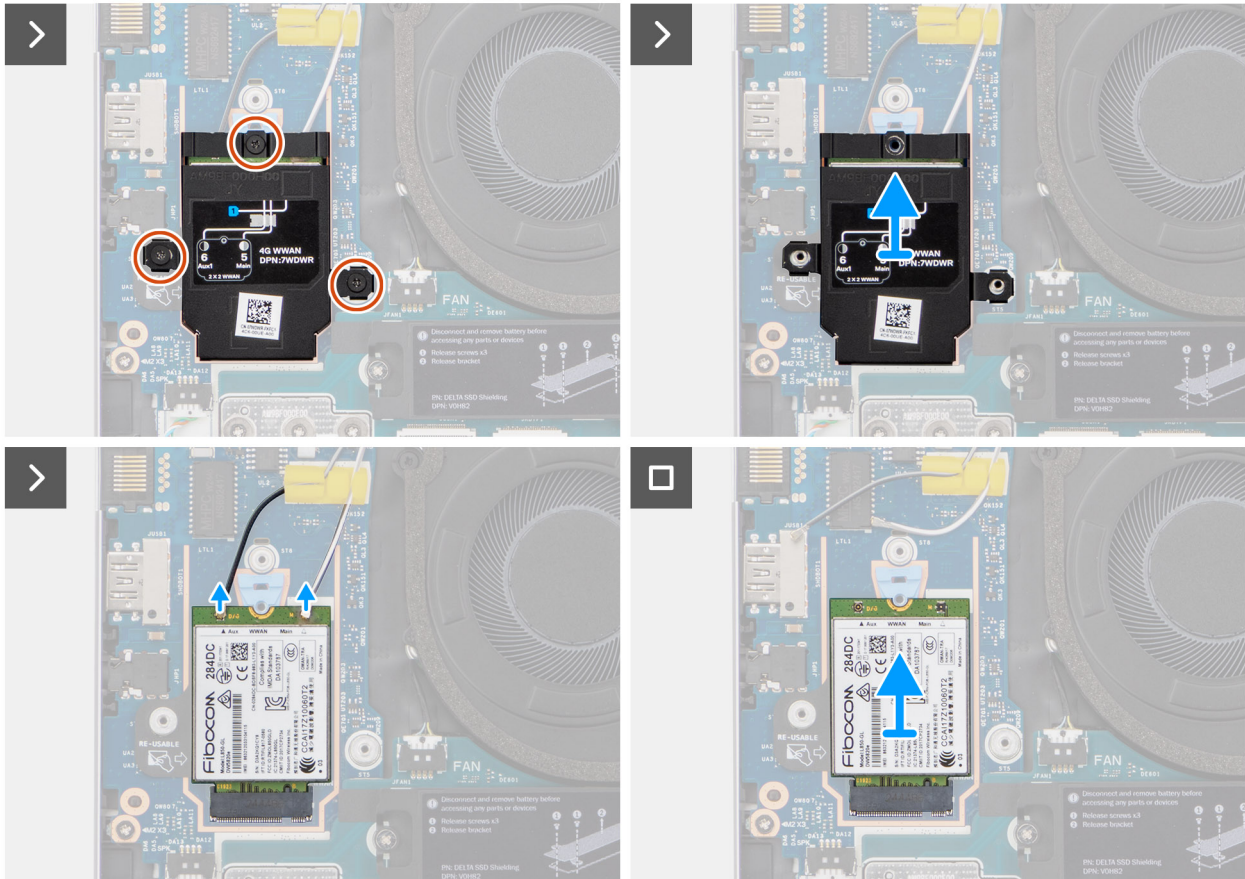
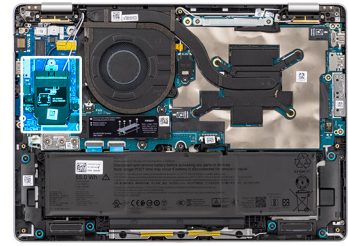

Figure 29. Removing the 4G WWAN card

Steps

1. Remove the three screws (M2x4) that secure the WWAN-card thermal shield to the I/O board.
2. Remove the WWAN-card thermal shield off the WWAN card.
3. Disconnect the antenna cables from the WWAN card.
4. Remove the WWAN card from the WWAN-card slot on the I/O board.

Installing the 4G WWAN card

Prerequisites

If you are replacing a component, remove the existing component before performing the installation procedure.

About this task

The following images indicate the location of the 4G WWAN card and provide a visual representation of the installation procedure.



3x
M2x4

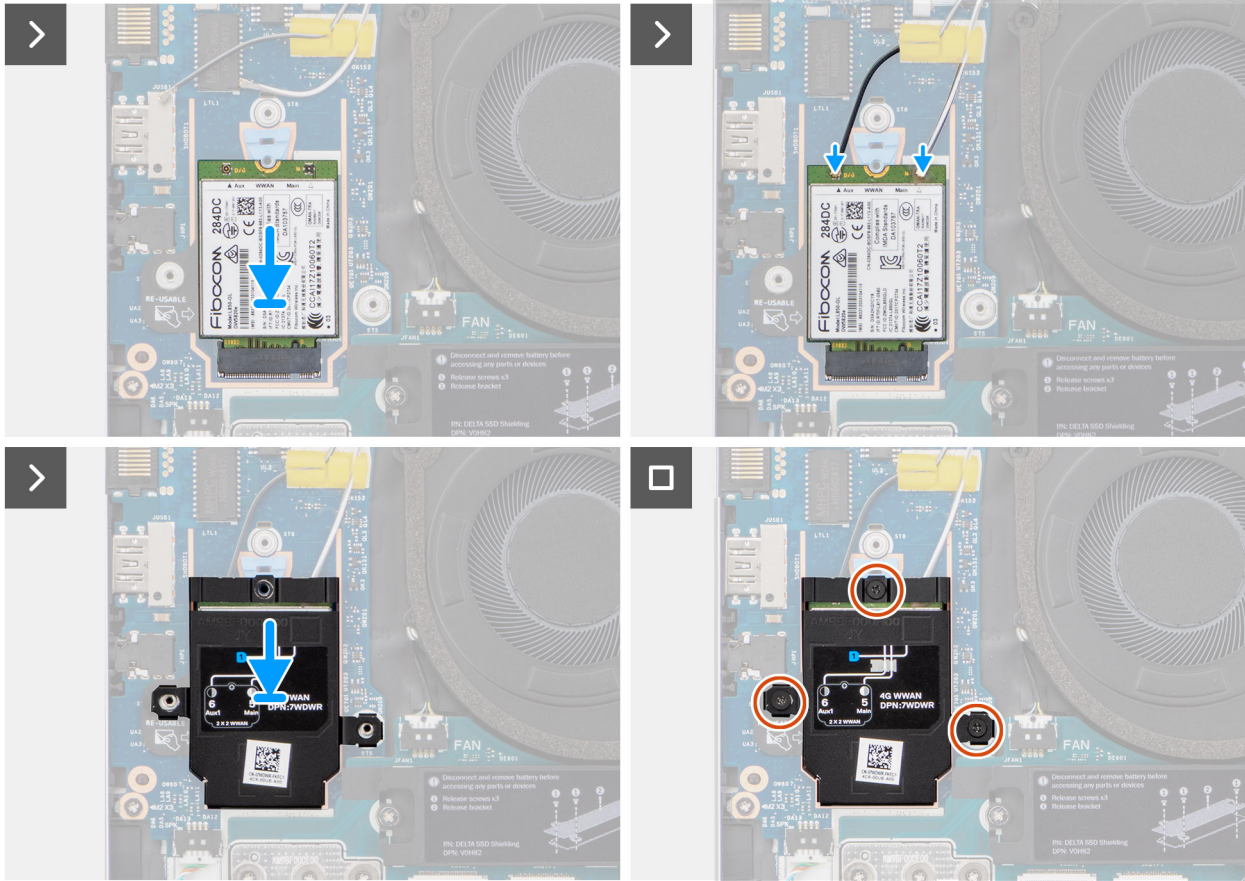
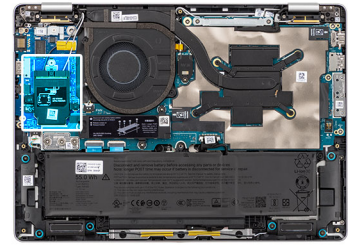

Figure 30. Installing the 4G WWAN card

Steps

1. Insert the WWAN card at an angle into the WWAN-card slot on the I/O board.
 - i** **NOTE:** If you are replacing the WWAN card, ensure that the thermal pad is in place.
 - i** **NOTE:** If the thermal pad is damaged, peel the thermal pad from the system board and replace it with a new thermal pad. The thermal pad must be purchased separately.
2. Connect the antenna cables to their respective connectors on the WWAN card.

The following table provides the antenna-cable color scheme for the WWAN card that is supported on your computer.

Table 36. Antenna-cable color scheme for 4G WWAN card

Connectors on the WWAN card	Antenna-cable color
6 Aux1	Black with a thin gray stripe
5 Main	White with a thin gray stripe

3. Align the screw holes on the WWAN-card thermal shield with the screw hole on the I/O board.
4. Replace the three screws (M2x4) that secure the WWAN-card thermal shield to the I/O board.

Next steps

1. Install the [base cover](#).
2. Install the [SIM-card tray](#), if applicable.
3. Follow the procedure in [After working inside your computer](#).

Solid State Drive (SSD)

Removing the M.2 2230 solid state drive

Prerequisites

1. Follow the procedure in [Before working inside your computer](#).
2. Remove the [SIM-card tray](#), if applicable.
3. Remove the [base cover](#).

About this task

The following images indicate the location of the M.2 2230 solid state drive and provide a visual representation of the removal procedure.

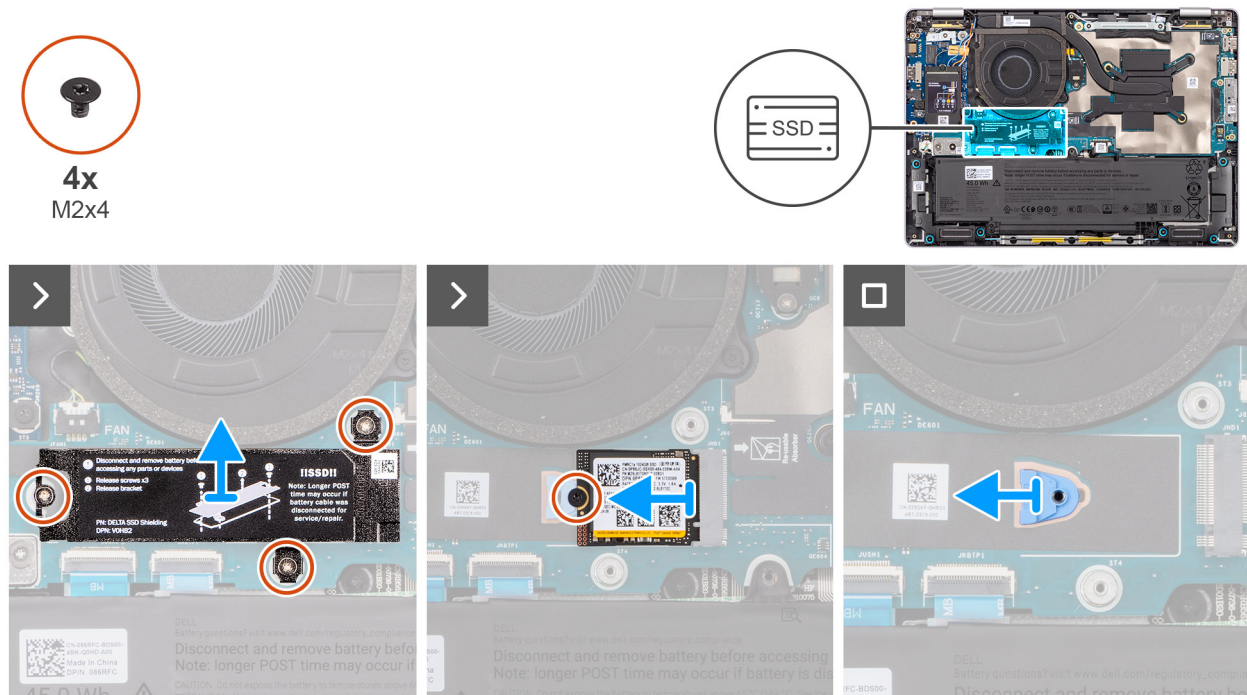

Figure 31. Removing the M.2 2230 SSD

Steps

1. Remove the three screws (M2x4) that secure the SSD thermal shield to the palm-rest assembly.
2. Lift the SSD thermal shield off the SSD.
 - NOTE:** When you replace the SSD, ensure the thermal pad is adhered on the SSD thermal shield before reinstalling the SSD to the computer.
3. Remove the screw (M2x4) that secures the M.2 2230 SSD to the SSD mounting bracket and palm-rest assembly.
4. Slide and remove the M.2 2230 SSD off the SSD slot.
5. Remove the M.2 2230 SSD mounting bracket off the palm-rest assembly.

NOTE: For models shipped with M.2 2230 SSD, ensure that you transfer the SSD mounting bracket from the old system board to the new one.

Installing the M.2 2230 solid state drive

Prerequisites

If you are replacing a component, remove the existing component before performing the installation procedure.

About this task

The following images indicate the location of the M.2 2230 solid state drive and provide a visual representation of the installation procedure.

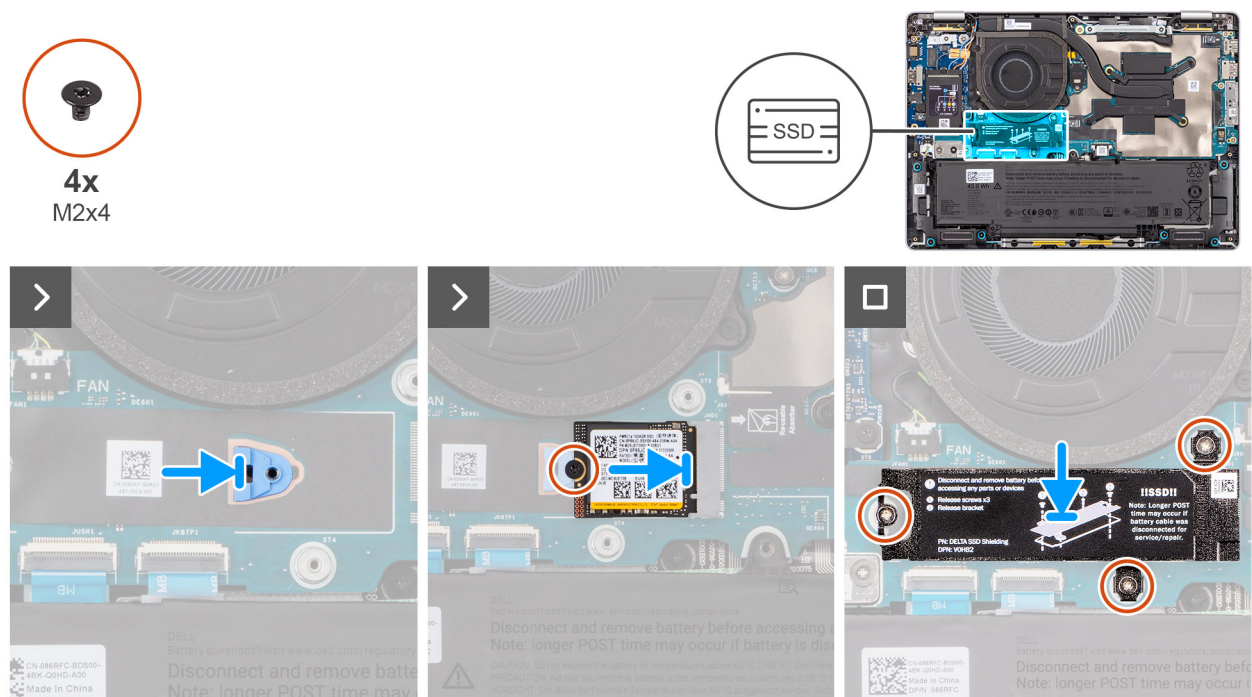

Figure 32. Installing the M.2 2230 SSD

Steps

1. Align and place the M.2 2230 SSD mounting bracket on to its slot on the palm-rest assembly.
NOTE: For models shipped with M.2 2230 SSD, ensure that the SSD mounting bracket is transferred when the system board is removed or replaced.
2. Align the notch on the M.2 2230 SSD with the tab on the M.2 2230 SSD slot.
3. Replace the screw (M2x4) that secures the M.2.2230 SSD to the SSD mounting bracket and palm-rest assembly.
4. Align the screw holes on the SSD thermal shield with the screw holes on the palm-rest assembly.
5. Replace the three screws (M2x4) that secure the SSD thermal shield to the palm-rest assembly.

Next steps

1. Install the [base cover](#).
2. Install the [SIM-card tray](#), if applicable.
3. Follow the procedure in [After working inside your computer](#).

Removing the M.2 2280 solid state drive

Prerequisites

1. Follow the procedure in [Before working inside your computer](#).
2. Remove the [SIM-card tray](#), if applicable.
3. Remove the [base cover](#).

About this task

The following images indicate the location of the M.2 2280 solid state drive and provide a visual representation of the removal procedure.

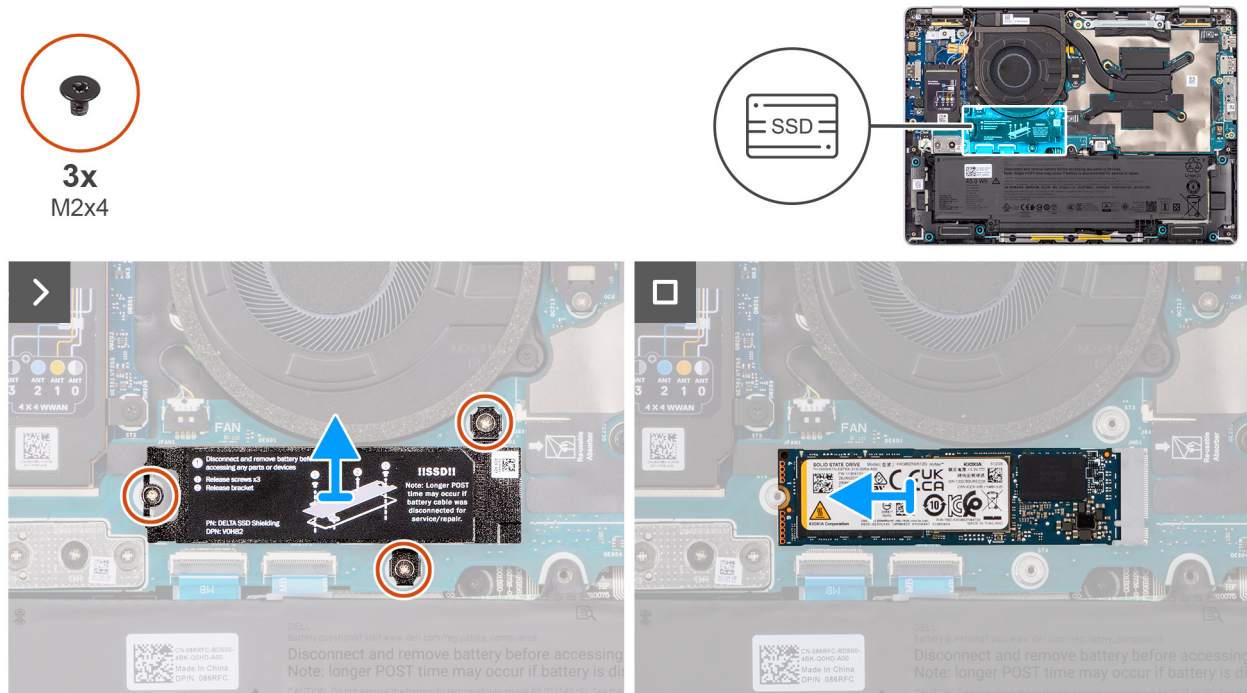

Figure 33. Removing the M.2 2280 SSD

Steps

1. Remove the three screws (M2x4) that secure the SSD thermal shield to the palm-rest assembly.
2. Lift the SSD thermal shield off the SSD.
NOTE: When you replace the SSD, ensure the thermal pad is adhered on the SSD thermal shield before reinstalling the SSD to the computer.
3. Slide and remove the M.2 2280 SSD off the SSD slot.

Installing the M.2 2280 solid state drive

About this task

The following images indicate the location of the M.2 2280 solid state drive and provide a visual representation of the installation procedure.



3x
M2x4

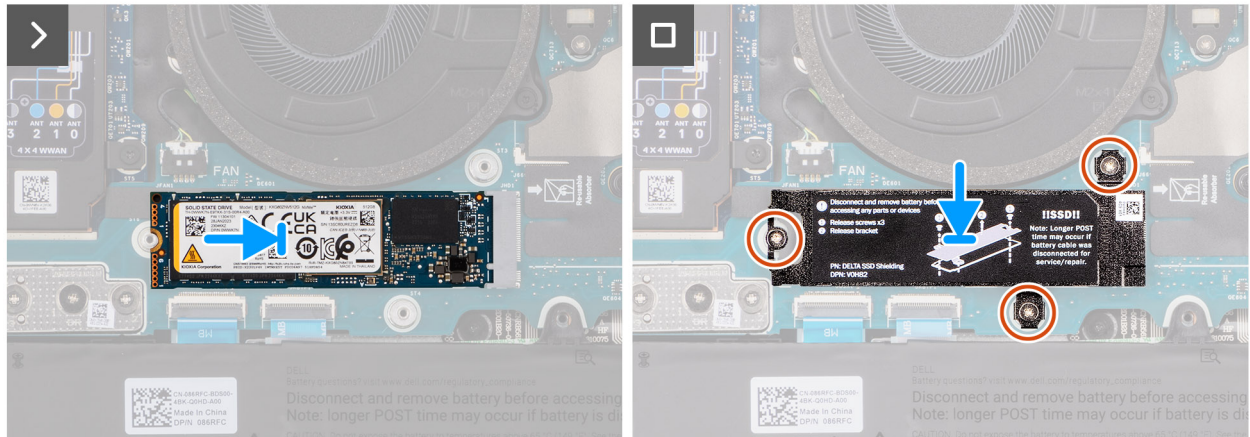
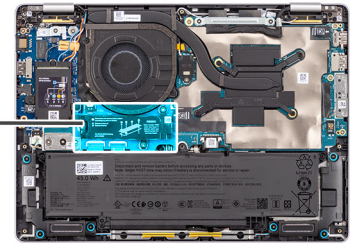
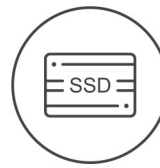

Figure 34. Installing the M.2 2280 SSD

Steps

1. Align the notch on the M.2 2280 SSD with the tab on the M.2 2280 SSD slot.
2. Slide the M.2 2280 SSD into the M.2 2280 SSD slot.
3. Align and place the SSD thermal shield on the SSD.
4. Replace the three screws (M2x4) that secure the SSD thermal shield to the palm-rest assembly.

Next steps

1. Install the [base cover](#).
2. Install the [SIM-card tray](#), if applicable.
3. Follow the procedure in [After working inside your computer](#).

Speakers

Removing the speakers

Prerequisites

1. Follow the procedure in [Before working inside your computer](#).
2. Remove the [SIM-card tray](#), if applicable.
3. Remove the [base cover](#).

About this task

The following image indicates the location of the speakers and provides a visual representation of the removal procedure.



6x
M1.6x1.5

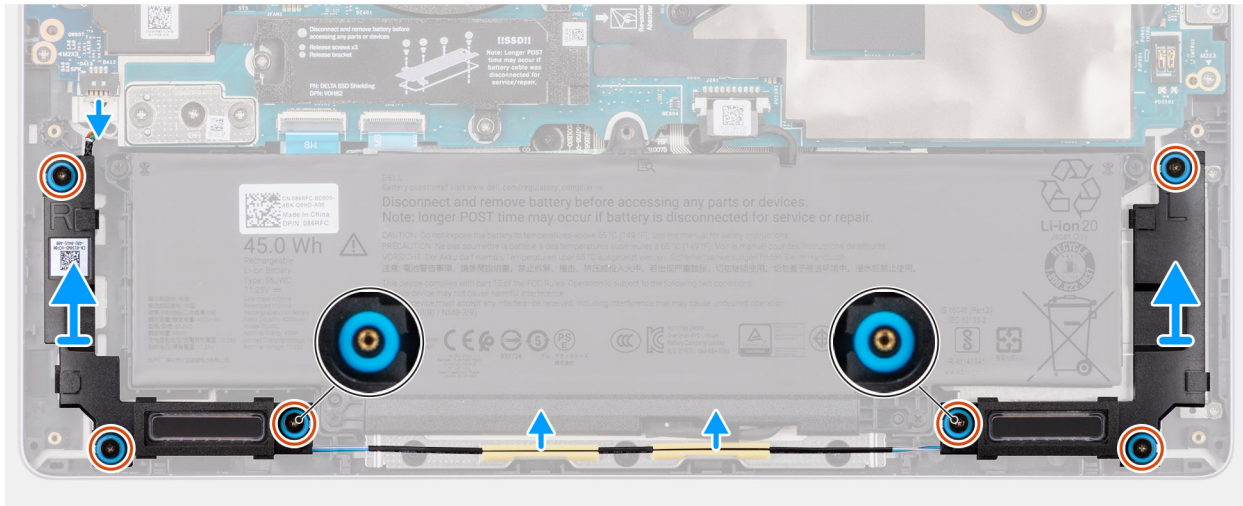
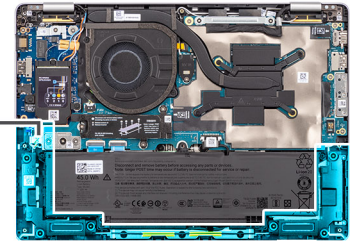
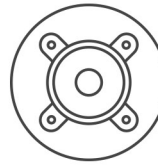

Figure 35. Removing the speakers

Steps

1. Disconnect the speaker cable from the connector on the I/O board.
2. Remove the six screws (M1.6x1.5) that secure the speakers to the palm-rest assembly.
3. Remove the speaker cable from the routing guides on the bottom side of the palm-rest assembly.
4. Release the speakers from the rubber grommets and lift the speakers off the palm-rest assembly.

Installing the speakers

Prerequisites

If you are replacing a component, remove the existing component before performing the installation procedure.

About this task

The following image indicates the location of the speakers and provides a visual representation of the installation procedure.

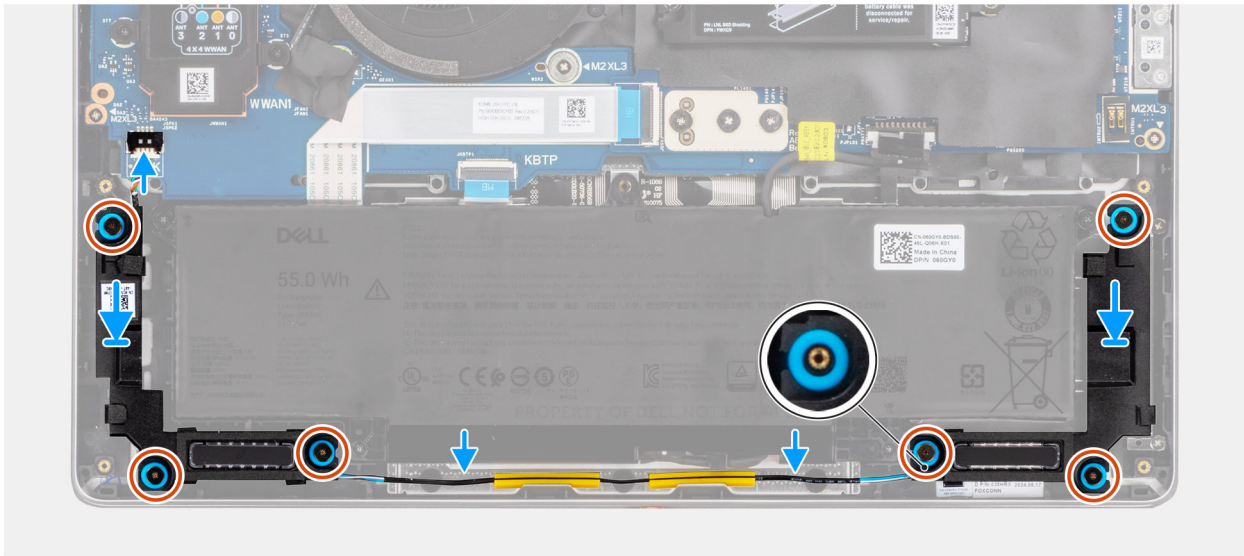
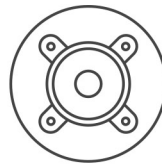
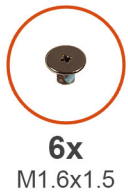

Figure 36. Installing the speakers

Steps

1. Using the alignment posts, place the left and right speakers into their slots on the palm-rest assembly.
 - NOTE:** To properly position the speakers, secure the rubber grommets into the hooks.
 - NOTE:** Ensure that the rubber grommets are seated into the slot and installed on the speakers properly.

Figure 37. Rubber grommets

2. Route the speaker cable through the routing guides on the palm-rest assembly.
3. Replace the six screws (M1.6x1.5) that secure the speakers to the palm-rest assembly.
4. Connect the speaker cable to the connector on the I/O board.

Next steps

1. Install the [base cover](#).
2. Install the [SIM-card tray](#), if applicable.
3. Follow the procedure in [After working inside your computer](#).

Removing and installing Field Replaceable Units (FRUs)

The replaceable components in this chapter are Field Replaceable Units (FRUs).

CAUTION: The information in this section is intended for authorized service technicians only.

CAUTION: To avoid any potential damage to the component or loss of data, ensure that an authorized service technician replaces the Field Replaceable Units (FRUs).

CAUTION: Dell Technologies recommends that these procedures be performed by trained technical repair specialists.

CAUTION: Your warranty does not cover damages that may occur during FRU repairs that are not authorized by Dell Technologies.

NOTE: The images in this document may differ from your computer depending on the configuration you ordered.

Fan

Removing the fan

CAUTION: The information in this removal section is intended for authorized service technicians only.

Prerequisites

1. Follow the procedure in [Before working inside your computer](#).
2. Remove the [SIM-card tray](#), if applicable.
3. Remove the [base cover](#).

About this task

The following image indicates the location of the fan and provides a visual representation of the removal procedure.

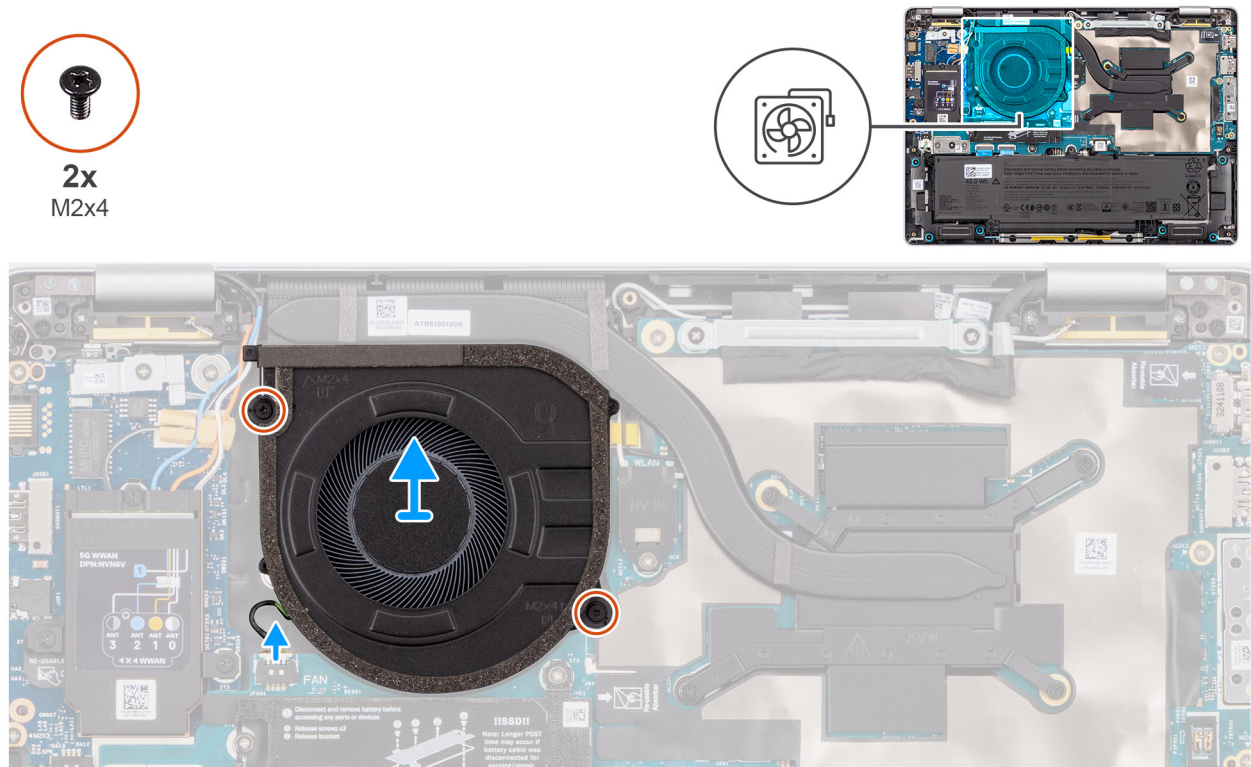

Figure 38. Removing the fan

Steps

1. Disconnect the fan cable from the connector on the system board.
2. Remove the two screws (M2x4) that secure the fan to the palm-rest assembly.
3. Lift the fan off the palm-rest assembly.

Installing the fan

CAUTION: The information in this installation section is intended for authorized service technicians only.

Prerequisites

If you are replacing a component, remove the existing component before performing the installation procedure.

About this task

The following image indicates the location of the fan and provides a visual representation of the installation procedure.

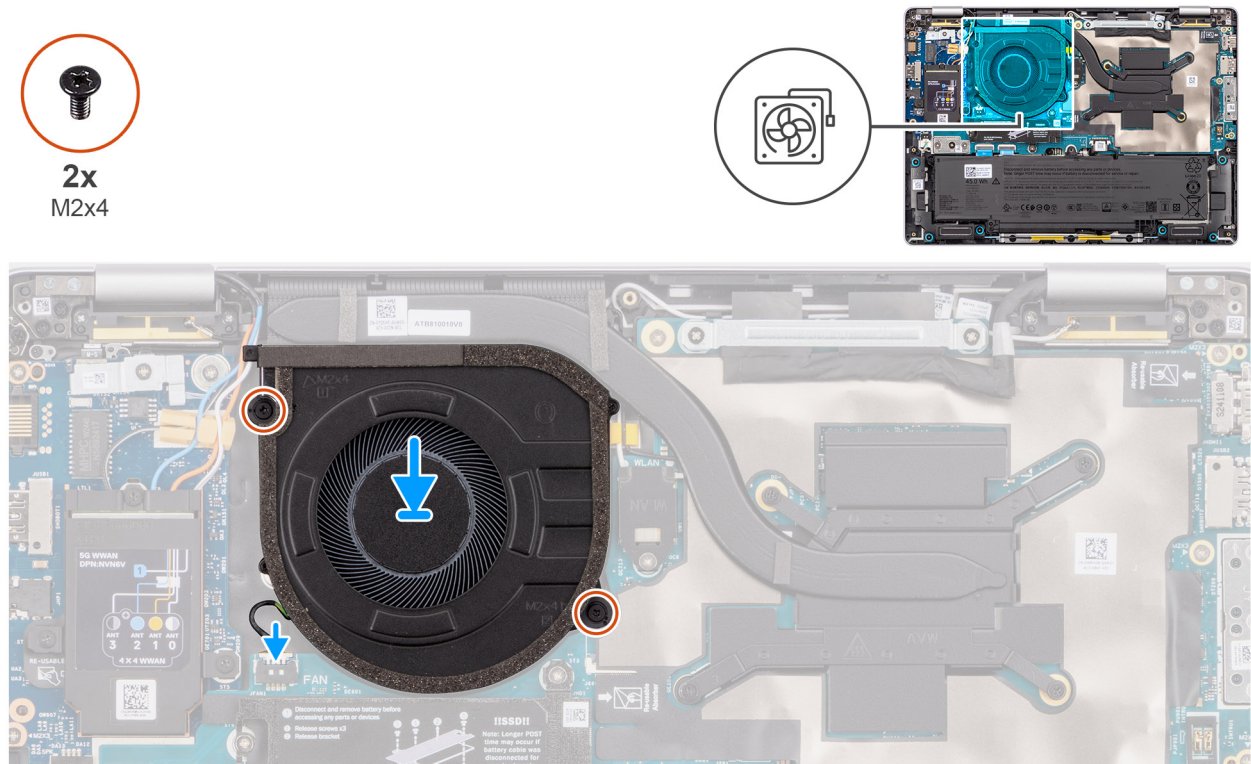

Figure 39. Installing the fan

Steps

1. Align the screw holes on the fan with the screw holes on the palm-rest assembly.
2. Replace the two screws (M2x4) that secure the fan to the palm-rest assembly.
3. Connect the fan cable to the fan-cable connector on the system board.

Next steps

1. Install the [base cover](#).
2. Install the [SIM-card tray](#), if applicable.
3. Follow the procedure in [After working inside your computer](#).

Heat sink

Removing the heat sink

⚠ CAUTION: The information in this removal section is intended for authorized service technicians only.

Prerequisites

1. Follow the procedure in [Before working inside your computer](#).
2. Remove the [SIM-card tray](#), if applicable.
3. Remove the [base cover](#).

About this task

i NOTE: The heat sink may become hot during normal operation. Allow sufficient time for the heat sink to cool before you touch it.

NOTE: For maximum cooling of the processor, do not touch the heat-transfer areas on the heat sink. The oils in your skin can reduce the heat-transfer capability of the thermal grease.

The following image indicates the location of the heat sink and provides a visual representation of the removal procedure.

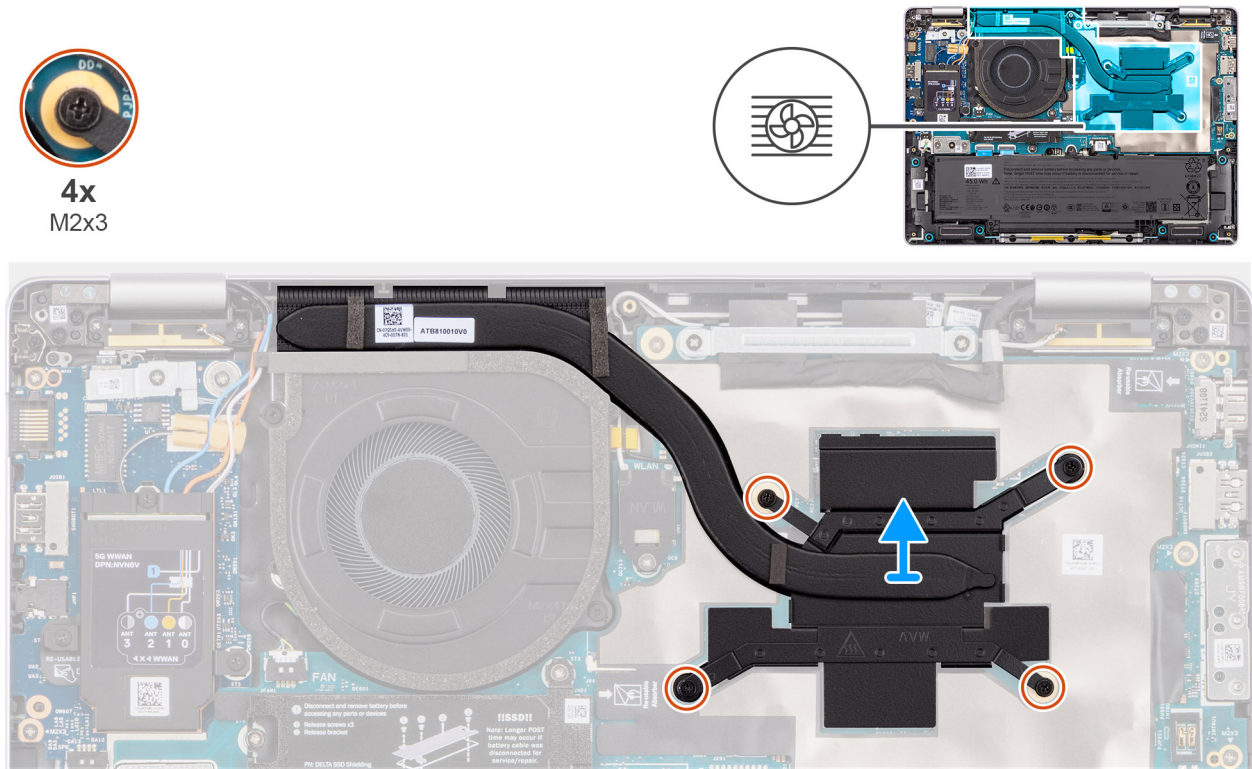

Figure 40. Removing the heat sink

Steps

1. In the reverse sequential order (4 > 3 > 2 > 1), loosen the four captive screws (M2x3) that secure the heat sink to the system board.
2. Lift the heat sink off the system board.

Installing the heat sink

CAUTION: The information in this removal section is intended for authorized service technicians only.

Prerequisites

If you are replacing a component, remove the existing component before performing the installation procedure.

About this task

CAUTION: Incorrect alignment of the heat sink can damage the system board and processor.

NOTE: If either the system board or the heat sink is replaced, use the thermal grease that is provided in the kit to ensure that thermal conductivity is achieved.

The following image indicates the location of the heat sink and provides a visual representation of the installation procedure.



4x
M2x3

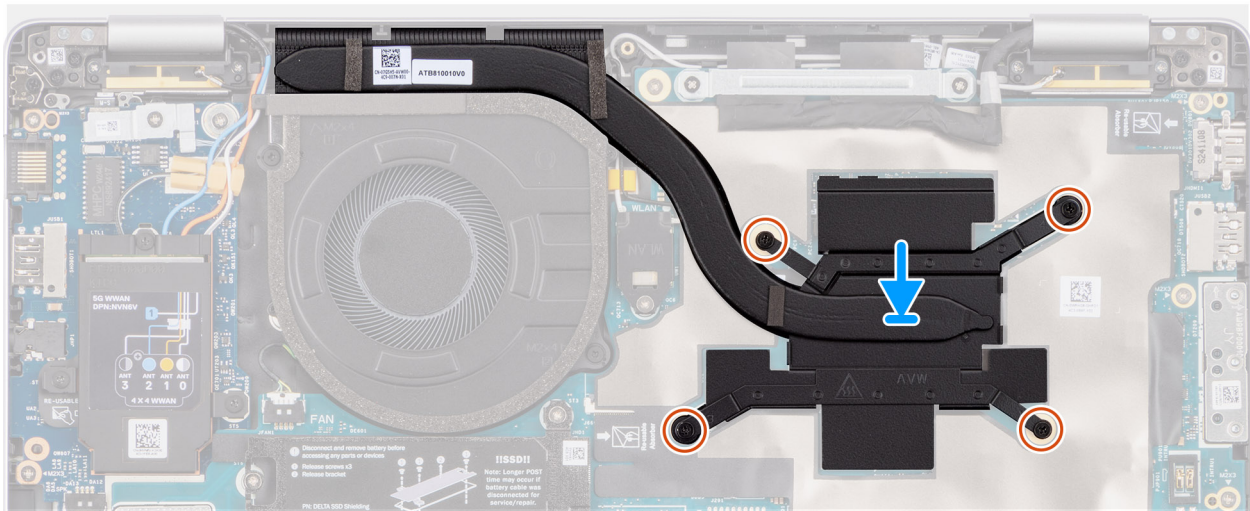
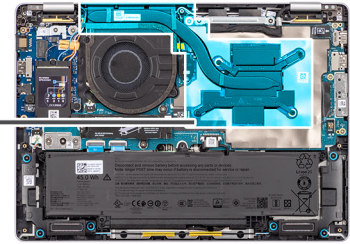
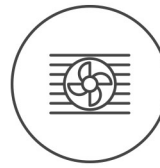

Figure 41. Installing the heat sink

Steps

1. Align the screw holes on the heat sink with the screw holes on the system board.
2. In the sequential order (1 > 2 > 3 > 4), tighten the four captive screws (M2x3) that secure the heat sink to the system board.

Next steps

1. Install the [base cover](#).
2. Install the [SIM-card tray](#), if applicable.
3. Follow the procedure in [After working inside your computer](#).

USH board

Removing the USH board

⚠ CAUTION: The information in this removal section is intended for authorized service technicians only.

Prerequisites

1. Follow the procedure in [Before working inside your computer](#).
2. Remove the [SIM-card tray](#), if applicable.
3. Remove the [base cover](#).
4. Remove the [battery](#).

About this task

The following images indicate the location of the USH board and provide a visual representation of the removal procedure.



2x
M1.6x1.5

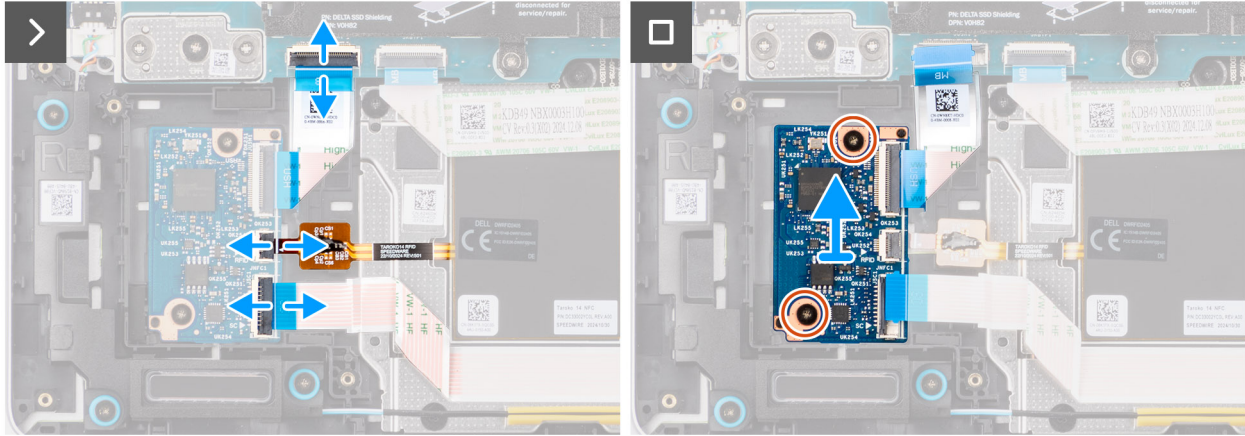
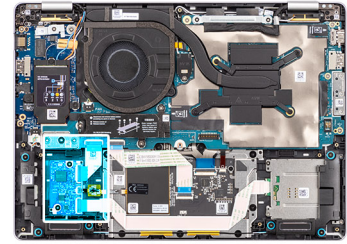

Figure 42. Removing the USH board

Steps

1. Open the latch and disconnect the smart card reader cable from the connector on the USH board.
i **NOTE:** This step applies only to computers shipped with smart card reader installed.
2. Open the latch and disconnect the NFC-sensor cable from the connector on the USH board.
i **NOTE:** This step applies only to computers shipped with NFC sensor installed.
3. Open the latch and disconnect the USH-board cable from the connector on the system board.
4. Gently peel off the USH-board cable from the system chassis.
5. Remove the two screws (M1.6x1.5) that secure the USH board to the palm-rest assembly.
6. Lift the USH board off the palm-rest assembly.

Installing the USH board

⚠ CAUTION: The information in this installation section is intended for authorized service technicians only.

About this task

The following images indicate the location of the USH board and provide a visual representation of the installation procedure.



2x
M1.6x1.5

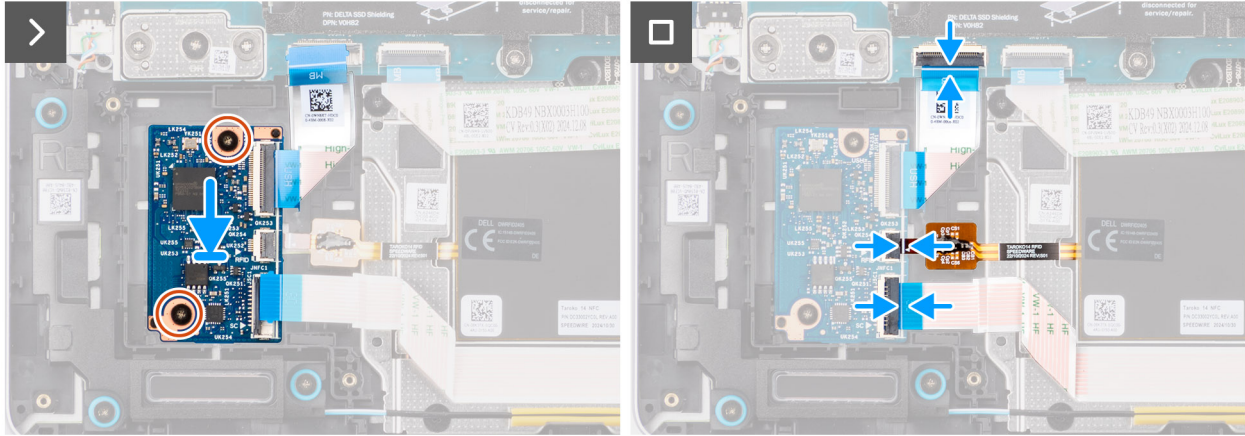
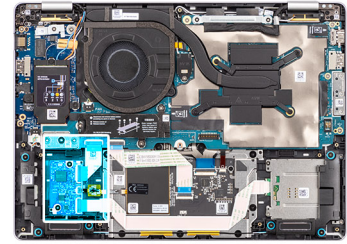

Figure 43. Installing the USH board

Steps

1. Align and place the USH board on the palm-rest assembly.
2. Replace the two screws (M1.6x1.5) that secure the USH board to the palm-rest assembly.
3. Connect the USH-board cable to the connector on the system board and close the latch to secure the cable.
4. Connect the NFC-sensor cable to the connector on the USH board and close the latch to secure the cable.
5. Connect the smart card reader cable to the connector on the USH board and close the latch to secure the cable.

NOTE: This step applies only to computers shipped with NFC sensor installed.

NOTE: This step applies only to computers shipped with smart card reader installed.

Next steps

1. Install the [battery](#).
2. Install the [base cover](#).
3. Install the [SIM-card tray](#), if applicable.
4. Follow the procedure in [After working inside your computer](#).

Smart card reader

Removing the smart card reader

CAUTION: The information in this removal section is intended for authorized service technicians only.

Prerequisites

1. Follow the procedure in [Before working inside your computer](#).
2. Remove the [SIM-card tray](#), if applicable.
3. Remove the [base cover](#).

4. Remove the [battery](#).

About this task

NOTE: This procedure applies only to computers shipped with a smart card reader installed.

The following images indicate the location of the smart card reader and provide a visual representation of the removal procedure.

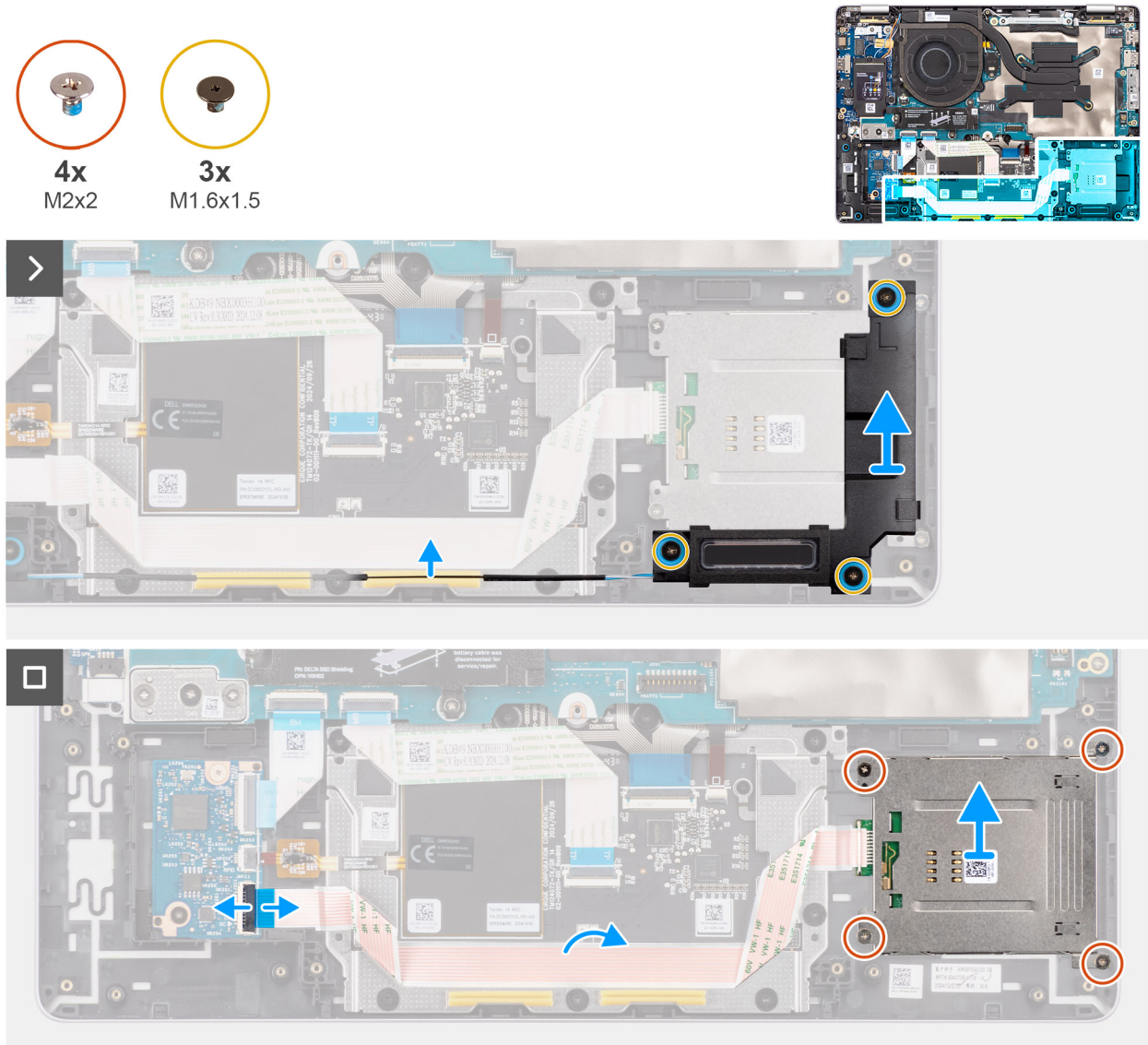

Figure 44. Removing the smart card reader

Steps

1. Remove the three screws (M1.6x1.5) that secure the speaker to the palm-rest assembly.
2. Release the speaker from the rubber grommets and remove the speaker cable from the routing guides on the palm-rest assembly.
3. Carefully remove the speaker and place it away from the palm-rest assembly.
4. Open the latch and disconnect the smart card reader cable from the USH board.
5. Gently peel the smart card reader cable from the palm-rest assembly.
6. Remove the four screws (M2x2) that secure the smart card reader to the palm-rest assembly.
7. Lift the smart card reader, along with its cable, off the palm-rest assembly.

Installing the smart card reader

CAUTION: The information in this installation section is intended for authorized service technicians only.

Prerequisites

If you are replacing a component, remove the existing component before performing the installation procedure.

About this task

NOTE: If the rubber grommets are pushed out when removing the speaker, push them back in before replacing the speaker.

The following images indicate the location of the smart card reader and provide a visual representation of the installation procedure.

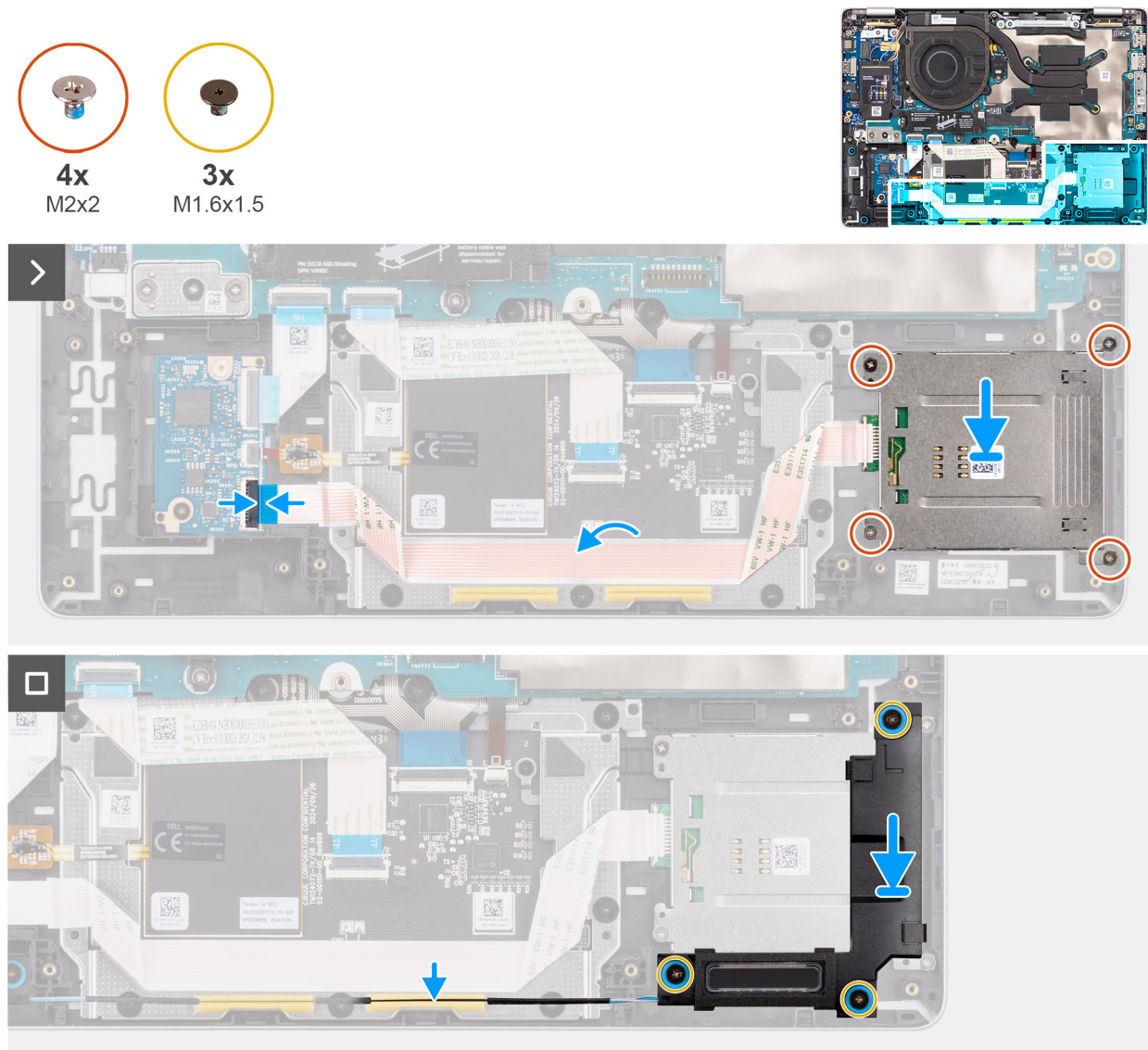

Figure 45. Installing the smart card reader

Steps

1. Align and place the smart card reader on the palm-rest assembly.
2. Replace the four screws (M2x2) that secure the smart card reader to the palm-rest assembly.
3. Connect the smart card reader cable to the connector on the USB board and close the latch to secure the cable.

4. Using the alignment posts and rubber grommets, place the speaker into the slot on the palm-rest assembly.
- NOTE:** Ensure that the rubber grommets on the speaker are threaded through the alignment posts. Ensure that the rubber grommets are seated into the slot and installed on the speaker properly.
5. Route the speaker cable through the routing guides on the palm-rest assembly.
 6. Replace the three screws (M1.6x1.5) that secure the speaker to the palm-rest assembly.

Next steps

1. Install the [battery](#).
2. Install the [base cover](#).
3. Install the [SIM-card tray](#), if applicable.
4. Follow the procedure in [After working inside your computer](#).

System board

Removing the system board

CAUTION: The information in this removal section is intended for authorized service technicians only.

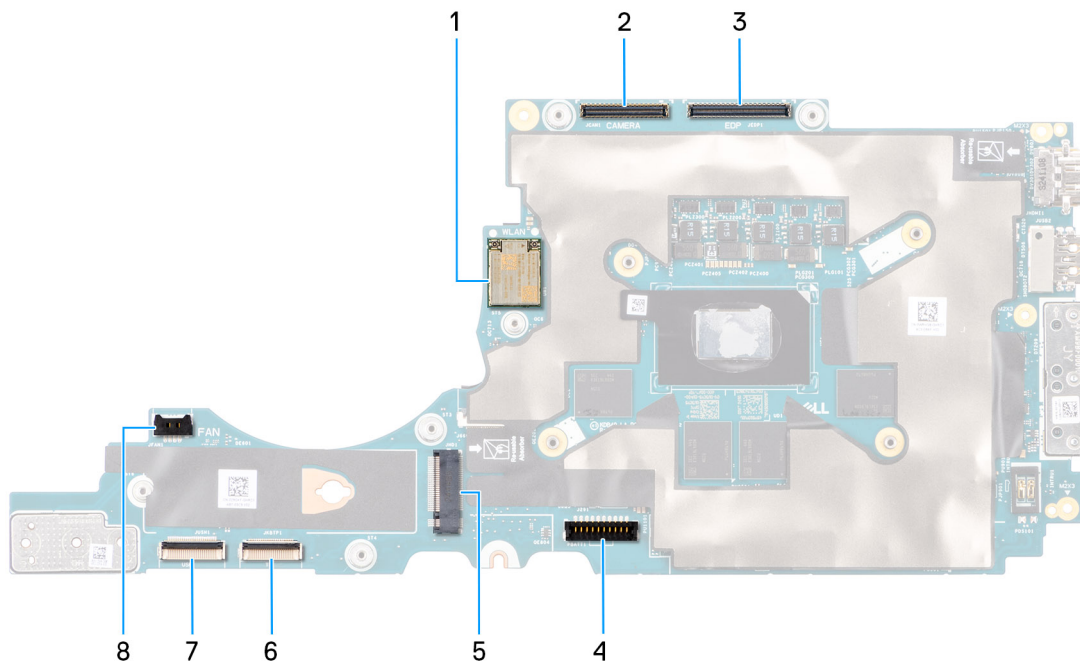

Figure 46. System board slots and connectors

1. WLAN-card slot
2. Camera-cable connector
3. Display-cable connector
4. Battery-cable connector
5. Solid State Drive connector
6. Touchpad-cable connector
7. USB board-cable connector
8. Fan-cable connector

Prerequisites

1. Follow the procedure in [Before working inside your computer](#).
2. Remove the [SIM-card tray](#), if applicable.
3. Remove the [base cover](#).
4. Remove the [battery](#).
5. Remove the [M.2 2230 solid state drive](#) or [M.2 2280 solid state drive](#), as applicable.
6. Remove the [heat sink](#).

About this task

The following image indicates the location of the system board and provides a visual representation of the removal procedure.

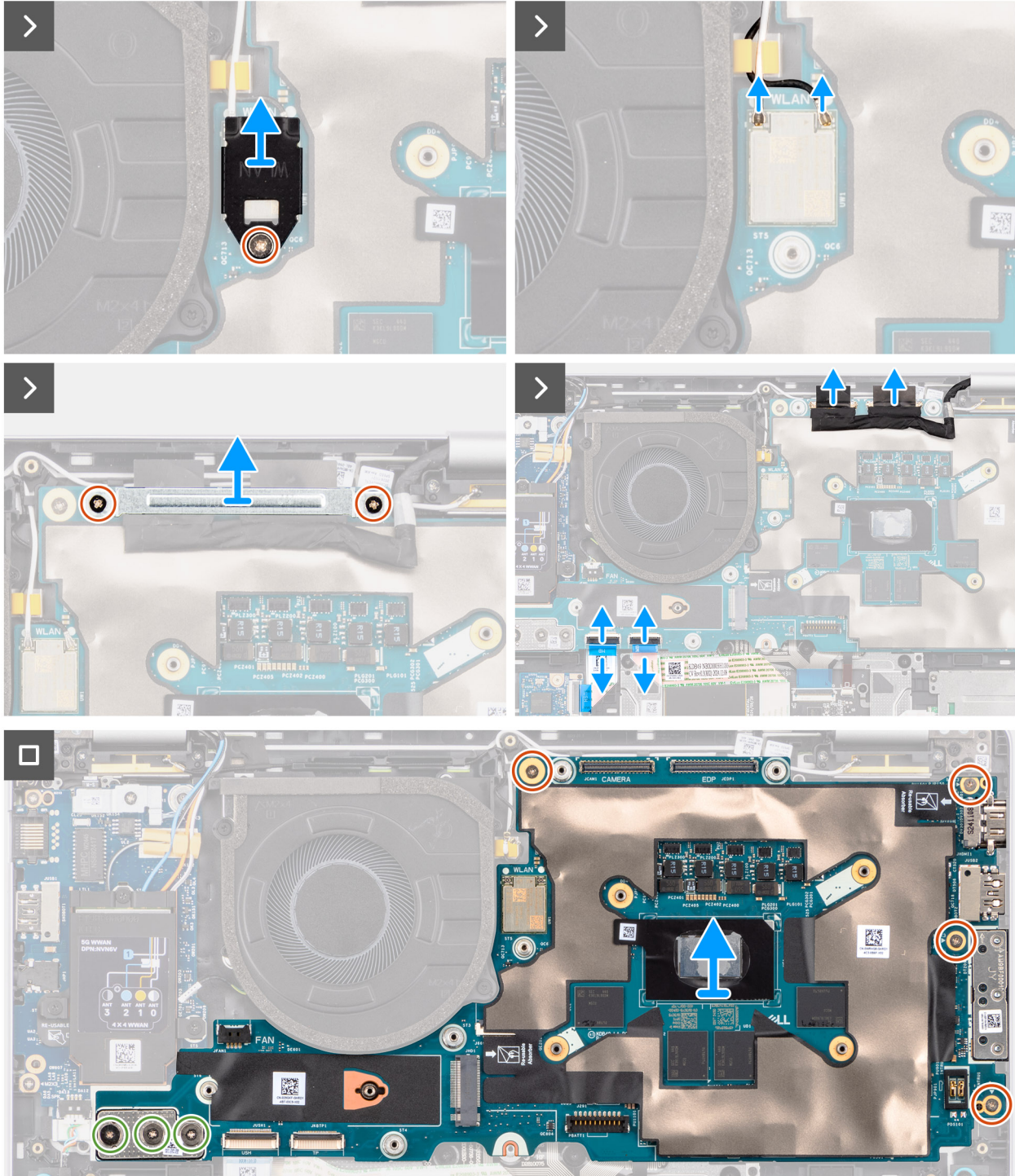
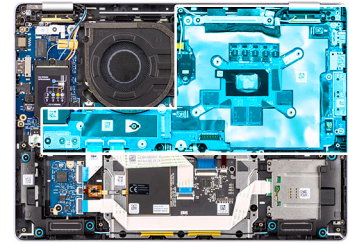

Figure 47. Removing the system board

Steps

1. Remove the screw (M2x3) that secures the WLAN bracket to the palm-rest assembly.
2. Remove the WLAN bracket off the palm-rest assembly.
3. Disconnect the WLAN antenna cables from the WLAN module on the system board.
4. Remove the two screws (M2x3) that secure the display-cable bracket to the palm-rest assembly.
5. Lift the display-cable bracket off the palm-rest assembly.
6. Disconnect the display cable, camera cable, touchpad cable, and USH-board cable (for models shipped with a USH board) from the connectors on the system board.
7. For laptops shipped without WWAN configuration, remove the four screws (M2x3) and two screws (M2x4) that secure the system board to the palm-rest assembly.
8. For laptops shipped with WWAN configuration, remove the four screws (M2x3) and three screws (M2x4) that secure the system board to palm-rest assembly.
9. Carefully lift the system board off the palm-rest assembly.

NOTE: When replacing the system board, do not remove the USB Type-C connector module or transfer it to the replacement system board. The USB Type-C connector module is pre-assembled in the replacement system board.

Installing the system board

CAUTION: The information in this installation section is intended for authorized service technicians only.

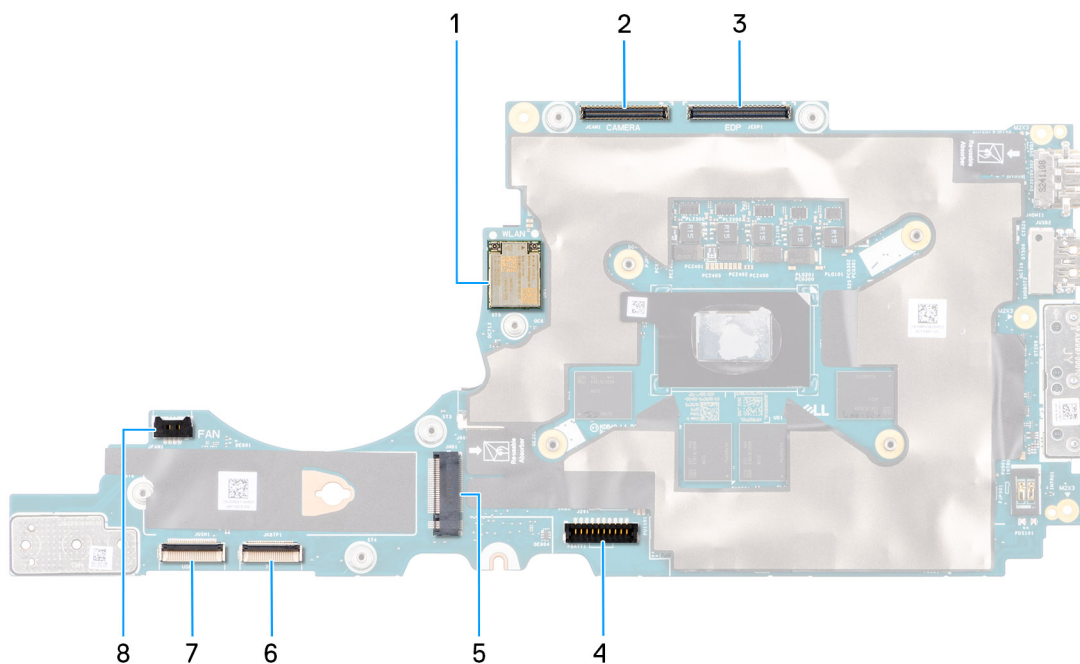

Figure 48. System board slots and connectors

1. WLAN-card slot
2. Camera-cable connector
3. Display-cable connector
4. Battery-cable connector
5. Solid State Drive slot
6. Touchpad-cable connector
7. USH board-cable connector
8. Fan-cable connector

About this task

The following image indicates the location of the system board and provides a visual representation of the installation procedure.

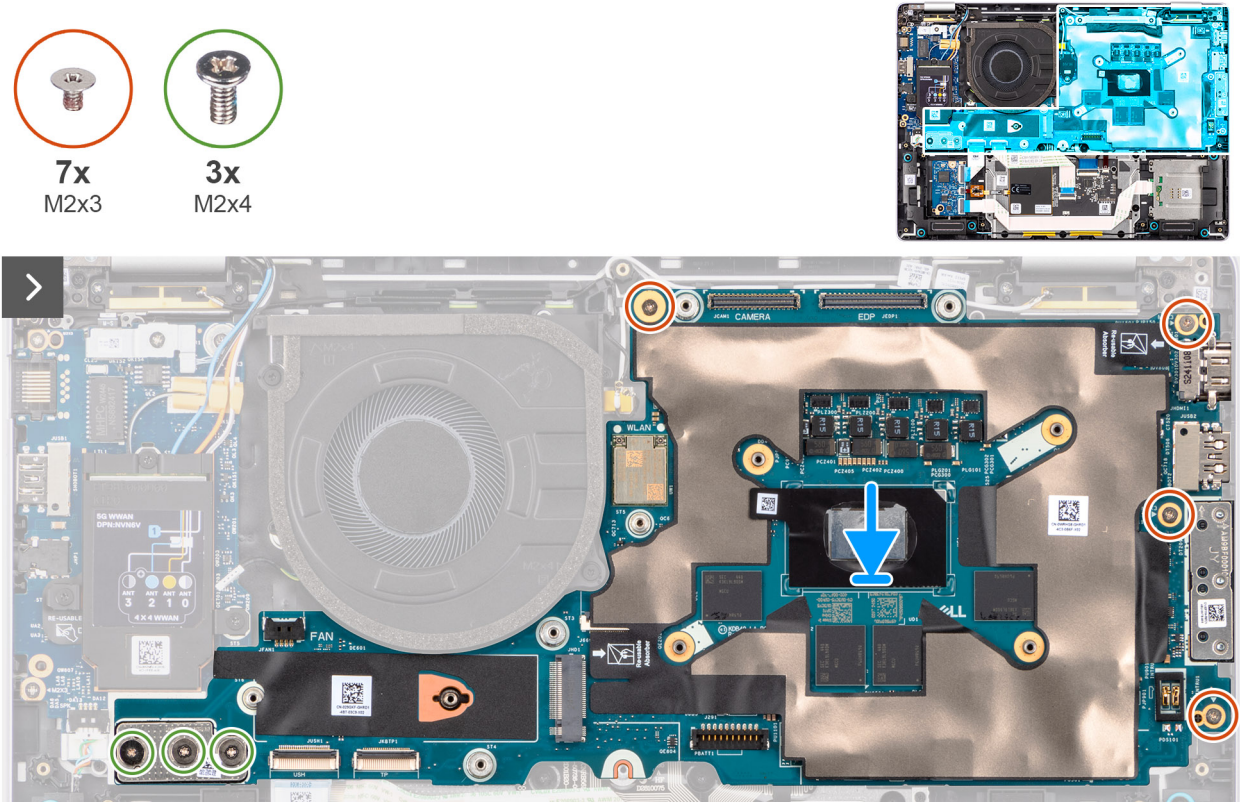

Figure 49. Installing the system board

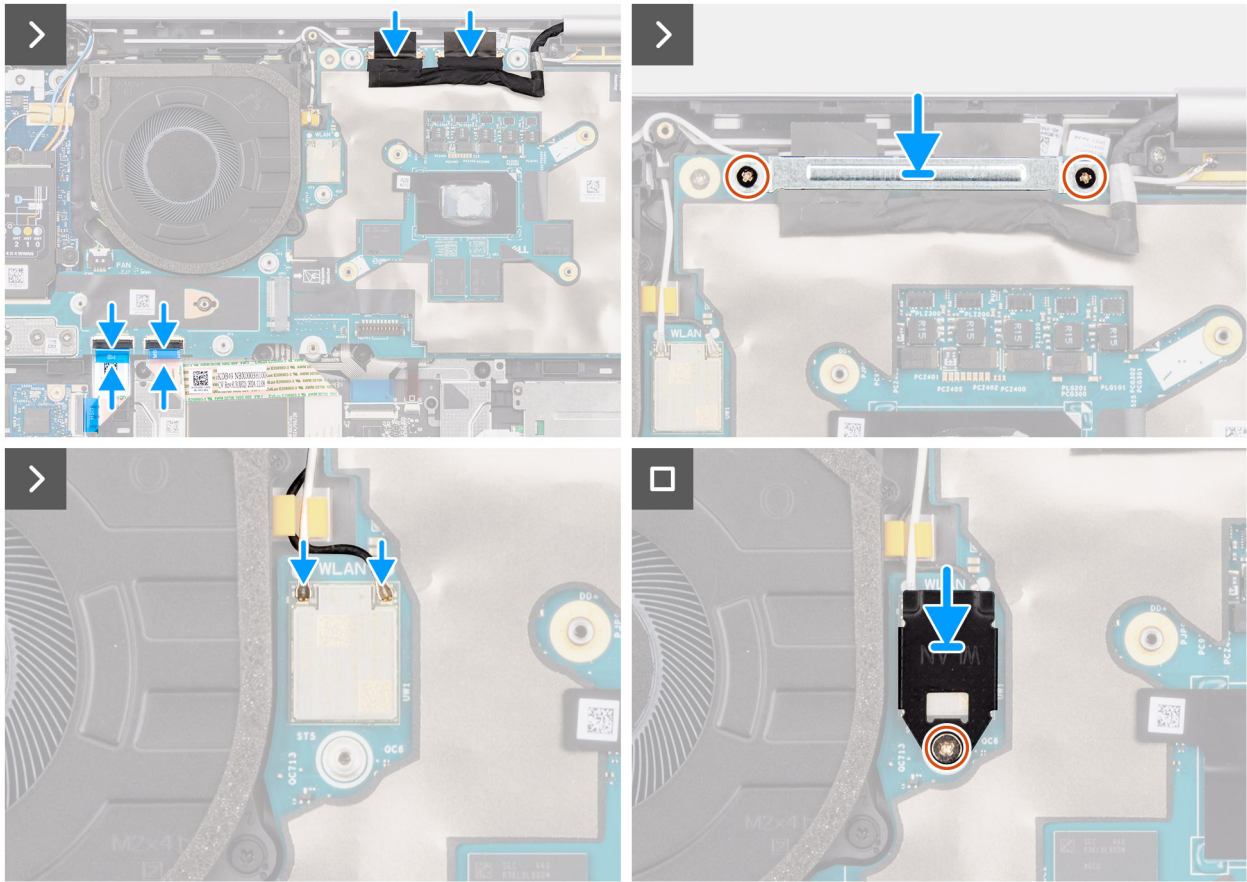

Figure 50. Installing the system board

Steps

1. Align and place the system board on its slot on the palm-rest assembly.
2. For laptops shipped with WWAN configuration, replace the four screws (M2x3) and three screws (M2x4) that secure the system board to the palm-rest assembly.
 - NOTE:** When installing the system board, follow the number markings on the system board-to-I/O board connector bracket to install the three screws (M2x4) in the sequential order 1 > 2 > 3.
3. For laptops shipped without WWAN configuration, replace the four screws (M2x3) and two screws (M2x4) that secure the system board to the palm-rest assembly.
4. Connect the display cable, camera cable, touchpad cable, and USH-board cable (for models shipped with a USH board) to the connectors on the system board.
5. Align the screw hole on the display-cable bracket with the screw hole on the palm-rest assembly.
6. Replace the two screws (M2x3) that secure the display-cable bracket to the palm-rest assembly.
7. Connect the WLAN antenna cables to the WLAN module on the system board.
8. Align and place the WLAN bracket on the WLAN antenna cable.
9. Replace the screw (M2x3) that secure the WLAN bracket to the palm-rest assembly.

Next steps

1. Install the [heat sink](#).
2. Install the [M.2 2230 solid state drive](#) or [M.2 2280 solid state drive](#), as applicable.
3. Install the [battery](#).
4. Install the [base cover](#).
5. Install the [SIM-card tray](#), if applicable.
6. Follow the procedure in [After working inside your computer](#).

Wireless Local Area Network (WLAN) antenna modules

Removing the WLAN antenna modules

CAUTION: The information in this removal section is intended for authorized service technicians only.

Prerequisites

1. Follow the procedure in [Before working inside your computer](#).
2. Remove the [SIM-card tray](#), if applicable.
3. Remove the [base cover](#).
4. Remove the [battery](#).
5. Remove the [M.2 2230 solid state drive](#) or [M.2 2280 solid state drive](#), as applicable.
6. Remove the [5G WWAN card](#) or [4G WWAN card](#), as applicable.
7. Remove the [system board](#).

NOTE: The system board can be removed and installed with the heat sink attached in order to simplify the procedure and preserve the thermal bond between the system board and heat sink.

About this task

The following image indicates the location of the WLAN antenna modules and provides a visual representation of the removal procedure.

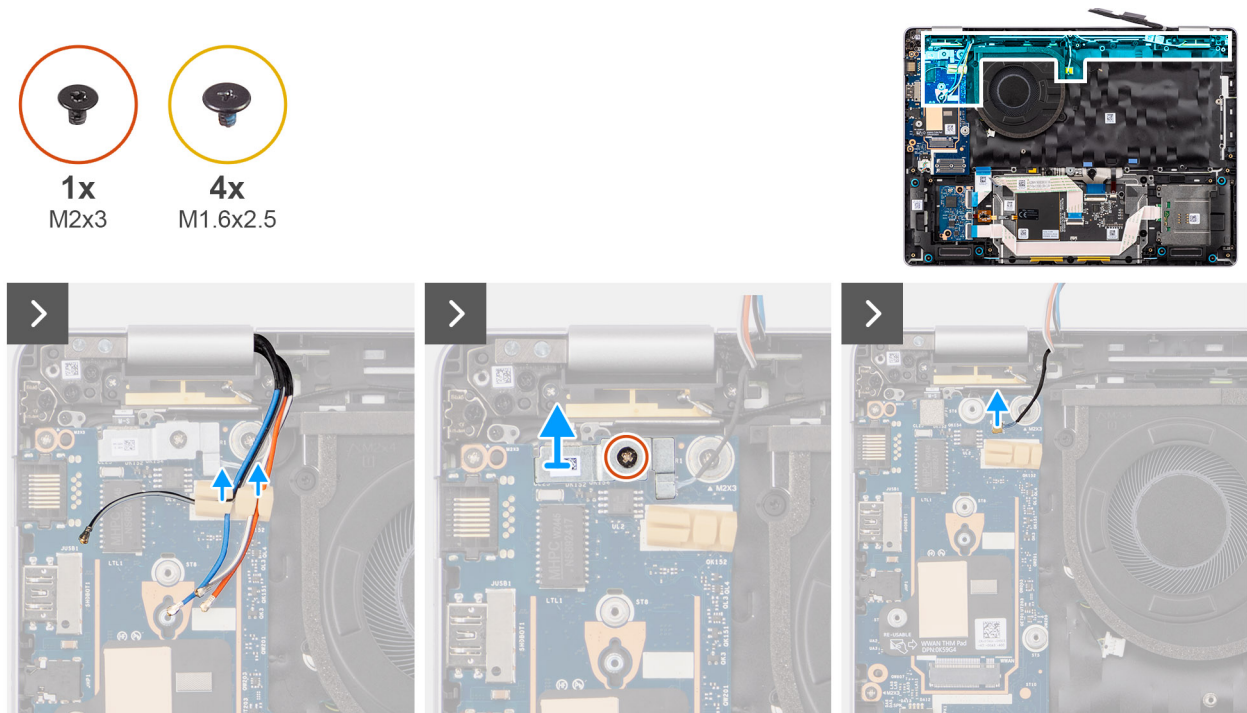

Figure 51. Removing the WLAN antenna modules

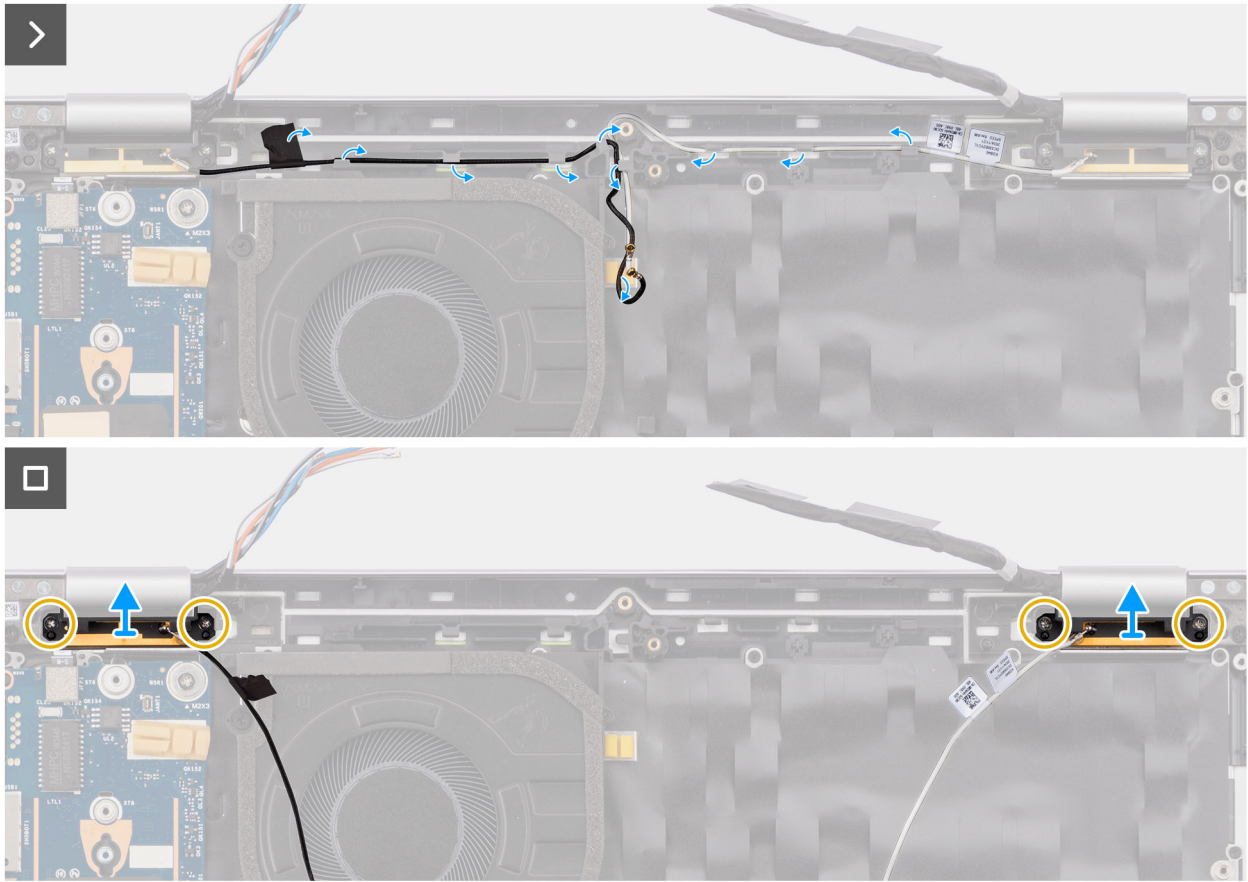

Figure 52. Removing the WLAN antenna modules

Steps

1. Remove the WWAN antenna cables from the routing guides on the I/O board.
2. Remove the screw (M2x3) that secures the fingerprint-reader bracket to the palm-rest assembly.
3. Lift the fingerprint-reader bracket off the palm-rest assembly.
4. Disconnect the Darwin cable from connector on the I/O board.
5. Peel the tape that secures the antenna cables to the palm-rest assembly.
6. Remove the antenna cable from the routing guides on the palm-rest assembly.
7. Remove the four screws (M1.6x2.5) that secure the WLAN antenna modules to the palm-rest assembly.
8. Lift the WLAN antenna modules along with the antenna cable, off the palm-rest assembly.

Installing the WLAN antenna modules

CAUTION: The information in this removal section is intended for authorized service technicians only.

Prerequisites

If you are replacing a component, remove the existing component before performing the installation procedure.

About this task

The following image indicates the location of the WLAN antenna modules and provides a visual representation of the installation procedure.

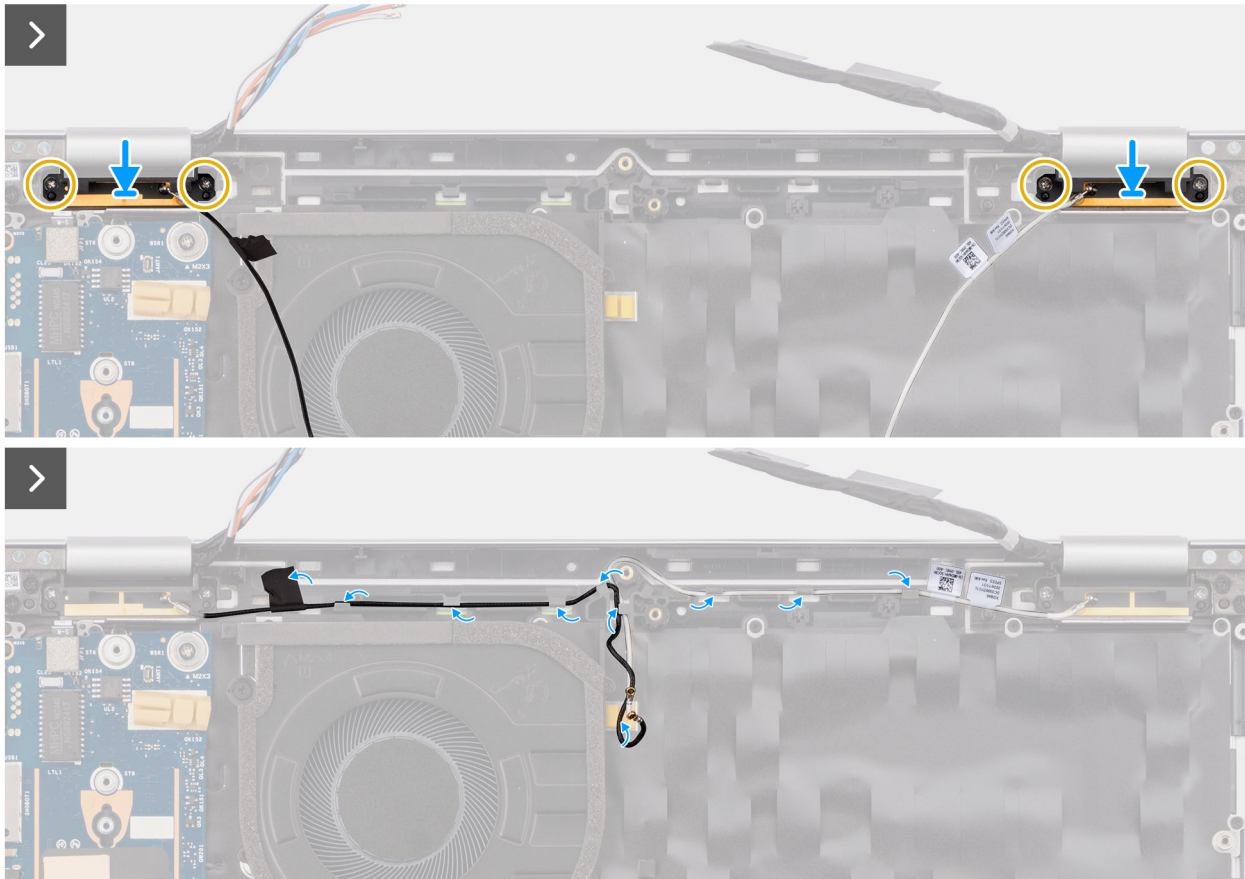
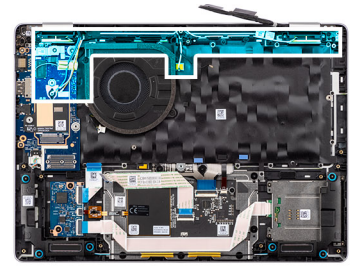

Figure 53. Installing the WLAN antenna modules

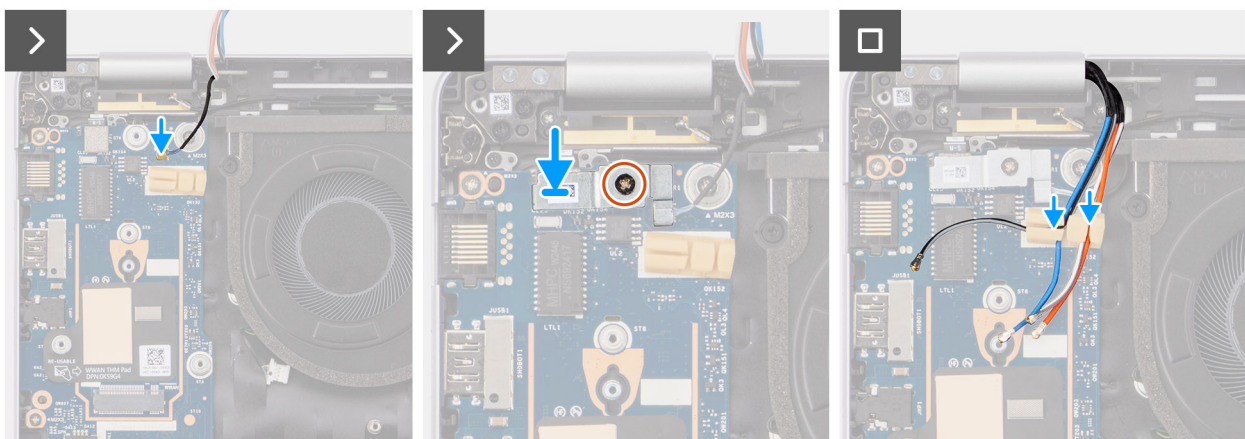

Figure 54. Installing the WLAN antenna modules

Steps

1. Align and place the WLAN antenna modules on to its slot on the palm-rest assembly.

2. Replace the four screws (M1.6x2.5) that secure the WLAN antenna modules to the palm-rest assembly.
3. Route the WLAN antenna cables through the routing guides on the palm-rest assembly.
4. Adhere the tape that secures the antenna cable to the palm-rest assembly.
5. Connect the Darwin cable to the connector on the I/O board.
6. Replace the screw (M2x3) that secures the fingerprint-reader bracket to the I/O board.
7. Route the WWAN antenna cables through the routing guides on the I/O board.

Next steps

1. Install the [system board](#).

 **NOTE:** The system board can be removed and installed with the heat sink attached in order to simplify the procedure and preserve the thermal bond between the system board and heat sink.

2. Install the [5G WWAN card](#) or [4G WWAN card](#), as applicable.
3. Install the [M.2 2230 solid state drive](#) or [M.2 2280 solid state drive](#), as applicable.
4. Install the [battery](#).
5. Install the [base cover](#).
6. Install the [SIM-card tray](#), if applicable.
7. Follow the procedure in [After working inside your computer](#).

USB Type-C connector module

Removing the USB Type-C connector module

 **CAUTION:** The information in this removal section is intended for authorized service technicians only.

Prerequisites

1. Follow the procedure in [Before working inside your computer](#).
2. Remove the [SIM-card tray](#), if applicable.
3. Remove the [base cover](#).
4. Remove the [battery](#).
5. Remove the [M.2 2230 solid state drive](#) or [M.2 2280 solid state drive](#), as applicable.
6. Remove the [system board](#).

 **NOTE:** The system board can be removed and installed with the heat sink attached in order to simplify the procedure and preserve the thermal bond between the system board and heat sink.

About this task

The following images indicate the location of the USB Type-C connector module and provide a visual representation of the removal procedure.



3x
M2x5

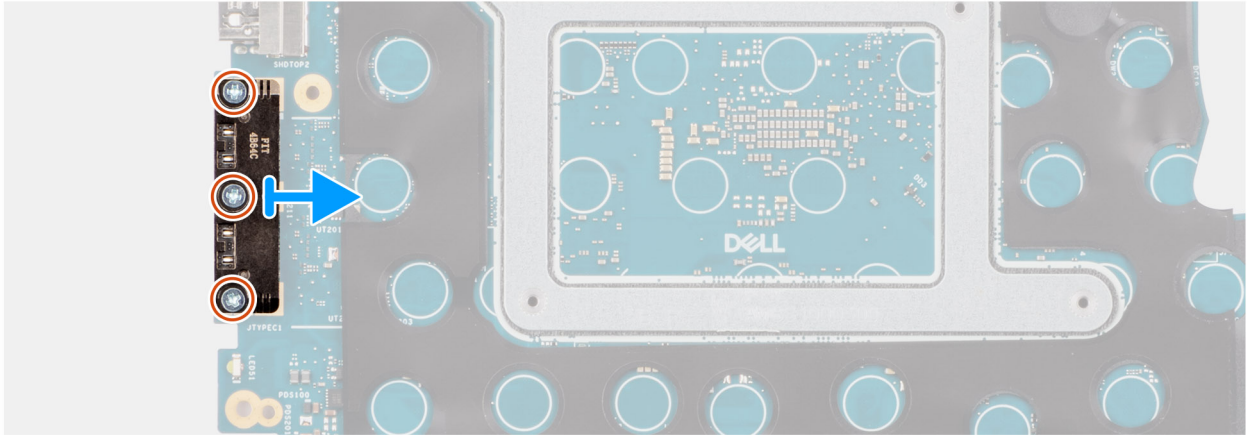

Figure 55. Removing the USB Type-C connector module

Steps

1. Turn the system board over.
2. Remove the three screws (M2x5) that secure the USB Type-C connector module to the system board.
3. Remove the USB Type-C connector module off the system board.

Installing the USB Type-C connector module

CAUTION: The information in this installation section is intended for authorized service technicians only.

Prerequisites

If you are replacing a component, remove the existing component before performing the installation procedure.

About this task

The following images indicate the location of the USB Type-C connector module and provide a visual representation of the installation procedure.



3x
M2x5

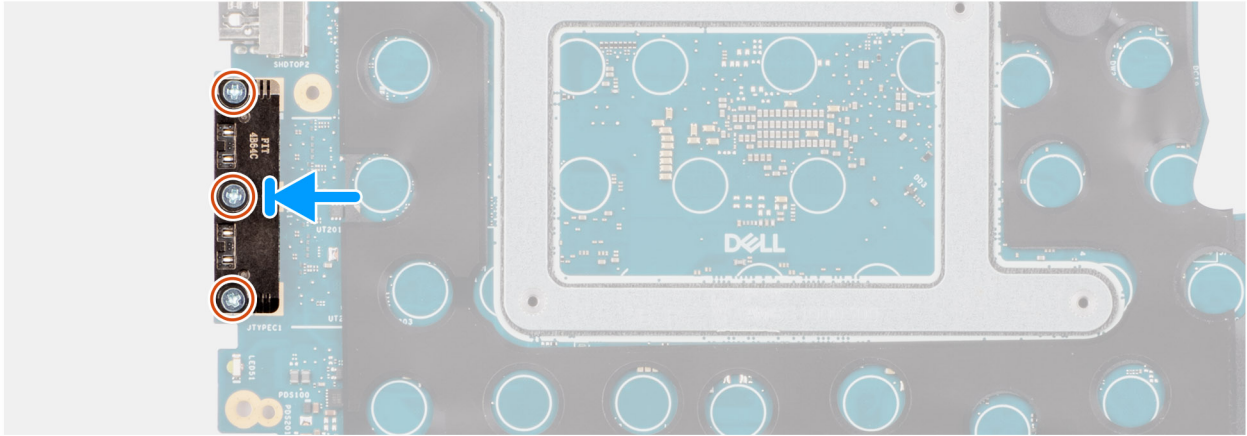

Figure 56. Installing the USB Type-C connector module

Steps

1. Place the USB Type-C connector module onto the slot on the bottom side of the system board.
2. Replace the three screws (M2x5) that secure the USB Type-C connector module to the bottom side of the system board.
3. Turn the system board over.

Next steps

1. Install the [system board](#).

NOTE: The system board can be removed and installed with the heat sink attached in order to simplify the procedure and preserve the thermal bond between the system board and heat sink.

2. Install the [M.2 2230 solid state drive](#) or [M.2 2280 solid state drive](#), as applicable.
3. Install the [battery](#).
4. Install the [base cover](#).
5. Install the [SIM-card tray](#), if applicable.
6. Follow the procedure in [After working inside your computer](#).

I/O board

Removing the I/O board

CAUTION: The information in this removal section is intended for authorized service technicians only.

Prerequisites

1. Follow the procedure in [Before working inside your computer](#).
2. Remove the [SIM-card tray](#), if applicable.
3. Remove the [base cover](#).
4. Remove the [battery](#).
5. Remove the [5G WWAN card](#) or [4G WWAN card](#), as applicable.

6. Remove the [M.2 2230 solid state drive](#) or [M.2 2280 solid state drive](#), as applicable.
7. Remove the [system board](#).

NOTE: The system board can be removed and installed with the heat sink attached in order to simplify the procedure and preserve the thermal bond between the system board and heat sink.

About this task

The following images indicate the location of the I/O board and provide a visual representation of the removal procedure.

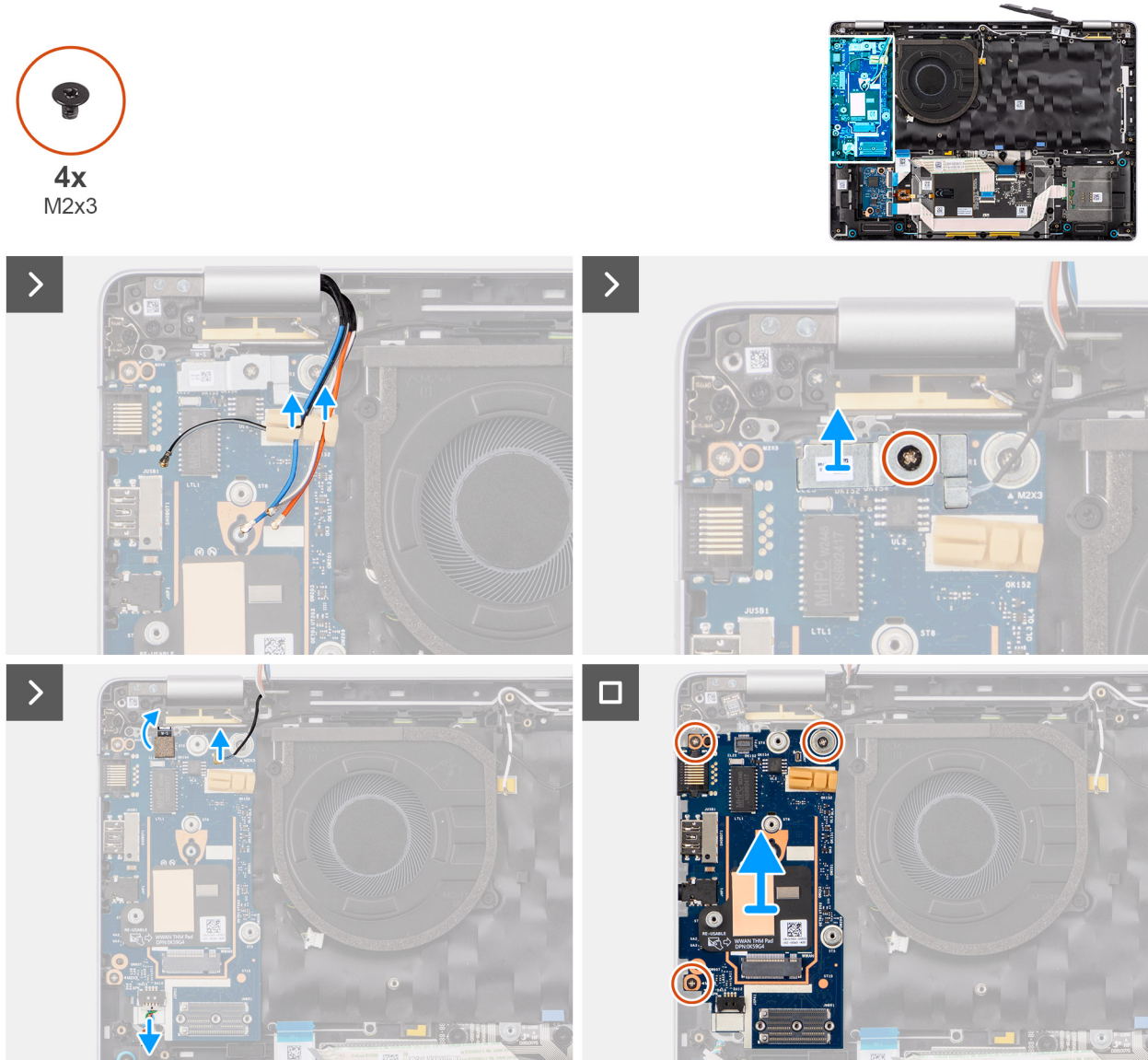

Figure 57. Removing the I/O board

Steps

1. Remove the WWAN antenna cables from the routing guides on the I/O board and move it away from the I/O board.
2. Remove the screw (M2x3) that secures the fingerprint-reader bracket to the I/O board. Lift the fingerprint-reader bracket off the I/O board.

NOTE: The fingerprint-reader bracket covers the fingerprint-reader connector and the Darwin-cable connector. Models that are shipped without fingerprint reader will still have a fingerprint-reader bracket that covers the Darwin-cable connector.
3. Disconnect the fingerprint-reader cable from the connector on the I/O board.

4. Disconnect the Darwin cable from the connector on the I/O board.
5. Disconnect the speaker cable from the connector on the I/O board.
6. Remove the three screws (M2x3) that secure the I/O board to the palm-rest assembly.
7. Carefully slide and remove the I/O board at angle from the palm-rest assembly.

NOTE: When replacing the I/O board, the WWAN-card thermal pad and Mylar tape must be transferred to the replacement I/O board.

Installing the I/O board

CAUTION: The information in this installation section is intended for authorized service technicians only.

About this task

The following images indicate the location of the I/O board and provide a visual representation of the installation procedure.

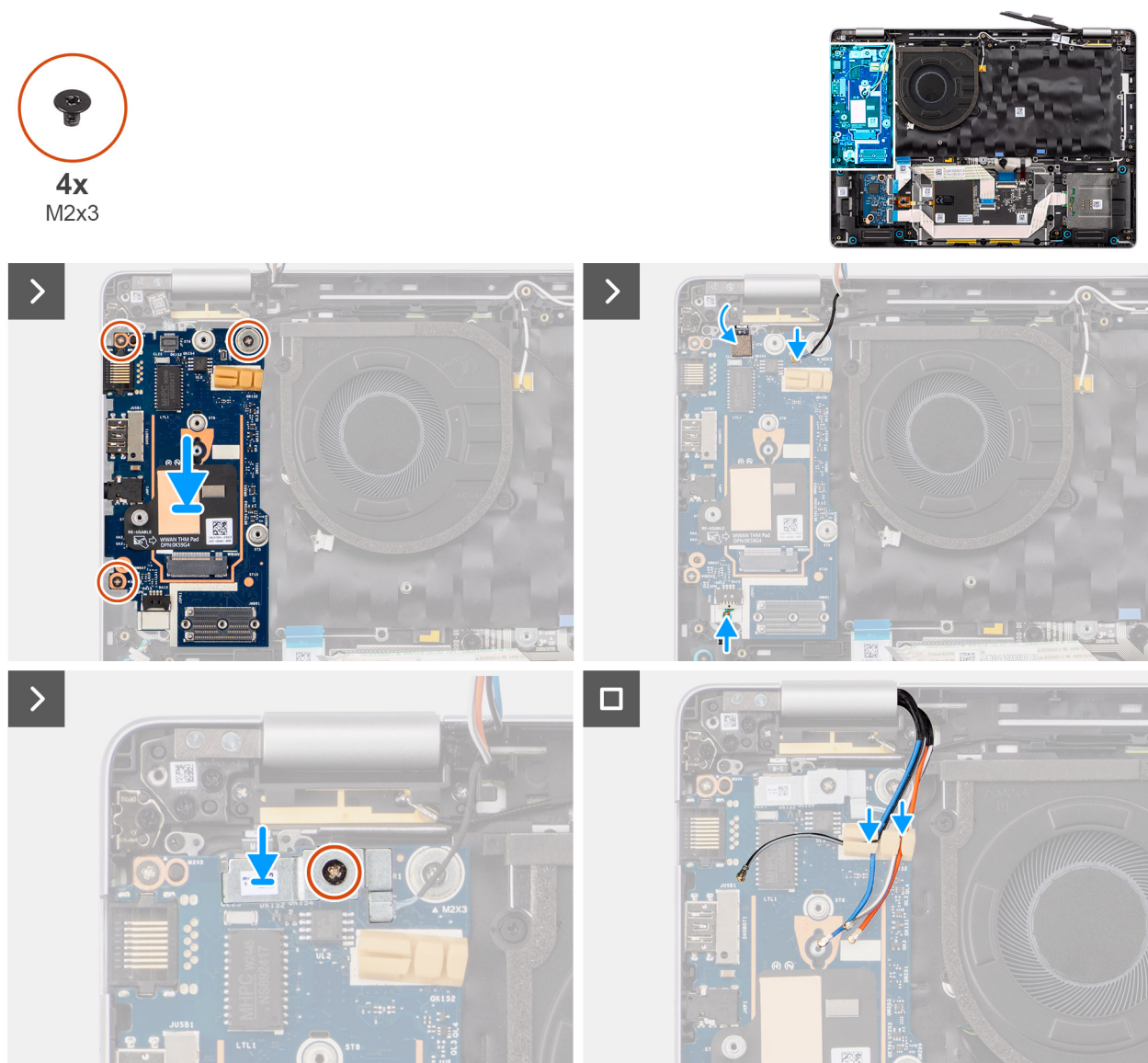

Figure 58. Installing the I/O board

Steps

1. Align and place the I/O board on to its slot on the palm-rest assembly.

2. Replace the three screws (M2x3) that secure the I/O board to the palm-rest assembly.
3. Connect the fingerprint-reader cable to the connector on the I/O board.
4. Connect the Darwin cable to the connector on the I/O board.
5. Connect the speaker cable to the connector on the I/O board.
6. Align and place the fingerprint-reader bracket over the fingerprint-reader cable and replace the screw (M2x3) that secures the fingerprint-reader bracket to the I/O board.

NOTE: The fingerprint-reader bracket covers both the fingerprint-reader connector and the Darwin-cable connector. Models that are shipped without fingerprint reader will still have a fingerprint-reader bracket that covers the Darwin-cable connector.

7. Route the WWAN-antenna cables through the routing guides on the I/O board.

Next steps

1. Install the [system board](#).

NOTE: The system board can be removed and installed with the heat sink attached in order to simplify the procedure and preserve the thermal bond between the system board and heat sink.

2. Install the [M.2 2230 solid state drive](#) or [M.2 2280 solid state drive](#), as applicable.
3. Install the [5G WWAN card](#) or [4G WWAN card](#), as applicable.
4. Install the [battery](#).
5. Install the [base cover](#).
6. Install the [SIM-card tray](#), if applicable.
7. Follow the procedure in [After working inside your computer](#).

Power-button with optional fingerprint reader

Removing the power button with optional fingerprint reader

CAUTION: The information in this removal section is intended for authorized service technicians only.

Prerequisites

1. Follow the procedure in [Before working inside your computer](#).
2. Remove the [SIM-card tray](#), if applicable.
3. Remove the [base cover](#).
4. Remove the [battery](#).
5. Remove the [5G WWAN card](#) or [4G WWAN card](#), as applicable.
6. Remove the [M.2 2230 solid state drive](#) or [M.2 2280 solid state drive](#), as applicable.
7. Remove the [system board](#).

NOTE: The system board can be removed and installed with the heat sink attached in order to simplify the procedure and preserve the thermal bond between the system board and heat sink.

8. Remove the [I/O board](#).

About this task

The following image indicates the location of the power button with optional fingerprint reader and provides a visual representation of the removal procedure.



2x
M1.6x1.7

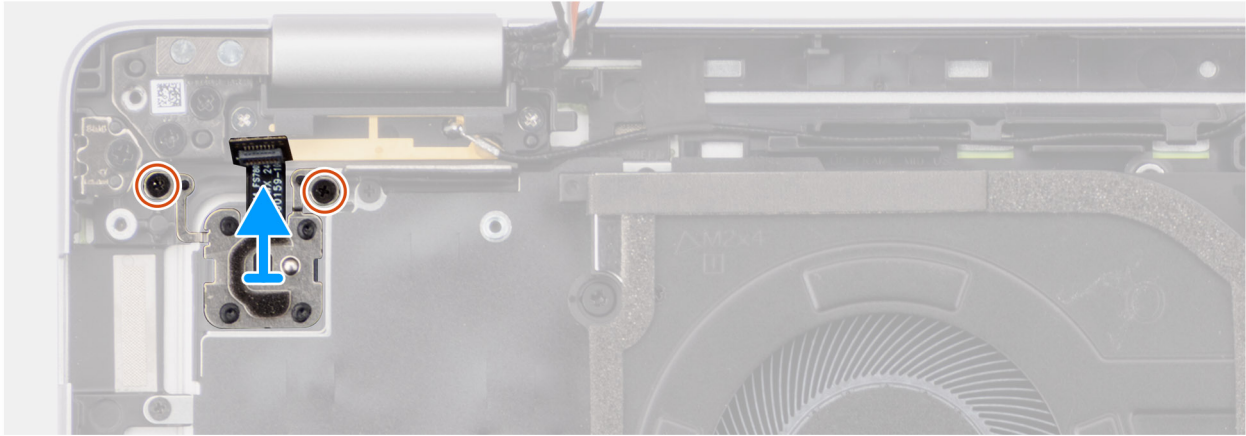
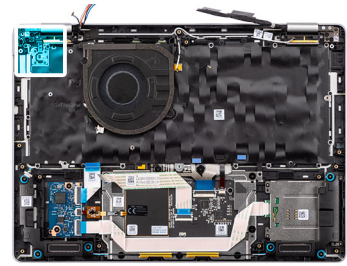

Figure 59. Remove the power button with optional fingerprint reader

Steps

1. Remove the two screws (M1.6x1.7) that secure the power button to the palm-rest assembly.
2. Lift the power button off the palm-rest assembly.

Installing the power button with optional fingerprint reader

CAUTION: The information in this installation section is intended for authorized service technicians only.

About this task

The following image indicates the location of the power button with optional fingerprint reader and provides a visual representation of the installation procedure.



2x
M1.6x1.7

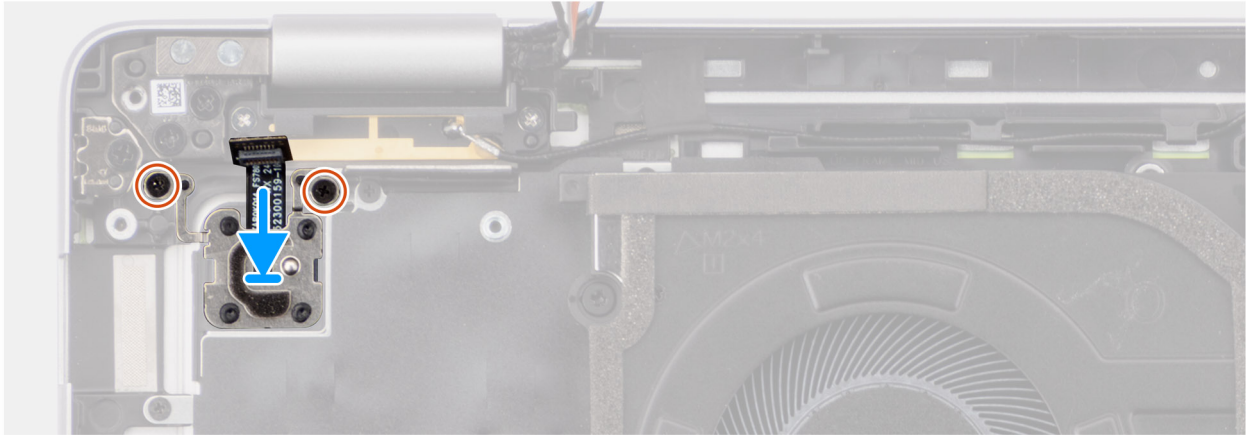
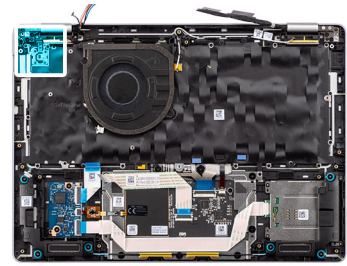

Figure 60. Installing the power button with optional fingerprint reader

Steps

1. Align and place the power button on to its slot on the palm-rest assembly.
2. Replace the two screws (M1.6x1.7) that secure the power button to the palm-rest assembly.

Next steps

1. Install the [I/O board](#).
2. Install the [system board](#).

NOTE: The system board can be removed and installed with the heat sink attached in order to simplify the procedure and preserve the thermal bond between the system board and heat sink.

3. Install the [M.2 2230 solid state drive](#) or [M.2 2280 solid state drive](#), as applicable.
4. Install the [5G WWAN card](#) or [4G WWAN card](#), as applicable.
5. Install the [battery](#).
6. Install the [base cover](#).
7. Install the [SIM-card tray](#), if applicable.
8. Follow the procedure in [After working inside your computer](#).

Display assembly

Removing the display assembly

CAUTION: The information in this removal section is intended for authorized service technicians only.

Prerequisites

1. Follow the procedure in [Before working inside your computer](#).
2. Remove the [SIM-card tray](#), if applicable.
3. Remove the [base cover](#).
4. Remove the [5G WWAN card](#) or [4G WWAN card](#), as applicable.

About this task

The following images indicate the location of the display assembly and provide a visual representation of the removal procedure.

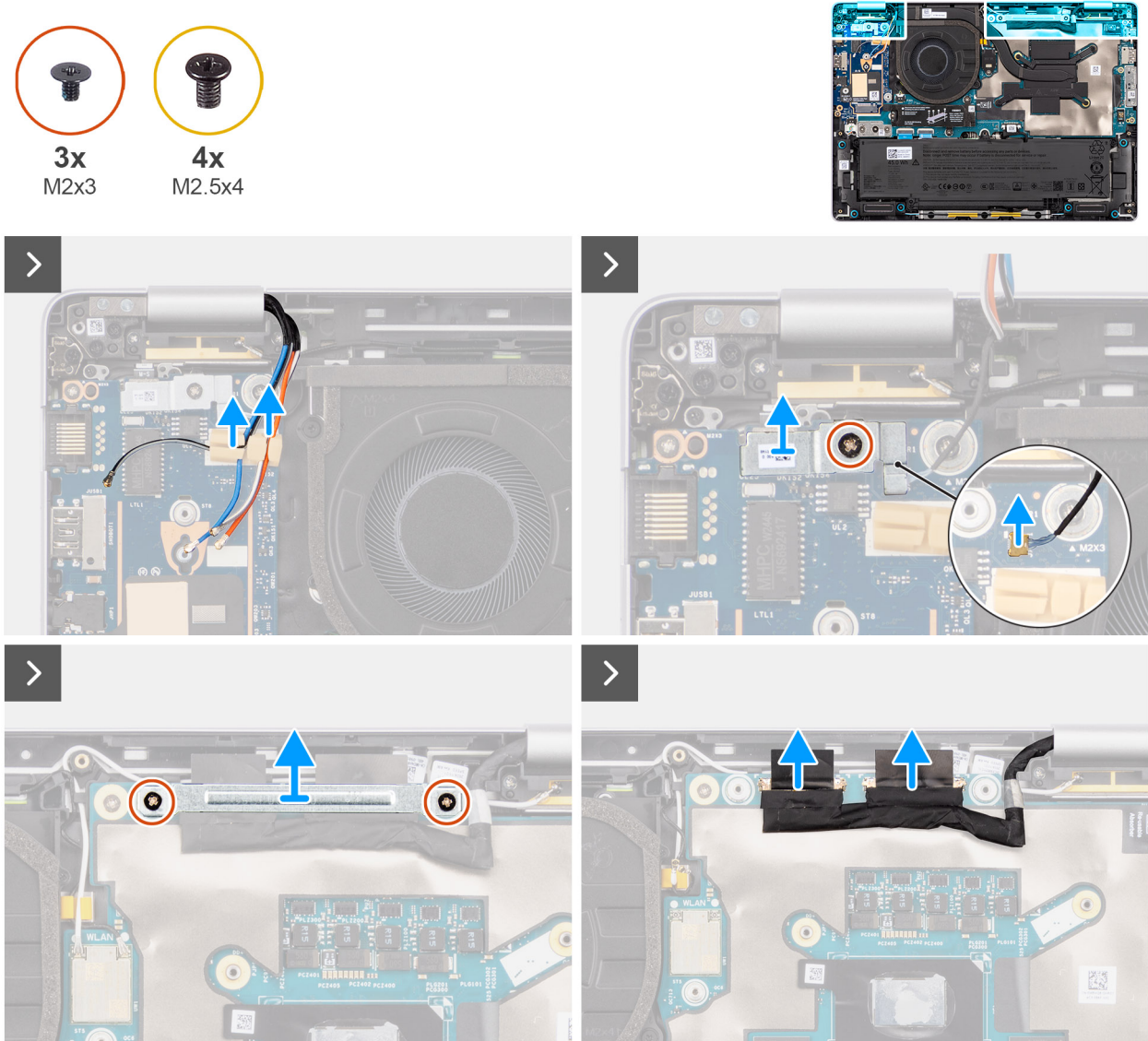

Figure 61. Removing the display assembly

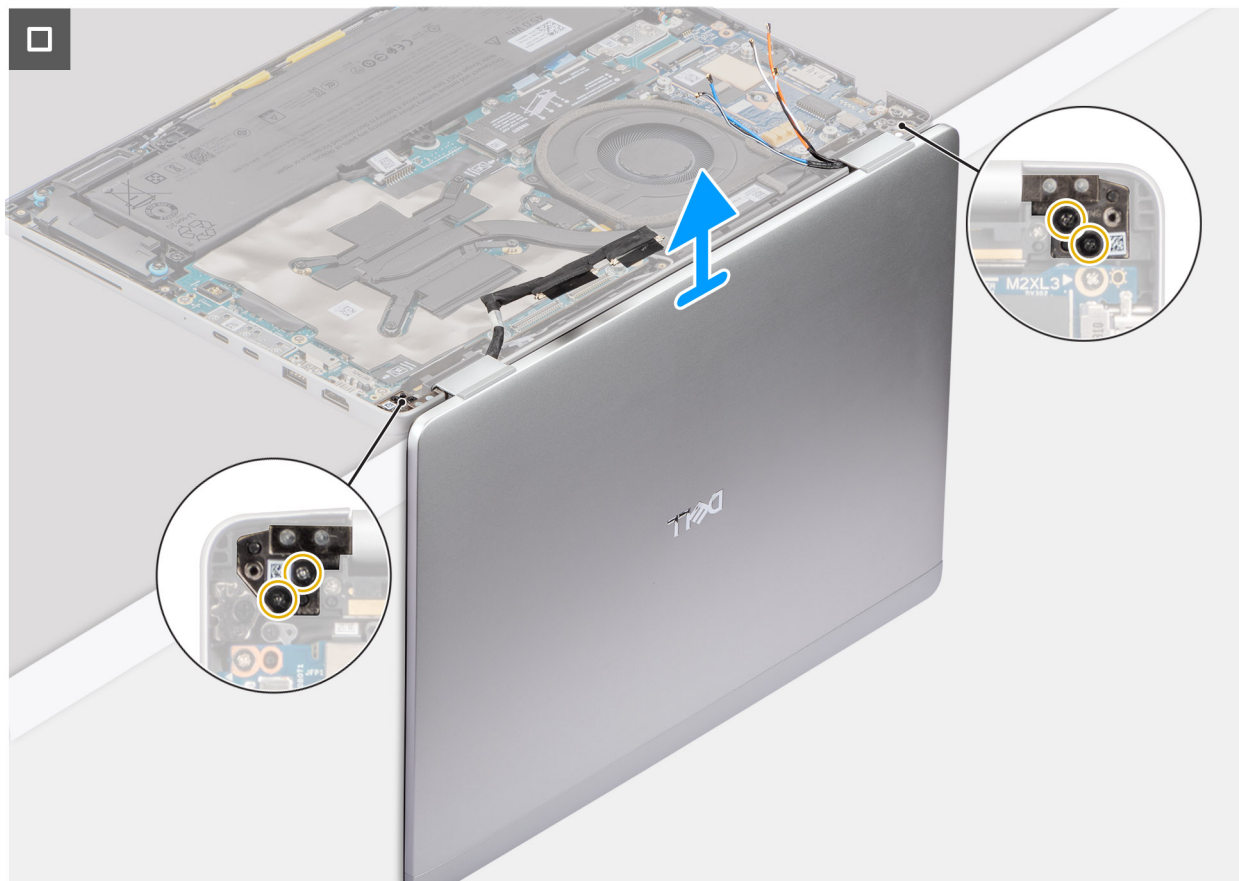

Figure 62. Removing the display assembly

Steps

1. Remove the WWAN antenna cables from the routing guides on the I/O board.
2. Remove the screw (M2x3) that secures the fingerprint-reader bracket to the I/O board.
 - i** **NOTE:** The fingerprint-reader bracket covers both the fingerprint-reader connector and the Darwin-cable connector. Models that are shipped without fingerprint reader will still have a fingerprint-reader bracket that covers the Darwin-cable connector.
3. Lift the fingerprint-reader bracket off the palm-rest assembly.
4. Disconnect the Darwin cable from the connector on the I/O board.
5. Remove the two screws (M2x3) that secure the display-cable bracket to the palm-rest assembly.
6. Disconnect the camera cable, if available, and display cable from the connector on the system board.
7. Open the display assembly at an angle of 90 degrees. Place the computer on the edge of a clean and flat surface so the display assembly extends below the edge of the surface.
8. Remove the four screws (M2.5x4) that secure the left and right display hinges to the palm-rest assembly.
9. Carefully remove the display assembly from the palm-rest assembly.
 - i** **NOTE:** For Dell Pro 14 Plus 2-in-1, the display assembly is a Hinge-Up Design (HUD) and cannot be further disassembled once it has been removed from the computer. If any component within the display assembly is faulty, replace the entire display assembly.

Installing the display assembly

⚠ CAUTION: The information in this installation section is intended for authorized service technicians only.

Prerequisites

If you are replacing a component, remove the existing component before performing the installation procedure.

About this task

The following images indicate the location of the display assembly and provide a visual representation of the installation procedure.



Figure 63. Aligning the display assembly with the palm-rest assembly

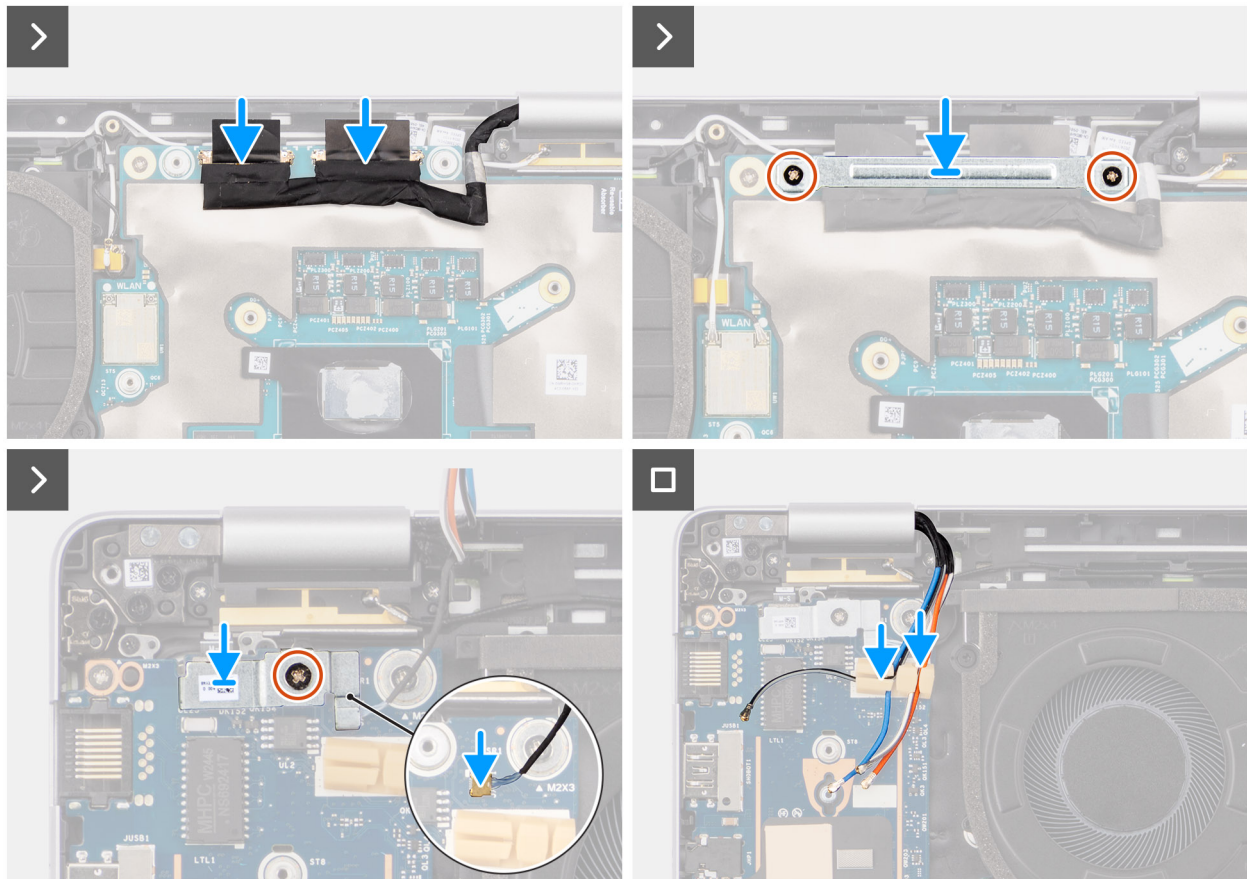

Figure 64. Installing the display assembly

Steps

1. Place the palm-rest assembly on the edge of a clean, flat surface.
2. At an angle of 90 degrees, align and place the display assembly over the palm-rest assembly.
3. Replace the four screws (M2.5x4) that secure the left and right display hinges to the palm-rest assembly.
4. Connect the camera cable, if available, and the display cable to the connectors on the system board.
5. Align and place the display-cable bracket over the cables on the system board.
6. Replace the two screws (M2x3) that secure the display-cable bracket to the system board.
7. Connect the Darwin cable to the connector on the I/O board.
8. Align and place the fingerprint-reader bracket on the I/O board.
9. Replace the screw (M2x3) that secures the fingerprint-reader bracket to the I/O board.
10. Route the WWAN-antenna cables through the routing guides on the I/O board.

Next steps

1. Install the [5G WWAN card](#) or [4G WWAN card](#), as applicable.
2. Install the [base cover](#).
3. Install the [SIM-card tray](#), if applicable.
4. Follow the procedure in [After working inside your computer](#).

Display bezel

Removing the display bezel

⚠ CAUTION: The information in this removal section is intended for authorized service technicians only.

NOTE: This procedure applies only to Dell Pro 14 Plus laptops.

Prerequisites

1. Follow the procedure in [Before working inside your computer](#).
2. Remove the [SIM-card tray](#), if applicable.
3. Remove the [base cover](#).
4. Remove the [5G WWAN card](#) or [4G WWAN card](#), as applicable.
5. Remove the [display assembly](#).

About this task

The following images indicate the location of the display bezel and provide a visual representation of the removal procedure.



Figure 65. Prying the plastic bezel

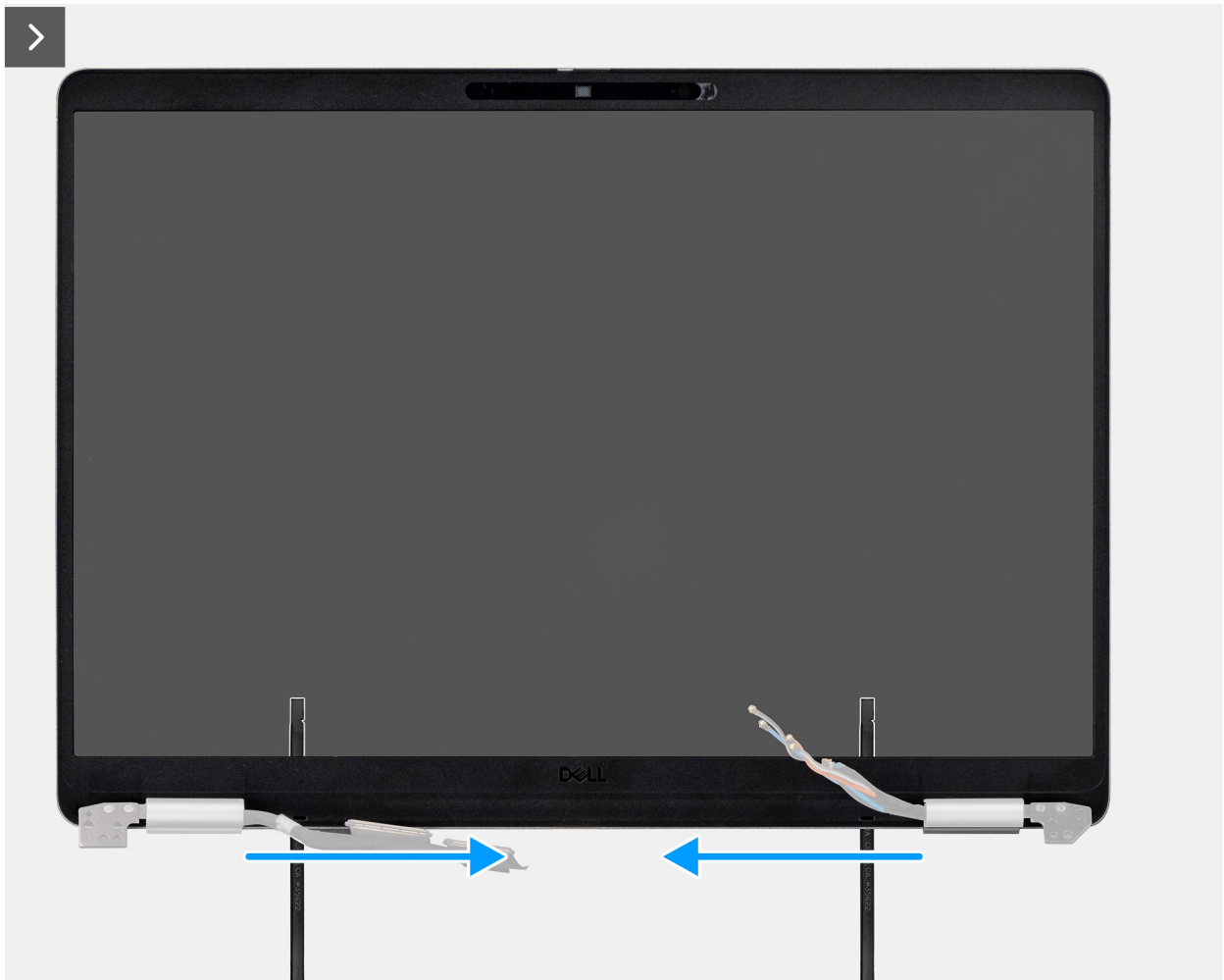

Figure 66. Prying the bezel along the hinges

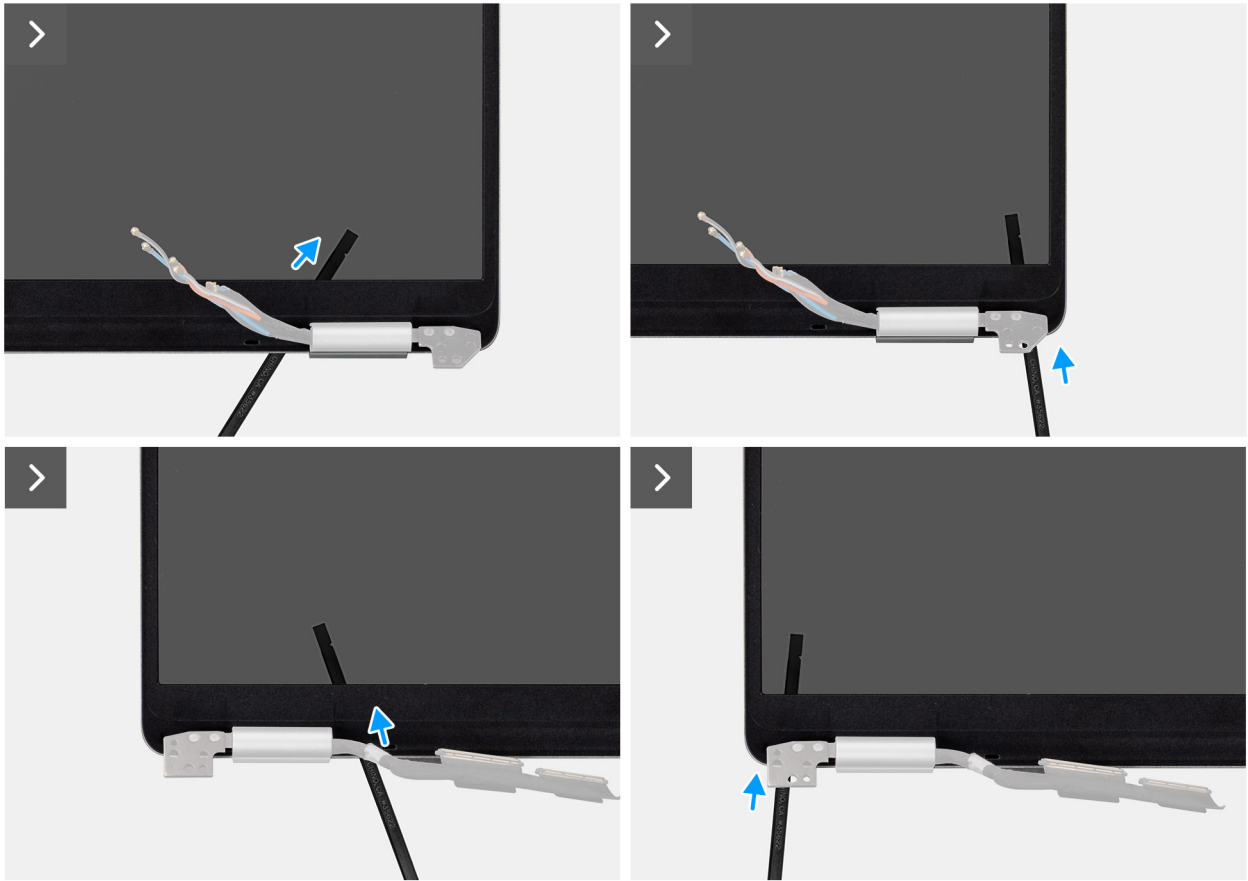

Figure 67. Prying the bezel along the hinges

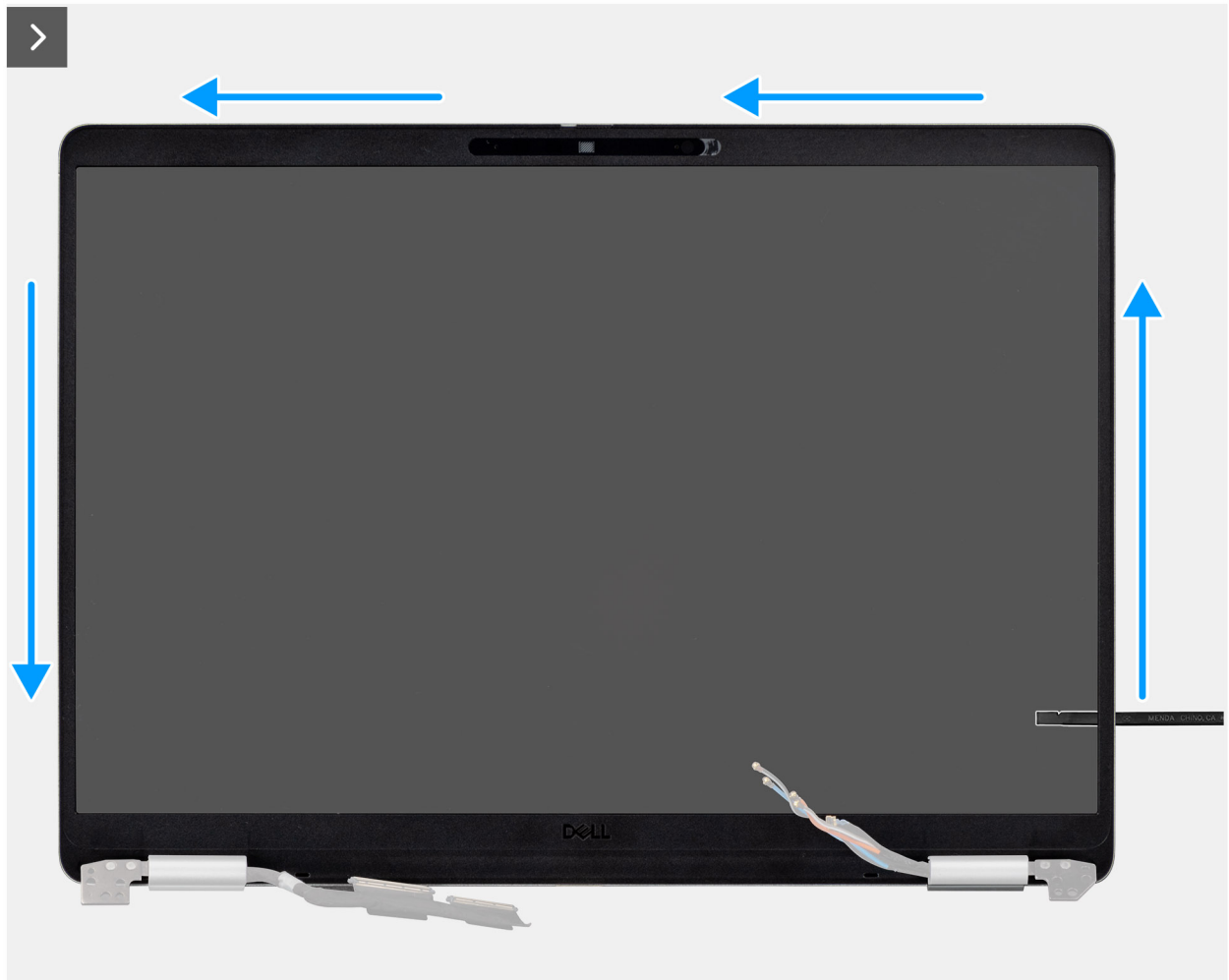

Figure 68. Prying the bezel along the sides

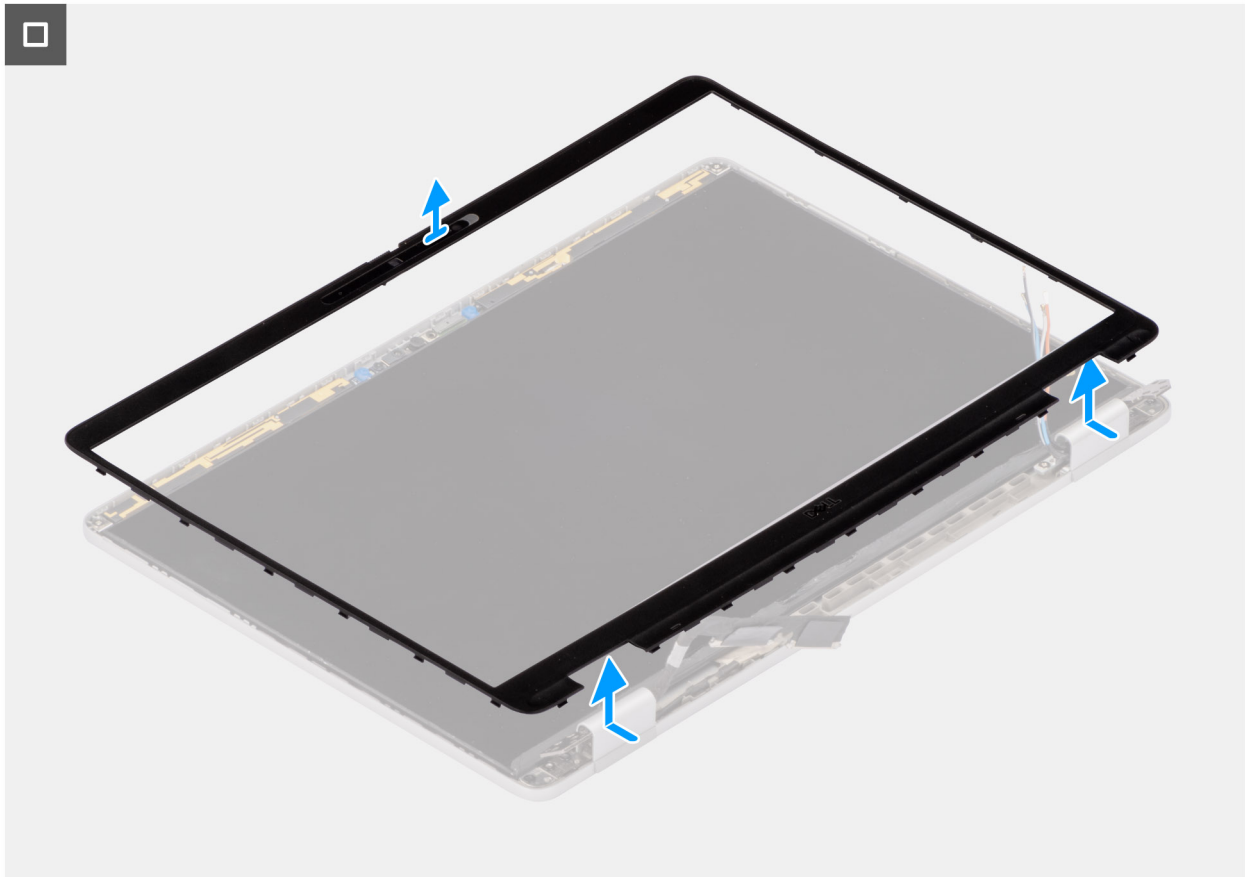

Figure 69. Removing the display bezel

Steps

1. Insert a flat-head slotted screwdriver (maximum width: 4 mm) into the slots on the display bezel near the hinges, and gently apply pressure to release the bezel at both ends, creating a gap.
2. Insert the flat end of the scribe into the gap created under the display bezel.
CAUTION: When inserting the scribe into the bezel, keep it parallel to the display. Pressing it downward can damage the display. Do not use the flat head (slotted) screwdriver to release up the rest of the bezel. Switch to the plastic scribe to continue prying along the bezel.
3. Keeping the scribe parallel to the display, carefully slide it along the bottom edge of the bezel to release the latches on the lower side.
4. Insert the scribe diagonally into the hinge section to carefully release the portion of the bezel above the hinge.
CAUTION: Do not lift the scribe vertically as it damages the screen. Slide the scribe horizontally to disengage the adhesive and release the bezel upwards.
5. Insert the scribe into the corner of the display bezel near the hinge. Keeping the scribe parallel to the display, carefully slide the scribe along the edges from one corner to the other (right to left or left to right).
6. Lift the display bezel from the display assembly.

Installing the display bezel

CAUTION: The information in this installation section is intended for authorized service technicians only.

Prerequisites

If you are replacing a component, remove the existing component before performing the installation procedure.

About this task

The following images indicate the location of the display bezel and provide a visual representation of the installation procedure.

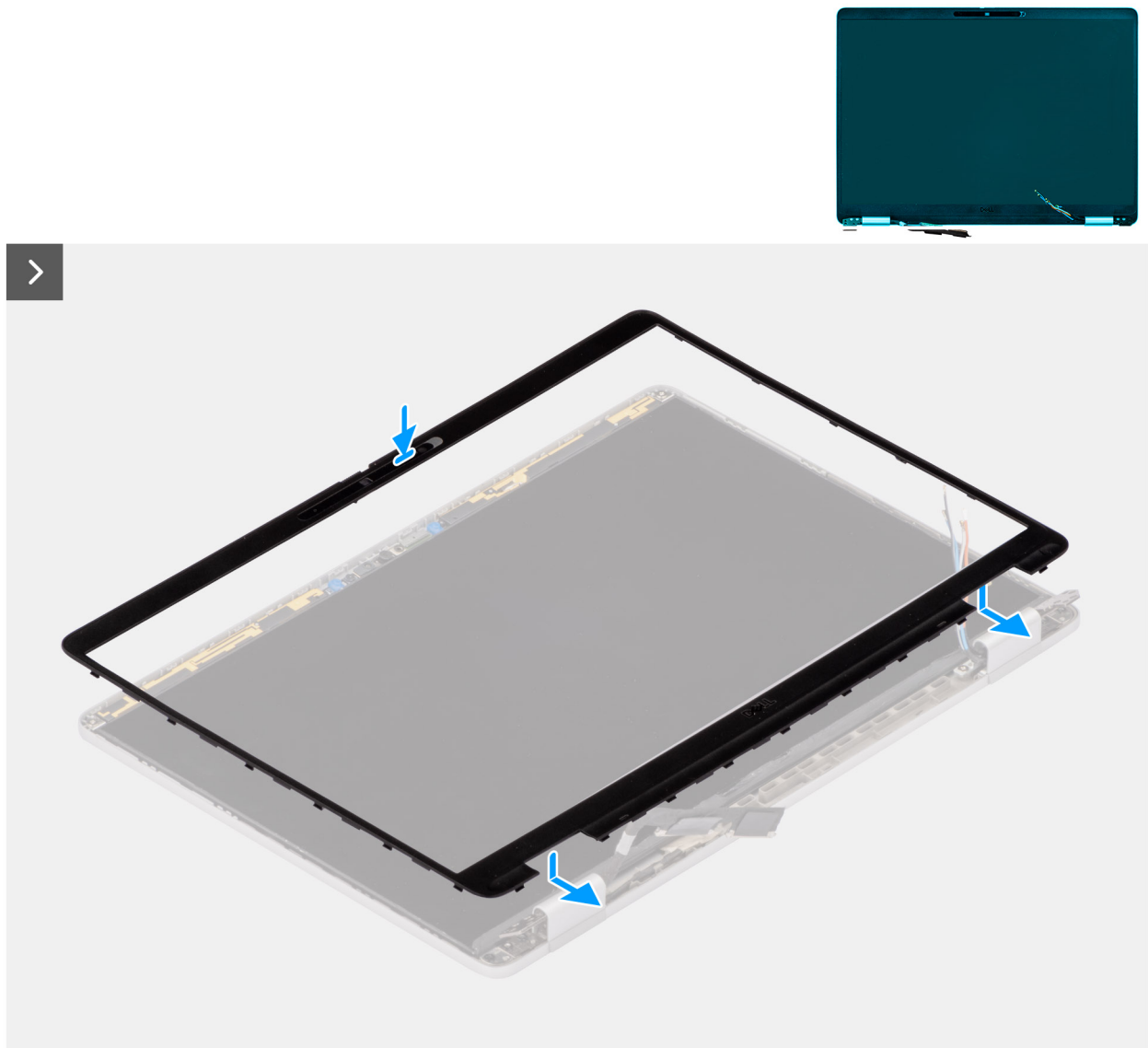

Figure 70. Installing the display bezel



Figure 71. Installing the display bezel

Steps

1. Place the display assembly on a clean and flat surface.
2. Align and place the display bezel on the display assembly.
3. Starting from the bottom corner, press the display bezel and work around the entire bezel until it snaps onto the display assembly.

Next steps

1. Install the [display assembly](#).
2. Install the [5G WWAN card](#) or [4G WWAN card](#), as applicable.
3. Install the [base cover](#).
4. Install the [SIM-card tray](#), if applicable.
5. Follow the procedure in [After working inside your computer](#).

Display panel

Removing the display panel

CAUTION: The information in this removal section is intended for authorized service technicians only.

NOTE: This procedure applies only to Dell Pro 14 Plus laptops.

Prerequisites

1. Follow the procedure in [Before working inside your computer](#).
2. Remove the [SIM-card tray](#), if applicable.
3. Remove the [base cover](#).
4. Remove the [5G WWAN card](#) or [4G WWAN card](#), as applicable.
5. Remove the [display assembly](#).
6. Remove the [display bezel](#).

About this task

The following images indicate the location of the display panel and provide a visual representation of the removal procedure.

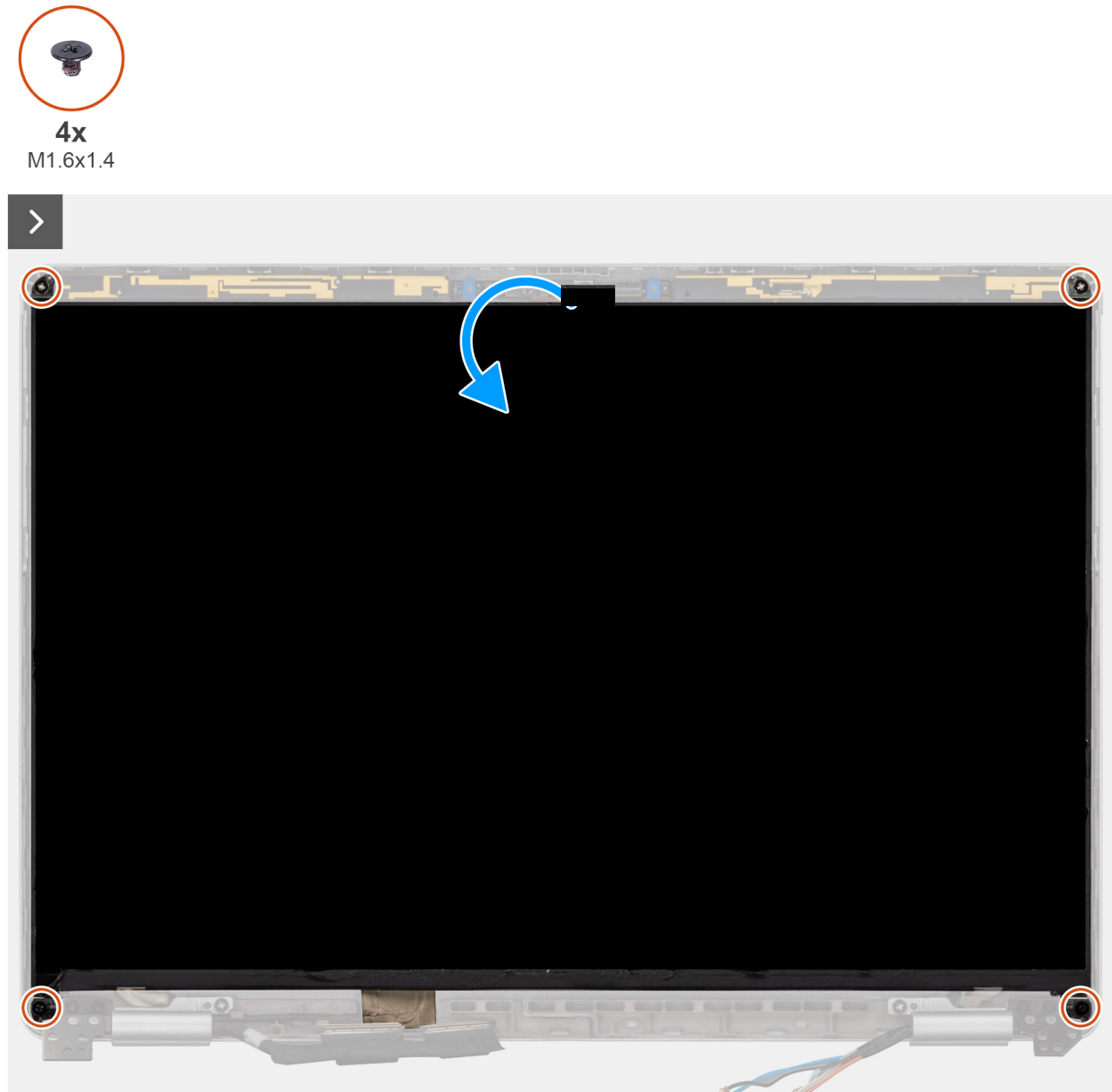

Figure 72. Removing the display panel



Figure 73. Removing the display panel

Steps

1. Remove the four screws (M1.6x1.4) that secure the display panel and bracket assembly to the display back cover.
2. Gently flip the display panel and peel the tape securing the display cable to the back of the display panel.
3. Open the latch and disconnect the display cable from the connector on the display panel.
4. Lift the display panel off the display back cover.

CAUTION: The display panel is assembled with the display-panel brackets as a single service part. Do not pull the two pieces of elastic tape and separate the brackets from the panel.



Figure 74. Display panel with brackets

Installing the display panel

CAUTION: The information in this installation section is intended for authorized service technicians only.

About this task

The following images indicate the location of the display panel and display cable and provide a visual representation of the installation procedure.



Figure 75. Installing the display panel



4x
M1.6x1.4

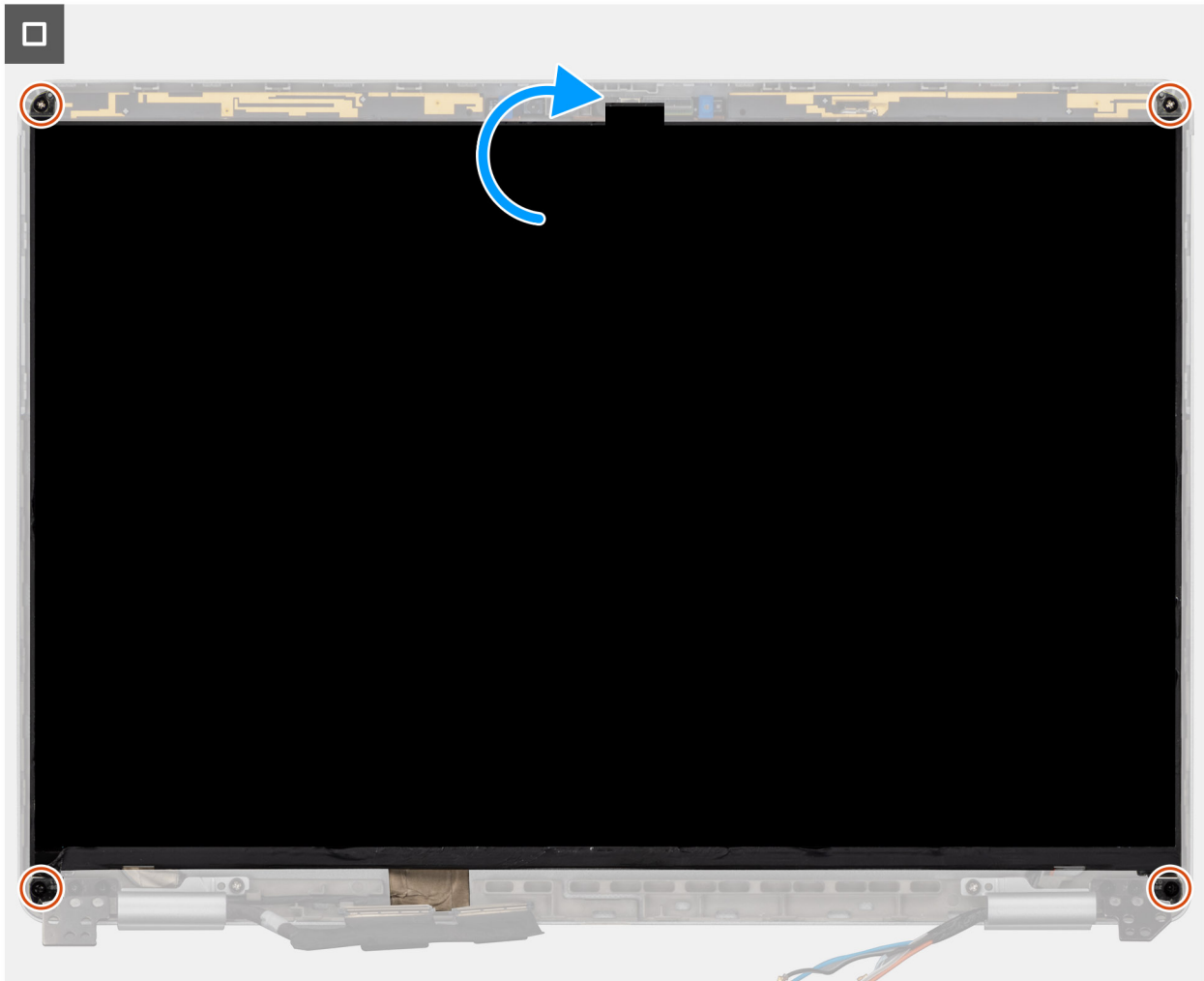

Figure 76. Installing the display panel

Steps

1. Align and place the display panel and display assembly on a clean and flat surface.
2. Connect the display cable to the connector on the back of the display panel.
3. Adhere the tape to secure the display cable to the connector on the display panel.
4. Gently turn the display panel over and place the display panel in the slot on the display back cover.
5. Replace the four screws (M1.6x1.4) that secure the display panel and bracket assembly to the display back-cover.

Next steps

1. Install the [display bezel](#).
2. Install the [display assembly](#).
3. Install the [5G WWAN card](#) or [4G WWAN card](#), as applicable.
4. Install the [base cover](#).
5. Install the [SIM-card tray](#), if applicable.
6. Follow the procedure in [After working inside your computer](#).

Display hinge caps

Removing the display hinge caps

 **CAUTION:** The information in this removal section is intended for authorized service technicians only.

 **NOTE:** This procedure applies only to Dell Pro 14 Plus laptops.

Prerequisites

1. Follow the procedure in [Before working inside your computer](#).
2. Remove the [SIM-card tray](#), if applicable.
3. Remove the [base cover](#).
4. Remove the [5G WWAN card](#) or [4G WWAN card](#), as applicable.
5. Remove the [display assembly](#).
6. Remove the [display bezel](#).
7. Remove the [display panel](#).

About this task

The following images indicate the location of the display hinge caps and provide a visual representation of the removal procedure.

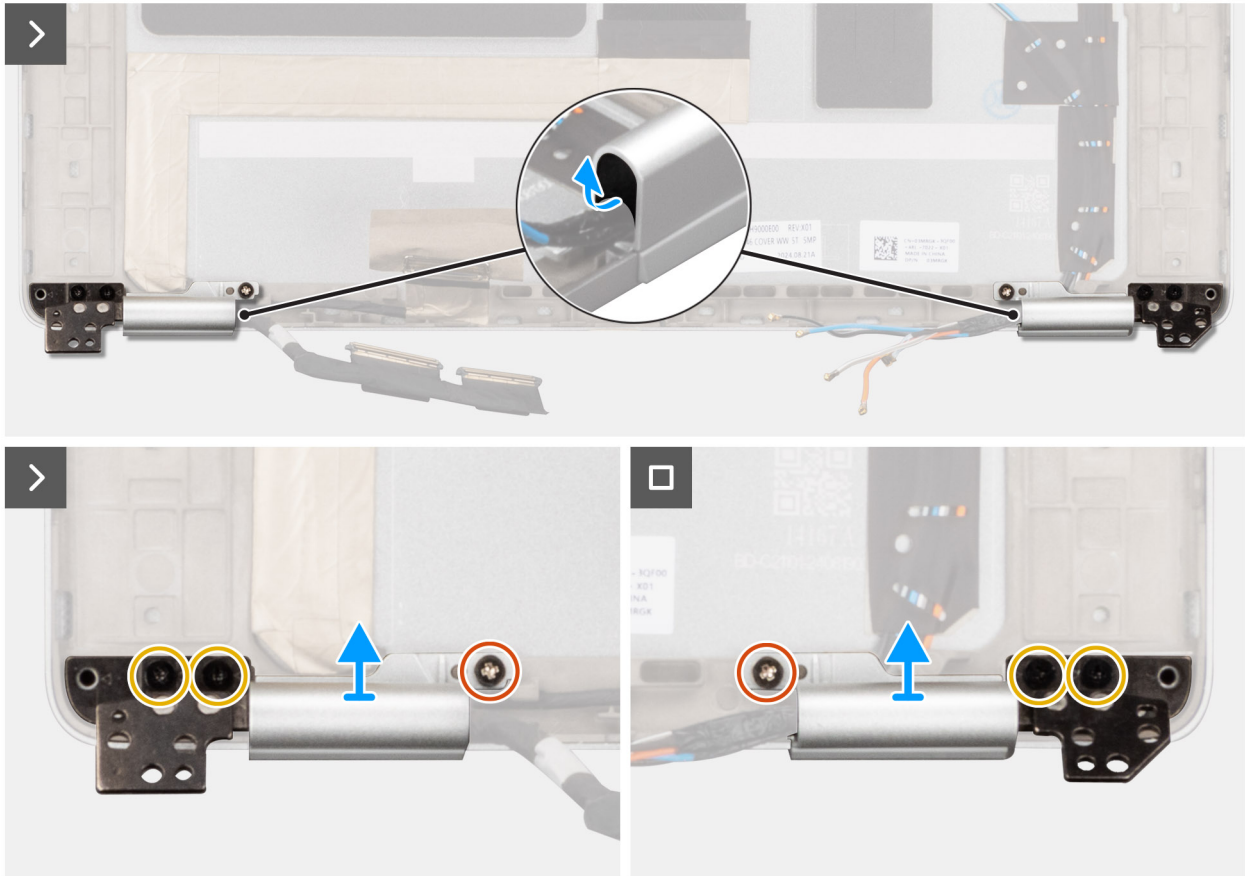
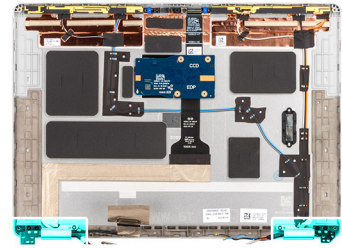

Figure 77. Removing the display hinges

Steps

1. Using a plastic scribe, pry the hinge rubber out of the left and right hinge caps.
 ⚠ **CAUTION: Do not pull the display cable, Darwin cable, or the WWAN-antenna cables out of the hinge caps directly.**
2. Remove the two screws (M2x3) and four screws (M2.5x3.5) that secure the left and right display hinge caps to the display back cover.
3. Pinch and lift the left and right display hinge cap off the display back cover.

Installing the display hinge caps

⚠ **CAUTION: The information in this installation section is intended for authorized service technicians only.**

Prerequisites

If you are replacing a component, remove the existing component before performing the installation procedure.

About this task

The following images indicate the location of the display hinge caps and provide a visual representation of the installation procedure.

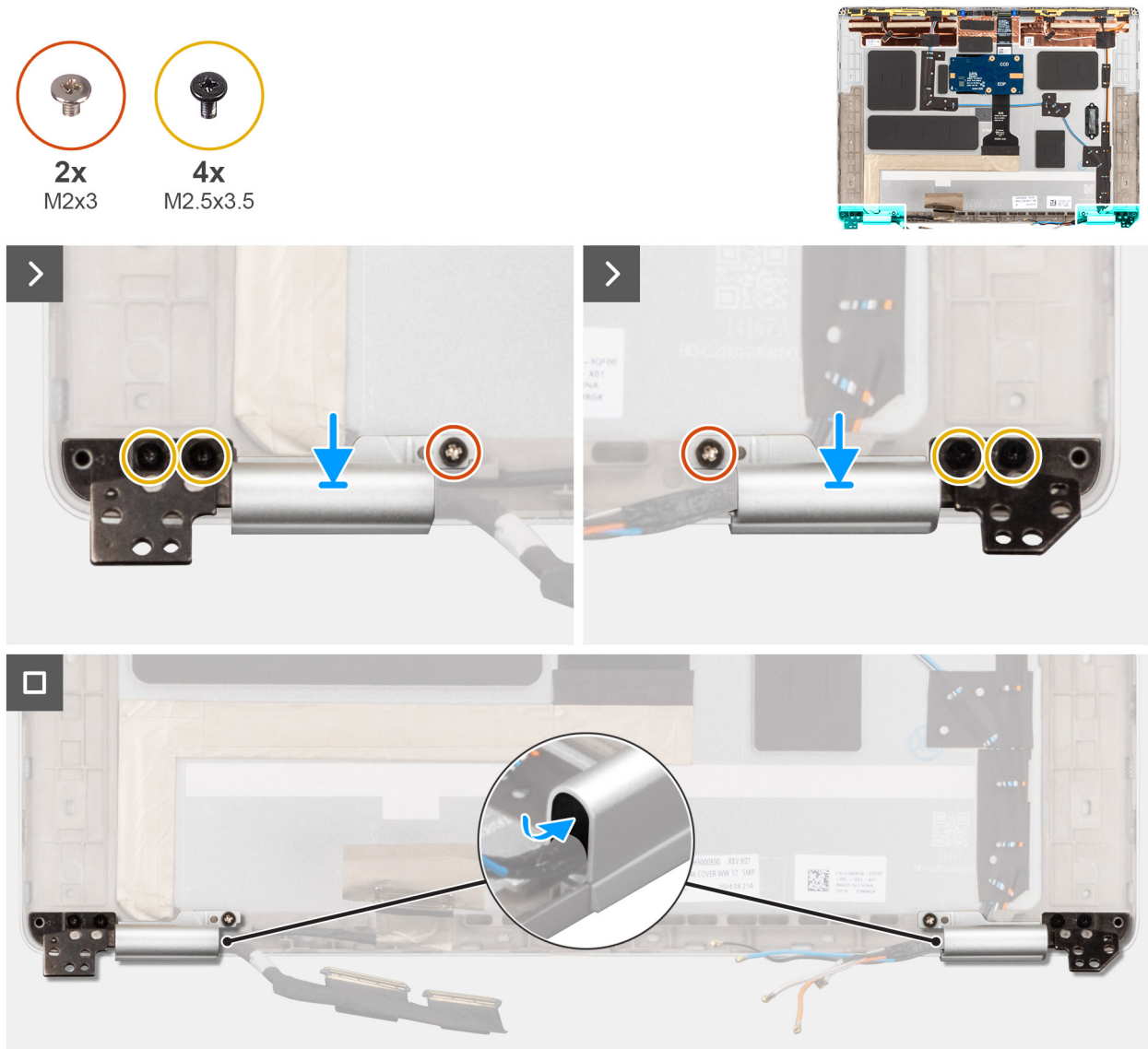

Figure 78. Installing the hinge caps

Steps

1. Align and place the display hinge caps on the display back cover.
2. Replace the two screws (M2x3) and four screws (M2.5x3.5) that secure the left and right display hinge caps to the display back cover.
3. Align and place the hinge rubber into the left and right hinge caps.

Next steps

1. Install the [display panel](#).
2. Install the [display bezel](#).
3. Install the [display assembly](#).
4. Install the [5G WWAN card](#) or [4G WWAN card](#), as applicable.
5. Install the [base cover](#).
6. Install the [SIM-card tray](#), if applicable.
7. Follow the procedure in [After working inside your computer](#).

RGB/IR camera

Removing the RGB/IR camera

CAUTION: The information in this removal section is intended for authorized service technicians only.

NOTE: This procedure applies only to Dell Pro 14 Plus laptops.

Prerequisites

1. Follow the procedure in [Before working inside your computer](#).
2. Remove the [SIM-card tray](#), if applicable.
3. Remove the [base cover](#).
4. Remove the [5G WWAN card](#) or [4G WWAN card](#), as applicable.
5. Remove the [display assembly](#).
6. Remove the [display bezel](#).
7. Remove the [display panel](#).

About this task

NOTE: This procedure applies only to models that are shipped with RGB or IR camera.

The following images indicate the location of the RGB/IR camera and provide a visual representation of the removal procedure.

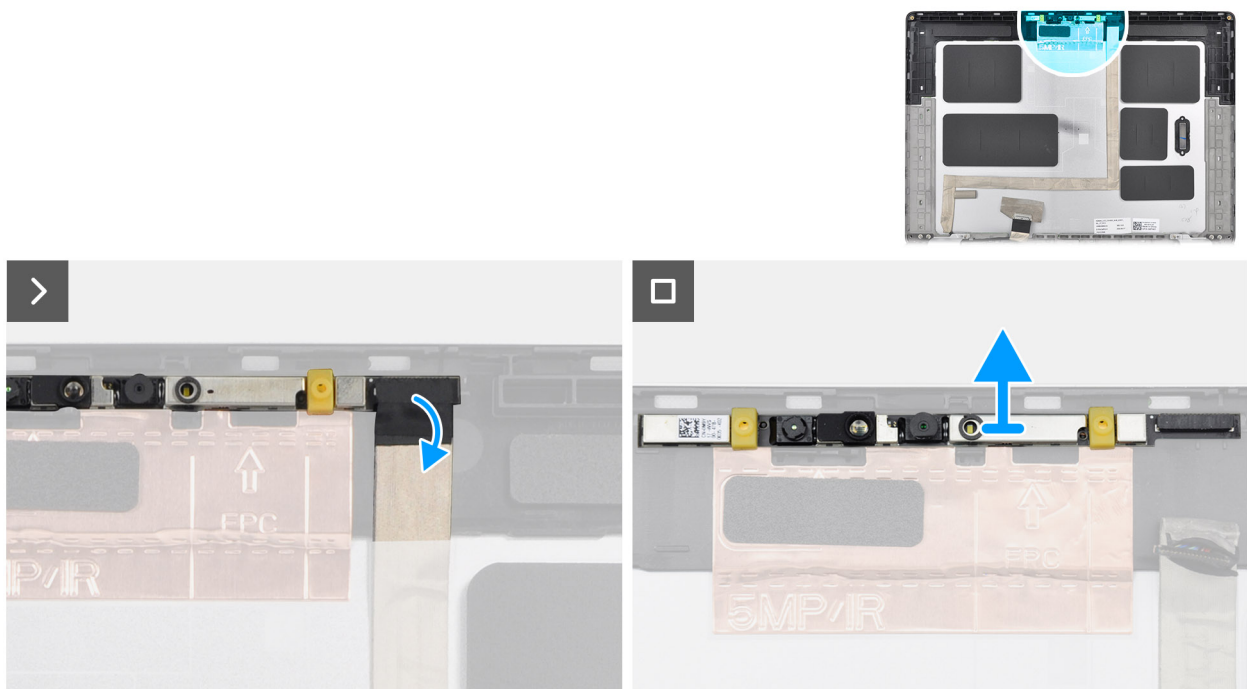

Figure 79. Removing the IR camera

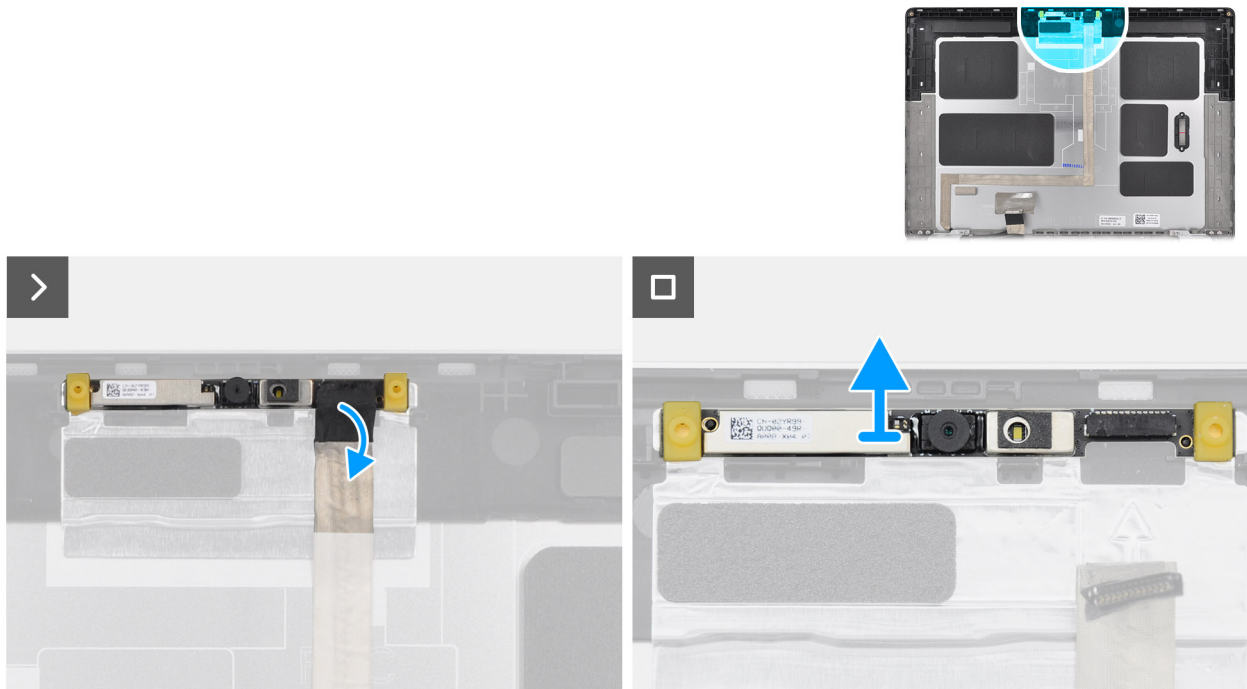

Figure 80. Removing the RGB camera

Steps

1. Disconnect the display and camera cable from the connector on the camera.
2. Pry up the module from the recess at its bottom side indicated by an arrow and then slide along the bottom side to detach it from the display back cover.
3. Lift the RGB/IR camera off the display back cover.

Installing the RGB/IR camera

CAUTION: The information in this installation section is intended for authorized service technicians only.

About this task

The following images indicate the location of the RGB/IR camera and provide a visual representation of the installation procedure.

NOTE: This procedure applies for only models that are shipped with an RGB or IR camera.

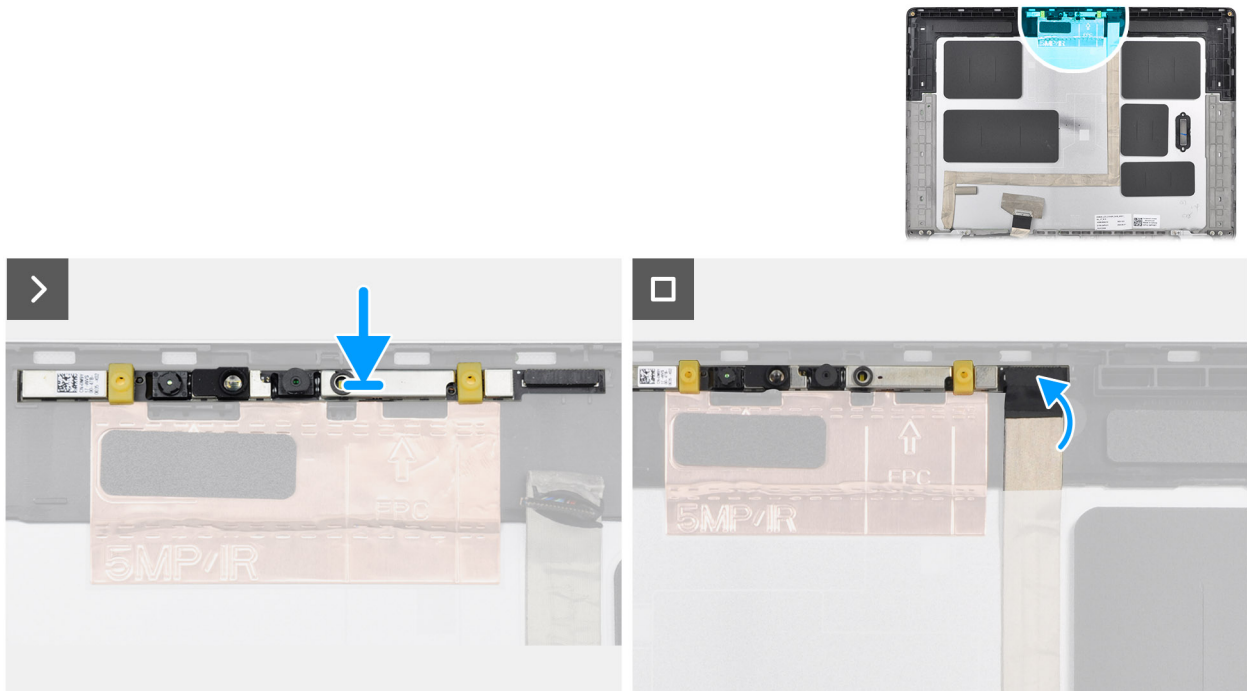

Figure 81. Installing the IR camera

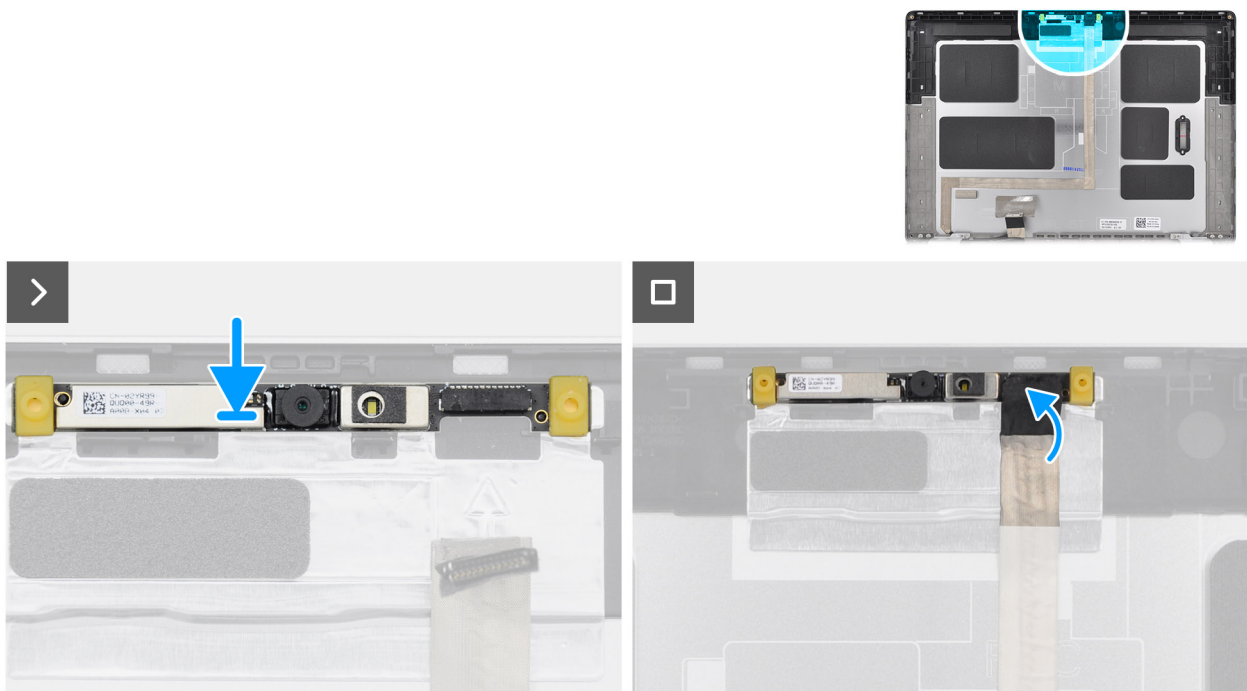

Figure 82. Installing the RGB camera

Steps

1. Align and place the RGB/IR camera on the display back cover.
2. Connect the display and camera cable to the connector on the camera.

Next steps

1. Install the [display panel](#).
2. Install the [display bezel](#).

3. Install the [display assembly](#).
4. Install the [5G WWAN card](#) or [4G WWAN card](#), as applicable.
5. Install the [base cover](#).
6. Install the [SIM-card tray](#), if applicable.
7. Follow the procedure in [After working inside your computer](#).

MIPI camera

Removing the MIPI camera

CAUTION: The information in this removal section is intended for authorized service technicians only.

NOTE: This procedure applies only to Dell Pro 14 Plus laptops.

Prerequisites

1. Follow the procedure in [Before working inside your computer](#).
2. Remove the [SIM-card tray](#), if applicable.
3. Remove the [base cover](#).
4. Remove the [5G WWAN card](#) or [4G WWAN card](#), as applicable.
5. Remove the [display assembly](#).
6. Remove the [display bezel](#).
7. Remove the [display panel](#).
8. Remove the [display hinge caps](#).

About this task

NOTE: This procedure applies for only models that are shipped with MIPI camera.

The following image indicates the location of the MIPI camera and provides a visual representation of the removal procedure.



Figure 83. Removing the MIPI camera

Steps

1. Remove the clip that secures the MIPI camera and the camera cable to the connector on the display back cover.
2. Using a plastic scribe, pry the camera module off the display back cover.
3. Carefully lift the MIPI camera module off the display back cover.

Installing the MIPI camera

CAUTION: The information in this installation section is intended for authorized service technicians only.

About this task

The following image indicates the location of the MIPI camera and provides a visual representation of the installation procedure.

NOTE: This procedure applies for only models that are shipped with MIPI camera.



Figure 84. Installing the MIPI camera

Steps

1. Align and place the MIPI camera module on the display back cover.
2. Replace the clip to secure the MIPI camera and the camera cable to the display back cover.

NOTE: When installing the clip to secure the MIPI camera connection to the middle-board cable, ensure that the top side (with "TOP" etched on it) is facing up.

Next steps

1. Install the [display hinge caps](#).
2. Install the [display panel](#).
3. Install the [display bezel](#).
4. Install the [display assembly](#).
5. Install the [5G WWAN card](#) or [4G WWAN card](#), as applicable.
6. Install the [base cover](#).
7. Install the [SIM-card tray](#), if applicable.
8. Follow the procedure in [After working inside your computer](#).

Display cable for RGB/IR camera

Removing the display cable for RGB/IR camera

CAUTION: The information in this removal section is intended for authorized service technicians only.

NOTE: This procedure applies only to Dell Pro 14 Plus laptops.

Prerequisites

1. Follow the procedure in [Before working inside your computer](#).
2. Remove the [SIM-card tray](#), if applicable.
3. Remove the [base cover](#).
4. Remove the [5G WWAN card](#) or [4G WWAN card](#), as applicable.
5. Remove the [display assembly](#).
6. Remove the [display bezel](#).
7. Remove the [display panel](#).

About this task

NOTE: This procedure applies for only models that are shipped with a RGB/IR camera.

The following images indicate the location of the display cable for RGB/IR camera and provide a visual representation of the removal procedure.

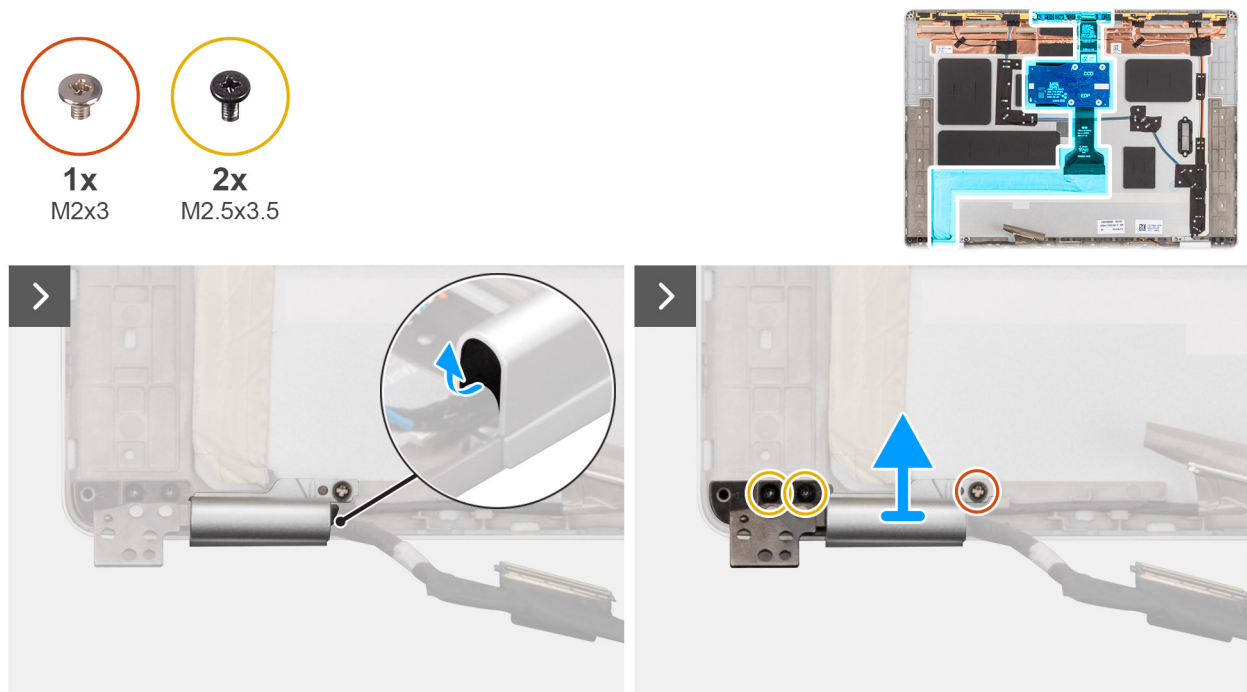

Figure 85. Removing the display cable for RGB/IR camera

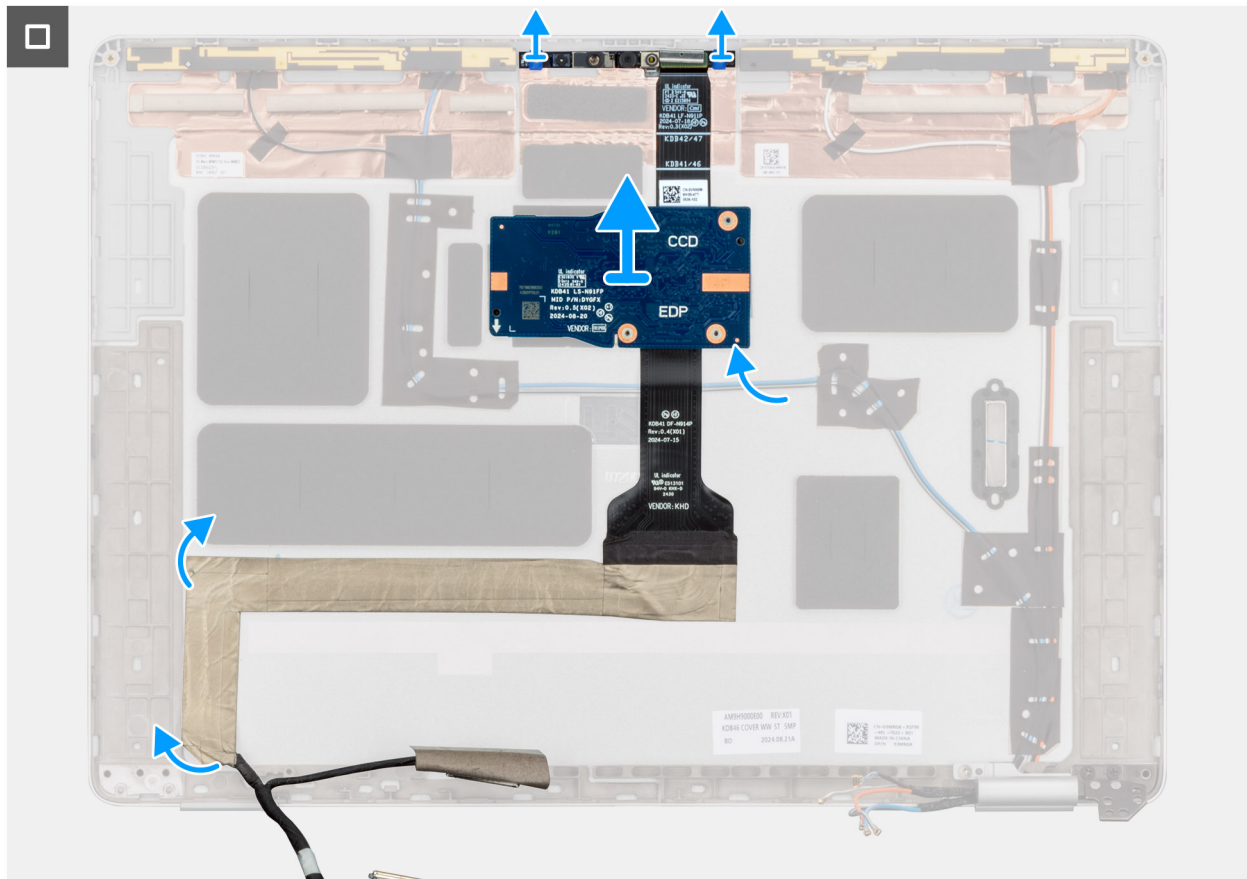

Figure 86. Removing the display cable for RGB/IR camera

Steps

1. Using a plastic scribe, pry the hinge rubber out of the left hinge cap.
2. Remove the screw (M2x3) and two screws (M2.5x3.5) that secure the left display hinge cap and hinge assembly to the display back cover.
3. Pinch the left hinge cap to remove the left hinge cap and hinge assembly from the display back cover.
4. Disconnect the display cable from the connector on the camera module.
5. Carefully peel and remove the display cable from the display back cover.

Installing the display cable for RGB/IR camera

CAUTION: The information in this installation section is intended for authorized service technicians only.

About this task

The following images indicate the location of the display cable for RGB/IR camera and provide a visual representation of the installation procedure.

NOTE: This procedure applies for only models that are shipped with an RGB or IR camera.

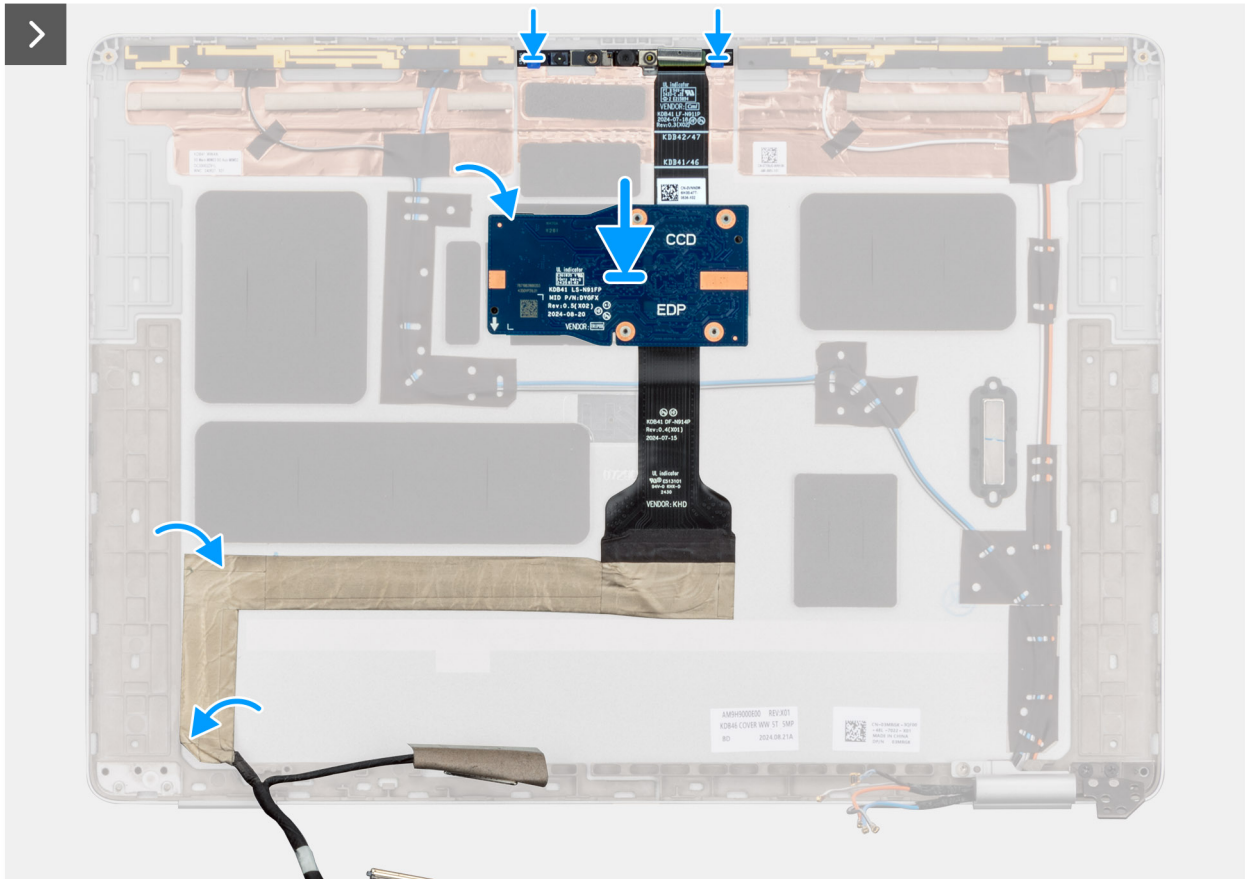
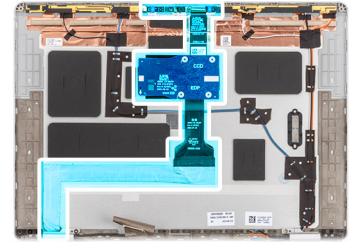

Figure 87. Installing the display cable for RGB/IR camera



Figure 88. Installing the display cable for RGB/IR camera

Steps

1. Adhere the display cable to the display back cover.

2. Connect the display cable to the connector on the camera module.
3. Carefully route the display cable through the display-hinge cap.
4. Align and place the left hinge cap and hinge assembly onto the display back cover.
5. Pinch the left hinge cap to secure the left hinge cap and hinge assembly to the display back cover.
6. Replace the screw (M2x3) and two screws (M2.5x3.5) that secure the left display hinge cap and hinge assembly on the display back cover.
7. Place the hinge rubber into the left hinge cap using a plastic scribe.

Next steps

1. Install the [display panel](#).
2. Install the [display bezel](#).
3. Install the [display assembly](#).
4. Install the [5G WWAN card](#) or [4G WWAN card](#), as applicable.
5. Install the [base cover](#).
6. Install the [SIM-card tray](#), if applicable.
7. Follow the procedure in [After working inside your computer](#).

Display cable for MIPI camera

Removing the display cable for MIPI camera

 **CAUTION:** The information in this removal section is intended for authorized service technicians only.

 **NOTE:** This procedure applies only to Dell Pro 14 Plus laptops.

Prerequisites

1. Follow the procedure in [Before working inside your computer](#).
2. Remove the [SIM-card tray](#), if applicable.
3. Remove the [base cover](#).
4. Remove the [5G WWAN card](#) or [4G WWAN card](#), as applicable.
5. Remove the [display assembly](#).
6. Remove the [display bezel](#).
7. Remove the [display panel](#).
8. Remove the [display hinge caps](#).
9. Remove the [MIPI camera](#).

About this task

 **NOTE:** This procedure applies for only models that are shipped with MIPI camera.

The following image indicates the location of the display cable for the MIPI camera and provides a visual representation of the removal procedure.



2x
M1.6x1.4

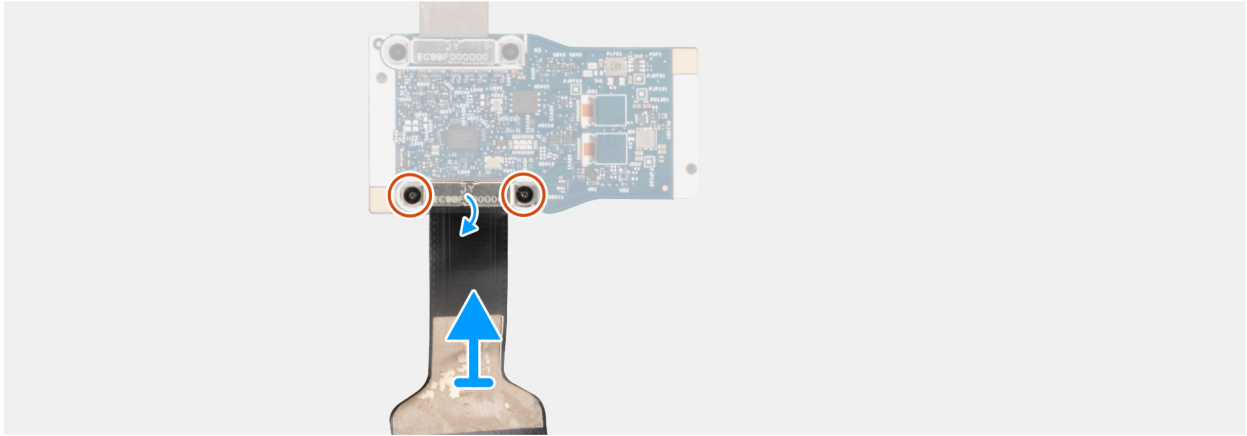
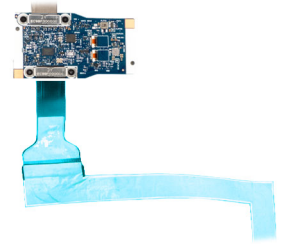

Figure 89. Removing the display cable for MIPI camera from middle board

Steps

1. Place the MIPI camera module on a clean, flat surface.
2. Turn the middle board over.
3. Remove the two screws (M1.6x1.4) that secure the display cable with the middle board.
4. Disconnect and remove the display cable from the connector on the middle board.

Installing the display cable for MIPI camera

⚠ CAUTION: The information in this installation section is intended for authorized service technicians only.

About this task

The following image indicates the location of the MIPI camera and provides a visual representation of the installation procedure.

ⓘ NOTE: This procedure applies for only models that are shipped with MIPI camera.

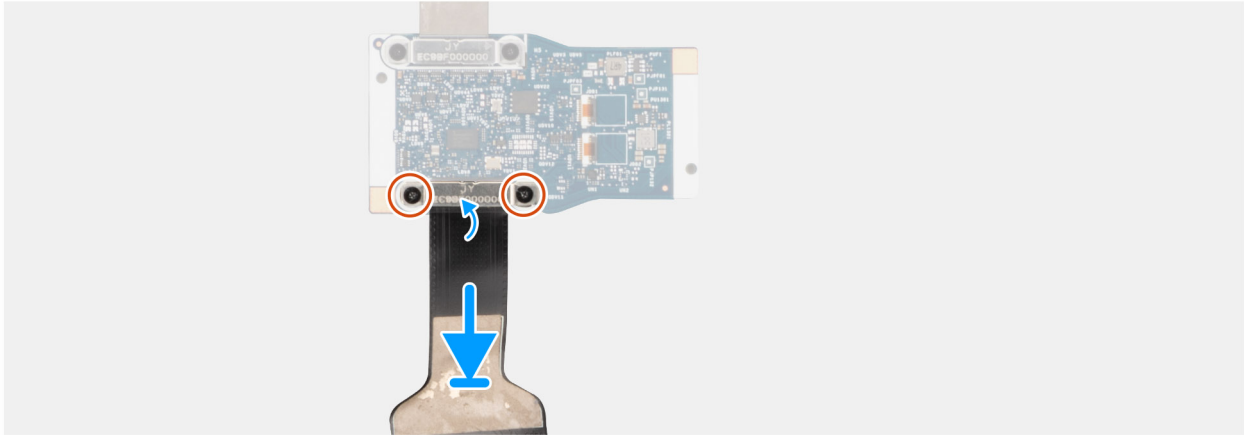
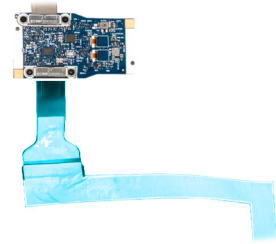

Figure 90. Installing the display cable for MIPI camera to middle board

Steps

1. Place the MIPI camera module on a clean, flat surface.
2. Turn the middle board over.
3. Connect the display cable to the connector on the middle board.
4. Replace the two screws (M1.6x1.4) to secure the display cable to the connector on the middle board.

Next steps

1. Install the [MIPI camera](#) .
2. Install the [display hinge caps](#).
3. Install the [display panel](#).
4. Install the [display bezel](#).
5. Install the [display assembly](#).
6. Install the [5G WWAN card](#) or [4G WWAN card](#), as applicable.
7. Install the [base cover](#).
8. Install the [SIM-card tray](#), if applicable.
9. Follow the procedure in [After working inside your computer](#).

Middle-board cable

Removing the middle-board cable

CAUTION: The information in this removal section is intended for authorized service technicians only.

NOTE: This procedure applies only to Dell Pro 14 Plus laptops.

Prerequisites

1. Follow the procedure in [Before working inside your computer](#).
2. Remove the [SIM-card tray](#), if applicable.

3. Remove the [base cover](#).
4. Remove the [5G WWAN card](#) or [4G WWAN card](#), as applicable.
5. Remove the [display assembly](#).
6. Remove the [display bezel](#).
7. Remove the [display panel](#).
8. Remove the [display hinge caps](#).
9. Remove the [MIPI camera](#).

About this task

The following images indicate the location of the middle-board cable and provide a visual representation of the removal procedure.

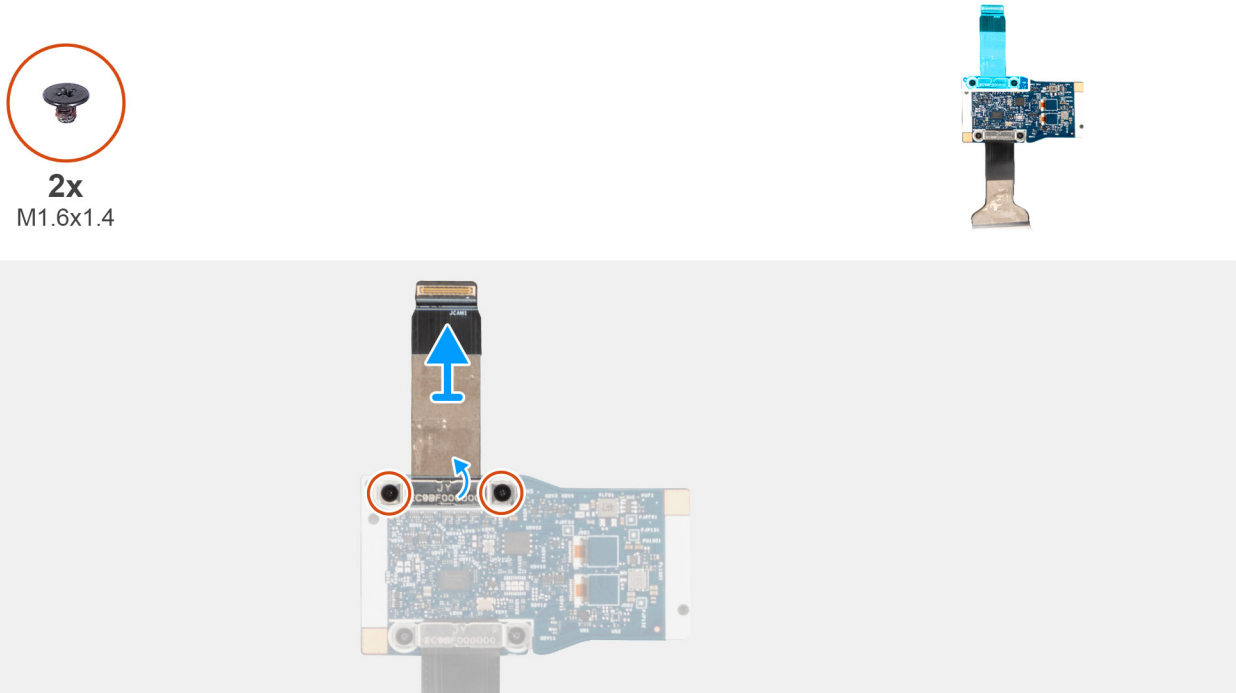

Figure 91. Removing the middle-board cable

Steps

1. Place the MIPI camera module on a clean, flat surface.
2. Turn the middle board over.
3. Remove the two screws (M1.6x1.4) that secure the middle-board cable to the middle board.
4. Disconnect and remove the middle-board cable from connector on the middle board.

Installing the middle-board cable

CAUTION: The information in this installation section is intended for authorized service technicians only.

Prerequisites

If you are replacing a component, remove the existing component before performing the installation procedure.

About this task

The following images indicate the location of the middle-board cable and provide a visual representation of the installation procedure.



2x
M1.6x1.4

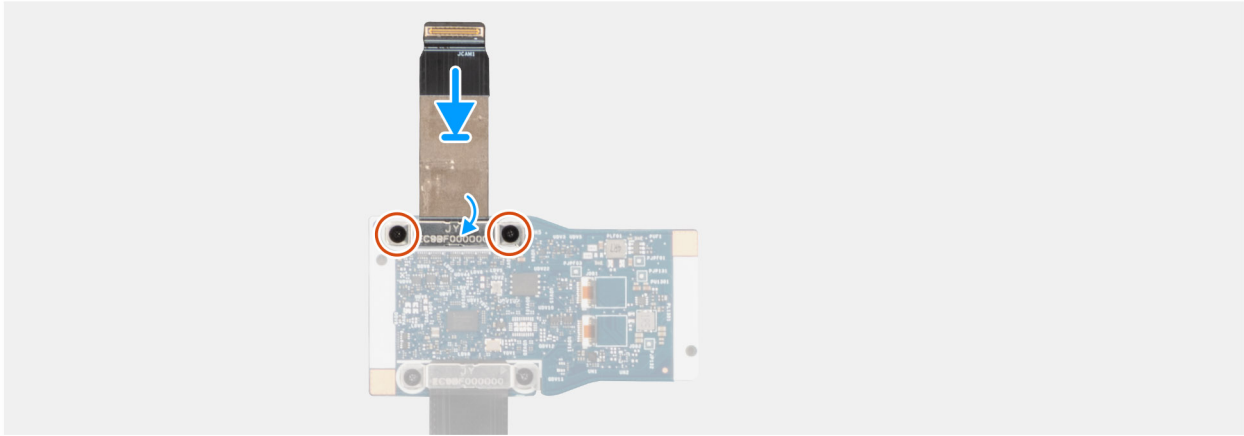

Figure 92. Installing the middle-board cable

Steps

1. Place the MIPI camera module on a clean, flat surface.
2. Turn the middle board over.
3. Connect the middle-board cable to the connector on the middle board.
4. Replace the two screws (M1.6x1.4) that secure the middle-board cable to the middle board.

Next steps

1. Install the [MIPI camera](#).
2. Install the [display hinge caps](#).
3. Install the [display panel](#).
4. Install the [display bezel](#).
5. Install the [display assembly](#).
6. Install the [5G WWAN card](#) or [4G WWAN card](#), as applicable.
7. Install the [base cover](#).
8. Install the [SIM-card tray](#), if applicable.
9. Follow the procedure in [After working inside your computer](#).

Middle board

Removing the middle board

CAUTION: The information in this removal section is intended for authorized service technicians only.

Prerequisites

1. Follow the procedure in [Before working inside your computer](#).
2. Remove the [SIM-card tray](#), if applicable.
3. Remove the [base cover](#).
4. Remove the [5G WWAN card](#) or [4G WWAN card](#), as applicable.

5. Remove the [display assembly](#).
6. Remove the [display bezel](#).
7. Remove the [display panel](#).
8. Remove the [display hinge caps](#).
9. Remove the [MIPI camera](#).
10. Remove the [display cable for MIPI camera](#).
11. Remove the [middle-board cable](#).

About this task

The following images indicate the location of the middle board and provide a visual representation of the removal procedure.

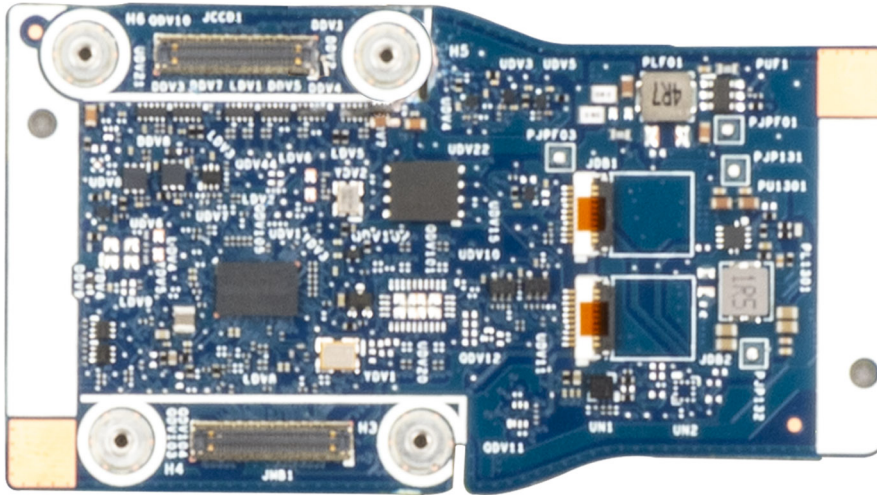

Figure 93. Middle board

Steps

After performing the **Prerequisites**, you are left with the middle board.

Installing the middle board

CAUTION: The information in this installation section is intended for authorized service technicians only.

Prerequisites

If you are replacing a component, remove the existing component before performing the installation procedure.

About this task

The following images indicate the location of the middle board and provide a visual representation of the installation procedure.

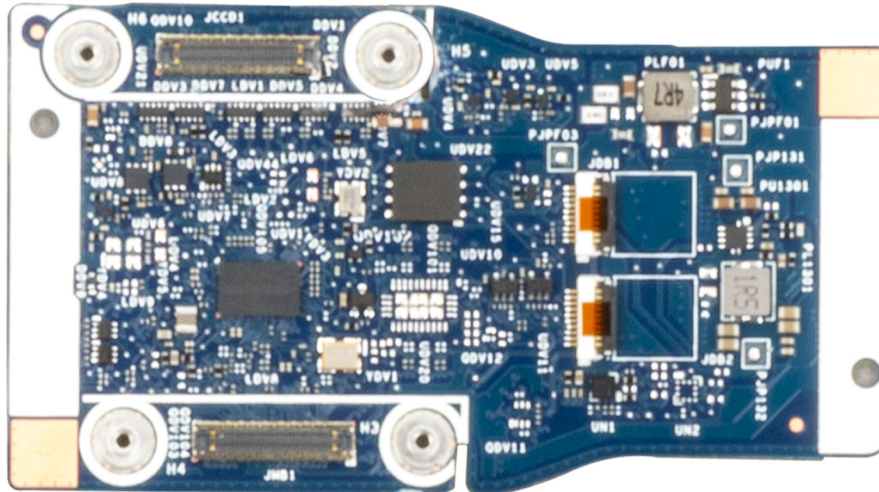

Figure 94. Middle board

Steps

Place the middle board on a clean flat surface and perform the post-requisites to install it to the display backcover.</

About this task

NOTE: The display back-cover and antenna assembly cannot be further disassembled once all the Prerequisites are completed. If the wireless antennas are malfunctioning and are required to be replaced, replace the entire display backcover and antenna assembly.

The following image indicates the display back-cover and antenna assembly and provide a visual representation of the removal procedure.

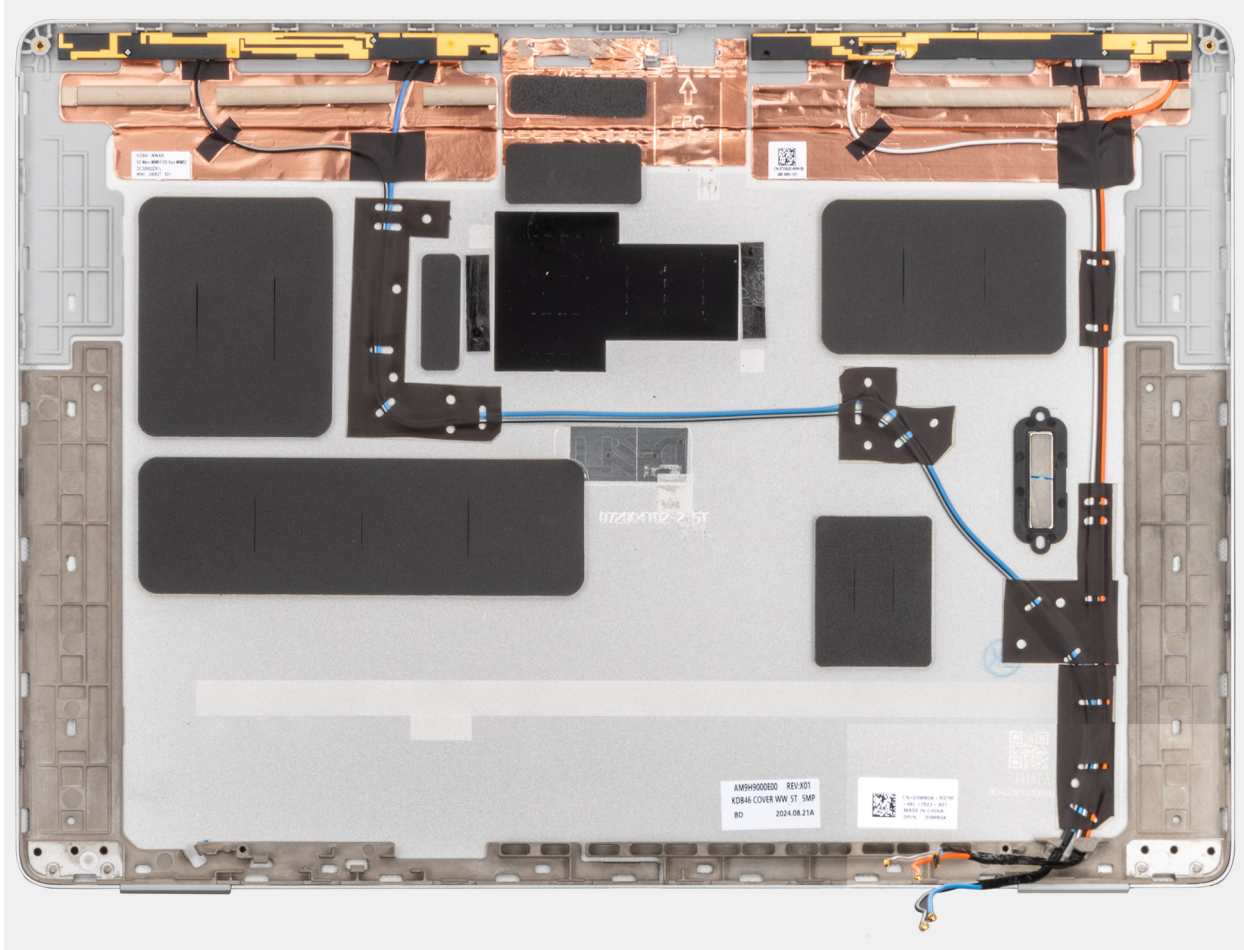

Figure 95. Removing display back-cover and antenna assembly

Steps

After performing the **Prerequisites**, you are left with the display back-cover and antenna assembly.

Installing the display back-cover and antenna assembly

CAUTION: The information in this installation section is intended for authorized service technicians only.

Prerequisites

If you are replacing a component, remove the existing component before performing the installation procedure.

About this task

The following images indicate the location of the display back-cover and antenna assembly.

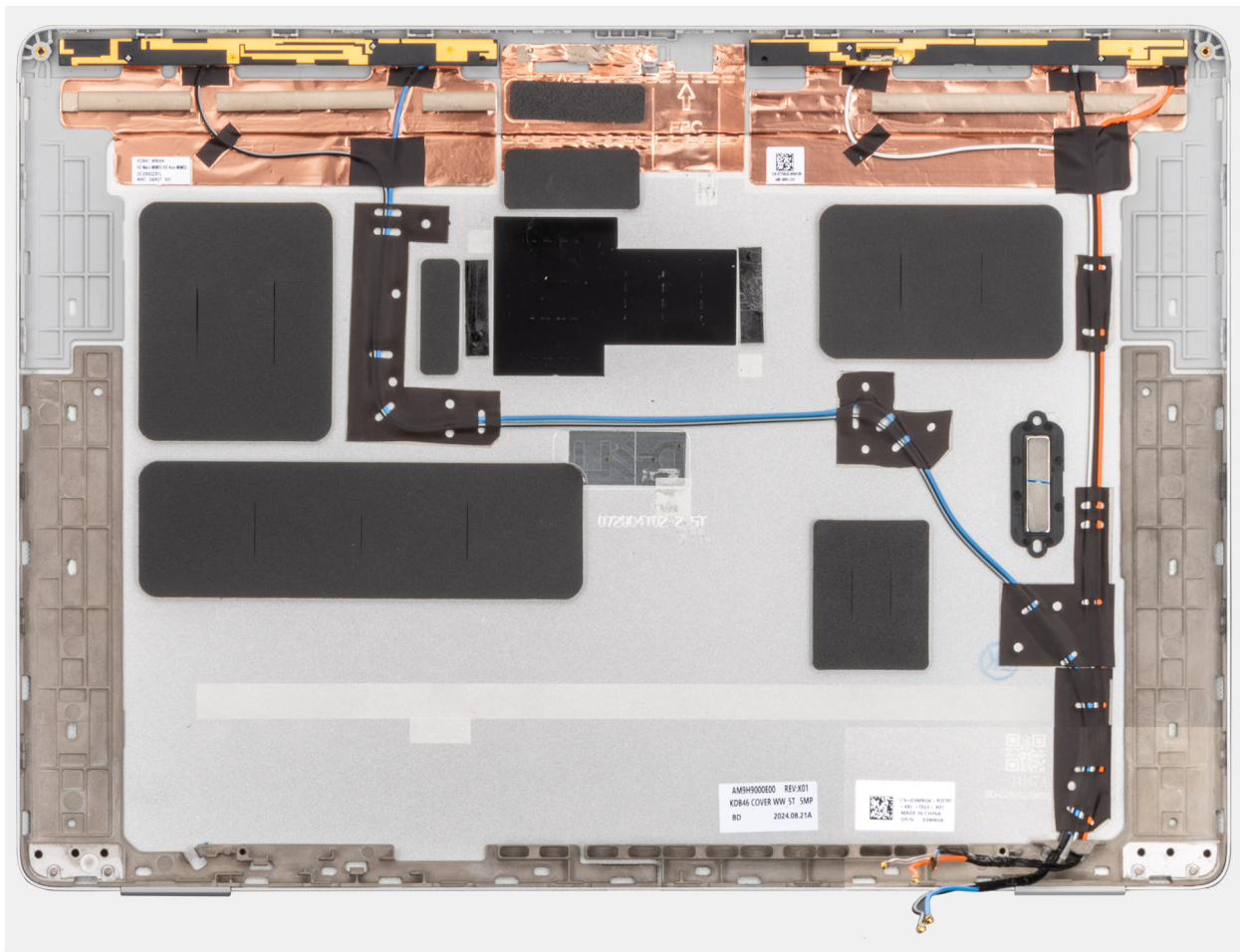

Figure 96. Display back-cover and antenna assembly

Steps

Place the display back-cover and antenna assembly on a flat surface and perform the post-requisites to install the display back-cover and antenna assembly.

Next steps

1. Install the [display cable for RGB/IR camera](#) or the [display cable for MIPI camera](#), as applicable.
2. Install the [RGB/IR camera](#) or the [MIPI camera](#), as applicable.
3. Install the [display hinge caps](#).
4. Install the [display panel](#).
5. Install the [display bezel](#).
6. Install the [display assembly](#).
7. Install the [5G WWAN card](#) or [4G WWAN card](#), as applicable.
8. Install the [base cover](#).
9. Install the [SIM-card tray](#), if applicable.
10. Follow the procedure in [After working inside your computer](#).

Keyboard

Removing the keyboard

CAUTION: The information in this removal section is intended for authorized service technicians only.

Prerequisites

1. Follow the procedure in [Before working inside your computer](#).
2. Remove the [SIM-card tray](#), if applicable.
3. Remove the [base cover](#).
4. Remove the [battery](#).
5. Remove the [5G WWAN card](#) or [4G WWAN card](#), as applicable.
6. Remove the [M.2 2230 solid state drive](#) or [M.2 2280 solid state drive](#), as applicable.
7. Remove the [fan](#).
8. Remove the [system board](#).

NOTE: The system board can be removed and installed with the heat sink attached in order to simplify the procedure and preserve the thermal bond between the system board and heat sink.

9. Remove the [I/O board](#).
10. Remove the [power button with optional fingerprint reader](#).

About this task

The following images indicate the location of the keyboard and provide a visual representation of the removal procedure.

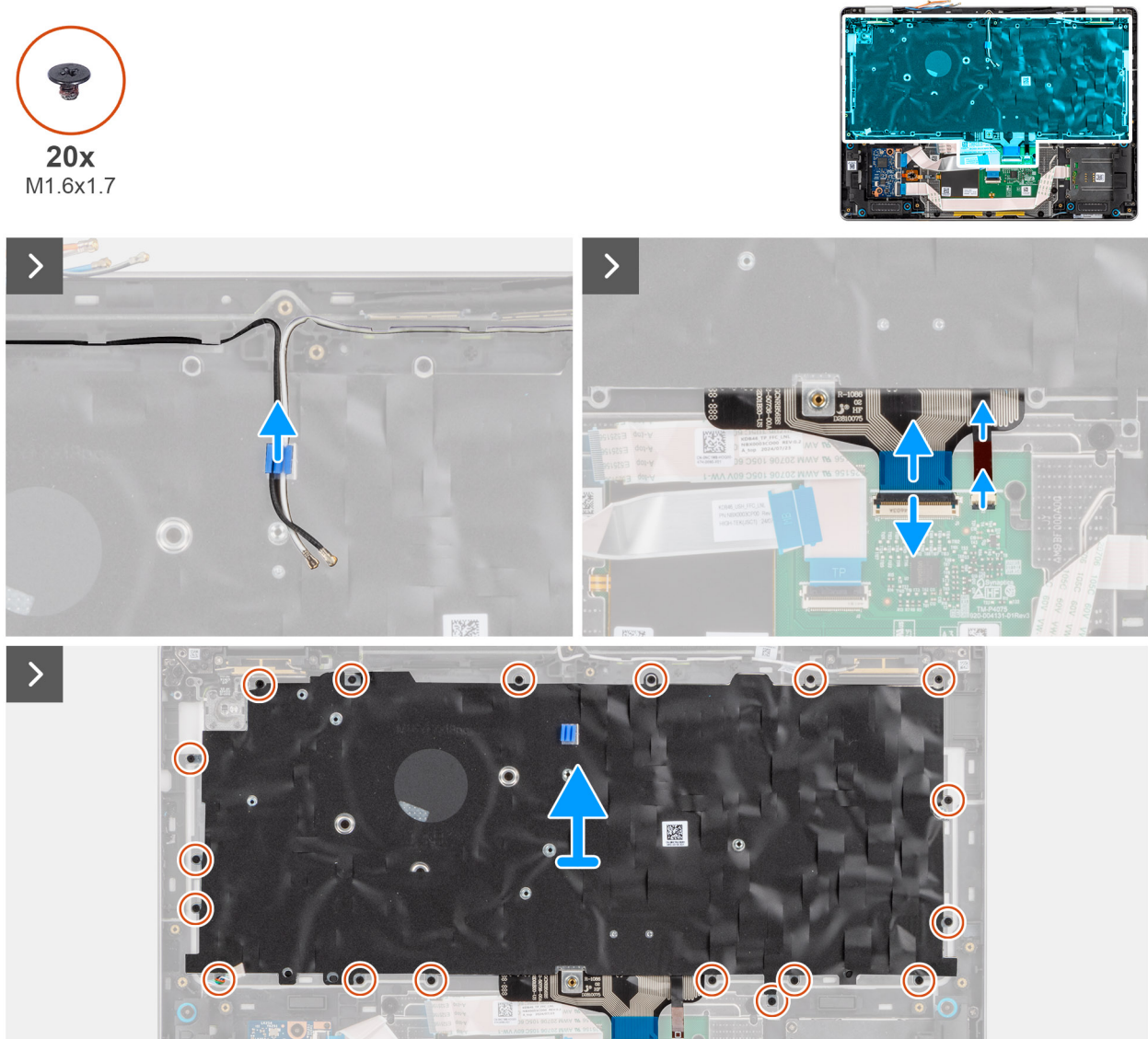

Figure 97. Removing the keyboard



Figure 98. Removing the keyboard

Steps

1. Remove the WLAN antenna cables from the routing guides on the keyboard bracket.
2. Disconnect the keyboard cable and keyboard backlight cable (for models that are shipped with the keyboard backlight) from the connectors on the touchpad.
3. Remove the 18 screws (M1.6x1.7) that secure the keyboard assembly to the palm-rest assembly.
4. Lift the keyboard assembly off the palm-rest assembly.
5. Remove the two screws (M1.6x1.7) that secure the keyboard to the keyboard bracket from the top side.
6. Lift the keyboard off the keyboard bracket.

Installing the keyboard

CAUTION: The information in this installation section is intended for authorized service technicians only.

Prerequisites

If you are replacing a component, remove the existing component before performing the installation procedure.

About this task

The following images indicate the location of the keyboard and provide a visual representation of the installation procedure.



20x
M1.6x1.7



Figure 99. Installing the keyboard

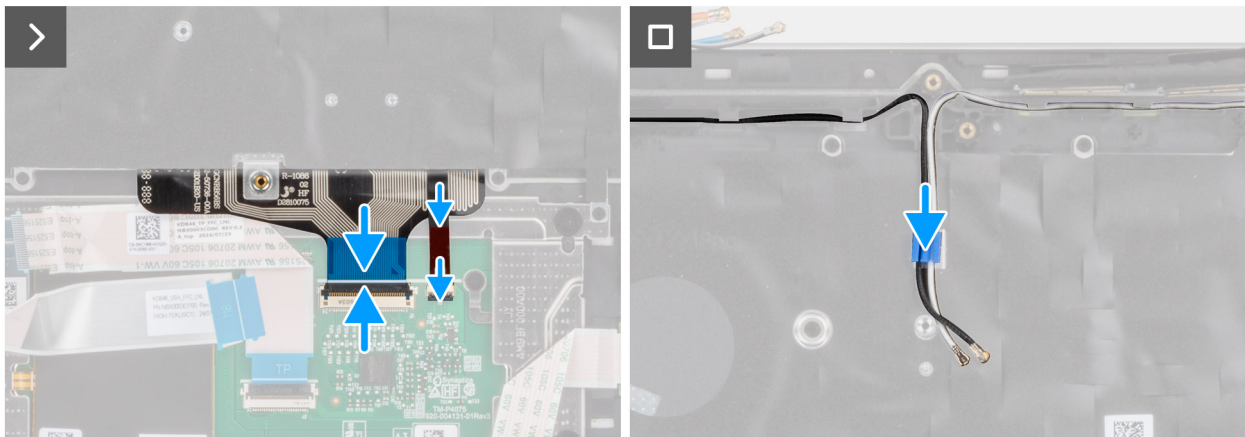
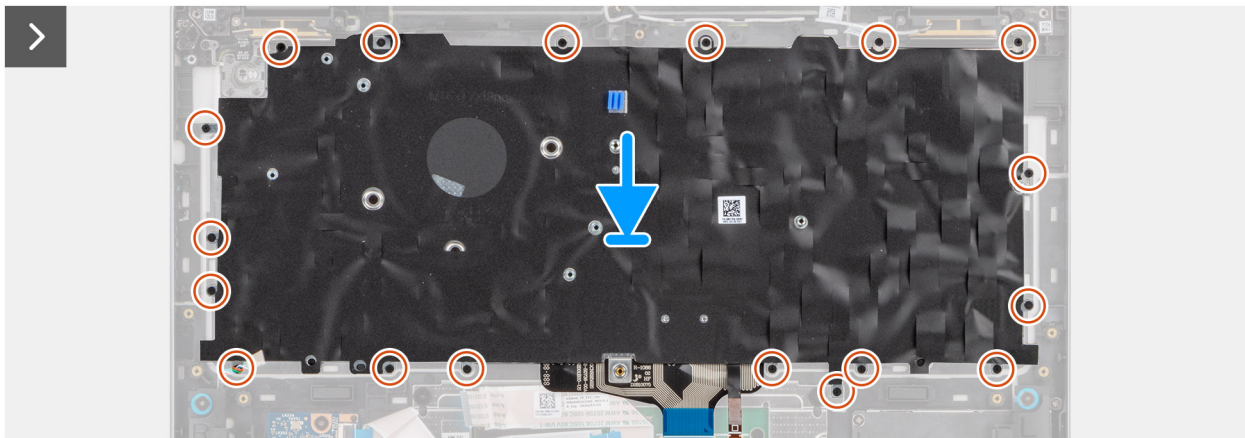



Figure 100. Installing the keyboard

Steps

1. Align and place the keyboard on the keyboard bracket.
2. Replace the two screws (M1.6x1.7) that secure the keyboard to the keyboard bracket from the top side.
3. Align and place the keyboard assembly on to the palm-rest assembly.
 **NOTE:** Ensure that the WLAN antenna cables are not stuck under the keyboard.
4. Replace the 18 screws (M1.6x1.7) that secure the keyboard to the palm-rest assembly.
5. Connect the keyboard cable and keyboard backlight cable (for models that are shipped with the keyboard backlight) to the connectors on the touchpad.
6. Route the WLAN antenna cables through the routing guides on the keyboard bracket.

Next steps

1. Install the [power button with optional fingerprint reader](#).
2. Install the [I/O board](#).
3. Install the [system board](#).

 **NOTE:** The system board can be removed and installed with the heat sink attached in order to simplify the procedure and preserve the thermal bond between the system board and heat sink.

4. Install the [fan](#).
5. Install the [M.2 2230 solid state drive](#) or [M.2 2280 solid state drive](#), as applicable.
6. Install the [5G WWAN card](#) or [4G WWAN card](#), as applicable.
7. Install the [battery](#).
8. Install the [base cover](#).
9. Install the [SIM-card tray](#), if applicable.
10. Follow the procedure in [After working inside your computer](#).

Palm-rest assembly

Removing the palm-rest assembly

 **CAUTION:** The information in this removal section is intended for authorized service technicians only.

Prerequisites

1. Follow the procedure in [Before working inside your computer](#).
2. Remove the [SIM-card tray](#), if applicable.
3. Remove the [base cover](#).
4. Remove the [battery](#).
5. Remove the [5G WWAN card](#) or [4G WWAN card](#), as applicable.
6. Remove the [M.2 2230 solid state drive](#) or [M.2 2280 solid state drive](#), as applicable.
7. Remove the [speakers](#).
8. Remove the [fan](#).
9. Remove the [USH board](#).
10. Remove the [smart card reader](#).
11. Remove the [system board](#).

 **NOTE:** The system board can be removed and installed with the heat sink attached in order to simplify the procedure and preserve the thermal bond between the system board and heat sink.

12. Remove the [WLAN antenna modules](#).
13. Remove the [I/O board](#).
14. Remove the [power button with fingerprint reader](#).
15. Remove the [display assembly](#).
16. Remove the [keyboard](#).

About this task

The following images indicate the location of the palm-rest assembly and provide a visual representation of the removal procedure.

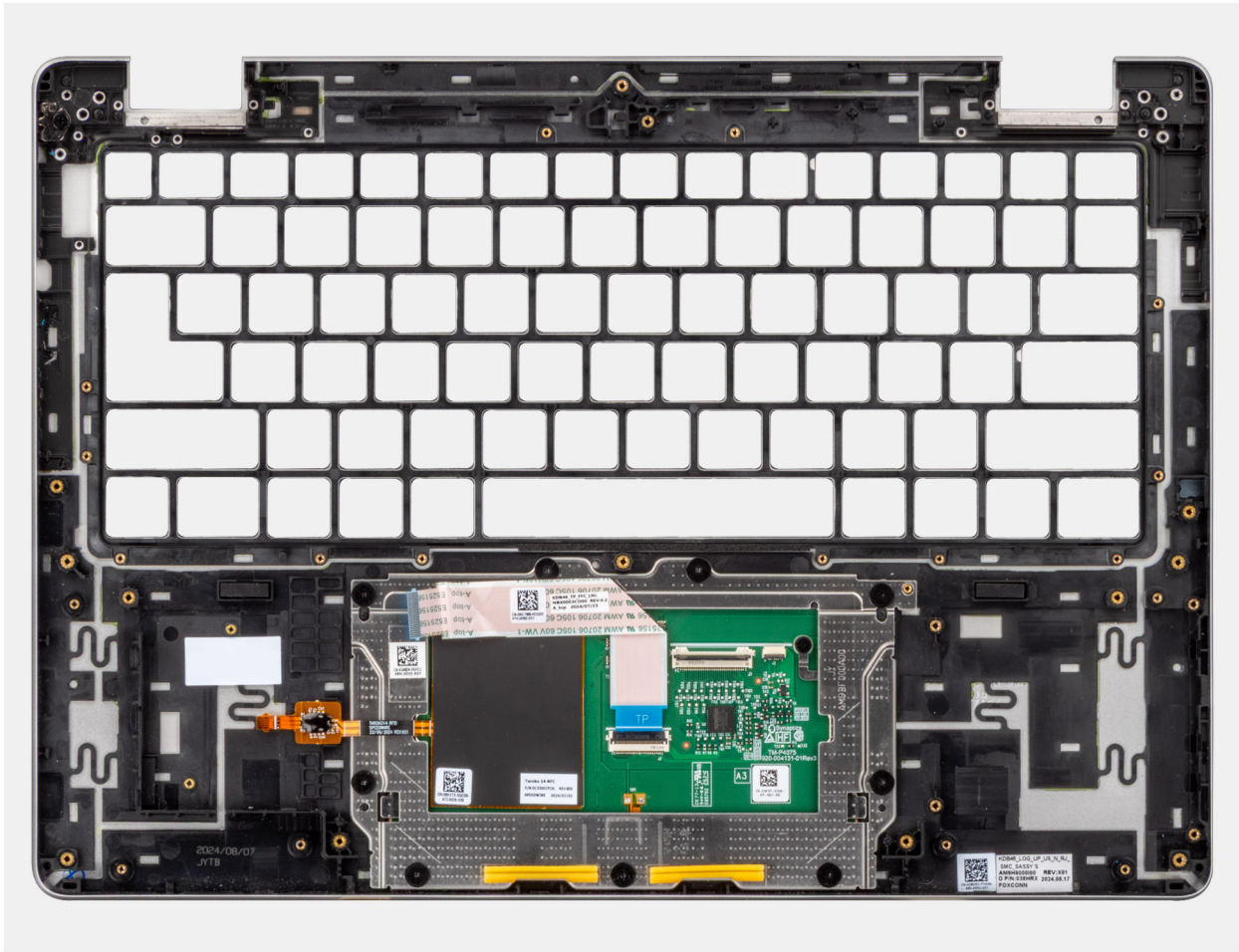

Figure 101. Palm-rest assembly

NOTE: When replacing the palm-rest assembly for models shipped with WLAN card, use a plastic scribe to pry off the SIM-card slot filler from the palm-rest assembly and then transfer it over to the replacement palm-rest assembly.

Steps

After performing the **Prerequisites**, you are left with the palm-rest assembly.

Installing the palm-rest assembly

CAUTION: The information in this installation section is intended for authorized service technicians only.

Prerequisites

If you are replacing a component, remove the existing component before performing the installation procedure.

NOTE: When replacing the palm-rest assembly for models shipped with WLAN card, ensure to transfer the SIM-card slot filler over the replacement palm-rest assembly.

About this task

The following images indicate the location of the palm-rest assembly and provide a visual representation of the installation procedure.

Steps

Place the palm-rest assembly on a clean and flat surface and perform the post-requisites to install the palm-rest assembly.

 **NOTE:** Touchpad is pre-assembled with the palm-rest assembly.

Next steps

1. Install the [keyboard](#).
2. Install the [display assembly](#).
3. Install the [power button with fingerprint reader](#).
4. Install the [I/O board](#).
5. Install the [WLAN antenna modules](#).
6. Install the [system board](#).

 **NOTE:** The system board can be removed and installed with the heat sink attached in order to simplify the procedure and preserve the thermal bond between the system board and heat sink.

7. Install the [smart card reader](#).
8. Install the [USH board](#).
9. Install the [fan](#).
10. Install the [speakers](#).
11. Install the [M.2 2230 solid state drive](#) or [M.2 2280 solid state drive](#), as applicable.
12. Install the [5G WWAN card](#) or [4G WWAN card](#), as applicable.
13. Install the [battery](#).
14. Install the [base cover](#).
15. Install the [SIM-card tray](#), if applicable.
16. Follow the procedure in [After working inside your computer](#).

Software

This chapter details the supported operating systems along with instructions on how to install the drivers.

Operating system

Your Dell Pro 14 Plus/Dell Pro 14 Plus 2-in-1 supports the following operating systems:

- Windows 11 Home
- Windows 11 Pro
- Windows 10 Home
- Windows 10 Pro
- Ubuntu Linux 24.04 LTS

NOTE: Ubuntu is supported only on Dell Pro 14 Plus.

NOTE: If you downgrade your computer from Windows 11 to Windows 10 22H2, Dell Technologies support follows the Microsoft Windows 10 End of Support plan.

NOTE: Windows 10 Home and Windows 10 Pro is supported only on computers shipped with AMD Ryzen 200 series processors.

Drivers and downloads

When troubleshooting, downloading, or installing drivers, it is recommended that you read the [Dell Knowledge Base article Drivers and Downloads FAQs](#).

BIOS Setup

CAUTION: Certain changes can make your computer work incorrectly. Before you change the settings in BIOS Setup, it is recommended that you note down the original settings for future reference.

NOTE: Depending on the computer and the installed devices, the options that are listed in this section may differ.

Use BIOS Setup for the following purposes:

- Get information about the hardware installed in your computer, such as the amount of RAM and the capacity of the storage device.
- Change the system configuration information.
- Set or change user-selectable options such as the user password, enabling or disabling base devices, and configuring hard drive settings.

Entering BIOS Setup program

Turn on or restart your computer and press F2 immediately.

Navigation keys

NOTE: For most of the BIOS Setup options, changes that you make are recorded but do not take effect until you restart the computer.

Table 37. Navigation keys

Keys	Navigation
Up arrow	Moves to the previous field.
Down arrow	Moves to the next field.
Enter	Selects a value in the selected field (if applicable) or follows the link in the field.
Spacebar	Expands or collapses a drop-down list, if applicable.
Tab	Moves to the next focus area.
Esc	Moves to the previous page until you view the main screen. Pressing Esc in the main screen displays a message that prompts you to save any unsaved changes and restart the computer.

F12 One Time Boot menu

To enter the One Time Boot menu, turn on or restart your computer, and then press F12 immediately.

NOTE: If you are unable to enter the One Time Boot menu, repeat the above action.

The One Time Boot menu displays the devices that you can boot from and also display the options to start diagnostics. The boot menu options are:

- Removable Drive (if available)
- STXXXX Drive (if available)

NOTE: XXXX denotes the SATA drive number.

- Optical Drive (if available)
- SATA Hard Drive (if available)
- Diagnostics

The One Time Boot menu screen also displays the option to access BIOS Setup.

View Advanced Setup options

About this task

Some BIOS Setup options are only visible by enabling **Advanced Setup** mode, which is disabled by default.

NOTE: BIOS Setup options, including **Advanced Setup** options, are described in [BIOS setup options](#).

To enable Advanced Setup:

Steps

1. Enter BIOS Setup.
The Overview menu appears.
2. Click the **Advanced Setup** option to move it to the **ON** mode.
Advanced BIOS Setup options are displayed.

View Service options

About this task

Service options are hidden by default and only visible by entering a hotkey command.

NOTE: Service options are described in [BIOS Setup options](#).

To view Service options:

Steps

1. Enter BIOS Setup.
The Overview menu appears.
2. Enter the hotkey combination **Ctrl + Alt + s** to view the **Service** options.
Service options are displayed.

BIOS Setup options

NOTE: Depending on your computer and its installed devices, the items that are listed in this section may or may not be displayed.

Table 38. BIOS Setup options—Overview menu

Overview	
Dell Pro 14 Plus PB14255	
BIOS Version	Displays the BIOS version number.
Service Tag	Displays the Service Tag of the computer.
Asset Tag	Displays the Asset Tag of the computer.
Manufacture Date	Displays the manufacture date of the computer.

Table 38. BIOS Setup options—Overview menu (continued)

Overview	
Ownership Date	Displays the ownership date of the computer.
Express Service Code	Displays the Express Service Code of the computer.
Ownership Tag	Displays the Ownership Tag of the computer.
Battery Information	
Primary	Displays the primary battery of the computer.
Battery Level	Displays the battery level of the computer.
Battery State	Displays the battery state of the computer.
Health	Displays the battery health of the computer.
AC Adapter	Displays whether an AC adapter is connected. If connected, displays the type of AC adapter that is connected.
Battery Life Type	Displays the battery life type of the computer.
Processor Information	
Processor Type	Displays the processor type.
Maximum Clock Speed	Displays the maximum processor clock speed.
Minimum Clock Speed	Displays the minimum processor clock speed.
Current Clock Speed	Displays the current processor clock speed.
Core Count	Displays the number of cores on the processor.
Processor ID	Displays the processor identification code.
Microcode Version	Displays the microcode version.
Simultaneous Multi-Threading Capable	Displays whether the processor is Simultaneous Multi-Threading capable.
Processor L2 Cache	Displays the L2 Cache.
Processor L3 Cache	Displays the L3 Cache.
Memory Information	
Memory Installed	Displays the total memory that is installed on the computer.
Memory Available	Displays the total memory available on the computer.
Memory Speed	Displays the memory speed.
Memory Channel Mode	Displays single or dual channel mode.
Memory Technology	Displays the technology that is used for the memory.
DIMM 1 Size	Displays the memory size of DIMM 1 slot.
DIMM 2 Size	Displays the memory size of DIMM 2 slot.
DIMM 3 Size	Displays the memory size of DIMM 3 slot.
DIMM 4 Size	Displays the memory size of DIMM 4 slot.
Devices Information	
Panel Type	Displays the type of display panel available on the computer.
Panel Revision	Displays the panel revision of the computer.
Video Controller	Displays the type of video controller available on the computer.
Video Memory	Displays the video memory information of the computer.
Wi-Fi Device	Displays the wireless device information of the computer.

Table 38. BIOS Setup options—Overview menu (continued)

Overview	
Native Resolution	Displays the native resolution of the computer.
Video BIOS Version	Displays the video BIOS version of the computer.
Audio Controller	Displays the audio controller information of the computer.
Bluetooth Device	Displays the Bluetooth device information of the computer.
Pass Through MAC Address	Displays the MAC address of the video pass-through.
LOM MAC Address	Displays the LOM MAC Address of the computer.
Cellular Device	Displays the Cellular device information of the computer.

Table 39. BIOS Setup options—Boot Configuration menu

Boot Configuration	
Boot Sequence	
Boot Sequence	Displays the boot sequence.
Enable PXE Boot Priority	When enabled, any new PXE boot option that is detected by the computer is added to the top of the Boot Sequence. By default, the Enable PXE Boot Priority option is disabled.
UEFI Network Boot Order	This option is used to select IPv4 and IPv6 option boot order.
Extended IPv4 PXE Boot Timeout	Enter the Extended IPv4 PXE Boot Timeout value only if the IPv4 PXE Boot fails with standard timeouts.
Secure Boot	
Enable Secure Boot	Secure Boot is a method of guaranteeing the integrity of the boot path by performing additional validation of the operating system and PCI add-in cards. The computer stops booting to the operating system when a component is not authenticated during the boot process. Secure Boot can be enabled in BIOS setup or using management interfaces like Dell Command Configure, but can only be disabled from BIOS setup. Enables the computer to boot using only validated boot software. By default, the Enable Secure Boot option is disabled. For additional security, Dell Technologies recommends keeping the Secure Boot option enabled to ensure that the UEFI firmware validates the operating system during the boot process. i NOTE: For Secure Boot to be enabled, the computer is required to be in UEFI boot mode and the Enable Legacy Option ROMs option is required to be turned off.
Secure Boot Mode	Enables or disables the Secure Boot operation mode. By default, the Deployed Mode is selected. i NOTE: Deployed Mode should be selected for normal operation of Secure Boot.
Enable Microsoft UEFI CA	When disabled, the UEFI CA is removed from the BIOS UEFI Secure Boot database. By default, the Enable Microsoft UEFI CA option is disabled.
Expert Key Management	
Enable Custom Mode	Enables or disables the ability to modify the keys in the PK, KEK, db, and dbx security key databases to be modified. By default, the Enable Custom Mode option is disabled.

Table 39. BIOS Setup options—Boot Configuration menu (continued)

Boot Configuration	
Custom Mode Key Management	Selects the custom values for expert key management. By default, the PK option is selected.

Table 40. BIOS Setup options—Integrated Devices menu

Integrated Devices	
Date/Time	
Date	Sets the computer date in MM/DD/YYYY format. Changes to the date format take effect immediately.
Time	Sets the computer time in HH/MM/SS 24-hour format. You can switch between a 12-hour and 24-hour clock. Changes to the time format take effect immediately.
Camera	
Enable Camera	Enables the camera. By default, the Enable Camera option is enabled. i NOTE: Depending on the configuration ordered, the camera setup option may not be available.
Audio	
Enable Audio	Enables all integrated audio controller. By default, all the options are enabled.
Enable Microphone	Enables the microphone. By default, the Enable Microphone option is enabled. i NOTE: Depending on the configuration ordered, the microphone setup option may not be available.
Enable Internal Speaker	Enables the internal speaker. By default, the Enable Internal Speaker option is enabled.
USB/Thunderbolt Configuration	
Enable USB Boot Support	Enables booting from USB mass storage devices that are connected to external USB ports. By default, the Enable USB Boot Support option is enabled.
Enable External USB Ports	Enables the external USB ports. By default, the Enable External USB Ports option is enabled.
Enable Thunderbolt Technology Support	
Enable Thunderbolt Technology Support	Enables the associated ports and adapters for Thunderbolt Technology support. By default, the Enable Thunderbolt Technology Support option is enabled.
Enable Thunderbolt Boot Support	
Enable Thunderbolt Boot Support	Enables the Thunderbolt adapter-peripheral device and USB devices that are connected to the Thunderbolt adapter to be used during BIOS Preboot. By default, the Enable Thunderbolt Boot Support option is disabled.
Enable Thunderbolt (and PCIe behind TBT) pre-boot modules	
	Enables the PCIe devices that are connected through a Thunderbolt adapter to run the PCIe devices UEFI Option ROM (if present) during preboot.

Table 40. BIOS Setup options—Integrated Devices menu (continued)

Integrated Devices	
	By default, the Enable Thunderbolt (and PCIe behind TBT) pre-boot modules option is disabled.
Video/Power only on Type-C Ports	Enables or disables the Type-C port functionality to video or only power. By default, the Video/Power only on Type-C Ports option is disabled.
Miscellaneous Devices	
Enable Fingerprint Reader Device	Enables the Fingerprint Reader Device option. By default, the Enable Fingerprint Reader Device option is enabled.
Microsoft Mute Led	This setting will indicate LED status of Microphone.

Table 41. BIOS Setup options—Storage menu

Storage	
SATA/NVMe Operation	
SATA/NVMe Operation	Sets the operating mode of the integrated SATA hard drive controller. By default, the AHCI/NVMe option is selected. The storage device is configured for AHCI/NVMe mode.
Storage Interface	Displays the information of various onboard drives.
Port Enablement	Enables or disables the M.2 PCIe SSD option. By default, the M.2 PCIe SSD option is enabled.
Self-Monitoring, Analysis, and Reporting Technology (SMART) Reporting	
Enable SMART Reporting	Enables or disables the Smart reporting option. By default, the Smart Reporting option is disabled.  NOTE: To view this option, enable Advanced Setup mode as described in View Advanced Setup options .
Drive Information	Displays the information of onboard drives.

Table 42. BIOS Setup options—Display menu

Display	
Touchscreen	Controls whether the touchscreen is enabled or disabled for the operating system.  NOTE: Touchscreen will always work in BIOS setup irrespective of this setting.
Full Screen Logo	Enables or disables the computer to display a full-screen logo, if the image matches screen resolution. By default, the Full Screen Logo option is disabled.

Table 43. BIOS Setup options—Connection menu

Connection	
Network Controller Configuration	
Integrated NIC	This option controls the on-board LAN Controller. By default, the Enabled with PXE option is enabled.

Table 43. BIOS Setup options—Connection menu (continued)

Connection	
Wireless Device Enable	
WLAN	Enables or disables the internal WLAN device. By default, the WLAN option enabled.
WWAN/GPS	Enables or disables the internal WWAN device. By default, the WWAN/GPS option is enabled.
Bluetooth	Enables or disables the internal Bluetooth device. By default, the Bluetooth option enabled.
Contactless Smartcard/NFC	Enables or disables the smartcard device. By default, the Contactless Smartcard/NFC option is enabled. i NOTE: To view this option, enable Advanced Setup mode as described in View Advanced Setup options .
Enable UEFI Network Stack	Enables or disables the UEFI Network Stack and controls the onboard LAN Controller. By default, the Auto-Enabled option is enabled.
IPv4 PXE Boot	When enabled, IPv4 PXE Boot option is available. When disabled, IPv4 PXE Boot option is not available.
IPv6 PXE Boot	When enabled, IPv6 PXE Boot option is available. When disabled, IPv4 PXE Boot option is not available.
Wireless Radio Control	
Control WLAN Radio	Enables to sense the connection of the computer to a wired network and then disables the selected wireless radios (WLAN and/or WWAN). Upon disconnection from the wired network, the selected wireless radios are reenabled. By default, the Control WLAN Radio option is disabled.
Control WWAN Radio	Enables to sense the connection of the computer to a wired network and then disables the selected wireless radios (WLAN and/or WWAN). Upon disconnection from the wired network, the selected wireless radios are reenabled. By default, the Control WWAN Radio option is disabled.
HTTP(s) Boot Feature	
HTTP(s) Boot	When enabled, supports HTTP(s) boot on the client BIOS, which offers wired or wireless and HTTP/HTTPS connection options. i NOTE: To view this option, enable HTTP(s) Boot as described in View Advanced Setup options .
HTTP(s) Boot Modes	In Auto Mode, the boot URL is obtained from the DHCP response; the boot URL specifies the HTTP Boot Server and location of the Network Boot Program (NBP) file. In Manual mode, the user enters the URL in the text box, which must start with <code>http://</code> or <code>https://</code> and end with the NBP file name. By default, Auto Mode is selected. i NOTE: To view this option, enable Advanced Setup mode as described in View Advanced Setup options .

Table 44. BIOS Setup options—Power menu

Power	
Battery Configuration	<p>Enables or disables the computer to run on battery during peak power usage hours. Set the values for Custom Charge Start and Custom Charge Stop, to prevent AC power usage between certain times of each day.</p> <p>By default, the Adaptive option is selected. Battery settings are adaptively optimized based on your typical battery usage pattern.</p>
Advanced Configuration	
Enable Advanced Battery Charge Configuration	<p>Enables Advanced Battery Charge Configuration from the beginning of the day to a specified work period. When enabled, Advanced Battery Charged maximizes battery health while still supporting heavy use during the work day.</p> <p>By default, the Enable Advanced Battery Charge Configuration option is disabled.</p>
Peak Shift	
Enable Peak Shift	<p>Enables the computer to run on battery during peak power usage hours.</p> <p>By default, the Enable Peak Shift option is disabled.</p>
USB PowerShare	
Enable USB PowerShare	<p>Enables or disables the USB PowerShare on the computer.</p> <p>By default, the Enable USB Powershare option is disabled.</p>
Thermal Management	<p>Enables or disables cooling of fan and manages processor heat to adjust the computer performance, noise, and temperature.</p> <p>By default, the Optimized option is selected. Standard setting for balanced performance, noise, and temperature.</p>
USB Wake Support	
Wake on Dell USB-C Dock	<p>When enabled, connecting a Dell USB-C Dock wakes the computer from Standby, Hibernate, and Power Off.</p> <p>By default, the Wake on Dell USB-C Dock option is enabled.</p>
Lid Switch	
Enable Lid Switch	<p>Enables or disables the Lid Switch.</p> <p>By default, the Enable Lid Switch option is enabled.</p>

Table 45. BIOS Setup options—Security menu

Security	
TPM 2.0 Security On	<p>Allows you to enable or disable TPM.</p> <p>By default, the TPM 2.0 Security On option is enabled.</p> <p>For additional security, Dell Technologies recommends keeping TPM 2.0 Security On enabled to allow these security technologies to fully function.</p>
Attestation Enable	<p>The Attestation Enable option controls the endorsement hierarchy of TPM. Disabling the Attestation Enable option prevents TPM from being used to digitally sign certificates.</p> <p>By default, the Attestation Enable option is enabled.</p> <p>For additional security, Dell Technologies recommends keeping the Attestation Enable option is enabled.</p> <p> NOTE: When disabled, this feature may cause compatibility issues or loss of functionality in some operating systems.</p>

Table 45. BIOS Setup options—Security menu (continued)



Security	
Key Storage Enable	<p>The Key Storage Enable option controls the storage hierarchy of TPM, which is used to store digital keys. Disabling the Key Storage Enable option restricts the ability of TPM to store owner's data.</p> <p>By default, the Key Storage Enable option is enabled.</p> <p>For additional security, Dell Technologies recommends keeping the Key Storage Enable option is enabled.</p> <p> NOTE: When disabled, this feature may cause compatibility issues or loss of functionality in some operating systems.</p>
Physical Presence Interface (PPI) Bypass for Clear Commands	<p>By default, the PPI Bypass for Clear Commands option is disabled.</p> <p>For additional security, Dell Technologies recommends keeping the PPI Bypass for Clear Commands option disabled.</p>
Chassis intrusion	
Chassis Intrusion	<p>The chassis intrusion detection enables a physical switch that triggers an event when the computer cover is opened.</p> <p>When set to Enabled, a notification is displayed on the next boot and the event is logged in the BIOS Events log.</p> <p>When set to On-Silent, the event is logged in the BIOS Events log, but no notification is displayed.</p> <p>When set to Disabled, no notification is displayed and no event is logged in the BIOS Events log.</p> <p>By default, the Chassis Intrusion Detection option is disabled.</p> <p>For additional security, Dell Technologies recommends keeping the Chassis Intrusion Detection option enabled.</p>
AMD Memory Guard	<p>Enables or disables memory encryption. AMD Memory Guard encrypts the contents of RAM to provide enhanced protection against unauthorized access. While enabling this feature may make detecting RAM errors more difficult during testing, it will not produce false errors. Enabling AMD Memory Guard may have a small performance impact on memory. This feature is only available on CPUs with AMD Pro technology.</p> <p>By default, the AMD Memory Guard option is disabled.</p>
Data Wipe on Next Boot	
Start Data Wipe	<p>Data Wipe is a secure wipe operation that deletes information from a storage device.</p> <p> CAUTION: The secure Data Wipe operation deletes information in a way that it cannot be reconstructed.</p> <p>Commands such as delete and format in the operating system may remove files from showing up in the file system. However, they can be reconstructed through forensic means as they are still represented on the physical media. Data Wipe prevents this reconstruction and the data can no longer be recovered.</p> <p>When enabled, the data wipe option provides prompts to wipe any storage devices that are connected to the computer on the next boot.</p> <p>By default, the Start Data Wipe option is disabled.</p>
HDD Security	
SED Block SID Authentication	<p>The SED Block SID Authentication setting prevents unauthorized access to Self-Encrypting Drives (SEDs) without passwords by using the BIOS. It also allows older SED management software to request temporary access when incompatible with the TCG Block SID interface.</p>

Table 45. BIOS Setup options—Security menu (continued)

Security	
	<p>When set to Enabled, the SED Block SID Authentication is enabled on the drive.</p> <p>When set to Disabled, the SED Block SID Authentication is disabled on the drive.</p>
PPI Bypass for SED Block SID Command	<p>The PPI Bypass for SED Block SID Command setting controls whether user approval is required for external software to unlock a Self-Encrypting Drive (SED).</p> <p>When set to Enabled, the drive can be left unlocked temporarily without user acknowledgment.</p> <p>When set to Disabled, user approval is needed for external software to manage the SED.</p>
Absolute	<p>Absolute Software provides various cyber security solutions, some requiring software preloaded on Dell computers and integrated into the BIOS. To use these features, you must enable the Absolute BIOS setting and contact Absolute for configuration and activation.</p> <p>By default, the Enable Absolute option is enabled.</p> <p>For additional security, Dell Technologies recommends keeping the Absolute option enabled.</p> <p> NOTE: When the Absolute features are activated, the Absolute integration cannot be disabled from the BIOS setup screen.</p>
UEFI Boot Path Security	<p>Enables or disables the computer to prompt the user to enter the Administrator password (if set) when booting to a UEFI boot path device from the F12 boot menu.</p> <p>By default, the Always Except Internal HDD option is enabled.</p>
Authenticated BIOS Interface	
Enable Authenticated BIOS Interface	<p>Allows the administrator to control access to BIOS configuration through an authenticated interface. When enabled, this option ensures that BIOS configuration changes are secured by authentication.</p> <p>By default, the Enable Authenticated BIOS Interface option is disabled.</p>
Legacy Manageability Interface Access	<p>Allows the administrator to control the access to BIOS configuration through the Legacy Manageability Interface option. When enabled, this prevents the BIOS Administrator password-based manageability tools from running, prevents some Dell software applications from reading configuration settings, and/or prevents changes to the BIOS configuration settings.</p> <p>When enabled, this option only supports the Authenticated BIOS Manageability Interface (ABI) for managing the BIOS configuration changes. To support this feature, ABI must be enabled and provisioned.</p> <p>When set to Enabled, the Legacy Manageability Interface can be used to read and change BIOS configuration settings.</p> <p>When set to Read-Only, BIOS configuration settings can be read, but cannot be changed through the Legacy Manageability Interface.</p> <p>When set to Disabled, the Legacy Manageability Interface is disabled. BIOS configuration reads and writes are blocked.</p>
Firmware Device Tamper Detection	<p>Allows you to control the firmware device tamper detection feature. This feature notifies the user when the firmware device is tampered. When enabled, a screen warning messages are displayed on the computer and a tamper detection event is logged in the BIOS Events log. The computer fails to reboot until the event is cleared.</p> <p>By default, the Firmware Device Tamper Detection option is set to silent.</p>

Table 45. BIOS Setup options—Security menu (continued)

Security	
	For additional security, Dell Technologies recommends keeping the Firmware Device Tamper Detection option enabled.
Clear Firmware Device Tamper Detection	<p>Allows you to clear the events that are logged when tampering of firmware device is detected.</p> <p>By default, the Clear Firmware Device Tamper Detection option is disabled.</p> <p> NOTE: To view this option, enable Advanced Setup mode as described in View Advanced Setup options.</p>

Table 46. BIOS Setup options—Passwords menu

Passwords	
Administrator Password	<p>The Administrator Password prevents unauthorized access to the BIOS Setup options. Once the administrator password is set, the BIOS setup options can only be modified after providing the correct password.</p> <p>The following rules and dependencies apply to the Administrator Password -</p> <ul style="list-style-type: none"> • The administrator password cannot be set if computer and/or internal storage passwords are previously set. • The administrator password can be used in place of the computer and/or internal storage passwords. • When set, the administrator password must be provided during a firmware update. • Clearing the administrator password also clears the computer password (if set). <p>Dell Technologies recommends using an administrator password to prevent unauthorized changes to BIOS setup options.</p>
System Password	<p>The System Password prevents the computer from booting to an operating system without entering the correct password.</p> <p>The following rules and dependencies apply when the System Password is used -</p> <ul style="list-style-type: none"> • The computer shuts down when idle for approximately 10 minutes at the computer password prompt. • The computer shuts down after three incorrect attempts to enter the computer password. • The computer shuts down when the Esc key is pressed at the System Password prompt. • The computer password is not prompted when the computer resumes from standby mode. <p>Dell Technologies recommends using the computer password in situations where it is likely that a computer may be lost or stolen.</p>
M.2 PCIe SSD-0	<p>The hard drive password can be set to prevent unauthorized access of the data stored on the solid-state drive. The computer prompts for the hard drive password during boot in order to unlock the drive. A password-secured hard drive stays locked even when removed from the computer or placed into another computer. It prevents an attacker from accessing data on the drive without authorization.</p> <p>The following rules and dependencies apply when the Hard Drive Password or M.2 PCIe SSD-0 Password option is used.</p> <ul style="list-style-type: none"> • The hard drive password option cannot be accessed when the hard drive is disabled in the BIOS Setup. • The computer shuts down when idle for approximately 10 minutes at the hard drive password prompt.

Table 46. BIOS Setup options—Passwords menu (continued)



Passwords	
	<ul style="list-style-type: none"> • The computer shuts down after three incorrect attempts to enter the hard drive password and treats the hard drive as not available. • The hard drive does not accept password unlock attempts after five incorrect attempts to enter the hard drive password from the BIOS Setup. The hard drive password must be reset for the new password unlock attempts. • The computer treats the hard drive as not available when the Esc key is pressed at the hard drive password prompt. • The hard drive password is not prompted when the computer resumes from standby mode. When the hard drive is unlocked by the user before the computer goes into standby mode, it remains unlocked after the computer resumes from standby mode. • If the system and hard drive passwords are set to the same value, the hard drive unlocks after the correct system password is entered. <p>Dell Technologies recommends using a hard drive password to protect unauthorized data access.</p>
Password Configuration	<p>The Password configuration page includes several options for changing the requirements of BIOS passwords. You can modify the minimum and maximum length of the passwords and require passwords to contain certain character classes (upper case, lower case, digit, special character).</p> <p>Dell Technologies recommends setting the minimum password length to at least eight characters.</p>
Password Changes	
Allow Non-Admin Password Changes	<p>The Allow Non-Admin Password Changes option in BIOS Setup allows an end user to set or change the system or hard drive passwords without entering the administrator password. This gives an administrator control over the BIOS settings but enables an end user to provide their own password.</p> <p>By default, the Allow Non-Admin Password Changes option is enabled.</p> <p>For additional security, Dell Technologies recommends keeping the Allow Non-Admin Password Changes option disabled.</p> <p> NOTE: To view this option, enable Advanced Setup mode as described in View Advanced Setup options.</p>
Admin Setup Lockout	<p>The Admin Setup Lockout option prevents an end user from even viewing the BIOS setup configuration without first entering the administrator password (if set).</p> <p>By default, the Admin Setup Lockout option is disabled.</p> <p>For additional security, Dell Technologies recommends keeping the Admin Setup Lockout option disabled.</p>
Master Password Lockout	
Enable Master Password Lockout	<p>The Master Password Lockout setting allows you to disable the Recovery Password feature. If the computer, administrator, or hard drive password is forgotten, the computer becomes unusable.</p> <p> NOTE: When the owner password is set, the Master Password Lockout option is not available.</p> <p> NOTE: When an internal hard drive password is set, it must first be cleared before Master Password Lockout can be changed.</p> <p>By default, the Enable Master Password Lockout option is disabled.</p> <p>Dell does not recommend enabling the Master Password Lockout unless you have implemented your own password recovery computer.</p>
Allow Non-Admin PSID Revert	

Table 46. BIOS Setup options—Passwords menu (continued)

Passwords	
Enable Allow Non-Admin PSID Revert	<p>The Allow Non-Admin PSID Revert option allows a user to clear the hard drive password without entering the BIOS Admin Password. When an Admin Password is set, the ability to enter the PSID is protected by requiring authentication with the Admin Password. If this option is enabled, any user can clear the drive without entering the Admin Password.</p> <p>By default, the Enable Allow Non-Admin PSID Revert option is disabled.</p> <p>NOTE: To view this option, enable Advanced Setup mode as described in View Advanced Setup options.</p>

Table 47. BIOS Setup options—Update, Recovery menu

Update, Recovery	
BIOS Recovery from Hard Drive	<p>Enables or disables the user to recover from certain corrupted BIOS conditions from a recovery file on the user primary hard drive or an external USB key.</p> <p>By default, the BIOS Recovery from Hard Drive option is enabled.</p> <p>NOTE: BIOS Recovery from Hard Drive is not available for self-encrypting drives (SED).</p> <p>NOTE: BIOS recovery is designed to fix the main BIOS block and cannot work if the Boot Block is damaged. In addition, this feature cannot work in the event of EC corruption, ME corruption, or a hardware issue. The recovery image must exist on an unencrypted partition on the drive.</p>
BIOS Downgrade	
Allow BIOS Downgrade	<p>Controls flashing of the computer firmware to previous revisions.</p> <p>By default, the Allow BIOS Downgrade option is enabled.</p>
SupportAssist OS Recovery	<p>Enables or disables the boot flow for SupportAssist OS Recovery tool in the event of certain computer errors.</p> <p>By default, the SupportAssist OS Recovery option is enabled.</p>
BIOSConnect	<p>Enables or disables cloud Service operating system recovery if the main operating system fails to boot with the number of failures equal to or greater than the value specified by the Auto OS Recovery Threshold setup option and local Service operating system does not boot or is not installed.</p> <p>By default, the BIOSConnect option is enabled.</p>
Dell Auto OS Recovery Threshold	<p>Allows you to control the automatic boot flow for SupportAssist System Resolution Console and for Dell OS Recovery Tool.</p> <p>By default, the Dell Auto OS Recovery Threshold value is set to 2.</p>

Table 48. BIOS Setup options—System Management menu

System Management	
Service Tag	Displays the Service Tag of the computer.
Asset Tag	<p>Creates a computer Asset Tag that can be used by an IT administrator to uniquely identify a particular computer.</p> <p>NOTE: Once set in BIOS, the Asset Tag cannot be changed.</p>
AC Behavior	
Wake on AC	<p>Enables or disables the computer to turn on and go to boot when AC power is supplied to the computer.</p> <p>By default, the Wake on AC option is disabled.</p>

Table 48. BIOS Setup options—System Management menu (continued)



System Management	
Wake on LAN	Enables or disables the computer to turn on by a special LAN signal. By default, the Wake on LAN option is disabled.
Auto On Time	Enable to set the computer to turn on automatically every day or on a preselected date and time. This option can be configured only if the Auto On Time is set to Everyday, Weekdays, or Selected Days. By default, the Auto On Time option is disabled.
First Power On Date	
Set Ownership Date	Sets the ownership date.
Diagnostics	
OS Agent Requests	Enable or disable the option for applications running in the operating system to run with preboot diagnostics on subsequent boots.  NOTE: To view this option, enable Advanced Setup mode as described in View Advanced Setup options .
Power-on-Self-Test Automatic Recovery	Enable or disable the automatic recovery of the computer from no power or no-POST failure by applying mitigation steps. By default, the Power-On-Self-Test Automatic Recovery option is enabled.  NOTE: To view this option, enable Advanced Setup mode as described in View Advanced Setup options .
DASH Support	Enables support for Desktop and Mobile Architecture for System Hardware (DASH) management via Platform Level Data Model (PLDM) exchanges.

Table 49. BIOS Setup options—Keyboard menu

Keyboard	
Fn Lock Options	Enables or disables the Fn Lock option. By default, the Fn Lock option is enabled.
Lock Mode	By default, the Lock Mode Secondary option is enabled. With this option, the F1-F12 keys scan the code for their secondary functions.
Keyboard Illumination	Configures the operating mode of the keyboard illumination feature. By default, the Dim option is selected. Enables the keyboard illumination feature at 100% brightness level.
Keyboard Backlight Timeout on AC	Sets the timeout value for the keyboard backlight when an AC adapter is connected to the computer. By default, the 10 seconds option is selected.
Keyboard Backlight Timeout on Battery	Sets the timeout value for the keyboard backlight when the computer is running only on the battery power. The keyboard backlight timeout value is only effective when the backlight is enabled. By default, the 10 seconds option is selected.

Table 50. BIOS Setup options—Pre-boot Behavior menu

Preboot Behavior	
Adapter Warnings	
Enable Adapter Warnings	Enables the adapter warnings messages during boot when the adapters with less power capacity are detected.

Table 50. BIOS Setup options—Pre-boot Behavior menu (continued)

Preboot Behavior	
	By default, the Enable Adapter Warnings option is enabled.
Warnings and Errors	Enables or disables the action to be taken when a warning or error is encountered. By default, the Prompt on Warnings and Errors option is selected. i NOTE: Errors deemed critical to the operation of the computer hardware stop the functioning of the computer.
Extend BIOS POST Time	Sets the BIOS POST (Power-On Self-Test) load time. By default, the 0 seconds option is selected.
MAC Address Pass-Through	Replaces the external NIC MAC address (in a supported dock or dongle) with the selected MAC address from the computer. By default, the System Unique MAC Address option is selected.
Sign of Life	
Early Keyboard Backlight	Keyboard Backlight Sign of Life. By default, the Early Keyboard Backlight option is enabled.

Table 51. BIOS Setup options—Virtualization menu

Virtualization	
DMA Protection	
Enable Pre-Boot DMA Support	Allows you to control the Pre-Boot DMA protection for both internal and external ports. This option does not directly enable DMA protection in the operating system. i NOTE: This option is not available when the virtualization setting for IOMMU is disabled (VT-d/AMD Vi). By default, the Enable Pre-Boot DMA Support option is enabled. For additional security, Dell Technologies recommends keeping the Enable Pre-Boot DMA Support option is enabled. i NOTE: This option is provided only for compatibility purposes, since some older hardware is not DMA capable.
Enable OS Kernel DMA Support	Allows you to control the Kernel DMA protection for both internal and external ports. This option does not directly enable DMA protection in the operating system. For operating systems that support DMA protection, this setting indicates to the operating system that the BIOS supports the feature. i NOTE: This option is not available when the virtualization setting for IOMMU is disabled (VT-d/AMD Vi). By default, the Enable OS Kernel DMA Support option is enabled. i NOTE: This option is provided only for compatibility purposes, since some older hardware is not DMA capable.
Internal Port DMA Compatibility Mode	Allows you to control the boot compatibility for integrated PCIe peripherals by disabling PCIe DMA protection on internal PCIe ports. When enabled, BIOS will notify the operating system that the internal ports are not DMA capable. This option is to help with devices that have operating system DMA compatibility issues. This option does not directly enable DMA protection in the operating system. i NOTE: This option is not available when the virtualization setting for IOMMU is disabled (VT-d/AMD Vi).

Table 51. BIOS Setup options—Virtualization menu (continued)

Virtualization	
	By default, the Internal Port DMA Compatibility Mode option is enabled.  NOTE: This option is provided only for compatibility purposes, since some older hardware is not DMA capable.

Table 52. BIOS Setup options—Performance menu

Performance	
AMD Simultaneous Multithreading	
Enable AMD Simultaneous Multithreading	Enables or disables the AMD Simultaneous Multithreading mode of the processor. When enabled, the AMD Simultaneous Multithreading increases the efficiency of the processor resources when multiple threads run on each core. By default, the Enable AMD Simultaneous Multithreading option is enabled.  NOTE: To view this option, enable Advanced Setup mode as described in View Advanced Setup options .
NUMA Nodes Per Socket	Controls how system memory is distributed among processor cores. By default, the Auto option is selected.

Table 53. BIOS Setup options—System Logs menu

System Logs	
BIOS Event Log	
Clear BIOS Event Log	Allows you to select option to keep or clear BIOS events logs. By default, the Keep Log option is selected.
Thermal Event Log	
Clear Thermal Event Log	Allows you to select option to keep or clear thermal events logs. By default, the Keep Log option is selected.
Power Event Log	
Clear Power Event Log	Allows you to select option to keep or clear power events logs. By default, the Keep Log option is selected.

Updating the BIOS

Updating the BIOS in Windows

About this task

 **CAUTION:** If BitLocker is not suspended before updating the BIOS, the BitLocker key is not recognized the next time you reboot the computer. You will then be prompted to enter the recovery key to proceed, and the computer displays a prompt for the recovery key on each reboot. Failure to provide the recovery key can result in data loss or an operating system reinstall. For more information, refer [Updating the BIOS on Dell systems with BitLocker enabled](#).

 **CAUTION:** Do not turn off the computer during the BIOS flash update process. The computer may not boot if you turn off your computer.

Steps

1. Go to [Dell Support Site](#).
2. Go to **Identify your product or ask support**. In the box, enter the product identifier, model, service request or describe what you are looking for, and then click **Search**.
 - NOTE:** If you do not have the Service Tag, click **Detect This PC**. The site automatically detects your device, and you can then click **Explore Product Support** to go to the support page for your device. You can also use the product ID or manually browse for your computer model.
3. Click **Drivers & Downloads**.
4. Select the operating system installed on your computer.
5. In the **Category** drop-down list, select **BIOS**.
6. Select the latest version of BIOS, and click **Download** to download the BIOS file for your computer.
7. After the download is complete, navigate to the folder where the BIOS update file has been saved.
8. Double-click the BIOS update file and follow the on-screen instructions.
For more information, search [Dell Support Site](#).

Updating the BIOS in Linux and Ubuntu

To update the system BIOS on a computer that is installed with Linux or Ubuntu, see [How to Update the Dell BIOS in the Ubuntu or Linux Environment](#) at [Dell Support Site](#).

Updating the BIOS using the USB drive in Windows

About this task

- CAUTION:** If BitLocker is not suspended before updating the BIOS, the BitLocker key is not recognized the next time you reboot the computer. You will then be prompted to enter the recovery key to proceed, and the computer displays a prompt for the recovery key on each reboot. Failure to provide the recovery key can result in data loss or an operating system reinstall. For more information, refer [Updating the BIOS on Dell systems with BitLocker enabled](#).
- CAUTION:** Do not turn off the computer during the BIOS flash update process. The computer may not boot if you turn off your computer.

Steps

1. Go to [Dell Support Site](#).
2. Go to **Identify your product or ask support**. In the box, enter the product identifier, model, service request or describe what you are looking for, and then click **Search**.
 - NOTE:** If you do not have the Service Tag, click **Detect This PC**. The site automatically detects your device, and you can then click **Explore Product Support** to go to the support page for your device. You can also use the product ID or manually browse for your computer model.
3. Click **Drivers & Downloads**.
4. Select the operating system installed on your computer.
5. In the **Category** drop-down list, select **BIOS**.
6. Select the latest version of BIOS, and click **Download** to download the BIOS file for your computer.
7. Create a bootable USB drive. For more information, search [Dell Support Site](#).
8. Copy the BIOS setup program file to the bootable USB drive.
9. Connect the bootable USB drive to the computer that needs the BIOS update.
10. Restart the computer and press **F12**.
11. Select the USB drive from the **One Time Boot Menu**.
12. Type the BIOS setup program filename and press **Enter**.
The **BIOS Update Utility** appears.

13. Follow the on-screen instructions to complete the BIOS update.

Updating the BIOS from the One-Time boot menu

To update the BIOS from the One-Time boot menu, see [Updating the BIOS from the One Time Boot Menu](#) at [Dell Support Site](#).

System and setup password

 **CAUTION:** The password features provide a basic level of security for the data on your computer.



 **CAUTION:** Ensure that your computer is locked when it is not in use. Anyone can access the data that is stored on your computer, when left unattended.

Table 54. System and setup password

Password type	Description
System password	Password that you must enter to boot to your operating system.
Setup password	Password that you must enter to access and change the BIOS settings of your computer.

You can create a system password and a setup password to secure your computer.

 **NOTE:** The System and setup password feature is disabled by default.

Assigning a System Setup password

Prerequisites

You can assign a new System or Admin Password only when the status is set to **Not Set**. To enter BIOS System Setup, press F2 immediately after a power-on or reboot.

Steps

1. To enter the **System Setup**, press **F2** immediately after a power-on or reboot.
2. In the **System BIOS** or **System Setup** screen, select **Security** and press Enter. The **Security** screen is displayed.
3. Select **System/Admin Password** and create a password in the **Enter the new password** field. Use the following guidelines to create the system password:
 - Password can be up to 32 characters.
 - Password must contain at least one special character: "(! " # \$ % & ' * + , - . / : ; < = > ? @ [\] ^ _ ` { | })"
 - The password can contain numbers from 0 to 9.
 - The password can contain alphabets A to Z and a to z.
4. Type the system password that you entered earlier in the **Confirm new password** field and click **OK**.
5. Press Y to save the changes. The computer restarts.

Deleting or changing an existing system password or setup password

Prerequisites

Ensure that the **Password Status** is Unlocked in the System Setup before attempting to delete or change the existing system password and/or setup password. You cannot delete or change an existing system password or setup password if the **Password Status** is Locked. To enter the System Setup, press F2 immediately after a power-on or reboot.

Steps

1. To enter the **System Setup**, press **F2** immediately after a power-on or reboot.
2. In the **System BIOS** or **System Setup** screen, select **System Security** and press Enter. The **System Security** screen is displayed.
3. In the **System Security** screen, verify that the **Password Status** is Unlocked.
4. Select **System Password**. Update or delete the existing system password, and press Enter or Tab.
5. Select **Setup Password**. Update or delete the existing setup password, and press Enter or Tab.
 **NOTE:** If you change the system password and/or setup password, reenter the new password when prompted. If you delete the system password and/or setup password, confirm the deletion when prompted.
6. Press Esc. A message prompts you to save the changes.
7. Press Y to save the changes and exit from **System Setup**. The computer restarts.

Clearing system and setup passwords

About this task

To clear the system or setup passwords, contact Dell technical support as described at [Contact Support](#).

-  **NOTE:** For information about how to reset Windows or application passwords, see the documentation accompanying Windows or your application.

Troubleshooting

Handling swollen rechargeable Li-ion batteries

Like most laptops, Dell laptops use Lithium-ion batteries. One type of Lithium-ion battery is the rechargeable Li-ion battery. Rechargeable Li-ion batteries have increased in popularity in recent years and have become a standard in the electronics industry due to customer preferences for a slim form factor (especially with newer ultra-thin laptops) and long battery life. Inherent to rechargeable Li-ion battery technology is the potential for swelling of the battery cells.

A swollen battery may impact the performance of the laptop. To prevent possible further damage to the device enclosure or internal components leading to malfunction, discontinue the use of the laptop and discharge it by disconnecting the AC adapter and letting the battery drain.

Swollen batteries should not be used and must be replaced and disposed of properly. We recommend contacting Dell Support for options to replace a swollen battery under the terms of the applicable warranty or service contract, including options for replacement by a Dell authorized service technician.

The guidelines for handling and replacing rechargeable Li-ion batteries are as follows:

- Exercise caution when handling rechargeable Li-ion batteries.
- Discharge the battery before removing it from the laptop. To discharge the battery, unplug the AC adapter from the computer and operate the computer only on battery power. The battery is fully discharged when the computer no longer turns on when the power button is pressed.
- Do not crush, drop, mutilate, or penetrate the battery with foreign objects.
- Do not expose the battery to high temperatures, or disassemble battery packs and cells.
- Do not apply pressure to the surface of the battery.
- Do not bend the battery.
- Do not use tools of any type to pry on or against the battery.
- If a battery gets stuck in a device as a result of swelling, do not try to free it as puncturing, bending, or crushing a battery can be dangerous.
- Do not attempt to reassemble a damaged or swollen battery into a laptop.
- Swollen batteries that are covered under warranty should be returned to Dell in an approved shipping container (provided by Dell)—this is to comply with transportation regulations. Swollen batteries that are not covered under warranty should be disposed of at an approved recycling center. Contact Dell Support at [Dell Support Site](#) for assistance and further instructions.
- Using a non-Dell or incompatible battery may increase the risk of fire or explosion. Replace the battery only with a compatible battery purchased from Dell that is designed to work with your Dell computer. Do not use a battery from other computers with your computer. Always purchase genuine batteries from [Dell Site](#) or otherwise directly from Dell.

Rechargeable Li-ion batteries can swell for various reasons such as age, number of charge cycles, or exposure to high heat. For more information about how to improve the performance and lifespan of the laptop battery and to minimize the possibility of occurrence of the issue, search Dell laptop battery at [Dell Support Site](#).

Dell SupportAssist Pre-boot System Performance Check diagnostics

About this task

SupportAssist diagnostics (also known as system diagnostics) performs a complete check of your hardware. The Dell SupportAssist Pre-boot System Performance Check diagnostics is embedded within the BIOS and launched by the BIOS internally. The embedded system diagnostics provides options for particular devices or device groups allowing you to:

- Run tests automatically or in an interactive mode.
- Repeat the tests.
- Display or save test results.
- Run thorough tests to add more options and obtain details about any failed devices.

- View status messages that inform you when the tests are completed successfully.
- View error messages that inform you of problems encountered during testing.

NOTE: Some tests for specific devices require user interaction. Always ensure that you are present at the computer when the diagnostic tests are performed.

For more information, see [How to Run Dell Preboot Diagnostics and Hardware Tests on Your Dell Computer](#).

Running the SupportAssist Pre-Boot System Performance Check

Steps

1. Turn on your computer.
2. As the computer boots, press the F12 key.
3. On the boot menu screen, select **Diagnostics**.
The diagnostic quick test begins.
NOTE: For more information about running the SupportAssist Pre-Boot System Performance Check on a specific device, see [Dell Support Site](#).
4. If there are any issues, error codes are displayed.
Note the error code and validation number and contact Dell.

Built-in self-test (BIST)

Motherboard Built-In Self-Test (M-BIST)

M-BIST is the system board built-in self-test diagnostics tool that improves the diagnostics accuracy of system board Embedded Controller (EC) failures.

NOTE: M-BIST can be manually initiated before Power On Self-Test (POST).

How to run M-BIST

NOTE: Before initiating M-BIST, ensure that the computer is in a power-off state.

1. Press and hold both the **M** key and the power button to initiate M-BIST.
2. The battery-charge status light may exhibit two states:
 - Off: No fault was detected.
 - Amber and White: Indicates a problem with the system board.
3. If there is a failure with the system board, the battery status LED flashes one of the following error codes for 30 seconds:

Table 55. LED error codes

Blinking Pattern		Possible Problem
Amber	White	
2	1	CPU Failure
1	1	TPM Detection Failure
2	4	Memory/RAM failure

4. If there is no failure with the system board, the LCD cycles through the solid color screens (that are described in the LCD-BIST) for 30 seconds and then turn off.

Logical Built-in Self-test (L-BIST)

L-BIST is an enhancement to the single LED error code diagnostics and is automatically initiated during POST. L-BIST will check the LCD power rail. If there is no power being supplied to the LCD (that is if the L-BIST circuit fails), the battery status LED flashes either an error code [2,7].

NOTE: If L-BIST fails, LCD-BIST cannot function as no power will be supplied to the LCD.

How to invoke the L-BIST

1. Turn on your computer.
2. If the computer does not start up normally, look at the battery status LED:
 - If the battery status LED flashes an error code [2,7], the display cable may not be connected properly.
3. For cases, when a [2,7] error code is shown, check to see if the display cable is properly connected.

LCD Built-in Self-Test (LCD-BIST)

Dell laptops have a built-in diagnostic tool that helps you determine if the screen abnormality you are experiencing is an inherent problem with the LCD (screen) of the Dell laptop or with the video card (GPU) and computer settings.

When you notice screen abnormalities like flickering, distortion, clarity issues, fuzzy or blurry image, horizontal or vertical lines, color fade, it is always a good practice to isolate the LCD (screen) by running the LCD-BIST.

How to invoke the LCD-BIST

1. Turn off your computer.
2. Disconnect any peripherals that are connected to the computer. Connect only the AC adapter (charger) to the computer.
3. Ensure that the LCD (screen) is clean (no dust particles on the surface of the screen).
4. Press and hold the **D** key and press the power button to enter LCD-BIST mode. Continue to hold the **D** key until the computer boots up.
5. The screen displays solid colors and changes colors on the entire screen to white, black, red, green, and blue twice.
6. Then it displays the colors white, black, and red.
7. Carefully inspect the screen for abnormalities (any lines, fuzzy color, or distortion on the screen).
8. At the end of the last solid color (red), the computer shuts down.

NOTE: Dell SupportAssist Preboot diagnostics upon launch initiates an LCD-BIST first, expecting a user intervention to confirm functionality of the LCD.

System-diagnostic lights

This section lists the system-diagnostic lights of your Dell Pro 14 Plus/Dell Pro 14 Plus 2-in-1.

The following table shows different Service LED blinking patterns and associated problems. The diagnostic light codes consist of a two-digit number, and the digits are separated by a comma. The number stands for a blinking pattern; the first digit shows the number of blinks in amber color, and the second digit shows the number of blinks in white color. The Service LED blinks in the following manner:

- The Service LED blinks the number of times equal to the value of the first digit and turns off with a short pause.
- After that, the Service LED blinks the number of times equal to the value of the second digit.
- The Service LED turns off again with a longer pause.
- After the second pause, the blinking pattern will be repeated.

Table 56. Diagnostic light codes

Diagnostic light codes (Amber, White)	Problem description	Recommended solutions
1,1	TPM Detection Failure	Replace the system board.
1,2	Unrecoverable SPI Flash Failure	Replace the system board.

Table 56. Diagnostic light codes (continued)

Diagnostic light codes (Amber, White)	Problem description	Recommended solutions
1,4	Hinge Cable OCP	Replace LCM (cable and Panel)
1,5	EC unable to program i-Fuse	Replace the system board.
1,6	Generic catch-all for ungraceful EC code flow errors	Disconnect all power source (AC, coin cell) and drain flea power by pressing and holding down the power button.
1,7	Non-RPMC Flash on Boot Guard fused system	Flash latest BIOS version. If the problem persists, replace the system board.
1,8	Chipset "Catastrophic Error" signal has tripped	Replace the CPU.
2,1	CPU configuration or CPU failure	Replace the CPU.
2,2	System board: BIOS or Read-Only Memory (ROM) failure	Flash latest BIOS version. If the problem persists, replace the system board.
2,3	No memory, or Random-Access Memory (RAM) detected	Replace the system board.
2,4	Memory, or Random-Access Memory (RAM) failure	Replace the system board.
2,5	Invalid memory module	Replace the system board.
2,6	System board/Chipset Error	Replace the system board.
2,7	LCD failure SBIOS message	Replace the display.
3,1	RTC power failure	Perform the RTC reset. If the problem persists, replace the battery.
3,2	PCI of Video card/chip failure	Replace the system board.
3,3	Recovery image not found	Replace the system board.
3,4	Recovery image found but invalid	Replace the system board.
3,5	EC power-rail error	Replace the system board.
3,6	Flash corruption detected by SBIOS	Flash corruption is detected by SBIOS. If the problem persists, replace the system board.
3,7	Timeout waiting on ME to reply to HECI message	Replace the system board.
4,1	Memory DIMM power rail failure	Replace the system board.
4,2	CPU Power cable connection issue	<ul style="list-style-type: none"> • Perform the PSU BIST Test, reseal the cable. • If this does not work, replace the system board, power supply or cabling.
4,4	LCD Power Rail Failure	Replace motherboard

Recovering the operating system

When your computer is unable to boot to the operating system even after repeated attempts, it automatically starts Dell SupportAssist OS Recovery.

Dell SupportAssist OS Recovery is a stand-alone tool that is preinstalled on Dell computers running the Windows operating system. It consists of tools to diagnose and troubleshoot issues that may occur before your computer boots to the operating system. It enables you to diagnose hardware issues, repair your computer, back up your files, and restore your computer to its factory state.

You can also download it from the Dell Support website to troubleshoot and fix your computer when it fails to boot into the primary operating system due to software or hardware failures.

For more information about the Dell SupportAssist OS Recovery, see *Dell SupportAssist OS Recovery User's Guide* at [Serviceability Tools at the Dell Support Site](#). Click **SupportAssist** and then click **SupportAssist OS Recovery**.

 **NOTE:** Windows 11 IoT Enterprise LTSC 2024 and Dell ThinOS 10 do not support Dell SupportAssist. For more information about recovering ThinOS 10, see [Recovery mode using R-Key](#).

Real-Time Clock (RTC Reset)

The Real-Time Clock (RTC) reset function enables you or the service technician to recover Dell computers from No POST/No Power/No Boot situations.

Start the RTC reset with the computer powered off and connected to AC power. Press and hold the power button for thirty seconds. The computer RTC Reset occurs after you release the power button.

Backup media and recovery options

It is recommended to create a recovery drive to troubleshoot and fix problems that may occur with Windows. Dell provides multiple options for recovering the Windows operating system on your Dell computer. For more information, see [Dell Windows Backup Media and Recovery Options](#).

Network power cycle

About this task

If your computer is unable to access the Internet due to network connectivity issues, reset your network devices by performing the following steps:

Steps

1. Turn off the computer.
2. Turn off the modem.
 **NOTE:** Some Internet service providers (ISPs) provide a modem and router combo device.
3. Turn off the wireless router.
4. Wait for 30 seconds.
5. Turn on the wireless router.
6. Turn on the modem.
7. Turn on the computer.

Drain flea power (perform hard reset)

About this task

Flea power is the residual static electricity that remains in the computer even after it has been powered off and the battery is removed.

For your safety, and to protect the sensitive electronic components in your computer, you must drain residual flea power before removing or replacing any components in your computer.

Draining flea power, also known as performing a "hard reset," is also a common troubleshooting step if your computer does not turn on or boot into the operating system.

Perform the following steps to drain the flea power:

Steps

1. Turn off the computer.
2. Disconnect the power adapter from the computer.
3. Remove the base cover.
4. Remove the battery.

 **CAUTION:** The battery is a Field Replaceable Unit (FRU) and the removal and installation procedures are intended for authorized service technicians only.

5. Press and hold the power button for 20 seconds to drain the flea power.
6. Install the battery.
7. Install the base cover.
8. Connect the power adapter to the computer.
9. Turn on the computer.

 **NOTE:** For more information about performing a hard reset, go to [Dell Support Site](#). On the menu bar at the top of the Support page, select Support > Support Library. In the Search field on the Support Library page, type the keyword, topic, or model number, and then click or tap the search icon to view the related articles.

LAN connectivity issue with Dell Pro Smart Docks and Thunderbolt Docks

Issue Overview: When your computer is connected to a Dell Pro Smart Dock or Thunderbolt Dock, and the RJ45 ethernet cable is connected through the ethernet port on the dock, you may not receive LAN connectivity to your computer.

Table 57. Possible issues and solutions:

Possible issue	Solution
The external USB ports on your computer are disabled.	Go to the BIOS Setup menu > Integrated Devices > USB Configuration . Ensure that the Enable External USB Ports option is enabled.
Your computer is installed with software that restricts USB access. Some organizations may require enterprise users to install software that restricts access to USB ports on the computer, hence affecting the functionality of the computer.	If the dock does not provide LAN connectivity, connect the RJ45 ethernet cable to the ethernet port on your computer to restore LAN access.  NOTE: If your laptop does not have an RJ45 ethernet port, connect to a wireless network.

Getting help and contacting Dell

Self-help resources

You can get information and help on Dell products and services using these self-help resources:

Table 58. Self-help resources

Self-help resources	Resource location
Information about Dell products and services	Dell Site
Contact Support	In Windows search, type <code>Contact Support</code> , and press Enter.
Online help for operating system	Windows Support Site Linux Support Site
Access top solutions, diagnostics, drivers and downloads, and learn more about your computer through videos, manuals, and documents.	Your Dell computer is uniquely identified using a Service Tag or Express Service Code. To view relevant support resources for your Dell computer, enter the Service Tag or Express Service Code at Dell Support Site . For more information about how to find the Service Tag for your computer, see Locate the Service Tag on your computer .
Dell knowledge base articles	<ol style="list-style-type: none"> 1. Go to Dell Support Site. 2. On the menu bar at the top of the Support page, select Support > Support Library. 3. In the Search field on the Support Library page, type the keyword, topic, or model number, and then click or tap the search icon to view the related articles.

Contacting Dell

To contact Dell for sales, technical support, or customer service issues, see [Dell Support Site](#).

 **NOTE:** Availability of the services may vary depending on the country or region, and product.

 **NOTE:** If you do not have an active Internet connection, you can find contact information in your purchase invoice, packing slip, bill, or Dell product catalog.

Revision history

Tracks all updates that are made to the document. It typically includes the date of change, version number, and a brief description of the modification. This log helps maintain transparency, accountability, and a clear timeline of progress.

Table 59. Revision history

Revision	Date	Description
A06	March 2026	<ul style="list-style-type: none"> Added Quebec requirement information. Added note that the wireless module is integrated on the system board in the wireless module specifications.
A05	December 2025	<ul style="list-style-type: none"> Updated dimensions and weight topic header. Updated system diagnostic lights. Updated display specifications. Added Microsoft UEFI CA to the system setup options. Updated top view topic image to include NFC callout.
A04	September 2025	<ul style="list-style-type: none"> Updated External Ports and Slots specifications topic and Left view topic with thunderbolt 4.0 information. Updated Power Adapter requirements topic. Updated display specifications topic.
A03	August 2025	<ul style="list-style-type: none"> Updated e-privacy panel specifications in the Display specifications topic and Dimensions and Weight specifications topic. Updated Battery specifications.
A02	July 2025	<ul style="list-style-type: none"> Updated Display specifications. Added e-privacy option specifications to Display specifications topic and Keyboard functions topic. Updated Processor specifications.
A01	May 2025	Added troubleshooting topic for LAN connectivity with Dell Pro Smart Docks and Thunderbolt Docks.
A00	March 2025	Original publish date