

# Dell Pro 14

PC14250

Owner's Manual

## Notes, cautions, and warnings

 **NOTE:** A NOTE indicates important information that helps you make better use of your product.

 **CAUTION:** A CAUTION indicates either potential damage to hardware or loss of data and tells you how to avoid the problem.

 **WARNING:** A WARNING indicates a potential for property damage, personal injury, or death.

<b>Chapter 1: Views of Dell Pro 14 PC14250.....</b>	<b>8</b>
Right.....	8
Left.....	8
Top.....	10
Front.....	11
Bottom.....	12
Locate the Service Tag or Express Service Code label of your computer.....	12
Battery-charge status light.....	13
<b>Chapter 2: Set up your Dell Pro 14 PC14250 .....</b>	<b>14</b>
<b>Chapter 3: Specifications of Dell Pro 14 PC14250.....</b>	<b>16</b>
Dimensions and weight.....	16
Processor.....	16
Chipset.....	19
Operating system.....	20
Memory.....	20
External ports and slots.....	20
Internal slots.....	21
Ethernet.....	21
Wireless module.....	22
Audio.....	22
Storage.....	23
Keyboard.....	23
Keyboard shortcuts of Dell Pro 14 PC14250.....	24
Camera.....	26
Touchpad.....	26
Power adapter.....	27
Power adapter requirements (for computers that are shipped with a 3-cell, 45 Wh battery).....	27
Power adapter requirements (for computers that are shipped with a 3-cell, 55 Wh battery).....	28
Battery.....	29
Power requirements (for computers that are shipped with a 3-cell, 45 Wh battery) .....	30
Power requirements (for computers that are shipped with a 3-cell, 55 Wh battery) .....	30
Display.....	31
Fingerprint reader (optional).....	32
Sensors .....	32
GPU—Integrated.....	33
Multiple display support matrix.....	33
Hardware security.....	33
Smart card reader.....	34
Contacted smart card reader.....	34
Operating and storage environment.....	35
Dell Optimizer.....	35
Dell support policy.....	35

Dell low blue light display.....	35
<b>Chapter 4: Working inside your computer.....</b>	<b>37</b>
Safety instructions.....	37
Before working inside your computer.....	37
Safety precautions.....	38
Electrostatic discharge—ESD protection.....	38
ESD Field Service kit .....	39
Transporting sensitive components.....	40
After working inside your computer.....	40
Information on reparability for Québec - From Dell Canada Inc. - to Quebec consumers.....	40
BitLocker.....	40
Recommended tools.....	41
Screw list.....	41
Major components of Dell Pro 14 PC14250.....	42
Customer Replaceable Units (CRUs) and Field Replaceable Units (FRUs) list.....	44
<b>Chapter 5: Removing and installing Customer Replaceable Units (CRUs).....</b>	<b>46</b>
Base cover.....	46
Removing the base cover.....	46
Installing the base cover.....	49
Battery.....	51
Rechargeable Li-ion battery precautions.....	51
Removing the battery.....	52
Installing the battery.....	53
Battery cable.....	55
Removing the battery cable.....	55
Installing the battery cable.....	55
Memory module.....	56
Removing the memory module.....	56
Installing the memory module.....	57
Solid state drive (SSD).....	58
Removing the solid state drive (SSD).....	58
Installing the solid state drive (SSD).....	59
Wireless Local Area Network (WLAN) card.....	60
Removing the wireless card.....	60
Installing the wireless card.....	61
Speakers.....	63
Removing the speakers.....	63
Installing the speakers.....	64
Removing the speakers (For computers shipped with smart card reader).....	65
Installing the speakers (For computers shipped with smart card reader).....	66
Fan.....	68
Removing the fan.....	68
Installing the fan.....	68
<b>Chapter 6: Removing and installing Field Replaceable Units (FRUs).....</b>	<b>70</b>
USH board FPC.....	70
Removing the USH board FPC (For computers shipped with smart card reader).....	70

Installing the USH board FPC (For computers shipped with smart card reader).....	71
USH board.....	72
Removing the USH board (For computers shipped with smart card reader).....	72
Installing the USH board (For computers shipped with smart card reader).....	73
Smart-card reader.....	74
Removing the smart card reader (For computers shipped with smart card reader).....	74
Installing the smart card reader (For computers shipped with smart card reader).....	75
Power-adapter port.....	77
Removing the power-adapter port.....	77
Installing the power-adapter port.....	77
Heat sink.....	78
Removing the heat sink.....	78
Installing the heat sink.....	79
vPro cable.....	80
Removing the vPro cable (For computers shipped with Intel Core Ultra 200U Series) .....	80
Installing the vPro cable (For computers shipped with Intel Core Ultra 200U Series).....	81
Removing the vPro cable (For computers shipped with Smart card reader) .....	82
Installing the vPro cable (For computers shipped with Smart card reader).....	83
I/O board.....	84
Removing the I/O board (For computers shipped with Intel Core Series).....	84
Installing the I/O board (For computers shipped with Intel Core Series).....	85
Removing the I/O board (For computers shipped with Intel Core Ultra 200U Series).....	86
Installing the I/O board (For computers shipped with Intel Core Ultra 200U Series).....	87
I/O-board FPC.....	88
Removing the I/O-board FPC.....	88
Installing the I/O-board FPC.....	89
Power button with fingerprint reader.....	90
Removing the power button with a fingerprint reader.....	90
Installing the power button with a fingerprint reader.....	91
System board.....	92
Removing the system board (For computers shipped with Intel Core Series).....	92
Installing the system board (For computers shipped with Intel Core Series).....	95
Removing the system board (For computers shipped with Intel Core Ultra 200U Series).....	99
Installing the system board (For computers shipped with Intel Core Ultra 200U Series).....	101
Removing the system board (For computers shipped with smart card reader).....	105
Installing the system board (For computers shipped with smart card reader).....	107
USB Type-C module.....	111
Removing the USB Type-C module.....	111
Installing the USB Type-C module.....	112
Removing the USB Type-C module (For computers shipped with smart card reader).....	113
Installing the USB Type-C module (For computers shipped with smart card reader).....	114
Keyboard.....	115
Removing the keyboard.....	115
Installing the keyboard.....	118
Removing the keyboard (For computers shipped with smart card reader).....	121
Installing the keyboard (For computers shipped with smart card reader).....	124
Keyboard support plate.....	127
Removing the keyboard support plate.....	127
Installing the keyboard support plate.....	129
Palm-rest assembly.....	130

Removing the palm-rest assembly.....	130
Installing the palm-rest assembly .....	132
Removing the palm-rest assembly (For computers shipped with smart card reader).....	134
Installing the palm-rest assembly (For computers shipped with smart card reader) .....	135
Display assembly.....	137
Removing the display assembly.....	137
Installing the display assembly.....	140
Display bezel.....	141
Removing the display bezel.....	141
Installing the display bezel.....	146
Display-panel assembly.....	148
Removing the display-panel assembly.....	148
Installing the display-panel assembly.....	153
Camera.....	157
Removing the camera.....	157
Installing the camera.....	158
eDP cable.....	159
Removing the eDP cable.....	159
Installing the eDP cable.....	160
Display back-cover assembly.....	161
Removing the display back-cover assembly.....	161
Installing the display back-cover assembly.....	162
<b>Chapter 7: Software.....</b>	<b>164</b>
Operating system.....	164
Drivers and downloads.....	164
<b>Chapter 8: BIOS Setup.....</b>	<b>165</b>
Entering BIOS Setup program.....	165
Navigation keys.....	165
F12 One Time Boot menu.....	165
View Advanced Setup options.....	166
View Service options.....	166
BIOS Setup options.....	166
Updating the BIOS.....	182
Updating the BIOS in Windows.....	182
Updating the BIOS in Linux and Ubuntu.....	183
Updating the BIOS using the USB drive in Windows.....	183
Updating the BIOS from the One-Time boot menu.....	183
System and setup password.....	183
Assigning a System Setup password.....	184
Deleting or changing an existing system password or setup password.....	184
Clearing system and setup passwords.....	185
<b>Chapter 9: Troubleshooting.....</b>	<b>186</b>
Handling swollen rechargeable Li-ion batteries.....	186
Dell SupportAssist Pre-boot System Performance Check diagnostics.....	186
Running the SupportAssist Pre-Boot System Performance Check.....	187
Built-in self-test (BIST).....	187

Motherboard Built-In Self-Test (M-BIST).....	187
Logic Built-in Self-test (L-BIST).....	188
LCD Built-in Self-Test (LCD-BIST).....	188
System-diagnostic lights.....	188
Recovering the operating system.....	189
Real-Time Clock (RTC Reset).....	190
Backup media and recovery options.....	190
Network power cycle.....	190
Drain flea power (perform hard reset).....	190
<b>Chapter 10: Getting help and contacting Dell.....</b>	<b>192</b>
<b>Chapter 11: Revision history.....</b>	<b>193</b>

# Views of Dell Pro 14 PC14250

## Right



Figure 1. Right View

### 1. USB 3.2 Gen 1 port

Connect devices such as external storage devices and printers. It provides data transfer speeds up to 5 Gbps.

### 2. USB 3.2 Gen 1 port with PowerShare

Connect devices such as external storage devices and printers.

Supports data transfer speeds up to 5 Gbps. PowerShare enables you to charge your USB devices even when your computer is turned off.

**NOTE:** If your computer is turned off or in a hibernate state, you must connect the power adapter to charge your devices using the PowerShare port. You must enable this feature in the BIOS setup program.

**NOTE:** Certain USB devices may not charge when the computer is turned off or in a sleep state. In such cases, turn on the computer to charge the device.

### 3. RJ45 ethernet port (1 Gbps)

Connect an RJ45 ethernet cable from a router or a broadband modem for network or Internet access, with a transfer rate of 10/100/1000 Mbps (maximum 1 Gbps).

### 4. Ethernet status LED

Indicates the connectivity status and network activity.

### 5. Security-cable slot

Attach a security cable to prevent unauthorized movement of your computer.

## Left

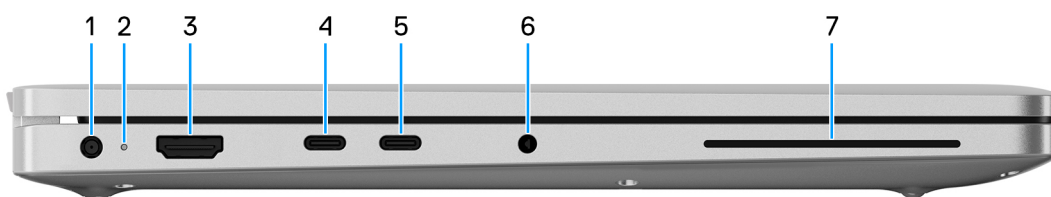

Figure 2. Left view

### 1. Power-adaptor port

Connect a power adapter to provide power to your computer.

## 2. **Battery-status light**

Indicates the battery-charge status.

Solid white—Battery is charging.

Solid amber—Battery charge is low.

Off—Battery is fully charged.

## 3. **HDMI 2.1 Transition-minimized differential signaling (TMDS) port**

Connect to a TV, external display, or another HDMI-in enabled device. Supports video and audio output.

## 4. **Thunderbolt 4.0 port with DisplayPort 2.1 and Power Delivery 3.1**

Supports USB4, DisplayPort 2.1, Thunderbolt 4 and also enables you to connect to an external display using a display adapter. Provides data transfer rates of up to 40 Gbps for USB4 and Thunderbolt 4.

 **NOTE:** You can connect a Dell Docking Station to the Thunderbolt 4 ports. For more information, search in the Knowledge Base Resource at [Dell Support Site](#).

 **NOTE:** A USB Type-C to DisplayPort adapter (sold separately) is required to connect a DisplayPort device.

 **NOTE:** USB4 is backward compatible with USB 3.2, USB 2.0, and Thunderbolt 3.

 **NOTE:** Thunderbolt 4 supports two 4K displays or one 8K display.

## 5. **USB 3.2 Gen 2 Type-C port with DisplayPort 2.0 and Power Delivery 3.1**

Connect devices such as external storage devices, printers, and external displays. Supports data transfer rate of up to 10 Gbps.

Supports Power Delivery that enables two-way power supply between devices. Supports up to 15 W power output that enables faster charging.

Supports DisplayPort 2.0 and also enables you to connect an external display using a display adapter.

 **NOTE:** A USB Type-C to DisplayPort adapter (sold separately) is required to connect a DisplayPort device.

## 6. **Global headset port**

Connect headphones or a headset (headphone and microphone combo).

## 7. **Smart card reader (optional)**

Using smart card provides authentication in corporate networks.

# Top

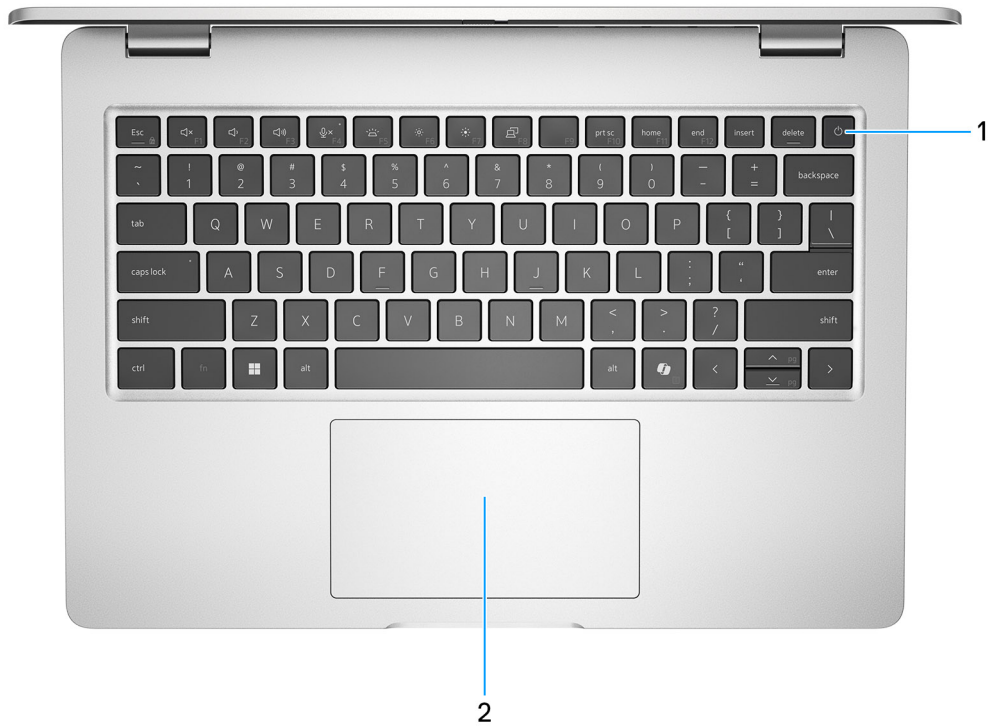

Figure 3. Top view

## 1. Power button with optional fingerprint reader

Press to turn on the computer if it is turned off, in sleep state, or in hibernate state.

When the computer is turned on, press the power button to put the computer into a sleep state; press and hold the power button for 10 seconds to force shutdown the computer.

If the power button has a fingerprint reader, place your finger on the power button steadily to log in.

**NOTE:** The power-status light on the power button is available only on computers without the fingerprint reader. Computers that are shipped with the fingerprint reader that is integrated on the power button will not have the power-status light on the power button.

**NOTE:** You can customize the power-button behavior in Windows.

## 2. Touchpad

Move your finger on the touchpad to move the mouse pointer. Tap to left-click and two fingers tap to right-click.

# Front



**Figure 4. Front view**

**1. Microphones (2)**

Provides digital sound input for audio recording and voice calls.

**2. Infrared camera (optional)**

Enhances security when paired with Windows Hello face authentication.

**3. Infrared emitter (optional)**

Emits infrared light, which enables the infrared camera to sense and track motion.

**4. Privacy shutter**

Slide the privacy shutter to cover the camera lens and protect your privacy when the camera is not in use.

**5. Camera**

Enables you to video chat, capture photos, and record videos.

**6. Camera-status light**

Turns on when the camera is in use.

# Bottom

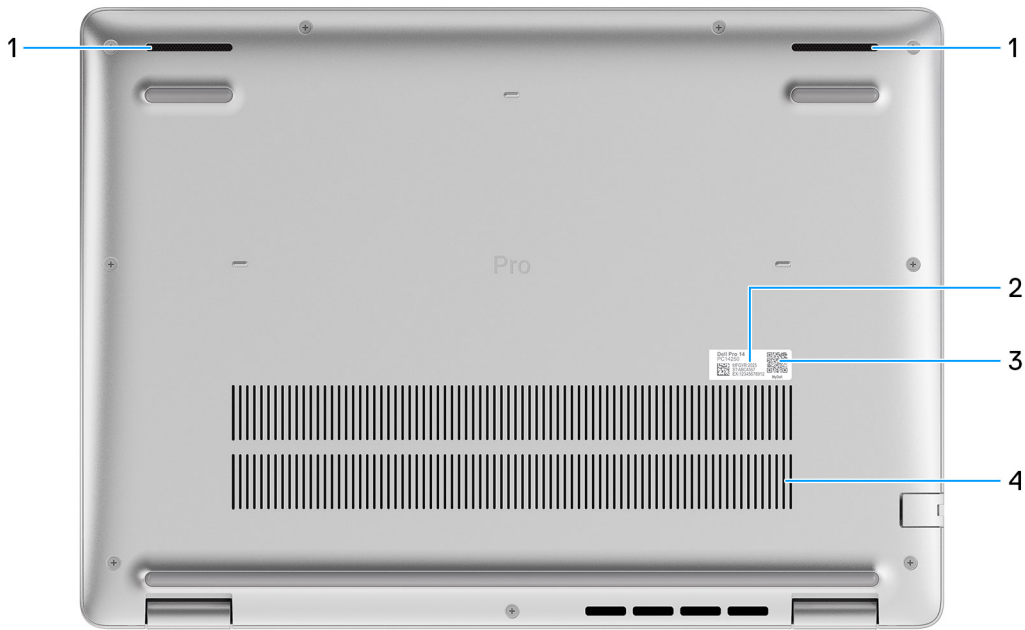

Figure 5. Bottom view

## 1. Speakers

Provide audio output.

## 2. Service Tag/Express Service Code label

The Service Tag is a unique alphanumeric identifier that enables Dell service technicians to identify the hardware components in your computer and access warranty information. The Express Service Code is a numeric version of the Service Tag.

## 3. MyDell QR code

MyDell is your hub for content that is personalized to your Dell Pro 14 PC14250, including videos, articles, manuals, and access to support.

## 4. Air vents

Air vents provide ventilation for your computer. Clogged air vents can cause overheating and can affect the performance of your computer and potentially cause hardware issues. Keep the air vents clear of obstructions and clean them regularly to prevent the build-up of dust and dirt. For more information about cleaning air vents, search for articles in the Knowledge Base Resource at [Dell Support Site](#).

# Locate the Service Tag or Express Service Code label of your computer

The service tag is a unique alphanumeric identifier that allows Dell service technicians to identify the hardware components in your computer and access warranty information. The Express Service Code is a numeric version of the Service Tag.

For more information about how to find the Service Tag of your computer, search in the Knowledge Base Resource at the [Dell Support Site](#).

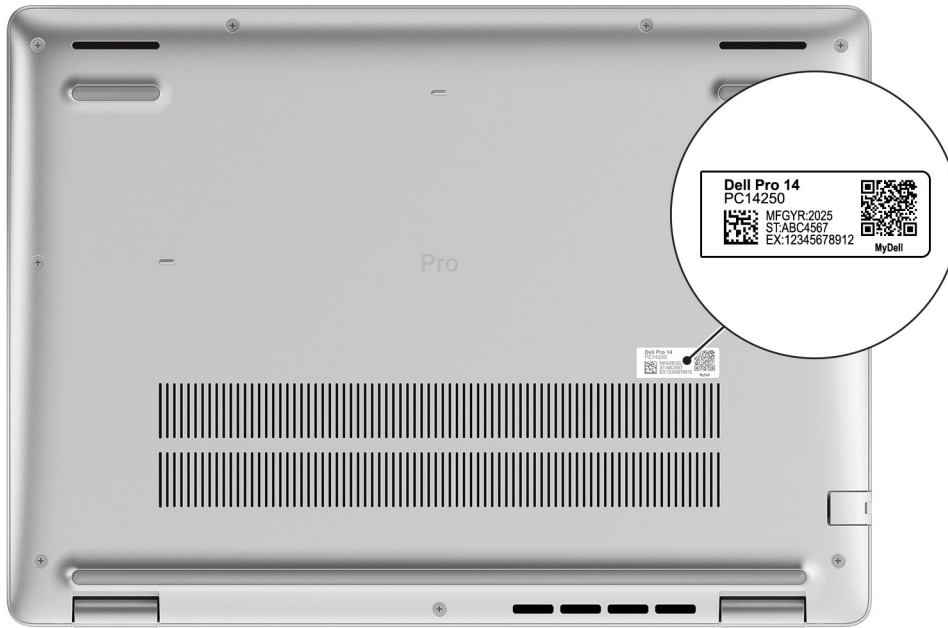

**Figure 6. Service Tag/Express Service Code location**

## Battery-charge status light

The following table lists the battery-charge and status light behavior of your Dell Pro 14 PC14250.

**Table 1. Battery charge and status light behavior**

Power source	LED behavior	System power state	Battery charge level
AC adapter	Off	S0 or S5	Fully charged
AC adapter	Solid white	S0 or S5	< Fully charged
Battery	Off	S0 or S5	11-100%
Battery	Solid amber (590+/-3 nm)	S0 or S5	< 10%

- S0 (ON): The computer is turned on.
- S4 (Hibernate): The computer consumes the least power in the Hibernated state than in the ON or OFF state. The computer is almost in the OFF state. The context data is written to a storage device, allowing you to resume from where you left when the computer is turned on.
- S5 (OFF): The computer is in a shutdown state.

**Table 2. Ethernet (RJ45) status LED**

LED Behavior	Connection status
Solid Amber	The RJ45 ethernet cable is connected properly from the router or switch to the computer. The connection is active.
Blinking Amber	Data transfer is in progress.

# Set up your Dell Pro 14 PC14250

## About this task

**NOTE:** The images in this document may differ from your computer depending on the configuration you ordered.

## Steps

1. Connect the power adapter and press the power button.



**Figure 7. Connect the power adapter and press the power button.**

**NOTE:** The battery may go into power-saving mode during shipment to conserve charge on the battery. Ensure that the power adapter is connected to your computer when it is turned on for the first time.

2. Finish the operating system setup.

### For Ubuntu:

Follow the on-screen instructions to complete the setup. For more information about installing and configuring Ubuntu, search in the Knowledge Base Resource at [Dell Support Site](#).

### For Windows:

Follow the on-screen instructions to complete the setup. When setting up, it is recommended that you:





- Connect to a network for Windows updates.

**NOTE:** If connecting to a secured wireless network, enter the password for the wireless network access when prompted.

- If connected to the Internet, sign in with or create a Microsoft account.

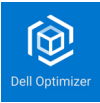
3. Locate and use Dell apps from the Windows Start menu—Recommended.

**Table 3. Locate Dell apps**

Resources	Description
	<p>Dell Optimizer is an application that is designed to enhance computer performance and productivity by optimizing settings for power, battery, display, and presence detection. It also provides access to applications purchased with your new computer.</p> <p>For more information, see Dell Optimizer User's Guide at <a href="#">Dell Support Site</a>.</p>
	<p><b>Dell Product Registration</b></p> <p>Register your computer with Dell.</p>
	<p><b>Dell Help &amp; Support</b></p> <p>Access help and support for your computer.</p>
	<p><b>SupportAssist</b></p> <p>SupportAssist is a proactive and predictive technology that offers automated technical support for Dell computers. It proactively monitors both hardware and software, addressing performance issues, preventing security threats, and automating engagement with Dell Technical Support.</p> <p>For more information, see SupportAssist documentation at <a href="#">Dell Support Site</a>.</p> <p><b>NOTE:</b> In SupportAssist, click the warranty expiry date to renew or upgrade your warranty.</p>

# Specifications of Dell Pro 14 PC14250

## Dimensions and weight

The following table lists the height, width, depth, and weight of your Dell Pro 14 PC14250.

**Table 4. Dimensions and weight**

Description	Option 1	Option 2 (For computers shipped with smart card reader)
Height:		
Front height	18.89 mm (0.74 in.)	20.29 mm (0.78 in.)
Rear height	20.37 mm (0.80 in.)	21.77 mm (0.85 in.)
Width	313.70 mm (12.35 in.)	313.70 mm (12.35 in.)
Depth	225.30 mm (8.87 in.)	225.30 mm (8.87 in.)
Weight  <b>NOTE:</b> The weight of your computer depends on the configuration that you ordered.	Minimum - 1.35 kg (2.97 lb)	Minimum - 1.42 kg (3.13 lb)

## Processor

The following tables list the details of the processors that are supported on your Dell Pro 14 PC14250.

**Table 5. Processor**

Description	Option one	Option two	Option three	Option four	Option five
Type	Intel Processor U300E	13 <sup>th</sup> Generation Intel Core i3-1315U	13 <sup>th</sup> Generation Intel Core i5-1335U	13 <sup>th</sup> Generation Intel Core i5-1345U	Intel Core 3 100U
Wattage	15 W	15 W	15 W	15 W	15 W
Total core count	5	6	10	10	6
Performance-cores	1	2	2	2	2
Efficient-cores	4	4	8	8	4
Total thread count	6	8	12	12	8
 <b>NOTE:</b> Intel Hyper-Threading Technology is available only on Performance-cores.					
Speed	Up to 4.3 GHz	Up to 4.5 GHz	Up to 4.6 GHz	Up to 4.7 GHz	Up to 4.7 GHz
Frequency—Performance cores					
Base frequency	1.1 GHz	1.2 GHz	1.3 GHz	1.6 GHz	1.2 GHz
Maximum turbo frequency	4.3 GHz	4.5 GHz	4.6 GHz	4.7 GHz	4.7 GHz
Frequency—Efficient cores					
Base frequency	1.1 GHz	0.9 GHz	0.9 GHz	1.2 GHz	0.9 GHz
Maximum turbo frequency	3.2 GHz	3.3 GHz	3.4 GHz	3.5 GHz	3.3 GHz
Cache	8 MB	10 MB	12 MB	12 MB	10 MB
Integrated graphics	Intel UHD Graphics	Intel UHD Graphics	Intel Iris Xe Graphics	Intel Iris Xe Graphics	Intel Graphics

**Table 6. Processor**

Description	Option six	Option seven	Option eight	Option nine	Option ten
Type	Intel Core 5 120U	Intel Core 5 220U	Intel Core 7 150U	Intel Core 7 250U	Intel Core Ultra 5 225U
Wattage	15 W	15 W	15 W	15 W	15 W
Total core count	10	10	10	10	12
Performance-cores	2	2	2	2	2
Efficient-cores	8	8	8	8	8
Total thread count	12	12	12	12	14
 <b>NOTE:</b> Intel Hyper-Threading Technology is only available on Performance-cores.					
Speed	Up to 5.0 GHz	Up to 5.0 GHz	Up to 5.4 GHz	Up to 5.4 GHz	Up to 4.8 GHz
Frequency—Performance cores					
Base frequency	1.4 GHz	1.4 GHz	1.8 GHz	1.8 GHz	1.5 GHz
Maximum turbo frequency	5.0 GHz	5.0 GHz	5.4 GHz	5.4 GHz	4.8 GHz
Frequency—Efficient cores					
Base frequency	0.9 GHz	0.9 GHz	1.2 GHz	1.2 GHz	1.3 GHz
Maximum turbo frequency	3.8 GHz	3.8 GHz	4.0 GHz	4.0 GHz	3.8 GHz
Cache	12 MB	12 MB	12 MB	12 MB	12 MB
Integrated graphics	Intel Graphics	Intel Graphics	Intel Graphics	Intel Graphics	Intel Graphics

**Table 7. Processor**

Description	Option eleven	Option twelve	Option thirteen
Type	Intel Core Ultra 5 235U	Intel Core Ultra 7 255U	Intel Core Ultra 7 265U
Wattage	15 W	15 W	15 W
Total core count	12	12	12
Performance-cores	2	2	2
Efficient-cores	8	8	8
Total thread count <b>i</b> <b>NOTE:</b> Intel Hyper-Threading Technology is only available on Performance-cores.	14	14	14
Speed	Up to 4.9 GHz	Up to 5.2 GHz	Up to 5.3 GHz
Frequency—Performance cores			
Base frequency	2.0 GHz	2.0 GHz	2.1 GHz
Maximum turbo frequency	4.9 GHz	5.20 GHz	5.3 GHz
Frequency—Efficient cores			
Base frequency	1.6 GHz	1.7 GHz	1.7 GHz
Maximum turbo frequency	4.1 GHz	4.2 GHz	4.2 GHz
Cache	12 MB	12 MB	12 MB
Integrated graphics	Intel Graphics	Intel Graphics	Intel Graphics

## Chipset

The following table lists the details of the chipset that is supported by your Dell Pro 14 PC14250.

**Table 8. Chipset**

Description	Values
Chipset	Integrated in the processor
Processor	<ul style="list-style-type: none"> <li>● Intel Processor U300E</li> <li>● 13<sup>th</sup> Generation Intel Core i3/i5</li> <li>● Intel Core 3/5/7</li> <li>● Intel Core Ultra 5/7</li> </ul>
DRAM bus width	64-bit
Flash EPROM	32 MB
PCIe bus	Up to Gen4

# Operating system

Your Dell Pro 14 PC14250 supports the following operating systems:

- Windows 11 Home
- Windows 11 Professional
- Ubuntu 24.04 LTS

**NOTE:** If you downgrade your computer from Windows 11 to Windows 10 22H2, Dell Technologies support will follow the Microsoft Windows 10 End of Support plan.

# Memory

The following table lists the memory specifications that are supported in your Dell Pro 14 PC14250.

**Table 9. Memory specifications**

Description	Values
Memory slots	Two SODIMM slots
Memory type	DDR5
Memory speed	<ul style="list-style-type: none"><li>• 5200 MT/s</li><li>• 5600 MT/s</li></ul>
Maximum memory configuration	64 GB
Minimum memory configuration	8 GB
Memory size per slot	8 GB, 16 GB, and 32 GB
Memory configurations supported	<p><b>For computers shipped with Intel Core Series:</b></p> <ul style="list-style-type: none"><li>• 8 GB: 1 x 8 GB, DDR5, 5200 MT/s, single-channel</li><li>• 16 GB: 2 x 8 GB, DDR5, 5200 MT/s, dual-channel</li><li>• 16 GB: 1 x 16 GB, DDR5, 5200 MT/s, single-channel</li><li>• 32 GB: 1 x 32 GB, DDR5, 5200 MT/s, single-channel</li><li>• 32 GB: 2 x 16 GB, DDR5, 5200 MT/s, dual-channel</li><li>• 64 GB: 2 x 32 GB, DDR5, 5200 MT/s, dual-channel</li></ul> <p><b>For computers shipped with Intel Core Ultra 200U Series:</b></p> <ul style="list-style-type: none"><li>• 8 GB: 1 x 8 GB, DDR5, 5600 MT/s, single-channel</li><li>• 16 GB: 2 x 8 GB, DDR5, 5600 MT/s, dual-channel</li><li>• 16 GB: 1 x 16 GB, DDR5, 5600 MT/s, single-channel</li><li>• 32 GB: 1 x 32 GB, DDR5, 5600 MT/s, single-channel</li><li>• 32 GB: 2 x 16 GB, DDR5, 5600 MT/s, dual-channel</li><li>• 64 GB: 2 x 32 GB, DDR5, 5600 MT/s, dual-channel</li></ul>

# External ports and slots

The following table lists the external ports and slots on your Dell Pro 14 PC14250.

**Table 10. External ports and slots**

Description	Values
Network port	One RJ45 ethernet port (1 Gbps)

**Table 10. External ports and slots (continued)**

Description	Values
USB ports	<ul style="list-style-type: none"> <li>One USB 3.2 Gen 1 (5 Gbps) port</li> <li>One USB 3.2 Gen 1 (5 Gbps) port with PowerShare</li> <li>One USB 3.2 Gen 2 (10 Gbps) Type-C with DisplayPort 2.0/Power Delivery 3.1</li> <li>One Thunderbolt 4 (40 Gbps) port with DisplayPort 2.1/USB Type-C/USB4/Power Delivery 3.1</li> </ul> <p><b>NOTE:</b> You can connect a Dell Docking Station to this port. For more information, search in the Knowledge Base Resource at <a href="#">Dell Support Site</a>.</p>
Audio port	One global headset port
Video port(s)	One HDMI 2.1 Transition-minimized differential signaling (TMDS) port
Media-card reader	Not applicable
Power-adaptor port	One 4.5 mm x 2.9 mm DC-in
Security-cable slot	One security-cable slot (wedge-shaped)
Smart card reader	One smart card reader slot (optional)

## Internal slots

The following table lists the internal slots of your Dell Pro 14 PC14250.

**Table 11. Internal slots**

Description	Values
M.2	<ul style="list-style-type: none"> <li>One M.2 2230 slot for solid state drive</li> <li>One M.2 2230 slot for WLAN card, Wi-Fi/Bluetooth</li> </ul> <p><b>NOTE:</b> To learn more about the features of different types of M.2 cards, search <a href="#">Dell Support Site</a>.</p>

## Ethernet

**Table 12. Ethernet specifications**

Description	Option one	Option two
Model	Integrated Realtek RTL8111H-CG	Intel Ethernet Connection i219-LM <b>NOTE:</b> Applicable only to computers shipped with Intel Core Ultra 5 235U and Intel Core Ultra 7 265U processors.
Transfer rate	10/100/1000 Mbps	10/100/1000 Mbps

# Wireless module

The following table lists the Wireless Local Area Network (WLAN) module specifications of your Dell Pro 14 PC14250.

**Table 13. Wireless module specifications**

Description	Option one	Option two	Option three	Option four
Model number	MediaTek MT7920	Intel AX211	Intel BE202 <b>i</b> <b>NOTE:</b> Applicable only to computers shipped with Intel Core Ultra 200U processors.	Intel BE200 <b>i</b> <b>NOTE:</b> Applicable only to computers shipped with Intel Core Ultra 200U processors.
Transfer rate	1200 Mbps	Up to 2400 Mbps	Up to 2400 Mbps	Up to 5760 Mbps
Frequency bands supported	2.4 GHz/5 GHz	2.4 GHz/5 GHz/6 Ghz	2.4 GHz/5 GHz/6 Ghz	2.4 GHz/5 GHz/6 Ghz
Wireless standards	<ul style="list-style-type: none"> <li>• WiFi 802.11a/b/g</li> <li>• Wi-Fi 4 (WiFi 802.11n)</li> <li>• Wi-Fi 5 (WiFi 802.11ac)</li> <li>• Wi-Fi 6 (WiFi 802.11ax)</li> </ul>	<ul style="list-style-type: none"> <li>• WiFi 802.11a/b/g</li> <li>• Wi-Fi 4 (WiFi 802.11n)</li> <li>• Wi-Fi 5 (WiFi 802.11ac)</li> <li>• Wi-Fi 6E (WiFi 802.11ax)</li> </ul>	<ul style="list-style-type: none"> <li>• WiFi 802.11a/b/g</li> <li>• Wi-Fi 4 (WiFi 802.11n)</li> <li>• Wi-Fi 5 (WiFi 802.11ac)</li> <li>• Wi-Fi 6E (WiFi 802.11ax)</li> <li>• Wi-Fi 7 (WiFi 802.11be)</li> </ul>	<ul style="list-style-type: none"> <li>• WiFi 802.11a/b/g</li> <li>• Wi-Fi 4 (WiFi 802.11n)</li> <li>• Wi-Fi 5 (WiFi 802.11ac)</li> <li>• Wi-Fi 6E (WiFi 802.11ax)</li> <li>• Wi-Fi 7 (WiFi 802.11be)</li> </ul>
Encryption	<ul style="list-style-type: none"> <li>• 64-bit/128-bit WEP</li> <li>• AES-CCMP</li> <li>• TKIP</li> </ul>	<ul style="list-style-type: none"> <li>• 64-bit/128-bit WEP</li> <li>• AES-CCMP</li> <li>• TKIP</li> </ul>	<ul style="list-style-type: none"> <li>• 64-bit/128-bit WEP</li> <li>• AES-CCMP</li> <li>• TKIP</li> </ul>	<ul style="list-style-type: none"> <li>• 64-bit/128-bit WEP</li> <li>• AES-CCMP</li> <li>• TKIP</li> </ul>
Bluetooth wireless card <b>i</b> <b>NOTE:</b> The functionality of the Bluetooth wireless card may vary based on the operating system.	Bluetooth 5.4	Bluetooth 5.3	Bluetooth 5.4	Bluetooth 5.4

# Audio

The following table lists the audio specifications of your Dell Pro 14 PC14250.

**Table 14. Audio specifications**

Description	Values
Audio controller	Realtek ALC3204
Stereo conversion	Supported with Waves MaxxAudio
Internal audio interface	High definition audio interface
External audio interface	One global headset (headphone and microphone combo) port

**Table 14. Audio specifications (continued)**

Description	Values
Number of speakers	Two
Internal-speaker amplifier	Supported (audio codec integrated)
External volume controls	Keyboard shortcut controls
Speaker output:	
Average	2 W x 2 = 4 W
Peak	2.5 W x 2 = 5 W
Microphone	Dual-array microphone

## Storage

This section lists the storage options on your Dell Pro 14 PC14250.

Your Dell Pro 14 PC14250 supports one of the following storage configurations:

- One Universal Flash Storage (onboard)

**NOTE:** UFS is available only for computers that are shipped with Intel Core Series processors.

**NOTE:** For computers shipped with UFS, the storage is integrated with the system board. Dell Technologies recommends that you back up your data regularly to avoid any potential data loss after a service incident. For more information, see the knowledge base article [000130154](#) at Dell Support Site.

- One M.2 2230 solid-state drive

**Table 15. Storage specifications**

Storage type	Interface type	Capacity
Universal Flash Storage (onboard)	UFS v3.1, up to HS-Gear 4, 2.9 GB/s	128 GB <b>NOTE:</b> The UFS is integrated in the processor and is not upgradable.
M.2 2230 solid-state drive, TLC	PCIe Gen4 NVMe, up to 64 Gbps	256 GB/512 GB/ 1 TB
M.2 2230 solid-state drive, QLC	PCIe Gen4 NVMe, up to 64 Gbps	512 GB/1 TB/2 TB
M.2 2230 solid-state drive, Self-encrypting drive, Opal 2.0, TLC <b>NOTE:</b> Only available on computers shipped with Intel Core Ultra 200U Series processors.	PCIe Gen4 NVMe, up to 64 Gbps	512 GB

## Keyboard

The following table lists the keyboard specifications of your Dell Pro 14 PC14250.

**Table 16. Keyboard specifications**

Description	Values
Keyboard type	<ul style="list-style-type: none"> <li>Backlit keyboard with Copilot key and fingerprint reader</li> </ul>

**Table 16. Keyboard specifications (continued)**

Description	Values
	<ul style="list-style-type: none"> <li>• Backlit keyboard with Copilot key</li> <li>• Non-backlit keyboard with Copilot key and fingerprint reader</li> <li>• Non-backlit keyboard with Copilot key</li> </ul>
Keyboard layout	QWERTY
Number of keys	<ul style="list-style-type: none"> <li>• Arabic, Chinese (Traditional), English International, English US, Hebrew, Ukrainian: 79 keys</li> <li>• Belgian, Bulgarian, Czech and Slovakian (MUI), English UK, French (European), French (European), German, Hungarian, Greek, Hebrew, Italian, Nordic (MUI), Portuguese Iberian, Portuguese Brazil, Russian, Spanish (Castilian), Spanish (Latin America), Swiss European (MUI), Turkish: 80 keys</li> <li>• Japanese: 83 keys</li> </ul>
Key pitch	Horizontal= 19.05 mm Vertical= 18.05 mm
Keyboard shortcuts	Some keys on your keyboard have two symbols on them. These keys can be used to type alternate characters or to perform secondary functions. <ul style="list-style-type: none"> <li>• To type the alternate character, press Shift and the desired key.</li> <li>• To perform secondary functions, press Fn and the desired key.</li> </ul> <p> <b>NOTE:</b> You can define the primary behavior of the function keys (F1–F12) changing <b>Function Key Behavior</b> in the BIOS Setup program.</p>

## Keyboard shortcuts of Dell Pro 14 PC14250

 **NOTE:** Keyboard characters may differ depending on the keyboard language configuration. Keys that are used for shortcuts remain the same across all language configurations.

Some keys on your keyboard have two symbols on them. These keys can be used to type alternate characters or to perform secondary functions. The symbol that is shown on the lower part of the key refers to the character that is typed out when the key is pressed. If you press shift and the key, the symbol that is shown on the upper part of the key is typed out. For example, if you press **2**, 2 is typed out; if you press **Shift + 2**, @ is typed out.

The keys F1-F12 at the top row of the keyboard are function keys for multimedia control, as indicated by the icon on the key. Press the function key to enable the task represented by the icon. For example, pressing F1 mutes the audio (see the table below).

However, if the function keys F1-F12 are needed for specific software applications, multimedia functionality can be disabled by pressing **Fn + Esc**. Later, multimedia control can be invoked by pressing **Fn** and the respective function key. For example, mute audio by pressing **Fn + F1**.

 **NOTE:** You can also define the primary behavior of the function keys (F1–F12) by changing **Function Key Behavior** in the BIOS setup program.

**Table 17. Function key primary behavior**

Function key	Primary behavior
F1	Mute or unmute audio
F2	Decrease volume

**Table 17. Function key primary behavior (continued)**

Function key	Primary behavior
F3	Increase volume
F4	Microphone Mute
F5	Keyboard Illumination/Backlight
F6	Decrease screen brightness
F7	Increase screen brightness
F8	Switch to external display
F10	Print screen
F11	Home
F12	End

The **Fn** key is also used with selected keys on the keyboard to invoke secondary functions.

**Table 18. Secondary behavior**

Function key	Secondary behavior
Fn + F1	Operating system and application-specific F1 behavior
Fn + F2	Operating system and application-specific F2 behavior
Fn + F3	Operating system and application-specific F3 behavior
Fn + F4	Operating system and application-specific F4 behavior
Fn + F5	Operating system and application-specific F5 behavior
Fn + F6	Operating system and application-specific F6 behavior
Fn + F7	Operating system and application-specific F6 behavior
Fn + F8	Operating system and application-specific F8 behavior
Fn + F9	Operating system and application-specific F9 behavior
Fn + F10	Operating system and application-specific F10 behavior
Fn + F11	Operating system and application-specific F11 behavior
Fn + F12	Operating system and application-specific F12 behavior
Fn + Ctrl	Open the application menu
Fn + Esc	Toggle between multimedia and function key behavior
Fn + PgUp	Scroll up the document or page
Fn + PgDn	Scroll down the document or page
Fn + Home	Move to the beginning of the document
Fn + End	Move to the end of the document
Copilot	<p>Launch Copilot in Windows</p> <p><b>NOTE:</b> If Copilot in Windows is not available on your computer, the Copilot key launches Recall. If both Recall and Copilot in Windows are not available on your computer, the Copilot key launches Windows Search. For more information about Copilot in Windows and Recall, search in the Knowledge Base Resource at the <a href="#">Dell Support Site</a>.</p>

# Camera

The following table lists the camera specifications of your Dell Pro 14 PC14250.

**Table 19. Camera specifications**

Description	Values
Number of cameras	Two  <b>NOTE:</b> The second camera is optional and available with selected configurations.
Camera type	<ul style="list-style-type: none"> <li>• HD RGB (For computers shipped with Intel Core Series)</li> <li>• FHD RGB</li> <li>• FHD RGB + IR</li> </ul>
Camera location	Front camera
Camera sensor type	CMOS sensor technology
Camera resolution:	
Still image	<ul style="list-style-type: none"> <li>• 0.92 megapixels (HD)</li> <li>• 2.07 megapixels (FHD)</li> </ul>
Video	<ul style="list-style-type: none"> <li>• 1280 x 720 (HD) at 30 fps</li> <li>• 1920 x 1080 (FHD) at 30 fps</li> </ul>
Infrared camera resolution:	
Still image	0.23 megapixels
Video	640 x 360 at 15 fps
Diagonal viewing angle:	
Camera	<ul style="list-style-type: none"> <li>• 75.0 degrees (HD)</li> <li>• 80.2 degrees (FHD)</li> </ul>
Infrared camera	86.60 degrees

# Touchpad

The following table lists the touchpad specifications of your Dell Pro 14 PC14250.

**Table 20. Touchpad specifications**

Description	Values
Touchpad resolution:	>300 DPI
Touchpad dimensions:	
Horizontal	115.00 mm (4.52 in.)
Vertical	67.00 mm (2.63 in.)
Touchpad gestures	For more information about the touchpad gestures available on Windows, search <a href="#">Microsoft Support Site</a> .

# Power adapter

The following table lists the power adapter specifications of your Dell Pro 14 PC14250.

**Table 21. Power-adapter specifications**

Description	Option one	Option two	Option three
Type	65W AC adapter, 4.5 mm barrel, E4	65W AC adapter, USB Type-C, PECOS	60W AC adapter, USB Type-C, 2-pin (Japan)
Connector dimensions:			
External diameter	4.5 mm	Not applicable	Not applicable
Internal diameter	2.9 mm	Not applicable	Not applicable
Power-adapter dimensions:			
Height	29.5 mm	28 mm	22 mm
Width	46.0 mm	51 mm	55 mm
Depth	108.0 mm	112 mm	66 mm
Input voltage	100 VAC - 240 VAC	100 VAC - 240 VAC	100 VAC - 240 VAC
Input frequency	50 Hz - 60 Hz	50 Hz - 60 Hz	50 Hz - 60 Hz
Input current (maximum)	1.7 A	1.7 A	1.7 A
Output current (continuous)	3.34 A	<ul style="list-style-type: none"> <li>• 20 V/3.25 A (Continuous)</li> <li>• 15 V/3 A (Continuous)</li> <li>• 9 V/3 A (Continuous)</li> <li>• 5 V/3 A (Continuous)</li> </ul>	<ul style="list-style-type: none"> <li>• 20 V/3 A (Continuous)</li> <li>• 15 V/3 A (Continuous)</li> <li>• 9 V/3 A (Continuous)</li> <li>• 5 V/3 A (Continuous)</li> </ul>
Rated output voltage	19.5 VDC	<ul style="list-style-type: none"> <li>• 20 VDC</li> <li>• 15 VDC</li> <li>• 9 VDC</li> <li>• 5 VDC</li> </ul>	<ul style="list-style-type: none"> <li>• 20 VDC</li> <li>• 15 VDC</li> <li>• 9 VDC</li> <li>• 5 VDC</li> </ul>
Temperature range:			
Operating	0°C to 40°C (32°F to 104°F)	0°C to 40°C (32°F to 104°F)	0°C to 40°C (32°F to 104°F)
Storage	-40°C to 70°C (-40°F to 158°F)	-40°C to 70°C (-40°F to 158°F)	-40°C to 70°C (-40°F to 158°F)
 <b>CAUTION: Operating and storage temperature ranges may differ among components, so operating or storing the device outside these ranges may impact the performance of specific components.</b>			

## Power adapter requirements (for computers that are shipped with a 3-cell, 45 Wh battery)

**NOTE:** If you did not purchase the Dell-branded power adapter that is recommended for your computer, ensure that the power adapter you use meets the following requirements.

The following table lists the power adapter requirements for your Dell Pro 14 PC14250.

**Table 22. Power adapter requirements**

Description	Value
Power that is required from a power adapter to achieve optimal performance.	65 W
Power that charges the computer at a slower speed. <i>i</i> <b>NOTE:</b> A warning message may appear informing you about the use of a lower-powered adapter and slower charging speed.	Less than 60 W
Minimum power that is required from a power adapter to operate the computer and charge the battery. <i>i</i> <b>NOTE:</b> A warning message appears informing you about the use of a lower-powered adapter and slower charging speed.	27 W
USB Power Delivery (PD) fast charging	Supported
ExpressCharge mode	ExpressCharge 1.0 and ExpressCharge Boost supported <i>i</i> <b>NOTE:</b> Ensure that the computer with a 45 Wh battery is connected to a 65 W power adapter for this feature to be supported.  <i>i</i> <b>NOTE:</b> ExpressCharge mode must also be enabled in the BIOS Setup screen. Select <b>Power &gt; Battery Configuration &gt; ExpressCharge</b> , then press <b>Enter</b> .

## Power adapter requirements (for computers that are shipped with a 3-cell, 55 Wh battery)

*i* **NOTE:** If you did not purchase the Dell-branded power adapter that is recommended for your computer, ensure that the power adapter you use meets the following requirements.

The following table lists the power adapter requirements for your Dell Pro 14 PC14250.

**Table 23. Power adapter requirements**

Description	Value
Power that is required from a power adapter to achieve optimal performance.	65 W
Power that charges the computer at a slower speed. <i>i</i> <b>NOTE:</b> A warning message may appear informing you about the use of a lower-powered adapter and slower charging speed.	Less than 60 W
Minimum power that is required from a power adapter to operate the computer and charge the battery. <i>i</i> <b>NOTE:</b> A warning message appears informing you about the use of a lower-powered adapter and slower charging speed.	27 W
USB Power Delivery (PD) fast charging	Supported
ExpressCharge mode	ExpressCharge 1.0 supported and ExpressCharge Boost capable <i>i</i> <b>NOTE:</b> For ExpressCharge Boost mode, ensure that the computer with a 55 Wh battery is connected to a 90 W power adapter for this feature to be supported.

**Table 23. Power adapter requirements (continued)**

Description	Value
	<p><b>NOTE:</b> ExpressCharge mode must also be enabled in the BIOS Setup screen. Select <b>Power &gt; Battery Configuration &gt; ExpressCharge</b>, then press <b>Enter</b>.</p>

## Battery

The following table lists the battery specifications of your Dell Pro 14 PC14250.

**Table 24. Battery specifications**

Description	Option one	Option two	Option three	Option four
Battery type	3-cell, 45 Wh, ExpressCharge 1.0, ExpressCharge Boost	3-cell, 45 Wh, ExpressCharge 1.0, ExpressCharge Boost, Long Life Cycle	3-cell, 55 Wh, ExpressCharge 1.0, ExpressCharge Boost Capable	3-cell, 55 Wh, ExpressCharge 1.0, ExpressCharge Boost Capable, Long Life Cycle
Battery voltage	11.25 VDC	11.25 VDC	11.70 VDC	11.70 VDC
Battery weight (maximum)	0.20 kg (0.44 lb)	0.20 kg (0.44 lb)	0.21 kg (0.48 lb)	0.21 kg (0.48 lb)
Battery dimensions:				
Height	6.30 mm (0.25 in.)	6.30 mm (0.25 in.)	6.30 mm (0.25 in.)	6.30 mm (0.25 in.)
Width	255.05 mm (10.04 in.)	255.05 mm (10.04 in.)	255.05 mm (10.04 in.)	255.05 mm (10.04 in.)
Depth	73.00 mm (2.87 in.)	73.00 mm (2.87 in.)	73.00 mm (2.87 in.)	73.00 mm (2.87 in.)
Temperature range:				
Operating	<ul style="list-style-type: none"> <li>Charge: 0°C to 45°C (32°F to 113°F)</li> <li>Discharge: 0°C to 70°C (32°F to 158°F)</li> </ul>	<ul style="list-style-type: none"> <li>Charge: 0°C to 45°C (32°F to 113°F)</li> <li>Discharge: 0°C to 70°C (32°F to 158°F)</li> </ul>	<ul style="list-style-type: none"> <li>Charge: 0°C to 45°C (32°F to 113°F)</li> <li>Discharge: 0°C to 70°C (32°F to 158°F)</li> </ul>	<ul style="list-style-type: none"> <li>Charge: 0°C to 45°C (32°F to 113°F)</li> <li>Discharge: 0°C to 70°C (32°F to 158°F)</li> </ul>
Storage	-20°C to 60°C (-4°F to 140°F)	-20°C to 60°C (-4°F to 140°F)	-20°C to 60°C (-4°F to 140°F)	-20°C to 60°C (-4°F to 140°F)
Battery operating time	Varies depending on operating conditions and can significantly reduce under certain power-intensive conditions.	Varies depending on operating conditions and can significantly reduce under certain power-intensive conditions.	Varies depending on operating conditions and can significantly reduce under certain power-intensive conditions.	Varies depending on operating conditions and can significantly reduce under certain power-intensive conditions.
Battery charging time (approximate)	<ul style="list-style-type: none"> <li>0°C to 15°C—4 hours (when the computer is off)</li> <li>16°C to 45°C—2 hours (when the computer is off)</li> </ul> <p><b>NOTE:</b> Control the charging time, duration, start and end time, and so on using the Dell Power Manager application.</p>	<ul style="list-style-type: none"> <li>0°C to 15°C—4 hours (when the computer is off)</li> <li>16°C to 45°C—2 hours (when the computer is off)</li> </ul>	<ul style="list-style-type: none"> <li>0°C to 15°C—4 hours (when the computer is off)</li> <li>16°C to 45°C—2 hours (when the computer is off)</li> </ul>	<ul style="list-style-type: none"> <li>0°C to 15°C—4 hours (when the computer is off)</li> <li>16°C to 45°C—2 hours (when the computer is off)</li> </ul>

**Table 24. Battery specifications (continued)**

Description	Option one	Option two	Option three	Option four
For more information on the Dell Power Manager see, <i>Me and My Dell</i> on <a href="#">dell support</a> .	<ul style="list-style-type: none"> <li>46°C to 50°C— 3 hours(when the computer is off)</li> </ul>	<ul style="list-style-type: none"> <li>46°C to 50°C— 3 hours(when the computer is off)</li> </ul>	<ul style="list-style-type: none"> <li>46°C to 50°C— 3 hours(when the computer is off)</li> </ul>	<ul style="list-style-type: none"> <li>46°C to 50°C— 3 hours(when the computer is off)</li> </ul>
Coin-cell battery	Not supported	Not supported	Not supported	Not supported
<p><b>⚠ CAUTION: Operating and storage temperature ranges may differ among components, so operating or storing the device outside these ranges may impact the performance of specific components.</b></p> <p><b>⚠ CAUTION: Dell recommends that you charge the battery regularly for optimal power consumption. If your battery charge is completely depleted, connect the power adapter, turn on your computer, and then restart your computer to reduce the power consumption.</b></p>				

## Power requirements (for computers that are shipped with a 3-cell, 45 Wh battery)

**NOTE:** The information in this section is applicable to the European Union (EU) countries.

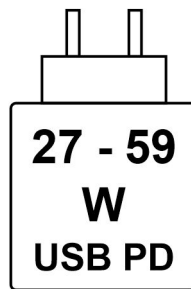

**Figure 8. Pictogram for power charging requirements**

The power that is delivered by the charger must be between a minimum of 27 Watts that is required by the radio equipment, and a maximum of 59 Watts in order to achieve the maximum charging speed.

This computer supports USB Power Delivery (PD) fast charging.

## Power requirements (for computers that are shipped with a 3-cell, 55 Wh battery)

**NOTE:** The information in this section is applicable to the European Union (EU) countries.

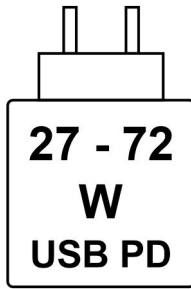

**Figure 9. Pictogram for power charging requirements**

The power that is delivered by the charger must be between a minimum of 27 Watts that is required by the radio equipment, and a maximum of 72 Watts in order to achieve the maximum charging speed.

This computer supports USB Power Delivery (PD) fast charging.

## Display

The following table lists the display specifications of your Dell Pro 14 PC14250.

**Table 25. Display specifications**

Description	Option one	Option two	Option three	Option four	Option five
Display type	14-inch, Full High Definition Plus (FHD+)	14-inch, Full High Definition Plus (FHD+), Low Blue Light	14-inch, Full High Definition Plus (FHD+)	14-inch, Full High Definition Plus (FHD+)	14-inch Full High Definition Plus (FHD+)
Touch options	Non-Touch	Non-Touch	Non-Touch	Touch	Touch
Display-panel technology	In-Plane Switching (IPS)	In-Plane Switching (IPS)	In-Plane Switching (IPS)	In-Plane Switching (IPS)	In-Plane Switching (IPS)
Display-panel dimensions (active area):					
Height	188.50 mm (7.42 in.)	188.50 mm (7.42 in.)	188.50 mm (7.42 in.)	188.50 mm (7.42 in.)	188.50 mm (7.42 in.)
Width	301.59 mm (11.87 in.)	301.59 mm (11.87 in.)	301.59 mm (11.87 in.)	301.59 mm (11.87 in.)	301.59 mm (11.87 in.)
Diagonal	355.60 mm (14.00 in.)	355.60 mm (14.00 in.)	355.60 mm (14.00 in.)	355.60 mm (14.00 in.)	355.60 mm (14.00 in.)
Display-panel native resolution	1920 x 1200	1920 x 1200	1920 x 1200	1920 x 1200	1920 x 1200
Luminance (typical)	300 nits	400 nits	400 nits	300 nits	400 nits
Megapixels	2.30	2.30	2.30	2.30	2.3
Color gamut	45% NTSC	100% sRGB	45% NTSC	100% sRGB	100% sRGB
Pixels Per Inch (PPI)	162	162	162	162	162
Contrast ratio (typical)	<ul style="list-style-type: none"> <li>• 600:1 (minimum)</li> <li>• 800:1 (typical)</li> </ul>	<ul style="list-style-type: none"> <li>• 800:1 (minimum)</li> <li>• 1000:1 (typical)</li> </ul>	<ul style="list-style-type: none"> <li>• 600:1 (minimum)</li> <li>• 800:1 (typical)</li> </ul>	<ul style="list-style-type: none"> <li>• 600:1 (minimum)</li> <li>• 800:1 (typical)</li> </ul>	<ul style="list-style-type: none"> <li>• 600:1 (minimum)</li> <li>• 800:1 (typical)</li> </ul>

**Table 25. Display specifications (continued)**

Description	Option one	Option two	Option three	Option four	Option five
Response time (maximum)	35 milliseconds	35 milliseconds	35 milliseconds	35 milliseconds	35 ms
Refresh rate	60 Hz	30 Hz to 60 Hz	60 Hz	60 Hz	60 Hz
Horizontal view angle	<ul style="list-style-type: none"> <li>+/- 80 degrees (minimum)</li> <li>+/- 85 degrees (typical)</li> </ul>	<ul style="list-style-type: none"> <li>+/- 80 degrees (minimum)</li> <li>+/- 85 degrees (typical)</li> </ul>	<ul style="list-style-type: none"> <li>+/- 80 degrees (minimum)</li> <li>+/- 89 degrees (typical)</li> </ul>	<ul style="list-style-type: none"> <li>+/- 80 degrees (minimum)</li> <li>+/- 85 degrees (typical)</li> </ul>	<ul style="list-style-type: none"> <li>+/- 80 degrees (minimum)</li> <li>+/- 89 degrees (typical)</li> </ul>
Vertical view angle	<ul style="list-style-type: none"> <li>+/- 80 degrees (minimum)</li> <li>+/- 85 degrees (typical)</li> </ul>	<ul style="list-style-type: none"> <li>+/- 80 degrees (minimum)</li> <li>+/- 85 degrees (typical)</li> </ul>	<ul style="list-style-type: none"> <li>+/- 80 degrees (minimum)</li> <li>+/- 85 degrees (typical)</li> </ul>	<ul style="list-style-type: none"> <li>+/- 80 degrees (minimum)</li> <li>+/- 85 degrees (typical)</li> </ul>	<ul style="list-style-type: none"> <li>+/- 80 degrees (minimum)</li> <li>+/- 85 degrees (typical)</li> </ul>
Pixel pitch	0.1571 mm	0.1571 mm	0.1571 mm	0.1571 mm	0.1571 mm
Power consumption (maximum)	3.68 W	2.50 W	4.6 W	4.40 W	5.50 W
Anti-glare vs glossy finish	Anti-glare	Anti-glare	Anti-glare	Anti-glare	Anti-glare

## Fingerprint reader (optional)

The following table lists the specifications of the optional fingerprint-reader of your Dell Pro 14 PC14250.

**Table 26. Fingerprint reader specifications**

Description	Values
Sensor technology	Capacitive
Sensor resolution	500 dpi
Sensor pixel size	108 mm x 88 mm

## Sensors

The following table lists the sensors of your Dell Pro 14 PC14250.

**Table 27. Sensor**

Sensor support
Hall Effect sensor

## GPU—Integrated

The following table lists the specifications of the integrated Graphics Processing Unit (GPU) supported by your Dell Pro 14 PC14250.

**Table 28. GPU—Integrated**

Controller	Memory size	Processor
Intel UHD Graphics	Shared system memory	<ul style="list-style-type: none"> <li>Intel Processor U300E</li> <li>13<sup>th</sup> Generation Intel Core i3-1315U</li> </ul>
Intel Iris Xe Graphics	Shared system memory	<ul style="list-style-type: none"> <li>13<sup>th</sup> Generation Intel Core i5-1335U</li> <li>13<sup>th</sup> Generation Intel Core i5-1345U</li> </ul>
Intel Graphics	Shared system memory	<ul style="list-style-type: none"> <li>Intel Core 3 100U</li> <li>Intel Core 5 120U</li> <li>Intel Core 5 220U</li> <li>Intel Core 7 150U</li> <li>Intel Core 7 250U</li> <li>Intel Core Ultra 5 225U</li> <li>Intel Core Ultra 5 235U</li> <li>Intel Core Ultra 7 255U</li> <li>Intel Core Ultra 7 265U</li> </ul>

## Multiple display support matrix

The following table lists the multiple display support matrix for your Dell Pro 14 PC14250.

**Table 29. Multiple display support matrix**

Graphics Card	Direct Graphics Controller Direct Output Mode	Supported external displays with computer internal display on	Supported external displays with computer internal display off
Intel UHD Graphics	Integrated	3	4
Intel Iris Xe Graphics	Integrated	3	4
Intel Graphics	Integrated	3	4

## Hardware security

The following table lists the hardware security of your Dell Pro 14 PC14250.

**Table 30. Hardware security**

Hardware security
One wedge-shaped lock slot
Trusted Platform Module (TPM) 2.0 discrete
Mechanical camera privacy shutter
FIPS (Federal Information Processing Standards) 140-2 certification for Trusted Platform Module (TPM)
Contacted smart card and ControlVault 3 Plus
ControlVault 3 Plus with FIPS 140-3 Level 3 Certification
Trusted Computing Group (TCG) Certification for TPM

**Table 30. Hardware security (continued)**

<b>Hardware security</b>
Chassis Intrusion Detection
BIOS - TPM clear and/or system boot lock after chassis intrusion detection

## Smart card reader

### Contacted smart card reader

The following table lists the contacted smart card reader specifications of your Dell Pro 14 PC14250.

**NOTE:** The smart card reader is only available on selected configurations that are shipped with one of the following processors:

- Intel Core Ultra 5 235U
- Intel Core Ultra 7 255U
- Intel Core Ultra 7 265U

**Table 31. Contacted smart card reader specifications**

Standards	Description	Dell ControlVault 3 Plus smart card reader
ISO 7816 -3 Class A Card Support	Reader capable of reading 5 V powered smart card	Yes
ISO 7816 -3 Class B Card Support	Reader capable of reading 3 V powered smart card	Yes
ISO 7816 -3 Class C Card support	Reader capable of reading 1.8 V powered smart card	Yes
ISO 7816-1 Compliant	Specification for the reader	Yes
ISO 7816 -2 Compliant	Specification for smart card device physical characteristics (size, location of connection points, and so on)	Yes
T=0 support	Cards support character-level transmission	Yes
T=1 support	Cards support block-level transmission	Yes
EMVCo Compliant	Compliant with EMVCo (for electronic payment standards) smart card standards that are published on to <a href="http://www.emvco.com">www.emvco.com</a>	Yes
EMVCo Certified	Formally certified based on EMVCO smart card standards	Yes
PC/SC operating system interface	Personal computer or smart card specification for integration of hardware readers into personal computer environments	Yes
CCID driver compliance	Common driver support for the Integrated Circuit Card Interface Device for OS level drivers	Yes
Windows Certified	Device certified by Microsoft Windows Hardware Certification Kit (WHCK).	Yes

**Table 31. Contacted smart card reader specifications (continued)**

Standards	Description	Dell ControlVault 3 Plus smart card reader
FIPS 201 (PIV/HSPD-12) Compliant via GSA	Device compliant with FIPS 201/PIV/HSPD-12 requirements	Yes

## Operating and storage environment

This table lists the operating and storage specifications of your Dell Pro 14 PC14250.

**Airborne contaminant level:** G1 as defined by ISA-S71.04-1985

**Table 32. Computer environment**

Description	Operating	Storage
Temperature range	0°C to 40°C (32 °F to 104°F)	-40°C to 65°C (-40°F to 149°F)
Relative humidity (maximum)	90% (non-condensing)	95% (non-condensing)
Vibration (maximum)*	0.66 GRMS	Not applicable
Shock (maximum)	140 G†	Not applicable
Altitude range	-15.2 m to 3048 m (-49.87 ft to 10,000 ft)	-15.2 m to 10,668 m (-49.87 ft to 35,000 ft)
 <b>CAUTION: Operating and storage temperature ranges may differ among components, so operating or storing the device outside these ranges may impact the performance of specific components.</b>		

\* Measured using a random vibration spectrum that simulates the user environment.

† Measured using a 2 ms half-sine pulse.

## Dell Optimizer

Dell Optimizer is an application that is designed to enhance computer performance and productivity by optimizing settings for power, battery, display, and presence detection. It also provides access to applications purchased with your new computer.

For more information, see *Dell Optimizer User's Guide* at [Dell Support Site](#).

## Dell support policy

For information about Dell support policy, search [Dell Support Site](#).

## Dell low blue light display

 **WARNING: Prolonged exposure to blue light from the display may lead to long-term effects such as eye strain, eye fatigue, or damage to the eyes.**

Blue light is a color in the light spectrum which has a short wavelength and high energy. Chronic exposure to blue light, particularly from digital sources may disrupt sleep patterns and cause long-term effects such as eye strain, eye fatigue, or damage to the eyes.

The display on this computer is designed to minimize blue light and complies with TÜV Rheinland's requirement for low blue light displays.

Low blue light mode is enabled at the factory, so no further configuration is necessary.









To reduce the risk of eye strain, it is also recommended that you:

- Position the display at a comfortable viewing distance between 20 and 28 inches (50 cm and 70 cm) from your eyes.
- Blink frequently to moisten your eyes, wet your eyes with water, or apply suitable eye drops.
- Take an extended break for 20 minutes every two hours.
- Look away from your display, and gaze at a distant object at 20 ft (609.60 cm) away for at least 20 seconds during each break.

# Working inside your computer

## Safety instructions

Use the following safety guidelines to protect your computer from potential damage and to ensure your personal safety. Unless otherwise noted, each procedure in this document assumes that you have read the safety information that shipped with your computer.



-  **WARNING:** Before working inside your computer, read the safety information that is shipped with your computer. For more safety best practices, see [Dell Regulatory Compliance Home Page](#).
-  **WARNING:** Disconnect your computer from all power sources before opening the computer cover or panels. After you finish working inside the computer, replace all covers, panels, and screws before connecting your computer to an electrical outlet.
-  **WARNING:** For laptops, discharge the battery completely before removing it. Disconnect the AC power adapter from the computer and operate the computer solely on battery power—the battery is fully discharged when the computer no longer turns on when the power button is pressed.
-  **CAUTION:** To avoid damaging the computer, ensure that the work surface is flat, dry, and clean.
-  **CAUTION:** You should only perform troubleshooting and repairs as authorized or directed by the Dell technical support team. Damage due to servicing that is not authorized by Dell is not covered by your warranty.
-  **CAUTION:** Before touching anything inside your computer, ground yourself by touching an unpainted metal surface, such as the metal at the back of the computer. While you work, periodically touch an unpainted metal surface to dissipate static electricity which could harm internal components.
-  **CAUTION:** To avoid damaging the components and cards, handle them by their edges, and avoid touching the pins and the contacts.
-  **CAUTION:** When you disconnect a cable, pull it by its connector or its pull tab, not the cable itself. Some cables have connectors with locking tabs or thumbscrews that you must disengage before disconnecting the cable. When disconnecting cables, keep them evenly aligned to avoid bending the connector pins. When connecting cables, ensure that the connector on the cable is correctly oriented and aligned with the port.
-  **CAUTION:** Press and eject any installed card from the media-card reader.

## Before working inside your computer

### About this task

 **NOTE:** The images in this document may differ from your computer depending on the configuration you ordered.

### Steps

1. Save and close all open files and exit all open applications.
2. Shut down your computer. For Windows operating system, click **Start** >  **Power** > **Shut down**.  
 **NOTE:** If you are using a different operating system, see the documentation of your operating system for instructions.
3. Turn off all the attached peripherals.
4. Disconnect your computer from the electrical outlet.

5. Disconnect all attached network devices and peripherals, such as keyboard, mouse, and monitor from your computer.
6. Remove any media card and optical drive from your computer, if applicable.
7. To clean the air vents, use a soft brush and move vertically.

 **NOTE:** Do not remove the base cover or use any blower to clean the vents.

8. Enter the Service Mode.

### Service Mode

Service Mode is used to cut off power without disconnecting the battery cable from the system board before conducting repairs in the computer.

 **CAUTION:** If you are unable to turn on the computer to put it into Service Mode, disconnect the battery cable. To disconnect the battery cable, follow the steps in [Removing the battery](#).

 **NOTE:** Ensure that your computer is shut down and the power adapter is disconnected.

- a. Press and hold the B key and the power button for 3 seconds, or until the Dell logo appears on the screen.
- b. If the **Owner Tag** is set, it is displayed on the screen. Press any key to continue.

 **NOTE:** If the **Owner Tag** information is not already set, the computer automatically skips this step and proceeds to enter Service Mode.

- c. If the power adapter is still connected, a message appears on the screen prompting you to disconnect it. Disconnect the power adapter, then press any key to continue.
- d. When the **System Ready For Service** message appears on the screen, press any key to proceed. The computer emits three short beeps and shuts down immediately. The computer shuts down and enters the Service Mode.

## Safety precautions

This section details the primary steps to be followed before disassembling any device or component.

Observe the following safety precautions before any installation or break-fix procedures involving disassembly or reassembly:

- Turn off the computer and all attached peripherals.
- Disconnect the computer from AC power.
- Disconnect all network cables and peripherals from the computer.
- Use an ESD field service kit when working inside your computer to avoid electrostatic discharge (ESD) damage.
- Place the removed component on an anti-static mat after removing it from the computer.
- Press and hold the power button for 15 seconds to discharge the residual power in the system board.

## Bonding

Bonding is a method for connecting two or more grounding conductors to the same electrical potential. This is done by using a field service electrostatic discharge (ESD) kit. When connecting a bonding wire, ensure that it is connected to bare metal and never to a painted or nonmetal surface. Ensure that the wrist strap is secure and in full contact with your skin. Remove all jewelry, watches, bracelets, or rings before grounding yourself and the equipment.

## Electrostatic discharge—ESD protection

ESD is a major concern when you handle electronic components, especially sensitive components such as expansion cards, processors, memory modules, and system boards. A slight charge can damage circuits in ways that may not be obvious, such as intermittent problems or a shortened product life span. As the industry pushes for lower power requirements and increased density, ESD protection is an increasing concern.

Two recognized types of ESD damage are catastrophic and intermittent failures.

- **Catastrophic** – Catastrophic failures represent approximately 20 percent of ESD-related failures. The damage causes an immediate and complete loss of device functionality. An example of catastrophic failure is a memory module that has received a static shock and immediately generates a "No POST/No Video" symptom with a beep code that is emitted for missing or nonfunctional memory.

- **Intermittent** – Intermittent failures represent approximately 80 percent of ESD-related failures. The high rate of intermittent failures means that most of the time when damage occurs, it is not immediately recognizable. The memory module receives a static shock, but the tracing is merely weakened and does not immediately produce outward symptoms that are related to the damage. The weakened trace may take weeks or months to melt, and in the meantime may cause degradation of memory integrity, intermittent memory errors, and so on.

Intermittent failures that are also called latent or "walking wounded" are difficult to detect and troubleshoot.

Perform the following steps to prevent ESD damage:

- Use a wired ESD wrist strap that is properly grounded. Wireless anti-static straps do not provide adequate protection. Touching the chassis before handling parts does not ensure adequate ESD protection on parts with increased sensitivity to ESD damage.
- Handle all static-sensitive components in a static-safe area. If possible, use anti-static floor pads and workbench pads.
- When unpacking a static-sensitive component from its shipping carton, do not remove the component from the anti-static packing material until you are ready to install the component. Before unwrapping the anti-static packaging, use the anti-static wrist strap to discharge the static electricity from your body.

**i** **NOTE:** You can protect against ESD and discharge static electricity from your body by touching a metal-grounded object before you interact with anything electronic, for example, an unpainted metal surface on your computer's I/O panel. When connecting a peripheral (including handheld digital assistants) to your computer, you should always ground both yourself and the peripheral before connecting it to the computer. In addition, as you work inside the computer, periodically touch a metal-grounded object to remove any static charge that your body may have accumulated.

For more information about the wrist strap and ESD wrist strap tester, see [Components of an ESD Field Service Kit](#).

- Before transporting a static-sensitive component, place it in an anti-static container or packaging.

## ESD Field Service kit

The unmonitored field service kit is the most commonly used service kit. Each Field Service kit includes three main components: anti-static mat, wrist strap, and bonding wire.

**⚠ CAUTION: It is critical to keep ESD-sensitive devices away from internal parts that are insulated and often highly charged, such as plastic heat sink casings.**

## Working environment

Before the ESD Field Service kit is deployed, conduct an evaluation of the site to ensure proper setup and readiness. For example, deploying the kit for a server environment is different than for a desktop or laptop environment. Servers are typically installed in a rack within a data center; desktops or laptops are typically placed on office desks or cubicles. Always look for a large open flat work area that is free of clutter and large enough to deploy the ESD kit with additional space to accommodate the type of computer that is being repaired. The workspace should also be free of insulators that can cause an ESD event. On the work area, insulators such as styrofoam and other plastics should always be moved at least 12 inches or 30 centimeters away from sensitive parts before physically handling any hardware components.

## ESD packaging

All ESD-sensitive devices must be shipped and received in static-safe packaging. Metal, static-shielded bags are preferred. However, you should always return the damaged component using the same ESD bag and packaging that the new part arrived in. The ESD bag should be folded over and taped shut and all the same foam packing material should be used in the original box that the new part arrived in. ESD-sensitive devices should be removed from packaging only at an ESD-protected work surface, and parts should never be placed on top of the ESD bag because only the inside of the bag is shielded. Always place parts in your hand, on the anti-static mat, in the computer, or inside an ESD bag.

## Components of an ESD Field Service kit

The components of an ESD Field Service kit are:

- **Anti-Static Mat** – The anti-static mat is dissipative and parts can be placed on it during service procedures. When using an anti-static mat, your wrist strap should be snug and the bonding wire should be connected to the anti-static mat and to any bare metal on the computer being worked on. Once deployed properly, service parts can be removed from the ESD bag and

placed directly on the anti-static mat. ESD-sensitive items are safe in your hand, on the anti-static mat, in the computer, or inside an ESD bag.

- **Wrist Strap and Bonding Wire** – If an anti-static mat is not being used, the wrist strap and bonding wire should be connected directly between your wrist and an exposed metal part of the hardware. If you are using an anti-static mat, connect the wrist strap and bonding wire to the anti-static mat to ensure protection for any hardware placed on the mat. The physical connection of the wrist strap and bonding wire between your skin, the anti-static mat, and the hardware is known as bonding. Use only Field Service kits with a wrist strap, anti-static mat, and bonding wire. Never use wireless wrist straps. Always be cautious that the internal wires of a wrist strap are prone to damage from normal wear and tear, and must be checked regularly with a wrist strap tester in order to avoid accidental ESD hardware damage. It is recommended to test the wrist strap and bonding wire at least once per week.
- **ESD Wrist Strap Tester** – The wires inside an ESD strap are prone to damage over time. When using an unmonitored ESD kit, it is recommended to test the wrist strap regularly—ideally before each service session, and at a minimum, once per week. The most reliable method for testing is with a wrist strap tester. To perform the test, connect the bonding wire of the wrist strap to the tester while wearing the strap. Press the test button to initiate the check. A green LED indicates a successful test, while a red LED and audible alarm signal a failure.

**NOTE:** It is recommended to always use the traditional wired ESD grounding wrist strap and protective anti-static mat when servicing Dell products. In addition, it is critical to keep sensitive parts separate from all insulator parts while servicing the computer.

## Transporting sensitive components

When transporting ESD sensitive components such as replacement parts or parts to be returned to Dell, it is critical to place these parts in anti-static bags for safe transport.

## After working inside your computer

### About this task

**CAUTION:** Leaving stray or loose screws inside your computer may severely damage your computer.

### Steps

1. Replace all screws and ensure that no stray screws remain inside your computer.
2. Connect any external devices, peripherals, or cables you removed before working on your computer.
3. Replace any media cards, disks, or any other parts that you removed before working on your computer.
4. Connect your computer to their electrical outlets.

**NOTE:** To exit service mode, ensure to connect the AC adapter to the power-adapter port on your computer.

5. Press the power button to turn on the computer.

## Information on repairability for Québec - From Dell Canada Inc. - to Quebec consumers

Dell does not guarantee the availability of replacement parts, repair services, or information necessary for maintenance or repair.

## BitLocker

When updating the BIOS on a computer with BitLocker enabled, consider the following precautions.

**CAUTION:** If BitLocker is not suspended before updating the BIOS, the BitLocker key will not be recognized the next time that you reboot the computer. You are prompted to enter the recovery key to progress, and the computer displays a prompt for the recovery key on each reboot. If the recovery key is not known, this can

**result in data loss or an operating system reinstall. For more information, see Knowledge Article: [updating the BIOS on Dell computers with BitLocker enabled](#).**

The installation of the following components triggers BitLocker:

- Hard disk drive or solid state drive
- System board

## Recommended tools

The procedures in this document may require the following tools:

- Phillips screwdriver #0
- Phillips screwdriver #1
- Flat-head slotted screwdriver (less than 4 mm)
- Plastic scribe







## Screw list

**NOTE:** When removing screws from a component, it is recommended to note the screw type and the quantity of screws, and then place them in a screw storage box. This is to ensure that the correct number of screws and correct screw type is restored when the component is replaced.







**NOTE:** Some computers have magnetic surfaces. Ensure that the screws are not left attached to such surfaces when replacing a component.

**NOTE:** Screw color may vary depending on the configuration ordered.

**Table 33. Screw list**

Component	Screw type	Quantity	Screw torque strength	Screw image
Base cover	M2.5x6 (Captive)	9	2.55 kgf-cm to 3.45 kgf-cm	
Battery	M2x3 (Captive)	4	1.36 Kgf-cm to 1.84 Kgf-cm	
	M2x4	1	1.98 Kgf-cm to 2.42 Kgf-cm	
Solid state drive	M2x3	1	1.36 Kgf-cm to 1.84 Kgf-cm	
Wireless card	M2x3	1	1.36 Kgf-cm to 1.84 Kgf-cm	
Fan	M2x3	2	1.36 Kgf-cm to 1.84 Kgf-cm	
Power-adaptor port	M2.5x5	2	2.55 kgf-cm to 3.45 kgf-cm	

**Table 33. Screw list (continued)**

Component	Screw type	Quantity	Screw torque strength	Screw image
Heat sink	M2x5.4 (Captive)	4	1.36 Kgf-cm to 1.84 Kgf-cm	
I/O board	M2.5x5	2	2.55 kgf-cm to 3.45 kgf-cm	
	M2x3	3	1.36 Kgf-cm to 1.84 Kgf-cm	
Power button/Power button with fingerprint reader (optional)	M2x2	2	1.36 Kgf-cm to 1.84 Kgf-cm	
System board	M2.5x5	2	2.55 kgf-cm to 3.45 kgf-cm	
	M2x3	3	1.36 Kgf-cm to 1.84 Kgf-cm	
	M2x5	2	1.36 Kgf-cm to 1.84 Kgf-cm	
USB Type-C module	M2x5	3	1.36 Kgf-cm to 1.84 Kgf-cm	
Keyboard	M2x2.2	22	1.36 Kgf-cm to 1.84 Kgf-cm	
Keyboard support plate	M2x2.2	2 8	1.36 Kgf-cm to 1.84 Kgf-cm	
Display assembly	M2.5x5	4	2.55 kgf-cm to 3.45 kgf-cm	
Display-panel assembly	M2.5x2.5	4	2.55 kgf-cm to 3.45 kgf-cm	
	M2.5x3.5	4	2.55 kgf-cm to 3.45 kgf-cm	
Smart card reader	M2x2.2	4	1.36 Kgf-cm to 1.84 Kgf-cm	
USH board	M2x2	2	1.36 Kgf-cm to 1.84 Kgf-cm	

## Major components of Dell Pro 14 PC14250

The following image shows the major components of Dell Pro 14 PC14250.

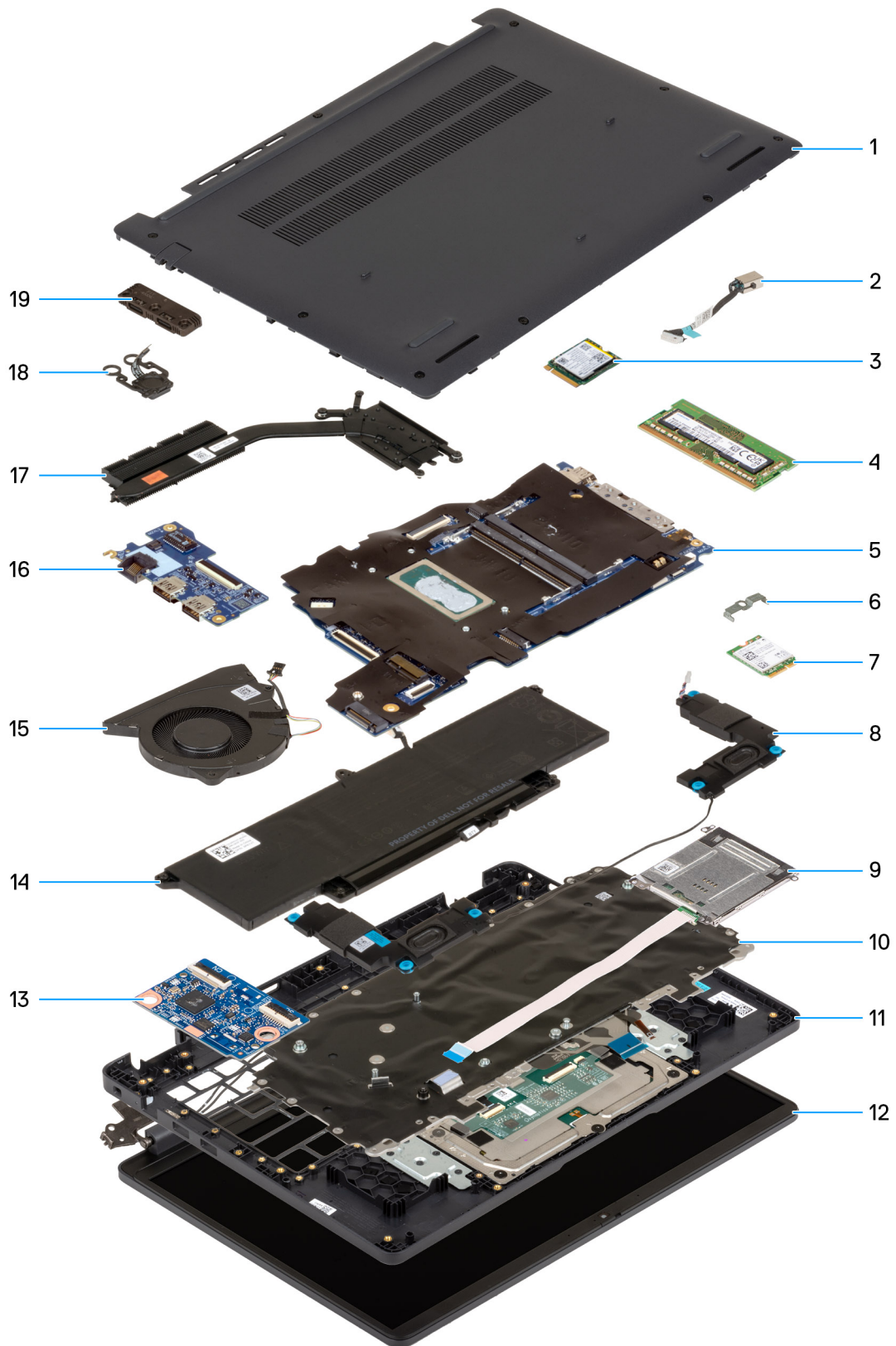

Figure 10. Major Components of your system/Exploded View

- 1. Base cover
- 2. Power-adaptor port

3. Solid state drive
4. Memory module
5. System board
6. Wireless-card bracket
7. Wireless card
8. Speakers
9. Smart card reader
10. Keyboard
11. Palmrest assembly
12. Display assembly
13. USH board
14. Battery
15. Fan
16. I/O board
17. Heat sink
18. Power button with fingerprint reader (optional)
19. USB Type-C module

**NOTE:** Dell provides a list of components and their part numbers for the original computer configuration purchased. These parts are available according to warranty coverage purchased by the customer. Contact your Dell sales representative for purchase options.

## Customer Replaceable Units (CRUs) and Field Replaceable Units (FRUs) list

The replaceable components in your Dell Pro 14 PC14250 are either Customer Replaceable Units (CRUs) or Field Replaceable Units (FRUs).

**CAUTION:** To avoid any potential damage to the component or loss of data, ensure that an authorized service technician replaces the Field Replaceable Units (FRUs). Customers can replace only the Customer Replaceable Units (CRUs) following the safety precautions and replacement procedures.

**Table 34. CRU and FRU list**

Customer Replaceable Units (CRU)	Field Replaceable Units (FRU)
Base cover	Power-adaptor port
Battery	Heat sink
Battery cable	I/O board
Memory module	I/O-board Flexible-Printed cable (FPC)
Solid state drive	vPro cable (For computers shipped with Intel Core Ultra 200U Series)
Wireless card	Power button
Wireless card bracket	Power button with fingerprint reader (optional)
Speakers	System board
Fan	USB Type-C module
	Keyboard
	Keyboard support plate
	Palm-rest assembly
	Display bezel
	Display-panel assembly

**Table 34. CRU and FRU list (continued)**

<b>Customer Replaceable Units (CRU)</b>	<b>Field Replaceable Units (FRU)</b>
	Camera
	Camera connector retention clip
	eDP cable
	Display back-cover assembly
	Smart card reader (For computers shipped with smart card reader)
	USH board (For computers shipped with smart card reader)
	USH board FPC cable (For computers shipped with smart card reader)

# Removing and installing Customer Replaceable Units (CRUs)

The replaceable components in this chapter are Customer Replaceable Units (CRUs).

 **CAUTION:** Customers can replace only the Customer Replaceable Units (CRUs) following the safety precautions and replacement procedures.

 **NOTE:** The images in this document may differ from your computer depending on the configuration you ordered.

## Base cover

### Removing the base cover

#### Prerequisites

1. Follow the procedure in [Before working inside your computer](#).

#### About this task

The following images indicate the location of the base cover and provide a visual representation of the removal procedure.



**9x**  
M2.5x6

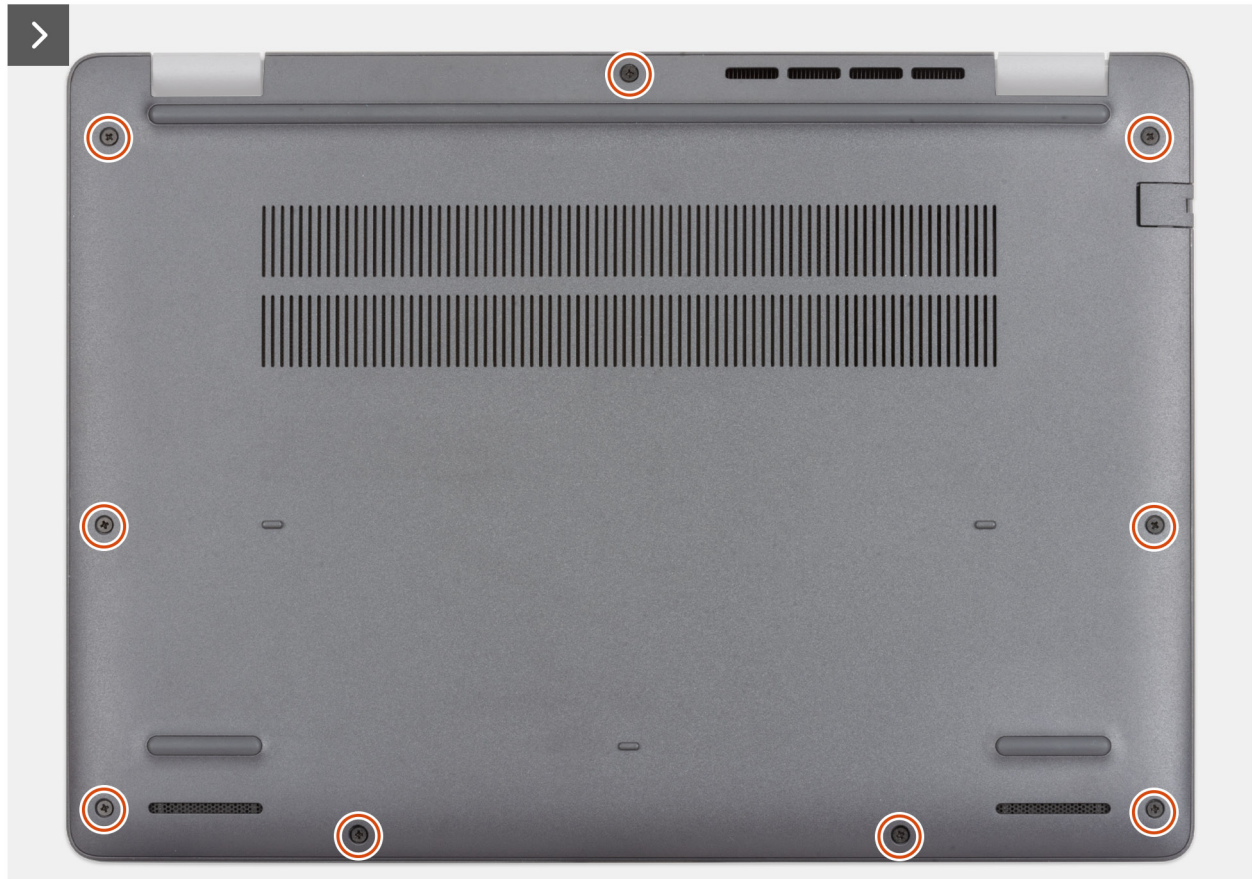

**Figure 11. Removing the base cover**

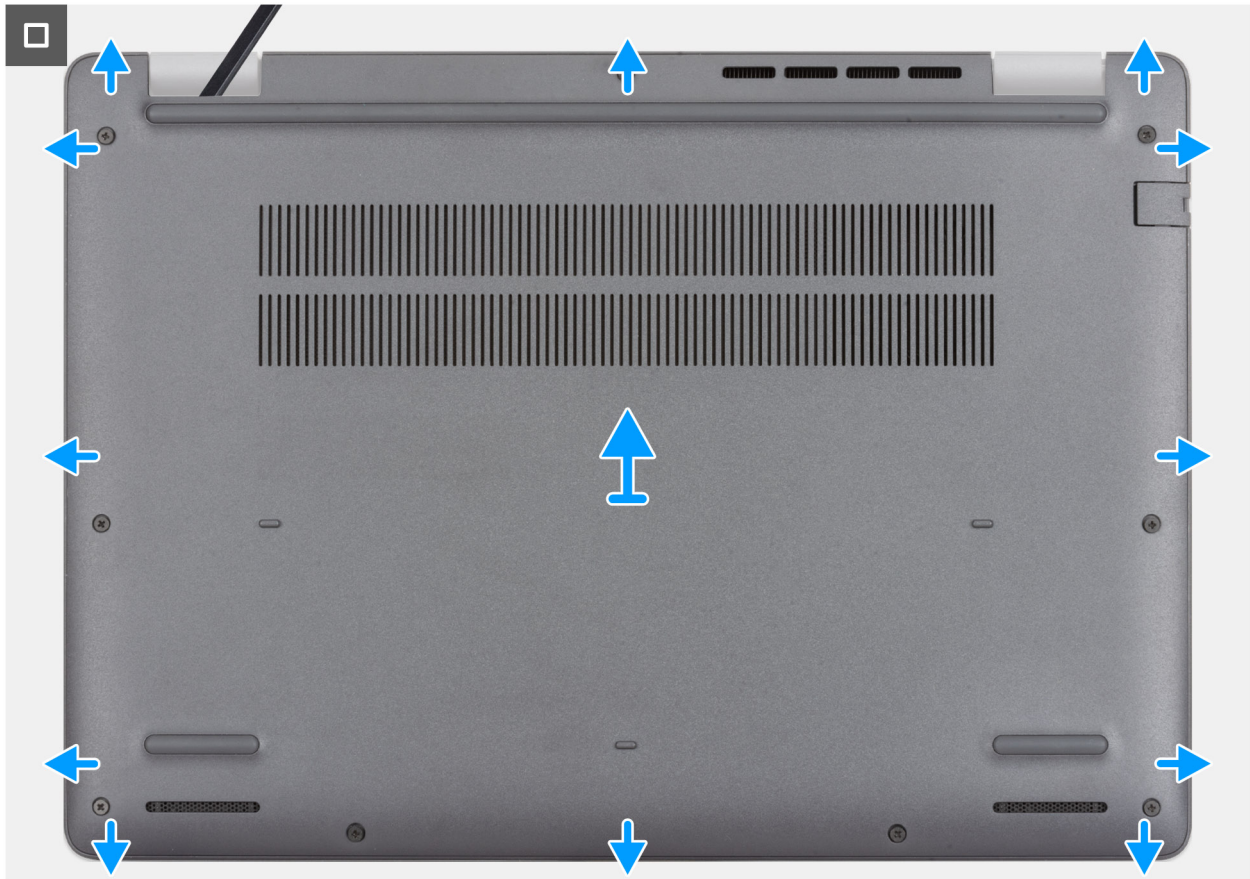

Figure 12. Removing the base cover

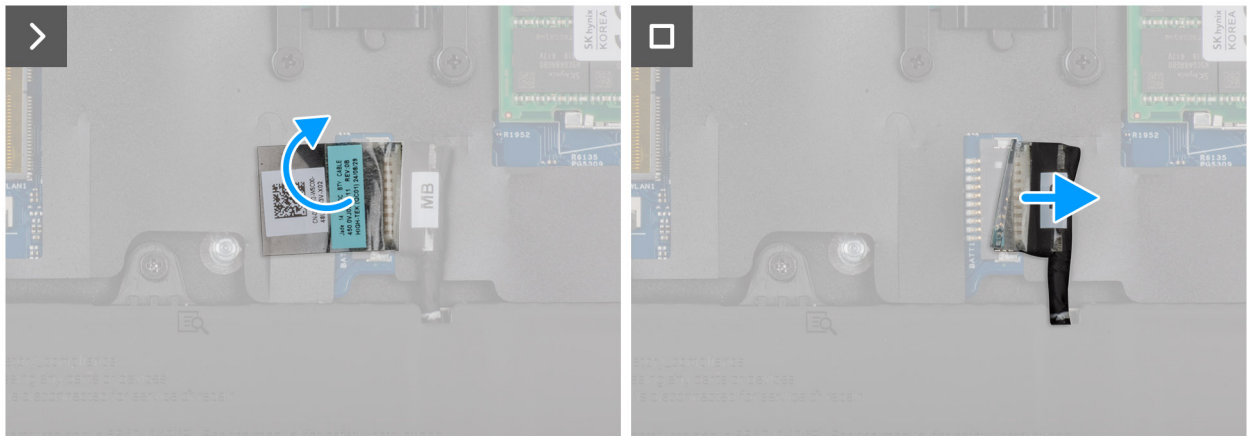

Figure 13. Disconnecting the battery cable

### Steps

1. Loosen the nine captive screws (M2.5x6) that secure the base cover to the chassis.
2. Using a plastic scribe, pry open the base cover starting from the U-shaped indents at the bottom edge of the base cover near the hinges.
3. Pry open the top side of the base cover, then continue along the sides to fully detach the base cover.
4. Lift and remove the base cover from the chassis.
  - i** **NOTE:** Ensure that your computer is in Service Mode. If your computer is unable to enter Service Mode, disconnect the battery cable from the system board. To disconnect the battery cable, follow step 5 to step 7.
5. Peel the tape that secures the battery cable to the battery.
6. Disconnect the battery cable from the battery cable connector (BATT1) on the system board.

7. Press and hold the power button for five seconds to ground the computer and drain the flea power.

## Installing the base cover

### Prerequisites

If you are replacing a component, remove the existing component before performing the installation procedure.

### About this task

The following images indicate the location of the base cover and provide a visual representation of the installation procedure.

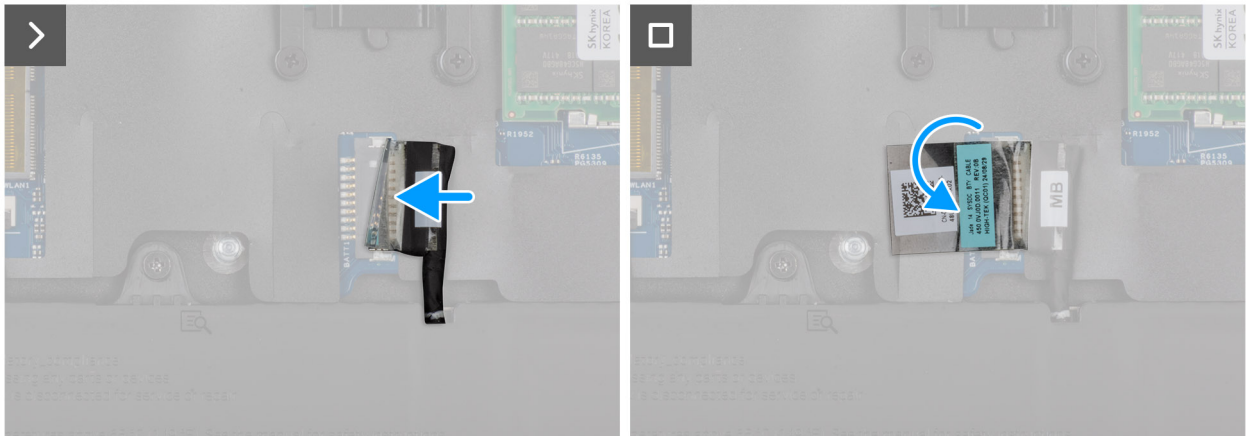

Figure 14. Connecting the battery cable



**9x**  
M2.5x6

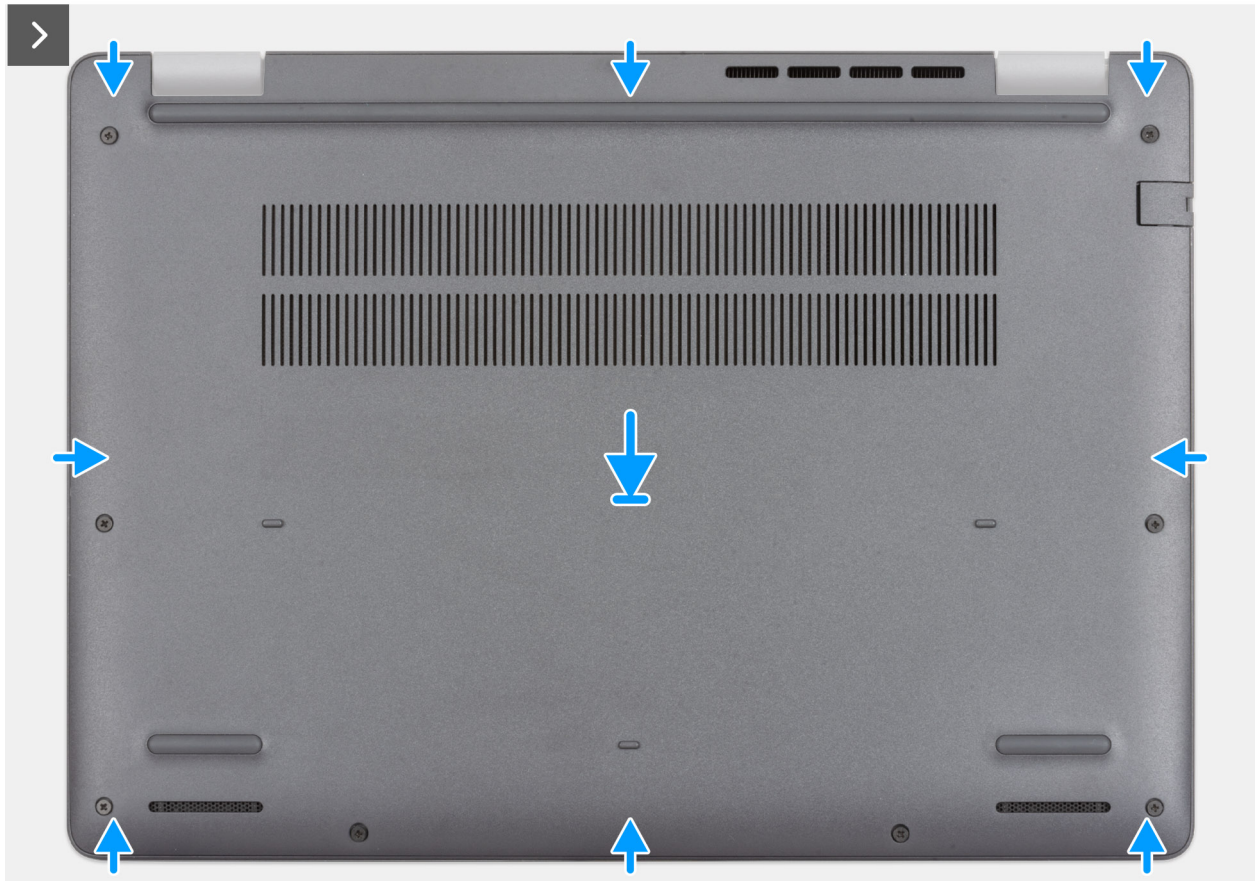

Figure 15. Installing the base cover



Figure 16. Installing the base cover

**NOTE:** If you have disconnected the battery cable, ensure to connect the battery cable. To connect the battery cable, follow step 1 in the procedure.

#### Steps

1. Connect the battery cable to the system board if the computer is not in service mode.
2. Align the screw holes on the base cover with the screw holes on the palm-rest assembly and snap the base cover into place.
3. Tighten the nine captive screws (M2.5x6) to secure the base cover to the palm-rest assembly.

#### Next steps

1. Follow the procedure in [After working inside your computer](#).

## Battery

### Rechargeable Li-ion battery precautions

#### **WARNING:**

- Exercise caution when handling rechargeable Li-ion batteries.
- Discharge the battery completely before removing it. Disconnect the AC power adapter from the computer and operate the computer solely on battery power—the battery is fully discharged when the computer no longer turns on when the power button is pressed.
- Do not crush, drop, mutilate, or penetrate the battery with foreign objects.
- Do not expose the battery to high temperatures, or disassemble battery packs and cells.

- Do not apply pressure to the surface of the battery.
- Do not bend the battery.
- Do not use tools of any kind to pry on or against the battery.
- To prevent accidental puncture or damage to the battery and other components, ensure that no screws are lost or misplaced during the servicing of the computer.
- Always purchase genuine batteries from [Dell Site](#) or authorized Dell partners and resellers.
- Swollen batteries should not be used and should be replaced and disposed properly. For guidelines on how to handle and replace swollen rechargeable Li-ion batteries, see [Handling swollen rechargeable Li-ion batteries](#).

## Removing the battery

### Prerequisites

1. Follow the procedure in [Before working inside your computer](#).
2. Remove the [base cover](#).

### About this task

 **CAUTION:** Removing the battery resets the BIOS setup settings to default. It is recommended that you note the BIOS setup settings before removing the battery.

The following image indicates the location of the battery and provides a visual representation of the removal procedure.

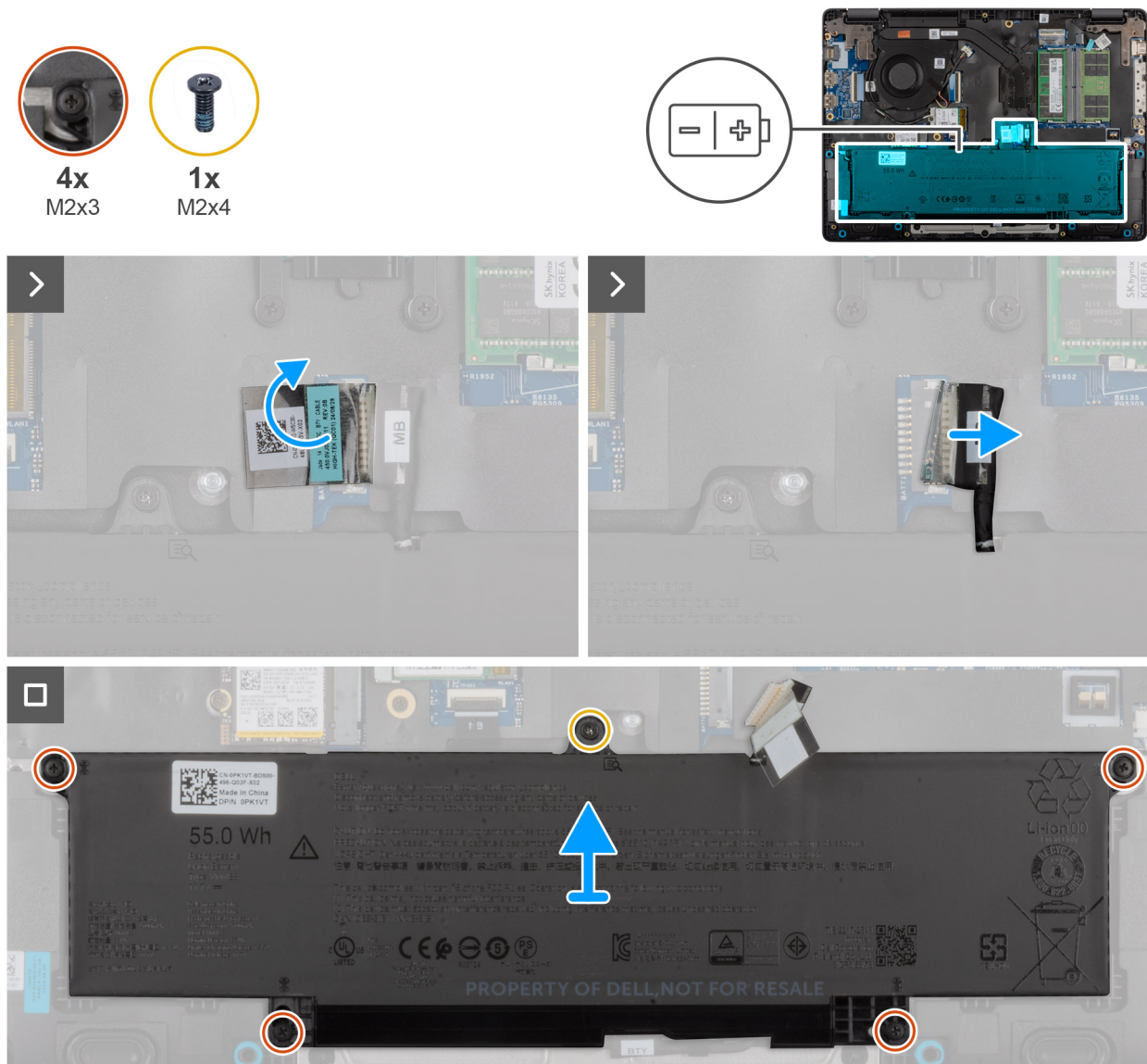

**Figure 17. Removing the battery**

**Steps**

1. Disconnect the battery cable from the battery cable connector (BATT1) on the system board.
2. Remove the screw (M2x4) that secures the battery to the palm-rest assembly.
3. Loosen the four captive screws (M2x3) that secure the battery to the palm-rest assembly.
4. Lift the battery off the palm-rest assembly.
5. If you are replacing the battery, remove the battery cable to transfer it to the replacement battery. For more information, see [Removing the battery cable](#).

## Installing the battery

**Prerequisites**

If you are replacing a component, remove the existing component before performing the installation procedure.

**About this task**

The following image indicates the location of the battery and provides a visual representation of the installation procedure.

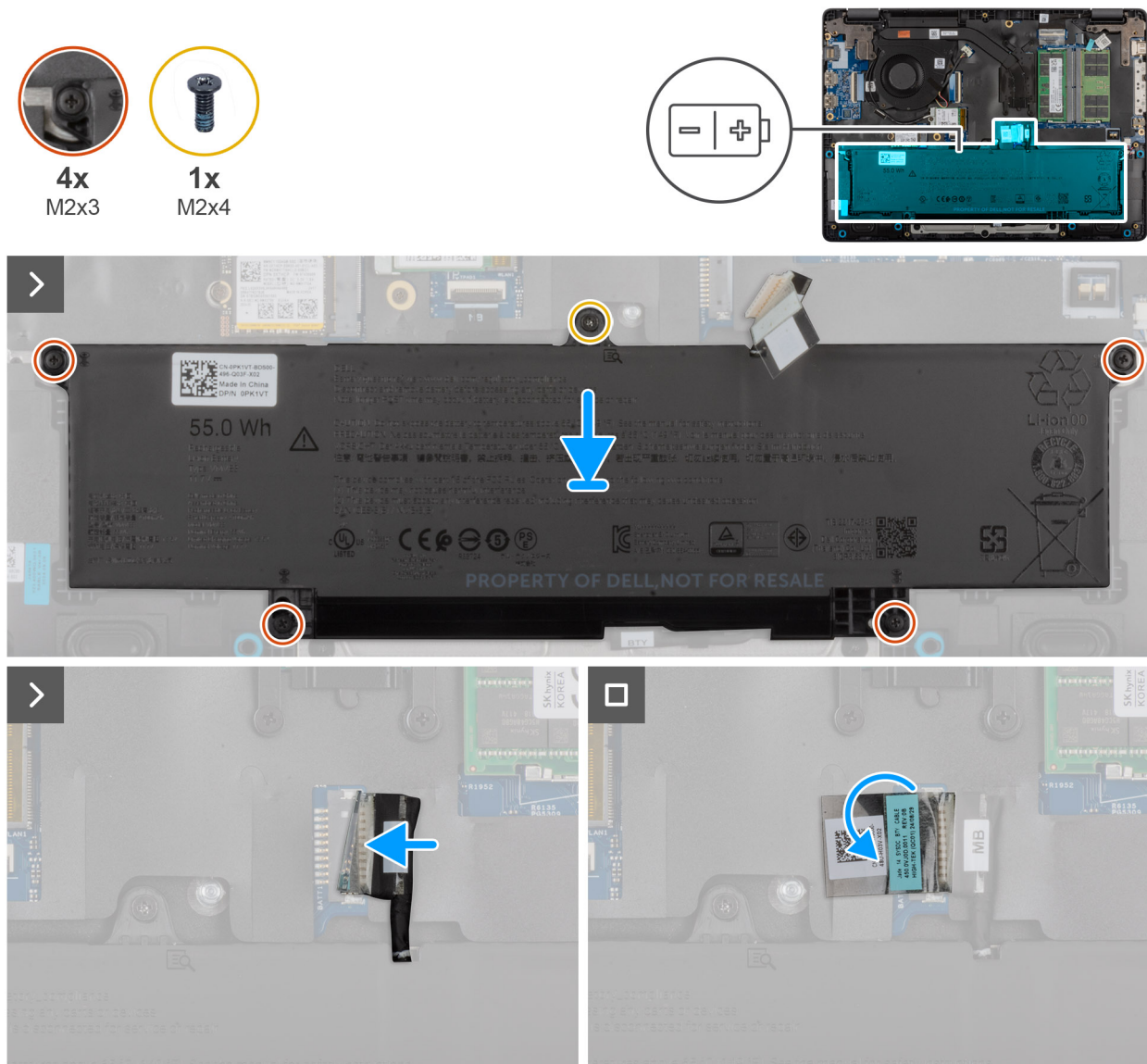

**Figure 18. Installing the battery**

**Steps**

1. If the battery cable was removed for replacing the battery, you must transfer the battery cable from the old battery to the replacement battery. For more information, see [Installing the battery cable](#).
2. Align the screw holes on the battery to the screw holes on the palm-rest assembly.
3. Tighten the four captive screws (M2x3) to secure the battery to the palm-rest assembly.
4. Replace the screw (M2x4) that secures the battery to the palm-rest assembly.
5. Connect the battery cable to the connector (BATT1) on the system board.

**Next steps**

1. Install the [base cover](#).
2. Follow the procedure in [After working inside your computer](#).

# Battery cable

## Removing the battery cable

### Prerequisites

1. Follow the procedure in [Before working inside your computer](#).
2. Remove the [base cover](#).
3. Remove the [battery](#).

### About this task

The following image indicates the location of the battery cable and provides a visual representation of the removal procedure.

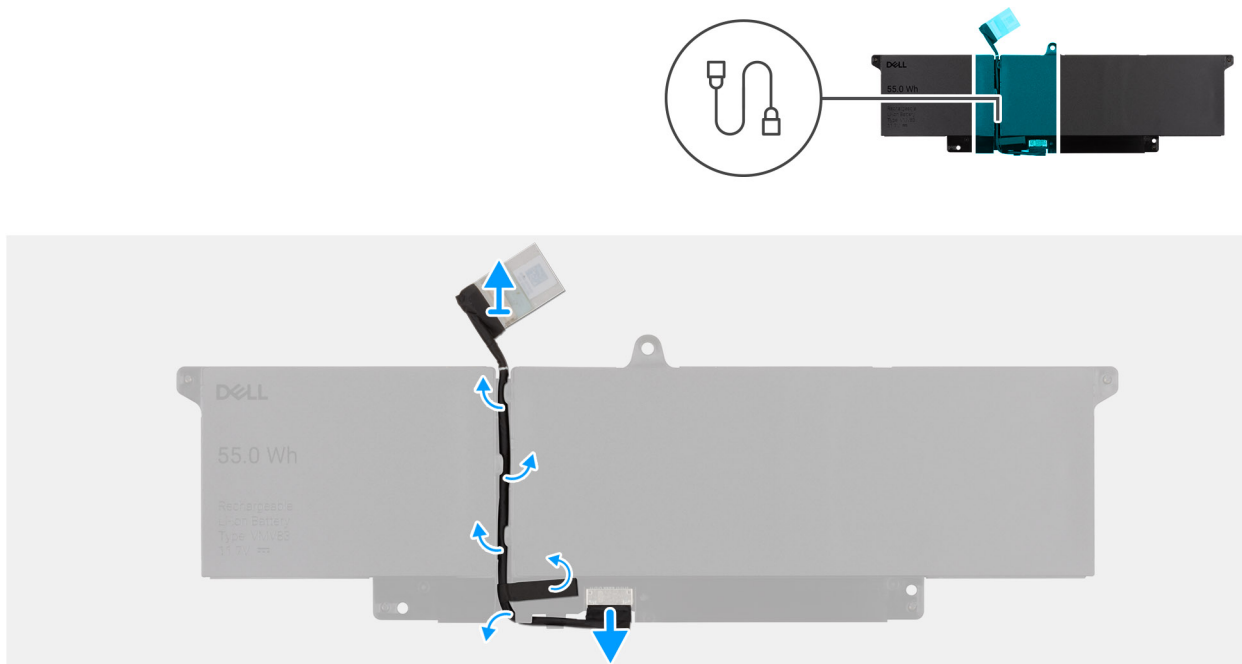

Figure 19. Removing the battery cable

### Steps

1. Unroute the battery cable from the routing guides on the battery.
2. Disconnect the battery cable from the connector on the battery.
3. Lift the battery cable away from the battery.

## Installing the battery cable

### Prerequisites

If you are replacing a component, remove the existing component before performing the installation procedure.

### About this task

The following image indicates the location of the battery cable and provides a visual representation of the installation procedure.

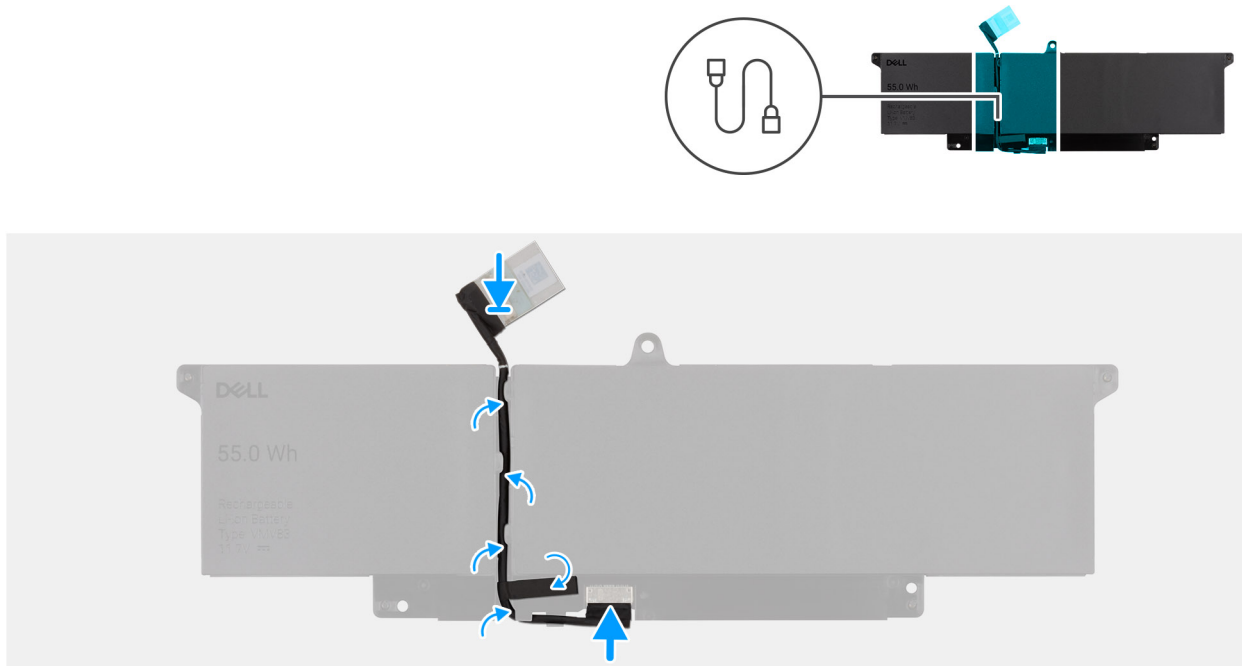

**Figure 20. Installing the battery cable**

#### Steps

1. Connect the battery cable to the connector on the battery.
2. Route the battery cable through the routing guides on the battery.

#### Next steps

1. Install the [battery](#).
2. Install the [base cover](#).
3. Follow the procedure in [After working inside your computer](#).

## Memory module

### Removing the memory module

#### Prerequisites

1. Follow the procedure in [Before working inside your computer](#).
2. Remove the [base cover](#).

#### About this task

The following image indicates the location of the memory module and provides a visual representation of the removal procedure.

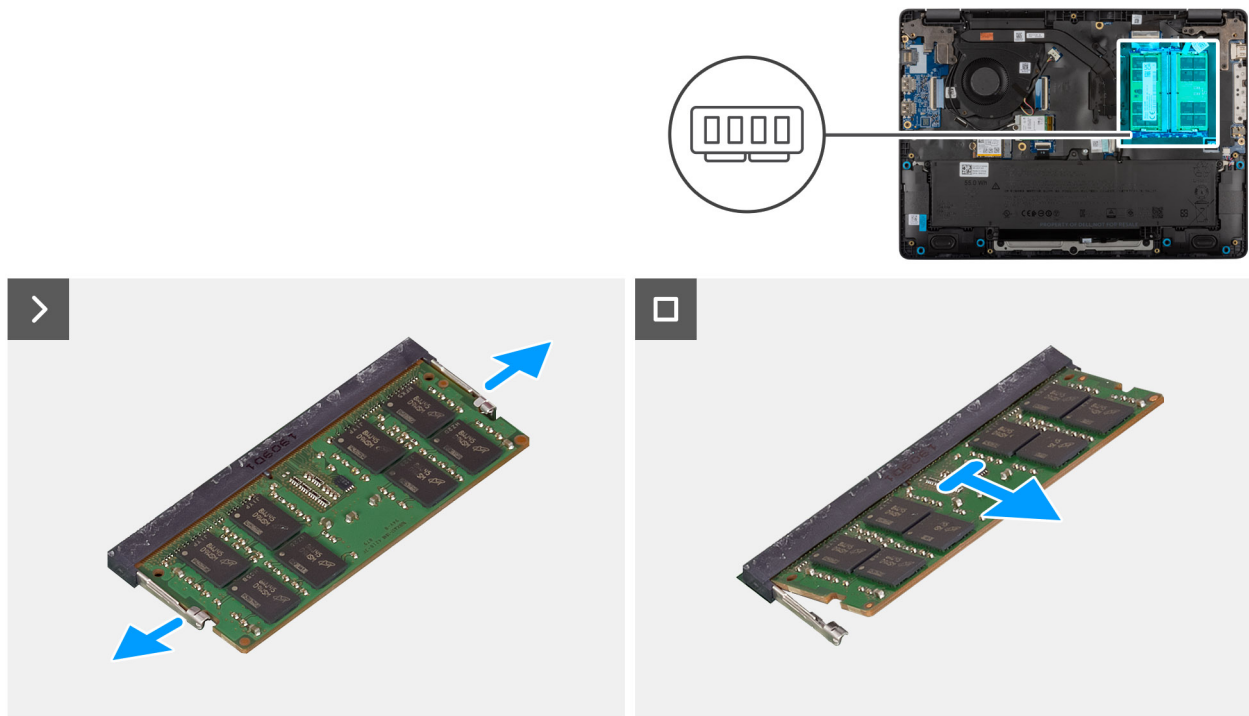

Figure 21. Removing the memory module

**Steps**

1. Pry the clips that secure the memory module until it pops up.
2. Remove the memory module from the slot.

**NOTE:** Repeat the steps if there is more than one memory module installed on your computer.

**CAUTION:** To prevent damage to the memory module, hold the memory module by the edges. Do not touch the components or metallic contacts on the memory module as electrostatic discharge (ESD) can inflict severe damage on the components. To read more about ESD protection, see [ESD protection](#).

## Installing the memory module

**Prerequisites**

If you are replacing a component, remove the existing component before performing the installation procedure.

**About this task**

The figure indicates the location of the memory module and provides a visual representation of the installation procedure.

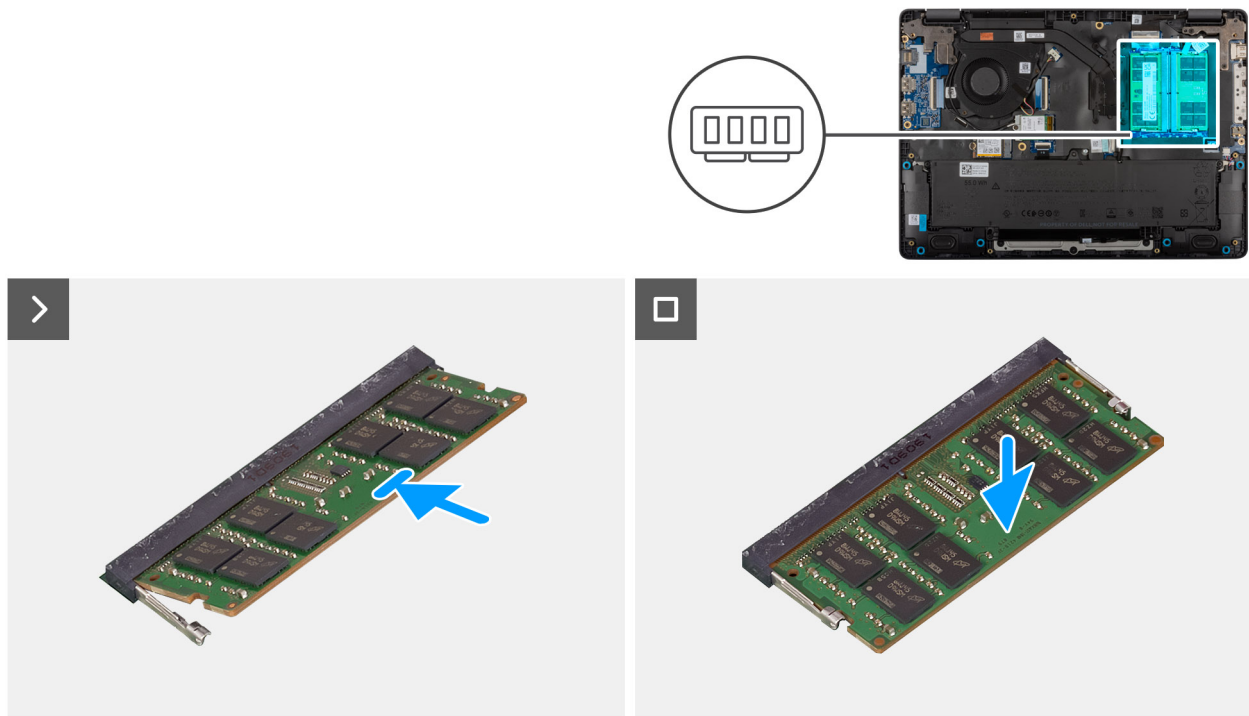

Figure 22. Installing the memory modules

### Steps

1. Align the notch on the memory module with the tab on the memory-module slot.
2. Slide the memory module firmly into the slot at an angle.
3. Press the memory module down until it clicks into place.

**i** **NOTE:** If you do not hear the click, remove the memory module and reinstall it.

**⚠ CAUTION:** To prevent damage to the memory module, hold the memory module by the edges. Do not touch the components or metallic contacts on the memory module as electrostatic discharge (ESD) can inflict severe damage on the components. To read more about ESD protection, see [ESD protection](#).

### Next steps

1. Install the [base cover](#).
2. Follow the procedure in [After working inside your computer](#).

## Solid state drive (SSD)

### Removing the solid state drive (SSD)

#### Prerequisites

1. Follow the procedure in [Before working inside your computer](#).
2. Remove the [base cover](#).

#### About this task

**i** **NOTE:** The procedures in this section apply only to computers shipped with a solid state drive (SSD). For computers shipped with UFS, the storage is integrated with the system board. Dell Technologies recommends that you back up your data regularly to avoid any potential data loss after a service incident. For more information, see the knowledge base article [000130154](#) at [Dell Support Site](#).

The following image indicates the location of the solid state drive (SSD) and provides a visual representation of the removal procedure.

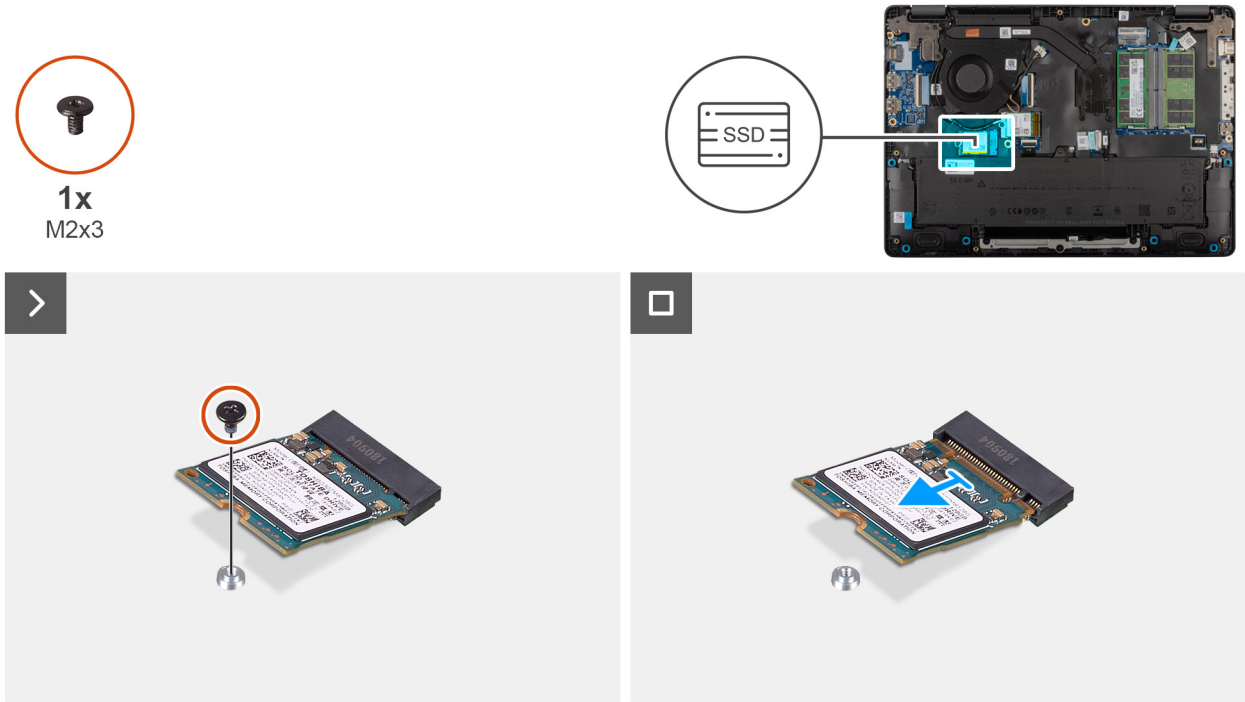

Figure 23. Removing the SSD

### Steps

1. Remove the screw (M2x3) that secures the SSD to the system board.
2. Slide and remove the SSD from the M.2 slot on the system board.

## Installing the solid state drive (SSD)

### Prerequisites

If you are replacing a component, remove the existing component before performing the installation procedure.

### About this task

**NOTE:** The procedures in this section apply only to computers shipped with a solid state drive (SSD). For computers shipped with UFS, the storage is integrated with the system board. Dell Technologies recommends that you back up your data regularly to avoid any potential data loss after a service incident. For more information, see the knowledge base article [000130154](https://www.dell.com/support/ articles/000130154) at [Dell Support Site](https://www.dell.com/support).

The following image indicates the location of the solid state drive (SSD) and provides a visual representation of the installation procedure.



1x  
M2x3

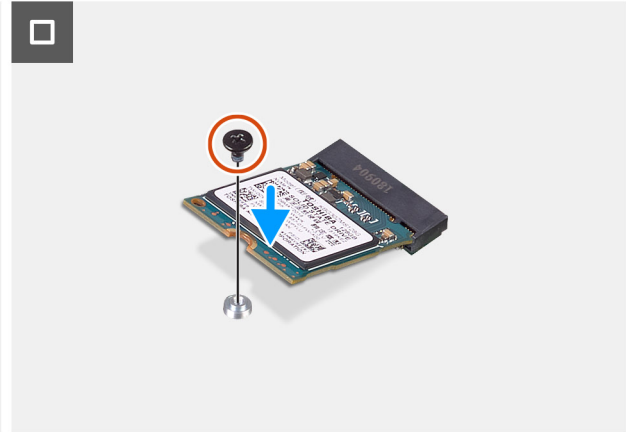
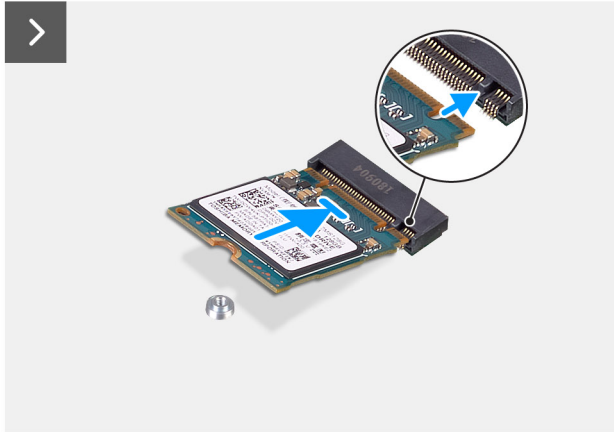
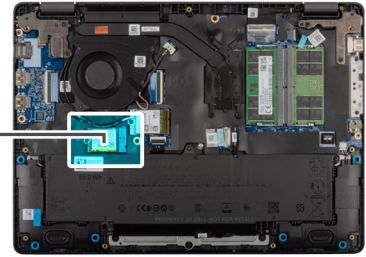

**Figure 24. Installing the SSD**

#### Steps

1. Align the notch on the SSD with the tab on the M.2 SSD slot on the system board.
2. Slide the SSD into the SSD slot on the system board.
3. Align the screw hole on the SSD with the screw hole on the palm-rest assembly.
4. Replace the screw (M2x3) that secures the SSD to the system board.

#### Next steps

1. Install the [base cover](#).
2. Follow the procedure in [After working inside your computer](#).

## Wireless Local Area Network (WLAN) card

### Removing the wireless card

#### Prerequisites

1. Follow the procedure in [Before working inside your computer](#).
2. Remove the [base cover](#).

#### About this task

The following image indicates the location of the wireless card and provides a visual representation of the removal procedure.



1x  
M2x3

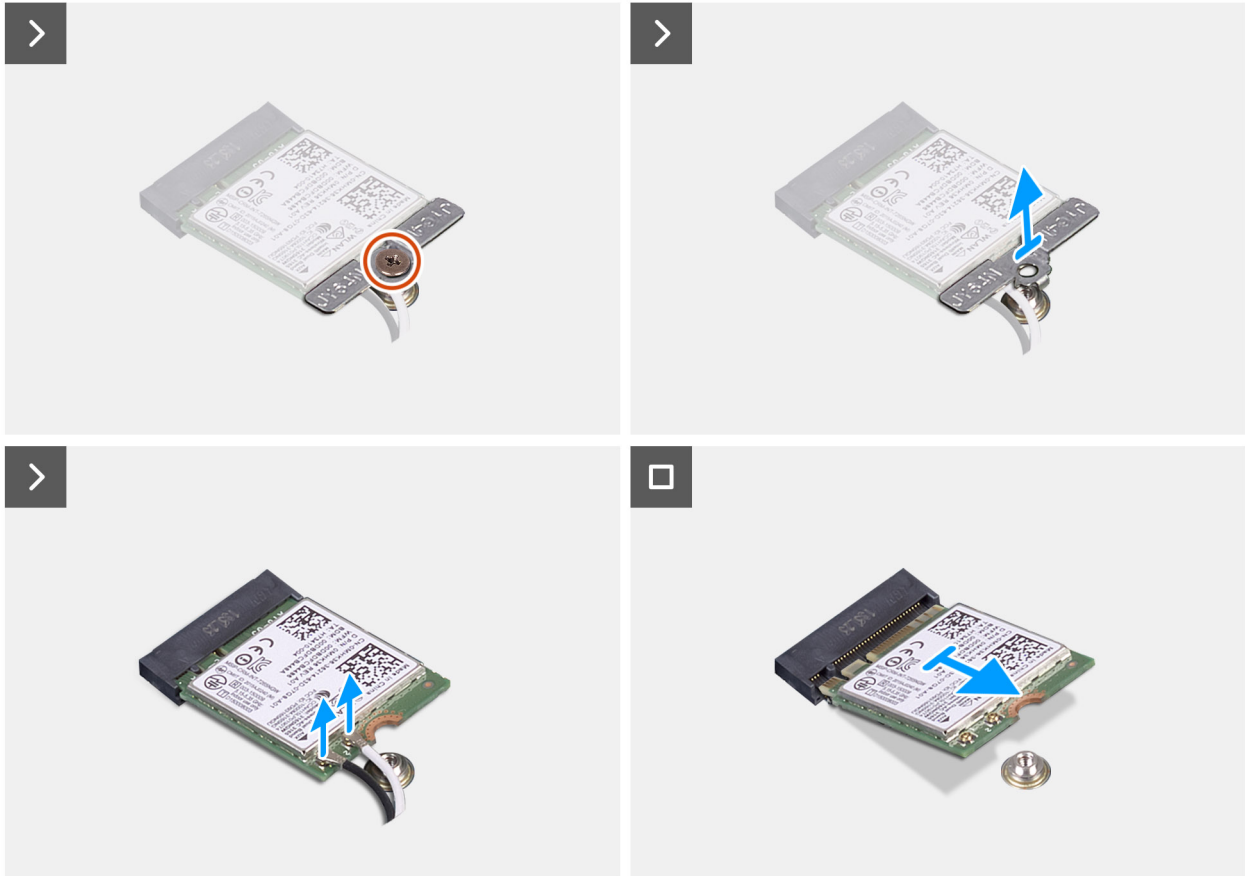
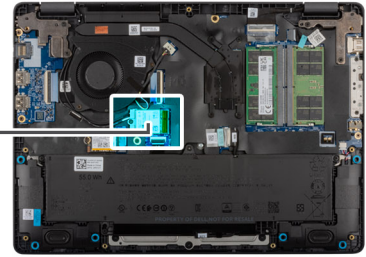

Figure 25. Removing the wireless card

### Steps

1. Remove the screw (M2x3) that secures the wireless-card bracket to the system board.
2. Lift the wireless-card bracket from the wireless card.
3. Disconnect the WLAN antenna cables from the wireless card.
4. Slide and remove the wireless card from the wireless-card slot.

## Installing the wireless card

### Prerequisites

If you are replacing a component, remove the existing component before performing the installation procedure.

### About this task

The following image indicates the location of the wireless card and provides a visual representation of the removal procedure.



1x  
M2x3

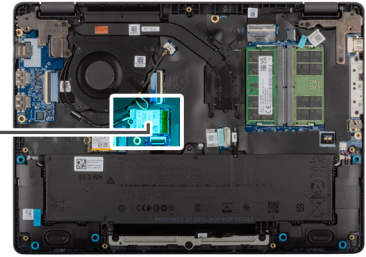

Figure 26. Installing the wireless card

### Steps

1. Connect the WLAN-antenna cables to the respective connectors on the wireless card.

The following table provides the antenna-cable color scheme for the wireless card that is supported for your computer.

Table 35. WLAN-antenna cable color scheme

Connectors on the wireless card	Antenna-cable color
Main - White triangle (△)	White cable
Auxiliary - Solid triangle (▲)	Black cable

2. Align the notch on the wireless card with the tab on the wireless-card slot.
3. Slide the wireless card at an angle into the wireless-card slot.
4. Place the wireless-card bracket on the wireless card.
5. Align the screw hole on the wireless-card bracket with the screw hole on the system board.
6. Replace the screw (M2x3) that secures the wireless-card bracket and the wireless card to the system board.

### Next steps

1. Install the [base cover](#).
2. Follow the procedure in [After working inside your computer](#).

## Speakers

### Removing the speakers

#### Prerequisites

1. Follow the procedure in [Before working inside your computer](#).
2. Remove the [base cover](#).

#### About this task

The following image indicates the location of the battery and provides a visual representation of the removal procedure.

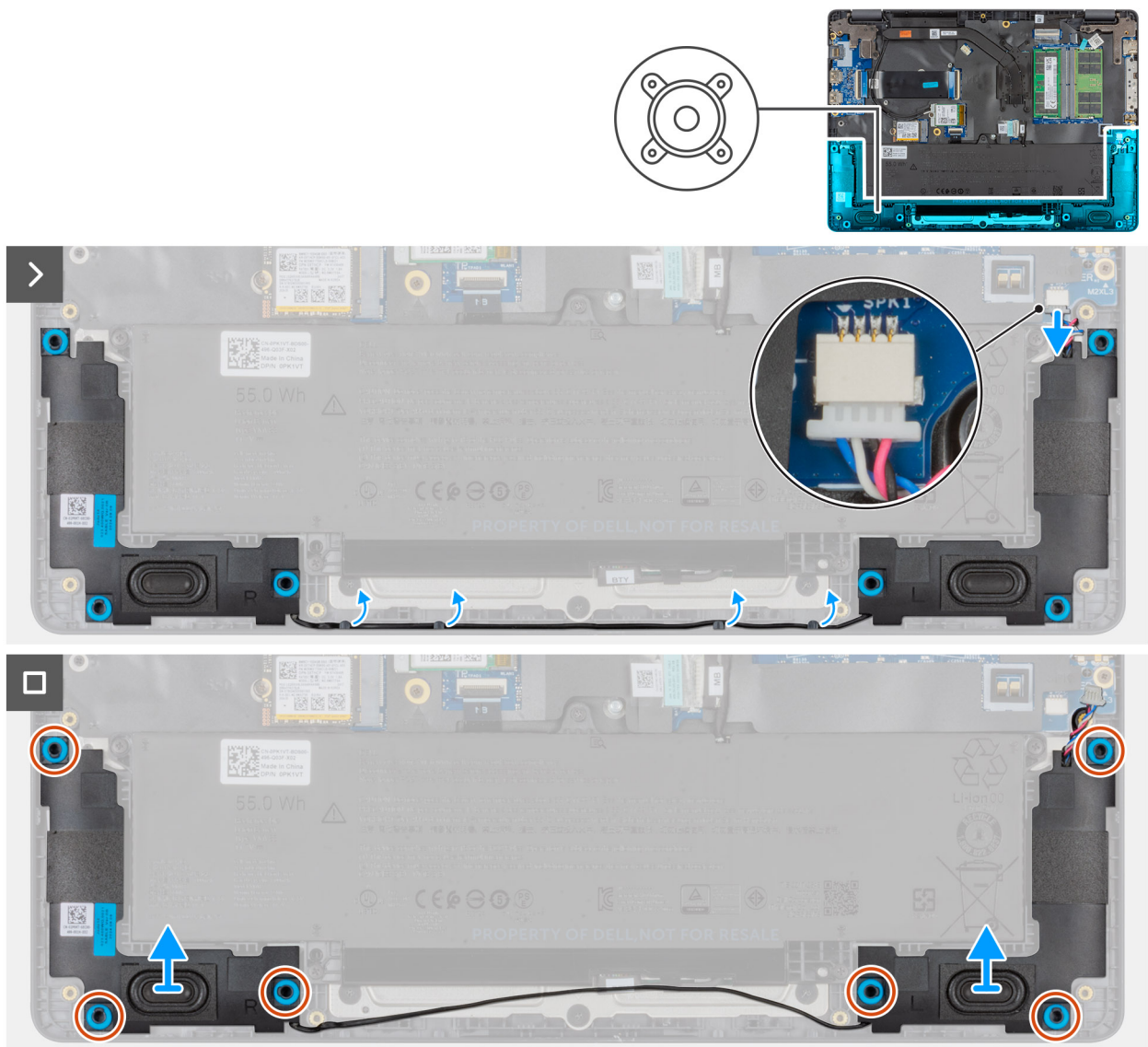

Figure 27. Removing the speakers

## Steps

1. Disconnect the speaker cable from the connector (SPK1) on the system board.
2. Unroute the speaker cable from the routing guides on the palm-rest assembly.
3. Remove the speakers from the palm-rest assembly.

## Installing the speakers

### Prerequisites

If you are replacing a component, remove the existing component before performing the installation procedure.

### About this task

**NOTE:** If the rubber grommets are pushed out when removing the speakers, push them back in place before replacing the speakers.

The following images indicate the location of the speakers and provide a visual representation of the installation procedure.

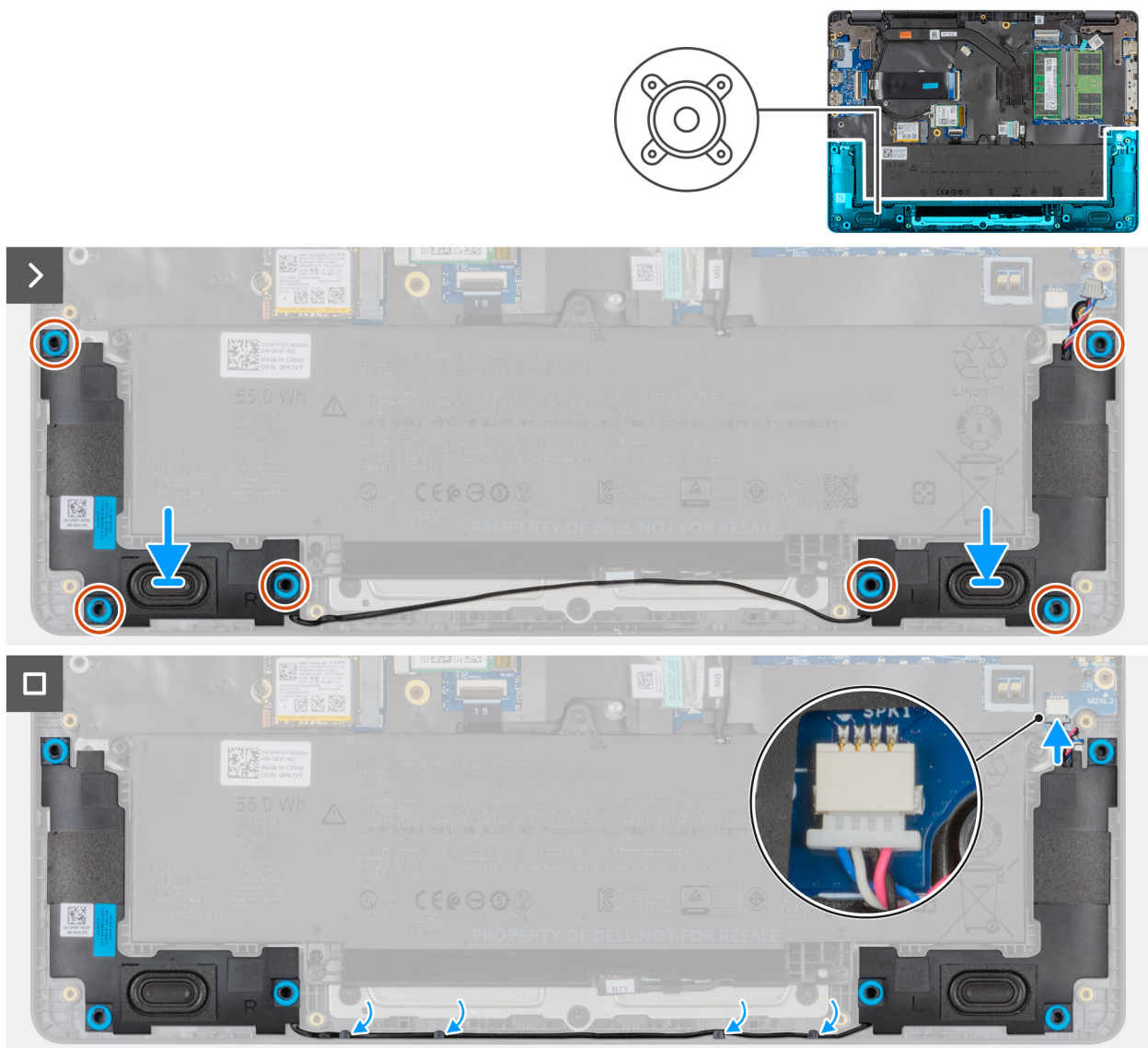
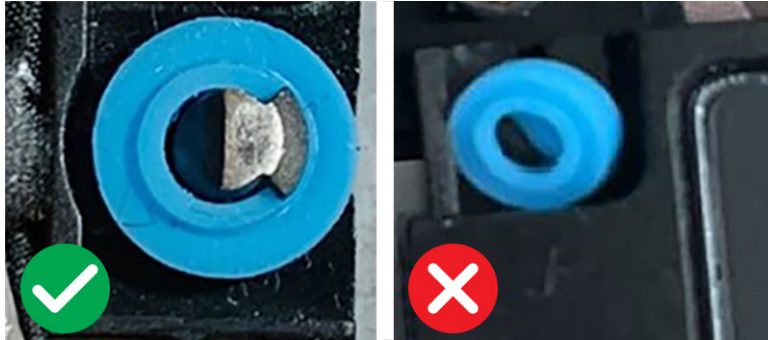

Figure 28. Installing the speakers

## Steps

1. Using the alignment posts, place the speakers into their slots on the palm-rest assembly.

**i** **NOTE:** Ensure that the rubber grommets are seated into the slot and installed on the speakers properly.



**Figure 29. Rubber grommets**

2. Route the speaker cables through the routing guides on the palm-rest assembly.
3. Connect the speaker cable to the connector (SPK1) on the system board.

## Next steps

1. Install the [base cover](#).
2. Follow the procedure in [After working inside your computer](#).

## Removing the speakers (For computers shipped with smart card reader)

### Prerequisites

1. Follow the procedure in [Before working inside your computer](#).
2. Remove the [base cover](#).

### About this task

The following image indicates the location of the battery and provides a visual representation of the removal procedure.

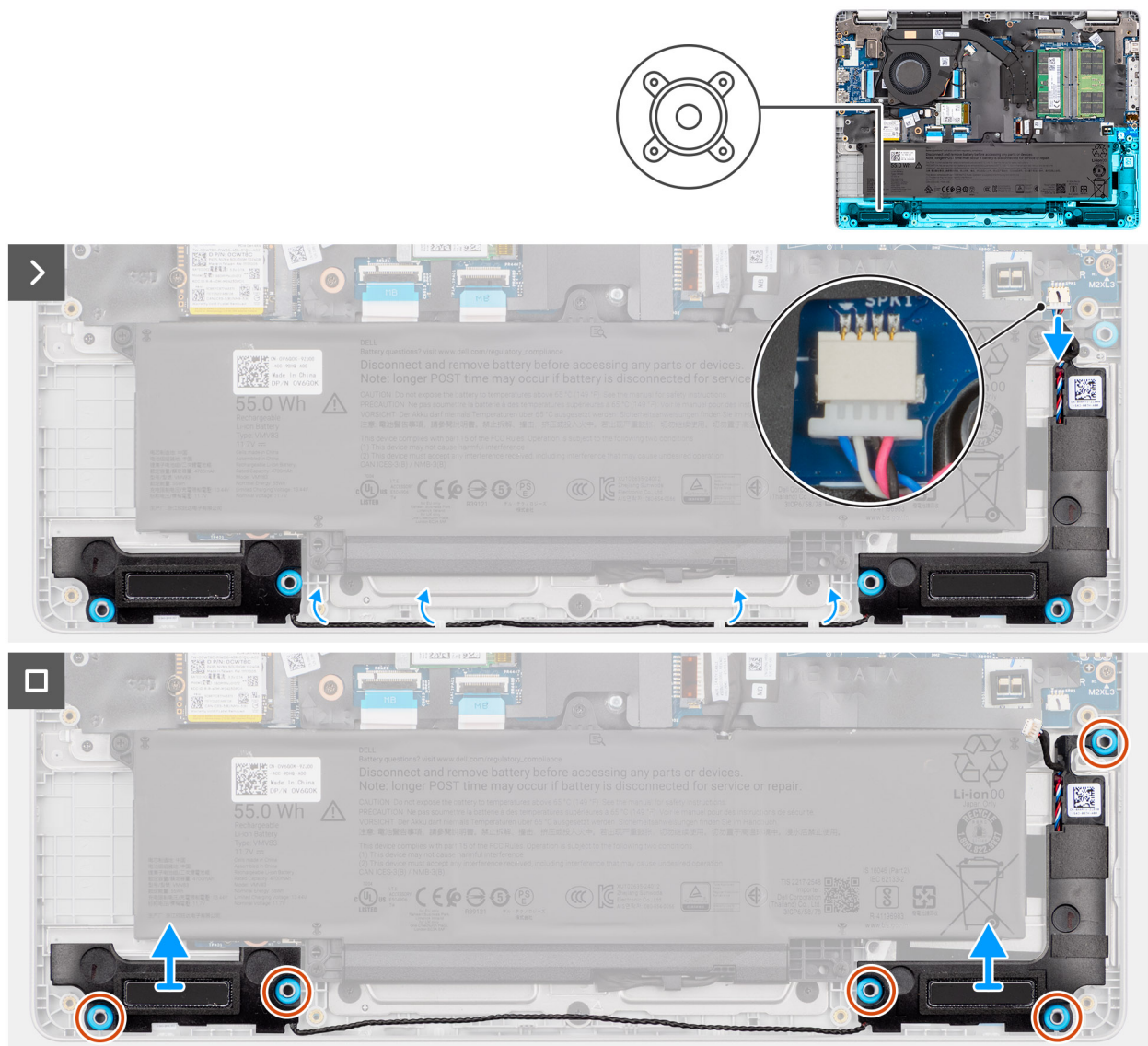

**Figure 30. Removing the speakers**

### Steps

1. Disconnect the speaker cable from the connector (SPK1) on the system board.
2. Unroute the speaker cable from the routing guides on the palm-rest assembly.
3. Remove the speakers from the palm-rest assembly.

## Installing the speakers (For computers shipped with smart card reader)

### Prerequisites

If you are replacing a component, remove the existing component before performing the installation procedure.

### About this task

**NOTE:** If the rubber grommets are pushed out when removing the speakers, push them back in place before replacing the speakers.

The following images indicate the location of the speakers and provide a visual representation of the installation procedure .

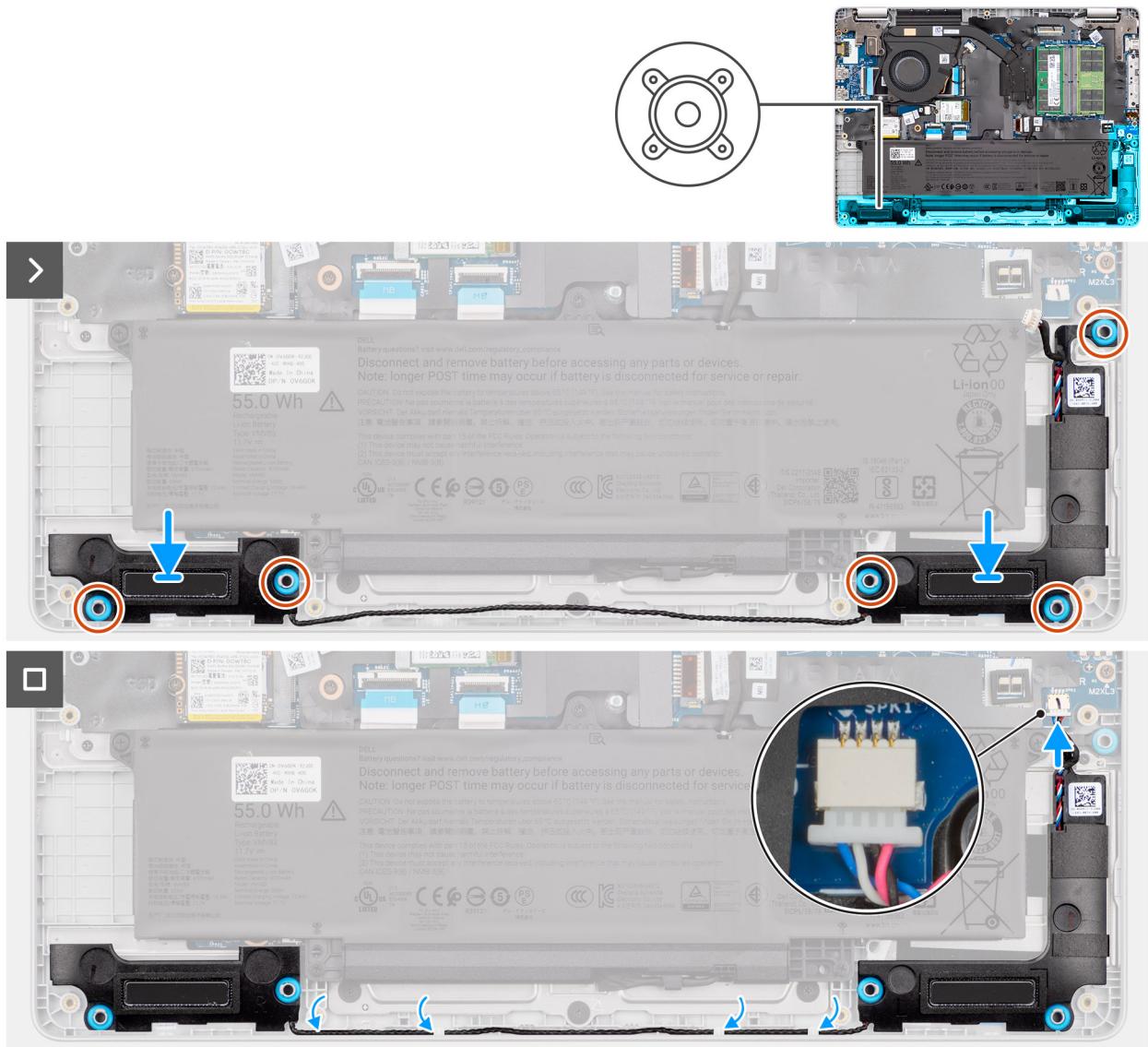

Figure 31. Installing the speakers

**Steps**

1. Using the alignment posts, place the speakers into their slots on the palm-rest assembly.

**NOTE:** Ensure that the rubber grommets are seated into the slot and installed on the speakers properly.



Figure 32. Rubber grommets

2. Route the speaker cables through the routing guides on the palm-rest assembly.

3. Connect the speaker cable to the connector (SPK1) on the system board.

#### Next steps

1. Install the [base cover](#).
2. Follow the procedure in [After working inside your computer](#).

## Fan

### Removing the fan

#### Prerequisites

1. Follow the procedure in [Before working inside your computer](#).
2. Remove the [base cover](#).

#### About this task

The following image indicates the location of the fan and provides a visual representation of the removal procedure.

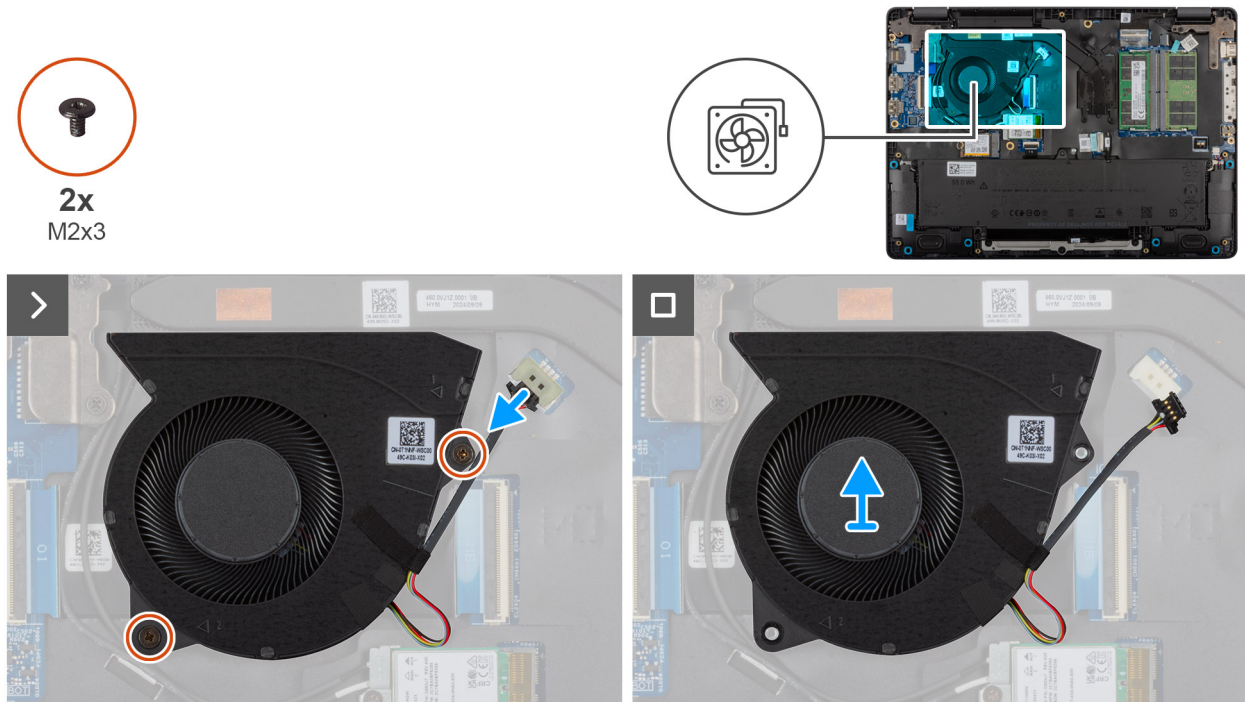

Figure 33. Removing the fan

#### Steps

1. Disconnect the fan cable from the connector (FAN1) on the system board.
2. Remove the two screws (M2x3) that secure the fan to the system board.
3. Lift and remove the fan from the system board.

### Installing the fan

#### Prerequisites

If you are replacing a component, remove the existing component before performing the installation procedure.

### About this task

The following image indicates the location of the fan and provides a visual representation of the installation procedure.

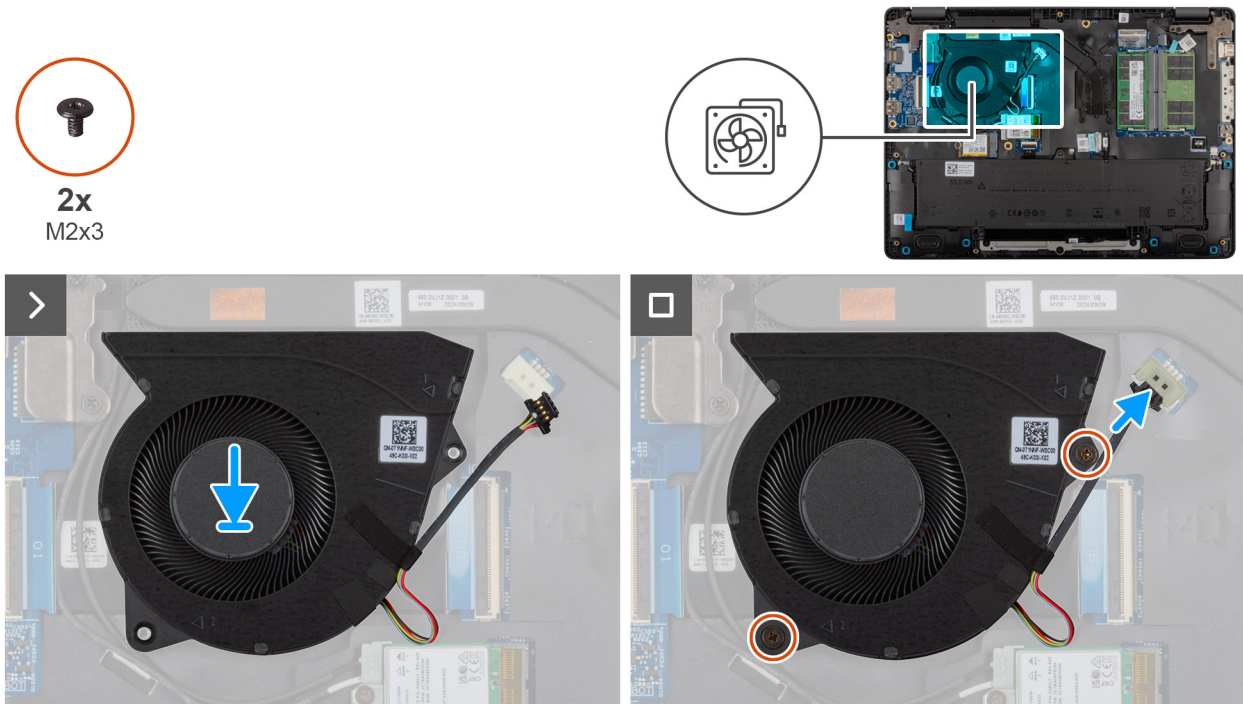

**Figure 34. Installing the fan**

### Steps

1. Place and align the screw holes on the fan with the screw holes on the system board.
2. Replace the two screws (M2x3) that secure the fan to the system board.
3. Connect the fan cable to the connector (FAN1) on the system board.

### Next steps

1. Install the [base cover](#).
2. Follow the procedure in [After working inside your computer](#).

# Removing and installing Field Replaceable Units (FRUs)

The replaceable components in this chapter are Field Replaceable Units (FRUs).

**CAUTION:** The information in this section is intended for authorized service technicians only.

**CAUTION:** To avoid any potential damage to the component or loss of data, ensure that an authorized service technician replaces the Field Replaceable Units (FRUs).

**CAUTION:** Dell Technologies recommends that these procedures be performed by trained technical repair specialists.

**CAUTION:** Your warranty does not cover damages that may occur during FRU repairs that are not authorized by Dell Technologies.

**NOTE:** The images in this document may differ from your computer depending on the configuration you ordered.

## USH board FPC

### Removing the USH board FPC (For computers shipped with smart card reader)

#### Prerequisites

1. Follow the procedure in [Before working inside your computer](#).
2. Remove the [base cover](#).
3. Remove the [battery](#).

#### About this task

The following image indicates the location of the USH board FPC and provides a visual representation of the removal procedure.

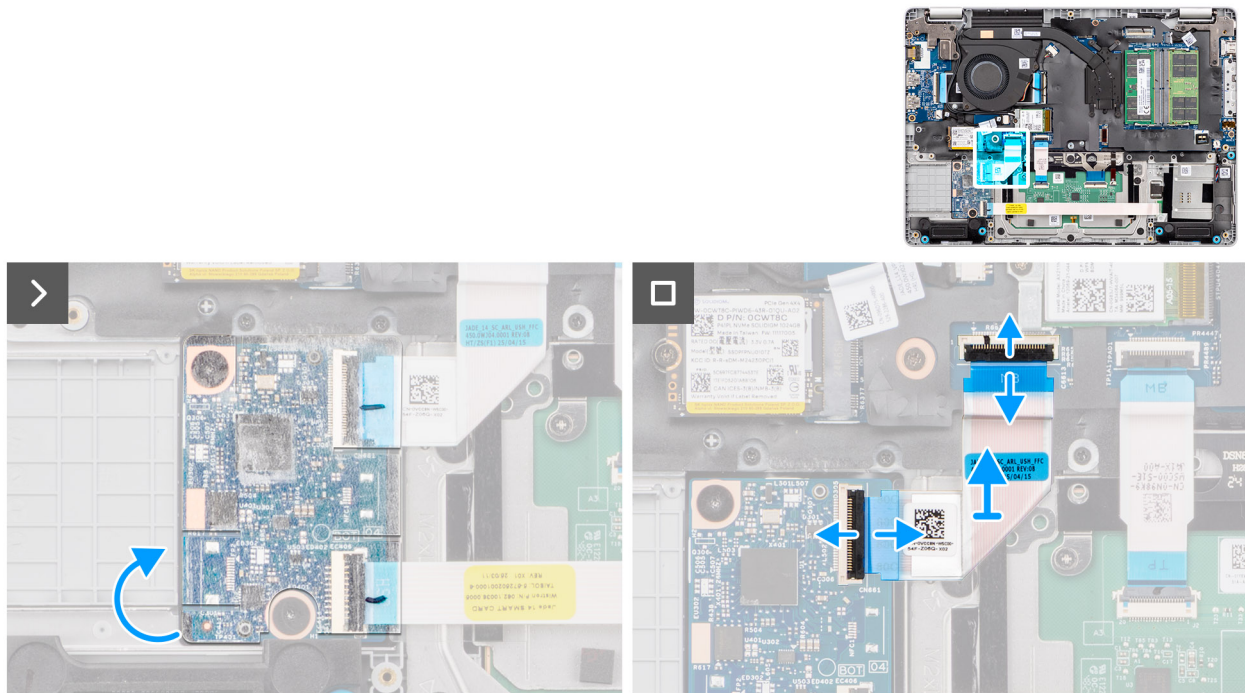

**Figure 35. Removing the USH board FPC**

**Steps**

1. Peel off the protective film from the USH board .
2. Open the latch and disconnect the USH board FPC from the connector (C6613) on the system board.
3. Open the latch and disconnect the USH board FPC from the connector (CN661) on the USH board.
4. Lift the USH board FPC off the palm-rest assembly.

## Installing the USH board FPC (For computers shipped with smart card reader)

**Prerequisites**

If you are replacing a component, remove the existing component before performing the installation procedure.

**About this task**

The following image indicates the location of the USH board FPC and provides a visual representation of the installation procedure.

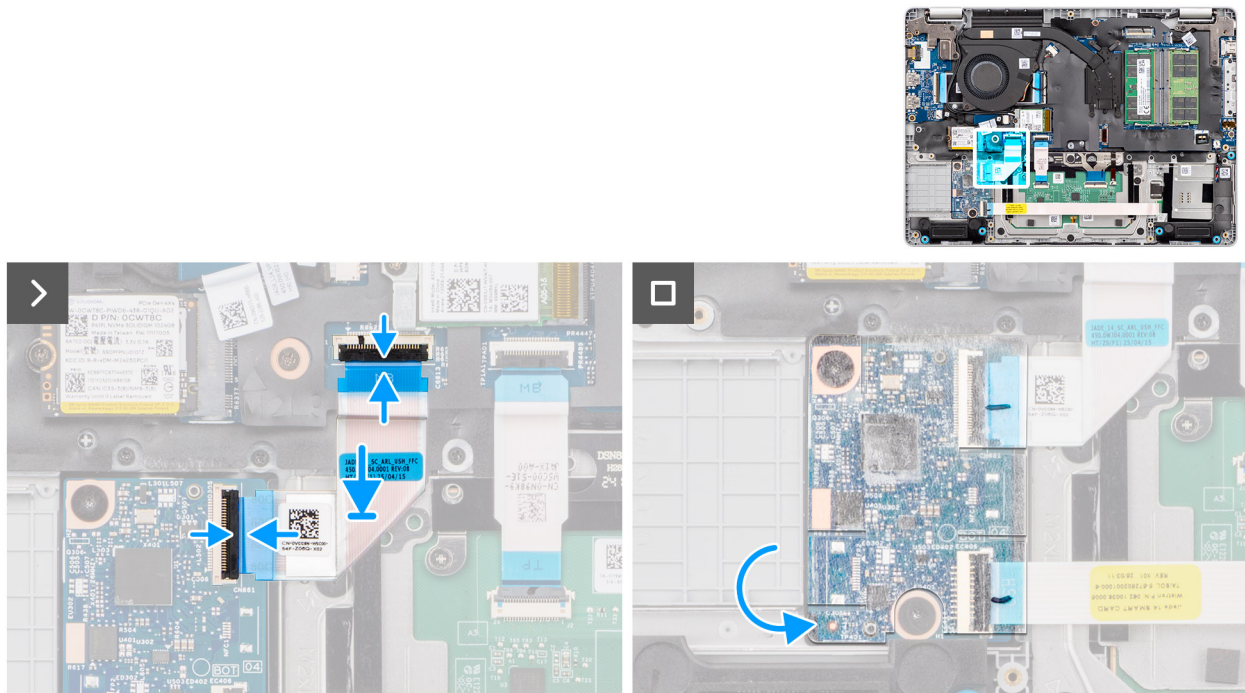

**Figure 36. Installing the USH board FPC**

**Steps**

1. Connect the USH board FPC to the connector (C6613) on the system board.
2. Connect the USH board FPC to the connector (CN661) on the USH board.
3. Replace the protective film over the USH board.

**Next steps**

1. Install the [battery](#).
2. Install the [base cover](#).
3. Follow the procedure in [After working inside your computer](#).

## USH board

### Removing the USH board (For computers shipped with smart card reader)

**Prerequisites**

1. Follow the procedure in [Before working inside your computer](#).
2. Remove the [base cover](#).
3. Remove the [battery](#).

**About this task**

The following image indicates the location of the USH board and provides a visual representation of the removal procedure.



2x  
M2x2

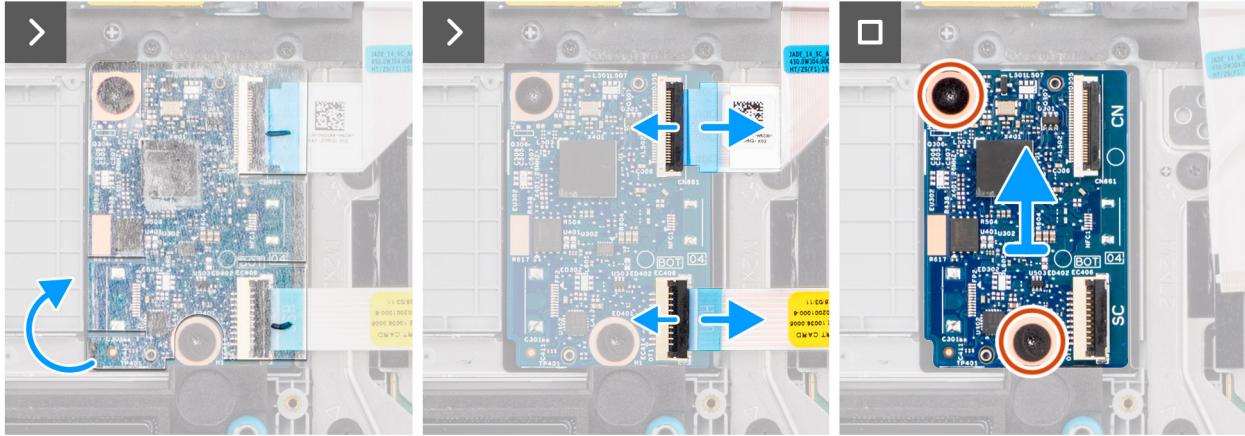
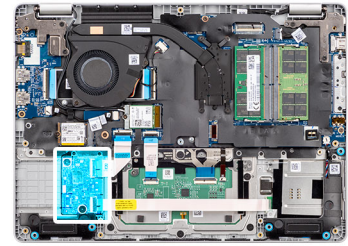

Figure 37. Removing the USH board

#### Steps

1. Peel off the protective film from the USH board.
2. Open the latch and disconnect the USH board FPC from the connector (CN661) on the USH board.
3. Open the latch and disconnect the smart card reader cable from the connector (EC406) on the USH board.
4. Remove the two screws (M2x2) that secure the USH board to the palm-rest assembly.
5. Lift the USH board off the palm-rest assembly.

## Installing the USH board (For computers shipped with smart card reader)

#### Prerequisites

If you are replacing a component, remove the existing component before performing the installation procedure.

#### About this task

The following image indicates the location of the USH board and provides a visual representation of the installation procedure.



2x  
M2x2

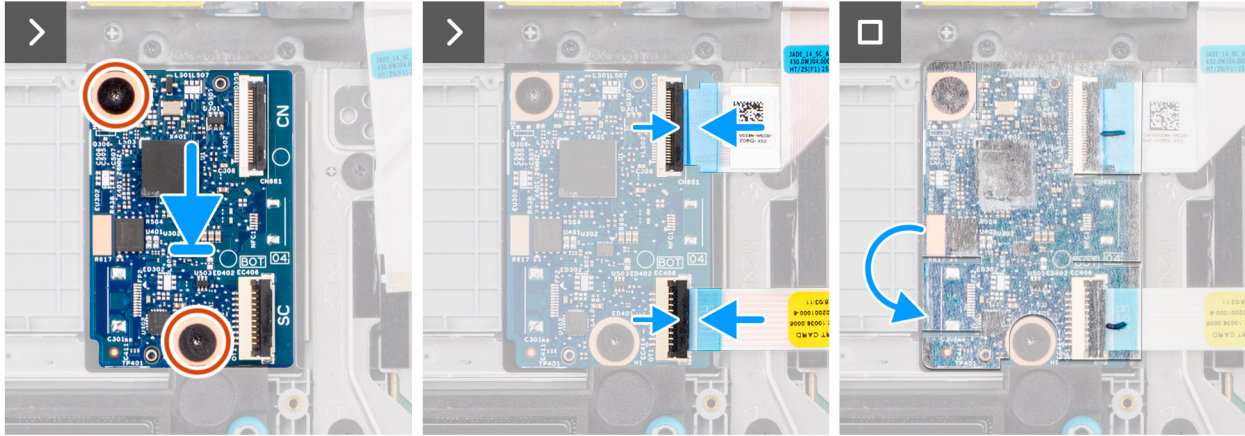
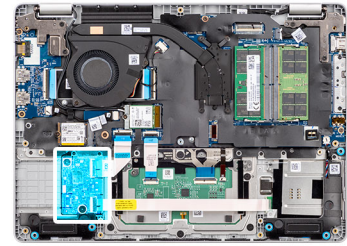

**Figure 38. Installing the USH board**

#### Steps

1. Align and place the USH board on its slot on the palm-rest assembly.
2. Replace the two screws (M2x2) that secure the USH board to the palm-rest assembly.
3. Connect the smart card reader cable to the connector (EC406) on the USH board.
4. Connect the USH board FPC to the connector (CN661) on the USH board.
5. Replace the protective film over the USH board.

#### Next steps

1. Install the [battery](#).
2. Install the [base cover](#).
3. Follow the procedure in [After working inside your computer](#).

## Smart-card reader

### Removing the smart card reader (For computers shipped with smart card reader)

#### Prerequisites

1. Follow the procedure in [Before working inside your computer](#).
2. Remove the [base cover](#).
3. Remove the [battery](#).

#### About this task

The following image indicates the location of the smart card reader and provides a visual representation of the removal procedure.



4x  
M2x2.2

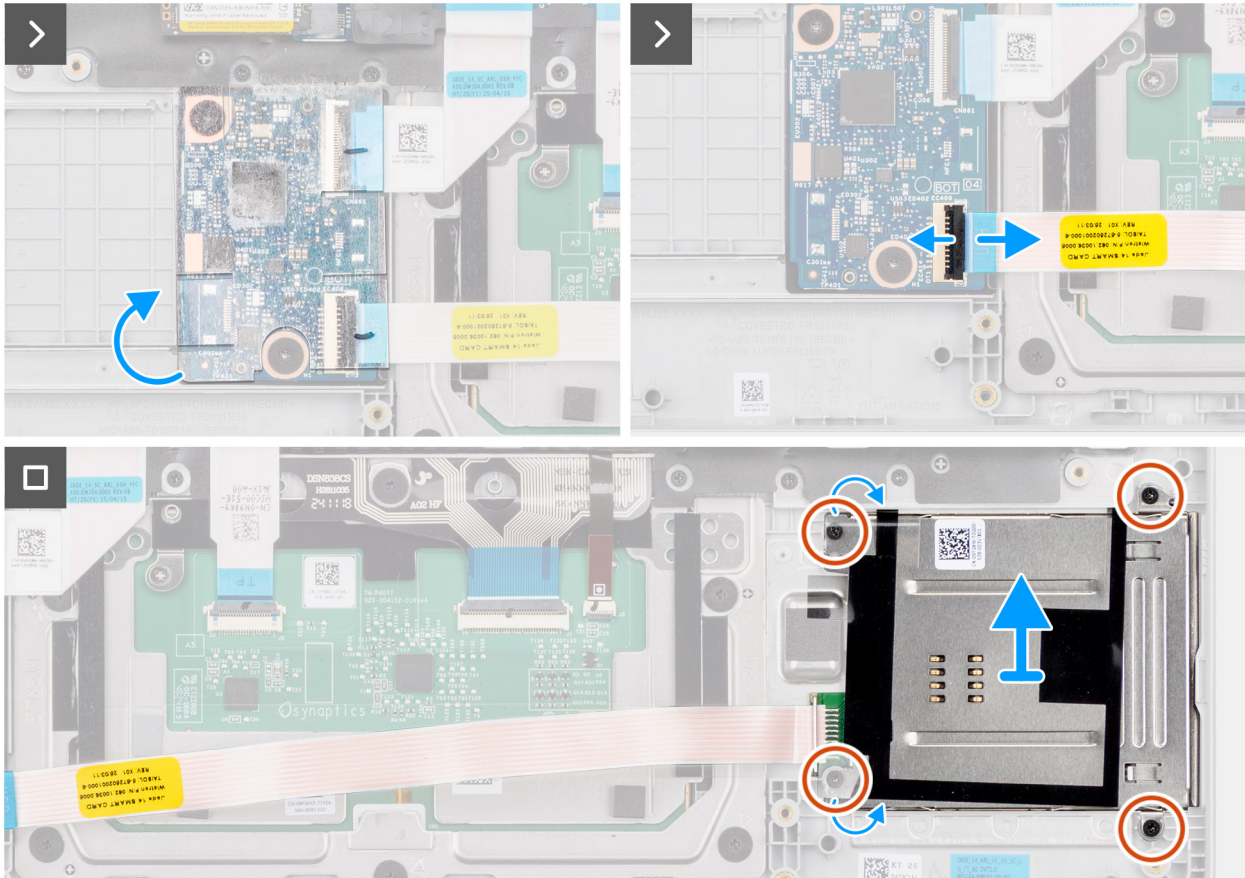
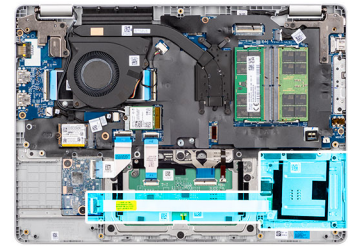

Figure 39. Removing the smart card reader

#### Steps

1. Peel off the protective film from the USH board.
2. Open the latch and disconnect the smart card reader cable from the connector (EC406) on the USH board.
3. Remove the four screws (M2x2.2) that secure the smart card reader to the palm-rest assembly.
4. Lift the smart card reader along with its cable from the palm-rest assembly.

## Installing the smart card reader (For computers shipped with smart card reader)

#### Prerequisites

If you are replacing a component, remove the existing component before performing the installation procedure.

#### About this task

The following image indicates the location of the smart card reader and provides a visual representation of the installation procedure.



4x  
M2x2.2

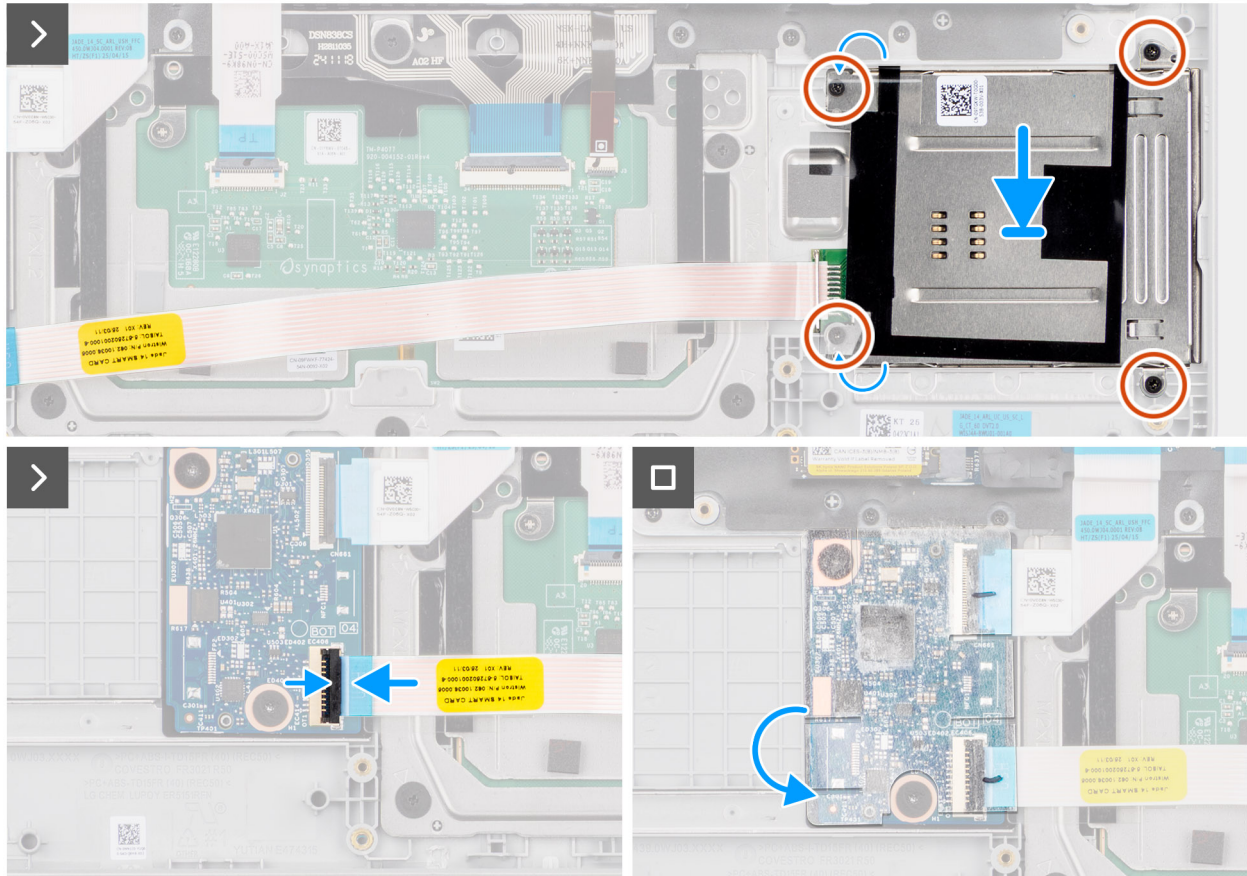
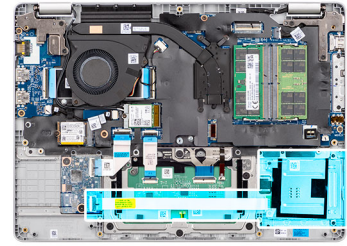

**Figure 40. Installing the smart card reader**

### Steps

1. Align and place the smart card reader on its slot on the palm-rest assembly.
2. Replace the four screws (M2x2.2) that secure the smart card reader to the palm-rest assembly.
3. Connect the smart card reader cable to the connector (EC406) on the USH board and close the latch.
4. Replace the protective film over the USH board.

### Next steps

1. Install the [battery](#).
2. Install the [base cover](#).
3. Follow the procedure in [After working inside your computer](#).

# Power-adapter port

## Removing the power-adapter port

**CAUTION:** The information in this removal section is intended for authorized service technicians only.

### Prerequisites

1. Follow the procedure in [Before working inside your computer](#).
2. Remove the [base cover](#).

### About this task

The following images indicate the location of the power-adapter port and provide a visual representation of the removal procedure.

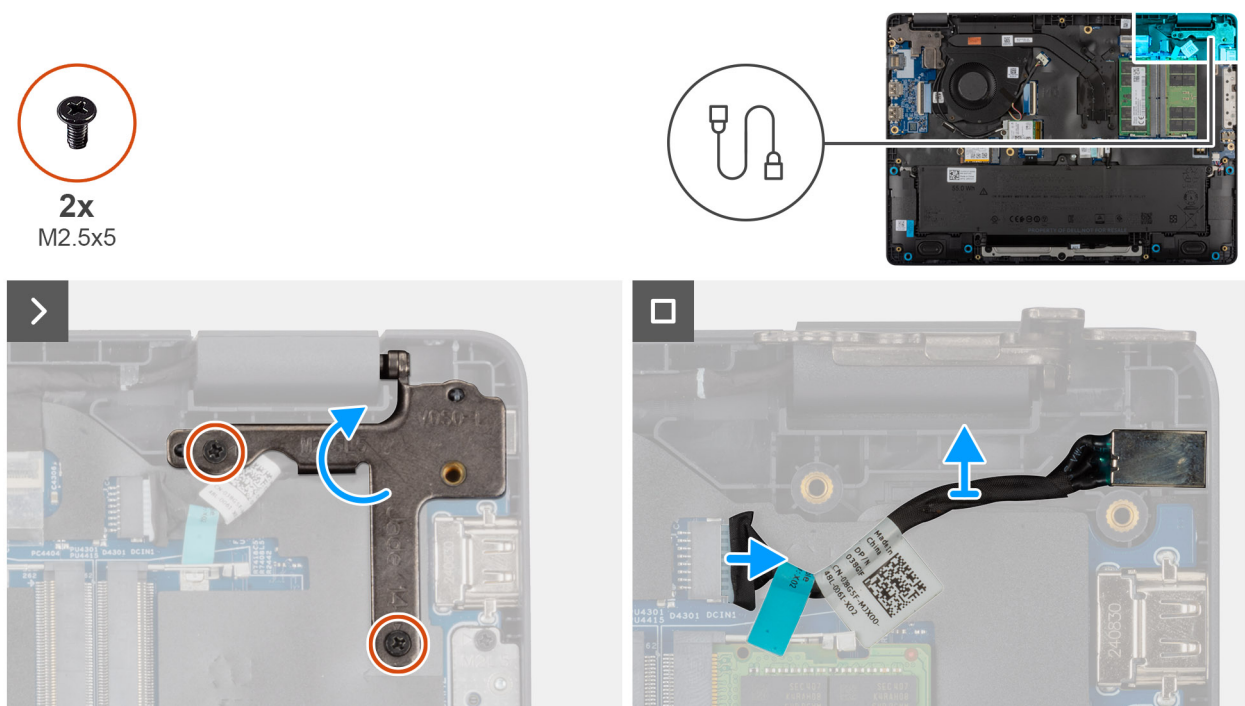

**Figure 41. Removing the power-adapter port**

### Steps

1. Remove the two screws (M2.5x5) that secure the left display-hinge to the palm-rest assembly.
2. Lift the left display-hinge upward to access the power-adapter port.
3. Disconnect the power-adapter port cable from the connector (DCIN1) on the system board.
4. Remove the power-adapter port from the system board.

## Installing the power-adapter port

**CAUTION:** The information in this installation section is intended for authorized service technicians only.

### Prerequisites

If you are replacing a component, remove the existing component before performing the installation procedure.

### About this task

The following images indicate the location of the power-adapter port and provide a visual representation of the installation procedure.

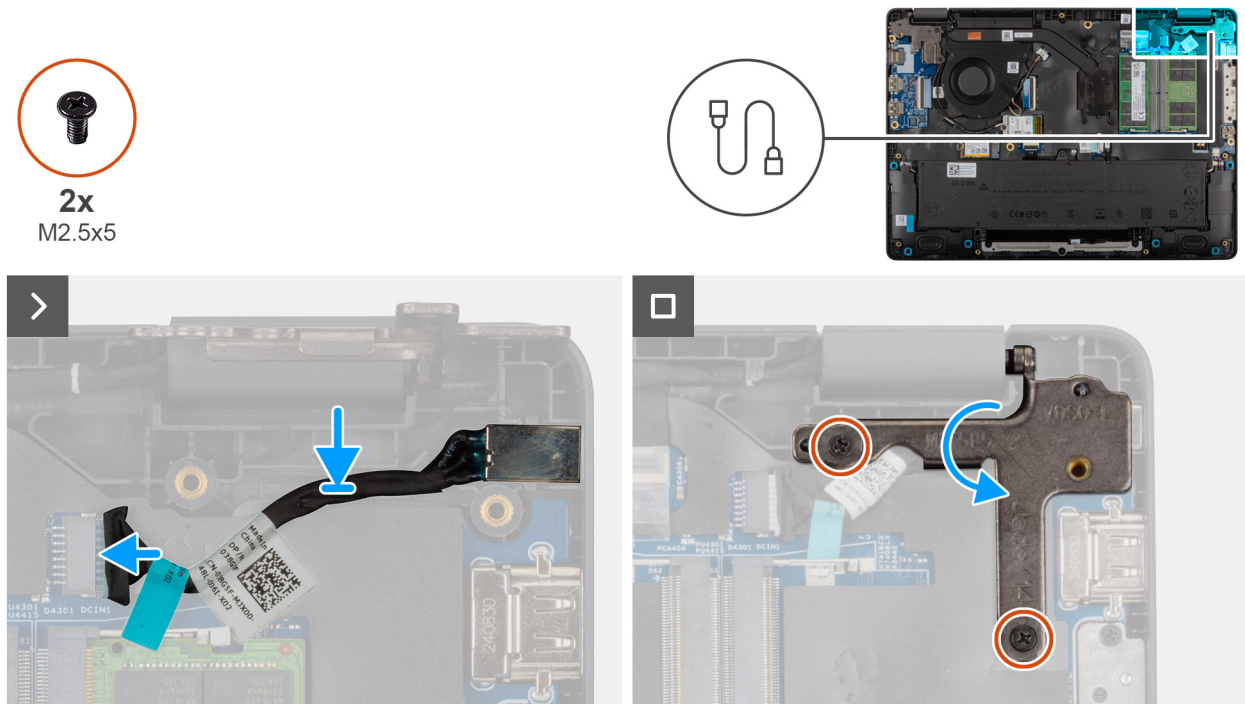

Figure 42. Installing the power-adapter port

### Steps

1. Align and place the power-adapter port on the system board.
2. Connect the power-adapter port cable to the connector (DCIN1) on the system board.
3. Gently press the left display-hinge in a downward direction towards the power-adapter port.
4. Replace the two screws (M2.5x4) that secure the left display-hinge to the palm-rest assembly.

### Next steps

1. Install the [base cover](#).
2. Follow the procedure in [After working inside your computer](#).

## Heat sink

### Removing the heat sink

**CAUTION:** The information in this removal section is intended for authorized service technicians only.

### Prerequisites

1. Follow the procedure in [Before working inside your computer](#).
2. Remove the [base cover](#).

### About this task

The following image indicates the location of the heat sink and provides a visual representation of the removal procedure.



**4x**  
M2x5.4

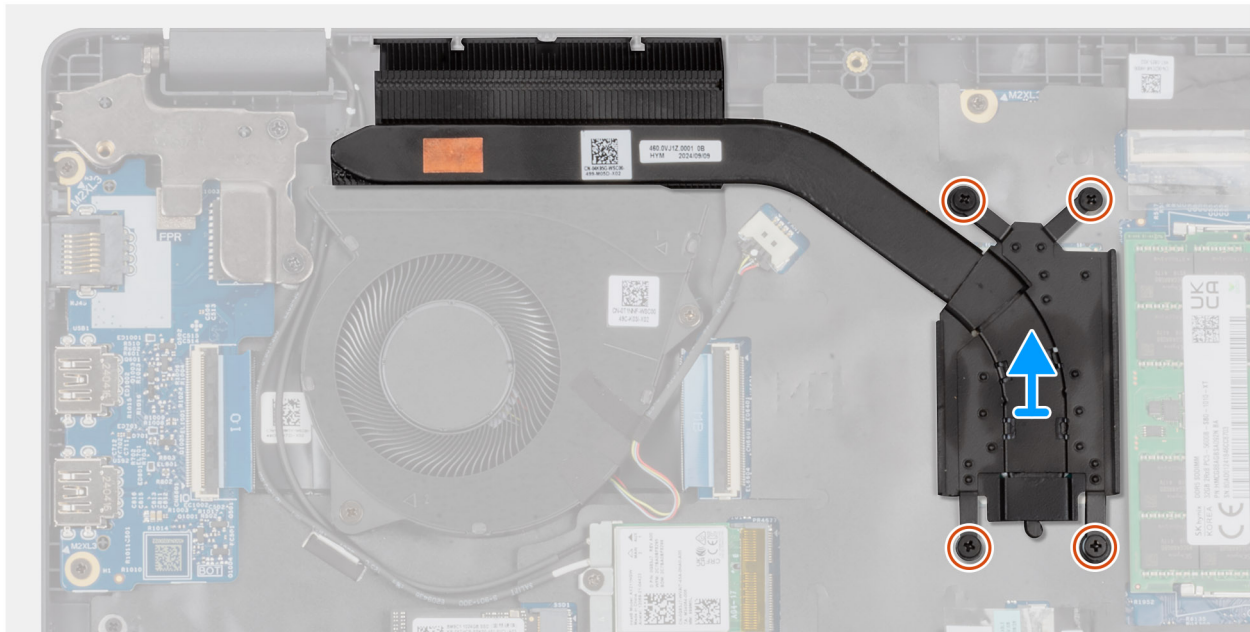
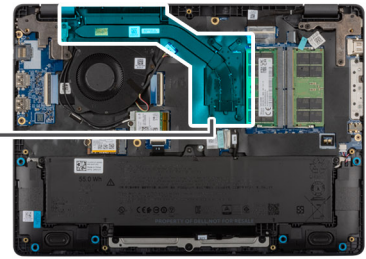

**Figure 43. Removing the heat sink**

### Steps

1. Loosen the four captive screws (M2x5.4) that secure the heat sink to the system board.  
**i** **NOTE:** Loosen the captive screws in the reverse sequential order mentioned on the heat sink [4 > 3 > 2 > 1].
2. Lift the heat sink from the system board.

## Installing the heat sink

**⚠ CAUTION:** The information in this installation section is intended for authorized service technicians only.

### Prerequisites

If you are replacing a component, remove the existing component before performing the installation procedure.

### About this task

**i** **NOTE:** If either the system board or the heat-sink is replaced, use the thermal grease that is provided in the kit to ensure that thermal conductivity is achieved.

The following image indicates the location of the heat sink and provides a visual representation of the installation procedure.



4x  
M2x5.4

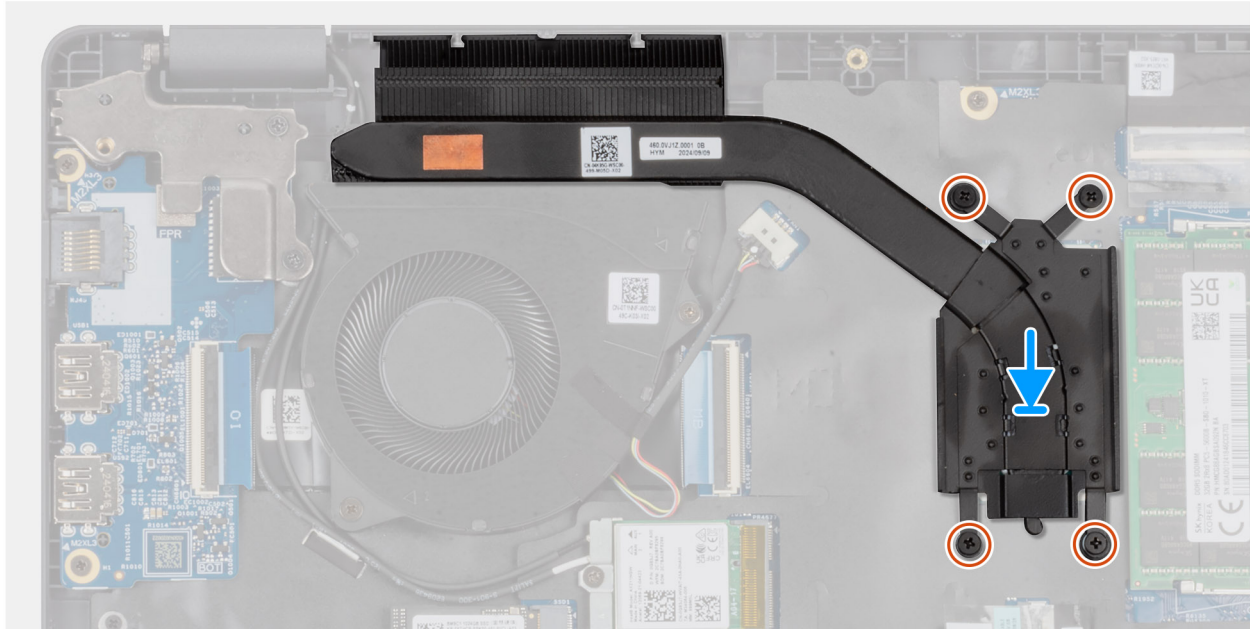
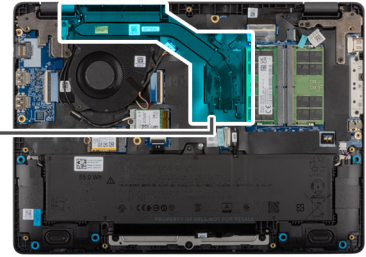

Figure 44. Installing the heat sink

#### Steps

1. Place the heat sink into its slot on the system board.
2. Align the screw holes on the heat sink to the screw holes on the system board.
3. Tighten the four captive screws (M2x5.4) that secure the heat sink to the system board.

**NOTE:** Tighten the captive screws in the sequential order mentioned on the heat sink [1 > 2 > 3 > 4].

#### Next steps

1. Install the [base cover](#).
2. Follow the procedure in [After working inside your computer](#).

## vPro cable

### Removing the vPro cable (For computers shipped with Intel Core Ultra 200U Series)

**CAUTION:** The information in this removal section is intended for authorized service technicians only.

#### Prerequisites

1. Follow the procedure in [Before working inside your computer](#).
2. Remove the [base cover](#).

### About this task

The following image indicates the location of the vPro cable and provides a visual representation of the removal procedure.

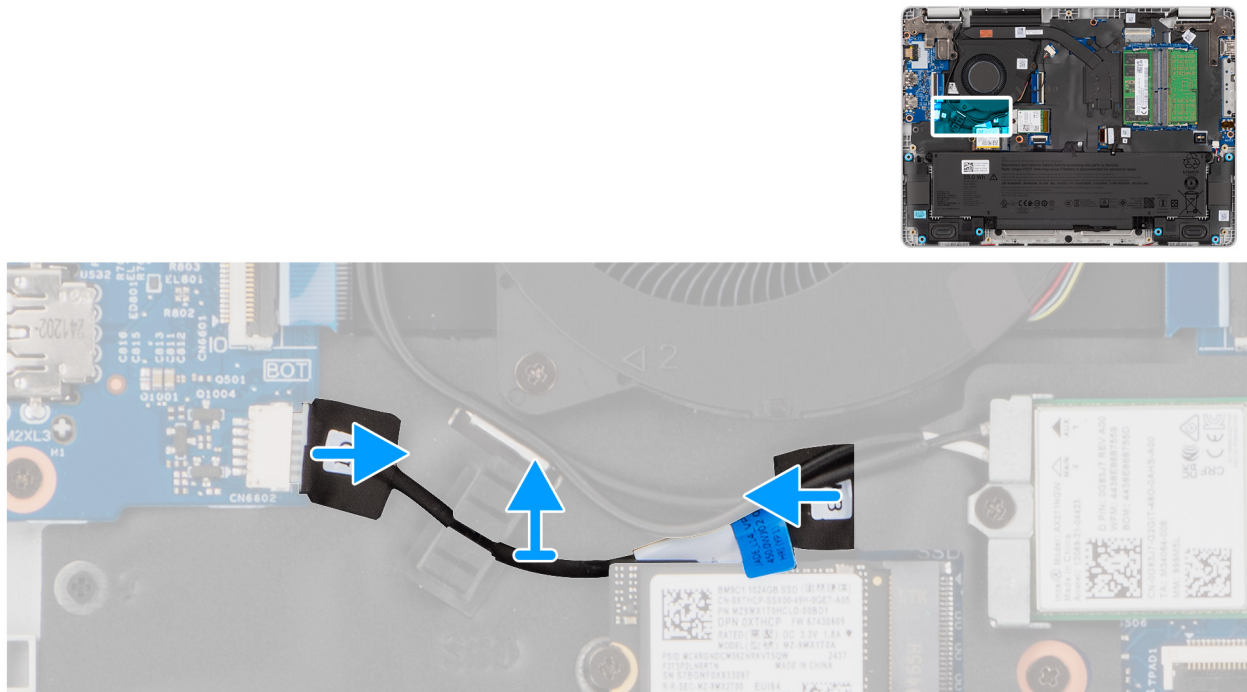

Figure 45. Removing the vPro cable

### Steps

1. Disconnect the vPro cable from the vPro connector on the I/O board.
2. Disconnect the vPro cable from the connector on the system board.
3. Unroute the vPro cable from the routing guide and lift it off the palm-rest and keyboard assembly.

## Installing the vPro cable (For computers shipped with Intel Core Ultra 200U Series)

**CAUTION:** The information in this installation section is intended for authorized service technicians only.

### Prerequisites

If you are replacing a component, remove the existing component before performing the installation procedure.

### About this task

The following image indicates the location of the vPro cable and provides a visual representation of the installation procedure.

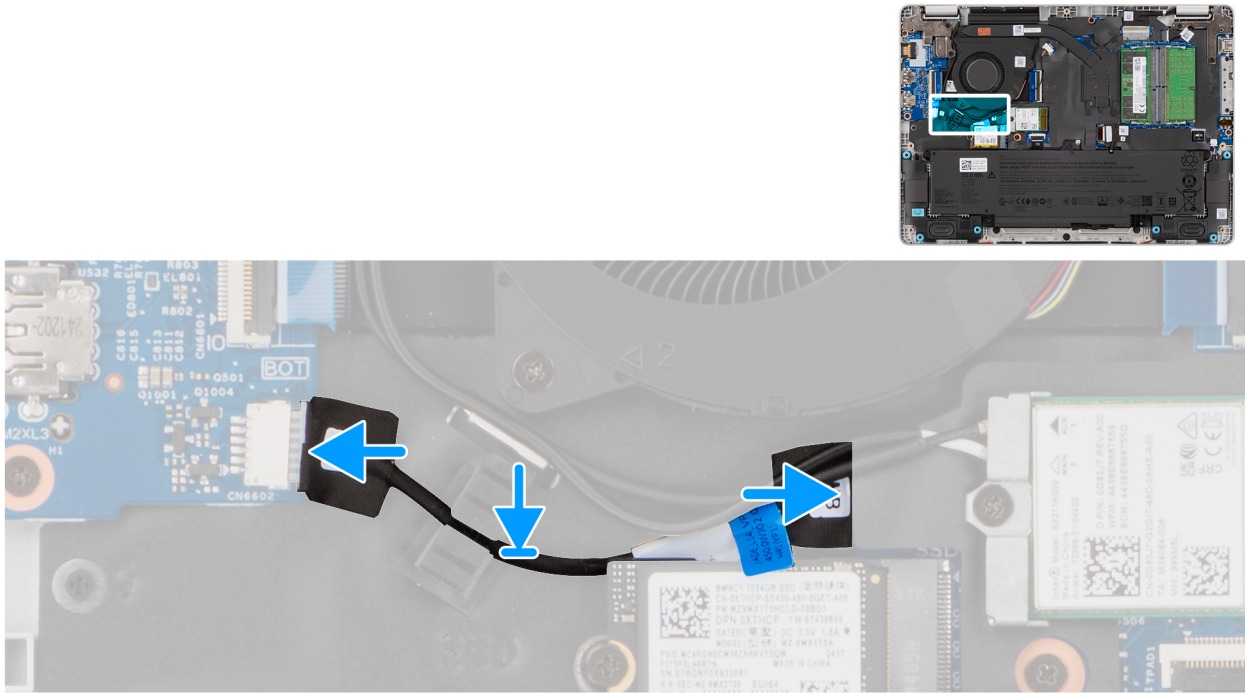

**Figure 46. Installing the vPro cable**

**Steps**

1. Route the vPro cable through the routing guide on the palm-rest and keyboard assembly.
2. Connect the vPro cable to the connector on the system board.
3. Connect the vPro cable to the vPro connector on the I/O board.

**Next steps**

1. Install the [base cover](#).
2. Follow the procedure in [After working inside your computer](#).

## Removing the vPro cable (For computers shipped with Smart card reader)

**CAUTION:** The information in this removal section is intended for authorized service technicians only.

**Prerequisites**

1. Follow the procedure in [Before working inside your computer](#).
2. Remove the [base cover](#).

**About this task**

The following image indicates the location of the vPro cable and provides a visual representation of the removal procedure.

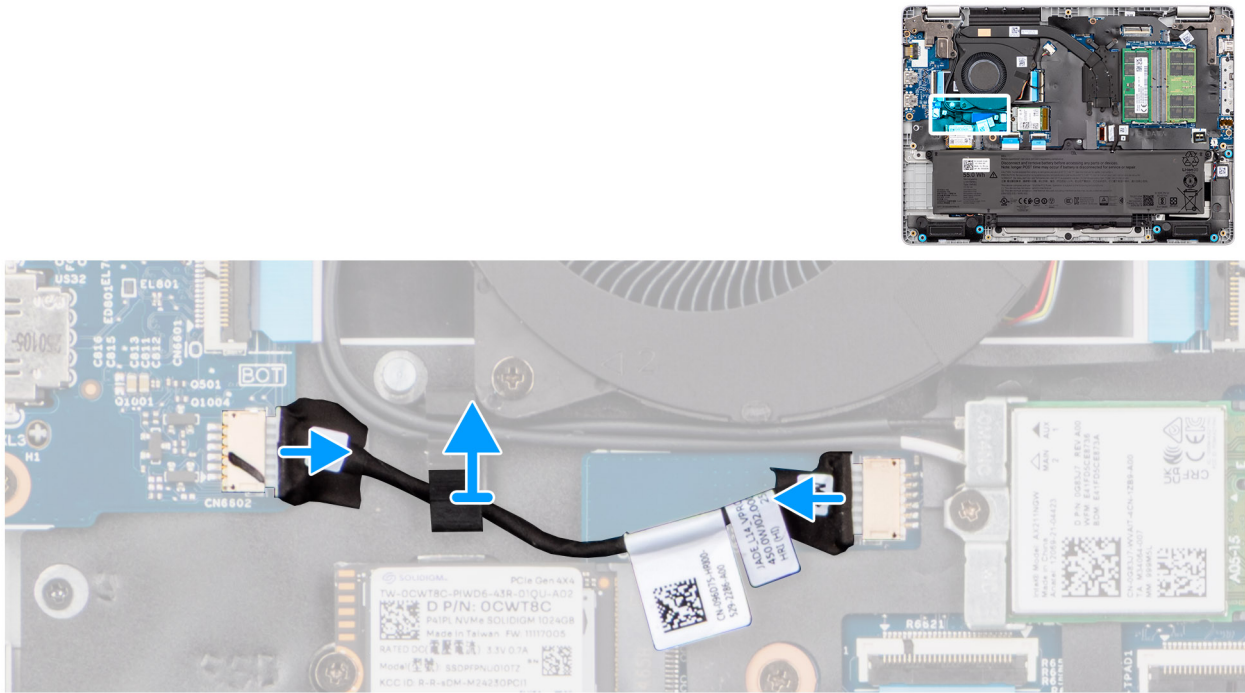

**Figure 47. Removing the vPro cable**

**Steps**

1. Disconnect the vPro cable from the vPro connector on the I/O board.
2. Disconnect the vPro cable from the connector on the system board.
3. Unroute the vPro cable from the routing guide and lift it off the palm-rest and keyboard assembly.

## Installing the vPro cable (For computers shipped with Smart card reader)

**CAUTION:** The information in this installation section is intended for authorized service technicians only.

**Prerequisites**

If you are replacing a component, remove the existing component before performing the installation procedure.

**About this task**

The following image indicates the location of the vPro cable and provides a visual representation of the installation procedure.

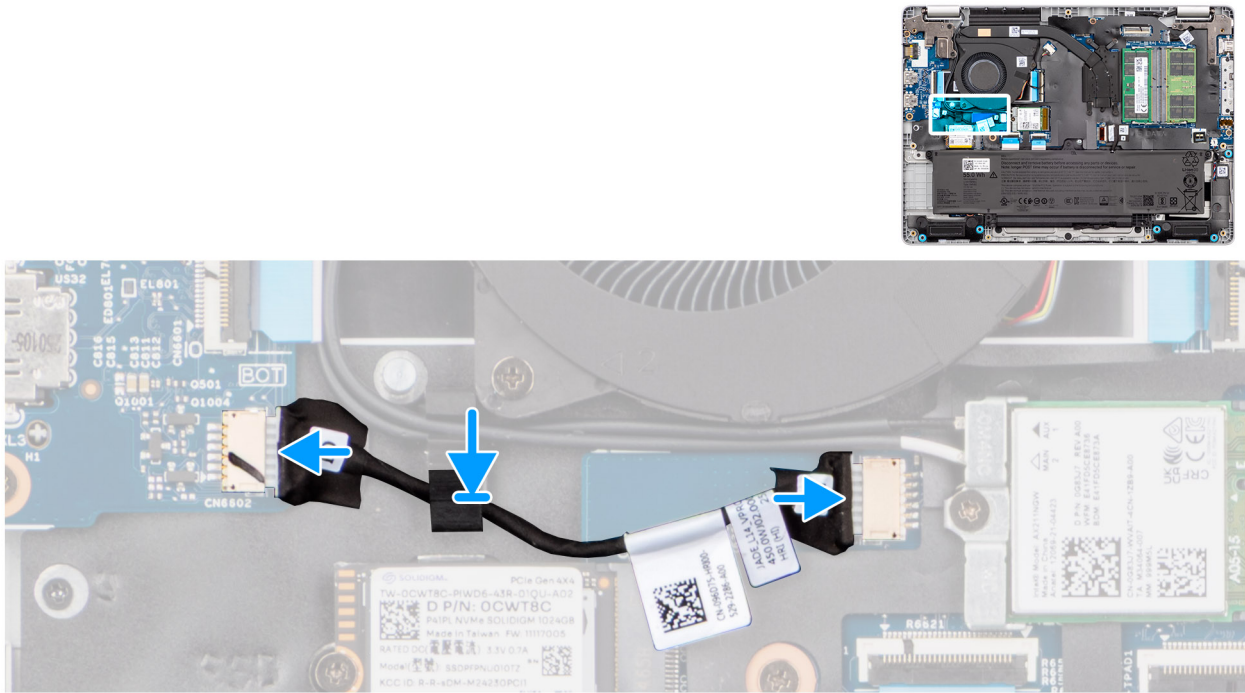

**Figure 48. Installing the vPro cable**

### Steps

1. Route the vPro cable through the routing guide on the palm-rest and keyboard assembly.
2. Connect the vPro cable to the connector on the system board.
3. Connect the vPro cable to the vPro connector on the I/O board.

### Next steps

1. Install the [base cover](#).
2. Follow the procedure in [After working inside your computer](#).

## I/O board

### Removing the I/O board (For computers shipped with Intel Core Series)

**CAUTION:** The information in this removal section is intended for authorized service technicians only.

### Prerequisites

1. Follow the procedure in [Before working inside your computer](#).
2. Remove the [base cover](#).
3. Remove the [fan](#).

### About this task

The following images indicate the location of the I/O board and provide a visual representation of the removal procedure.

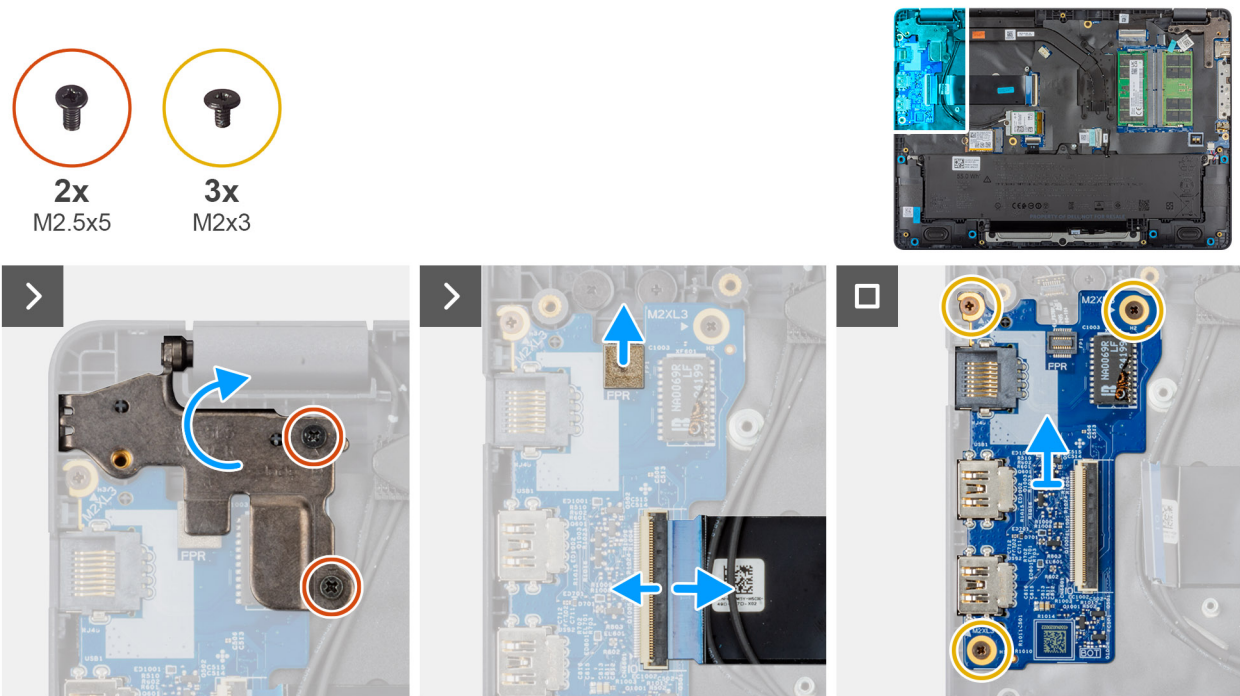

**Figure 49. Removing the I/O board**

### Steps

1. Remove the two screws (M2.5x5) that secure the right display-hinge to the chassis.
2. Lift the right display-hinge upward to access the I/O board.
3. For computers shipped with fingerprint readers, disconnect the FPC cable of the fingerprint reader from the connector (FPR) on the I/O board.
4. Open the latch and disconnect the I/O-board cable from the connector (IO) on the I/O board.
5. Remove the three screws (M2x3) that secure the I/O board to the palm-rest assembly.
6. Lift the I/O board off the palm-rest assembly.

## Installing the I/O board (For computers shipped with Intel Core Series)

**CAUTION:** The information in this installation section is intended for authorized service technicians only.

### Prerequisites

If you are replacing a component, remove the existing component before performing the installation procedure.

### About this task

The following images indicate the location of the I/O board and provide a visual representation of the installation procedure.

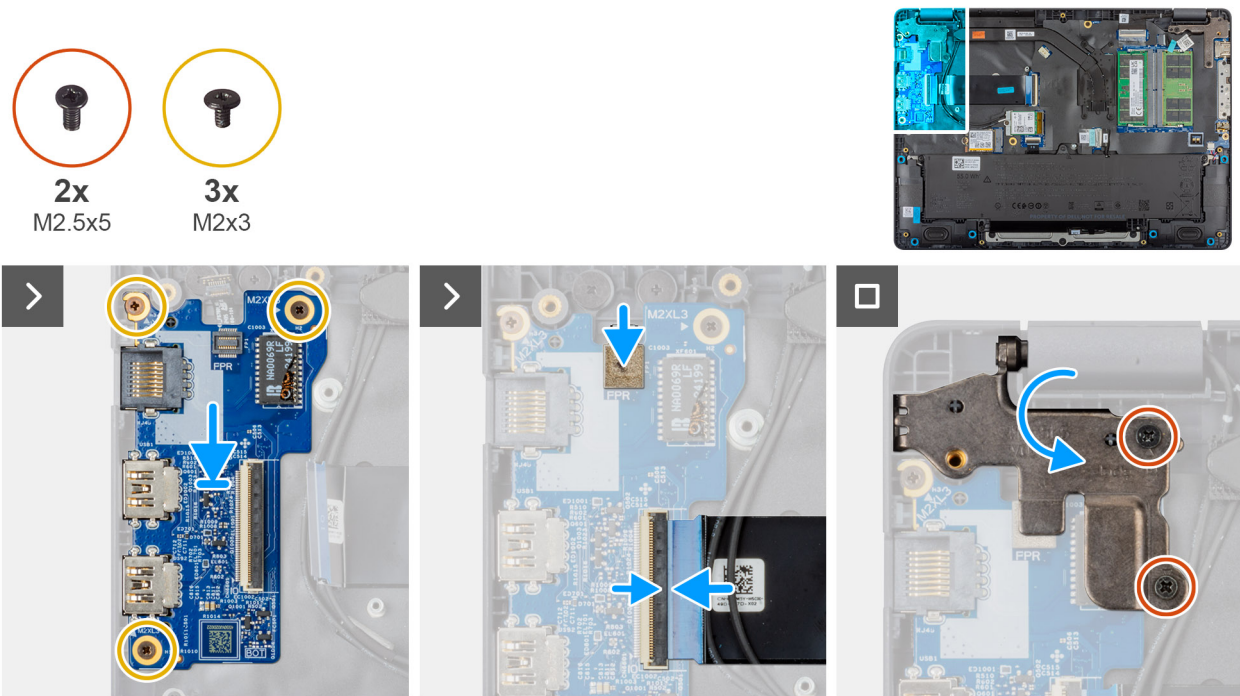

**Figure 50. Installing the I/O board**

#### Steps

1. Place and align the screw holes on the I/O board with the screw holes on the palm-rest assembly.
2. Replace the three screws (M2x3) that secure the I/O board to the palm-rest assembly.
3. Connect the I/O-board cable to the connector (IO) on the I/O board and close the latch.
4. For computers shipped with fingerprint readers, connect the FPC cable of the fingerprint reader to the connector (FPR) on the I/O board.
5. Gently press the right display-hinge in a downward direction towards the I/O board.
6. Replace the two screws (M2.5x5) that secure the right display-hinge to the palm-rest assembly.

#### Next steps

1. Install the [fan](#).
2. Install the [base cover](#).
3. Follow the procedure in [After working inside your computer](#).

## Removing the I/O board (For computers shipped with Intel Core Ultra 200U Series)

**CAUTION:** The information in this removal section is intended for authorized service technicians only.

#### Prerequisites

1. Follow the procedure in [Before working inside your computer](#).
2. Remove the [base cover](#).
3. Remove the [fan](#).

#### About this task

The following images indicate the location of the I/O board and provide a visual representation of the removal procedure.

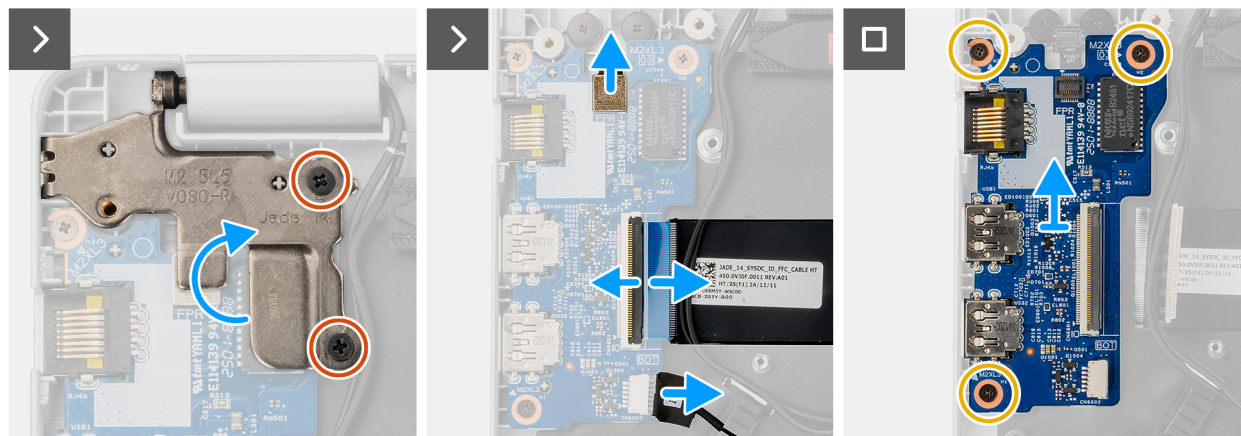
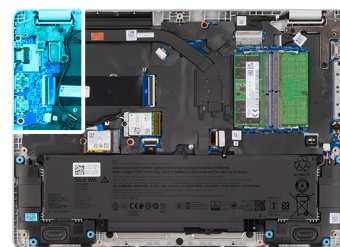
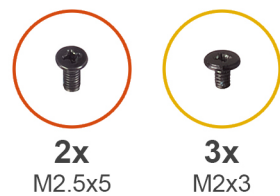

**Figure 51. Removing the I/O board**

### Steps

1. Remove the two screws (M2.5x5) that secure the right display-hinge to the chassis.
2. Lift the right display-hinge upward to access the I/O board.
3. For computers shipped with fingerprint readers, disconnect the FPC cable of the fingerprint reader from the connector (FPR) on the I/O board.
4. Open the latch and disconnect the I/O-board cable from the connector (IO) on the I/O board.
5. Disconnect the vPro cable from the vPro connector on the I/O board.
6. Remove the three screws (M2x3) that secure the I/O board to the palm-rest assembly.
7. Lift the I/O board off the palm-rest assembly.

## Installing the I/O board (For computers shipped with Intel Core Ultra 200U Series)

**CAUTION:** The information in this installation section is intended for authorized service technicians only.

### Prerequisites

If you are replacing a component, remove the existing component before performing the installation procedure.

### About this task

The following images indicate the location of the I/O board and provide a visual representation of the installation procedure.

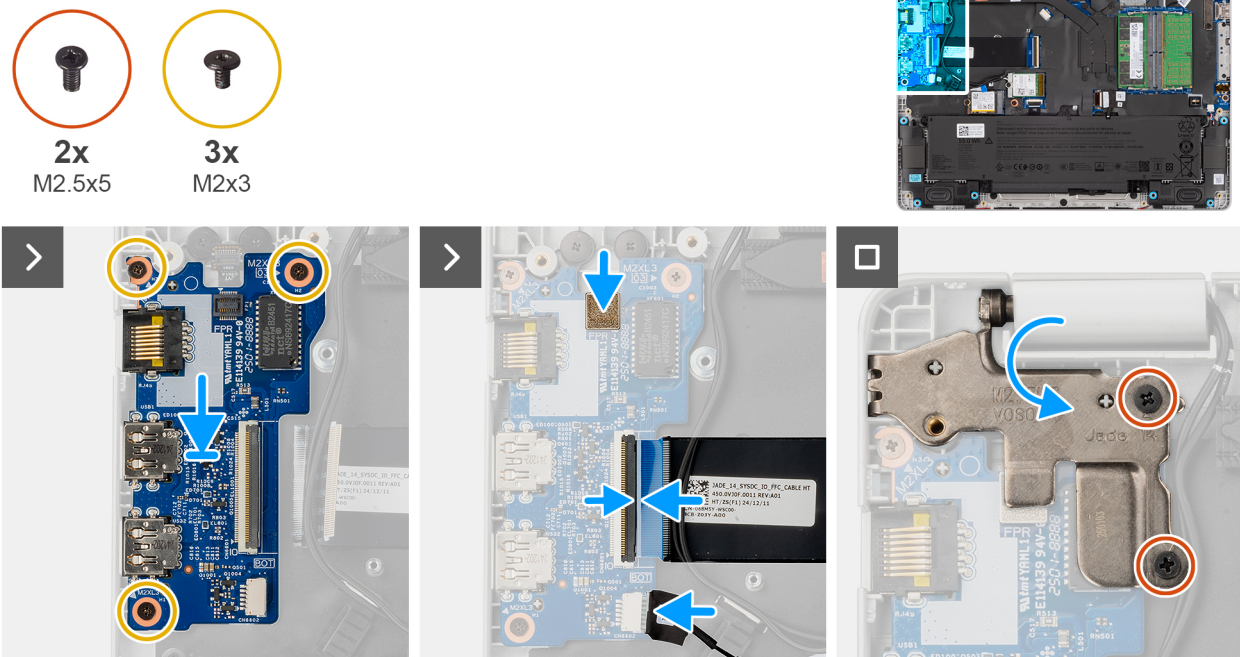

**Figure 52. Installing the I/O board**

### Steps

1. Place and align the screw holes on the I/O board with the screw holes on the palm-rest assembly.
2. Replace the three screws (M2x3) that secure the I/O board to the palm-rest assembly.
3. Connect the vPro cable to the vPro connector on the I/O board.
4. Connect the I/O-board cable to the connector (IO) on the I/O board and close the latch.
5. For computers shipped with fingerprint readers, connect the FPC cable of the fingerprint reader to the connector (FPR) on the I/O board.
6. Gently press the right display-hinge in a downward direction towards the I/O board.
7. Replace the two screws (M2.5x5) that secure the right display-hinge to the palm-rest assembly.

### Next steps

1. Install the [fan](#).
2. Install the [base cover](#).
3. Follow the procedure in [After working inside your computer](#).

## I/O-board FPC

### Removing the I/O-board FPC

**CAUTION:** The information in this removal section is intended for authorized service technicians only.

#### Prerequisites

1. Follow the procedure in [Before working inside your computer](#).
2. Remove the [base cover](#).
3. Remove the [fan](#).

#### About this task

The following image indicates the location of the I/O-board FPC and provides a visual representation of the removal procedure.

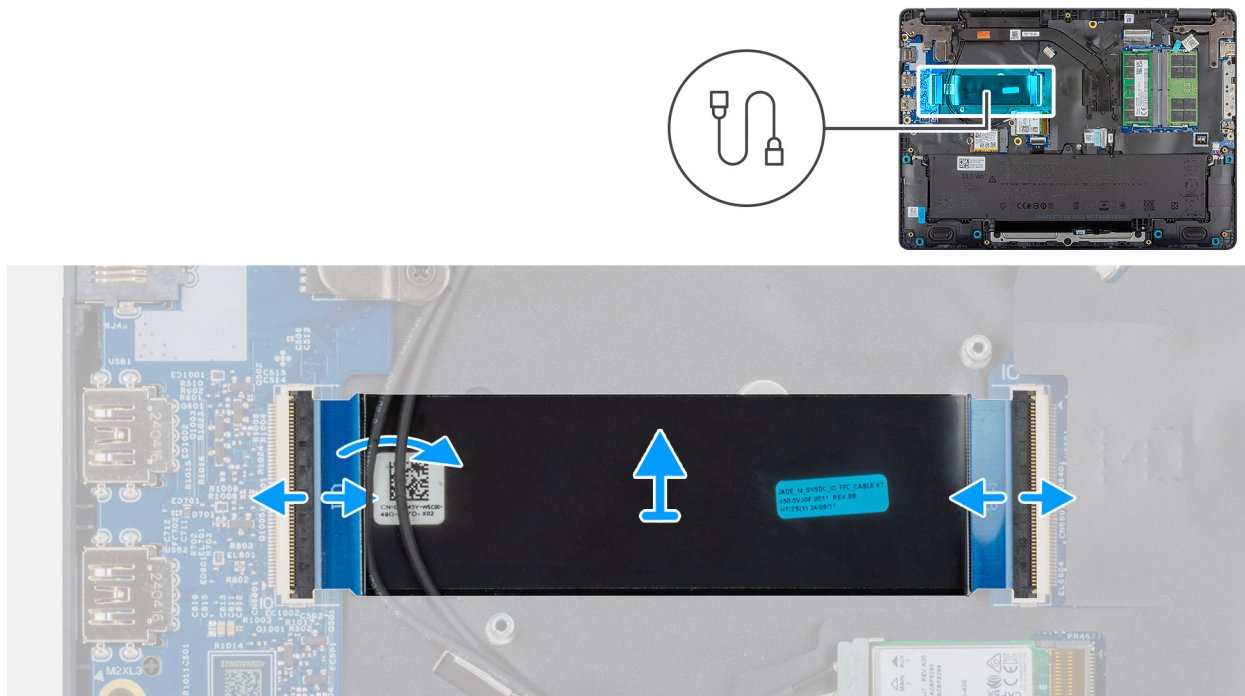

**Figure 53. Removing the I/O-board FPC**

### Steps

1. Open the latch and disconnect the I/O-board FPC from the connector (IO) on the I/O board.
2. Open the latch and disconnect the other end of the I/O-board FPC from the connector on the system board.
3. Slide and lift the I/O-board FPC cable off the computer.

## Installing the I/O-board FPC

**CAUTION:** The information in this installation section is intended for authorized service technicians only.

### Prerequisites

If you are replacing a component, remove the existing component before performing the installation procedure.

### About this task

The following image indicates the location of the I/O-board FPC and provides a visual representation of the installation procedure.

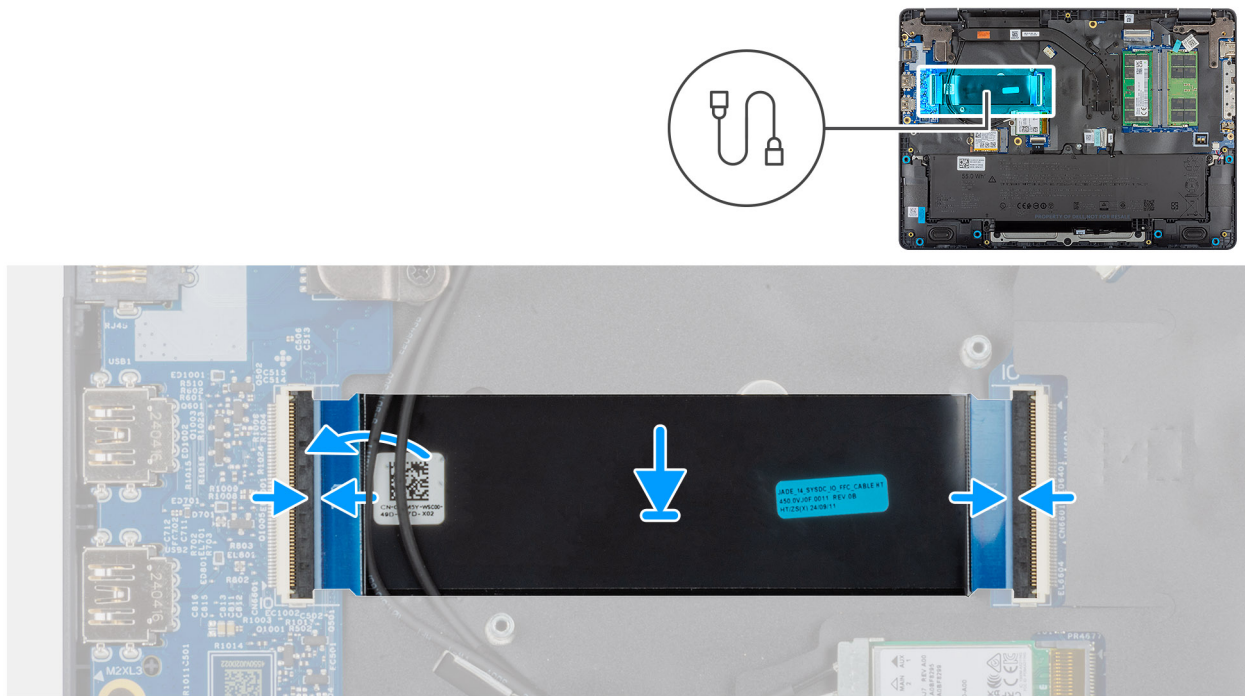

**Figure 54. Installing the I/O-board FPC**

### Steps

1. Slide the I/O-board FPC beneath the WLAN antenna cables.
2. Connect the I/O-board FPC to the connector on the system board and close the latch to secure the cable in place.
3. Connect the other end of the I/O-board FPC to the connector (IO) on the I/O board and close the latch to secure the cable in place.

### Next steps

1. Install the [fan](#).
2. Install the [base cover](#).
3. Follow the procedure in [After working inside your computer](#).

## Power button with fingerprint reader

### Removing the power button with a fingerprint reader

**⚠ CAUTION:** The information in this removal section is intended for authorized service technicians only.

### Prerequisites

1. Follow the procedure in [Before working inside your computer](#).
2. Remove the [base cover](#).
3. Remove the [fan](#).
4. Remove the I/O board (for computers shipped with Intel Core Series) or (for computers shipped with Intel Core Ultra 200U Series), whichever is applicable.

### About this task

**i NOTE:** For computers shipped without a fingerprint reader configuration, the power button removal steps remain the same.

The following images indicate the location of the power button and provide a visual representation of the removal procedure.

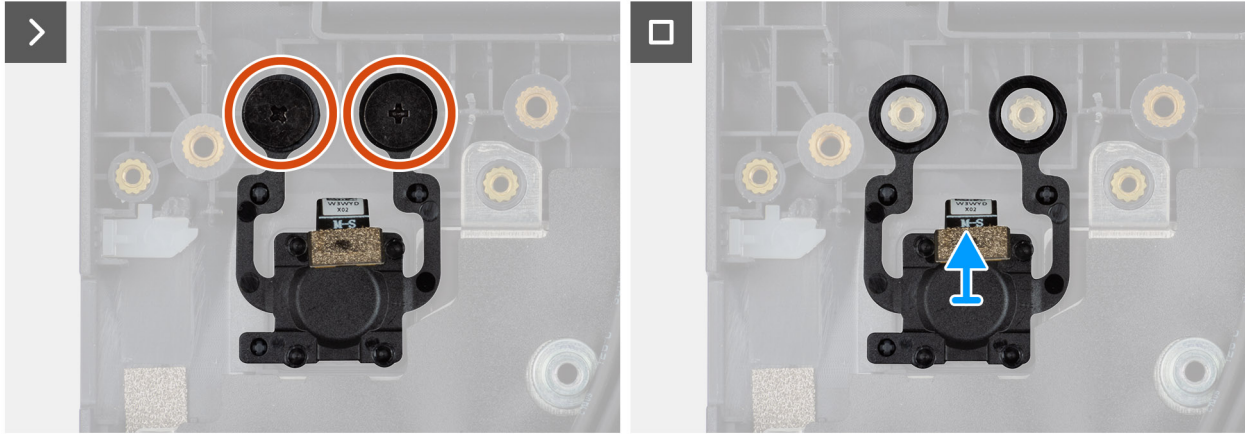

Figure 55. Removing the power button with fingerprint reader

#### Steps

1. Remove the two screws (M2x2) that secure the power button to the palm-rest assembly.
2. Lift the power button from the slot in the palm-rest assembly.

## Installing the power button with a fingerprint reader

**CAUTION:** The information in this installation section is intended for authorized service technicians only.

#### Prerequisites

If you are replacing a component, remove the existing component before performing the installation procedure.

#### About this task

**NOTE:** For computers shipped without a fingerprint reader configuration, the power button installation steps remain the same.

The following images indicate the location of the power button and provide a visual representation of the installation procedure.

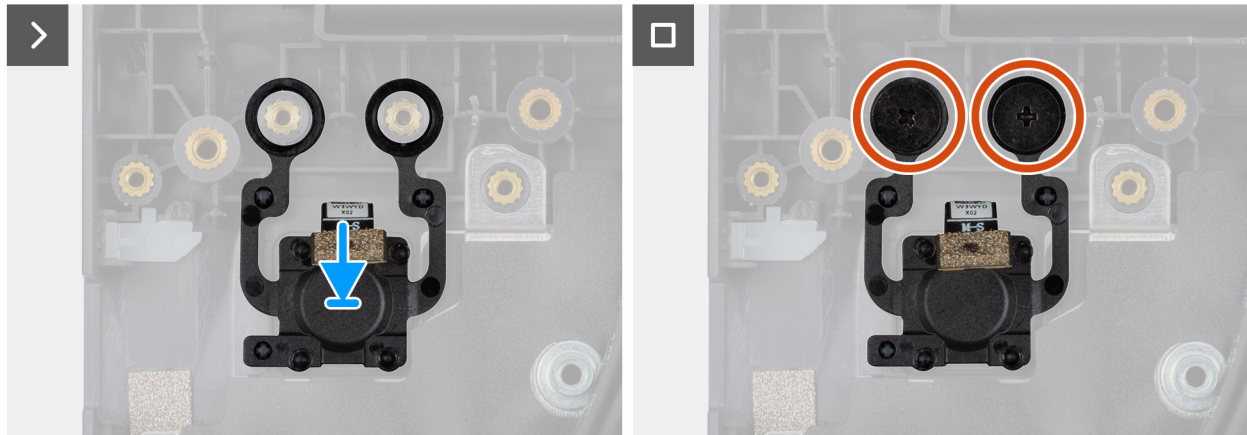
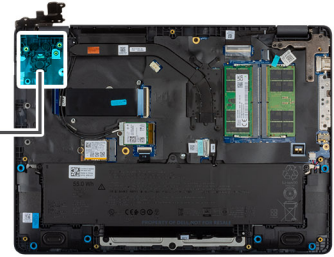

**Figure 56. Installing the power button with a fingerprint reader**

#### Steps

1. Align the screw holes on the power button to the screw holes on the palm-rest assembly.
2. Replace the two screws (M2x2) that secure the power button to the palm-rest assembly.

#### Next steps

1. Install the I/O board (for computers shipped with Intel Core Series) or (for computers shipped with Intel Core Ultra 200U Series), whichever is applicable.
2. Install the fan.
3. Install the base cover.
4. Follow the procedure in [After working inside your computer](#).

## System board

### Removing the system board (For computers shipped with Intel Core Series)

**⚠ CAUTION:** The information in this removal section is intended for authorized service technicians only.

#### Prerequisites

1. Follow the procedure in [Before working inside your computer](#).
2. Remove the [base cover](#).
3. Remove the [battery](#).
4. Remove the [memory module](#).
5. Remove the [SSD](#).
6. Remove the [wireless card](#).
7. Remove the [fan](#).
8. Remove the [heat sink](#).
9. Remove the [display assembly](#).

### About this task

**NOTE:** For computers shipped with UFS, the storage is integrated with the system board. Dell Technologies recommends that you back up your data regularly to avoid any potential data loss after a service incident. For more information, see the knowledge base article [000130154](https://www.dell.com/support/kbarticle/000130154) at [Dell Support Site](https://www.dell.com/support).

The following image indicates the connectors on your system board.

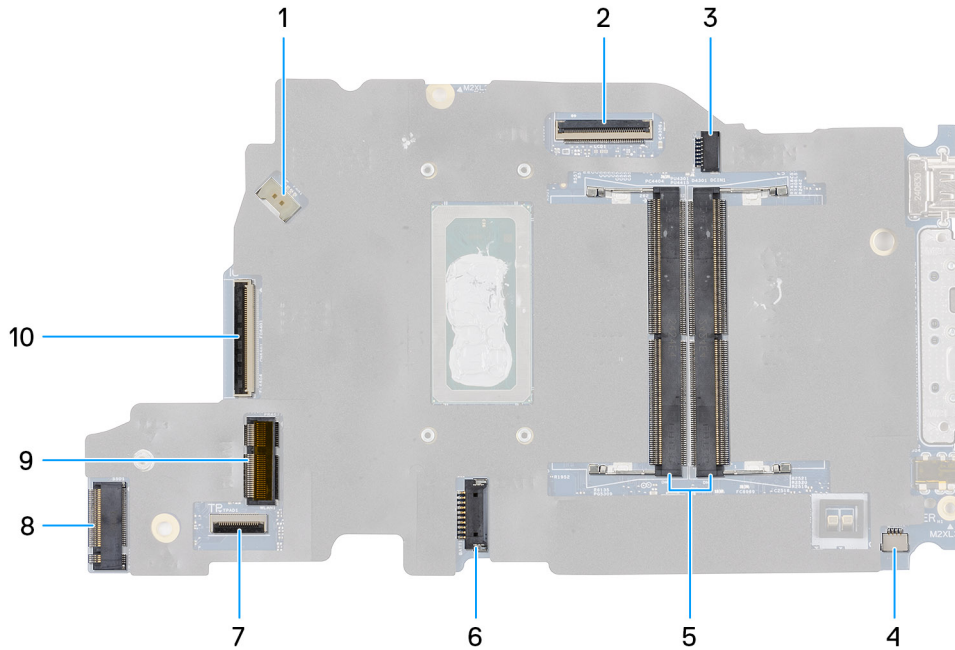

**Figure 57. System-board connectors**

- |   |                                    |
|---|------------------------------------|
| 1. Fan-cable connector (FAN1)             | 2. Display-cable connector (LCD1)  |
| 3. DC-in port connector (DCIN1)           | 4. Speaker-cable connector (SPK1)  |
| 5. Memory-module connectors (DM1 AND DM2) | 6. Battery-cable connector (BATT1) |
| 7. Touchpad-cable connector (TPAD1)       | 8. Wireless-card connector (WLAN1) |
| 9. SSD slot (SSD1)                        | 10. I/O-board cable connector (IO) |

The following images indicate the location of the system board and provide a visual representation of the removal procedure.

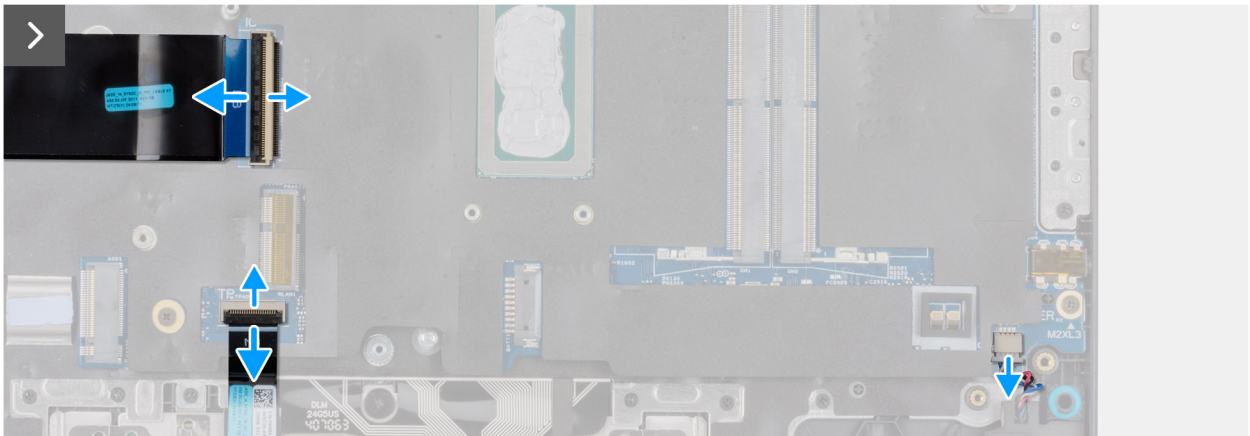
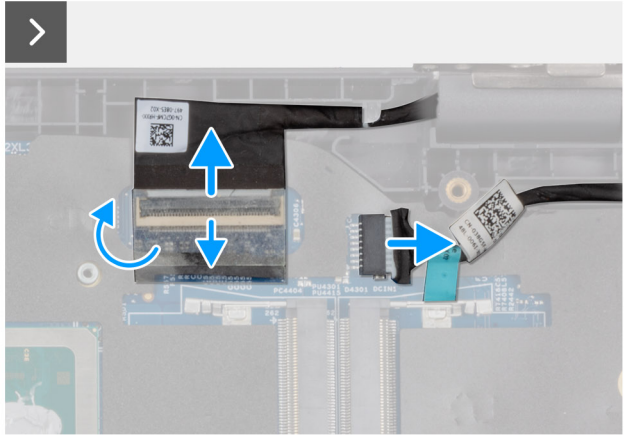
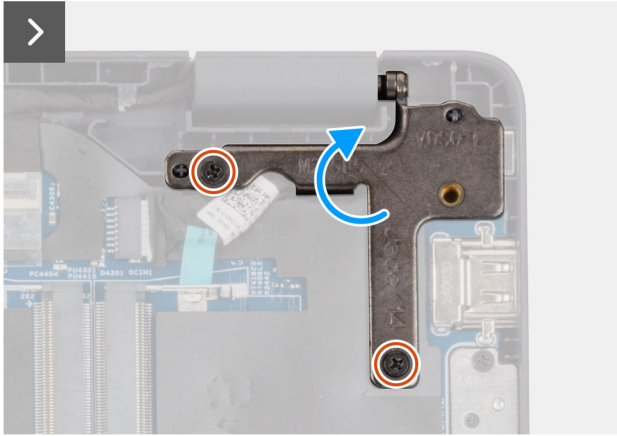
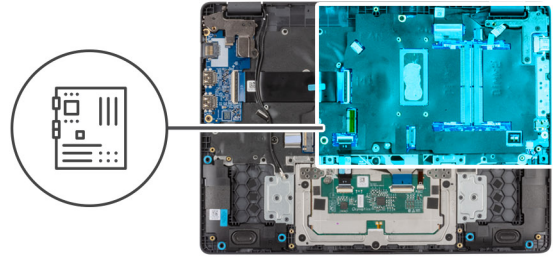
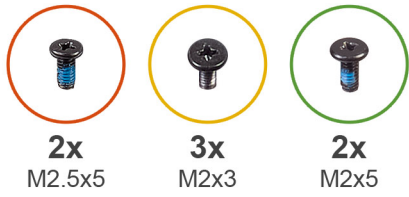
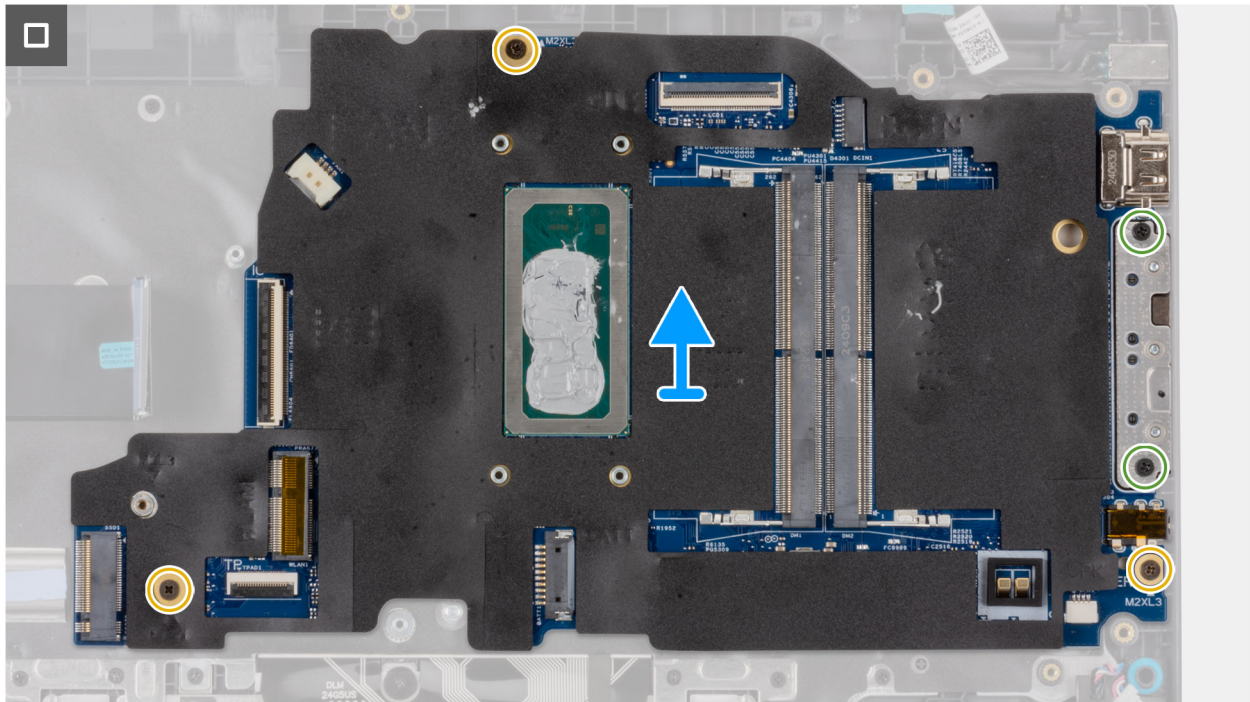

Figure 58. Removing the system board



**Figure 59. Removing the system board**

### Steps

1. Remove the two screws (M2.5x5) that secure the left display-hinge to the palm-rest assembly.
2. Lift the left display-hinge in an upward direction away from the system board.
3. Disconnect the following cables from the respective connectors on the system board:
  - Display cable (EDP)
  - Power-adapter port cable
  - Speaker cable
  - Touchpad cable
  - I/O-board cable
4. Remove the two screws (M2x5) that secure the Type-C module to the system board.
5. Remove the three screws (M2x3) that secure the system board to the palm-rest assembly.
6. Lift the system board off the palm-rest assembly.

## Installing the system board (For computers shipped with Intel Core Series)

**CAUTION:** The information in this installation section is intended for authorized service technicians only.

### Prerequisites

If you are replacing a component, remove the existing component before performing the installation procedure.

### About this task

**NOTE:** For computers shipped with UFS, the storage is integrated with the system board. Dell Technologies recommends that you back up your data regularly to avoid any potential data loss after a service incident. For more information, see the knowledge base article [000130154](https://www.dell.com/support/kbarticle/000130154) at [Dell Support Site](https://www.dell.com/support).

The following image indicates the connectors on your system board.

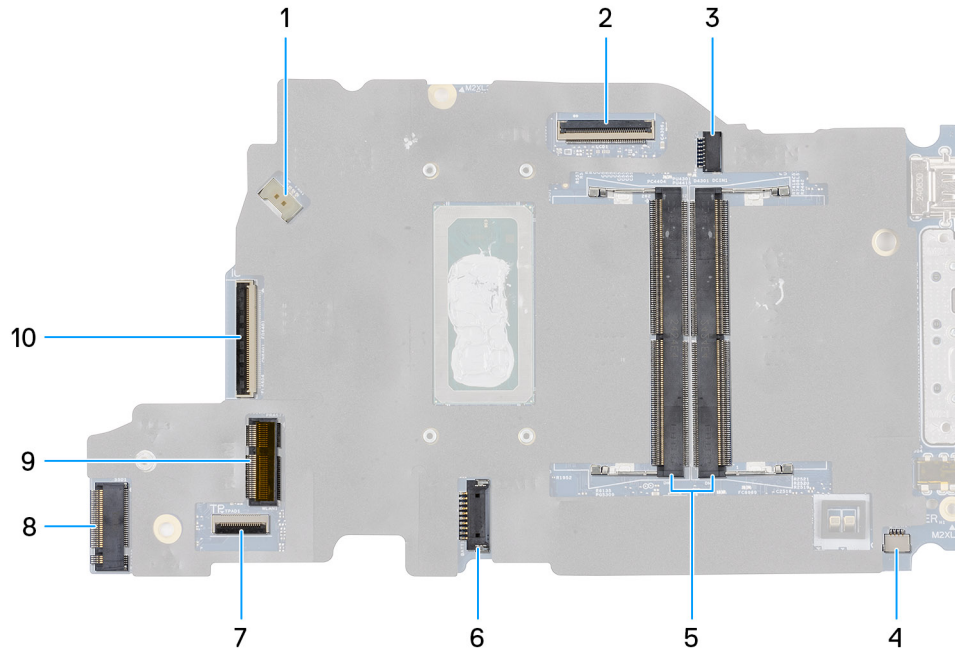

**Figure 60. System-board connectors**

- |   |                                    |
|---|------------------------------------|
| 1. Fan-cable connector (FAN1)             | 2. Display-cable connector (LCD1)  |
| 3. DC-in port connector (DCIN1)           | 4. Speaker-cable connector (SPK1)  |
| 5. Memory-module connectors (DM1 AND DM2) | 6. Battery-cable connector (BATT1) |
| 7. Touchpad-cable connector (TPAD1)       | 8. SSD slot (SSD1)                 |
| 9. Wireless-card connector (WLAN1)        | 10. I/O-board cable connector (IO) |

The following images indicate the location of the system board and provide a visual representation of the removal procedure.

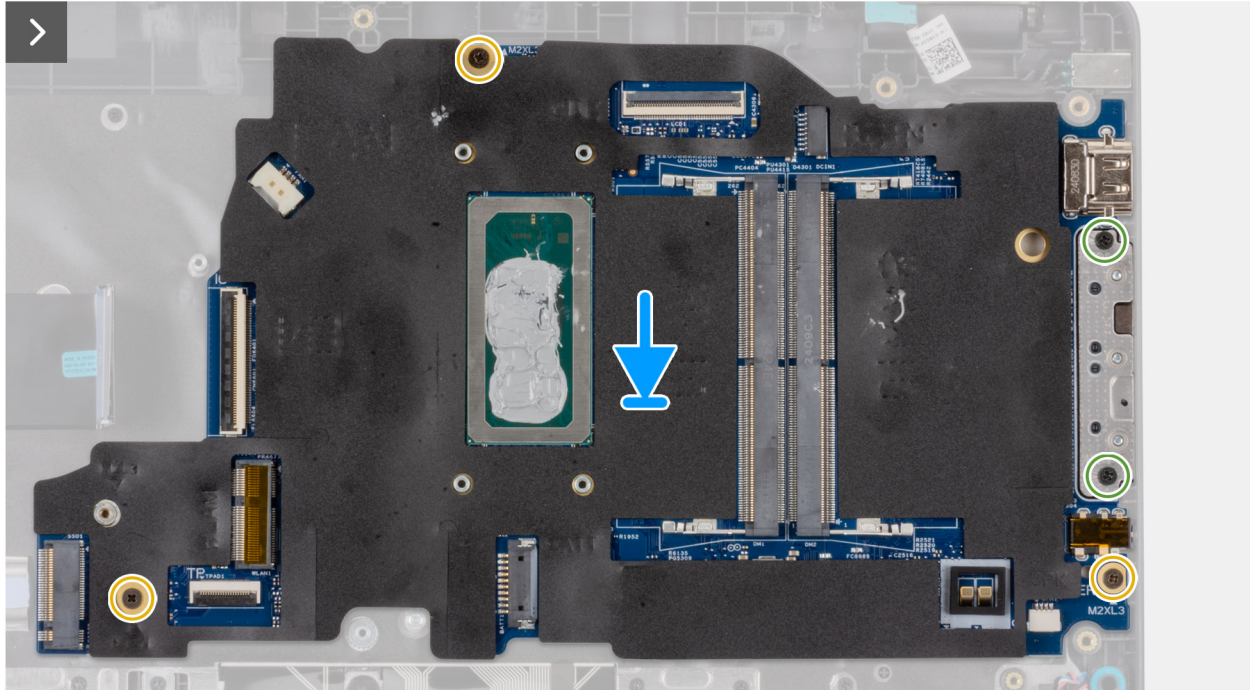
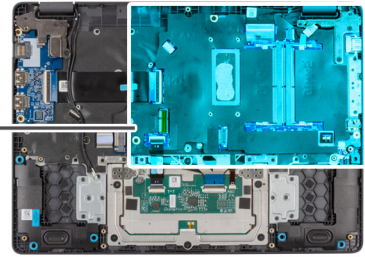
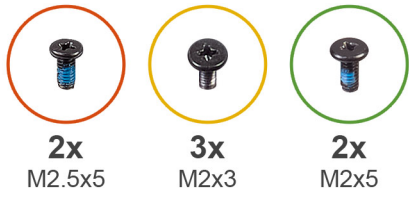
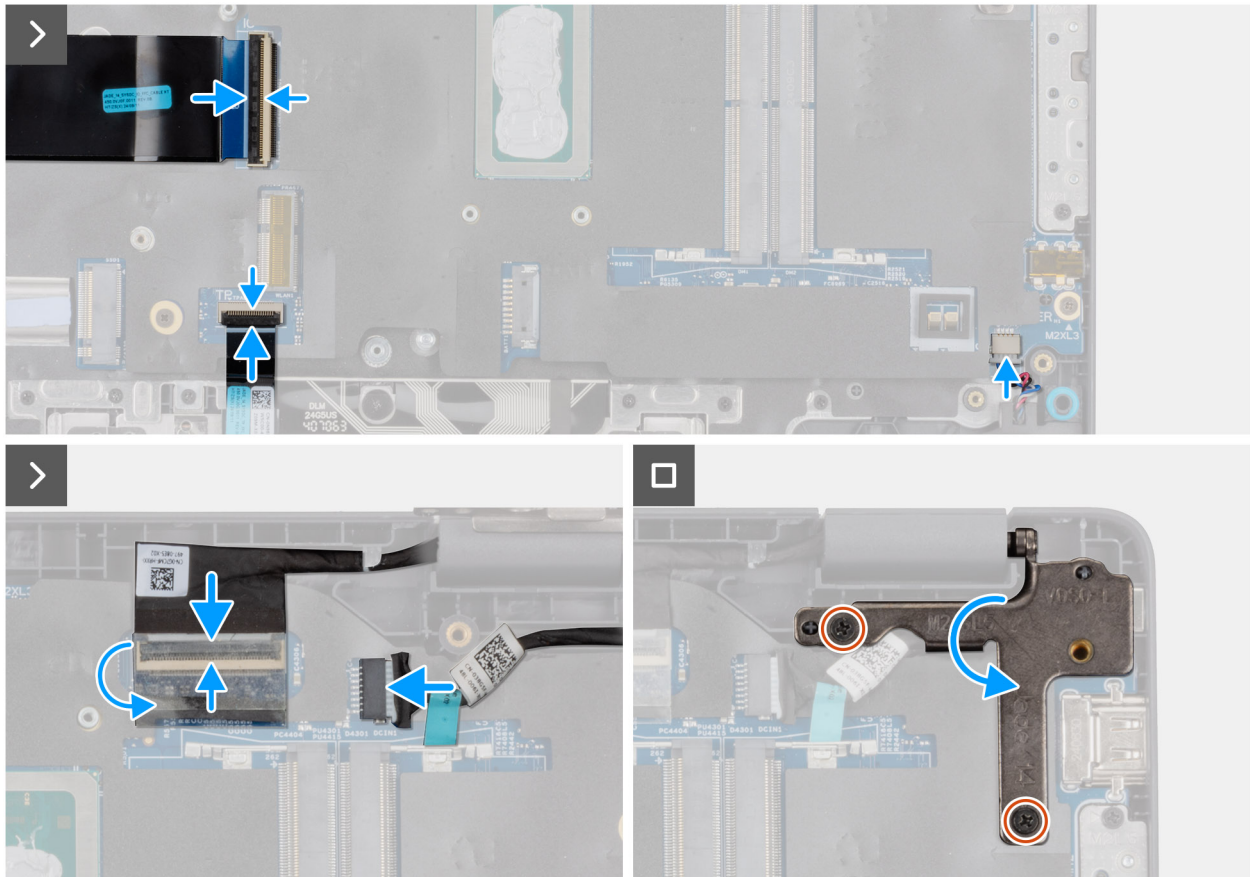

Figure 61. Installing the system board



**Figure 62. Installing the system board**

**Steps**

1. Align the screw holes on the system board with the screw holes on the palm-rest assembly.
  2. Replace the three screws (M2x3) that secure the system board to the palm-rest assembly.
  3. Replace the two screws (M2x5) that secure the Type-C module to the system board.
  4. Connect the following cables to the respective connectors on the system board:
    - I/O-board cable
    - Touchpad cable
    - Speaker cable
    - Display cable (EDP)
    - Power-adapter port cable
  5. Gently press the left display-hinge in a downward direction towards the system board.
  6. Replace the two screws (M2.5x5) that secure the left display-hinge to the palm-rest assembly.
- NOTE:** When replacing the system board, ensure that the USB Type-C module is removed and transferred to the replacement system board.

**Next steps**

1. Install the [display assembly](#).
2. Install the [heat sink](#).
3. Install the [fan](#).
4. Install the [wireless card](#).
5. Install the [SSD](#).
6. Install the [memory module](#).
7. Install the [battery](#).
8. Install the [base cover](#).
9. Follow the procedure in [After working inside your computer](#).

# Removing the system board (For computers shipped with Intel Core Ultra 200U Series)

**CAUTION:** The information in this removal section is intended for authorized service technicians only.

## Prerequisites

1. Follow the procedure in [Before working inside your computer](#).
2. Remove the [base cover](#).
3. Remove the [battery](#).
4. Remove the [memory module](#).
5. Remove the [SSD](#).
6. Remove the [wireless card](#).
7. Remove the [fan](#).
8. Remove the [heat sink](#).
9. Remove the [display assembly](#).

## About this task

The following image indicates the connectors on your system board.

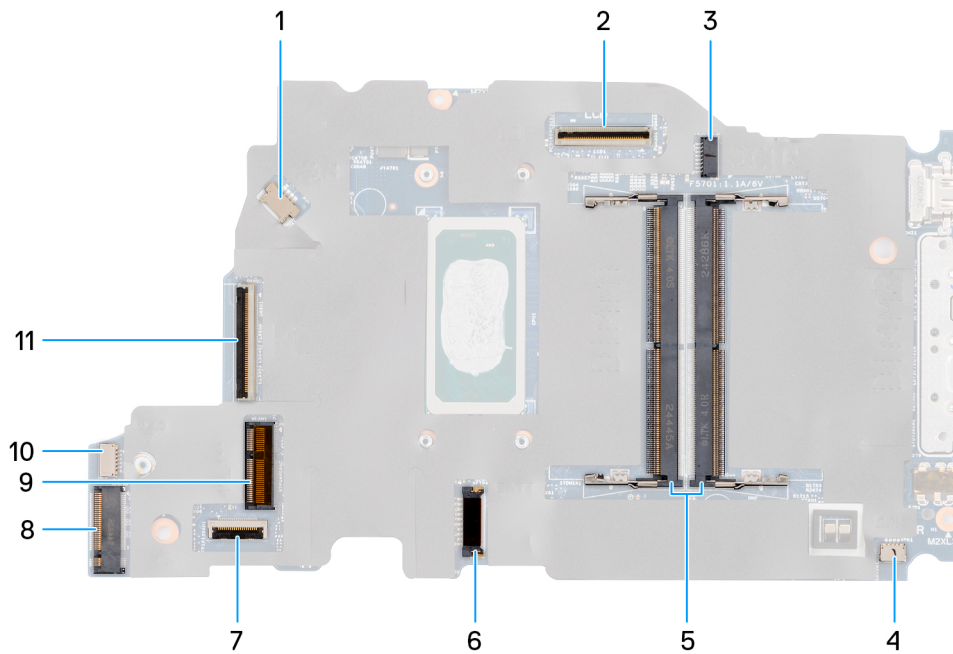

**Figure 63. System-board connectors**

- |   |                                    |
|---|------------------------------------|
| 1. Fan-cable connector (FAN1)             | 2. Display-cable connector (LCD1)  |
| 3. DC-in port connector (DCIN1)           | 4. Speaker-cable connector (SPK1)  |
| 5. Memory-module connectors (DM1 AND DM2) | 6. Battery-cable connector (BATT1) |
| 7. Touchpad-cable connector (TPAD1)       | 8. SSD slot (SSD1)                 |
| 9. Wireless-card connector (WLAN1)        | 10. vPro cable connector           |
| 11. I/O-board cable connector (IO)        |                                    |

The following images indicate the location of the system board and provide a visual representation of the removal procedure.

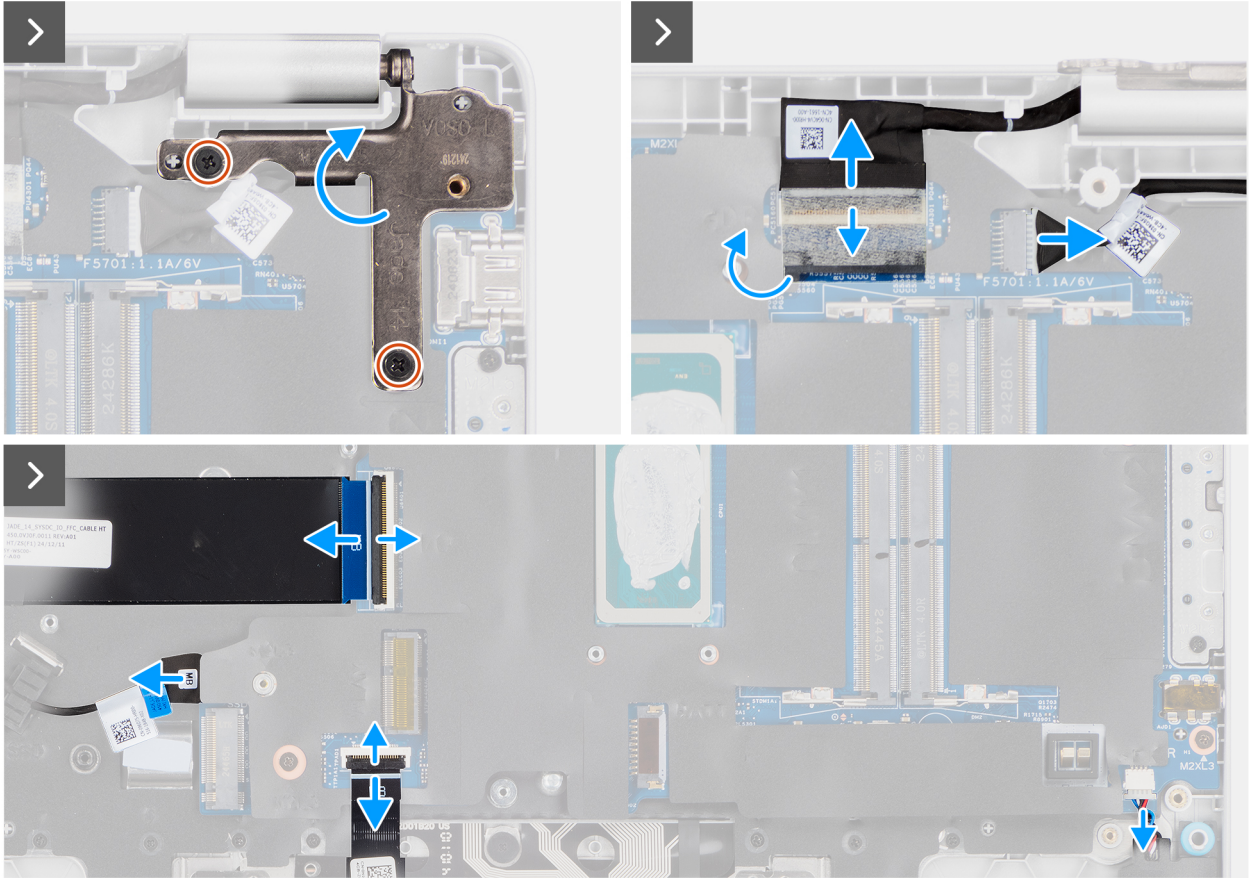
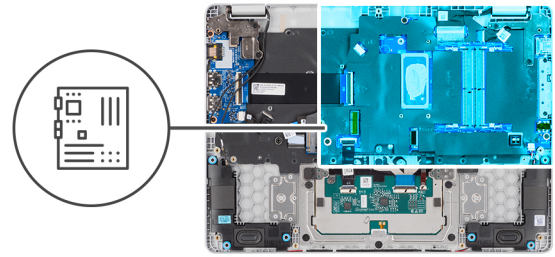
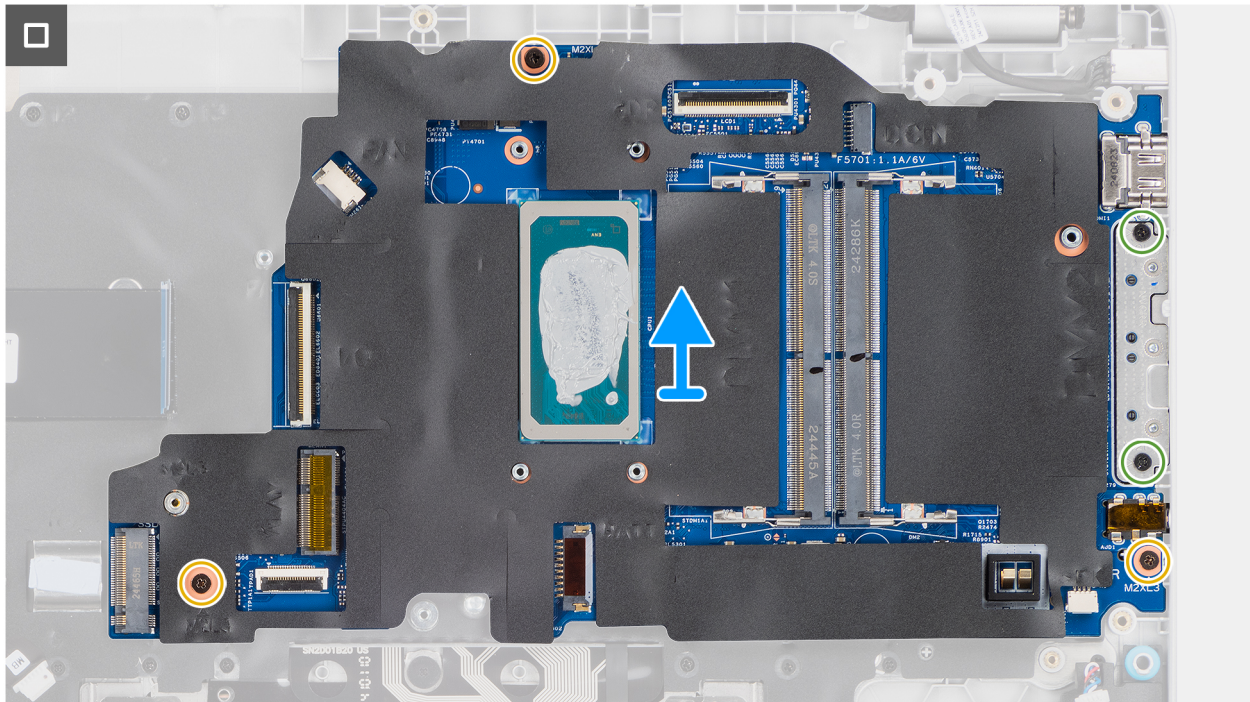

Figure 64. Removing the system board



**Figure 65. Removing the system board**

### Steps

1. Remove the two screws (M2.5x5) that secure the left display-hinge to the palm-rest assembly.
2. Lift the left display-hinge in an upward direction away from the system board.
3. Disconnect the following cables from the respective connectors on the system board:
  - Display cable (EDP)
  - Power-adapter port cable
  - Speaker cable
  - Touchpad cable
  - vPro cable
  - I/O-board cable
4. Remove the two screws (M2x5) that secure the Type-C module to the system board.
5. Remove the three screws (M2x3) that secure the system board to the palm-rest assembly.
6. Lift the system board off the palm-rest assembly.

## Installing the system board (For computers shipped with Intel Core Ultra 200U Series)

**CAUTION:** The information in this installation section is intended for authorized service technicians only.

### Prerequisites

If you are replacing a component, remove the existing component before performing the installation procedure.

### About this task

The following image indicates the connectors on your system board.

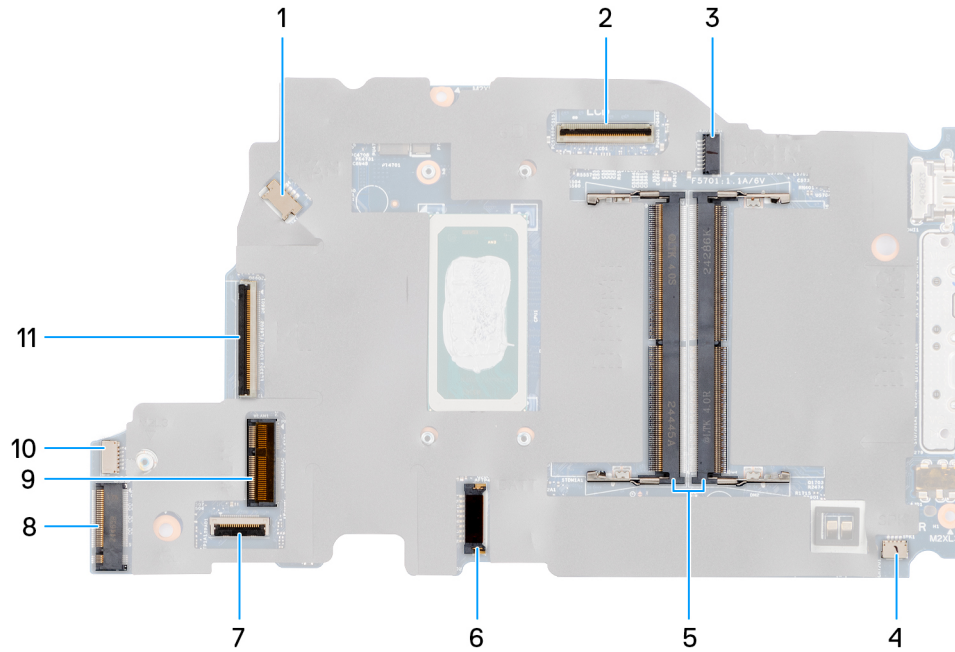

**Figure 66. System-board connectors**

- |   |                                    |
|---|------------------------------------|
| 1. Fan-cable connector (FAN1)             | 2. Display-cable connector (LCD1)  |
| 3. DC-in port connector (DCIN1)           | 4. Speaker-cable connector (SPK1)  |
| 5. Memory-module connectors (DM1 AND DM2) | 6. Battery-cable connector (BATT1) |
| 7. Touchpad-cable connector (TPAD1)       | 8. SSD slot (SSD1)                 |
| 9. Wireless-card connector (WLAN1)        | 10. vPro cable connector           |
| 11. I/O-board cable connector (IO)        |                                    |

The following images indicate the location of the system board and provide a visual representation of the removal procedure.

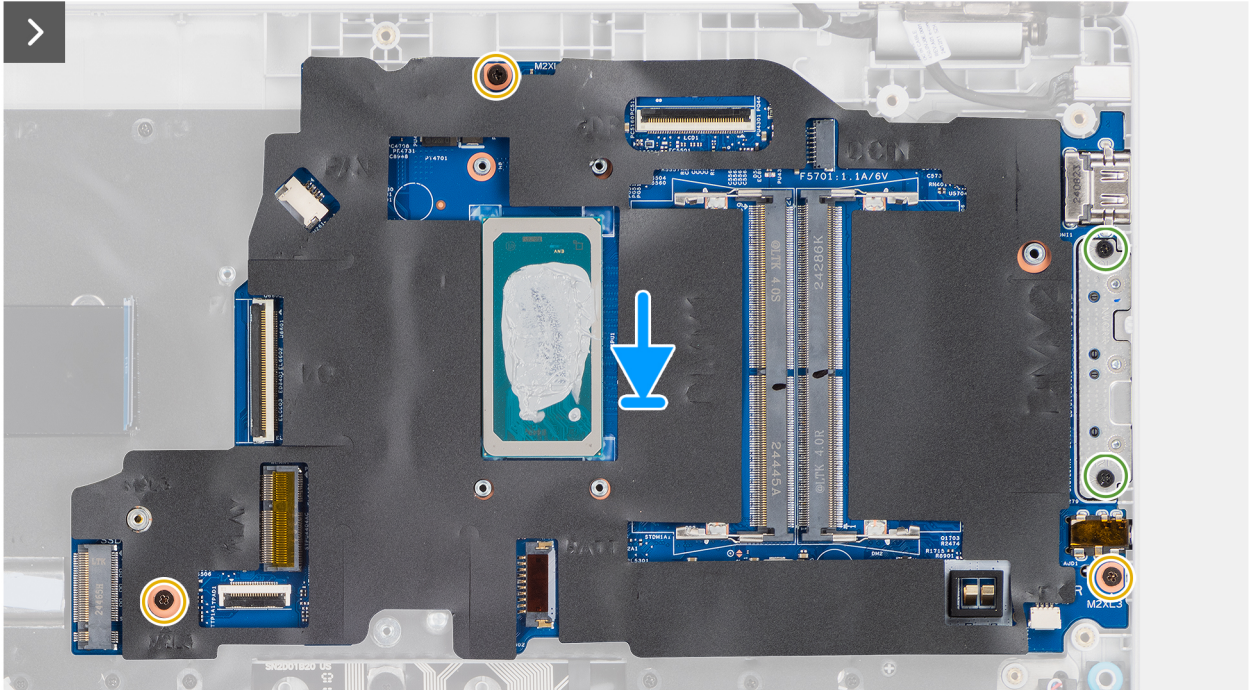
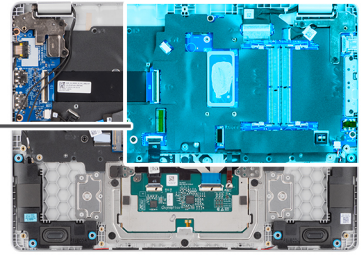
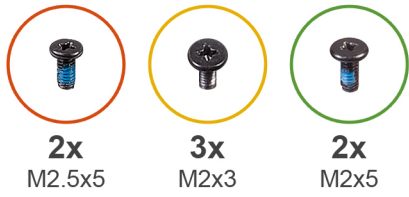
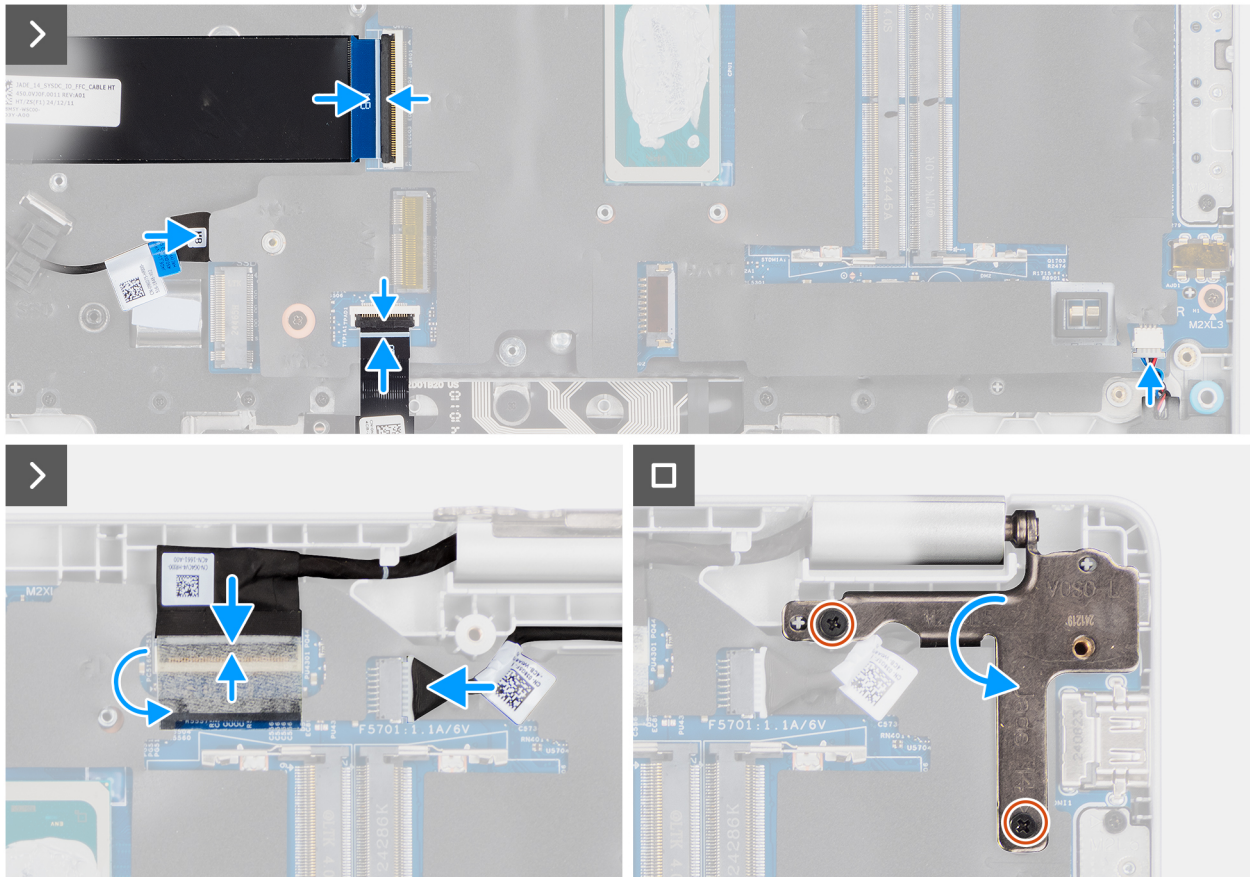

Figure 67. Installing the system board



**Figure 68. Installing the system board**

**Steps**

1. Align the screw holes on the system board with the screw holes on the palm-rest assembly.
2. Replace the three screws (M2x3) that secure the system board to the palm-rest assembly.
3. Replace the two screws (M2x5) that secure the Type-C module to the system board.
4. Connect the following cables to the respective connectors on the system board:
  - I/O-board cable
  - vPro cable
  - Touchpad cable
  - Speaker cable
  - Display cable (EDP)
  - Power-adapter port cable
5. Gently press the left display-hinge in a downward direction towards the system board.
6. Replace the two screws (M2.5x5) that secure the left display-hinge to the palm-rest assembly.

**NOTE:** When replacing the system board, ensure that the USB Type-C module is removed and transferred to the replacement system board.

**Next steps**

1. Install the [display assembly](#).
2. Install the [heat sink](#).
3. Install the [fan](#).
4. Install the [wireless card](#).
5. Install the [SSD](#).
6. Install the [memory module](#).
7. Install the [battery](#).
8. Install the [base cover](#).

9. Follow the procedure in [After working inside your computer](#).

## Removing the system board (For computers shipped with smart card reader)

**CAUTION:** The information in this removal section is intended for authorized service technicians only.

### Prerequisites

1. Follow the procedure in [Before working inside your computer](#).
2. Remove the [base cover](#).
3. Remove the [battery](#).
4. Remove the [memory module](#).
5. Remove the [SSD](#).
6. Remove the [wireless card](#).
7. Remove the [fan](#).
8. Remove the [heat sink](#).
9. Remove the [display assembly](#).

### About this task

The following image indicates the connectors on your system board.

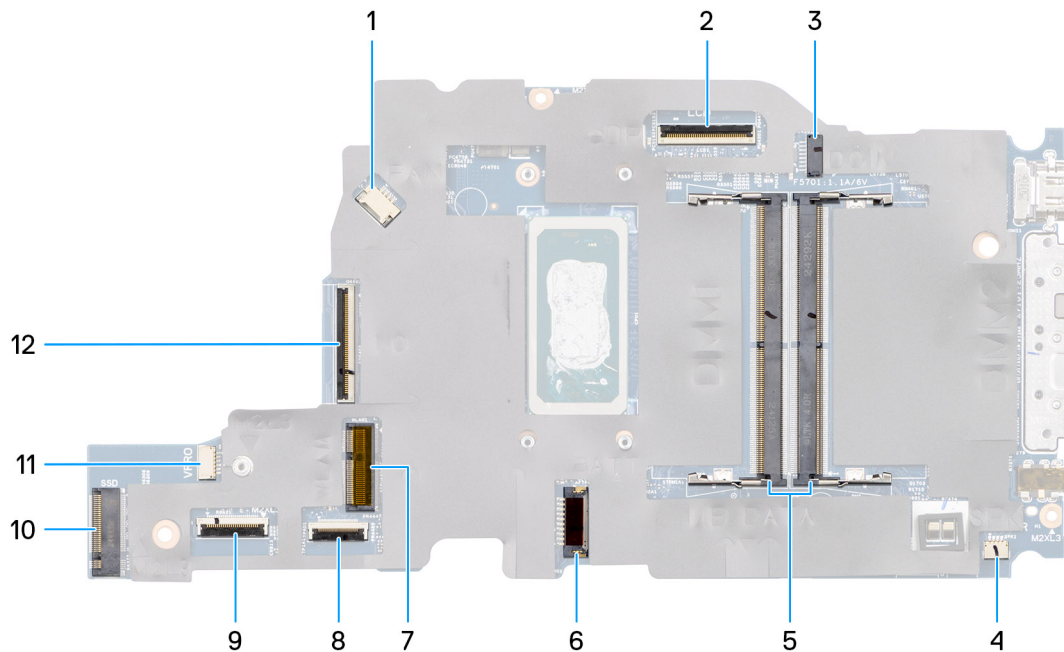

**Figure 69. System-board connectors**

- |   |                                     |
|---|-------------------------------------|
| 1. Fan-cable connector (FAN1)             | 2. Display-cable connector (LCD1)   |
| 3. DC-in port connector (DCIN1)           | 4. Speaker-cable connector (SPK1)   |
| 5. Memory-module connectors (DM1 AND DM2) | 6. Battery-cable connector (BATT1)  |
| 7. Wireless-card connector (WLAN1)        | 8. Touchpad-cable connector (TPAD1) |
| 9. USH board FPC connector                | 10. SSD slot (SSD1)                 |
| 11. vPro cable connector                  | 12. I/O-board cable connector (IO)  |

The following images indicate the location of the system board and provide a visual representation of the removal procedure.

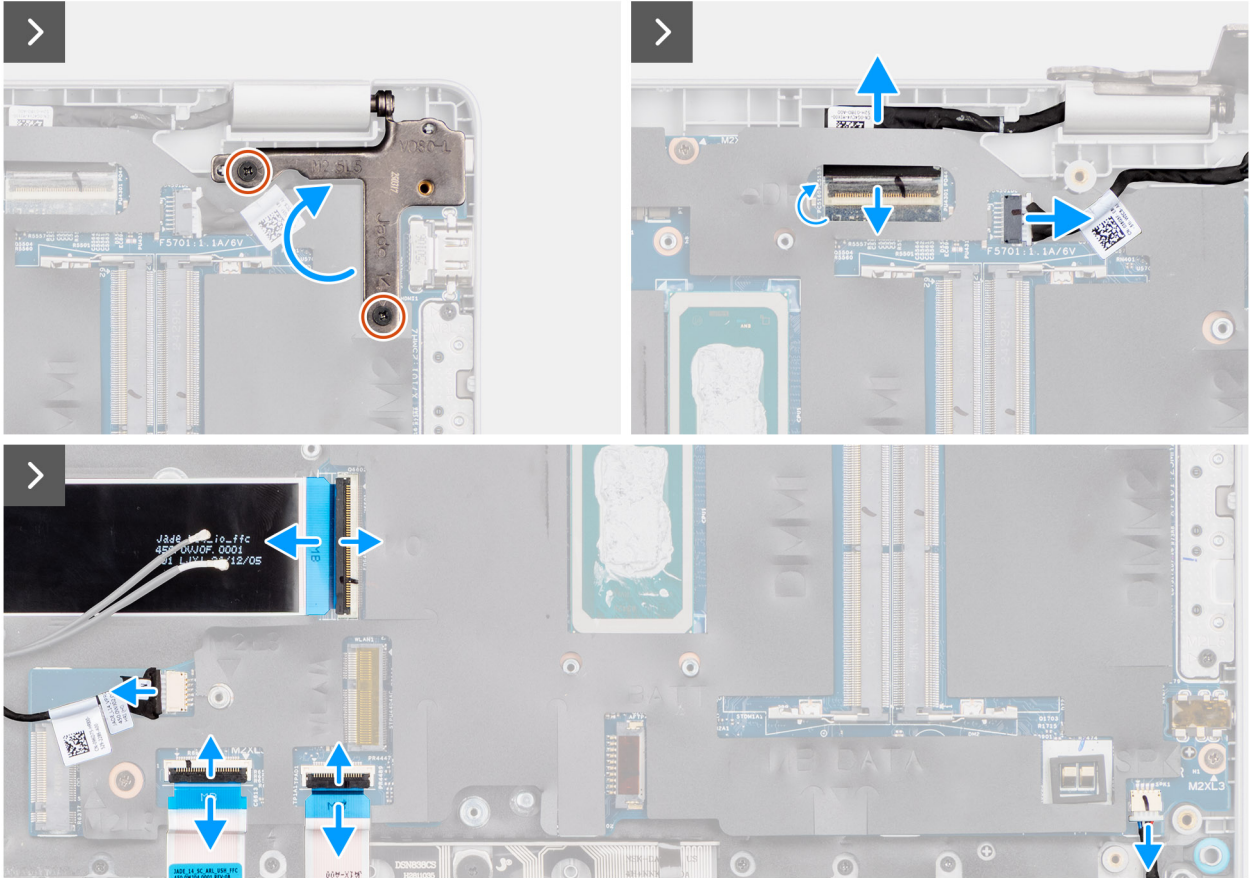
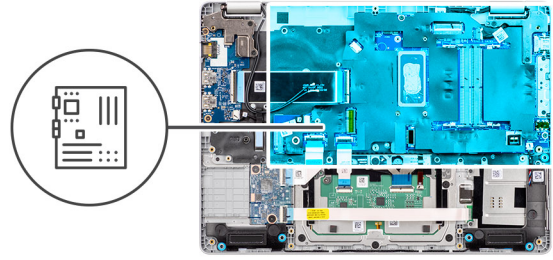
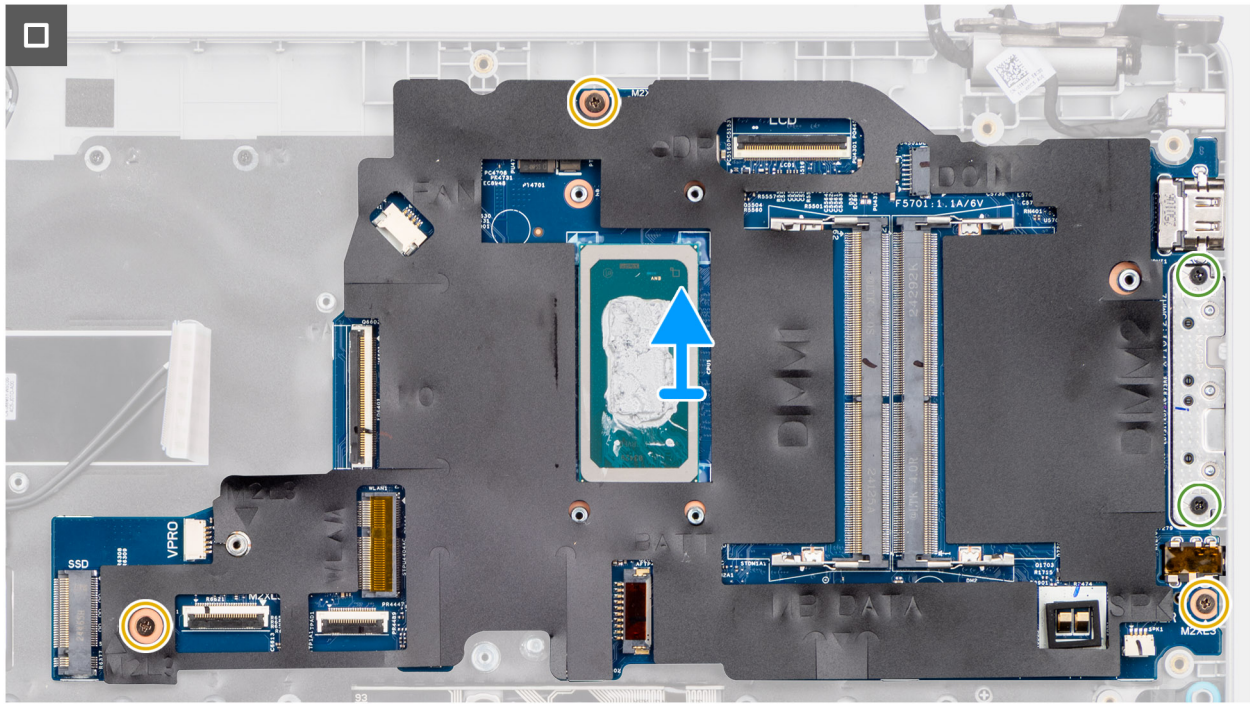

Figure 70. Removing the system board



**Figure 71. Removing the system board**

**Steps**

1. Remove the two screws (M2.5x5) that secure the left display-hinge to the palm-rest assembly.
2. Lift the left display-hinge in an upward direction away from the system board.
3. Disconnect the following cables from the respective connectors on the system board:
  - Display cable (EDP)
  - Power-adapter port cable
  - Speaker cable
  - Touchpad cable
  - USh board FPC
  - vPro cable
  - I/O-board cable
4. Remove the two screws (M2x5) that secure the Type-C module to the system board.
5. Remove the three screws (M2x3) that secure the system board to the palm-rest assembly.
6. Lift the system board off the palm-rest assembly.

## Installing the system board (For computers shipped with smart card reader)

**CAUTION:** The information in this installation section is intended for authorized service technicians only.

**Prerequisites**

If you are replacing a component, remove the existing component before performing the installation procedure.

**About this task**

The following image indicates the connectors on your system board.

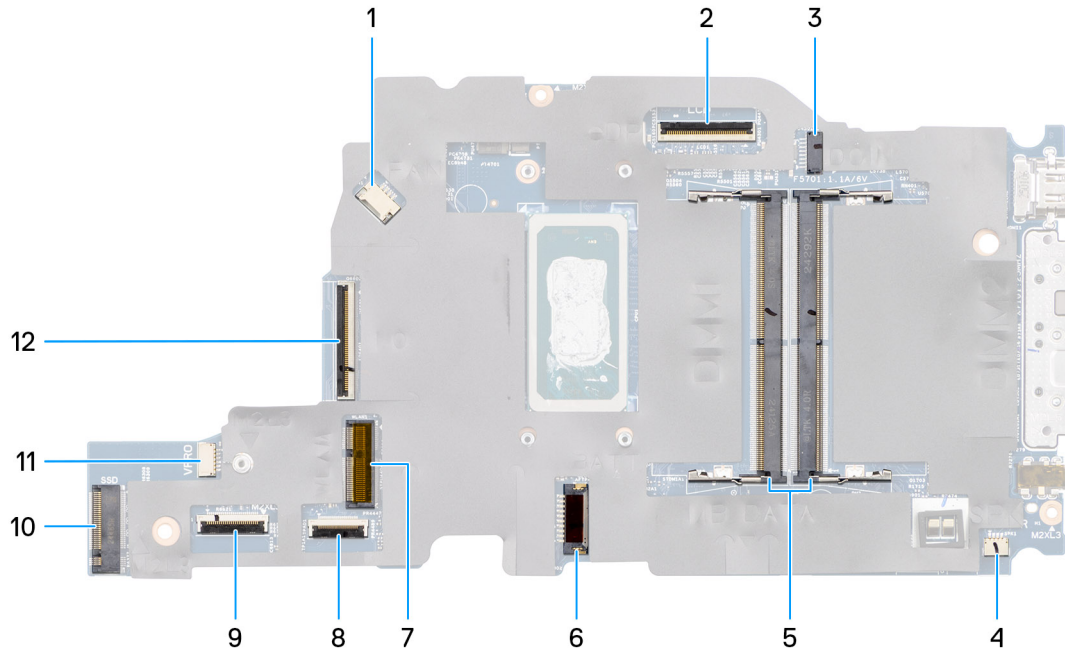

**Figure 72. System-board connectors**

- |   |                                     |
|---|-------------------------------------|
| 1. Fan-cable connector (FAN1)             | 2. Display-cable connector (LCD1)   |
| 3. DC-in port connector (DCIN1)           | 4. Speaker-cable connector (SPK1)   |
| 5. Memory-module connectors (DM1 AND DM2) | 6. Battery-cable connector (BATT1)  |
| 7. Wireless-card connector (WLAN1)        | 8. Touchpad-cable connector (TPAD1) |
| 9. USH board FPC connector                | 10. SSD slot (SSD1)                 |
| 11. vPro cable connector                  | 12. I/O-board cable connector (IO)  |

The following images indicate the location of the system board and provide a visual representation of the removal procedure.



2x  
M2.5x5



3x  
M2x3



2x  
M2x5

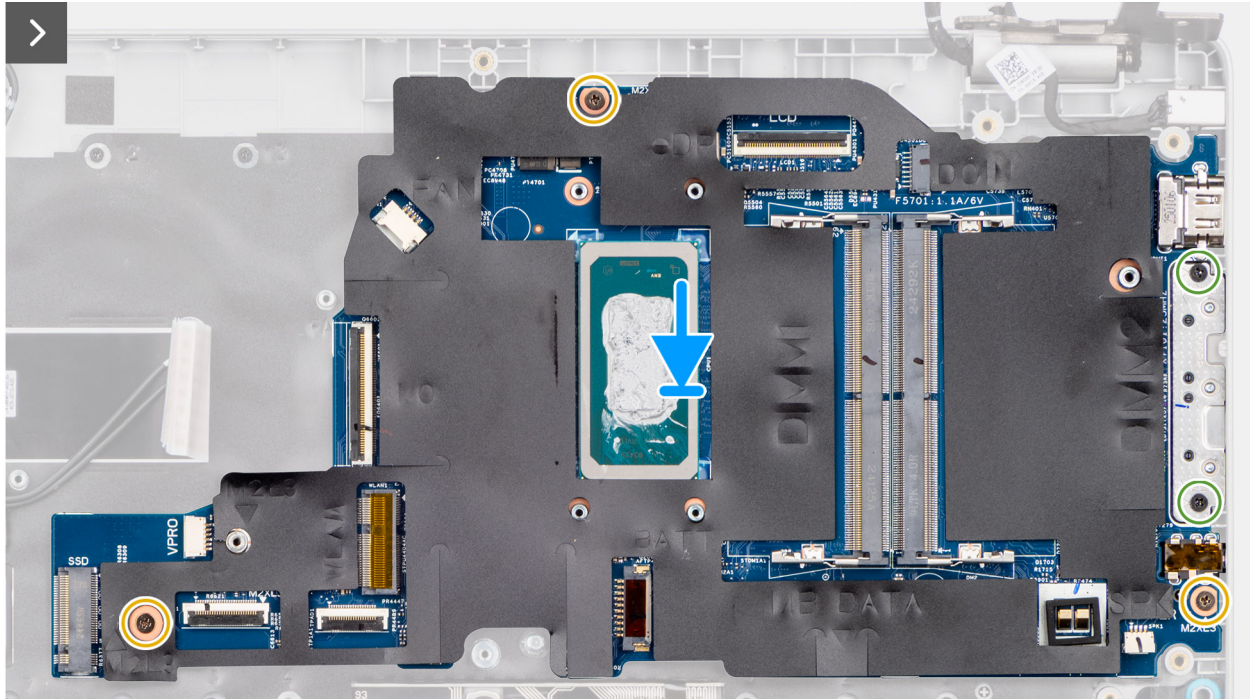
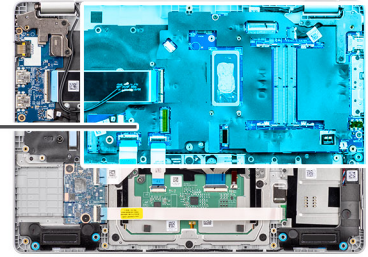
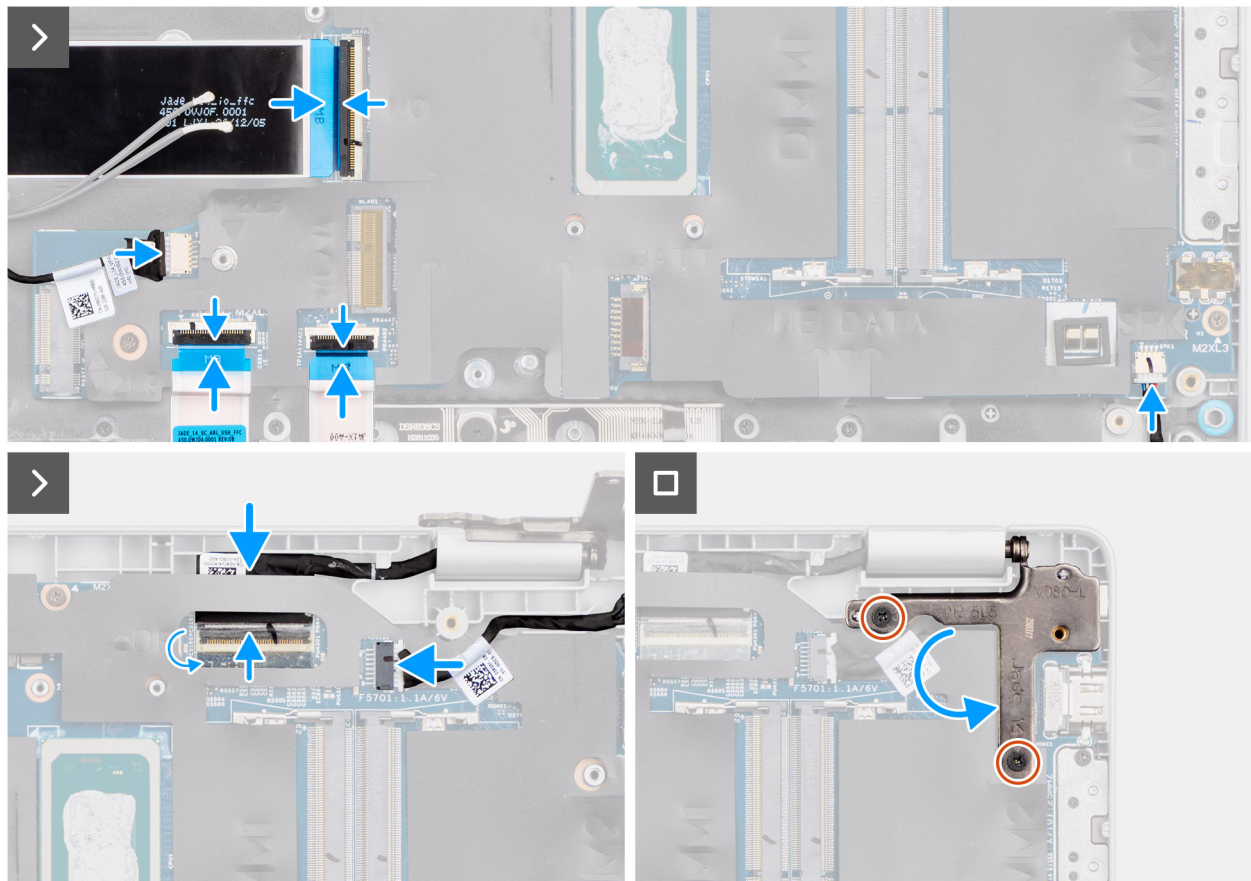

Figure 73. Installing the system board



**Figure 74. Installing the system board**

### Steps

1. Align the screw holes on the system board with the screw holes on the palm-rest assembly.
  2. Replace the three screws (M2x3) that secure the system board to the palm-rest assembly.
  3. Replace the two screws (M2x5) that secure the Type-C module to the system board.
  4. Connect the following cables to the respective connectors on the system board:
    - I/O-board cable
    - vPro cable
    - USH board FPC
    - Touchpad cable
    - Speaker cable
    - Display cable (EDP)
    - Power-adaptor port cable
  5. Gently press the left display-hinge in a downward direction towards the system board.
  6. Replace the two screws (M2.5x5) that secure the left display-hinge to the palm-rest assembly.
- NOTE:** When replacing the system board, ensure that the USB Type-C module is removed and transferred to the replacement system board.

### Next steps

1. Install the [display assembly](#).
2. Install the [heat sink](#).
3. Install the [fan](#).
4. Install the [wireless card](#).
5. Install the [SSD](#).
6. Install the [memory module](#).

7. Install the [battery](#).
8. Install the [base cover](#).
9. Follow the procedure in [After working inside your computer](#).

## USB Type-C module

### Removing the USB Type-C module

**CAUTION:** The information in this removal section is intended for authorized service technicians only.

#### Prerequisites

1. Follow the procedure in [Before working inside your computer](#).
2. Remove the [base cover](#).
3. Remove the [battery](#).
4. Remove the [memory module](#).
5. Remove the [SSD](#).
6. Remove the [wireless card](#).
7. Remove the [fan](#).
8. Remove the [heat sink](#).
9. Remove the [display assembly](#).
10. Remove the system board (for computers shipped with Intel Core Series) or (for computers shipped with Intel Core Ultra 200U Series), whichever is applicable.

#### About this task

**NOTE:** The system board can be removed with the heat sink attached in order to simplify the procedure and preserve the thermal bond between the system board and the heat sink.

The following images indicate the location of the USB Type-C module and provide a visual representation of the removal procedure.

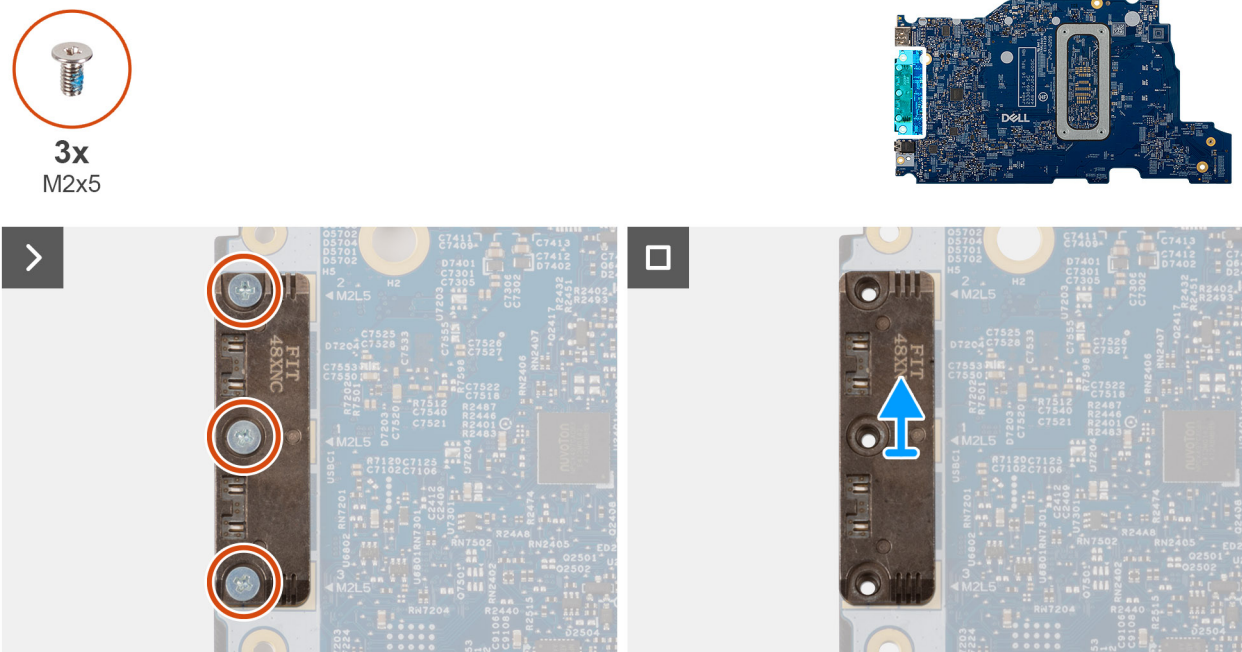

Figure 75. Removing the USB Type-C module

## Steps

1. Turn the system board over and remove the three screws (M2x5) that secure the USB Type-C module to the bottom side of the system board.
2. Remove the USB Type-C module from the system board.

## Installing the USB Type-C module

**CAUTION:** The information in this installation section is intended for authorized service technicians only.

### Prerequisites

If you are replacing a component, remove the existing component before performing the installation procedure.

### About this task

The following images indicate the location of the USB Type-C module and provide a visual representation of the installation procedure.

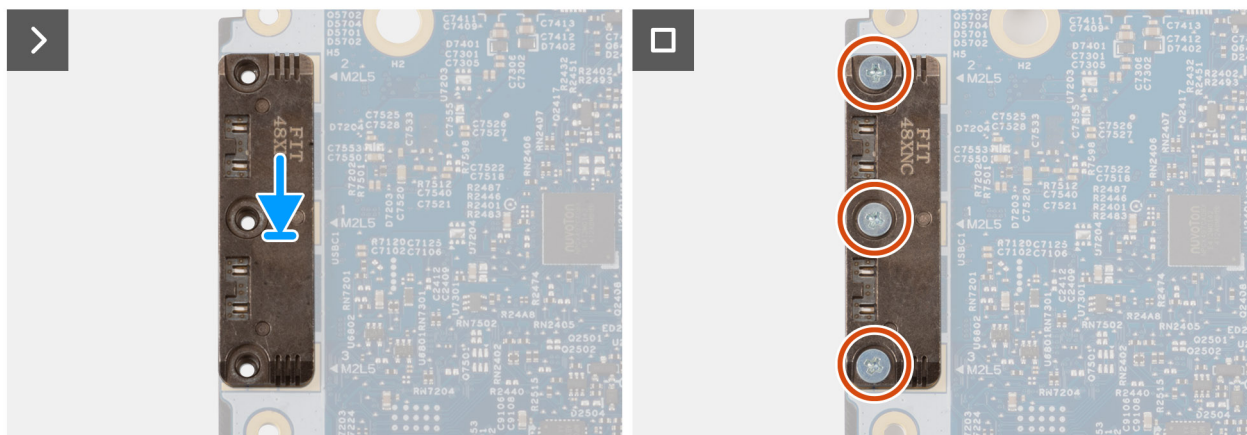
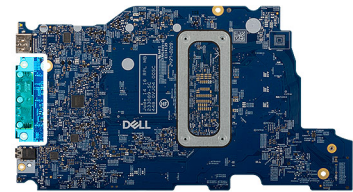

**Figure 76. Installing the USB Type-C module**

## Steps

1. Place the USB Type-C module into the slot on the bottom side of the system board.
2. Replace the three screws (M2x5) that secure the USB Type-C module in place.
3. Turn the system board over.

## Next steps

1. Install the system board (for computers shipped with Intel Core Series) or (for computers shipped with Intel Core Ultra 200U Series), whichever is applicable.
2. Install the [display assembly](#).
3. Install the [heat sink](#).
4. Install the [fan](#).
5. Install the [wireless card](#).
6. Install the [SSD](#).
7. Install the [memory module](#).

8. Install the [battery](#).
9. Install the [base cover](#).
10. Follow the procedure in [After working inside your computer](#).

## Removing the USB Type-C module (For computers shipped with smart card reader)

**⚠ CAUTION:** The information in this removal section is intended for authorized service technicians only.

### Prerequisites

1. Follow the procedure in [Before working inside your computer](#).
2. Remove the [base cover](#).
3. Remove the [battery](#).
4. Remove the [memory module](#).
5. Remove the [SSD](#).
6. Remove the [wireless card](#).
7. Remove the [fan](#).
8. Remove the [heat sink](#).
9. Remove the [display assembly](#).
10. Remove the system board (for computers shipped with smart card reader).

### About this task

**i NOTE:** The system board can be removed with the heat sink attached in order to simplify the procedure and preserve the thermal bond between the system board and the heat sink.

The following images indicate the location of the USB Type-C module and provide a visual representation of the removal procedure.



3x  
M2x5

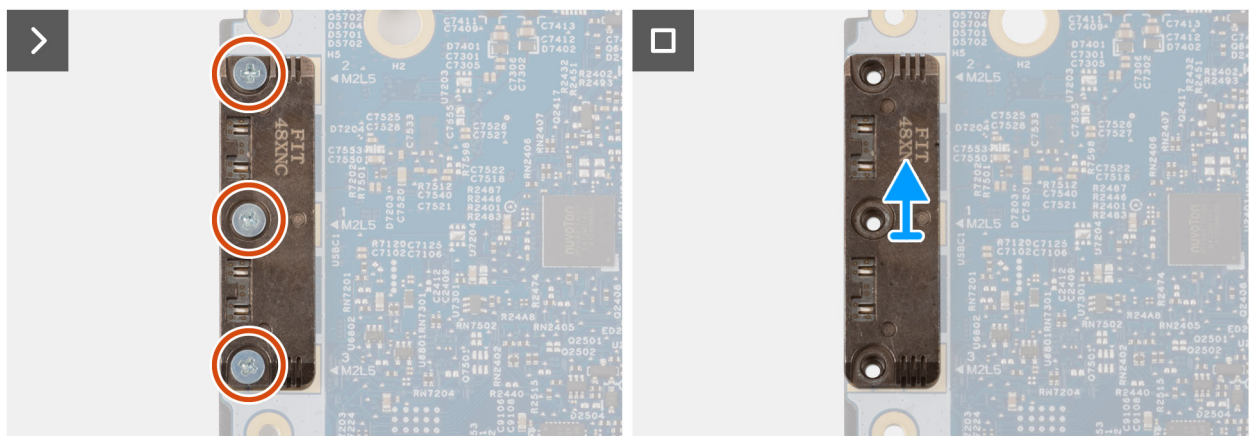
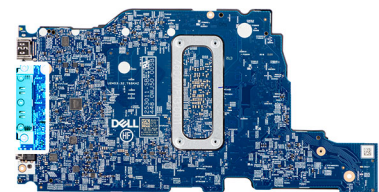

**Figure 77. Removing the USB Type-C module**

### Steps

1. Turn the system board over and remove the three screws (M2x5) that secure the USB Type-C module to the bottom side of the system board.

2. Remove the USB Type-C module from the system board.

## Installing the USB Type-C module (For computers shipped with smart card reader)

**CAUTION:** The information in this installation section is intended for authorized service technicians only.

### Prerequisites

If you are replacing a component, remove the existing component before performing the installation procedure.

### About this task

The following images indicate the location of the USB Type-C module and provide a visual representation of the installation procedure.

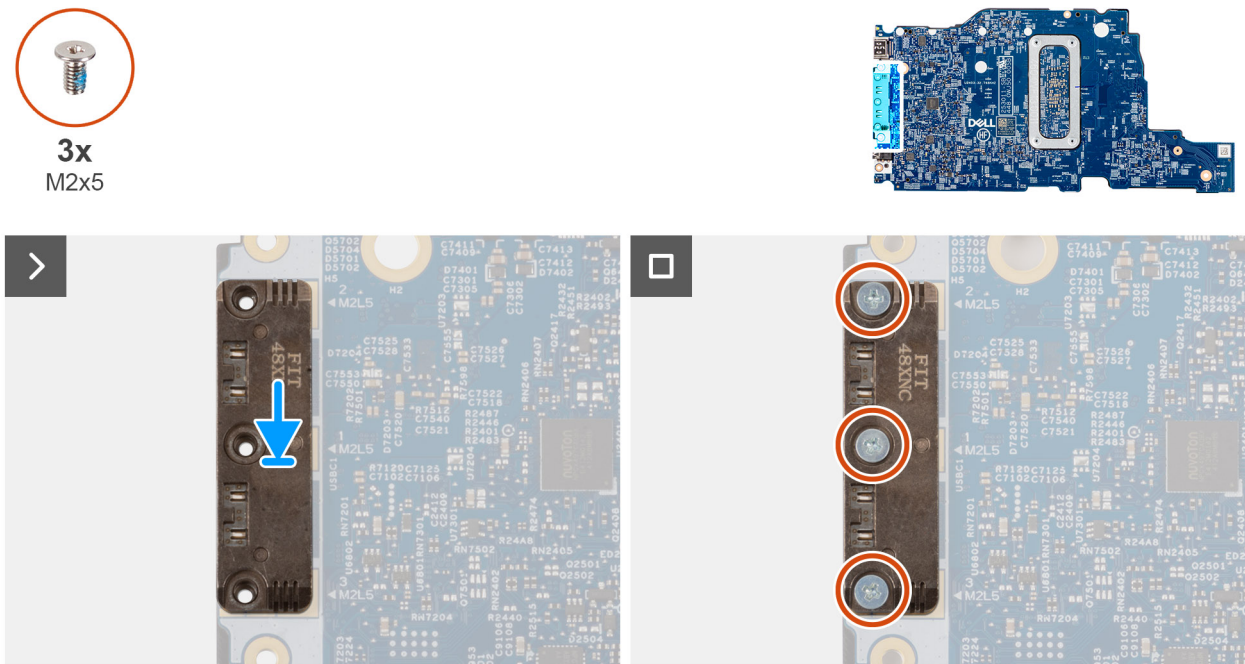

Figure 78. Installing the USB Type-C module

### Steps

1. Place the USB Type-C module into the slot on the bottom side of the system board.
2. Replace the three screws (M2x5) that secure the USB Type-C module in place.
3. Turn the system board over.

### Next steps

1. Install the system board (for computers shipped with smart card reader).
2. Install the [display assembly](#).
3. Install the [heat sink](#).
4. Install the [fan](#).
5. Install the [wireless card](#).
6. Install the [SSD](#).
7. Install the [memory module](#).
8. Install the [battery](#).
9. Install the [base cover](#).
10. Follow the procedure in [After working inside your computer](#).

# Keyboard

## Removing the keyboard

 **CAUTION:** The information in this removal section is intended for authorized service technicians only.

### Prerequisites

1. Follow the procedure in [Before working inside your computer](#).
2. Remove the [base cover](#).
3. Remove the [battery](#).
4. Remove the [memory module](#).
5. Remove the [SSD](#).
6. Remove the [wireless card](#).
7. Remove the [fan](#).
8. Remove the [heat sink](#).
9. Remove the [display assembly](#).
10. Remove the I/O board ([for computers shipped with Intel Core Series](#)) or ([for computers shipped with Intel Core Ultra 200U Series](#)), whichever is applicable.
11. Remove the system board ([for computers shipped with Intel Core Series](#)) or ([for computers shipped with Intel Core Ultra 200U Series](#)), whichever is applicable.
12. Remove the [power-adaptor port](#).

### About this task

 **NOTE:** The system board can be removed with the heat sink attached in order to simplify the procedure and preserve the thermal bond between the system board and the heat sink.

The following images indicate the location of the keyboard and provide a visual representation of the removal procedure.

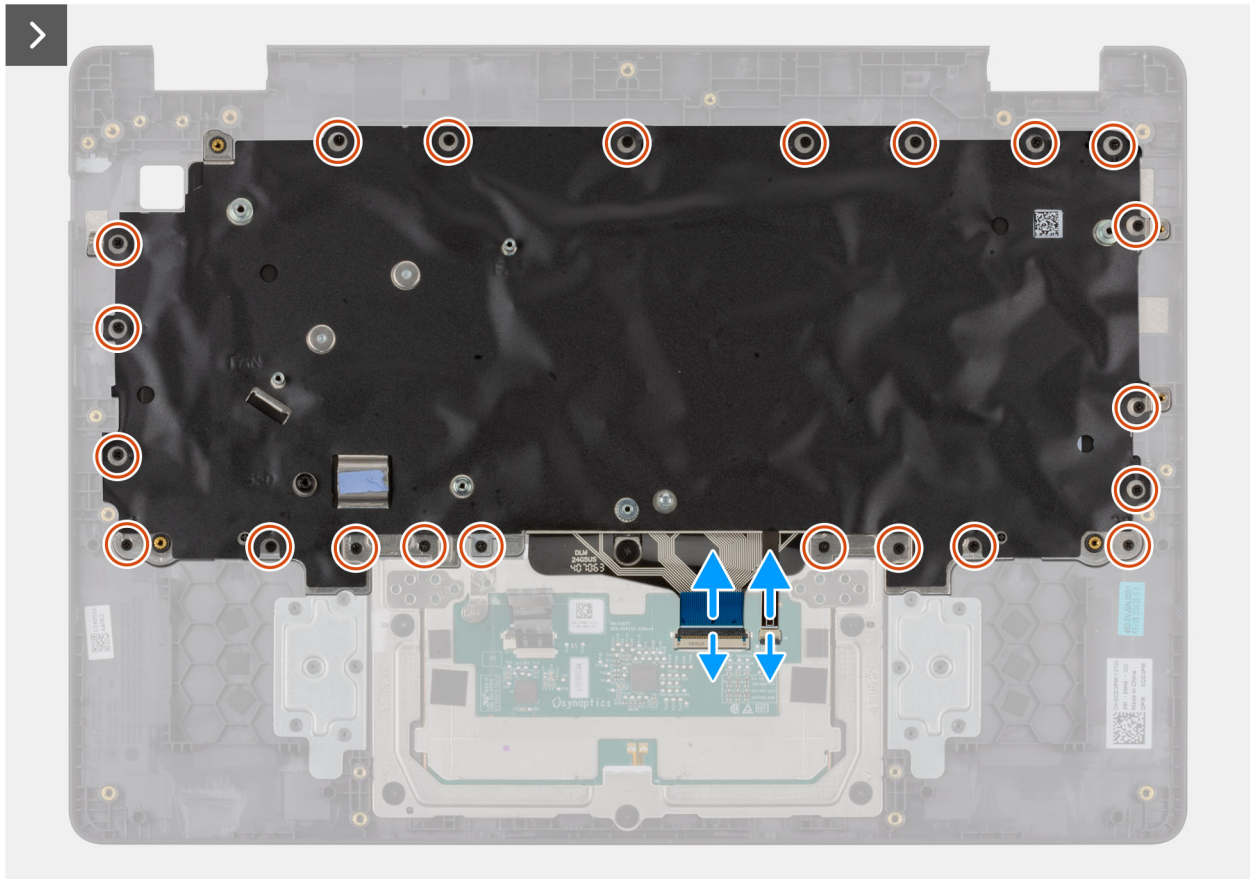
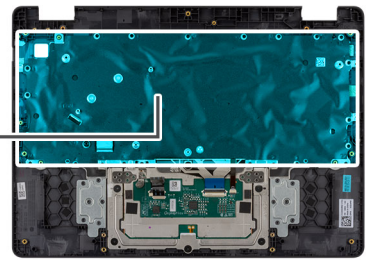
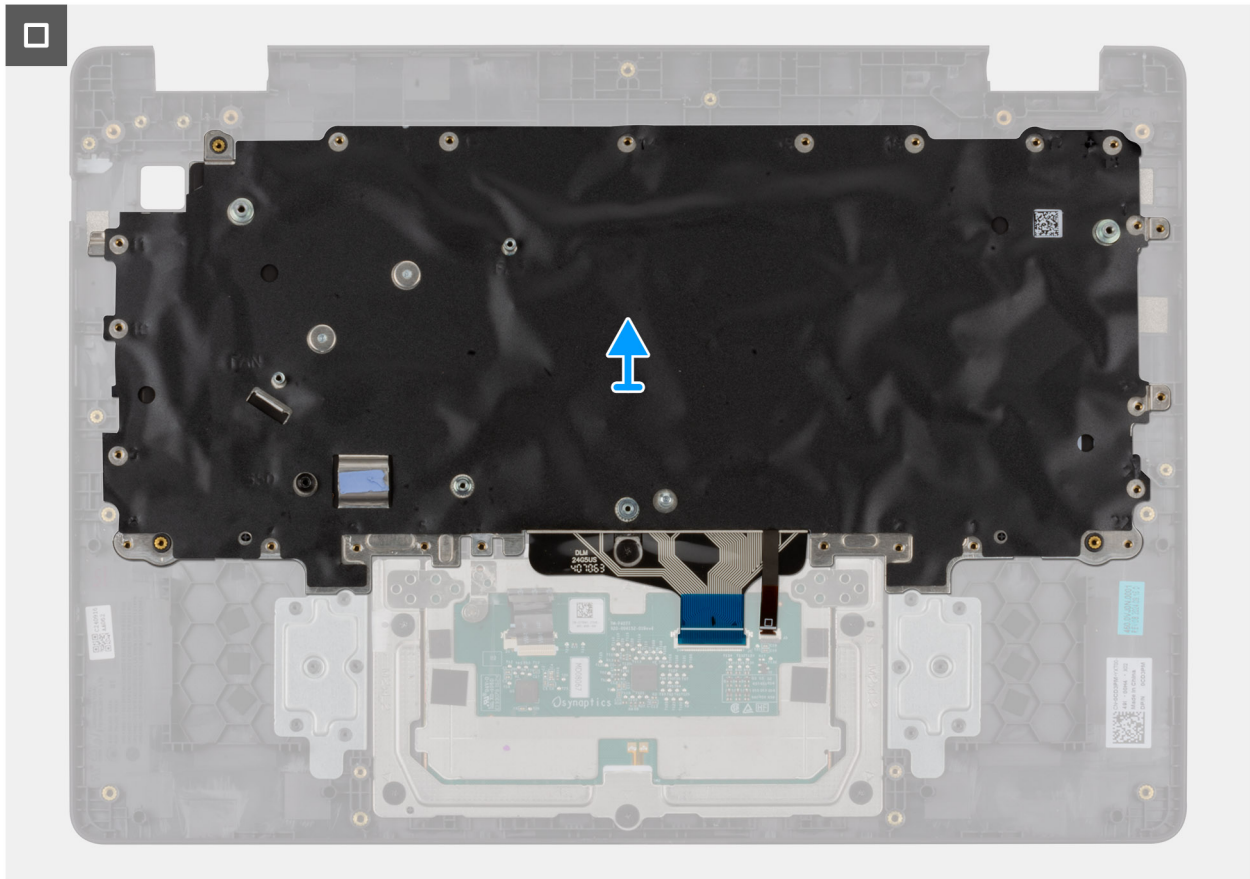

Figure 79. Removing the keyboard



**Figure 80. Removing the keyboard**



**Figure 81. Removing the keyboard**

**Steps**

1. Disconnect the keyboard cable and the keyboard backlit cable from the connectors on the touchpad.
2. Remove the 22 screws (M2x2.2) that secure the keyboard to the palm-rest assembly.
3. Lift the keyboard off the palm-rest assembly.

# Installing the keyboard

**CAUTION:** The information in this installation section is intended for authorized service technicians only.

## Prerequisites

If you are replacing a component, remove the existing component before performing the installation procedure.

## About this task

The following images indicate the location of the keyboard and provide a visual representation of the installation procedure.



Figure 82. Installing the keyboard



22x  
M2x2.2

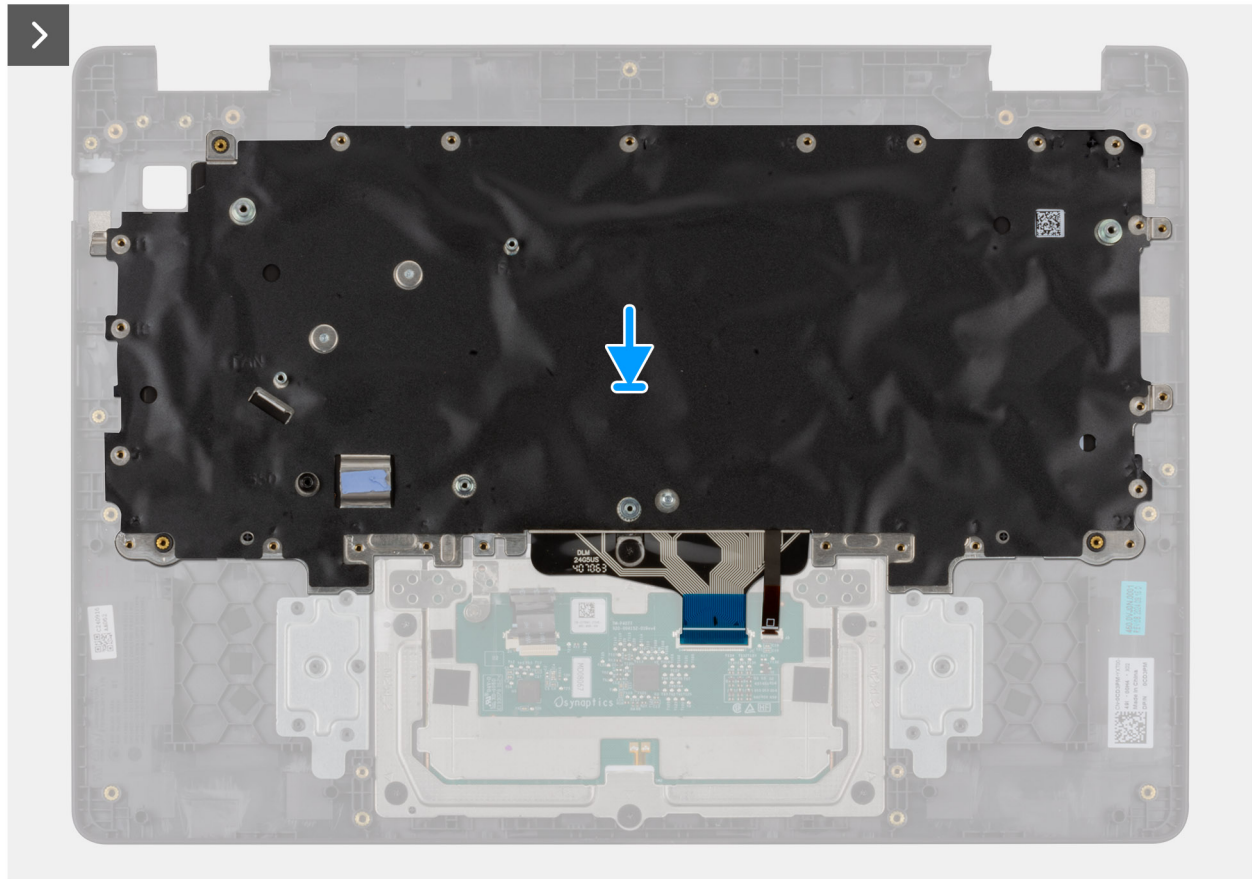
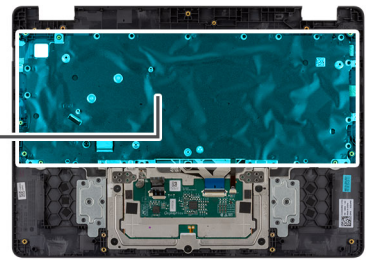
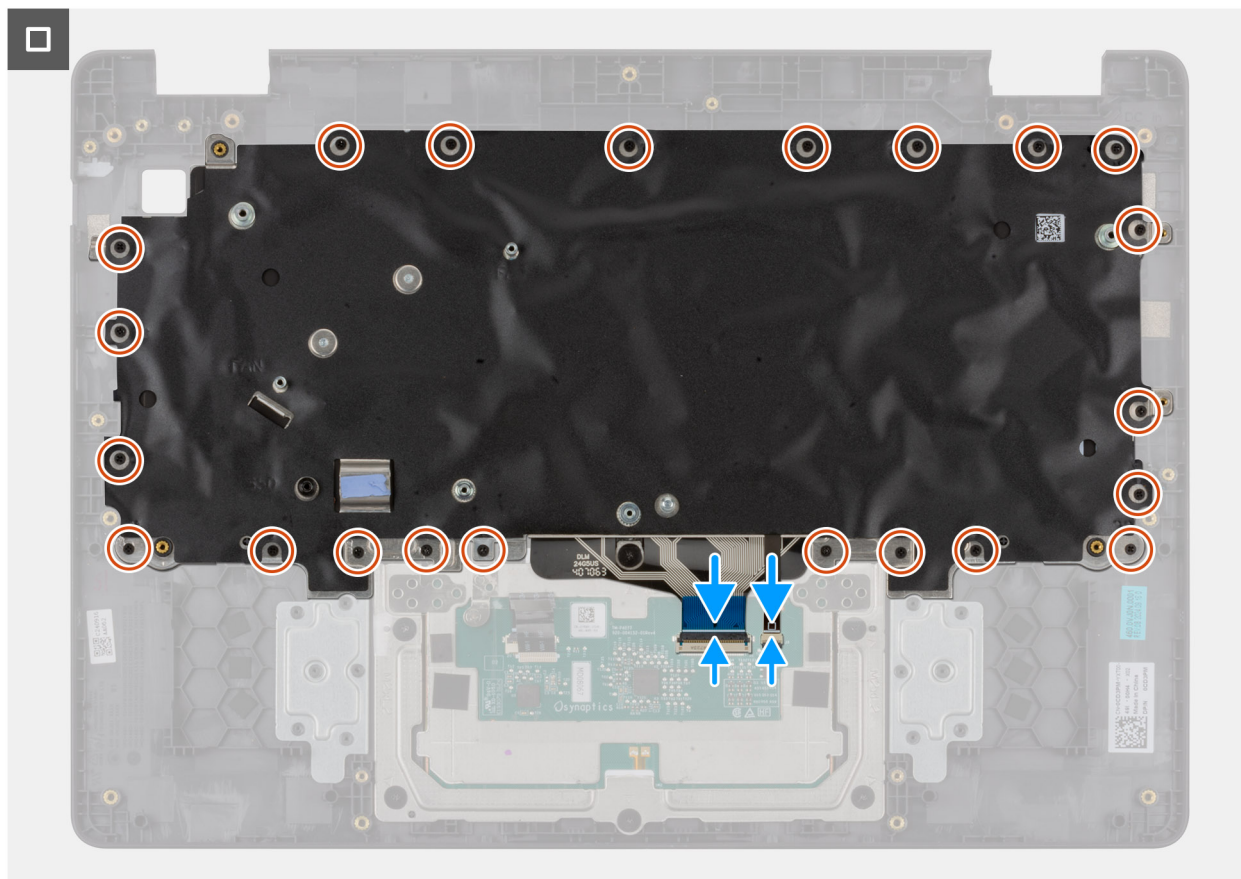

Figure 83. Installing the keyboard



**Figure 84. Installing the keyboard**

#### Steps

1. Align the screw holes on the keyboard with the screw holes on the palm-rest assembly.
2. Connect the keyboard cable and the keyboard backlit cable to the connectors on the touchpad.
3. Replace the 22 screws (M2x2.2) that secure the keyboard to the palm-rest assembly.

#### Next steps

1. Install the [power-adaptor port](#).
2. Install the system board ([for computers shipped with Intel Core Series](#)) or ([for computers shipped with Intel Core Ultra 200U Series](#)), whichever is applicable.
3. Install the I/O board ([for computers shipped with Intel Core Series](#)) or ([for computers shipped with Intel Core Ultra 200U Series](#)), whichever is applicable.
4. Install the [display assembly](#).
5. Install the [heat sink](#).
6. Install the [fan](#).
7. Install the [wireless card](#).
8. Install the [SSD](#).
9. Install the [memory module](#).
10. Install the [battery](#).
11. Install the [base cover](#).
12. Follow the procedure in [After working inside your computer](#).

# Removing the keyboard (For computers shipped with smart card reader)

 **CAUTION:** The information in this removal section is intended for authorized service technicians only.

## Prerequisites

1. Follow the procedure in [Before working inside your computer](#).
2. Remove the [base cover](#).
3. Remove the [battery](#).
4. Remove the [memory module](#).
5. Remove the [SSD](#).
6. Remove the [wireless card](#).
7. Remove the [fan](#).
8. Remove the [heat sink](#).
9. Remove the [display assembly](#).
10. Remove the I/O board [for computers shipped with Intel Core Ultra 200U Series](#).
11. Remove the system board ([for computers shipped with smart card reader](#)).
12. Remove the [power-adaptor port](#).

## About this task

 **NOTE:** The system board can be removed with the heat sink attached in order to simplify the procedure and preserve the thermal bond between the system board and the heat sink.

The following images indicate the location of the keyboard and provide a visual representation of the removal procedure.



21x  
M2x2.2

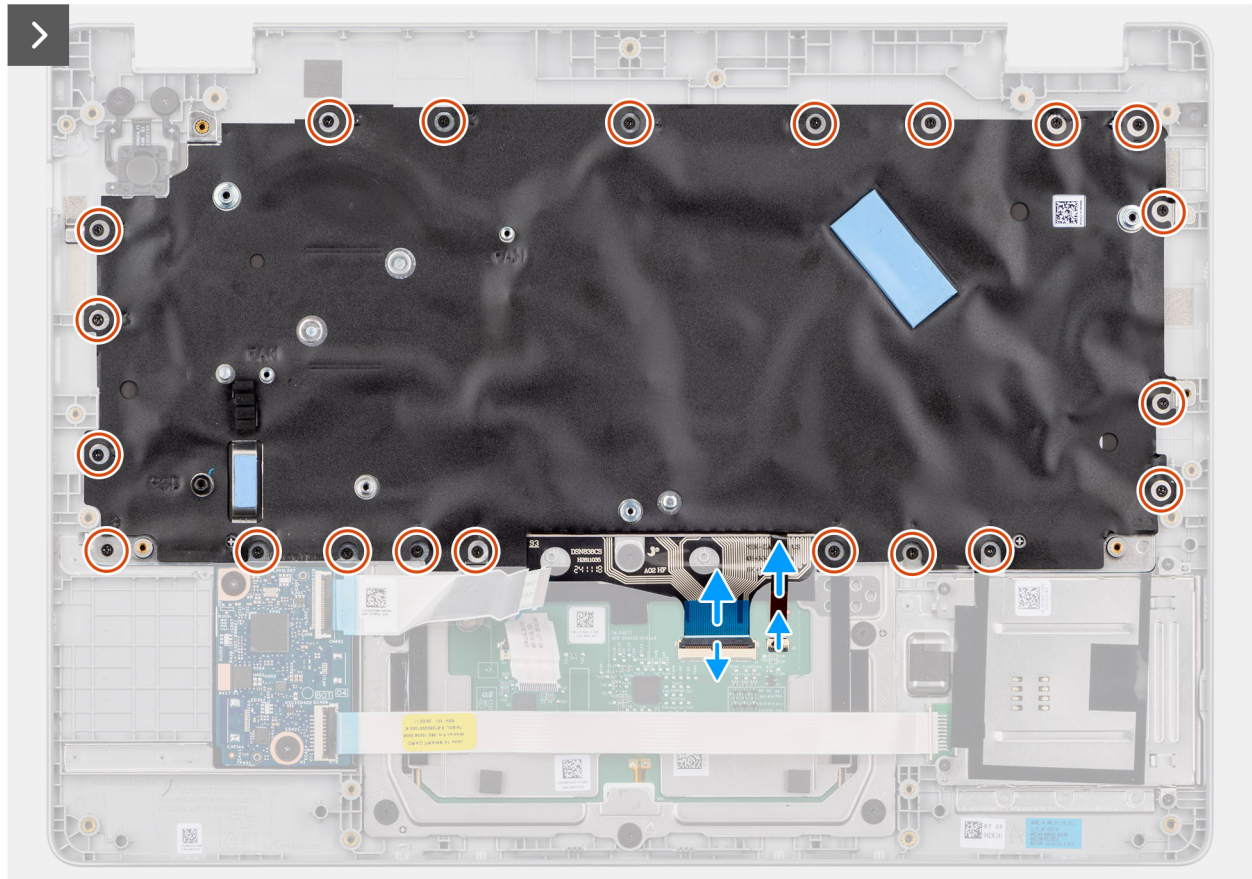
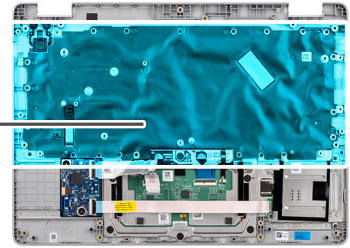
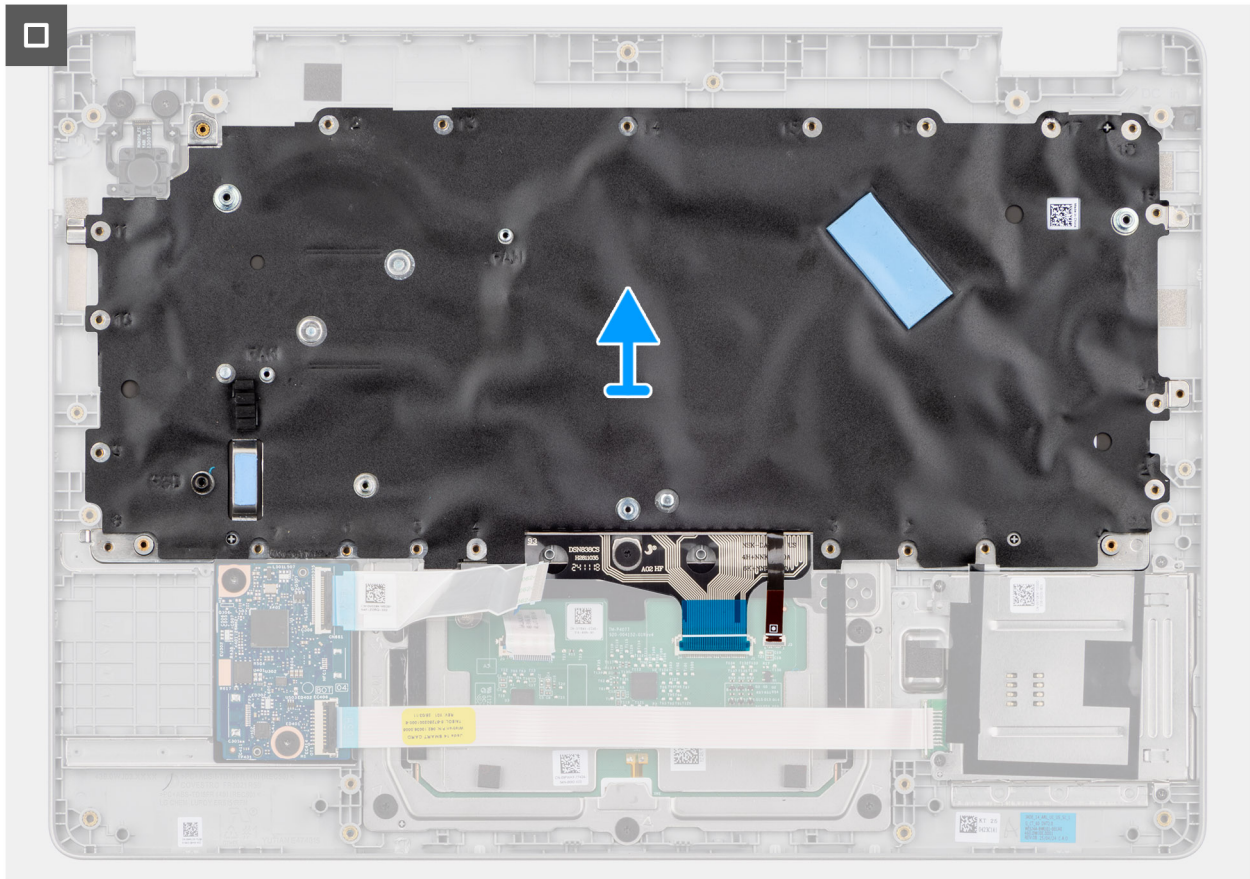

Figure 85. Removing the keyboard



**Figure 86. Removing the keyboard**



**Figure 87. Removing the keyboard**

**Steps**

1. Disconnect the keyboard cable and the keyboard backlit cable from the connectors on the touchpad.
2. Remove the 21 screws (M2x2.2) that secure the keyboard to the palm-rest assembly.
3. Lift the keyboard off the palm-rest assembly.

## Installing the keyboard (For computers shipped with smart card reader)

**CAUTION:** The information in this installation section is intended for authorized service technicians only.

### Prerequisites

If you are replacing a component, remove the existing component before performing the installation procedure.

### About this task

The following images indicate the location of the keyboard and provide a visual representation of the installation procedure.



Figure 88. Installing the keyboard



21x  
M2x2.2

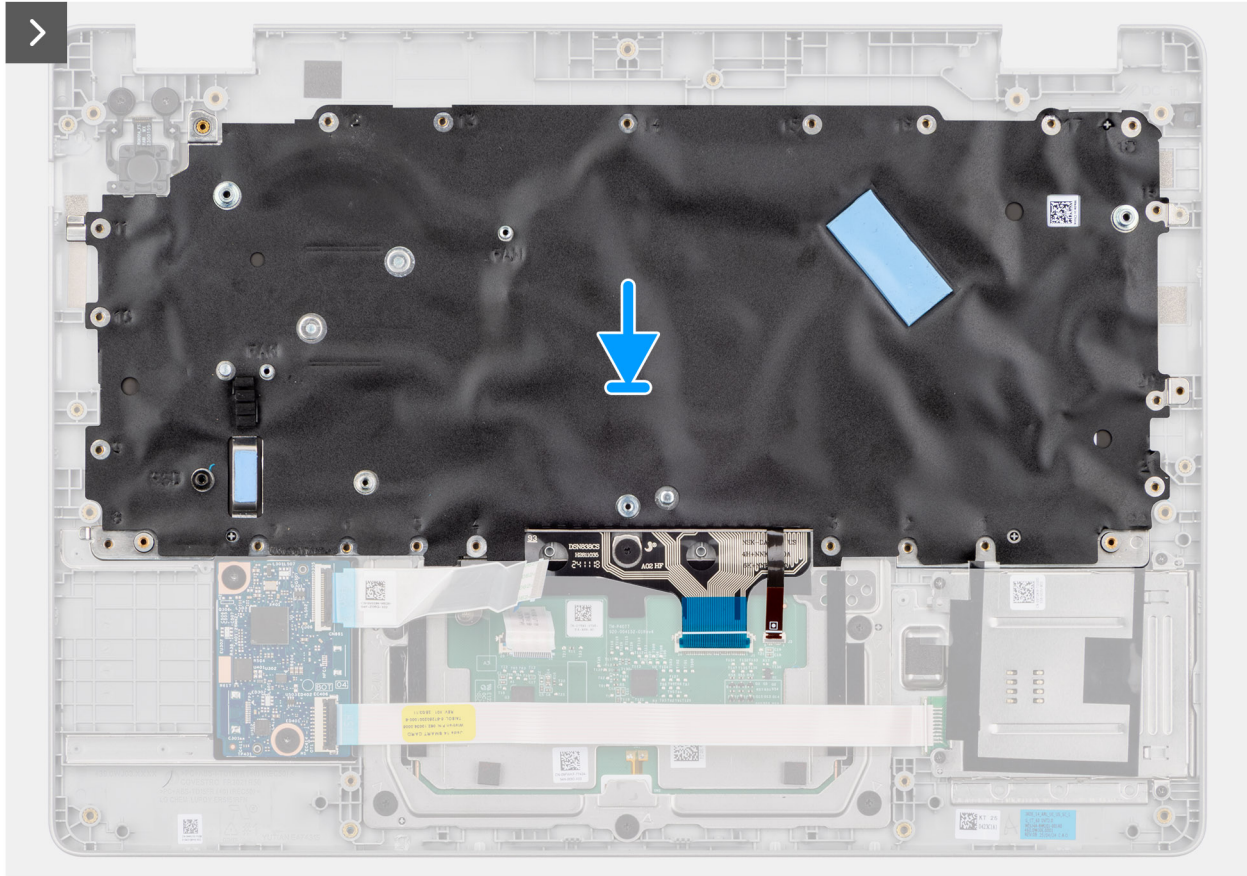
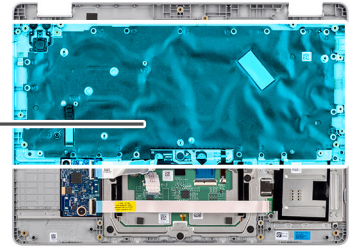
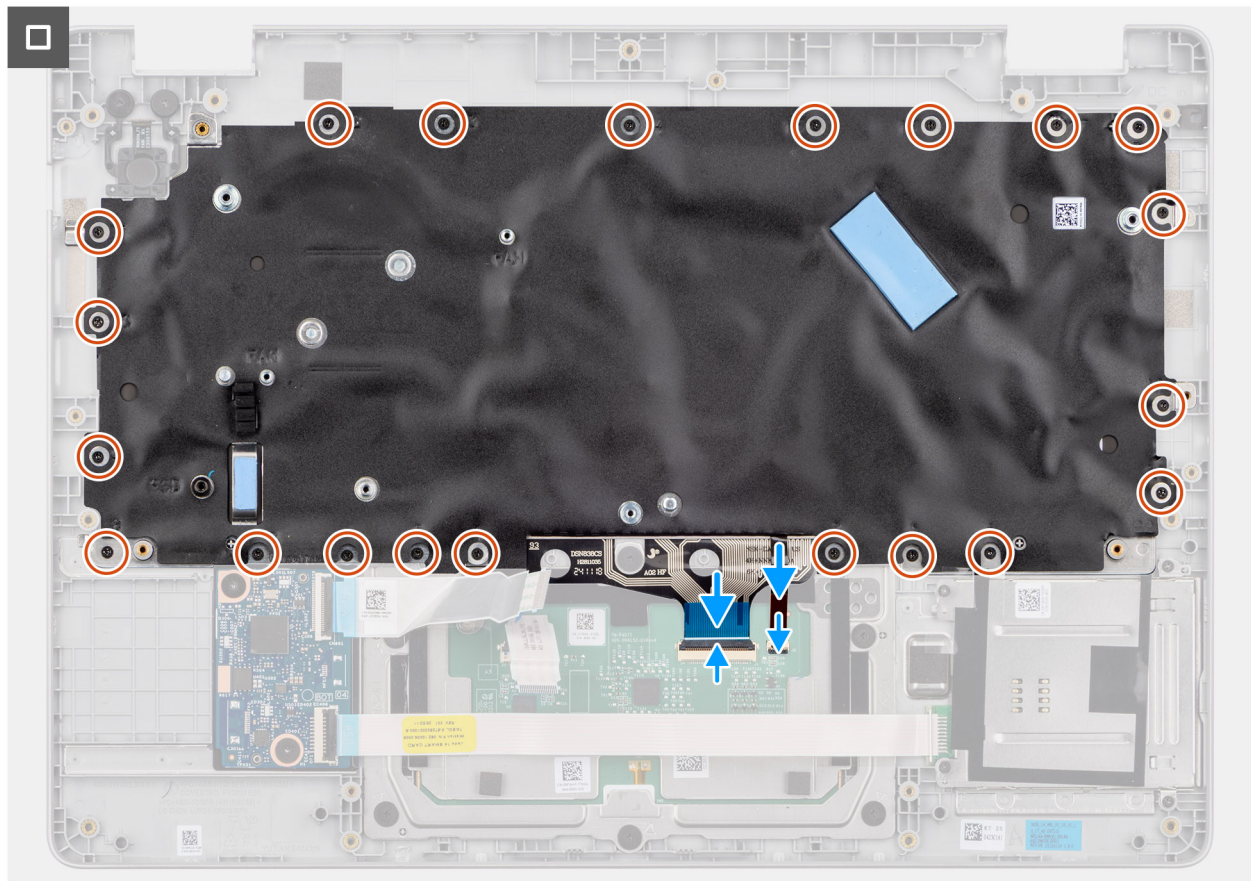

Figure 89. Installing the keyboard



**Figure 90. Installing the keyboard**

**Steps**

1. Align the screw holes on the keyboard with the screw holes on the palm-rest assembly.
2. Connect the keyboard cable and the keyboard backlit cable to the connectors on the touchpad.
3. Replace the 21 screws (M2x2.2) that secure the keyboard to the palm-rest assembly.

**Next steps**

1. Install the [power-adapter port](#).
2. Install the system board (for computers shipped with smart card reader).
3. Install the I/O board for computers shipped with Intel Core Ultra 200U Series.
4. Install the [display assembly](#).
5. Install the [heat sink](#).
6. Install the [fan](#).
7. Install the [wireless card](#).
8. Install the [SSD](#).
9. Install the [memory module](#).
10. Install the [battery](#).
11. Install the [base cover](#).
12. Follow the procedure in [After working inside your computer](#).

# Keyboard support plate

## Removing the keyboard support plate

 **CAUTION:** The information in this removal section is intended for authorized service technicians only.

### Prerequisites

1. Follow the procedure in [Before working inside your computer](#).
2. Remove the [base cover](#).
3. Remove the [battery](#).
4. Remove the [memory module](#).
5. Remove the [SSD](#).
6. Remove the [wireless card](#).
7. Remove the [fan](#).
8. Remove the [heat sink](#).
9. Remove the [display assembly](#).
10. Remove the I/O board ([for computers shipped with Intel Core Series](#)) or ([for computers shipped with Intel Core Ultra 200U Series](#)), whichever is applicable.
11. Remove the system board ([for computers shipped with Intel Core Series](#)) or ([for computers shipped with Intel Core Ultra 200U Series](#)), whichever is applicable.
12. Remove the [power-adaptor port](#).
13. Remove the [keyboard](#).

### About this task

 **NOTE:** The system board can be removed with the heat sink attached in order to simplify the procedure and preserve the thermal bond between the system board and the heat sink.

The following images indicate the location of the keyboard support plate and provide a visual representation of the removal procedure.



Figure 91. Removing the keyboard support plate

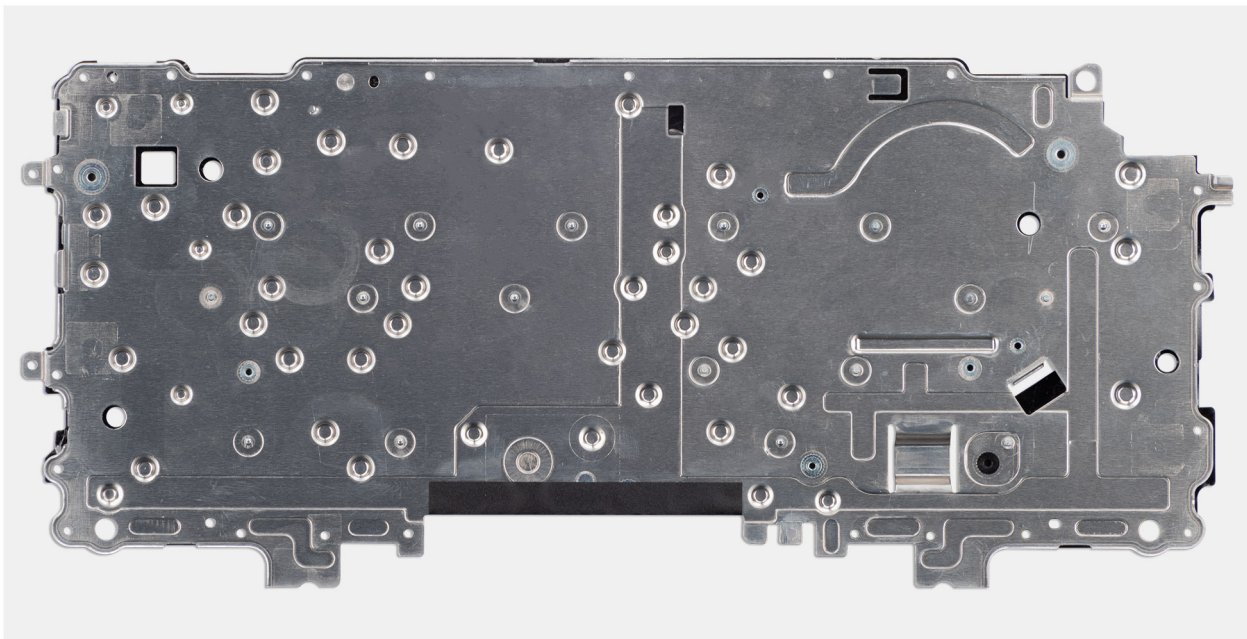

Figure 92. Removing the keyboard support plate

#### Steps

1. Remove the two screws (M2x2.2) screws that secure the keyboard to the keyboard support plate.
2. Lift the keyboard support plate off the keyboard.

## Installing the keyboard support plate

**CAUTION:** The information in this installation section is intended for authorized service technicians only.

### Prerequisites

If you are replacing a component, remove the existing component before performing the installation procedure.

### About this task

The following images indicate the location of the keyboard support plate and provide a visual representation of the removal procedure.

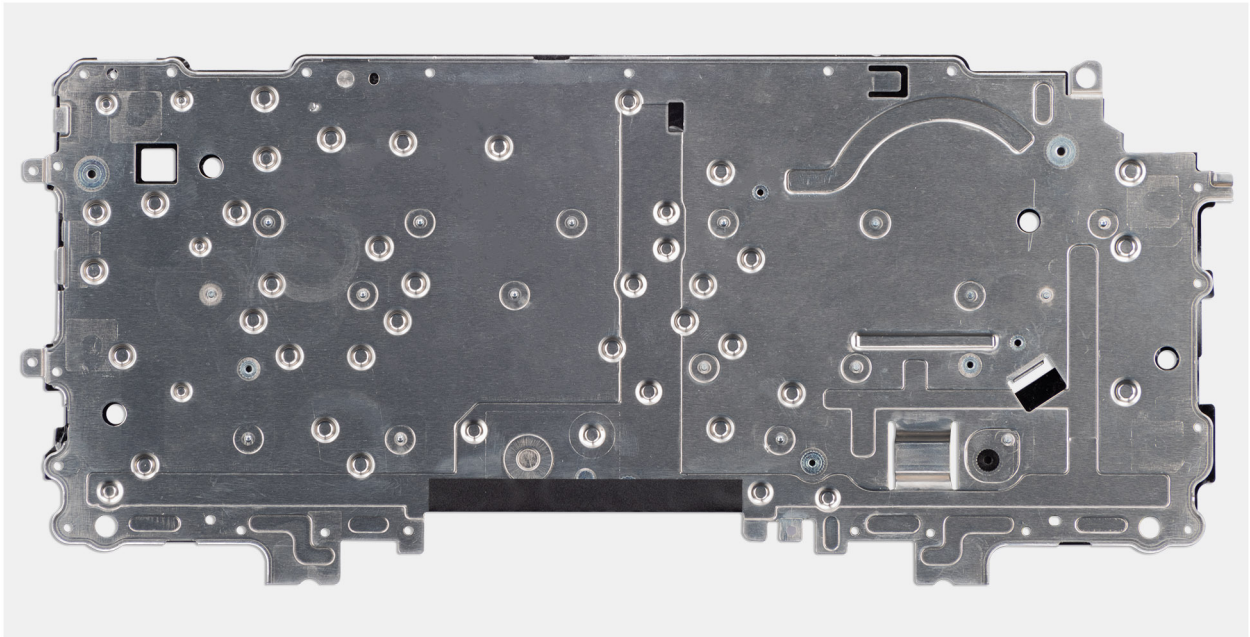

Figure 93. Installing the keyboard support plate



Figure 94. Installing the keyboard support plate

### Steps

1. Align the screw holes on the keyboard with the screw holes on the keyboard support plate.
2. Replace the two screws (M2x2.2) screws that secure the keyboard to the keyboard support plate.

### Next steps

1. Install the [keyboard](#).
2. Install the [power-adapter port](#).
3. Install the system board (for computers shipped with Intel Core Series) or (for computers shipped with Intel Core Ultra 200U Series), whichever is applicable.
4. Install the I/O board (for computers shipped with Intel Core Series) or (for computers shipped with Intel Core Ultra 200U Series), whichever is applicable.
5. Install the [display assembly](#).
6. Install the [heat sink](#).
7. Install the [fan](#).
8. Install the [wireless card](#).
9. Install the [SSD](#).
10. Install the [memory module](#).
11. Install the [battery](#).
12. Install the [base cover](#).
13. Follow the procedure in [After working inside your computer](#).

## Palm-rest assembly

### Removing the palm-rest assembly

 **CAUTION:** The information in this removal section is intended for authorized service technicians only.

## Prerequisites

1. Follow the procedure in [Before working inside your computer](#).
2. Remove the [base cover](#).
3. Remove the [battery](#).
4. Remove the [memory module](#).
5. Remove the [SSD](#).
6. Remove the [wireless card](#).
7. Remove the [fan](#).
8. Remove the [heat sink](#).
9. Remove the [display assembly](#).
10. Remove the I/O board ([for computers shipped with Intel Core Series](#)) or ([for computers shipped with Intel Core Ultra 200U Series](#)), whichever is applicable.
11. Remove the [power button](#).
12. Remove the [speakers](#).
13. Remove the system board ([for computers shipped with Intel Core Series](#)) or ([for computers shipped with Intel Core Ultra 200U Series](#)), whichever is applicable.
14. Remove the [power-adaptor port](#).
15. Remove the [keyboard](#).

## About this task

**NOTE:** The system board can be removed with the heat sink attached in order to simplify the procedure and preserve the thermal bond between the system board and the heat sink.

**NOTE:** The palm-rest assembly cannot be further disassembled once all the prerequisites are completed. The touchpad is part of the palm-rest assembly. If the touchpad is malfunctioning and needs to be replaced, the entire palm-rest assembly must be replaced.

The image below shows the palm-rest assembly after the prerequisites have been completed. After performing the steps mentioned in the prerequisites, you are left with the palm-rest assembly.

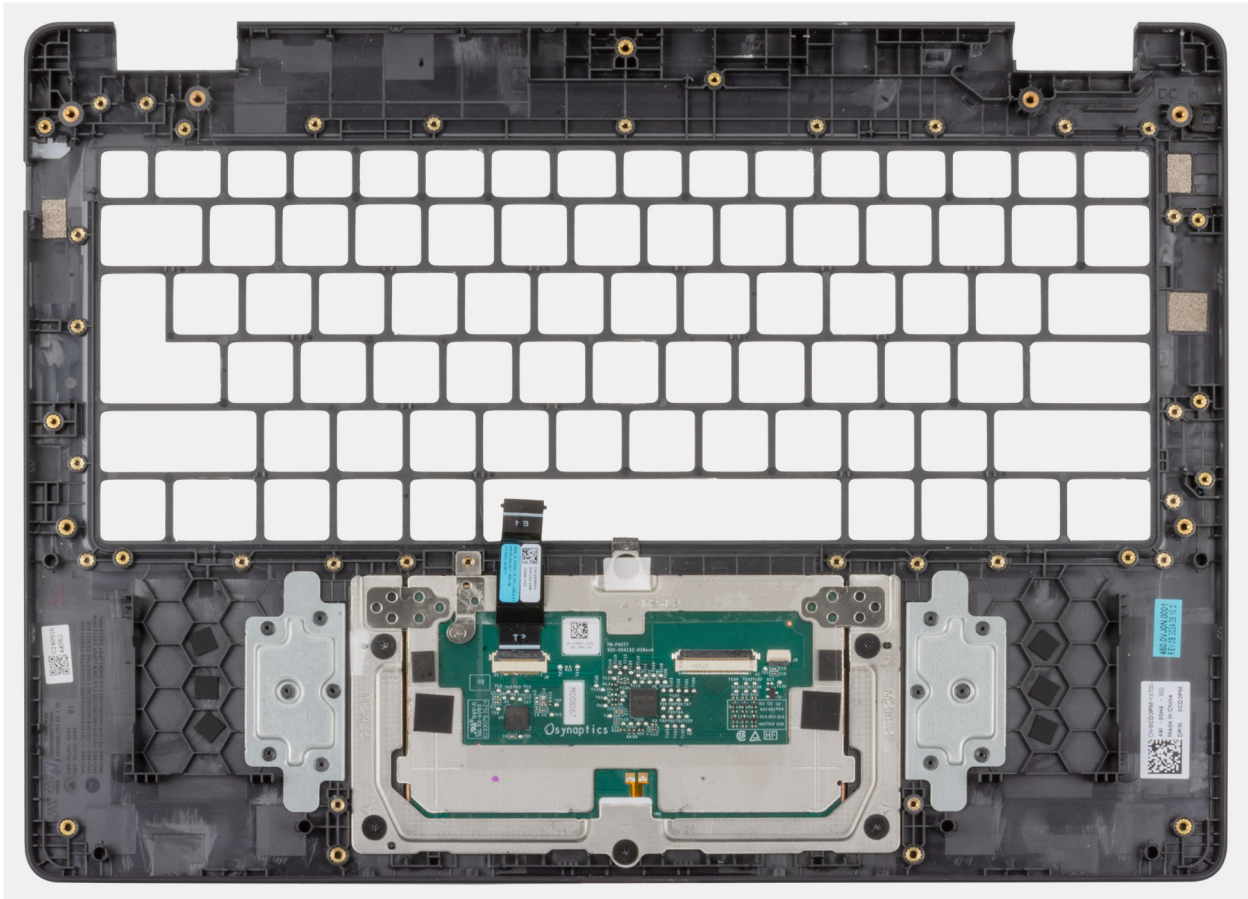

Figure 95. Removing the palm-rest and assembly

## Installing the palm-rest assembly

**CAUTION:** The information in this installation section is intended for authorized service technicians only.

### Prerequisites

If you are replacing a component, remove the existing component before performing the installation procedure.

### About this task

The following image shows the palm-rest assembly.

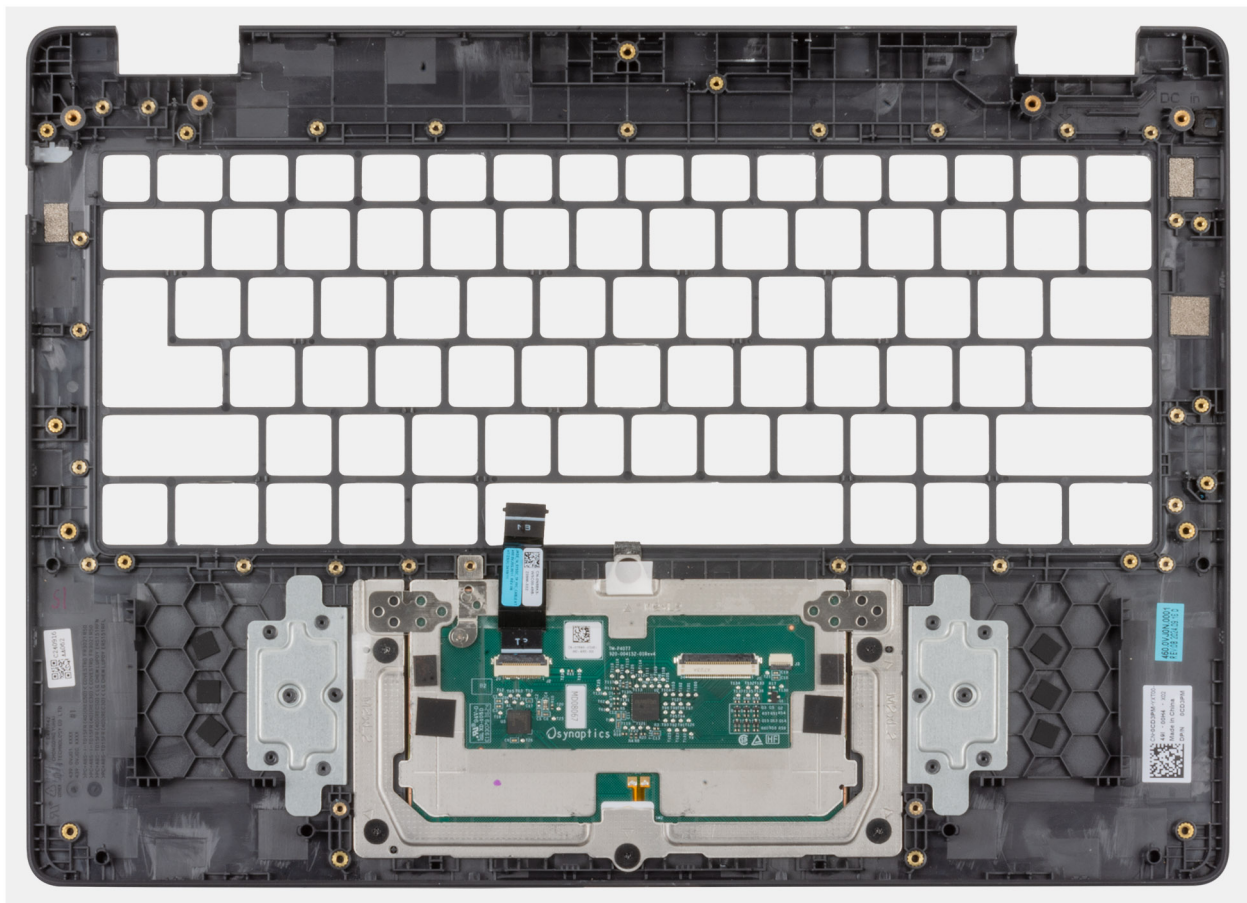

**Figure 96. Installing the palm-rest assembly**

### Steps

Place the palm-rest assembly on a flat surface.

**NOTE:** The touchpad is part of the palm-rest assembly.

### Next steps

1. Install the [keyboard](#).
2. Install the [power-adaptor port](#).
3. Install the system board ([for computers shipped with Intel Core Series](#)) or ([for computers shipped with Intel Core Ultra 200U Series](#)), whichever is applicable.
4. Install the [speakers](#).
5. Install the [power button](#).
6. Install the I/O board ([for computers shipped with Intel Core Series](#)) or ([for computers shipped with Intel Core Ultra 200U Series](#)), whichever is applicable.
7. Install the [display assembly](#).
8. Install the [heat sink](#).
9. Install the [fan](#).
10. Install the [wireless card](#).
11. Install the [SSD](#).
12. Install the [memory module](#).
13. Install the [battery](#).
14. Install the [base cover](#).
15. Follow the procedure in [After working inside your computer](#).



# Removing the palm-rest assembly (For computers shipped with smart card reader)

 **CAUTION:** The information in this removal section is intended for authorized service technicians only.

## Prerequisites

1. Follow the procedure in [Before working inside your computer](#).
2. Remove the [base cover](#).
3. Remove the [battery](#).
4. Remove the [smart card reader](#).
5. Remove the [USH board](#).
6. Remove the [memory module](#).
7. Remove the [SSD](#).
8. Remove the [wireless card](#).
9. Remove the [fan](#).
10. Remove the [heat sink](#).
11. Remove the [display assembly](#).
12. Remove the I/O board ([for computers shipped with Intel Core Series](#)) or ([for computers shipped with Intel Core Ultra 200U Series](#)), whichever is applicable.
13. Remove the [power button](#).
14. Remove the [speakers](#).
15. Remove the system board ([for computers shipped with smart card reader](#)).
16. Remove the [power-adapter port](#).
17. Remove the [keyboard](#).

## About this task

-  **NOTE:** The system board can be removed with the heat sink attached in order to simplify the procedure and preserve the thermal bond between the system board and the heat sink.
-  **NOTE:** The palm-rest assembly cannot be further disassembled once all the prerequisites are completed. The touchpad is part of the palm-rest assembly. If the touchpad is malfunctioning and needs to be replaced, the entire palm-rest assembly must be replaced.

The image below shows the palm-rest assembly after the prerequisites have been completed. After performing the steps mentioned in the prerequisites, you are left with the palm-rest assembly.

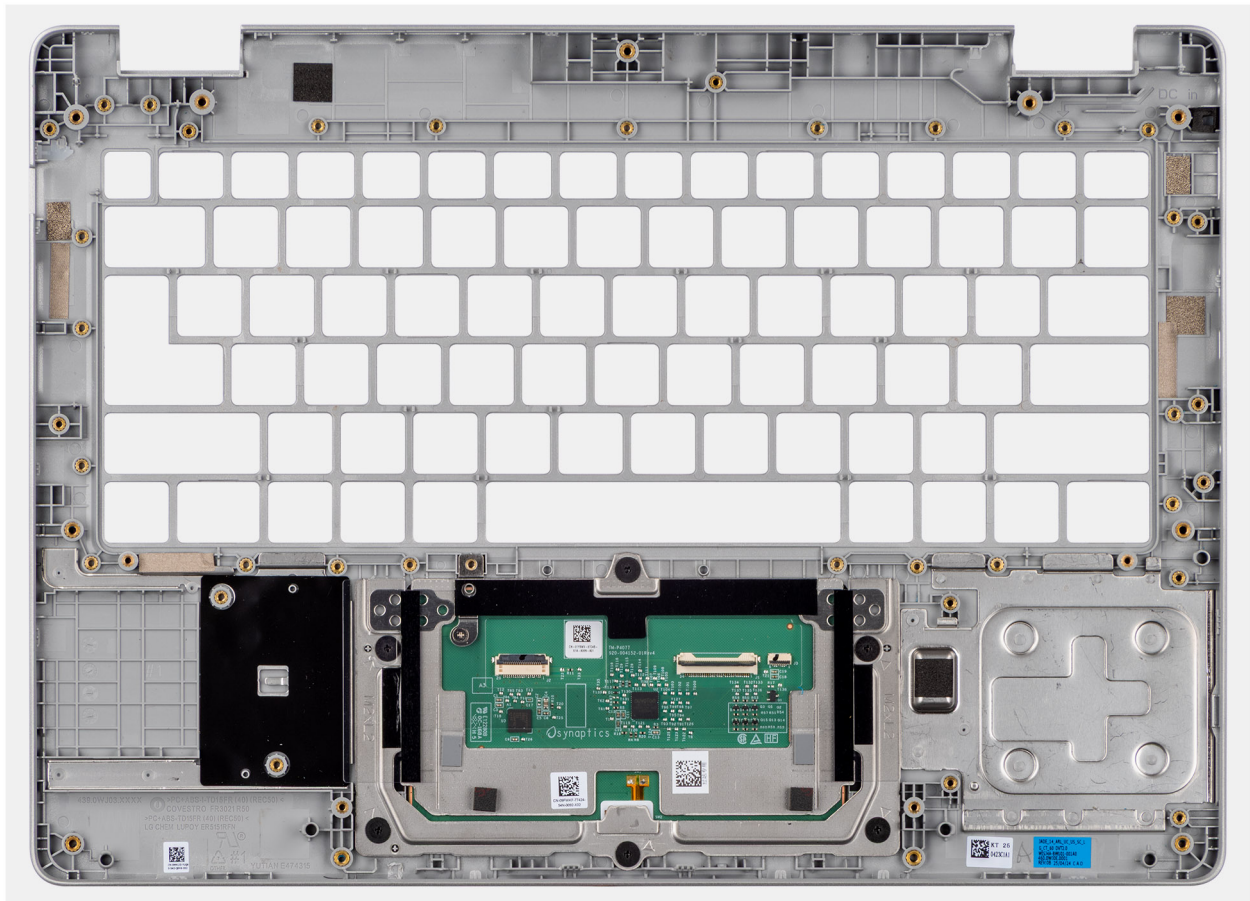

Figure 97. Removing the palm-rest and assembly

## Installing the palm-rest assembly (For computers shipped with smart card reader)

**CAUTION:** The information in this installation section is intended for authorized service technicians only.

### Prerequisites

If you are replacing a component, remove the existing component before performing the installation procedure.

### About this task

The following image shows the palm-rest assembly.

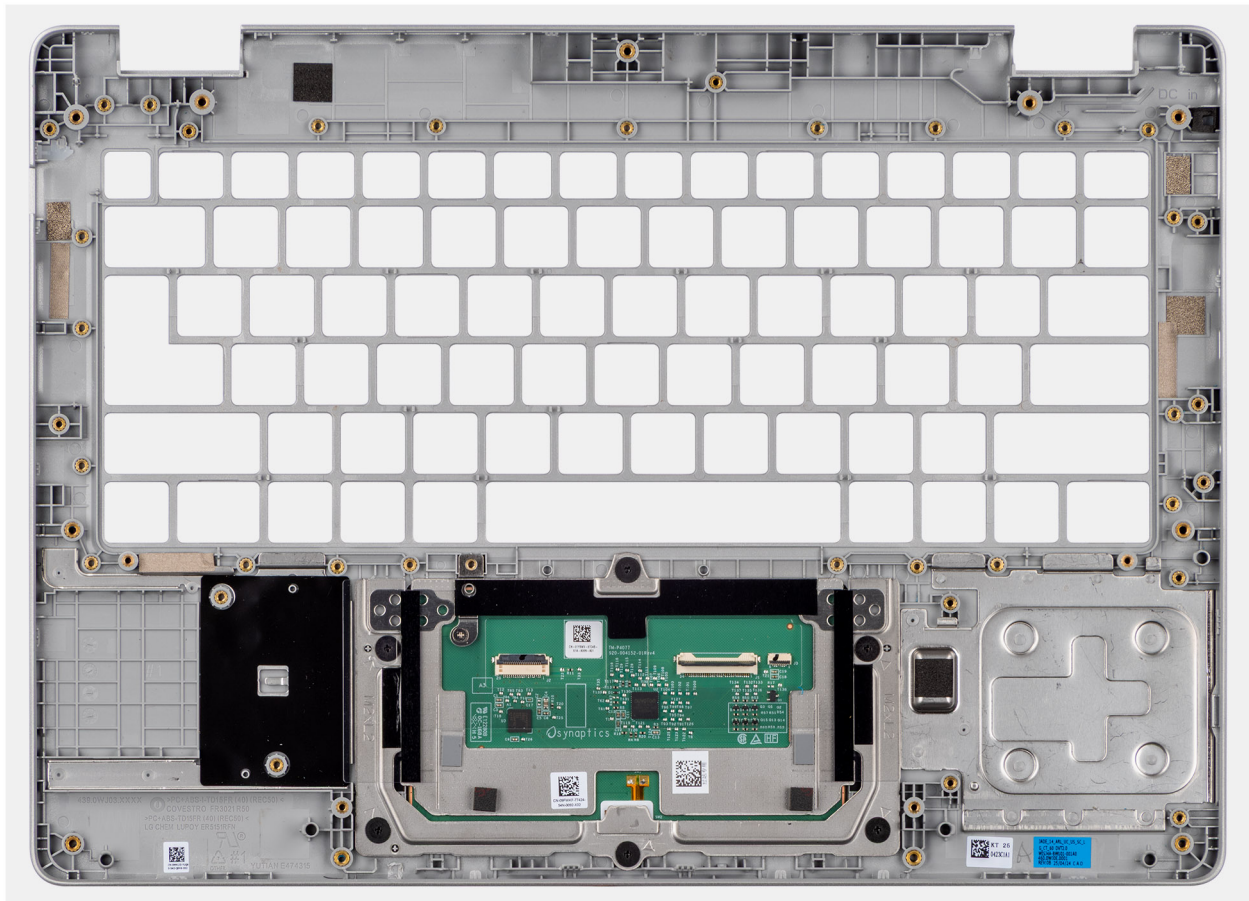

**Figure 98. Installing the palm-rest assembly**

### Steps

Place the palm-rest assembly on a flat surface.

**NOTE:** The touchpad is part of the palm-rest assembly.

### Next steps

1. Install the [keyboard](#).
2. Install the [power-adaptor port](#).
3. Install the system board (for computers shipped with smart card reader).
4. Install the [speakers](#).
5. Install the [power button](#).
6. Install the I/O board (for computers shipped with Intel Core Series) or (for computers shipped with Intel Core Ultra 200U Series), whichever is applicable.
7. Install the [display assembly](#).
8. Install the [heat sink](#).
9. Install the [fan](#).
10. Install the [wireless card](#).
11. Install the [SSD](#).
12. Install the [memory module](#).
13. Install the [USH board](#).
14. Install the [smart card reader](#).
15. Install the [battery](#).
16. Install the [base cover](#).
17. Follow the procedure in [After working inside your computer](#).

# Display assembly

## Removing the display assembly

 **CAUTION:** The information in this removal section is intended for authorized service technicians only.

### Prerequisites

1. Follow the procedure in [Before working inside your computer](#).
2. Remove the [base cover](#).
3. Remove the [wireless card](#).

### About this task

 **NOTE:** The display assembly is not a standalone serviceable component. It must be removed as a prerequisite to access and service the following components:

- Display bezel
- Display-panel assembly
- Camera
- eDP cable
- Display back-cover assembly

The following images indicate the location of the display assembly and provide a visual representation of the removal procedure.



4x  
M2.5x5

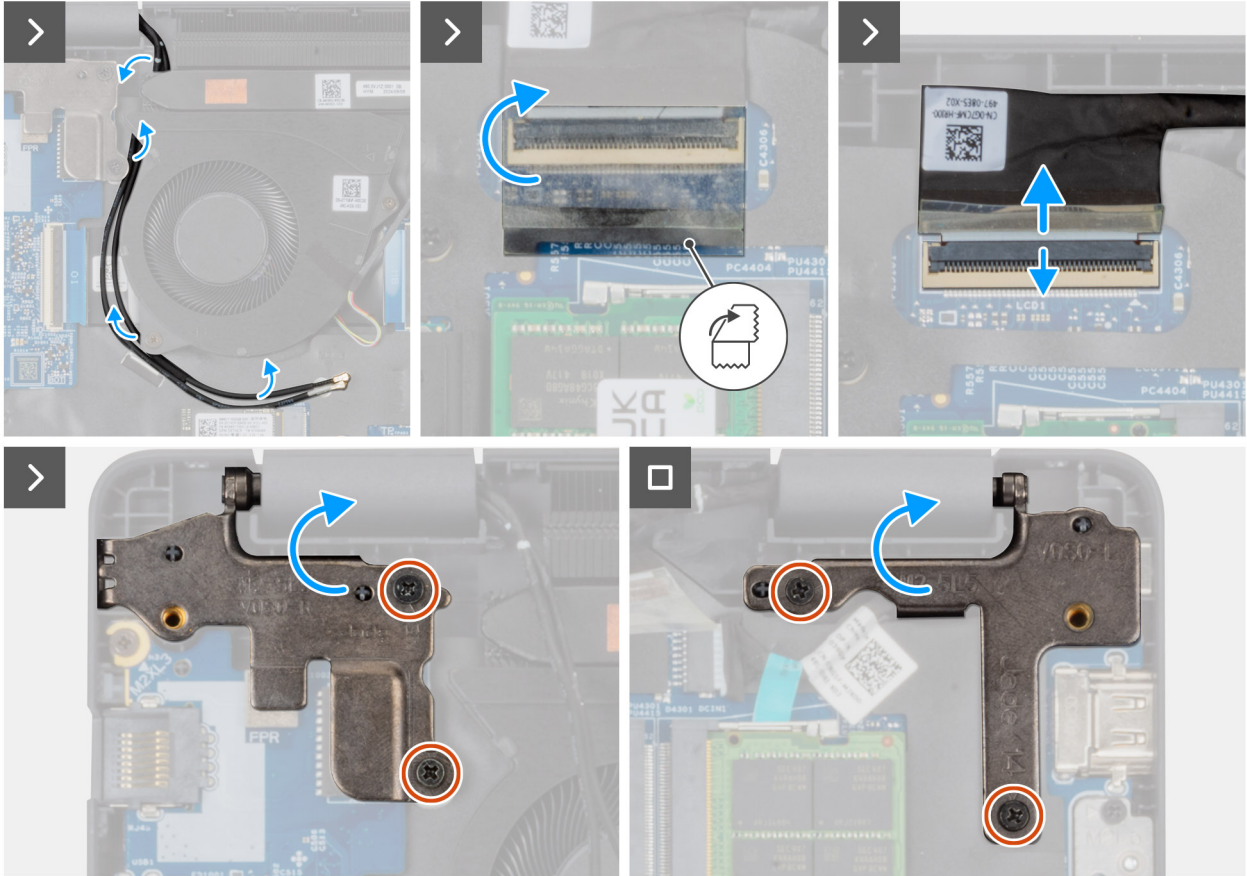
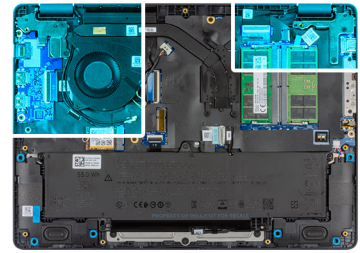

Figure 99. Removing the display assembly

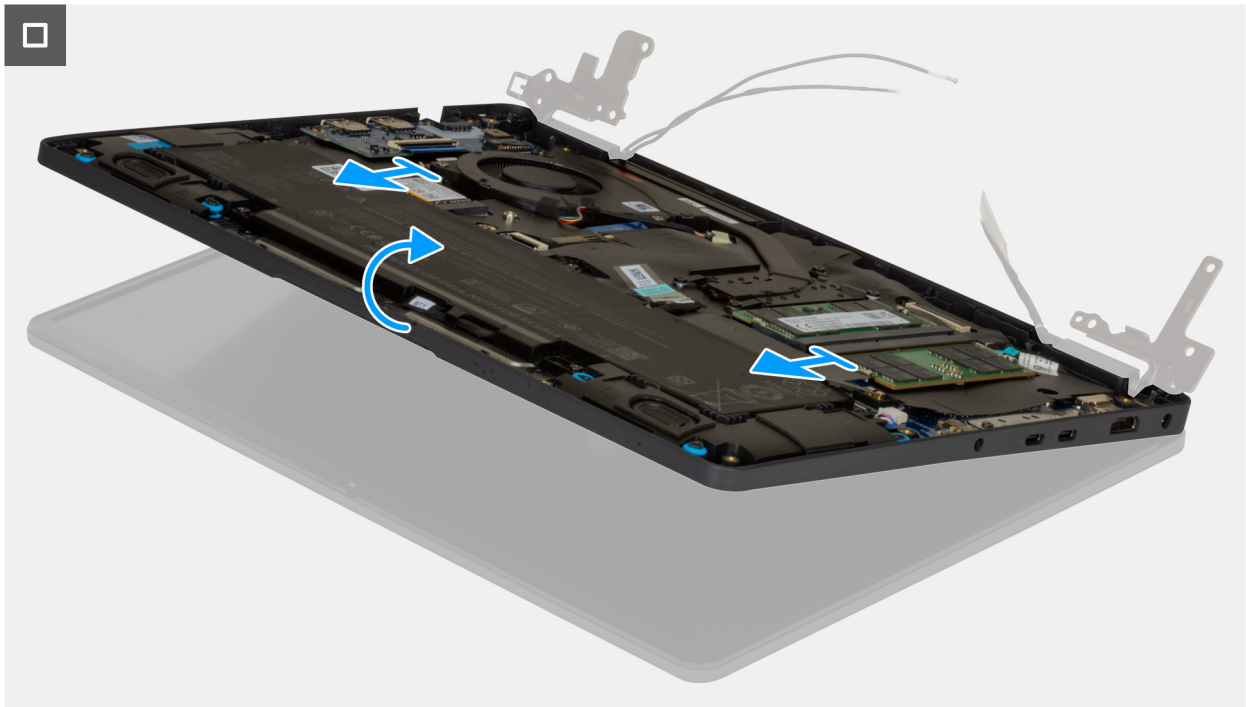

Figure 100. Removing the display assembly



Figure 101. Removing the display assembly

**Steps**

1. Place the system on a flat surface such that the palm-rest and keyboard assembly lay flat on the surface.

2. Unroute the WLAN antenna cables from the routing guides on the fan.
3. Peel away the mylar that secures the display cable to the system board.
4. Open the latch and disconnect the display cable from the connector (LCD1) on the system board.
5. Remove the four screws (M2.5x5) that secure the display hinges to the palm-rest assembly.
6. Lift the left and right hinges in an upward direction, and away from the computer.
7. Lift the palm-rest assembly at an angle and remove it from the display assembly.

## Installing the display assembly

**CAUTION:** The information in this installation section is intended for authorized service technicians only.

### Prerequisites

If you are replacing a component, remove the existing component before performing the installation procedure.

### About this task

**NOTE:** Ensure that the hinges are opened to the maximum before replacing the display assembly on the palm-rest and keyboard assembly.

The following images indicate the location of the display assembly and provide a visual representation of the installation procedure.



4x  
M2.5x5

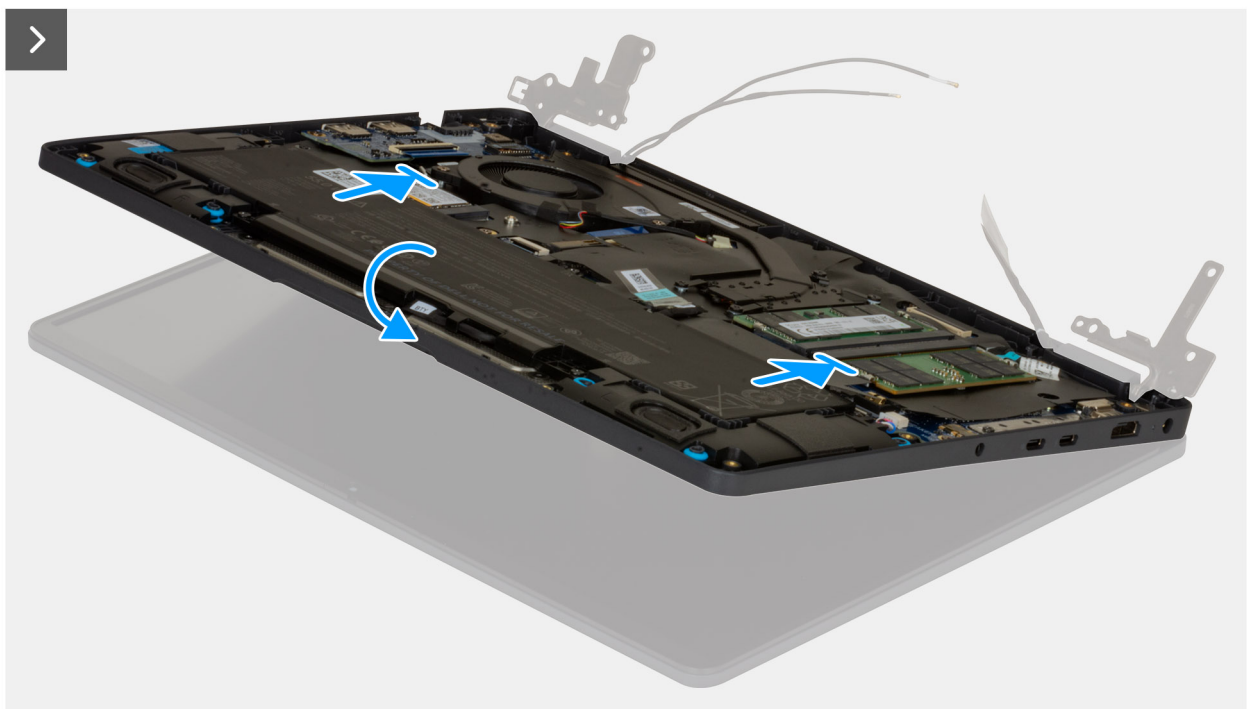
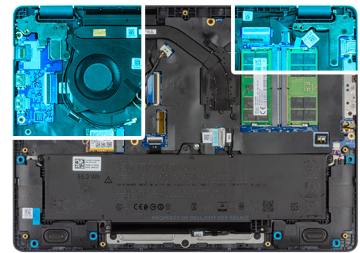
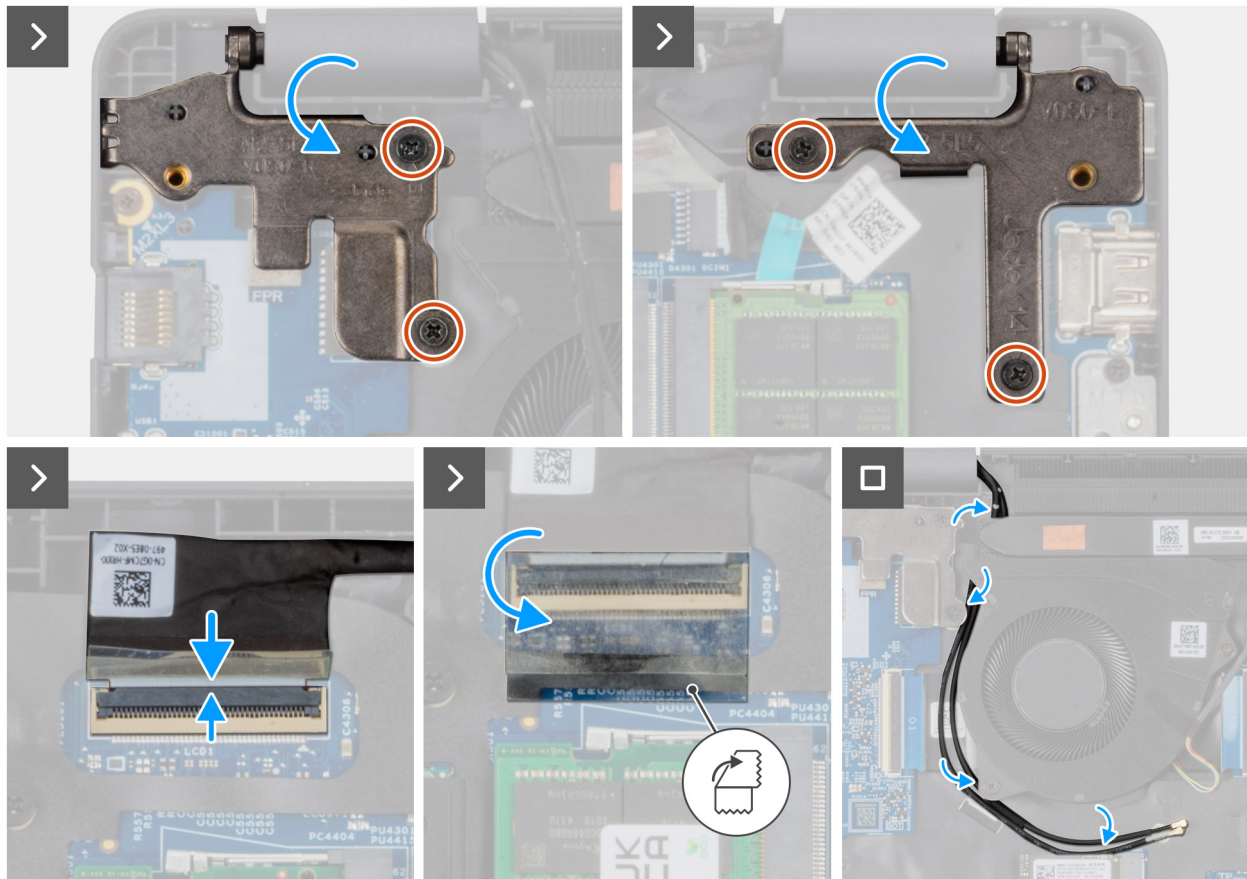

Figure 102. Installing the display assembly



**Figure 103. Installing the display assembly**

**Steps**

1. Place the display assembly on a flat surface.
2. Slide the palm-rest assembly under the hinges of the display assembly.
3. Gently press down on the display hinges and align the screw holes on the display hinges with the screw holes on the palm-rest assembly.
4. Replace the four screws (M2.5x5) that secure the display hinges to the palm-rest assembly.
5. Open the latch and connect the display cable to its connector (LCD1) on the system board.
6. Adhere the mylar that secures the display cable to the system board.
7. Route the WLAN-antenna cables through the routing guides on the fan.

**Next steps**

1. Install the [wireless card](#).
2. Install the [base cover](#).
3. Follow the procedure in [After working inside your computer](#).

## Display bezel

### Removing the display bezel

**CAUTION:** The information in this removal section is intended for authorized service technicians only.

**Prerequisites**

1. Follow the procedure in [Before working inside your computer](#).

2. Remove the [base cover](#).
3. Remove the [display assembly](#).

**About this task**

The following images indicate the location of the display bezel and provide a visual representation of the removal procedure.



**Figure 104. Removing the display bezel**

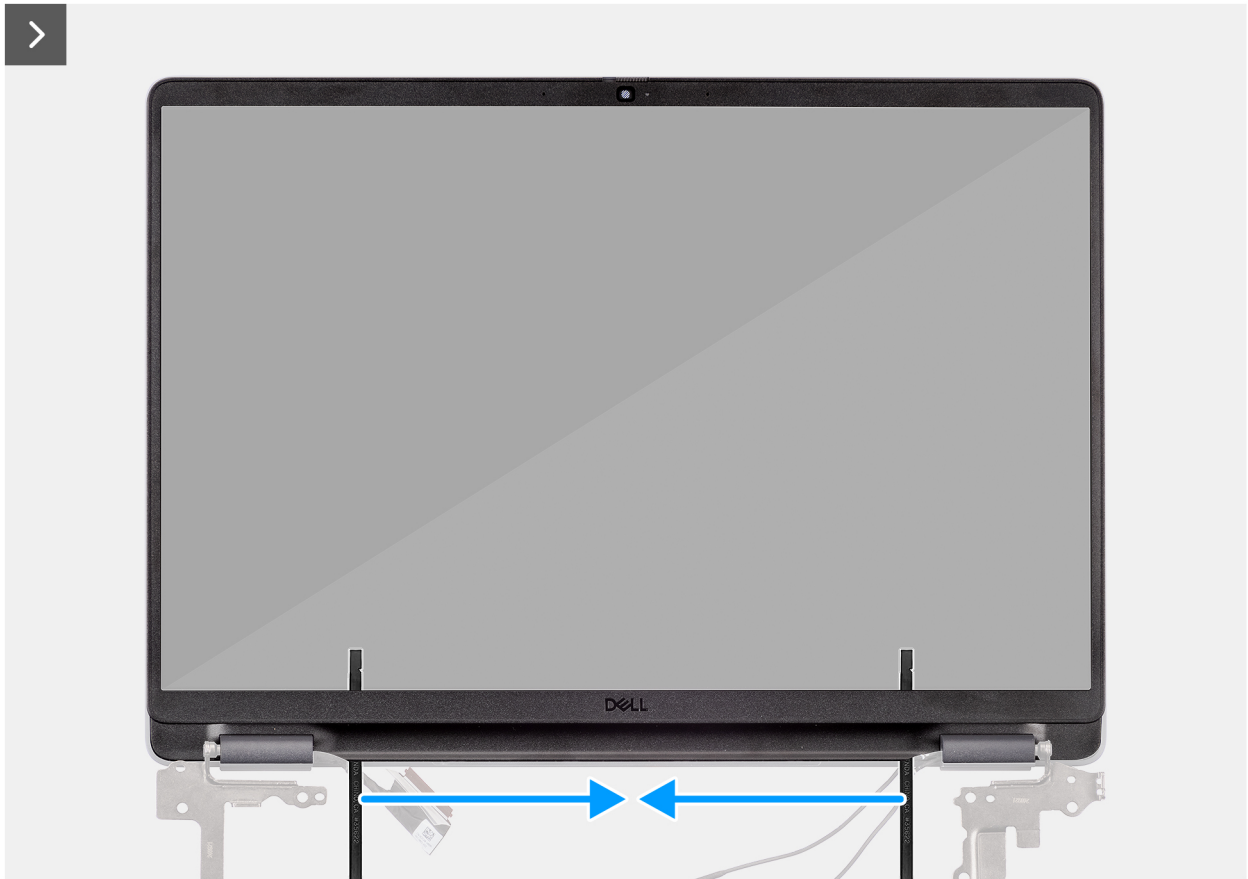

Figure 105. Removing the display bezel

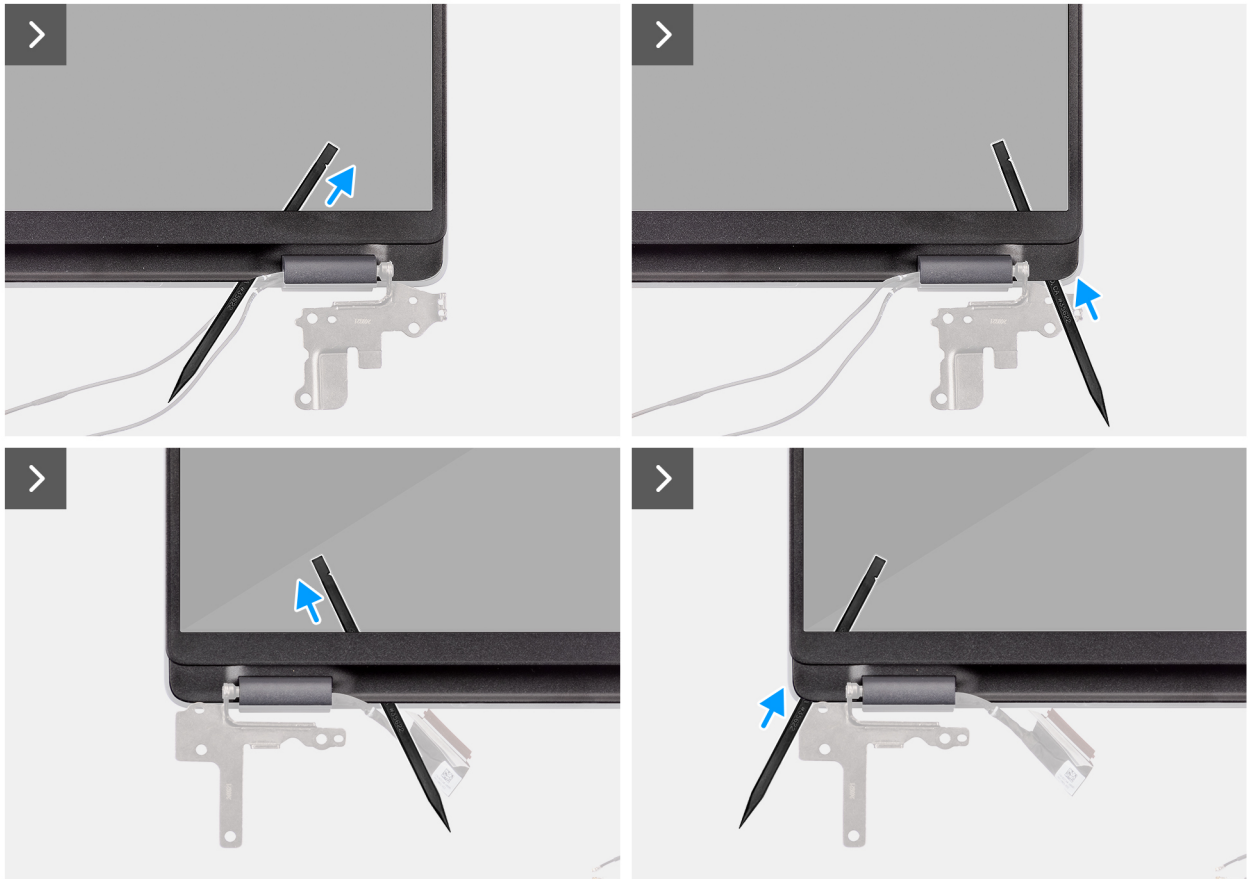
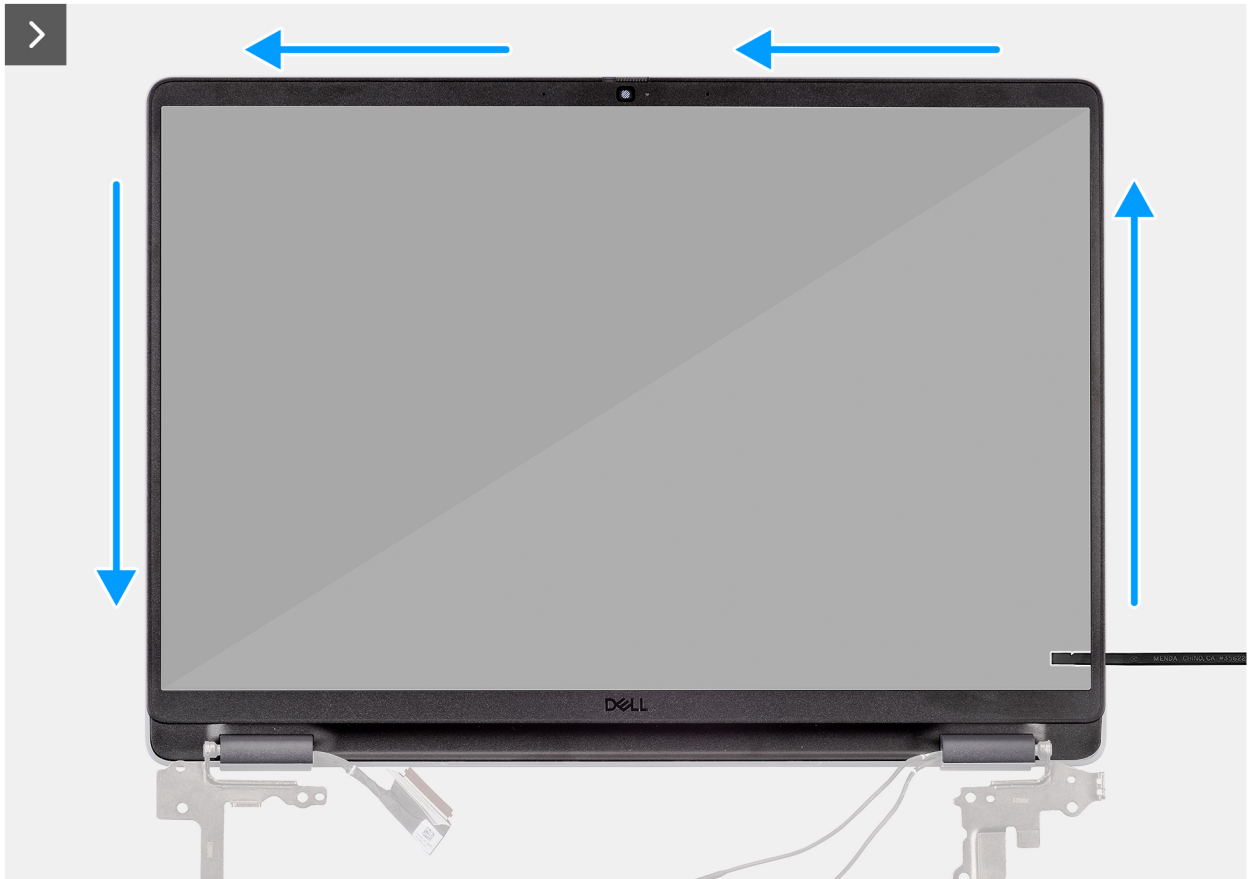
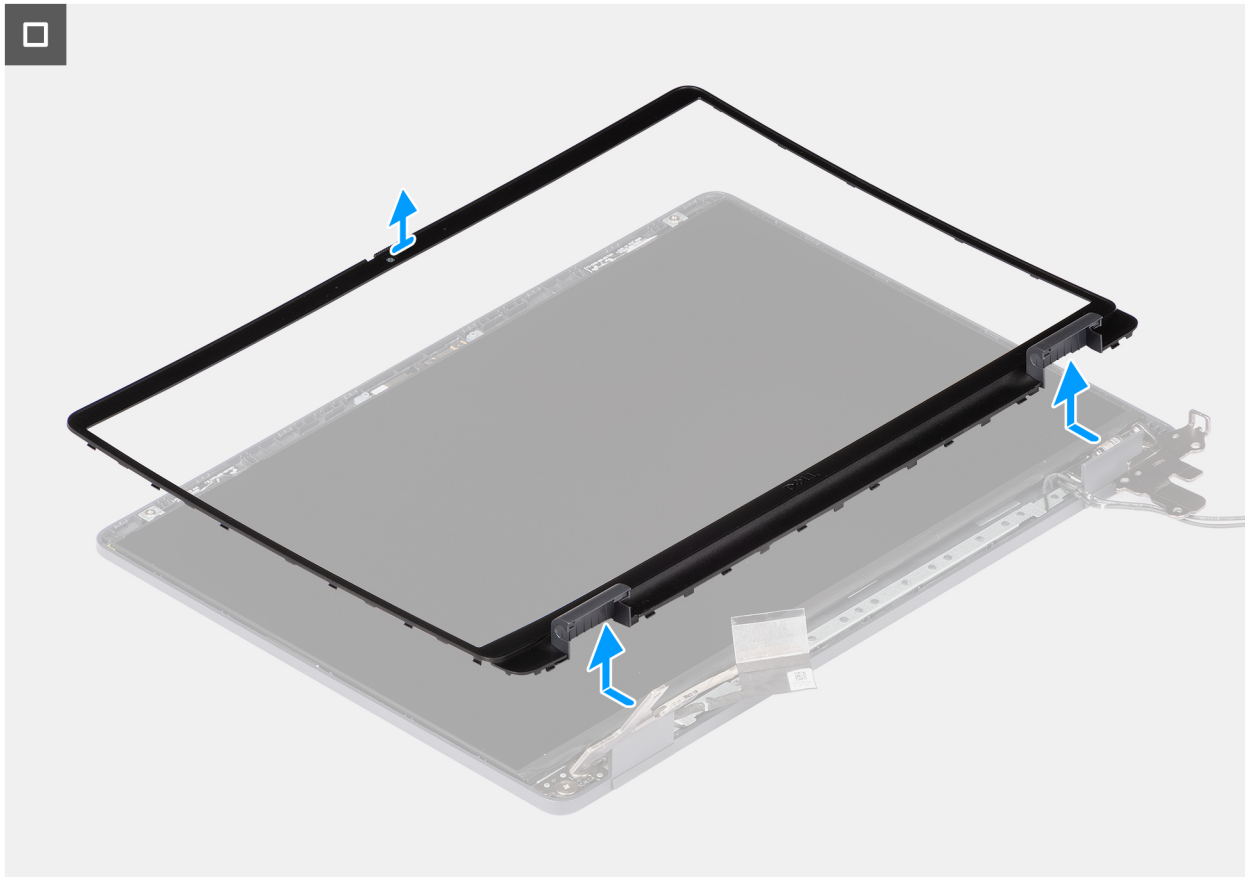

Figure 106. Removing the display bezel



**Figure 107. Removing the display bezel**



**Figure 108. Removing the display bezel**

### Steps

1. Insert a flat-head screwdriver (maximum width: 4 mm) into the slots on the display bezel near the hinges, and gently apply pressure to release the bezel at both ends, creating a gap.
2. Insert the flat end of the scribe into the gap created under the display bezel.

**NOTE:** Do not use the flat head screwdriver to pry up the rest of the bezel. Instead, use the flat end of a plastic scribe to continue prying along the bezel.

**CAUTION:** When inserting the scribe into the bezel, keep it parallel to the display. Pressing it downward can damage the display.

3. Keeping the scribe parallel to the display, carefully slide it along the bottom edge of the bezel to release the latches on the lower side.
4. Insert the scribe diagonally into the hinge section to carefully release the adhesive near the portion of the bezel above the hinge.

**CAUTION:** Do not lift the scribe vertically as it damages the screen. Slide the scribe horizontally to disengage the adhesive and pry the bezel upwards.

5. Insert the scribe into the corner of the display bezel near the hinge. Keeping the scribe parallel to the display, carefully slide the scribe along the edges from one corner to the other (right to left or left to right).
6. Lift the display bezel from the display assembly.

## Installing the display bezel

**CAUTION:** The information in this installation section is intended for authorized service technicians only.

### Prerequisites

If you are replacing a component, remove the existing component before performing the installation procedure.

### About this task

The following images indicate the location of the display bezel and provide a visual representation of the installation procedure.

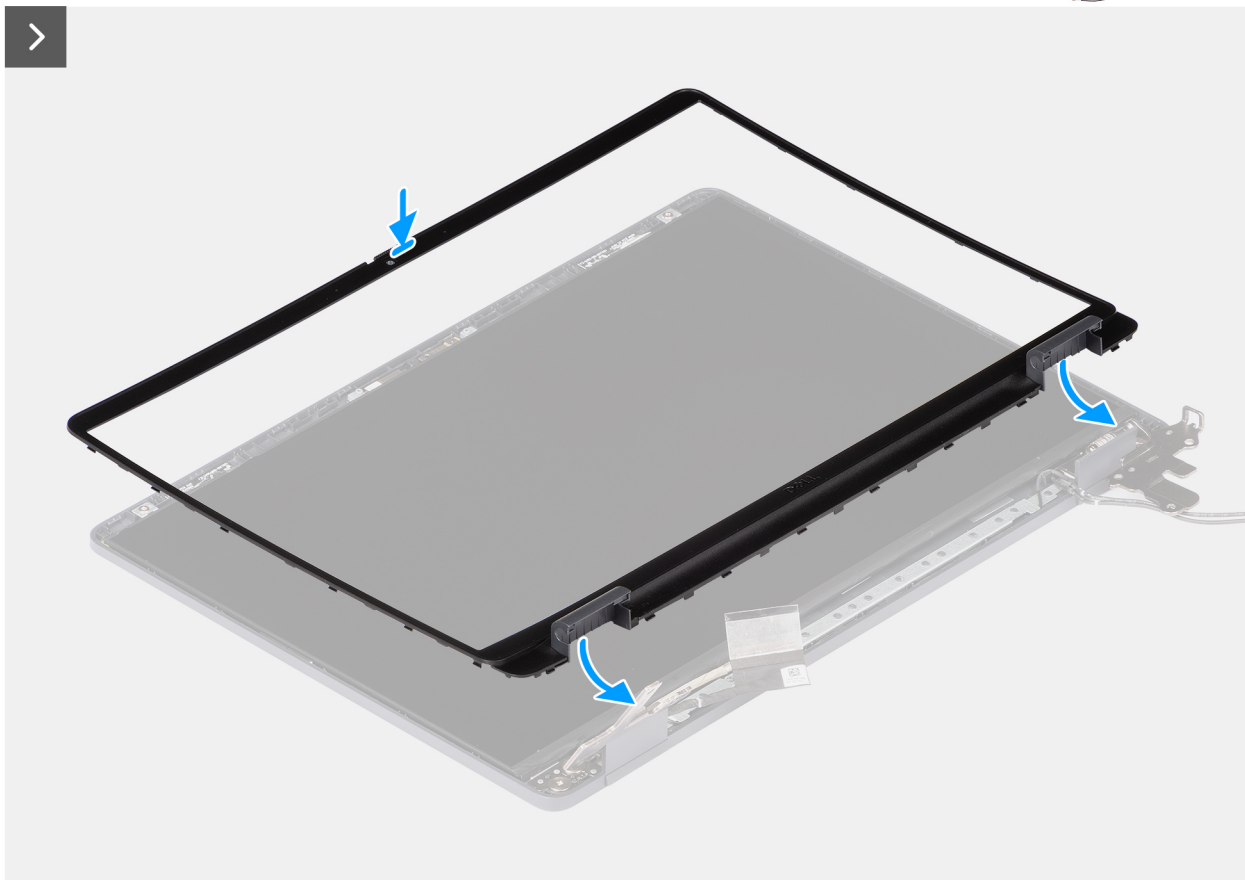
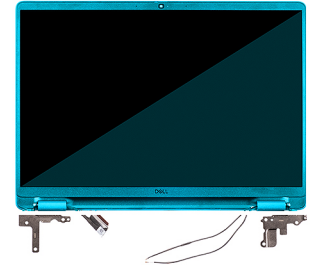
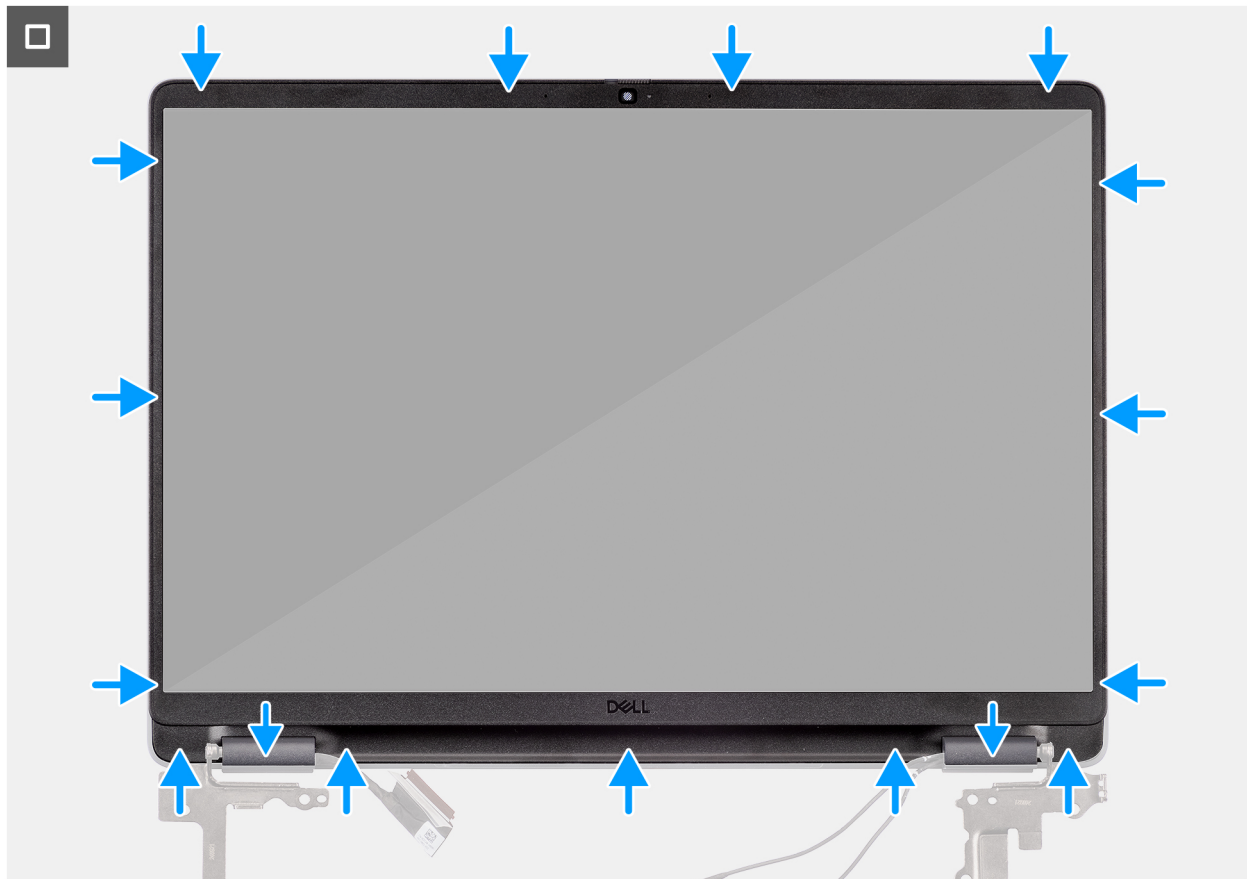

Figure 109. Installing the display bezel



**Figure 110. Installing the display bezel**

### Steps

**NOTE:** The holding tape secures the camera shutter on the replacement display bezel.

**CAUTION:** To avoid accidental removal or damage to the camera shutter on the replacement display bezel, avoid peeling off the holding tape abruptly.

1. Align and place the display bezel on the display assembly.
2. Gently press along the edges of the display bezel to secure it with the clips on the display assembly.

### Next steps

1. Install the [display assembly](#).
2. Install the [base cover](#).
3. Follow the procedure in [After working inside your computer](#).

## Display-panel assembly

### Removing the display-panel assembly

**CAUTION:** The information in this removal section is intended for authorized service technicians only.

#### Prerequisites

1. Follow the procedure in [Before working inside your computer](#).
2. Remove the [base cover](#).

3. Remove the [display assembly](#).
4. Remove the [display bezel](#).

**About this task**

The following images indicate the location of the display-panel assembly and provide a visual representation of the removal procedure.

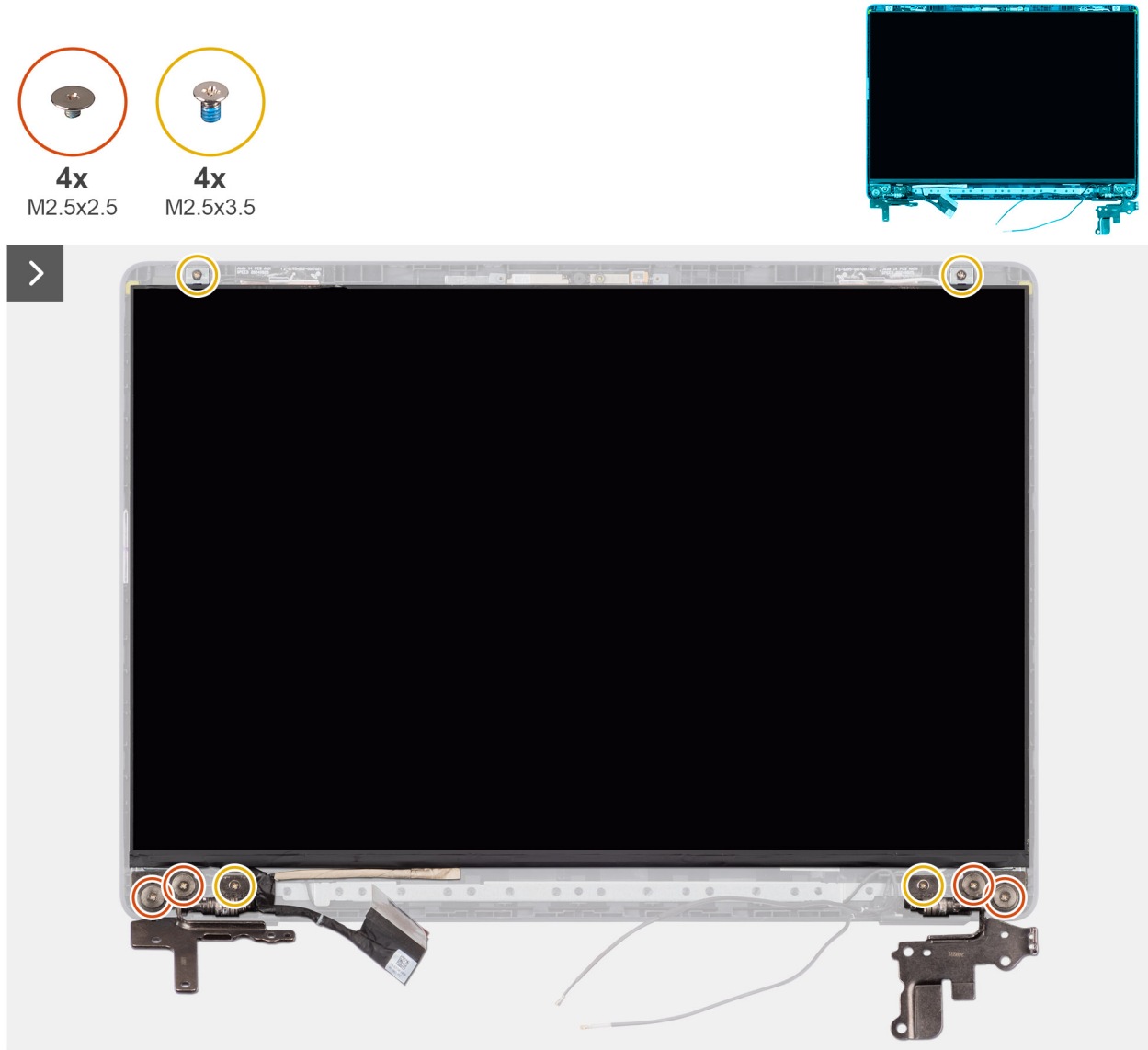

**Figure 111. Removing the display-panel assembly assembly**



Figure 112. Removing the display-panel assembly



Figure 113. Removing the display-panel assembly



**Figure 114. Removing the display-panel assembly**

**Steps**

**i** **NOTE:** The display-panel assembly is preassembled with the display brackets as a single service part. Do not pull the Stretch Release tapes to separate the brackets from the display panel.



1. Remove the four (M2.5x2.5) screws and four (M2.5x3.5) screws that secure the left and right hinges to the display back cover.  
**NOTE:** While removing the display-panel assembly, disengage the display panel tabs from the display cover before flipping it over.
2. Lift the lower portion of the LCD panel, slide it downwards, and then flip the panel over to access the display cable.
3. Peel the conductive tape on the display-cable connector.
4. Open the latch and disconnect the cable from the connector (LCD1) on the display panel.
5. Lift the display-panel assembly away from the display back cover.

## Installing the display-panel assembly

**CAUTION:** The information in this installation section is intended for authorized service technicians only.

### Prerequisites

If you are replacing a component, remove the existing component before performing the installation procedure.

### About this task

The following images indicate the location of the display panel and provide a visual representation of the installation procedure.



**4x**  
M2.5x2.5



**4x**  
M2.5x3.5

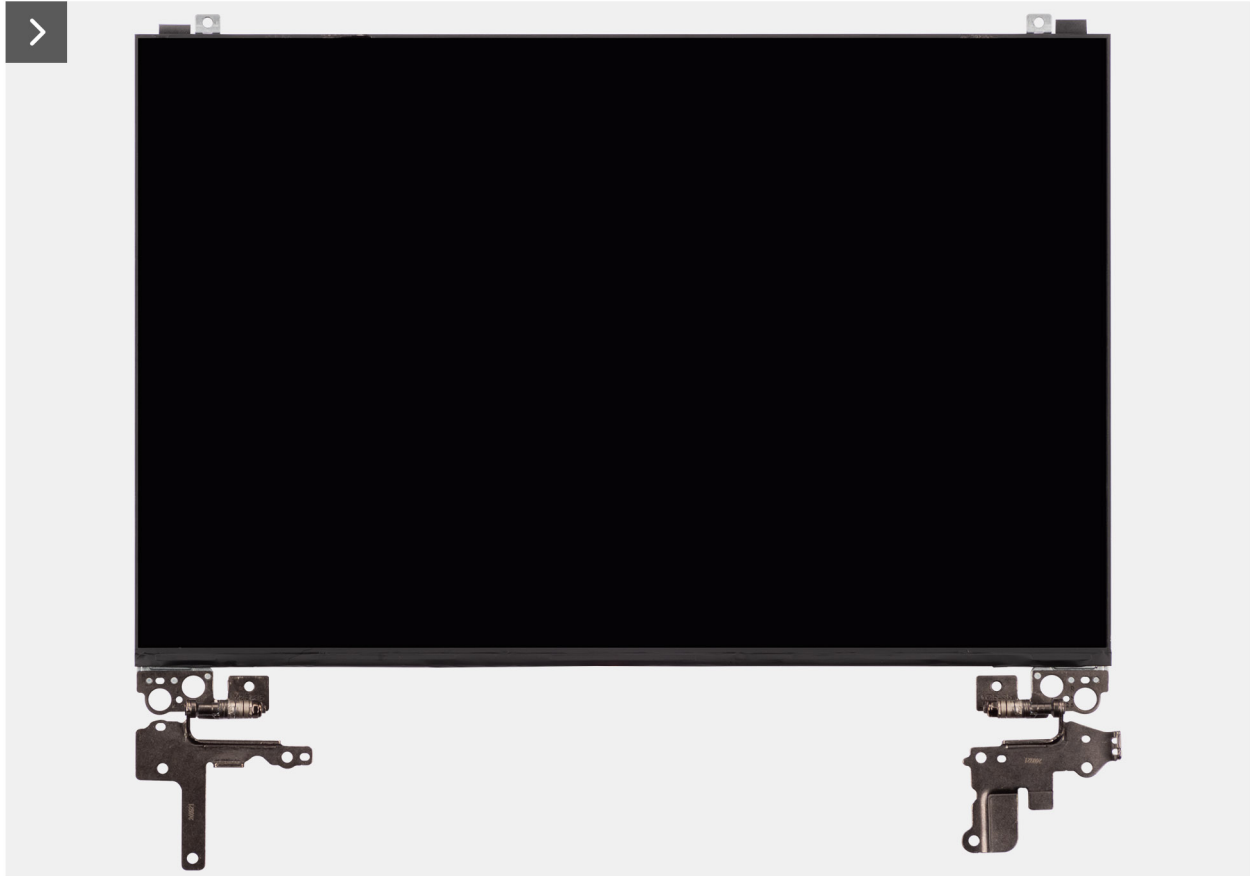
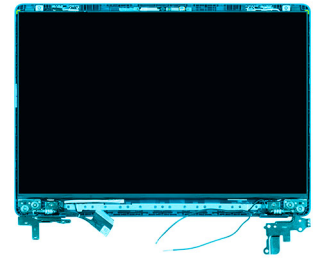

**Figure 115. Installing the display-panel assembly**

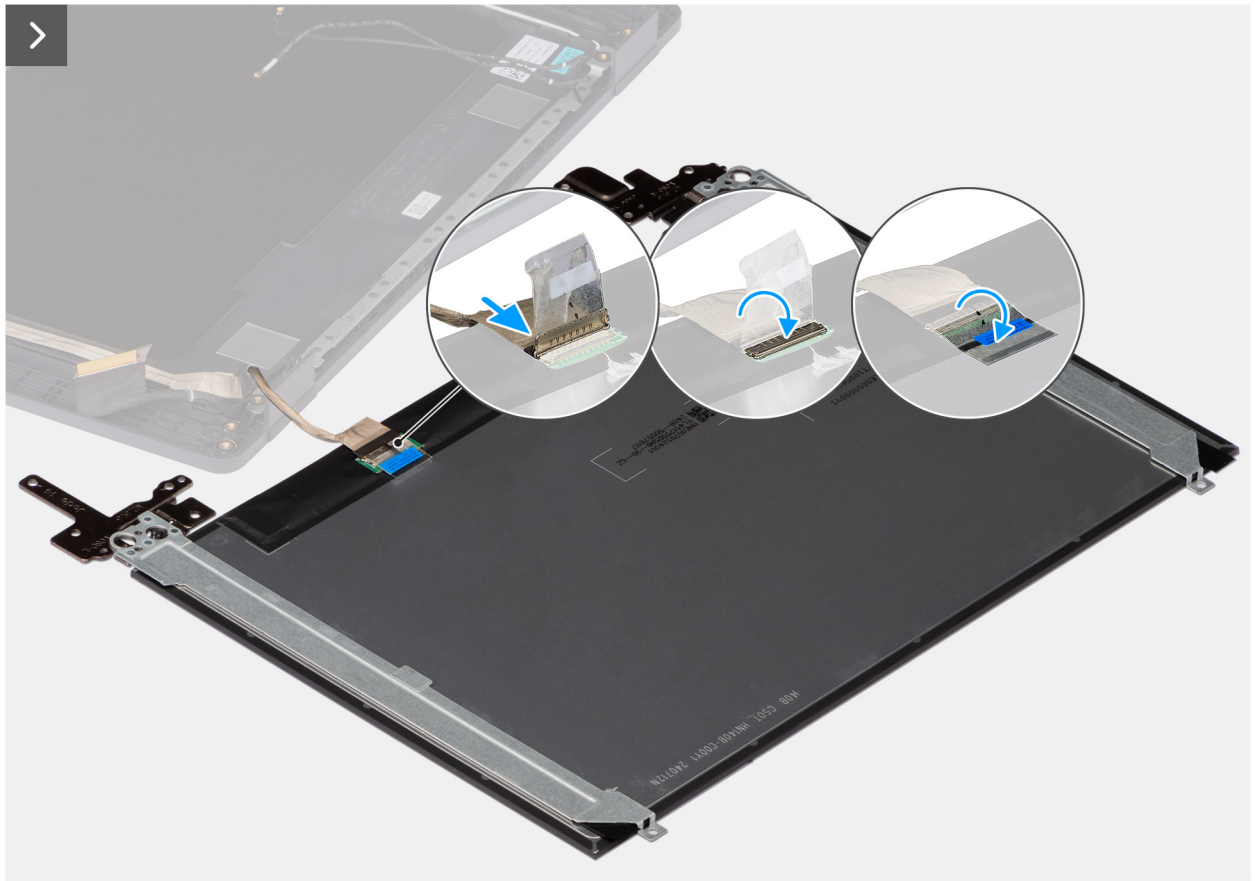

Figure 116. Installing the display-panel assembly



Figure 117. Installing the display-panel assembly



**Figure 118. Installing the display-panel assembly**

### Steps

**i** **NOTE:** The display-panel assembly is preassembled with the display brackets as a single service part. Do not pull the Stretch Release tapes to separate the brackets from the display panel.

1. Place the display-panel assembly on a flat and clean surface.
2. Connect the display cable to the connector (LCD1) on the display-panel assembly and close the latch.
3. Adhere the conductive tape to secure the display cable to the display-panel assembly.
4. Insert the display-panel assembly tabs into the slots on the display cover.
5. Replace the four (M2.5x2.5) screws and four (M2.5x3.5) screws to secure the display-panel assembly to the display back cover.

### Next steps

1. Install the [display bezel](#).
2. Install the [display assembly](#).
3. Install the [base cover](#).
4. Follow the procedure in [After working inside your computer](#).

## Camera

### Removing the camera

**⚠ CAUTION:** The information in this removal section is intended for authorized service technicians only.

### Prerequisites

1. Follow the procedure in [Before working inside your computer](#).
2. Remove the [base cover](#).
3. Remove the [display assembly](#).
4. Remove the [display bezel](#).
5. Remove the [display-panel assembly](#).

### About this task

The following image indicates the location of the camera and provides a visual representation of the removal procedure.

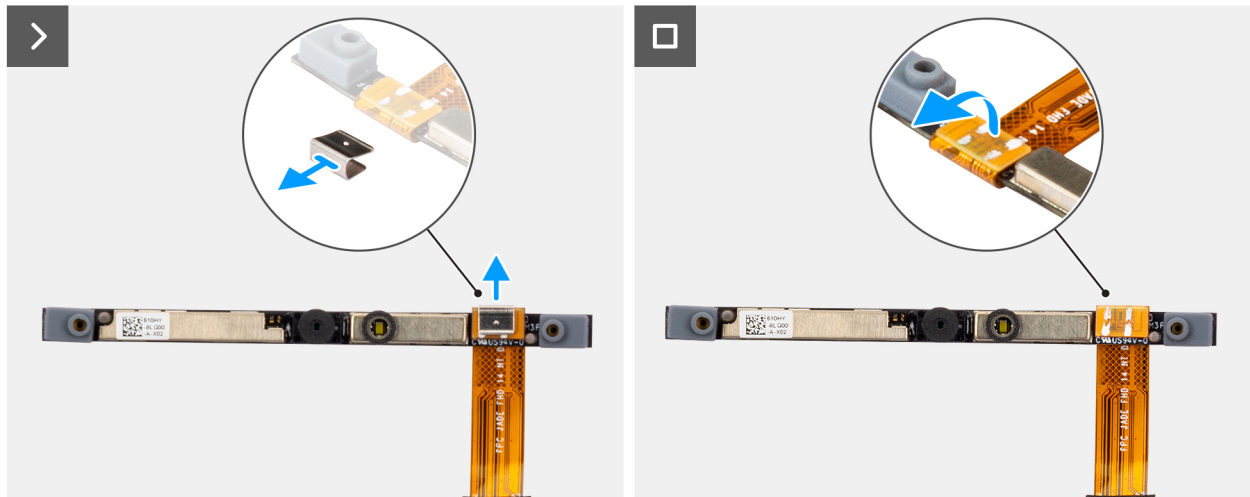

**Figure 119. Removing the camera**

### Steps

1. Peel off the cable with adhesive backing, then pry detach the camera away from the display back-cover assembly.
2. Remove the clip and disconnect the camera cable from the camera module.
3. Lift the camera module off the display back-cover.

## Installing the camera

**CAUTION:** The information in this installation section is intended for authorized service technicians only.

### Prerequisites

If you are replacing a component, remove the existing component before performing the installation procedure.

### About this task

The following image indicates the location of the camera and provides a visual representation of the installation procedure.

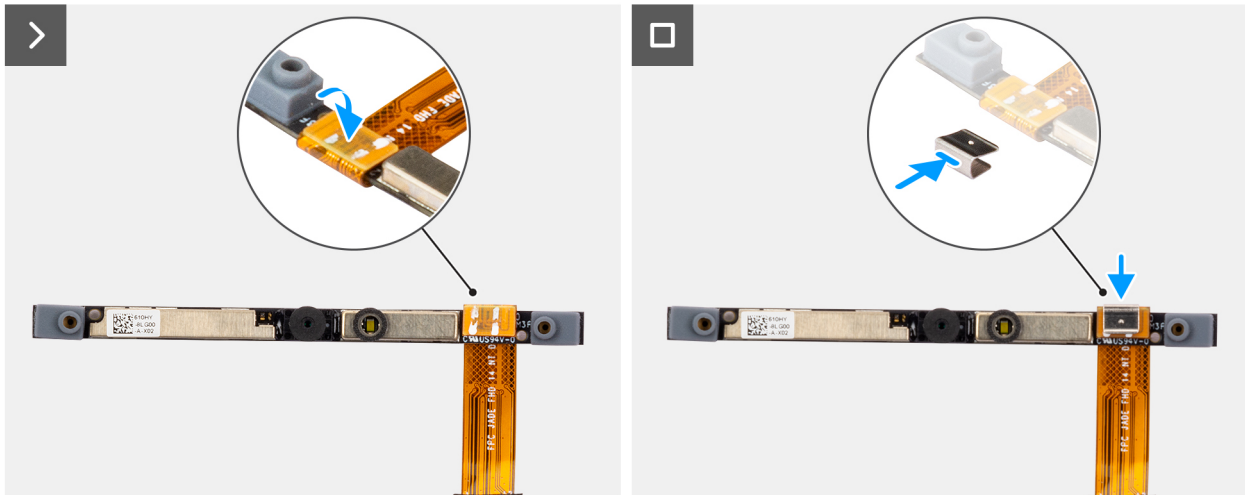

Figure 120. Installing the camera

#### Steps

1. Align and place the camera module on the slot on the display back-cover.
2. Connect the camera cable to the camera module and reattach the clip.

#### Next steps

1. Install the [display-panel assembly](#).
2. Install the [display bezel](#).
3. Install the [display assembly](#).
4. Install the [base cover](#).
5. Follow the procedure in [After working inside your computer](#).

## eDP cable

### Removing the eDP cable

**CAUTION:** The information in this removal section is intended for authorized service technicians only.

#### Prerequisites

1. Follow the procedure in [Before working inside your computer](#).
2. Remove the [base cover](#).
3. Remove the [display assembly](#).
4. Remove the [display bezel](#).
5. Remove the [display-panel assembly](#).
6. Remove the [camera](#).

### About this task

The following image indicates the location of the eDP cable and provides a visual representation of the removal procedure.

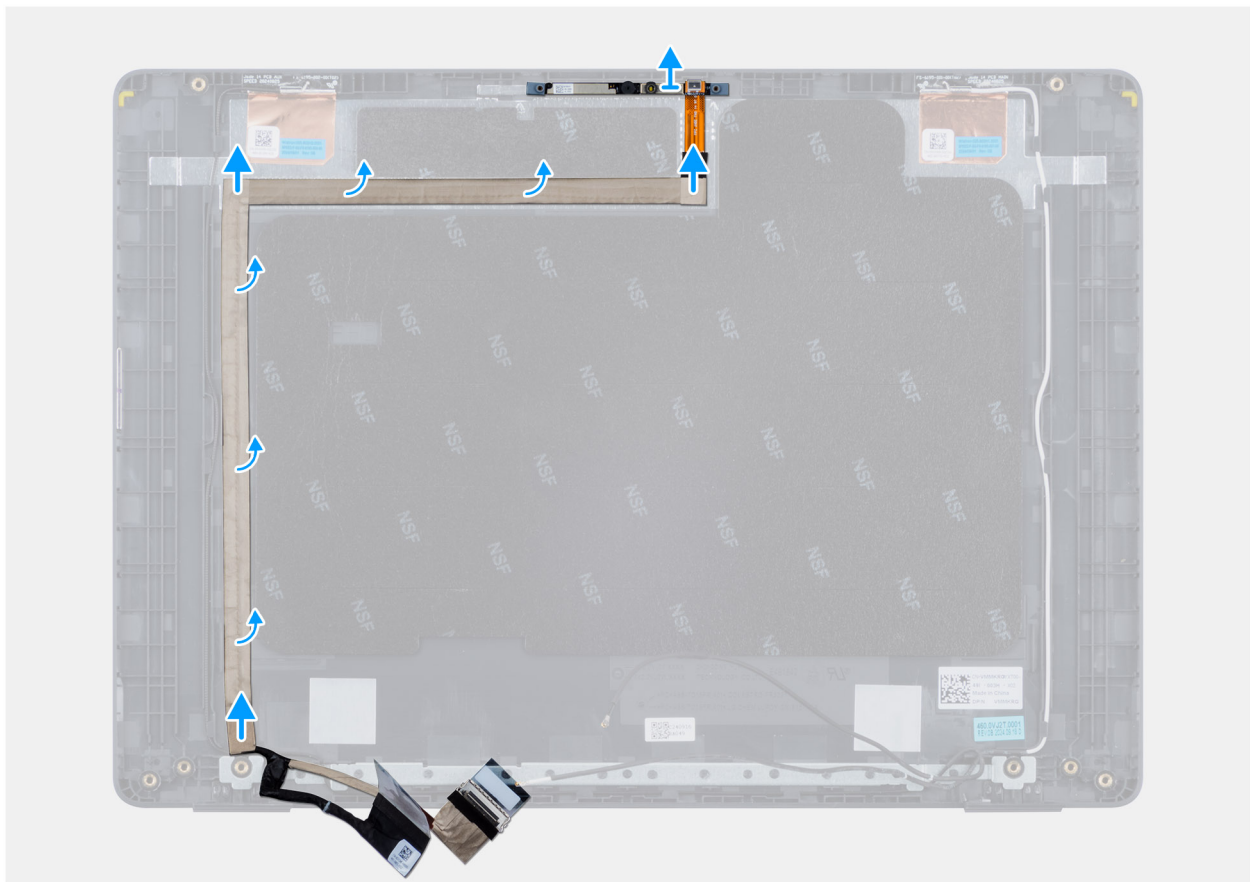

**Figure 121. Removing the eDP cable**

### Steps

1. Disconnect the eDP cable from the connector (LCD1) on the camera module.
2. Peel away the conductive tape that adheres the eDP cable to the display back-cover.
3. Lift the eDP cable away from the computer.

## Installing the eDP cable

**⚠ CAUTION:** The information in this installation section is intended for authorized service technicians only.

### Prerequisites

If you are replacing a component, remove the existing component before performing the installation procedure.

### About this task

The following image indicates the location of the eDP cable and provides a visual representation of the installation procedure.

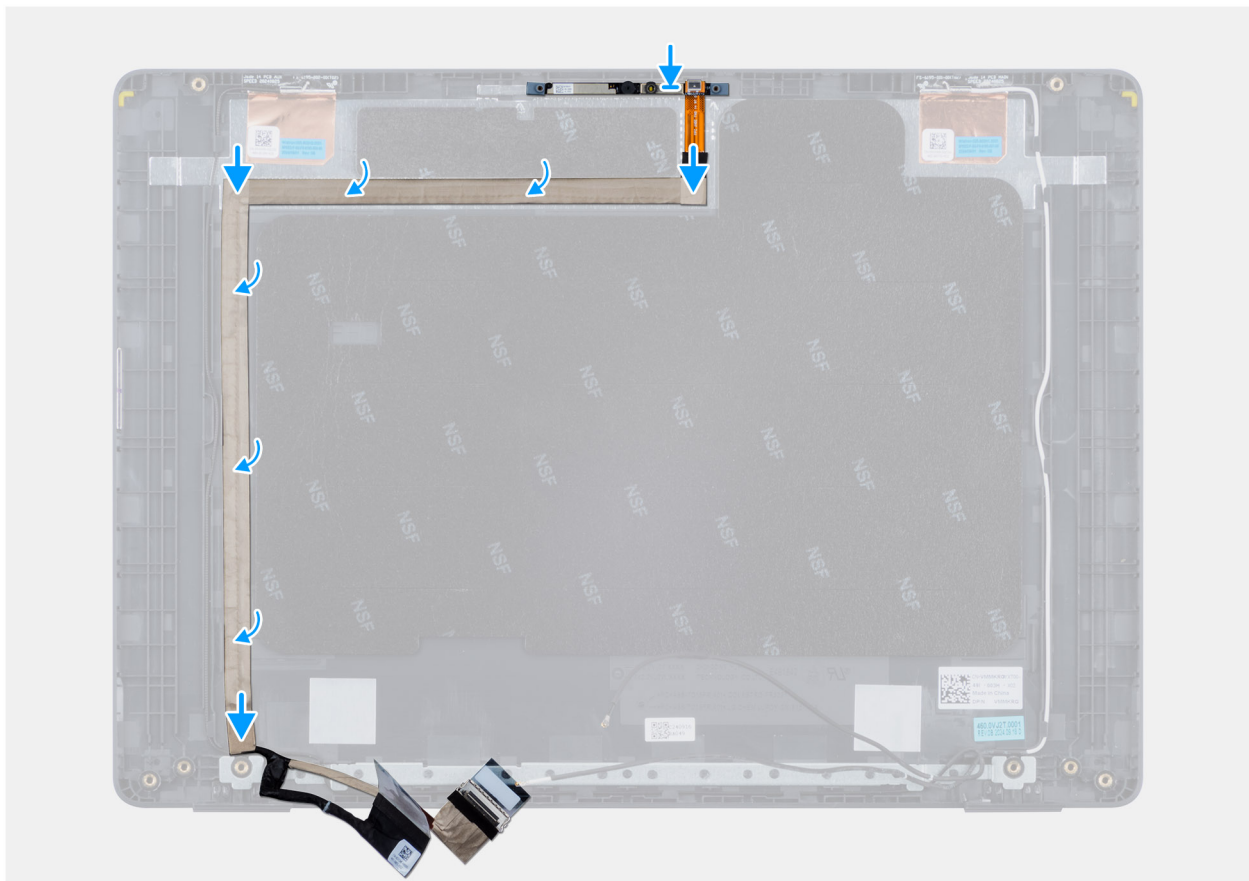

**Figure 122. Installing the eDP cable**

#### Steps

1. Connect the eDP cable to the connector (LCD1) on the camera module.
2. Adhere the eDP cable to the display back cover.
3. Adhere the conductive tape and route the eDP cable to the display back-cover.

#### Next steps

1. Install the [camera](#).
2. Install the [display-panel assembly](#).
3. Install the [display bezel](#).
4. Install the [display assembly](#).
5. Install the [base cover](#).
6. Follow the procedure in [After working inside your computer](#).

## Display back-cover assembly

### Removing the display back-cover assembly

**CAUTION:** The information in this removal section is intended for authorized service technicians only.

#### Prerequisites

1. Follow the procedure in [Before working inside your computer](#).
2. Remove the [base cover](#).
3. Remove the [display assembly](#).

4. Remove the [display bezel](#).
5. Remove the [display-panel assembly](#).
6. Remove the [camera](#).
7. Remove the [eDP cable](#).

#### About this task

The following image shows the display back-cover assembly and provide a visual representation of the removal procedure.



Figure 123. Removing the display back-cover assembly

#### Steps

After performing the steps in the pre-requisites, we are left with the display back-cover assembly.

## Installing the display back-cover assembly

**CAUTION:** The information in this installation section is intended for authorized service technicians only.

#### Prerequisites

If you are replacing a component, remove the existing component before performing the installation procedure.

#### About this task

The following image indicates the location of the display back-cover assembly and provides a visual representation of the installation procedure.



**Figure 124. Installing the display back-cover assembly**

### Steps

Place the display back-cover assembly on a clean and flat surface.

### Next steps

1. Install the [eDP cable](#).
2. Install the [camera](#).
3. Install the [display-panel assembly](#).
4. Install the [display bezel](#).
5. Install the [display assembly](#).
6. Install the [base cover](#).
7. Follow the procedure in [After working inside your computer](#).

# Software

This chapter details the supported operating systems along with instructions on how to install the drivers.

## Operating system

Your Dell Pro 14 PC14250 supports the following operating systems:

- Windows 11 Home
- Windows 11 Professional
- Ubuntu 24.04 LTS

 **NOTE:** If you downgrade your computer from Windows 11 to Windows 10 22H2, Dell Technologies support will follow the Microsoft Windows 10 End of Support plan.

## Drivers and downloads

When troubleshooting, downloading, or installing drivers, it is recommended that you read the [Dell Knowledge Base article Drivers and Downloads FAQs](#).

# BIOS Setup

**CAUTION:** Certain changes can make your computer work incorrectly. Before you change the settings in BIOS Setup, it is recommended that you note down the original settings for future reference.

**NOTE:** Depending on the computer and the installed devices, the options that are listed in this section may differ.

Use BIOS Setup for the following purposes:

- Get information about the hardware installed in your computer, such as the amount of RAM and the capacity of the storage device.
- Change the system configuration information.
- Set or change user-selectable options such as the user password, enabling or disabling base devices, and configuring hard drive settings.

## Entering BIOS Setup program

Turn on or restart your computer and press F2 immediately.

## Navigation keys

**NOTE:** For most of the BIOS Setup options, changes that you make are recorded but do not take effect until you restart the computer.

**Table 36. Navigation keys**

Keys	Navigation
Up arrow	Moves to the previous field.
Down arrow	Moves to the next field.
Enter	Selects a value in the selected field (if applicable) or follows the link in the field.
Spacebar	Expands or collapses a drop-down list, if applicable.
Tab	Moves to the next focus area.
Esc	Moves to the previous page until you view the main screen. Pressing Esc in the main screen displays a message that prompts you to save any unsaved changes and restart the computer.

## F12 One Time Boot menu

To enter the One Time Boot menu, turn on or restart your computer, and then press F12 immediately.

**NOTE:** If you are unable to enter the One Time Boot menu, repeat the above action.

The One Time Boot menu displays the devices that you can boot from and also display the options to start diagnostics. The boot menu options are:

- Removable Drive (if available)
- STXXXX Drive (if available)

**NOTE:** XXXX denotes the SATA drive number.

- Optical Drive (if available)
- SATA Hard Drive (if available)
- Diagnostics

The One Time Boot menu screen also displays the option to access BIOS Setup.

## View Advanced Setup options

### About this task

Some BIOS Setup options are only visible by enabling **Advanced Setup** mode, which is disabled by default.

**NOTE:** BIOS Setup options, including **Advanced Setup** options, are described in [BIOS setup options](#).

### To enable Advanced Setup:

#### Steps

1. Enter BIOS Setup.  
The Overview menu appears.
2. Click the **Advanced Setup** option to move it to the **ON** mode.  
Advanced BIOS Setup options are displayed.

## View Service options

### About this task

Service options are hidden by default and only visible by entering a hotkey command.

**NOTE:** Service options are described in [BIOS setup options](#).

### To view Service options:

#### Steps

1. Enter BIOS Setup.  
The Overview menu appears.
2. Enter the hotkey combination **Ctrl + Alt + s** to view the **Service** options.  
**Service** options are displayed.

## BIOS Setup options

**NOTE:** Depending on your computer and its installed devices, the items that are listed in this section may or may not be displayed.

**Table 37. BIOS Setup options—Overview menu**

Overview	
<b>Dell Pro 14 PC14250</b>	
BIOS Version	Displays the BIOS version number.
Service Tag	Displays the Service Tag of the computer.
Asset Tag	Displays the Asset Tag of the computer.
Manufacture Date	Displays the manufacture date of the computer.



**Table 37. BIOS Setup options—Overview menu (continued)**

<b>Overview</b>	
Ownership Date	Displays the ownership date of the computer.
Express Service Code	Displays the Express Service Code of the computer.
Ownership Tag	Displays the Ownership Tag of the computer.
<b>Battery Information</b>	
Primary	Displays the primary battery of the computer.
Battery Level	Displays the battery level of the computer.
Battery State	Displays the battery state of the computer.
Health	Displays the battery health of the computer.
AC Adapter	Displays whether an AC adapter is connected. If connected, displays the type of AC adapter that is connected.
Battery Life Type	Displays the battery life type.
<b>Processor Information</b>	
Processor Type	Displays the processor type.
Maximum Clock Speed	Displays the maximum processor clock speed.
Core Count	Displays the number of cores on the processor.
Processor ID	Displays the processor identification code.
Processor L2 Cache	Displays the processor L2 cache size.
Processor L3 Cache	Displays the processor L3 cache size.
Microcode Version	Displays the microcode version.
Intel Hyper-Threading Capable	Displays whether the processor is Hyper-Threading (HT) capable.
Intel vPro Technology	Displays whether the processor is Intel vPro Technology capable.
<b>Memory Information</b>	
Memory Installed	Displays the total memory that is installed on the computer.
Memory Available	Displays the total memory available on the computer.
Memory Speed	Displays the memory speed.
Memory Technology	Displays the technology that is used for the memory.
DIMM_SLOT A	Displays the total memory that is installed in DIMM Slot A
DIMM_SLOT B	Displays the total memory that is installed in DIMM Slot B
<b>Devices Information</b>	
Panel Type	Displays the type of display panel available on the computer.
Panel Revision	Displays the panel revision of the computer.
Video Controller	Displays the type of video controller available on the computer.
Video Memory	Displays the video memory information of the computer.
Wi-Fi Device	Displays the wireless device information of the computer.
Native Resolution	Displays the native resolution of the computer.
Video BIOS Version	Displays the video BIOS version of the computer.
Audio Controller	Displays the audio controller information of the computer.
Bluetooth Device	Displays the Bluetooth device information of the computer.

**Table 37. BIOS Setup options—Overview menu (continued)**

Overview	
LOM MAC Address	Displays the LOM MAC address of the computer.
Pass Through MAC Address	Displays the MAC address of the video pass-through.

**Table 38. BIOS Setup options—Boot Configuration menu**

Boot Configuration	
Boot Sequence	
Boot Sequence	Displays the boot mode of the computer and the boot sequence.
Enable PXE Boot Priority	
Enable PXE Boot Priority	Enables or disables the new PXE boot option. Allows loading an operating system over a network connection. By default, the <b>Enable PXE Boot Priority</b> option is disabled.
UEFI Network Boot Priority	
UEFI Network Boot Priority	This option allows to select the IPV4 and IPV6 option boot order.
Secure Boot	
	Secure Boot is a method of guaranteeing the integrity of the boot path by performing additional validation of the operating system and PCI add-in cards. The computer stops booting to the operating system when a component is not authenticated during the boot process. Secure Boot can be enabled in BIOS setup or using management interfaces like Dell Command Configure, but can only be disabled from BIOS setup.
Enable Secure Boot	Enables the computer to boot using only validated boot software. By default, the <b>Enable Secure Boot</b> option is disabled. For additional security, Dell Technologies recommends keeping the <b>Secure Boot</b> option is enabled to ensure that the UEFI firmware validates the operating system during the boot process.  <b>NOTE:</b> For Secure Boot to be enabled, the computer is required to be in UEFI boot mode and the Enable Legacy Option ROMs option is required to be turned off.
Enable Microsoft UEFI CA	When disabled, the UEFI CA is removed from the BIOS UEFI Secure Boot database. By default: <ul style="list-style-type: none"> <li>For computers shipped with <b>Intel Core Ultra 200U Series processors</b> the <b>Enable Microsoft UEFI CA</b> option is disabled.</li> <li>For computers shipped with <b>Intel Core Series processors</b> the <b>Enable Microsoft UEFI CA</b> option is enabled.</li> </ul>  <b>CAUTION:</b> When disabled, the Microsoft UEFI CA can cause your system to not boot, computer graphics may not function, some devices may not function properly, and the computer could become unrecoverable.
Secure Boot Mode	Enables or disables the Secure Boot operation mode. By default, the <b>Deployed Mode</b> is selected.  <b>NOTE:</b> <b>Deployed Mode</b> should be selected for normal operation of Secure Boot.
Expert Key Management	
Enable Custom Mode	Enables or disables the ability to modify the keys in the PK, KEK, db, and dbx security key databases to be modified.

**Table 38. BIOS Setup options—Boot Configuration menu (continued)**

<b>Boot Configuration</b>	
	By default, the <b>Enable Custom Mode</b> option is disabled.
Custom Mode Key Management	Selects the custom values for expert key management. By default, the <b>PK</b> option is selected.

**Table 39. BIOS Setup options—Integrated Devices menu**

<b>Integrated Devices</b>	
<b>Date/Time</b>	
Date	Sets the computer date in MM/DD/YYYY format. Changes to the date format take effect immediately.
Time	Sets the computer time in HH/MM/SS 24-hour format. You can switch between a 12-hour and 24-hour clock. Changes to the time format take effect immediately.
<b>Camera</b>	
Enable Camera	Enables the camera. By default, the <b>Enable Camera</b> option is enabled. <b>i</b> <b>NOTE:</b> Depending on the configuration ordered, the camera setup option may not be available.
<b>Audio</b>	
Enable Audio	Enables all integrated audio controller. By default, all the options are enabled.
Enable Microphone	Enables the microphone. By default, the <b>Enable Microphone</b> option is enabled. <b>i</b> <b>NOTE:</b> Depending on the configuration ordered, the microphone setup option may not be available.
Enable Internal Speaker	Enables the internal speaker. By default, the <b>Enable Internal Speaker</b> option is enabled.
<b>USB/Thunderbolt Configuration</b>	
Enable External USB Ports	Enables the external USB ports. By default, the <b>Enable External USB Ports</b> option is enabled.
Enable USB Boot Support	Enables booting from USB mass storage devices that are connected to external USB ports. By default, the <b>Enable USB Boot Support</b> option is enabled.
<b>Enable Thunderbolt Technology Support</b>	
Enable Thunderbolt Technology Support	Enables the associated ports and adapters for Thunderbolt Technology support. By default, the <b>Enable Thunderbolt Technology Support</b> option is enabled.
<b>Enable Thunderbolt Boot Support</b>	
Enable Thunderbolt Boot Support	Enables the Thunderbolt adapter-peripheral device and USB devices that are connected to the Thunderbolt adapter to be used during BIOS Preboot. By default, the <b>Enable Thunderbolt Boot Support</b> option is disabled.
<b>Disable USB4 PCIE Tunneling</b>	Disables the USB4 PCIE Tunneling option.

**Table 39. BIOS Setup options—Integrated Devices menu (continued)**

<b>Integrated Devices</b>	
	By default, the <b>Disable USB4 PCIe Tunneling</b> option is disabled.
<b>Video/Power only on Type-C Ports</b>	Enables or disables the Type-C port functionality to video or only power. By default, the <b>Video/Power only on Type-C Ports</b> option is disabled.
<b>Type-C Dock Override</b>	
Type-C Dock Override	Enables or disables to use connected Type-C Dell Dock to provide data stream with external USB ports disabled. When Type-C Dock override is enabled, the Video/Audio/LAN submenu is activated. By default, the <b>Type-C Dock Override</b> option is enabled.
Type-C Dock Audio	Enables or disables the usage of audio inputs and outputs from the connected Type-C Dell docking station. By default, the <b>Type-C Dock Audio</b> option is enabled.
Type-C Dock LAN	Enables or disables the usage of LAN on the external ports of the connected Type-C Dell docking station. By default, the <b>Type-C Dock LAN</b> option is enabled.
<b>Miscellaneous Devices</b>	
Enable Fingerprint Reader Device	Enable or disable Fingerprint Reader device. By default, the <b>Enable Fingerprint Reader Device</b> option is disabled.
<b>Unobtrusive mode</b>	
Enable Unobtrusive mode	Enables or disables the unobtrusive mode. When enabled, all system LEDs, LCD panel backlight, and audio devices of the computer are turned off. By default, the <b>Unobtrusive Mode</b> option is disabled.  <b>NOTE:</b> To view this option, enable <b>Advanced Setup</b> mode as described in <a href="#">View Advanced Setup options</a> .
<b>Dust Filter Maintenance</b>	
Dust Filter Maintenance	Allows you to enable or disable BIOS messages for maintaining the optional dust filter that is installed in your computer. BIOS will generate a pre-boot reminder to clean or replace the dust filter based on the interval set. By default, the <b>Dust Filter Maintenance</b> option is disabled.

**Table 40. BIOS Setup options—Storage menu**

<b>Storage</b>	
<b>SATA/NVMe Operation</b>	
SATA/NVMe Operation	Sets the operating mode of the integrated SATA hard drive controller. By default, the <b>RAID ON</b> option is selected. The storage device is configured for RAID mode.
<b>Storage Interface</b>	
Port Enablement	Enables or disables the M.2 PCIe SSD option. By default, the <b>M.2 PCIe SSD</b> option is enabled.
<b>Smart Reporting</b>	
Enable Smart Reporting	Enables or disables the Smart reporting option. By default, the <b>Enable Smart Reporting</b> option is disabled.

**Table 40. BIOS Setup options—Storage menu (continued)**

Storage	
	 <b>NOTE:</b> To view this option, enable <b>Advanced Setup</b> mode as described in <a href="#">View Advanced Setup options</a> .
<b>Drive Information</b>	Displays the information of onboard drives.

**Table 41. BIOS Setup options—Display menu**

Display	
<b>Display Brightness</b>	
Brightness on battery power	Enables to set the screen brightness when the computer is running on battery power. By default, the screen brightness is set to 50 when the computer is running on battery power.
Brightness on AC power	Enables to set the screen brightness when the computer is running on AC power. By default, the screen brightness is set to 100 when the computer is running on AC power.
<b>Touchscreen</b>	Enables or disables the touch screen option. By default, the <b>Touchscreen</b> option is enabled.
<b>Full Screen Logo</b>	Enables or disables the computer to display a full-screen logo, if the image matches screen resolution. By default, the <b>Full Screen Logo</b> option is disabled.

**Table 42. BIOS Setup options—Connection menu**

Connection	
<b>Network Controller Configuration</b>	
Integrated NIC	This option controls the onboard LAN Controller. By default, the <b>Enabled with PXE</b> option is enabled.
<b>Wireless Device Enable</b>	
WLAN	Enables or disables the internal WLAN device. By default, the <b>WLAN</b> option is enabled.
Bluetooth	Enables or disables the internal Bluetooth device. By default, the <b>Bluetooth</b> option is enabled.
<b>Enable UEFI Network Stack</b>	
Enable UEFI Network Stack	Enables or disables the UEFI Network Stack and controls the onboard LAN Controller. By default, the <b>Auto-Enabled</b> option is enabled.
IPv4 PXE Boot	When enabled, IPv4 PXE Boot option is available. When disabled, IPv4 PXE Boot option is not available.
IPv6 PXE Boot	When enabled, IPv6 PXE Boot option is available. When disabled, IPv4 PXE Boot option is not available.
<b>Wireless Radio Control</b>	
Control WLAN Radio	Enables to sense the connection of the computer to a wired network and then disables the selected wireless radios (WLAN and/or WWAN). Upon disconnection from the wired network, the selected wireless radios are reenabled.

**Table 42. BIOS Setup options—Connection menu (continued)**

Connection	
	By default, the <b>Control WLAN Radio</b> option is disabled.
Enable UEFI Bluetooth Stack	
Enable UEFI Bluetooth Stack	<p>Enables or disables the UEFI Bluetooth Stack and controls the onboard LAN Controller.</p> <p>By default, the <b>Enable UEFI Bluetooth Stack</b> option is enabled.</p> <p><b>i</b> <b>NOTE:</b> To view this option, enable <b>Advanced Setup</b> mode as described in <a href="#">View Advanced Setup options</a>.</p>
HTTP(s) Boot Feature	
HTTP(s) Boot	<p>When enabled, supports HTTP(s) boot on the client BIOS, which offers wired or wireless and HTTP/HTTPS connection options.</p> <p><b>i</b> <b>NOTE:</b> To view this option, enable <b>HTTP(s) Boot</b> as described in <a href="#">View Advanced Setup options</a>.</p>
HTTP(s) Boot Modes	<p>In Auto Mode, the boot URL is obtained from the DHCP response; the boot URL specifies the HTTP Boot Server and location of the Network Boot Program (NBP) file. In Manual mode, the user enters the URL in the text box, which must start with <code>http://</code> or <code>https://</code> and end with the NBP file name.</p> <p>By default, <b>Auto Mode</b> is selected.</p> <p><b>i</b> <b>NOTE:</b> To view this option, enable <b>Advanced Setup</b> mode as described in <a href="#">View Advanced Setup options</a>.</p>

**Table 43. BIOS Setup options—Power menu**

Power	
Battery Configuration	
Battery Configuration	<p>Enables or disables the computer to run on battery during peak power usage hours. Use the table <b>Custom Charge Start</b> and <b>Custom Charge Stop</b>, to prevent AC power usage between certain times of each day.</p> <p>By default, the <b>Adaptive</b> option is selected. Battery settings are adaptively optimized based on your typical battery usage pattern.</p>
Advanced Configuration	
Enable Advanced Battery Charge Configuration	<p>Enables Advanced Battery Charge Configuration from the beginning of the day to a specified work period. When enabled, Advanced Battery Charged maximizes battery health while still supporting heavy use during the work day.</p> <p>By default, the <b>Enable Advanced Battery Charge Configuration</b> option is disabled.</p>
Peak Shift	
Enable Peak Shift	<p>Enables the computer to run on battery during peak power usage hours.</p> <p>By default, the <b>Enable Peak Shift</b> option is disabled.</p>
Type-C Connector Power	
Type-C Connector Power	<p>This option allows to select the maximum power that can be drawn from the Type-C connector.</p> <p>By default, the <b>7.5 watts</b> option is enabled.</p>
Thermal Management	
Thermal Management	<p>Enables or disables cooling of fan and manages processor heat to adjust the computer performance, noise, and temperature.</p>

**Table 43. BIOS Setup options—Power menu (continued)**

<b>Power</b>	
	By default, the <b>Optimized</b> option is selected. Standard setting for balanced performance, noise, and temperature.
<b>USB Wake Support</b>	
Wake on Dell USB-C Dock	When enabled, connecting a Dell USB-C Dock wakes the computer from Standby, Hibernate, and Power Off.  By default, the <b>Wake on Dell USB-C Dock</b> option is enabled.
<b>Block Sleep</b>	
Block Sleep	Enables or disables the computer from entering Sleep (S3) mode in the operating system.  By default, the <b>Block Sleep</b> option is disabled. <b>i</b> <b>NOTE:</b> When enabled, the computer does not go to Sleep, Intel Rapid Start is disabled automatically, and the operating system power option is blank if it was set to Sleep.
<b>Lid Switch</b>	
Enable Lid Switch	Enables or disables the Lid Switch.  By default, the <b>Enable Lid Switch</b> option is enabled.



**Table 44. BIOS Setup options—Security menu**

<b>Security</b>	
<b>TPM 2.0 Security On</b>	
TPM 2.0 Security On	Allows you to enable or disable TPM.  By default, the <b>TPM 2.0 Security On</b> option is enabled.  For additional security, Dell Technologies recommends keeping <b>TPM 2.0 Security On</b> enabled to allow these security technologies to fully function.
Attestation Enable	The <b>Attestation Enable</b> option controls the endorsement hierarchy of TPM. Disabling the <b>Attestation Enable</b> option prevents TPM from being used to digitally sign certificates.  By default, the <b>Attestation Enable</b> option is enabled.  For additional security, Dell Technologies recommends keeping the <b>Attestation Enable</b> option is enabled. <b>i</b> <b>NOTE:</b> When disabled, this feature may cause compatibility issues or loss of functionality in some operating systems.
Key Storage Enable	The <b>Key Storage Enable</b> option controls the storage hierarchy of TPM, which is used to store digital keys. Disabling the <b>Key Storage Enable</b> option restricts the ability of TPM to store owner's data.  By default, the <b>Key Storage Enable</b> option is enabled.  For additional security, Dell Technologies recommends keeping the <b>Key Storage Enable</b> option is enabled. <b>i</b> <b>NOTE:</b> When disabled, this feature may cause compatibility issues or loss of functionality in some operating systems.
Clear	When enabled, the <b>Clear</b> option clears information that is stored in the TPM after exiting the computer's BIOS. This option returns to the disabled state when the computer restarts.  By default, the <b>Clear</b> option is disabled.

**Table 44. BIOS Setup options—Security menu (continued)**

<b>Security</b>	
	Dell Technologies recommends enabling the <b>Clear</b> option only when TPM data is required to be cleared.
Physical Presence Interface (PPI) Bypass for Clear Commands	By default, the <b>PPI Bypass for Clear Commands</b> option is disabled. For additional security, Dell Technologies recommends keeping the <b>PPI Bypass for Clear Commands</b> option disabled.
<b>Intel Total Memory Encryption</b>	
Multi-Key Total Memory Encryption (Up to 16 keys)	Enables or disables the processor’s memory encryption feature. By default, the <b>Intel Total Memory Encryption</b> option is disabled.
<b>Chassis intrusion</b>	
Chassis Intrusion	The chassis intrusion detection enables a physical switch that triggers an event when the computer cover is opened. When set to <b>Enabled</b> , a notification is displayed on the next boot and the event is logged in the BIOS Events log. When set to <b>On-Silent</b> , the event is logged in the BIOS Events log, but no notification is displayed. When set to <b>Disabled</b> , no notification is displayed and no event is logged in the BIOS Events log. By default, the <b>Chassis Intrusion</b> option is enabled. For additional security, Dell Technologies recommends keeping the <b>Chassis Intrusion Detection</b> option is disabled.
<b>Clear Intrusion Warning</b>	
Block Boot Until Cleared	The <b>Block Boot Until Cleared</b> option is enabled when <b>Chassis Intrusion Warning</b> is enabled. When enabled, the computer does not boot until the chassis intrusion is cleared.
<b>Data Wipe on Next Boot</b>	
Start Data Wipe	Data Wipe is a secure wipe operation that deletes information from a storage device. <b>CAUTION: The secure Data Wipe operation deletes information in a way that it cannot be reconstructed.</b> Commands such as delete and format in the operating system may remove files from showing up in the file system. However, they can be reconstructed through forensic means as they are still represented on the physical media. Data Wipe prevents this reconstruction, and the data can no longer be recovered. When enabled, the data wipe option provides prompts to wipe any storage devices that are connected to the computer on the next boot. By default, the <b>Start Data Wipe</b> option is disabled.
<b>Absolute</b>	
Absolute	Absolute Software provides various cyber security solutions, some requiring software preloaded on Dell computers and integrated into the BIOS. To use these features, you must enable the Absolute BIOS setting and contact Absolute for configuration and activation. By default, the <b>Absolute</b> option is enabled. For additional security, Dell Technologies recommends keeping the <b>Absolute</b> option is enabled.

**Table 44. BIOS Setup options—Security menu (continued)**

<b>Security</b>	
	<p> <b>NOTE:</b> When the Absolute features are activated, the Absolute integration cannot be disabled from the BIOS setup screen.</p>
<b>UEFI Boot Path Security</b>	
UEFI Boot Path Security	<p>Enables or disables the computer to prompt the user to enter the Administrator password (if set) when booting to a UEFI boot path device from the F12 boot menu.</p> <p>By default, the <b>Always Except Internal HDD</b> option is enabled.</p>
<b>Authenticated BIOS Interface</b>	
Enable Authenticated BIOS Interface	<p>Allows the administrator to control access to BIOS configuration through an authenticated interface. When enabled, this option ensures that BIOS configuration changes are secured by authentication.</p> <p>By default, the <b>Enable Authenticated BIOS Interface</b> option is disabled.</p>
Clear Certificate Store	<p>Deletes the certificate.</p>
Legacy Manageability Interface Access	<p>Allows the administrator to control the access to BIOS configuration through the Legacy Manageability Interface option. When enabled, this prevents the BIOS Administrator password-based manageability tools from running, prevents some Dell software applications from reading configuration settings, and/or prevents changes to the BIOS configuration settings.</p> <p>When enabled, this option only supports the Authenticated BIOS Manageability Interface (ABI) for managing the BIOS configuration changes. To support this feature, ABI must be enabled and provisioned.</p> <p>When set to <b>Enabled</b>, the Legacy Manageability Interface can be used to read and change BIOS configuration settings.</p> <p>When set to <b>Read-Only</b>, BIOS configuration settings can be read, but cannot be changed through the Legacy Manageability Interface.</p> <p>When set to <b>Disabled</b>, the Legacy Manageability Interface is disabled. BIOS configuration reads and writes are blocked.</p>
<b>Firmware Device Tamper Detection</b>	
Firmware Device Tamper Detection	<p>Allows you to control the firmware device tamper detection feature. This feature notifies the user when the firmware device is tampered. When enabled, a screen warning messages are displayed on the computer and a tamper detection event is logged in the BIOS Events log. The computer fails to reboot until the event is cleared.</p> <p>By default, the <b>Silent</b> option is enabled.</p> <p>For additional security, Dell Technologies recommends keeping the <b>Firmware Device Tamper Detection</b> option is enabled.</p>
Clear Firmware Device Tamper Detection	<p>Allows you to clear the events that are logged when tampering of firmware device is detected.</p> <p>By default, the <b>Clear Firmware Device Tamper Detection</b> option is disabled.</p> <p> <b>NOTE:</b> To view this option, enable <b>Advanced Setup</b> mode as described in <a href="#">View Advanced Setup options</a>.</p>

**Table 45. BIOS Setup options—Passwords menu**

<b>Passwords</b>	
<b>Admin Password</b>	<p>The Administrator Password prevents unauthorized access to the BIOS Setup options. Once the administrator password is set, the BIOS setup options can only be modified after providing the correct password.</p> <p>The following rules and dependencies apply to the Administrator Password -</p> <ul style="list-style-type: none"> <li>• The administrator password cannot be set if computer and/or internal storage passwords are previously set.</li> <li>• The administrator password can be used in place of the computer and/or internal storage passwords.</li> <li>• When set, the administrator password must be provided during a firmware update.</li> <li>• Clearing the administrator password also clears the computer password (if set).</li> </ul> <p>Dell Technologies recommends using an administrator password to prevent unauthorized changes to BIOS setup options.</p>
<b>System Password</b>	<p>The System Password prevents the computer from booting to an operating system without entering the correct password.</p> <p>The following rules and dependencies apply when the System Password is used -</p> <ul style="list-style-type: none"> <li>• The computer shuts down when idle for approximately 10 minutes at the computer password prompt.</li> <li>• The computer shuts down after three incorrect attempts to enter the computer password.</li> <li>• The computer shuts down when the <b>Esc</b> key is pressed at the System Password prompt.</li> <li>• The computer password is not prompted when the computer resumes from standby mode.</li> </ul> <p>Dell Technologies recommends using the computer password in situations where it is likely that a computer may be lost or stolen.</p>
<b>M.2 PCIe SSD-0</b>	<p>The hard drive password can be set to prevent unauthorized access of the data stored on the solid-state drive. The computer prompts for the hard drive password during boot in order to unlock the drive. A password-secured hard drive stays locked even when removed from the computer or placed into another computer. It prevents an attacker from accessing data on the drive without authorization.</p> <p>The following rules and dependencies apply when the <b>Hard Drive Password</b> or <b>M.2 PCIe SSD-0 Password</b> option is used.</p> <ul style="list-style-type: none"> <li>• The hard drive password option cannot be accessed when the hard drive is disabled in the BIOS Setup.</li> <li>• The computer shuts down when idle for approximately 10 minutes at the hard drive password prompt.</li> <li>• The computer shuts down after three incorrect attempts to enter the hard drive password and treats the hard drive as not available.</li> <li>• The hard drive does not accept password unlock attempts after five incorrect attempts to enter the hard drive password from the BIOS Setup. The hard drive password must be reset for the new password unlock attempts.</li> <li>• The computer treats the hard drive as not available when the <b>Esc</b> key is pressed at the hard drive password prompt.</li> <li>• The hard drive password is not prompted when the computer resumes from standby mode. When the hard drive is unlocked by the user before the computer goes into standby mode, it remains unlocked after the computer resumes from standby mode.</li> <li>• If the system and hard drive passwords are set to the same value, the hard drive unlocks after the correct system password is entered.</li> </ul> <p>Dell Technologies recommends using a hard drive password to protect unauthorized data access.</p>

**Table 45. BIOS Setup options—Passwords menu (continued)**

<b>Passwords</b>	
<b>Password Configuration</b>	<p>The Password configuration page includes several options for changing the requirements of BIOS passwords. You can modify the minimum and maximum length of the passwords and require passwords to contain certain character classes (upper case, lower case, digit, special character).</p> <p>Dell Technologies recommends setting the minimum password length to at least eight characters.</p>
<b>Password Bypass</b>	
Password Bypass	<p>The <b>Password Bypass</b> option allows the computer to reboot from the operating system without entering the computer or hard drive password. If the computer has already booted to the operating system, it is presumed that the user has already entered the correct computer or hard drive password.</p> <p><b>NOTE:</b> This option does not remove the requirement to enter the password after shutting down.</p> <p>By default, the <b>Password Bypass</b> option is enabled.</p> <p>For additional security, Dell Technologies recommends keeping the <b>Password Bypass</b> option is enabled.</p>
<b>Password Changes</b>	
Allow Non-Admin Password Changes	<p>The <b>Allow Non-Admin Password Changes</b> option in BIOS Setup allows an end user to set or change the system or hard drive passwords without entering the administrator password. This gives an administrator control over the BIOS settings but enables an end user to provide their own password.</p> <p>By default, the <b>Allow Non-Admin Password Changes</b> option is enabled.</p> <p>For additional security, Dell Technologies recommends keeping the <b>Allow Non-Admin Password Changes</b> option disabled.</p>
Admin Setup Lockout	<p>The <b>Admin Setup Lockout</b> option prevents an end user from even viewing the BIOS setup configuration without first entering the administrator password (if set).</p> <p>By default, the <b>Admin Setup Lockout</b> option is disabled.</p> <p>For additional security, Dell Technologies recommends keeping the <b>Admin Setup Lockout</b> option disabled.</p>
<b>Master Password Lockout</b>	
Enable Master Password Lockout	<p>The Master Password Lockout setting allows you to disable the Recovery Password feature. If the computer, administrator, or hard drive password is forgotten, the computer becomes unusable.</p> <p><b>NOTE:</b> When the owner password is set, the Master Password Lockout option is not available.</p> <p><b>NOTE:</b> When an internal hard drive password is set, it must first be cleared before Master Password Lockout can be changed.</p> <p>By default, the <b>Enable Master Password Lockout</b> option is disabled.</p> <p>Dell does not recommend enabling the <b>Master Password Lockout</b> unless you have implemented your own password recovery computer.</p>
<b>Allow Non-Admin PSID Revert</b>	
Enable Allow Non-Admin PSID Revert	<p>The <b>Allow Non-Admin PSID Revert</b> option allows a user to clear the hard drive password without entering the BIOS Admin Password. When an Admin Password is set, the ability to enter the PSID is protected by requiring authentication with the Admin Password. If this option is enabled, any user can clear the drive without entering the Admin Password.</p> <p>By default, the <b>Enable Allow Non-Admin PSID Revert</b> option is disabled.</p>

**Table 45. BIOS Setup options—Passwords menu (continued)**

Passwords	
	<p><b>i</b> <b>NOTE:</b> To view this option, enable <b>Advanced Setup</b> mode as described in <a href="#">View Advanced Setup options</a>.</p>

**Table 46. BIOS Setup options—Update, Recovery menu**

Update, Recovery	
<b>BIOS Recovery from Hard Drive</b>	<p>Enables or disables the user to recover from certain corrupted BIOS conditions from a recovery file on the user primary hard drive or an external USB key.</p> <p>By default, the <b>BIOS Recovery from Hard Drive</b> option is enabled.</p> <p><b>i</b> <b>NOTE:</b> BIOS Recovery from Hard Drive is not available for self-encrypting drives (SED).</p> <p><b>i</b> <b>NOTE:</b> BIOS recovery is designed to fix the main BIOS block and cannot work if the Boot Block is damaged. In addition, this feature cannot work in the event of EC corruption, ME corruption, or a hardware issue. The recovery image must exist on an unencrypted partition on the drive.</p>
<b>BIOS Downgrade</b>	
Allow BIOS Downgrade	<p>Controls flashing of the computer firmware to previous revisions.</p> <p>By default, the <b>Allow BIOS Downgrade</b> option is enabled.</p>
<b>SupportAssist OS Recovery</b>	
SupportAssist OS Recovery	<p>Enables or disables the boot flow for SupportAssist OS Recovery tool in the event of certain computer errors.</p> <p>By default, the <b>SupportAssist OS Recovery</b> option is enabled.</p>
<b>BIOSConnect</b>	
BIOSConnect	<p>Enables or disables cloud Service operating system recovery if the main operating system fails to boot with the number of failures equal to or greater than the value specified by the Auto OS Recovery Threshold setup option and local Service operating system does not boot or is not installed.</p> <p>By default, the <b>BIOSConnect</b> option is enabled.</p>
<b>Dell Auto OS Recovery Threshold</b>	
Dell Auto OS Recovery Threshold	<p>Allows you to control the automatic boot flow for SupportAssist System Resolution Console and for Dell OS Recovery Tool.</p> <p>By default, the <b>Dell Auto OS Recovery Threshold</b> value is set to 2.</p>

**Table 47. BIOS Setup options—System Management menu**

System Management	
<b>Service Tag</b>	Displays the Service Tag of the computer.
<b>Asset Tag</b>	<p>Creates a computer Asset Tag that can be used by an IT administrator to uniquely identify a particular computer.</p> <p><b>i</b> <b>NOTE:</b> Once set in the BIOS, the Asset Tag cannot be changed.</p>
<b>AC Behavior</b>	
Wake on AC	<p>Enables or disables the computer to turn on and go to boot when AC power is supplied to the computer.</p> <p>By default, the <b>Wake on AC</b> option is disabled.</p>
<b>Wake on LAN</b>	

**Table 47. BIOS Setup options—System Management menu (continued)**

<b>System Management</b>	
Wake on LAN	Enables or disables the computer to turn on by a special LAN signal. By default, the <b>Wake on LAN</b> option is disabled.
<b>Auto On Time</b>	
Auto On Time	Enable to set the computer to turn on automatically every day or on a preselected date and time. This option can be configured only if the Auto On Time is set to Everyday, Weekdays, or Selected Days. By default, the <b>Auto On Time</b> option is disabled.
<b>Intel AMT capability</b>	
Enable Intel AMT capability	Configure Intel Active Management Technology (AMT) options, which can be enabled, disabled, or restricted. By default, the <b>Restrict Preboot Access</b> option is enabled.
<b>First Power On Date</b>	
Set Ownership Date	This option lets you set an Ownership date. By default, the <b>Set Ownership Date</b> option is disabled.
<b>Diagnostics</b>	
OS Agent Requests	Enable or disable the option for applications running in the operating system to run with preboot diagnostics on subsequent boots. <b>i</b> <b>NOTE:</b> To view this option, enable <b>Advanced Setup</b> mode as described in <a href="#">View Advanced Setup options</a> .
<b>Power-on-Self-Test Automatic Recovery</b>	
Power-on-Self-Test Automatic Recovery	Enable or disable the automatic recovery of the computer from no power or no-POST failure by applying mitigation steps. By default, the <b>Power-On-Self-Test Automatic Recovery</b> option is enabled. <b>i</b> <b>NOTE:</b> To view this option, enable <b>Advanced Setup</b> mode as described in <a href="#">View Advanced Setup options</a> .

**Table 48. BIOS Setup options—Keyboard menu**

<b>Keyboard</b>	
<b>Fn Lock Options</b>	
Fn Lock Options	Enables or disables the Fn Lock option. By default, the <b>Fn Lock</b> option is enabled.
Lock Mode	By default, the <b>Lock Mode Secondary</b> option is enabled. With this option, the F1-F12 keys scan the code for their secondary functions.
<b>Keyboard Illumination</b>	
Keyboard Illumination	Set the keyboard illumination settings. By default, the <b>Dim</b> option is enabled.
<b>Keyboard Backlight Timeout on AC</b>	
Keyboard Backlight Timeout on AC	Set the timeout value for the keyboard backlight when an AC adapter is connected to the system. By default, the <b>10 seconds</b> option is enabled.
<b>Keyboard Backlight Timeout on Battery</b>	

**Table 48. BIOS Setup options—Keyboard menu (continued)**

<b>Keyboard</b>	
Keyboard Backlight Timeout on Battery	Set the timeout value for the keyboard backlight when the is running only on battery power.  By default, the <b>10 seconds</b> option is enabled.
<b>Device Configuration HotKey Access</b>	
Device Configuration HotKey Access	Allows you to control whether you can access device configuration screens through hotkeys during system startup.By default, the <b>Device Configuration HotKey Access</b> option is enabled.  <b>i</b> <b>NOTE:</b> This setting controls only the Intel RAID (CTRL+I), MEBX (CTRL+P), and LSI RAID (CTRL+C) Option ROMs. Other preboot Option ROMs, which support entry using a key sequence, are not affected by this setting

**Table 49. BIOS Setup options—Pre-boot Behavior menu**

<b>Preboot Behavior</b>	
<b>Adapter Warnings</b>	
Enable Adapter Warnings	Enables the warning messages during boot when the adapters with less power capacity are detected.  By default, the <b>Enable Adapter Warnings</b> option is enabled.
<b>Warnings and Errors</b>	
Warnings and Errors	Enables or disables the action to be taken when a warning or error is encountered.  By default, the <b>Prompt on Warnings and Errors</b> option is selected.  <b>i</b> <b>NOTE:</b> Errors deemed critical to the operation of the computer hardware stop the functioning of the computer.
<b>USB-C Warnings</b>	
Enable Dock Warning Messages	Enables the warning messages during boot when the USB-C adapters with less power capacity are detected.  By default, the <b>Enable Dock Warning Messages</b> option is enabled.
<b>Extend BIOS POST Time</b>	
Extend BIOS POST Time	Sets the BIOS POST (Power-On Self-Test) load time.  By default, the <b>0 seconds</b> option is selected.
<b>MAC Address Pass-Through</b>	
MAC Address Pass-Through	Replaces the external NIC MAC address (in a supported dock or dongle) with the selected MAC address from the computer.  By default, the <b>System Unique MAC Address</b> option is selected.
<b>Show Ownership Tag with Logo</b>	
Show Ownership Tag with Logo	Displays the system ownership tag in addition to the BIOS Boot logo.

**Table 50. BIOS Setup options—Virtualization menu**

<b>Virtualization</b>	
<b>Intel Trusted Execution Technology (TXT)</b>	
Enable Intel Trusted Execution Technology (TXT)	Intel Trusted Execution Technology (TXT) is a set of hardware extensions to Intel processors and chipsets. It provides a hardware-based root of trust to ensure that a platform boots with a known good configuration of firmware, BIOS, virtual

**Table 50. BIOS Setup options—Virtualization menu (continued)**

<b>Virtualization</b>	
	<p>machine monitor, and operating system. The following must be enabled in order to enable Intel TXT -</p> <ul style="list-style-type: none"> <li>• Intel Virtualization Technology - X</li> <li>• Intel Virtualization Technology - Direct</li> </ul> <p>By default, the Intel <b>Trusted Execution Technology (TXT)</b> option is disabled.</p>
<b>DMA Protection</b>	
Enable Pre-Boot DMA Support	<p>Allows you to control the Pre-Boot DMA protection for both internal and external ports. This option does not directly enable DMA protection in the operating system.</p> <p><b>NOTE:</b> This option is not available when the virtualization setting for IOMMU is disabled (VT-d/AMD Vi).</p> <p>By default, the <b>Enable Pre-Boot DMA Support</b> option is enabled.</p> <p>For additional security, Dell Technologies recommends keeping the <b>Enable Pre-Boot DMA Support</b> option is enabled.</p> <p><b>NOTE:</b> This option is provided only for compatibility purposes, since some older hardware is not DMA capable.</p>
Enable OS Kernel DMA Support	<p>Allows you to control the Kernel DMA protection for both internal and external ports. This option does not directly enable DMA protection in the operating system. For operating systems that support DMA protection, this setting indicates to the operating system that the BIOS supports the feature.</p> <p><b>NOTE:</b> This option is not available when the virtualization setting for IOMMU is disabled (VT-d/AMD Vi).</p> <p>By default, the <b>Enable OS Kernel DMA Support</b> option is enabled.</p> <p><b>NOTE:</b> This option is provided only for compatibility purposes, since some older hardware is not DMA capable.</p>
Internal Port DMA Compatibility Mode	<p>Allows you to control the boot compatibility for integrated PCIe peripherals by disabling PCIe DMA protection on internal PCIe ports.</p> <p>When enabled, BIOS will notify the operating system that the internal ports are not DMA capable. This option is to help with devices that have operating system DMA compatibility issues. This option does not directly enable DMA protection in the operating system.</p> <p><b>NOTE:</b> This option is not available when the virtualization setting for IOMMU is disabled (VT-d/AMD Vi).</p> <p>By default, the <b>Internal Port DMA Compatibility Mode</b> option is enabled.</p> <p><b>NOTE:</b> This option is provided only for compatibility purposes, since some older hardware is not DMA capable.</p>

**Table 51. BIOS Setup options—Performance menu**

<b>Performance</b>	
<b>Intel SpeedStep</b>	
Enable Intel SpeedStep Technology	<p>Enables the computer to dynamically adjust processor voltage and core frequency, decreasing average power consumption and heat production.</p> <p>By default, the <b>Enable Intel SpeedStep Technology</b> option is enabled.</p> <p><b>NOTE:</b> To view this option, enable <b>Service</b> options as described in <a href="#">Service options</a>.</p>
<b>Intel Hyper-Threading Technology</b>	

**Table 51. BIOS Setup options—Performance menu (continued)**

Performance	
Enable Intel Hyper-Threading Technology	<p>Enables or disables the Intel Hyper-Threading mode of the processor. When enabled, the Intel Hyper-Threading increases the efficiency of the processor resources when multiple threads run on each core.</p> <p>By default, the <b>Intel Hyper-Threading Technology</b> option is enabled.</p> <p> <b>NOTE:</b> To view this option, enable <b>Advanced Setup</b> mode as described in <a href="#">View Advanced Setup options</a>.</p>

**Table 52. BIOS Setup options—System Logs menu**

System Logs	
<b>BIOS Event Log</b>	
Clear BIOS Event Log	<p>Allows you to select option to keep or clear BIOS events logs.</p> <p>By default, the <b>Keep Log</b> option is selected.</p>
<b>Thermal Event Log</b>	
Clear Thermal Event Log	<p>Allows you to select option to keep or clear thermal events logs.</p> <p>By default, the <b>Keep Log</b> option is selected.</p>
<b>Power Event Log</b>	
Clear Power Event Log	<p>Allows you to select option to keep or clear power events logs.</p> <p>By default, the <b>Keep Log</b> option is selected.</p>

## Updating the BIOS

### Updating the BIOS in Windows

#### About this task

 **CAUTION:** If BitLocker is not suspended before updating the BIOS, the BitLocker key is not recognized the next time you reboot the computer. You will then be prompted to enter the recovery key to proceed, and the computer displays a prompt for the recovery key on each reboot. Failure to provide the recovery key can result in data loss or an operating system reinstall. For more information, see the Knowledge Base Resource [updating the BIOS on Dell systems with BitLocker enabled](#).

#### Steps

1. Go to [Dell Support Site](#).
2. Go to **Search Dell or identify your product**. In the box, enter the product identifier, model, service request or describe what you are looking for, and then click **Search**.
 

 **NOTE:** If you do not have the Service Tag, use the SupportAssist to automatically identify your computer. You can also use the product ID or manually browse for your computer model.
3. Click **Drivers & Downloads**.
4. Select the operating system installed on your computer.
5. In the **Category** drop-down list, select **BIOS**.
6. Select the latest version of BIOS, and click **Download** to download the BIOS file for your computer.
7. After the download is complete, browse the folder where you saved the BIOS update file.
8. Double-click the BIOS update file icon and follow the on-screen instructions.
 

For more information, search in the Knowledge Base Resource at [Dell Support Site](#).

## Updating the BIOS in Linux and Ubuntu

To update the system BIOS on a computer that is installed with Linux or Ubuntu, see [How to Update the Dell BIOS in the Ubuntu or Linux Environment](#) at [Dell Support Site](#).

## Updating the BIOS using the USB drive in Windows

### About this task

**CAUTION:** If BitLocker is not suspended before updating the BIOS, the BitLocker key is not recognized the next time you reboot the computer. You will then be prompted to enter the recovery key to proceed, and the computer displays a prompt for the recovery key on each reboot. Failure to provide the recovery key can result in data loss or an operating system reinstall. For more information, see the Knowledge Base Resource [updating the BIOS on Dell systems with BitLocker enabled](#).

### Steps

1. Go to [Dell Support Site](#).
2. Go to **Search Dell or identify your product** . In the box, enter the product identifier, model, service request or describe what you are looking for, and then click **Search**.  
**NOTE:** If you do not have the Service Tag, use the SupportAssist to automatically identify your computer. You can also use the product ID or manually browse for your computer model.
3. Click **Drivers & Downloads**.
4. Select the operating system installed on your computer.
5. In the **Category** drop-down list, select **BIOS**.
6. Select the latest version of BIOS, and click **Download** to download the BIOS file for your computer.
7. Create a bootable USB drive. For more information, search in the Knowledge Base Resource at [Dell Support Site](#).
8. Copy the BIOS setup program file to the bootable USB drive.
9. Connect the bootable USB drive to the computer that needs the BIOS update.
10. Restart the computer and press **F12**.
11. Select the USB drive from the **One Time Boot Menu**.
12. Type the BIOS setup program filename and press **Enter**.  
The **BIOS Update Utility** appears.
13. Follow the on-screen instructions to complete the BIOS update.

## Updating the BIOS from the One-Time boot menu

To update the BIOS from the One-Time boot menu, see [Updating the BIOS from the One Time Boot Menu](#) at [Dell Support Site](#).

## System and setup password

**CAUTION:** The password features provide a basic level of security for the data on your computer.

**CAUTION:** Ensure that your computer is locked when it is not in use. Anyone can access the data that is stored on your computer, when left unattended.

**Table 53. System and setup password**

Password type	Description
System password	Password that you must enter to boot to your operating system.

**Table 53. System and setup password (continued)**

Password type	Description
Setup password	Password that you must enter to access and change the BIOS settings of your computer.

You can create a system password and a setup password to secure your computer.

 **NOTE:** The System and setup password feature is disabled by default.

## Assigning a System Setup password

### Prerequisites

You can assign a new System or Admin Password only when the status is set to **Not Set**. To enter BIOS System Setup, press F2 immediately after a power-on or reboot.

### Steps

1. To enter the **System Setup**, press **F2** immediately after a power-on or reboot.
2. In the **System BIOS** or **System Setup** screen, select **Security** and press Enter.  
The **Security** screen is displayed.
3. Select **System/Admin Password** and create a password in the **Enter the new password** field.  
Use the following guidelines to create the system password:
  - Password can be up to 32 characters.
  - Password must contain at least one special character: "( ! " # \$ % & ' \* + , - . / : ; < = > ? @ [ \ ] ^ \_ ` { | } )"
  - The password can contain numbers from 0 to 9.
  - The password can contain alphabets A to Z and a to z.
4. Type the system password that you entered earlier in the **Confirm new password** field and click **OK**.
5. Press Y to save the changes.  
The computer restarts.

## Deleting or changing an existing system password or setup password

### Prerequisites

Ensure that the **Password Status** is Unlocked in the System Setup before attempting to delete or change the existing system password and/or setup password. You cannot delete or change an existing system password or setup password if the **Password Status** is Locked. To enter the System Setup, press F2 immediately after a power-on or reboot.

### Steps

1. To enter the **System Setup**, press **F2** immediately after a power-on or reboot.
2. In the **System BIOS** or **System Setup** screen, select **System Security** and press Enter.  
The **System Security** screen is displayed.
3. In the **System Security** screen, verify that the **Password Status** is Unlocked.
4. Select **System Password**. Update or delete the existing system password, and press Enter or Tab.
5. Select **Setup Password**. Update or delete the existing setup password, and press Enter or Tab.  
 **NOTE:** If you change the system password and/or setup password, reenter the new password when prompted. If you delete the system password and/or setup password, confirm the deletion when prompted.
6. Press Esc. A message prompts you to save the changes.
7. Press Y to save the changes and exit from **System Setup**.  
The computer restarts.

# Clearing system and setup passwords

## About this task

To clear the system or setup passwords, contact Dell technical support as described at [Contact Support](#).

 **NOTE:** For information about how to reset Windows or application passwords, see the documentation accompanying Windows or your application.

# Troubleshooting

## Handling swollen rechargeable Li-ion batteries

Like most laptops, Dell laptops use Lithium-ion batteries. One type of Lithium-ion battery is the rechargeable Li-ion battery. Rechargeable Li-ion batteries have increased in popularity in recent years and have become a standard in the electronics industry due to customer preferences for a slim form factor (especially with newer ultra-thin laptops) and long battery life. Inherent to rechargeable Li-ion battery technology is the potential for swelling of the battery cells.

A swollen battery may impact the performance of the laptop. To prevent possible further damage to the device enclosure or internal components leading to malfunction, discontinue the use of the laptop and discharge it by disconnecting the AC adapter and letting the battery drain.

Swollen batteries should not be used and must be replaced and disposed of properly. We recommend contacting Dell Support for options to replace a swollen battery under the terms of the applicable warranty or service contract, including options for replacement by a Dell authorized service technician.

The guidelines for handling and replacing rechargeable Li-ion batteries are as follows:

- Exercise caution when handling rechargeable Li-ion batteries.
- Discharge the battery before removing it from the laptop. To discharge the battery, unplug the AC adapter from the computer and operate the computer only on battery power. The battery is fully discharged when the computer no longer turns on when the power button is pressed.
- Do not crush, drop, mutilate, or penetrate the battery with foreign objects.
- Do not expose the battery to high temperatures, or disassemble battery packs and cells.
- Do not apply pressure to the surface of the battery.
- Do not bend the battery.
- Do not use tools of any type to pry on or against the battery.
- If a battery gets stuck in a device as a result of swelling, do not try to free it as puncturing, bending, or crushing a battery can be dangerous.
- Do not attempt to reassemble a damaged or swollen battery into a laptop.
- Swollen batteries that are covered under warranty should be returned to Dell in an approved shipping container (provided by Dell)—this is to comply with transportation regulations. Swollen batteries that are not covered under warranty should be disposed of at an approved recycling center. Contact Dell Support at [Dell Support Site](#) for assistance and further instructions.
- Using a non-Dell or incompatible battery may increase the risk of fire or explosion. Replace the battery only with a compatible battery purchased from Dell that is designed to work with your Dell computer. Do not use a battery from other computers with your computer. Always purchase genuine batteries from [Dell Site](#) or otherwise directly from Dell.

Rechargeable Li-ion batteries can swell for various reasons such as age, number of charge cycles, or exposure to high heat. For more information about how to improve the performance and lifespan of the laptop battery and to minimize the possibility of occurrence of the issue, search Dell laptop battery at [Dell Support Site](#).

## Dell SupportAssist Pre-boot System Performance Check diagnostics

### About this task

SupportAssist diagnostics (also known as system diagnostics) performs a complete check of your hardware. The Dell SupportAssist Pre-boot System Performance Check diagnostics is embedded within the BIOS and launched by the BIOS internally. The embedded system diagnostics provides options for particular devices or device groups allowing you to:

- Run tests automatically or in an interactive mode.
- Repeat the tests.
- Display or save test results.
- Run thorough tests to add more options and obtain details about any failed devices.

- View status messages that inform you when the tests are completed successfully.
- View error messages that inform you of problems encountered during testing.

**NOTE:** Some tests for specific devices require user interaction. Always ensure that you are present at the computer when the diagnostic tests are performed.

For more information, see [How to Run Dell Preboot Diagnostics and Hardware Tests on Your Dell Computer](#).

## Running the SupportAssist Pre-Boot System Performance Check

### Steps

1. Turn on your computer.
2. As the computer boots, press the F12 key.
3. On the boot menu screen, select **Diagnostics**.  
The diagnostic quick test begins.  
**NOTE:** For more information about running the SupportAssist Pre-Boot System Performance Check on a specific device, see [Dell Support Site](#).
4. If there are any issues, error codes are displayed.  
Note the error code and validation number and contact Dell.

## Built-in self-test (BIST)

### Motherboard Built-In Self-Test (M-BIST)

M-BIST is the system board onboard self-test diagnostics tool that improves the diagnostics accuracy of system board Embedded Controller (EC) failures.

**NOTE:** M-BIST can be manually initiated before Power On Self-Test (POST).

### How to run M-BIST

**NOTE:** Before initiating M-BIST, ensure that the computer is in a power-off state.

1. Press and hold both the **M** key and the power button to initiate M-BIST.
2. The battery-status light may exhibit two states:
  - Off: No fault was detected.
  - Amber and White: Indicates a problem with the system board.
3. If there is a failure with the system board, the battery-status light flashes one of the following error codes for 30 seconds:

**Table 54. LED error codes**

Blinking Pattern		Possible Problem
Amber	White	
2	1	CPU Failure
2	8	LCD Power Rail Failure
1	1	TPM Detection Failure
2	4	Memory/RAM failure

4. If there is no failure with the system board, the LCD cycles through the solid color screens (that are described in the LCD-BIST) for 30 seconds and then turn off.

## Logic Built-in Self-test (L-BIST)

L-BIST is an enhancement to the single LED error code diagnostics and is automatically initiated during POST. L-BIST will check the LCD power rail. If there is no power being supplied to the LCD (that is if the L-BIST circuit fails), the battery status LED flashes either an error code [2,8] or an error code [2,7].

 **NOTE:** If L-BIST fails, LCD-BIST cannot function as no power will be supplied to the LCD.

### How to invoke the L-BIST

1. Turn on your computer.
2. If the computer does not start up normally, look at the battery status LED:
  - If the battery status LED flashes an error code [2,7], the display cable may not be connected properly.
  - If the battery status LED flashes an error code [2,8], there is a failure on the LCD power rail of the system board, hence there is no power that is supplied to the LCD.
3. For cases, when a [2,7] error code is shown, check to see if the display cable is properly connected.
4. For cases when a [2,8] error code is shown, replace the system board.

## LCD Built-in Self-Test (LCD-BIST)

Dell laptops have a built-in diagnostic tool that helps you determine if the screen abnormality you are experiencing is an inherent problem with the LCD (screen) of the Dell laptop or with the video card (GPU) and computer settings.

When you notice screen abnormalities like flickering, distortion, clarity issues, fuzzy or blurry image, horizontal or vertical lines, color fade, it is always a good practice to isolate the LCD (screen) by running the LCD-BIST.

### How to invoke the LCD-BIST

1. Turn off your computer.
2. Disconnect any peripherals that are connected to the computer. Connect only the AC adapter (charger) to the computer.
3. Ensure that the LCD (screen) is clean (no dust particles on the surface of the screen).
4. Press and hold the **D** key and press the power button to enter LCD-BIST mode. Continue to hold the **D** key until the computer boots up.
5. The screen displays solid colors and changes colors on the entire screen to white, black, red, green, and blue twice.
6. Then it displays the colors white, black, and red.
7. Carefully inspect the screen for abnormalities (any lines, fuzzy color, or distortion on the screen).
8. At the end of the last solid color (red), the computer shuts down.

 **NOTE:** Dell SupportAssist Preboot diagnostics upon launch initiates an LCD-BIST first, expecting a user intervention to confirm functionality of the LCD.

## System-diagnostic lights

This section lists the system-diagnostic lights of your Dell Pro 14 PC14250.

The following table shows different Service LED blinking patterns and associated problems. The diagnostic light codes consist of a two-digit number, and the digits are separated by a comma. The number stands for a blinking pattern; the first digit shows the number of blinks in amber color, and the second digit shows the number of blinks in white color. The Service LED blinks in the following manner:

- The Service LED blinks the number of times equal to the value of the first digit and turns off with a short pause.
- After that, the Service LED blinks the number of times equal to the value of the second digit.
- The Service LED turns off again with a longer pause.
- After the second pause, the blinking pattern will be repeated.

**Table 55. Diagnostic light codes**

<b>Diagnostic light codes (Amber, White)</b>	<b>Problem description</b>
<b>1,1</b>	TPM Detection Failure
<b>1,2</b>	Unrecoverable SPI Flash Failure
<b>1,5</b>	EC unable to program i-Fuse
<b>1,6</b>	Generic catch-all for ungraceful EC code flow errors
<b>1,7</b>	Non-RPMC Flash on Boot Guard fused system
<b>1,8</b>	Chipset "Catastrophic Error" signal has tripped
<b>2,1</b>	CPU configuration or CPU failure
<b>2,2</b>	System board: BIOS or Read-Only Memory (ROM) failure
<b>2,3</b>	No memory or Random-Access Memory (RAM) detected
<b>2,4</b>	Memory or Random-Access Memory (RAM) failure
<b>2,5</b>	Invalid memory installed
<b>2,6</b>	System board/Chipset Error
<b>2,7</b>	LCD failure SBIOS message
<b>2,8</b>	Display power-rail failure on the system board
<b>3,1</b>	RTC power failure
<b>3,2</b>	PCI of Video card/chip failure
<b>3,3</b>	Recovery image not found
<b>3,4</b>	Recovery image found but invalid
<b>3,5</b>	EC power-rail error
<b>3,6</b>	Flash corruption detected by SBIOS
<b>3,7</b>	Timeout waiting on ME to reply to HECI message
<b>4,1</b>	Memory DIMM power rail failure
<b>4,4</b>	LCD Power Rail Failure

## Recovering the operating system

When your computer is unable to boot to the operating system even after repeated attempts, it automatically starts Dell SupportAssist OS Recovery.

Dell SupportAssist OS Recovery is a stand-alone tool that is preinstalled on Dell computers running the Windows operating system. It consists of tools to diagnose and troubleshoot issues that may occur before your computer boots to the operating system. It enables you to diagnose hardware issues, repair your computer, back up your files, and restore your computer to its factory state.

You can also download it from the Dell Support website to troubleshoot and fix your computer when it fails to boot into the primary operating system due to software or hardware failures.

For more information about the Dell SupportAssist OS Recovery, see *Dell SupportAssist OS Recovery User's Guide* at [Serviceability Tools at the Dell Support Site](#). Click **SupportAssist** and then click **SupportAssist OS Recovery**.

**i** **NOTE:** Windows 11 IoT Enterprise LTSC 2024 and Dell ThinOS 10 do not support Dell SupportAssist. For more information about recovering ThinOS 10, see [Recovery mode using R-Key](#).

## Real-Time Clock (RTC Reset)

The Real-Time Clock (RTC) reset function enables you or the service technician to recover Dell computers from No POST/No Power/No Boot situations.

Start the RTC reset with the computer powered off and connected to AC power. Press and hold the power button for thirty seconds. The computer RTC Reset occurs after you release the power button.

## Backup media and recovery options

It is recommended to create a recovery drive to troubleshoot and fix problems that may occur with Windows. Dell provides multiple options for recovering the Windows operating system on your Dell computer. For more information, see [Dell Windows Backup Media and Recovery Options](#).

## Network power cycle

### About this task

If your computer is unable to access the Internet due to network connectivity issues, reset your network devices by performing the following steps:

### Steps

1. Turn off the computer.
2. Turn off the modem.  
**i** **NOTE:** Some Internet service providers (ISPs) provide a modem and router combo device.
3. Turn off the wireless router.
4. Wait for 30 seconds.
5. Turn on the wireless router.
6. Turn on the modem.
7. Turn on the computer.

## Drain flea power (perform hard reset)

### About this task

Flea power is the residual static electricity that remains in the computer even after it has been powered off and the battery is removed.

For your safety, and to protect the sensitive electronic components in your computer, you must drain residual flea power before removing or replacing any components in your computer.

Draining flea power, also known as a performing a "hard reset," is also a common troubleshooting step if your computer does not turn on or boot into the operating system.

Perform the following steps to drain the flea power:

### Steps

1. Turn off the computer.
2. Disconnect the power adapter from the computer.

3. Remove the [base cover](#).
4. Remove the [battery](#).
5. Press and hold the power button for 20 seconds to drain the flea power.
6. Install the [battery](#).
7. Install the [base cover](#).
8. Connect the power adapter to the computer.
9. Turn on the computer.

 **NOTE:** For more information about performing a hard reset, go to [Dell Support Site](#). On the menu bar at the top of the Support page, select Support > Support Library. In the Search field on the Support Library page, type the keyword, topic, or model number, and then click or tap the search icon to view the related articles.

# Getting help and contacting Dell

## Self-help resources

You can get information and help on Dell products and services using these self-help resources:

**Table 56. Self-help resources**

Self-help resources	Resource location
Information about Dell products and services	<a href="#">Dell Site</a>
Contact Support	In Windows search, type <code>Contact Support</code> , and press Enter.
Online help for operating system	<a href="#">Windows Support Site</a> <a href="#">Linux Support Site</a>
Access top solutions, diagnostics, drivers and downloads, and learn more about your computer through videos, manuals, and documents.	Your Dell computer is uniquely identified using a Service Tag or Express Service Code. To view relevant support resources for your Dell computer, enter the Service Tag or Express Service Code at <a href="#">Dell Support Site</a> .  For more information about how to find the Service Tag for your computer, see <a href="#">Locate the Service Tag on your computer</a> .
Dell knowledge base articles	<ol style="list-style-type: none"> <li>1. Go to <a href="#">Dell Support Site</a>.</li> <li>2. On the menu bar at the top of the Support page, select <b>Support &gt; Support Library</b>.</li> <li>3. In the Search field on the Support Library page, type the keyword, topic, or model number, and then click or tap the search icon to view the related articles.</li> </ol>

## Contacting Dell

To contact Dell for sales, technical support, or customer service issues, see [Dell Support Site](#).

 **NOTE:** Availability of the services may vary depending on the country or region, and product.

 **NOTE:** If you do not have an active Internet connection, you can find contact information in your purchase invoice, packing slip, bill, or Dell product catalog.

## Revision history

Tracks all updates that are made to the document. It typically includes the date of change, version number, and a brief description of the modification. This log helps maintain transparency, accountability, and a clear timeline of progress.

**Table 57. Revision history**

Revision	Date	Description
A05	April 2026	<ul style="list-style-type: none"> <li>• Updated audio specifications.</li> <li>• Updated storage specifications to include a new 512 GB SED-ready option.</li> <li>• Updated storage specifications to include a new 1 TB TLC option.</li> <li>• Updated display specifications to add new display options.</li> <li>• Updated BIOS setup options.</li> <li>• Updated system board connector callouts.</li> </ul>
A04	October 2025	<ul style="list-style-type: none"> <li>• Updated power adapter requirements specifications.</li> <li>• Updated battery specifications.</li> </ul>
A03	August 2025	Updated smart card reader specifications
A02	July 2025	<ul style="list-style-type: none"> <li>• Updated processor specifications (added two new processor options).</li> <li>• Updated Ethernet specifications.</li> <li>• Updated wireless module specification (added BE200).</li> <li>• Added specification for smart Card Reader.</li> </ul>
A00	March 2025	Original publish date.