

Always there to help you

Register your product and get support at
www.philips.com/welcome

SHD9200



User manual

PHILIPS

Contents

1	Important	2
	Electric-, Magnetic- and Electromagnetic Fields (EMF)	2
	General information	2
	Disposal of your old product	3
	Notice for the European Union	3

2	What's in the box (Fig.A)	4
----------	----------------------------------	----------

3	Get Started	5
----------	--------------------	----------

4	LED indications	7
----------	------------------------	----------

5	Sound indications	8
----------	--------------------------	----------

6	Product information	9
----------	----------------------------	----------

7	Adaptor specification	10
----------	------------------------------	-----------

8	Frequently asked questions (FAQ)	11
----------	---	-----------

1 Important

Hearing safety



! Caution

- To prevent possible hearing damage, do not listen at high volume levels for long periods. Set the volume to a safe level. The louder the volume, the shorter is the safe listening time.

Be sure to observe the following guidelines when using your headphones.

- Listen at reasonable volumes for reasonable periods of time.
- Be careful not to adjust the volume continuously upwards as your hearing adapts.
- Do not turn up the volume so high that you can't hear what's around you.
- You should use caution or temporarily discontinue use in potentially hazardous situations.
- Excessive sound pressure from earphones and headphones can cause hearing loss.

Electric-, Magnetic- and Electromagnetic Fields (EMF)

1. Royal Philips Electronics manufactures and sells many products targeted at consumers, which, like any electronic apparatus, in general have the ability to emit and receive electromagnetic signals.

2. One of Philips' leading Business Principles is to take all necessary health and safety measures for our products, to comply with all applicable legal requirements and to stay well within

the EMF standards applicable at the time of producing products.

3. Philips is committed to develop, produce and market products that cause no adverse health effects.

4. Philips confirms that if its products are handled properly for their intended use, they are safe to use according to scientific evidence available today.

5. Philips plays an active role in the development of international EMF and safety standards, enabling Philips to anticipate further developments in standardization for early integration in its products.

General information

- **To prevent fire or shock hazard:** Always keep this product dry. Do not expose it to excessive heat by heating equipment or direct sunlight.
- No naked flame sources, such as lighted candles, should be placed on the apparatus.
- Do not allow your headset to be submerged in water.
- **To clean the product:** Use a slightly dampened chamois cloth. Do not use cleansing agents containing alcohol, spirits, ammonia or abrasives as they may harm the product.
- Do not disassemble the product.
- Transmission range: 100 meters, depending on ambient conditions.
- Do not operate or store the product in a place where temperature is below 0°C (32°F) or above 40°C (104°F) as this may shorten the battery life.
- This product shall not be exposed to dripping or splashing.
- The mains plug of AC/DC adaptor is used as the disconnect device, the disconnect device shall be readily operable.

- Only use rechargeable NiMH batteries (capacity over 700mAh) with your headphones.
- Other types of rechargeable or alkaline batteries cannot be charged with this system.
- AAA alkaline batteries can be used to operate the headphones.
- Batteries (battery pack or batteries installed) shall not be exposed to excessive heat such as sunshine, fire or the like.

Disposal of your old product

Your product is designed and manufactured with high quality materials and components, which can be recycled and reused.



When this crossed-out wheeled bin symbol is attached to a product it means that the product is covered by the European Directive 2002/96/EC.

Please inform yourself about the local separate collection system for electrical and electronic products.

Please act according to your local rules and do not dispose of your old products with your normal household waste. Correct disposal of your old product helps to prevent potential negative consequences for the environment and human health.

Your product contains batteries covered by the European Directive 2006/66/EC, which cannot be disposed with normal household waste.

Please inform yourself about the local rules on separate collection of batteries because correct disposal helps to prevent negative consequences for the environmental and human health.

Attention should be drawn to the environmental aspects of battery disposal.

Environmental information

All unnecessary packaging has been omitted. We have tried to make the packaging easy to separate into three materials: cardboard (box), polystyrene foam (buffer) and polyethylene (bags, protective foam sheet.)

Your system consists of materials which can be recycled and reused if disassembled by a specialized company. Please observe the local regulations regarding the disposal of packaging materials, exhausted batteries and old equipment.

Notice for the European Union



Hereby, Philips Consumer Lifestyle, BU Communications, Headphones & Accessories, declares that this Philips digital wireless headset SHD9200 is in compliance with the essential requirements and other relevant provisions of Directive 1999/5/EC. This product has been designed, tested and manufactured according to the European R&TTE Directive 1999/5/EC.

2 What's in the box (Fig. A)

1) Headphones	2) Docking station
3) AC/DC adaptor 5V 300mA	4) RCA to RCA cable
5) 2 × AAA rechargeable NiMH batteries	6) Quick start guide

3 Get Started

Note

- Before using the headphones for the first time, charge the supplied batteries for at least 8 hours. Only rechargeable NiMH batteries can be charged. Use the batteries (capacity over 700mAh) to ensure the 20 hours' operating time from fully charged.
- AAA alkaline batteries can be used to operate the headphones.
- Use Philips power adaptor only.
- If no audio input for over 10 minutes, the transmitter automatically turns to standby.
- The docking station does not transmit audio signal during charge.
- Digital input only supports PCM (pulse code modulation).

- 1 Install/Replace the supplied batteries (Fig.B).
- 2 Power on the transmitter (Fig.C).
- 3 Power off the headphones and charge the headphones (Fig.D).
- 4 Press **INPUT** to select **ANALOGUE** or **DIGITAL** mode (Fig.E).
 - In **ANALOGUE** mode, connect the audio device to **LINE IN** sockets, then adjust **ATT** (Attenuation of audio input signal) (Fig.F).
 - For portable CD player, MP3 player or other devices with 3.5mm triport socket output, connect with RCA to RCA cable (provided) and RCA to 3.5mm plug adaptor (not provided), then switch **ATT** to **0dB**.
 - For Hi-Fi, TV, DVD player or other devices with RCA socket output, connect with RCA to RCA cable (provided), then switch **ATT** to **-8dB**.
 - In **DIGITAL** mode, connect the digital audio device to **DIGITAL IN COAXIAL** socket with coaxial cable (not provided) (Fig.G).

- 1 Press and hold **⏻** on the right headphone for 2 seconds to power on the headphones (Fig.H).
- 2 Touch **+/-** on the right headphone to adjust the volume (Fig.I).
- 3 Press the **3D SOUND** button on the right headphone to activate/deactivate the 3D sound function (Fig.I).
 - ↳ The LED on the transmitter turns on.

Tip

- You can also adjust the volume on the audio device.

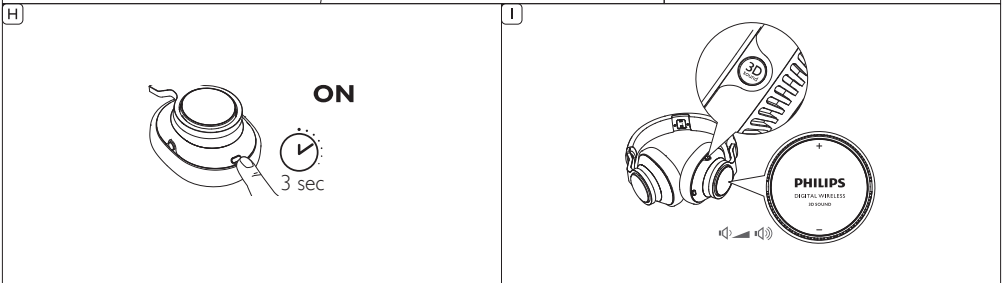
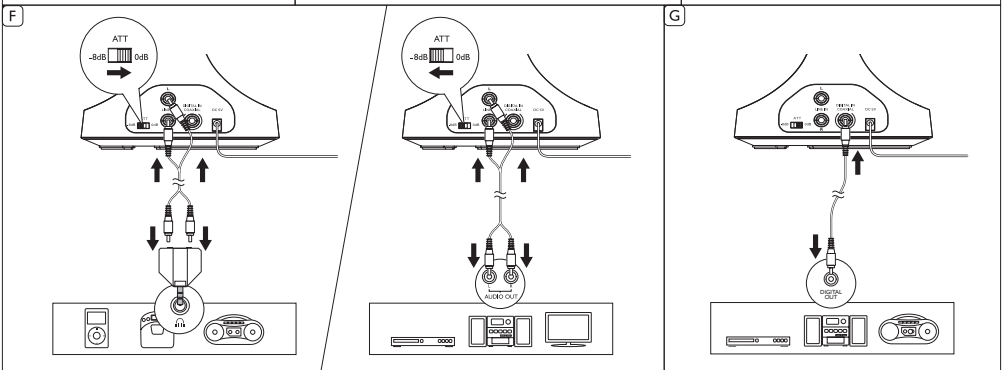
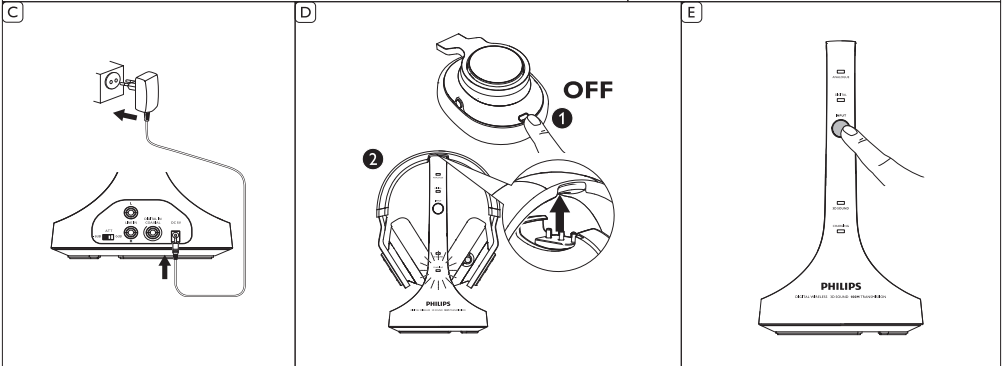
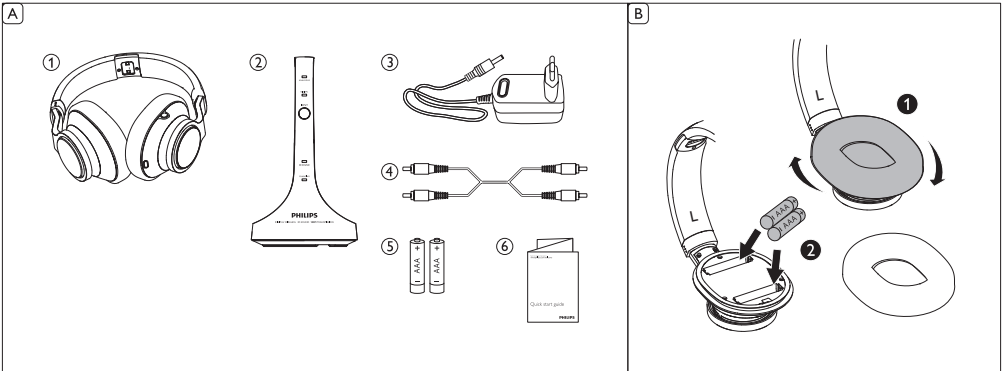

4 LED indications

Situation	Transmitter		Headphones	
	Analogue/Digital	Charging	3D sound	
LED	White	Red	White	Red
Searching	Fast blinking	---	---	Fast blinking
Connection established	Blinking	---	---	Blinking
Standby	Off	Off	---	---
Low battery	---	---	---	Fast blinking
Charging	Off	Blinking	---	---
Fully charged	---	On	---	---
Non NiMH batteries	---	Off	---	---
3D sound activated	---	---	On	---
3D sound deactivated	---	---	Off	---

5 Sound indications

Situation	Sound signal
Low battery	One "Beep" per 10 seconds
Turn the volume to maximum/minimum level	Alert tone "Beep"

6 Product information





Transmitter

System	Radio Frequency (RF)
Modulation	MSK digital
Carrier frequency	2,400 - 2,483.5 MHz
Channels	15 (auto-switching)
Radiated output power	10 mW
Effective transmission range	Approx. 100 meters (depending on ambient conditions)
Input Level	800 mV (0 dB); 2 V (-8 dB)
Power requirements	DC 5 V; 300 mA (from the supplied AC power adaptor)

Headphones

Playback frequency range	17 - 24,000 Hz
Signal/Noise ratio	≥ 89 dB Nominal
Distortion	< 0.5% THD (Total Harmonic Distortion)
Channel Separation	≥ 60 dB
Impedance	32 ohm
Power Requirements	2 × 700 mAh rechargeable NiMH batteries (supplied) or commercially available (AAA) dry batteries
Operating time	~ up to 20 hours (actual result may vary)

7 Adaptor specification

Region	Adaptor type number	Input voltage	Output voltage	Input frequency
Europe (except U.K.)	YLS0051A-E050030	100-240V~	5V  , 300mA	50/60Hz
	S003IV0500030	100-240V~	5V  , 300mA	50/60Hz
U.K./H.K.	YLS0051A-U050030	100-240V~	5V  , 300mA	50/60Hz
	S003IB0500030	100-240V~	5V  , 300mA	50/60Hz

8 Frequently asked questions (FAQ)

1. Headphones fail to charge.

Possible cause	Solution
No battery installed or wrongly installed.	Install or replace batteries properly (Fig.B).
No power supply to transmitter.	Make sure that the docking station is connected to the local mains power (Fig.C).
Headphones wrongly placed into the charging dock.	Dock the headphones properly and make sure that the CHARGING indicator is on (Fig.D).

2. No sound or distorted sound.

Possible cause	Solution
Not set up properly or completed.	Make sure that the audio cable is connected to AUDIO OUT on the audio device (Fig.E).
Low battery.	Recharge the headphones (Fig.D).
Audio device is off.	Turn on the audio device.
Volume of Analog/Digital audio input is too low/high.	Adjust the volume to a higher/lower and non-distorted level.
Receiver is too far away from transmitter.	Make sure that you use the product within effective range.

For further product support, please visit www.philips.com/support.



Specifications are subject to change without notice
© 2013 Koninklijke Philips Electronics N.V.
All rights reserved.

SHD9200_UM_10_V1.0
WK1303

CE 0168

