



*LBP7100Cn / LBP7110Cw*

<a href="#">Before You Start</a>	8
<a href="#">Legal Notices</a>	9
<a href="#">Legal Limitations on the Usage of Your Product and the Use of Images</a>	11
<a href="#">Using the e-Manual</a>	12
<a href="#">How to Use the e-Manual</a>	13
<a href="#">Operating Environment</a>	14
<a href="#">Installing the e-Manual</a>	15
<a href="#">Uninstalling the e-Manual</a>	19
<a href="#">Screen Layout of the e-Manual</a>	22
<a href="#">Top Page</a>	23
<a href="#">Topic Page</a>	25
<a href="#">Site Map</a>	26
<a href="#">Search Method</a>	27
<a href="#">Viewing the e-Manual</a>	28
<a href="#">Disclaimers</a>	30
<a href="#">Copyright</a>	31
<a href="#">Trademarks</a>	32
<a href="#">Important Safety Instructions</a>	33
<a href="#">Important Safety Instructions</a>	34
<a href="#">Installation</a>	35
<a href="#">Power Supply</a>	36
<a href="#">Handling</a>	37
<a href="#">Maintenance and Inspections</a>	39
<a href="#">Consumables</a>	41
<a href="#">Wireless LAN Regulatory Information (LBP7110Cw Only)</a>	42
<a href="#">About This Printer</a>	46
<a href="#">Printer Specifications</a>	47
<a href="#">System Requirements for Printing</a>	50
<a href="#">Names and Dimensions of Each Part</a>	51
<a href="#">Control Panel</a>	53
<a href="#">Printer Status Window</a>	56
<a href="#">Introduction of the Utilities</a>	59
<a href="#">Energy-saving Mode</a>	60
<a href="#">Sleep Mode</a>	61
<a href="#">Auto Shutdown</a>	62
<a href="#">Cautions for Handling the Printer</a>	63
<a href="#">Consumables</a>	64
<a href="#">Checking the Consumables Status</a>	65
<a href="#">Maintenance</a>	66
<a href="#">Toner Cartridge Replacement</a>	67
<a href="#">Attention (Toner Cartridge)</a>	69
<a href="#">Replacing the Toner Cartridge</a>	71
<a href="#">Storing Toner Cartridges</a>	75
<a href="#">Moving the Printer</a>	76
<a href="#">Cleaning the Printer</a>	78
<a href="#">Adjusting Colors and Correcting Color Mismatches (Calibration/Color Mismatch Correction)</a>	79
<a href="#">Adjusting Color (Calibration)</a>	80
<a href="#">Correcting Color Mismatches (Color Mismatch Correction)</a>	82
<a href="#">Auto Image Quality Adjustment Settings</a>	84

<a href="#">Cleaning the Inside of the Printer</a>	86
<a href="#">Cleaning the Fixing Roller of the Printer</a>	87
<a href="#">Cleaning the Transfer Belt of the Printer</a>	89
<a href="#">Cleaning the Outside of the Printer</a>	90
<a href="#">Attention (Cleaning)</a>	92
<a href="#">Location of the Serial Number</a>	93
<a href="#">Printer Installation</a>	94
<a href="#">Attention (Printer Installation)</a>	95
<a href="#">Confirming the Supplied Accessories and Checking the Installation Location</a>	97
<a href="#">Removing the Packing Materials</a>	99
<a href="#">Installing the Printer</a>	103
<a href="#">Driver Installation</a>	105
<a href="#">Installing the Printer Driver</a>	106
<a href="#">Easy Installation</a>	108
<a href="#">Connecting the Printer and Computer</a>	114
<a href="#">Attention (Wired LAN Connection)</a>	117
<a href="#">Attention (Wireless LAN Connection) (LBP7110Cw Only)</a>	118
<a href="#">[Select Printers to Install] Screen</a>	120
<a href="#">[Printer Information] Screen</a>	122
<a href="#">After Installation</a>	125
<a href="#">Uninstalling the Printer Driver</a>	127
<a href="#">Basic Printer Operations</a>	133
<a href="#">Usable Paper</a>	134
<a href="#">Precautions for Paper</a>	137
<a href="#">Printable Area</a>	139
<a href="#">Paper Loading and Output</a>	140
<a href="#">Loading Paper</a>	141
<a href="#">Attention (Paper Loading)</a>	144
<a href="#">Registering the Paper Size and Type</a>	145
<a href="#">Basic Printing Procedure</a>	147
<a href="#">Attention (Basic Printing)</a>	151
<a href="#">How to Use Help</a>	152
<a href="#">Canceling a Job</a>	154
<a href="#">Canceling a Job Being Printed or Waiting to Be Printed from the Computer</a>	155
<a href="#">Canceling a Print Job Being Printed Using the Cancel Job Key</a>	157
<a href="#">Checking the Printer Status</a>	158
<a href="#">Printing on Various Types of Paper</a>	159
<a href="#">Printing on Plain Paper, Heavy Paper, or Index Card</a>	160
<a href="#">Printing on Transparencies (Black and White Printing Only)</a>	161
<a href="#">Printing on Labels</a>	162
<a href="#">Printing on Envelopes</a>	163
<a href="#">Printing on Coated Paper</a>	165
<a href="#">Printing on Custom Size Paper</a>	166
<a href="#">Registering a Custom Paper Size</a>	167
<a href="#">Paper Loading Orientation</a>	169
<a href="#">Useful Printing Functions</a>	170
<a href="#">Displaying the Setting Screen</a>	171
<a href="#">Scaling Print Output</a>	173
<a href="#">Layout Printing (N-page Print)</a>	175

<a href="#">Printing an Image Larger than A4 (Poster Printing)</a>	177
<a href="#">Adding a Watermark to a Document to Be Printed (Watermark Printing)</a>	179
<a href="#">Adding, Editing, or Deleting a Watermark</a>	181
<a href="#">Printing Borders, the Printing Date, and so on</a>	184
<a href="#">Printing a Color Document in Black and White</a>	186
<a href="#">Combining Data before Printing</a>	188
<a href="#">Changing the Output Method According to the Print Data or Number of Copies</a>	192
<a href="#">Printing with a Gutter</a>	193
<a href="#">Selecting the Paper Output Method</a>	195
<a href="#">Printing with the Page 180 Degrees Rotated</a>	197
<a href="#">Adjusting the Image Quality or Colors</a>	199
<a href="#">Performing Printing Appropriate for Particular Print Data</a>	200
<a href="#">Adjusting the Toner Density</a>	201
<a href="#">Adjusting the Toner Density of Each Color for Each Density Range</a>	203
<a href="#">Printing with Brightness and Contrast Adjusted</a>	205
<a href="#">Adjusting the Color</a>	207
<a href="#">Matching the Color with the Screen</a>	209
<a href="#">Registering the Printing Preferences</a>	212
<a href="#">Changing the Default Values for Printing Preferences</a>	213
<a href="#">Saving Frequently Used Printing Preferences (Adding/Editing/Deleting a "Profile")</a>	215
<a href="#">Selecting a "Profile"</a>	219
<a href="#">Configuring the Network Settings (Sharing the Printer)</a>	220
<a href="#">Checking Your Printing Environment</a>	221
<a href="#">If You Use the Printer by Direct Connection</a>	222
<a href="#">Basic Network Settings</a>	224
<a href="#">Switching Between Wireless LAN and Wired LAN for the Connection (LBP7110Cw Only)</a>	225
<a href="#">Specifying the Connection Settings</a>	226
<a href="#">Setting a Port and Installing the Printer Driver</a>	227
<a href="#">Changing the Network Settings for the Printer</a>	240
<a href="#">Configuring the Protocol Settings</a>	241
<a href="#">Attention (Protocol Settings)</a>	243
<a href="#">IPv4 Settings</a>	245
<a href="#">IPv6 Settings</a>	250
<a href="#">Other Protocol Settings</a>	256
<a href="#">Specifying a Dedicated Port</a>	264
<a href="#">Specifying the Waiting Time Until Connected to the Network</a>	267
<a href="#">Specifying the Wired LAN Communication Mode and Transmission Speed</a>	270
<a href="#">Checking the IP Address of the Printer</a>	273
<a href="#">Checking the MAC Address of the Printer</a>	274
<a href="#">Checking the Wireless LAN Information (LBP7110Cw Only)</a>	275
<a href="#">Configuring and Changing the Port</a>	278
<a href="#">Changing the Port Configuration</a>	284
<a href="#">If You Use the Printer in the Print Server Environment</a>	287
<a href="#">Configuring the Print Server</a>	289
<a href="#">Checking the Settings of Your Network</a>	294
<a href="#">Installation on Clients</a>	296
<a href="#">Installing from the Printer Folder</a>	297
<a href="#">Installing from [Windows Explorer]</a>	304
<a href="#">Managing the Printer</a>	305

<a href="#">Software That Can Be Used for Managing the Printer</a>	306
<a href="#">Remote UI</a>	307
<a href="#">Starting the Remote UI</a>	308
<a href="#">Attention (Remote UI)</a>	311
<a href="#">Screen Layout of the Remote UI</a>	312
<a href="#">Displaying or Changing the Support Link</a>	315
<a href="#">Changing the Display Language of the Remote UI</a>	318
<a href="#">MF/LBP Network Setup Tool</a>	320
<a href="#">Directly Starting the MF/LBP Network Setup Tool</a>	322
<a href="#">Managing Print Jobs</a>	324
<a href="#">Checking the Printer Settings</a>	327
<a href="#">Printing the "User Data List"</a>	329
<a href="#">Specifying the System Manager Information</a>	330
<a href="#">Specifying the Device Name and Installation Location</a>	333
<a href="#">Specifying the Time Zone and Daylight Saving Time Settings of the Printer</a>	335
<a href="#">Initializing the System Settings</a>	337
<a href="#">Initializing Using the Remote UI</a>	338
<a href="#">Initializing Using the Reset Button</a>	341
<a href="#">Security Settings</a>	342
<a href="#">Restricting the Users Who Can Print and Specify Settings</a>	343
<a href="#">Monitoring/Controlling Devices by SNMP (SNMP Settings)</a>	354
<a href="#">Specifying Keys and Certificates/CA Certificates</a>	360
<a href="#">Creating Keys and Certificates</a>	361
<a href="#">Installing Keys and Certificates/CA Certificates</a>	365
<a href="#">Checking Keys and Certificates/CA Certificates</a>	373
<a href="#">Deleting Keys and Certificates/CA Certificates</a>	379
<a href="#">Initializing Keys and Certificates/CA Certificates</a>	383
<a href="#">Setting the SSL Encrypted Communication Function</a>	385
<a href="#">Attention (SSL Encrypted Communication)</a>	390
<a href="#">Setting IEEE 802.1X Authentication</a>	391
<a href="#">Attention (IEEE 802.1X Authentication)</a>	402
<a href="#">Troubleshooting</a>	403
<a href="#">Printing Cannot Be Performed</a>	404
<a href="#">Printing Cannot Be Performed (USB Connection)</a>	405
<a href="#">Printing Cannot Be Performed (Wired LAN Connection)</a>	408
<a href="#">Printing Cannot Be Performed (Wireless LAN Connection) (LBP7110Cw Only)</a>	413
<a href="#">Printing Cannot Be Performed (via the Print Server)</a>	418
<a href="#">The Print Server for Connection Cannot Be Found</a>	421
<a href="#">The Shared Printer Cannot Be Accessed</a>	422
<a href="#">The Printer Pauses during Printing, and then Printing Repeatedly Starts and Stops</a>	423
<a href="#">You Cannot Turn the Printer ON</a>	424
<a href="#">All the Indicators on the Network Interface Are Off</a>	425
<a href="#">You Cannot Install the Printer Driver</a>	426
<a href="#">The Printer Is Not Recognized Automatically</a>	427
<a href="#">The Printer Cannot Be Searched for</a>	428
<a href="#">You Cannot Uninstall the Printer Driver</a>	430
<a href="#">Starting the Uninstaller from the CD-ROM</a>	431
<a href="#">Uninstalling the USB Class Driver</a>	434
<a href="#">The Printer Driver Settings Cannot Be Changed</a>	437

<a href="#">"Profiles" Cannot Be Selected or Edited</a>	439
<a href="#">Paper Jams</a>	441
<a href="#">Attention (Paper Jams)</a>	442
<a href="#">Clearing Paper Jams (Paper Drawer)</a>	443
<a href="#">Clearing Paper Jams (Output Area)</a>	445
<a href="#">Clearing Paper Jams (Inside the Rear Cover)</a>	446
<a href="#">Indicators on the Printer Are On/Blinking</a>	447
<a href="#">A Message Appears in the Printer Status Window</a>	449
<a href="#">When &lt;Service Error&gt; Is Displayed</a>	454
<a href="#">Poor Printout Results</a>	456
<a href="#">Paper Curls</a>	458
<a href="#">Paper Creases</a>	460
<a href="#">White Streaks (Lines) Appear</a>	462
<a href="#">Streaks (lines) Appear in Gradated Portions</a>	463
<a href="#">Thin Lateral Streaks (Lateral Lines) Appear</a>	464
<a href="#">Printing Is Uneven</a>	465
<a href="#">Printed Pages Have White Specks</a>	466
<a href="#">Colors Are Uneven or Not Printed Smoothly</a>	467
<a href="#">The Toner Does Not Fix onto the Paper Well</a>	469
<a href="#">The Printed Paper Has Smudge Marks</a>	470
<a href="#">Smudge Marks of Spattering Toner Appear around the Text or Patterns</a>	471
<a href="#">The Back of the Printed Paper Has Smudge Marks</a>	472
<a href="#">The Overall Print Result Is Dark</a>	473
<a href="#">Residual Images Appear on Non-printed Areas</a>	474
<a href="#">White Dust Is Attached to the Printed Transparencies</a>	475
<a href="#">The Overall Print Result Is Faint</a>	476
<a href="#">Printing Is Faded</a>	477
<a href="#">Colored Text Appears Blurred</a>	478
<a href="#">Data Is Not Printed in the Correct Color (Specified Color) Due to Color Mismatches</a>	479
<a href="#">Thin Lines or Fill Patterns Are Not Printed with the Specified Colors or Do Not Appear At All</a>	481
<a href="#">Shaded Patterns Are Not Printed in the Correct Color (Specified Color)</a>	482
<a href="#">Photographs and so on Are Printed in Different Colors from Those Displayed on the Monitor</a>	483
<a href="#">Fill Patterns and Borders Are Not Printed in the Correct Color (Specified Color) Even When the Same Color Is Specified for Them</a>	484
<a href="#">Square Areas That Cannot Be Seen on the Display Appear around Lines or Text and Are Printed in a Different Color from the Other Areas</a>	485
<a href="#">Adjusting the Color and so on for Printing</a>	486
<a href="#">The Printing Position Is Skewed</a>	487
<a href="#">A Portion of the Page Is Not Printed (Printed Data Lies Outside Paper)</a>	488
<a href="#">Data Is Reduced and Printed</a>	490
<a href="#">The Next Page Is Printed from Halfway across the Previous Page</a>	491
<a href="#">Blank Paper Is Output (Nothing Is Printed on the Paper)</a>	492
<a href="#">The Overall Surface of the Paper Is Printed in a Particular Color</a>	493
<a href="#">The Flap of the Printed Envelope Sticks</a>	494
<a href="#">Multiple Sheets of Paper Are Fed at a Time</a>	495
<a href="#">Printed Bar Codes Cannot Be Scanned</a>	496
<a href="#">If You Cannot Solve a Problem</a>	497
<a href="#">Appendix</a>	498
<a href="#">Points to Make Full Use of the Printer</a>	499
<a href="#">Basic Operations/Various Information for Windows</a>	501

[For Windows 8/Server 2012 Users](#)

512

[For Macintosh Users](#)

513

[Office Locations](#)

514

## Before You Start

---

[Legal Notices](#)

---

[Legal Limitations on the Usage of Your Product and the Use of Images](#)

---

[Using the e-Manual](#)

---



## Legal Notices

### Product Name

Safety regulations require the product's name to be registered.

In some regions where this product is sold, the following name(s) in parentheses ( ) may be registered instead.

LBP7100Cn/LBP7110Cw (F163600)

### EMC requirements of EC Directive

This equipment conforms with the essential EMC requirements of EC Directive. We declare that this product conforms with the EMC requirements of EC Directive at nominal mains input 230 V, 50 Hz although the rated input of the product is 220 to 240 V, 50/60 Hz. Use of shielded cable is necessary to comply with the technical EMC requirements of EC Directive.

### Laser Safety

This product is certified as a Class 1 laser product under IEC60825-1:2007 and EN60825-1:2007. This means that the product does not produce hazardous laser radiation.

Since radiation emitted inside the product is completely confined within protective housings and external covers, the laser beam cannot escape from the machine during any phase of user operation. Do not remove protective housings or external covers, except as directed by the equipment's manuals.

The label shown below is attached to the laser scanner unit inside the machine.

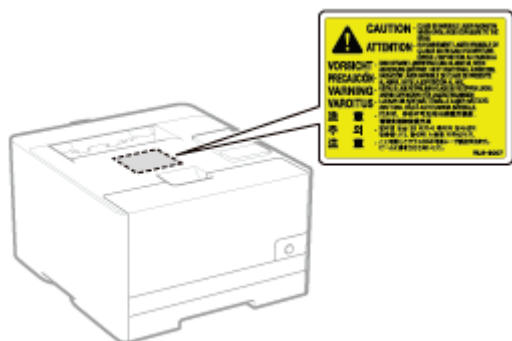

CLASS 1 LASER PRODUCT

LASER KLASSE 1

APPAREIL À LASER DE CLASSE 1

APPARECCHIO LASER DI CLASSE 1

PRODUCTO LÁSER DE CLASE 1

APARELHO A LASER DE CLASSE 1

LUOKAN 1 LASER-TUOTE

LASERPRODUKT KLASSE 1

### CAUTION

Use of controls, adjustments, or performance of procedures other than those specified in this manual may result in hazardous radiation exposure.

### International ENERGY STAR Program



As an ENERGY STAR® Partner, Canon Inc. has determined that this product meets the ENERGY STAR Program for energy efficiency.

The International ENERGY STAR Office Equipment Program is an international program that promotes energy saving through the use of computers and other office equipment.

The program backs the development and dissemination of products with functions that effectively reduce energy consumption. It is an open system in which business proprietors can participate voluntarily.

The targeted products are office equipment, such as computers, displays, printers, facsimiles, and copiers. The standards and logos are uniform among participating nations.

## WEEE Directive



Only for European Union and EEA (Norway, Iceland and Liechtenstein)

This symbol indicates that this product is not to be disposed of with your household waste, according to the WEEE Directive (2012/19/EU) and national legislation. This product should be handed over to a designated collection point, e.g., on an authorized one-for-one basis when you buy a new similar product or to an authorized collection site for recycling waste electrical and electronic equipment (EEE). Improper handling of this type of waste could have a possible negative impact on the environment and human health due to potentially hazardous substances that are generally associated with EEE. At the same time, your cooperation in the correct disposal of this product will contribute to the effective usage of natural resources. For more information about where you can drop off your waste equipment for recycling, please contact your local city office, waste authority, approved WEEE scheme or your household waste disposal service. For more information regarding return and recycling of WEEE products, please visit

**[www.canon-europe.com/weee](http://www.canon-europe.com/weee)**.

## IPv6 Ready Logo



The protocol stack included in this machine has obtained the IPv6 Ready Logo Phase-1 established by the IPv6 Forum.

## Legal Limitations on the Usage of Your Product and the Use of Images

---

Using your product to scan, print or otherwise reproduce certain documents, and the use of such images as scanned, printed or otherwise reproduced by your product, may be prohibited by law and may result in criminal and/or civil liability. A non-exhaustive list of these documents is set forth below. This list is intended to be a guide only. If you are uncertain about the legality of using your product to scan, print or otherwise reproduce any particular document, and/or of the use of the images scanned, printed or otherwise reproduced, you should consult in advance with your legal advisor for guidance.

- Paper Money
  - Travelers Checks
  - Money Orders
  - Food Stamps
  - Certificates of Deposit
  - Passports
  - Postage Stamps (canceled or uncanceled)
  - Immigration Papers
  - Identifying Badges or Insignias
  - Internal Revenue Stamps (canceled or uncanceled)
  - Selective Service or Draft Papers
  - Bonds or Other Certificates of Indebtedness
  - Checks or Drafts Issued by Governmental Agencies
  - Stock Certificates
  - Motor Vehicle Licenses and Certificates of Title
  - Copyrighted Works/Works of Art without Permission of Copyright Owner
-

# Using the e-Manual

---

Even if you do not have the supplied CD-ROM at hand, you can view the e-Manual any time if you install it on your computer beforehand.

For the efficient use of the e-Manual, you can use several search tools to find the desired content.

## ➤ How to Use the e-Manual

- [Operating Environment](#)
- [Installing the e-Manual](#)
- [Uninstalling the e-Manual](#)

## ➤ Screen Layout of the e-Manual

- [Top Page](#)
- [Topic Page](#)
- [Site Map](#)
- [Search Method](#)

## ➤ Viewing the e-Manual

### <To find the desired content>

- **Selecting between the category icons**

From the top page, select a category icon you want.

➤ ["Top Page"](#)

- **Searching from the site map**

On the site map, you can view the list of whole sections of the e-Manual sorted by category. You can directly display sections in a category.

➤ ["Site Map"](#)

- **Whole text search function**

You can search by keyword in the e-Manual. You can display the desired description from the search results by entering a keyword you want to search. This function supports AND search.

➤ ["Search Method"](#)

## How to Use the e-Manual

---

Click the following links to see the system requirements to use the e-Manual and how to install/uninstall the e-Manual.

[Operating Environment](#)

[Installing the e-Manual](#)

[Uninstalling the e-Manual](#)

---

## Operating Environment

---

You need a Web browser to use the e-Manual. Operation of the following Web browsers is guaranteed.

- Internet Explorer 6.0/7.0/8.0/9.0/10.0
- Firefox 2.x/3.x/4.x/5.x/6.x/7.x/8.x/9.x/10.x/11.x/13.x/14.x/15.x/16.x/17.x/18.x/19.x

 **NOTE**

**Enabling the script function and cookies**

Enable the script function and cookies for the Web browser before using the e-Manual.

---

## Installing the e-Manual

Install the e-Manual included in the supplied CD-ROM on your computer using the following procedure.

† This function is not supported for Macintosh.

### 1

**Insert the supplied CD-ROM "User Software" into the CD-ROM drive of your computer.**

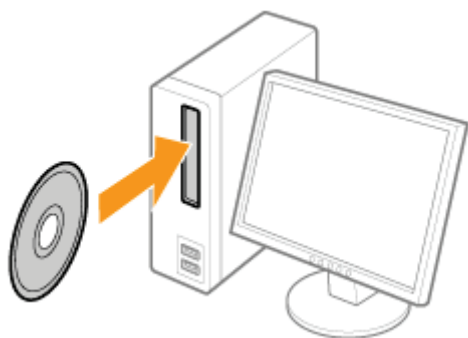

### 2

**Click [Custom Installation].**

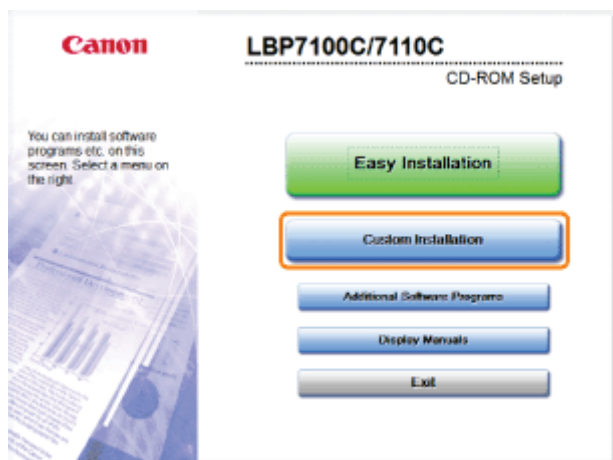

**? If the above screen does not appear**

↳ "Basic Operations/Various Information for Windows"

**? If the [AutoPlay] dialog box appears**

Click [Run AUTORUN.EXE].

**? If the [User Account Control] dialog box appears**

Click [Yes] or [Continue].

### 3

**Perform the following procedure.**

(1) Clear the [MF/LBP Network Setup Tool] and [Printer Driver] check boxes.

(2) Click [Start].

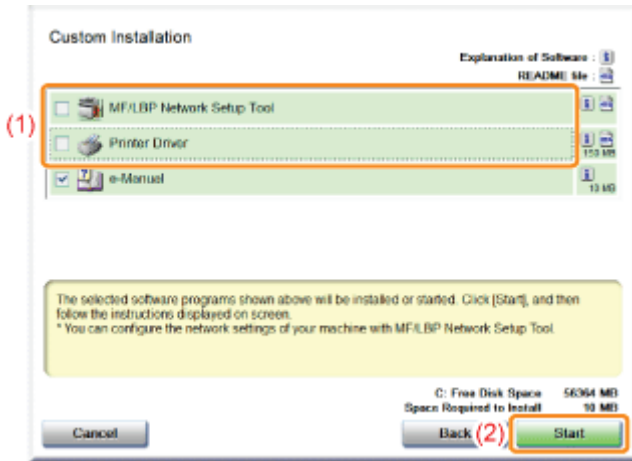

## 4

**Read the contents of License Agreement, and then click [Yes].**



→ The installation starts.

Wait a moment until the installation is complete. (It may take a long time to install the e-Manual.)

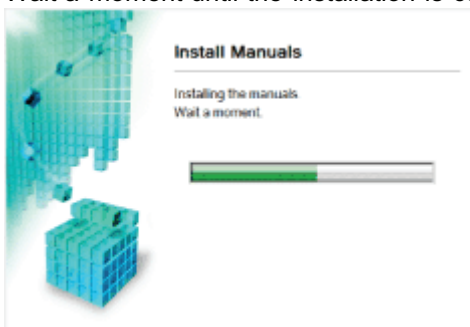

## 5

**Click [Exit].**





## 6

Click **[Next]**.

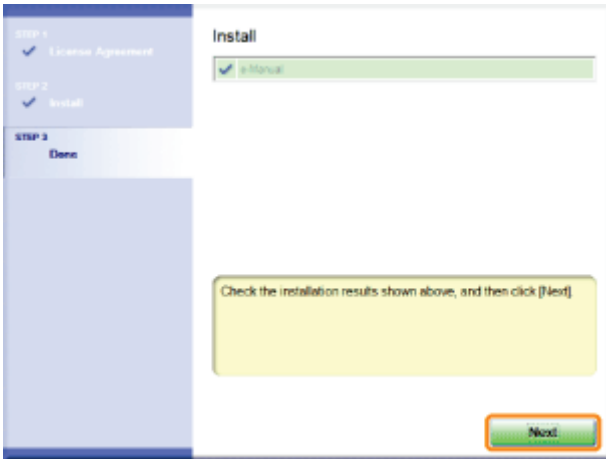

## 7

Click **[Exit]**.

† When the following screen appears, you can remove the CD-ROM.

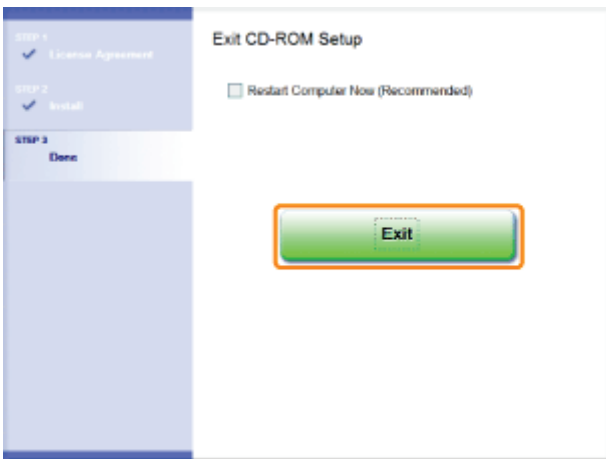

### Displaying the e-Manual

Double-click [LBP7100C 7110C e-Manual] created on the desktop.



## When a security protection message appears

To help protect your security, Internet Explorer has restricted this webpage from running scripts or ActiveX controls that could access your computer. Click here for options...

Perform the following procedure.

1. Click the information bar, and then select [Allow Blocked Content] from the pop-up menu.

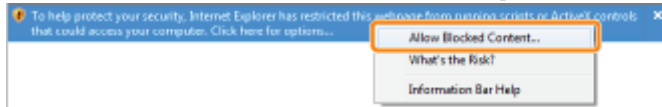

2. Click [Yes].

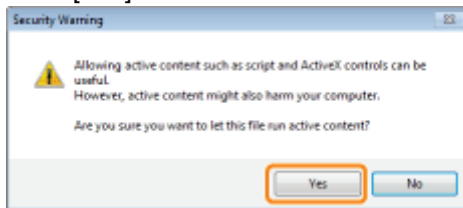

## NOTE

### Displaying the e-Manual directly from the CD-ROM

You can also display the e-Manual directly from the CD-ROM without installing it in the computer you are using.

1. Insert the supplied CD-ROM "User Software" into the CD-ROM drive of your computer.
2. Click [Display Manuals].
3. Click [ ] button next to [e-Manual].

† Depending on the operating system you are using, a security protection message is displayed. Allow the contents to be displayed.

## Uninstalling the e-Manual

The process of removing the e-Manual to restore the computer to the same state as before the e-Manual was installed is referred to as uninstallation. To uninstall the e-Manual, perform the following procedure.

† This function is not supported for Macintosh.

### 1

**Insert the supplied CD-ROM "User Software" into the CD-ROM drive of your computer.**

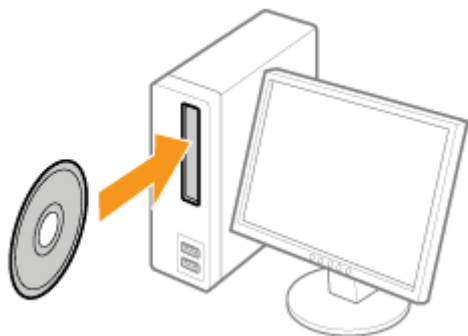

### 2

**Click [Additional Software Programs].**



**? If the above screen does not appear**

↳ "Basic Operations/Various Information for Windows"

**? If the [AutoPlay] dialog box appears**

Click [Run AUTORUN.EXE].

**? If the [User Account Control] dialog box appears**

Click [Yes] or [Continue].

### 3

**Click [Start] in [Manual Uninstaller].**

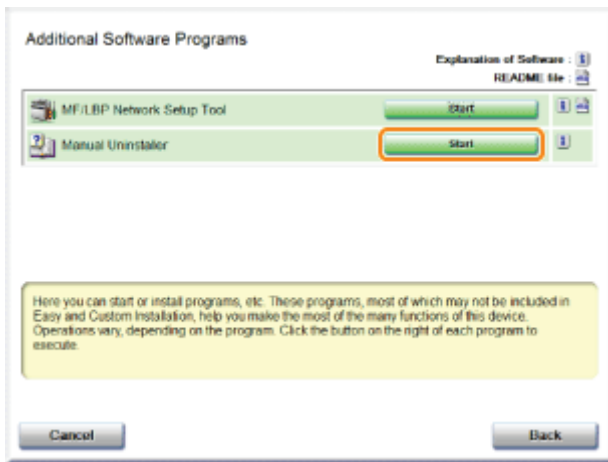

## 4

**Click [Uninstall] to start the uninstallation.**

Please wait a moment until the uninstallation is complete. (It may take a long time to uninstall the e-Manual.)



## 5

**Click [Exit].**



## 6

**Click [Back].**

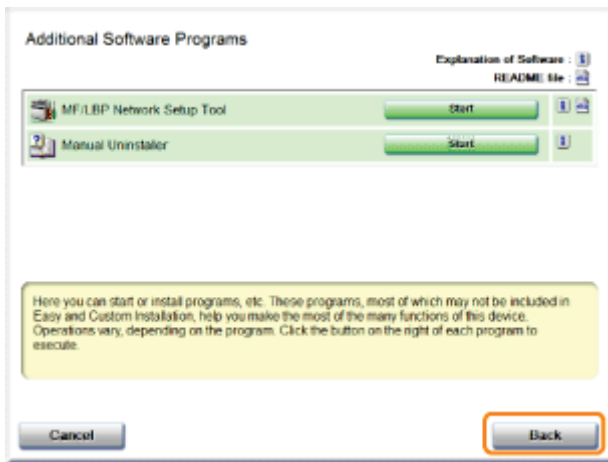

## 7

Click **[Exit]**.

† When the following screen appears, you can remove the CD-ROM.

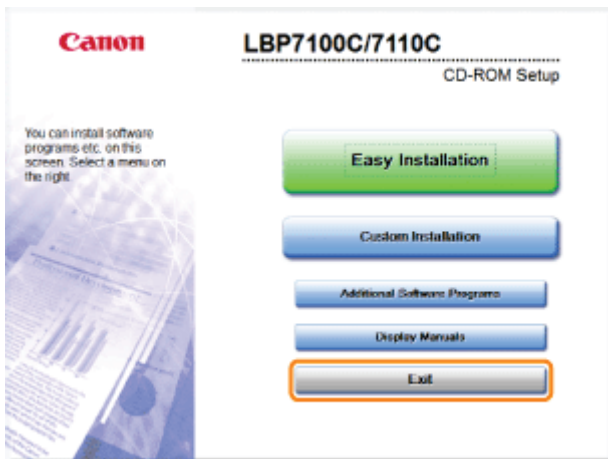

## Screen Layout of the e-Manual

---

This section describes the screen layout of the e-Manual.

The page displayed right after the e-Manual starts is called "Top Page" and the manual description is called "Topic Page" in this section.

"Site map" is displayed from [Site map] which is located on the upper right of the e-Manual.

The search panel is used to make search through the e-Manual.

The screen layout is different for each page, so click the following links to see the instruction.

[\*\*➤ Top Page\*\*](#)

[\*\*➤ Topic Page\*\*](#)

[\*\*➤ Site Map\*\*](#)

[\*\*➤ Search Method\*\*](#)

---

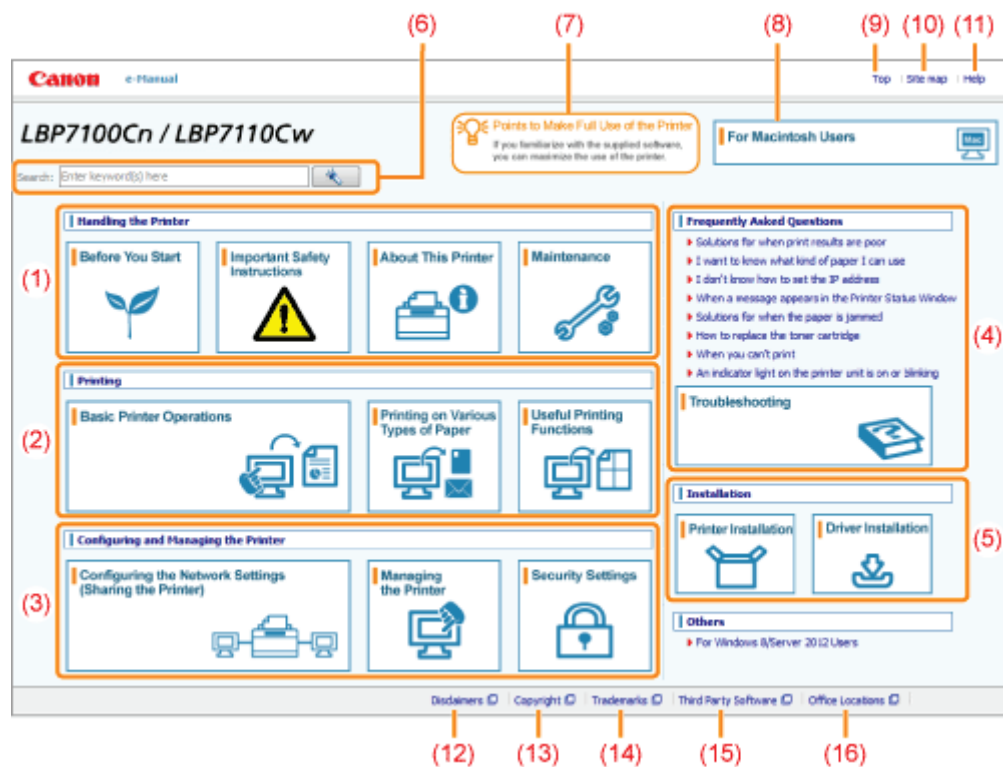

## (1) [Handling the Printer]

This section describes the precautions and maintenance methods for handling the printer, and so on.

## (2) [Printing]

This section describes a variety of printing methods, such as basic printing and advanced one that uses the various printing functions.

How to load paper is also described here.

## (3) [Configuring and Managing the Printer]

This section describes how to specify the network settings, how to manage the printer, and so on.

## (4) [Frequently Asked Questions]

Frequently asked questions are featured.

For details on the solutions for the other problems, see [Troubleshooting].

## (5) [Installation]

This section describes how to install this printer, how to install the printer driver, and so on.

## (6) [Search]

The search panel is displayed by entering keyword(s) and clicking [  ].

For details, see "[Search Method](#)."

## (7) [Points to Make Full Use of the Printer]

This section describes software tasks and functions supplied with the printer to maximize the use of the printer.

## (8) [For Macintosh Users]

Precautions when using Macintosh are explained.

## (9) [Top]

The top page of the e-Manual is displayed.

## (10) [Site map]

The entire contents of the e-Manual are displayed.

## (11) [Help]

How to use the e-Manual is displayed.

## (12) [Disclaimers]

The disclaimers are displayed.

## (13) [Copyright]

The information of copyrights is displayed.

**(14) [Trademarks]**

The trademarks are displayed.

**(15) [Third Party Software]**

The information about the third party software is displayed.

**(16) [Office Locations]**

Inquiries for this printer are displayed.

---



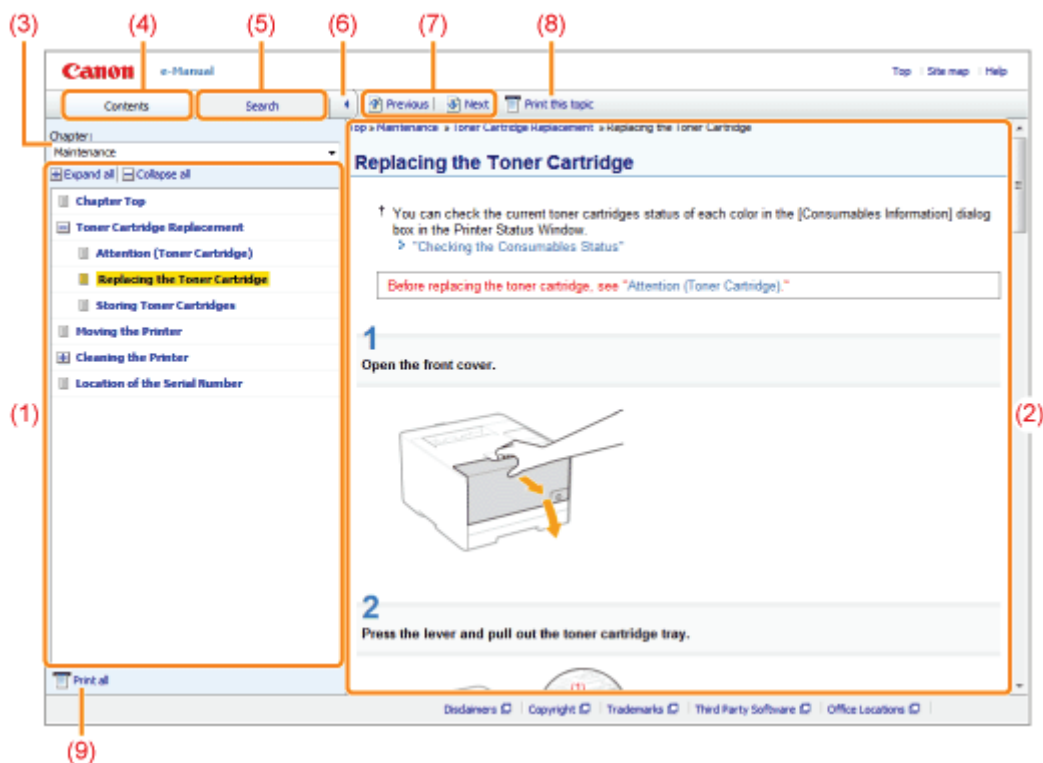

## (1) Chapter contents

This is the list of the contents in the chapter. Clicking each item displays the description in the topic page. Click [ + ] to expand a menu, and click [ - ] to collapse a menu.

Alternatively, click [ + Expand all ] to expand all menus, and click [ - Collapse all ] to collapse all menus.

## (2) Topic page

The descriptions of each item are displayed.

The current location of the displayed topic is displayed at the upper left of the topic page. Click a link to move to a higher level.

## (3) [Chapter] menu

You can select a different chapter from the pull-down menu.

## (4) [Contents] tab

Click to display the chapter contents panel.

## (5) [Search] tab

Click to display the search panel.

For details, see "Search Method."

## (6) [ < /> ]

Click to display or hide the chapter contents panel/search panel.

## (7) [Previous]/[Next]

Click to move to the previous or next topic.

## (8) [Print this topic]

Prints only the topic page currently displayed.

## (9) [Print all]

Prints all the contents in a chapter.

# Site Map

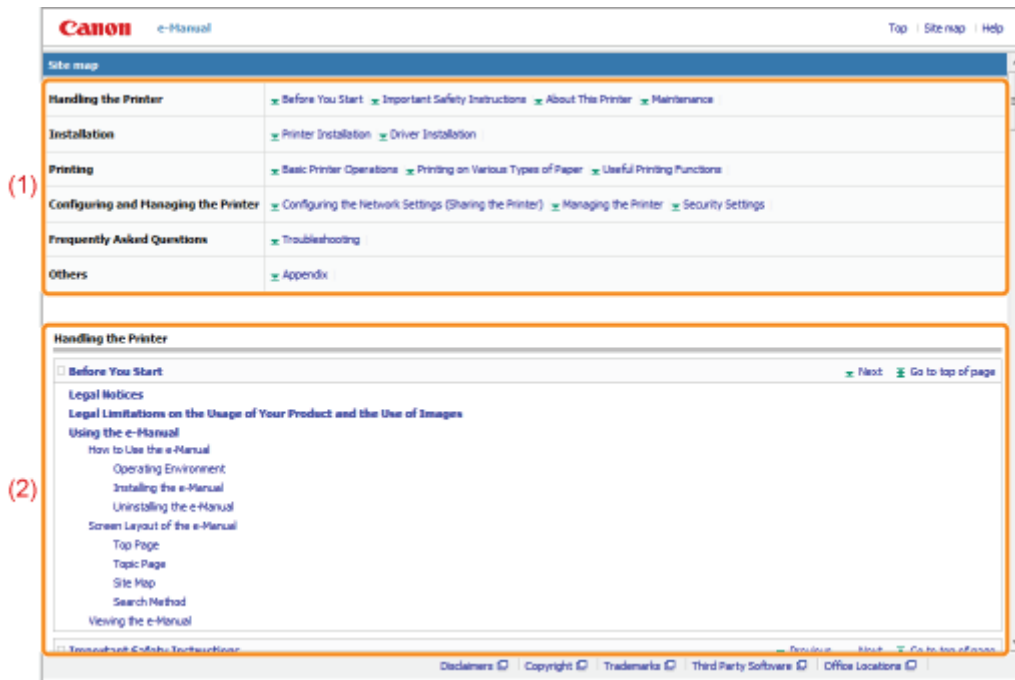

## (1) Categories

Shows the chapters of the e-Manual. Click an item to view the detailed list of the chapter.

## (2) Whole contents

Shows the all chapters and sections of the e-Manual. Click an item to view the contents.

# Search Method

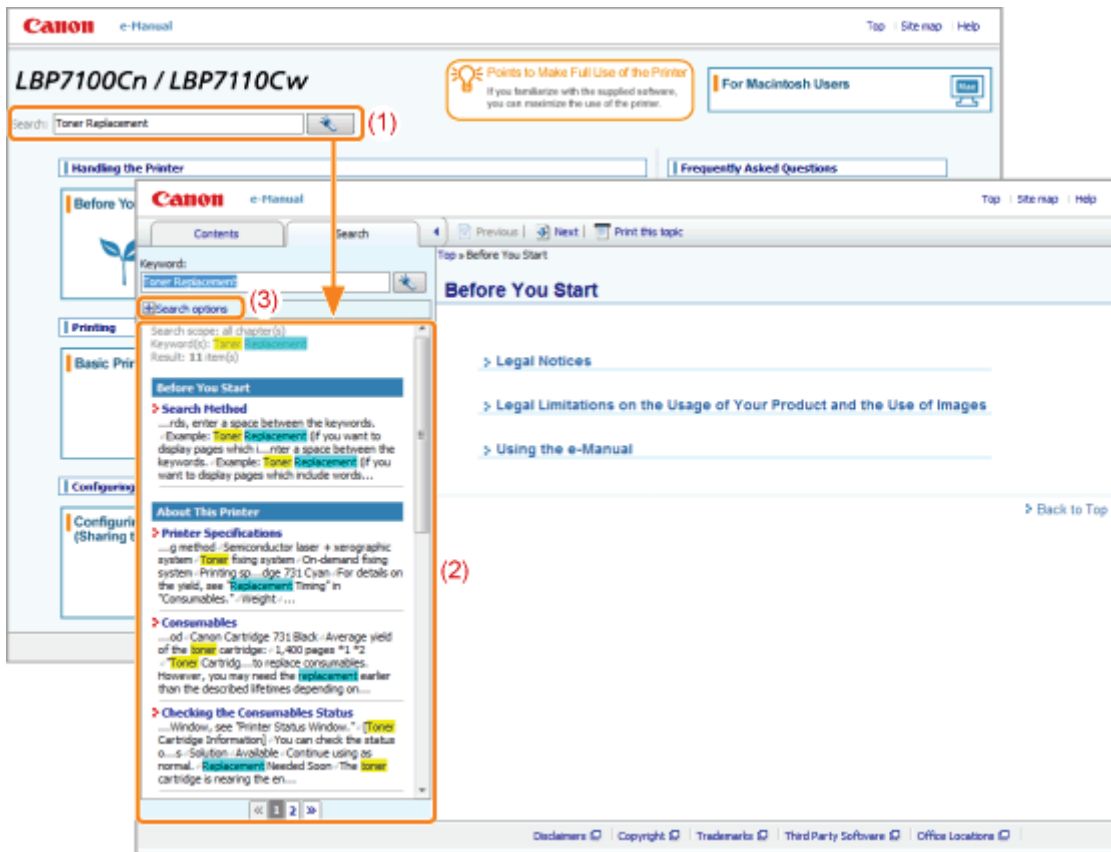

## (1) Search



Entering a character string in [Search] on the top page or in the [Keyword] text box on the search panel and then clicking [  ] displays the search results.

The AND search is available in the e-Manual so you can refine the search results by entering two or more keywords. When entering keywords, enter a space between the keywords.

- **Example:** Toner Replacement (if you want to display pages which include words, "Toner" and "Replacement")

## (2) Search result

The search results for a keyword are displayed.

If there are more than 10 search results, you can see the other results by clicking [  ], [  ], or the number which is located below the result.

## (3) [Search options]

Click to display the search options.

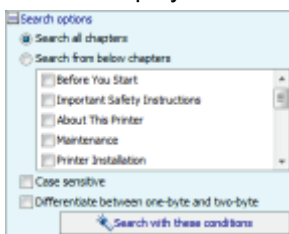

The search options can be used to specify the chapter to search, case sensitivity, and whether to differentiate between one- and two-byte characters.

Click [Search with these conditions] to search with the specified conditions.

## Viewing the e-Manual

### Symbols Used in the e-Manual

The following are descriptions of warnings and cautions used in the e-Manual to explain handling restrictions, precautions, and instructions that should be observed for your safety.

#### **WARNING**

Indicates a warning concerning operations that may lead to death or injury to persons if not performed correctly. To use the machine safely, always pay attention to these warnings.

#### **CAUTION**

Indicates a caution concerning operations that may lead to injury to persons if not performed correctly. To use the machine safely, always pay attention to these cautions.

#### **IMPORTANT**

Indicates operational requirements and restrictions. Be sure to read these items carefully to operate the machine correctly, and avoid damage to the machine or property.

#### **NOTE**

Indicates a clarification of an operation, or contains additional explanations for a procedure. Reading these notes is highly recommended.



Indicates an operation that must not be performed. Read these items carefully, and make sure not to perform the described operations.

### Keys and Buttons Used in This Manual

The following are examples of how control panel keys and on-screen buttons are depicted in the e-Manual.

Type	Depiction in the e-Manual	Example
Control panel keys	[Key icon] + (Key name)	[  ] (Cancel Job)
Buttons on computer operation screen and so on	[Button name and so on]	[OK]

### Screenshots Used in the e-Manual

The contents of the screenshots used in the e-Manual are the default settings.

Depending on the system configuration, the contents of the screenshots may partly differ.

† The functions of the printer driver may be changed due to upgrade.

### Illustrations Used in the e-Manual

- The illustrations used in the e-Manual are those for the LBP7110Cw unless mentioned otherwise.

† Though not shown in the illustrations in this manual, the control panels are labeled with names in certain countries or regions.

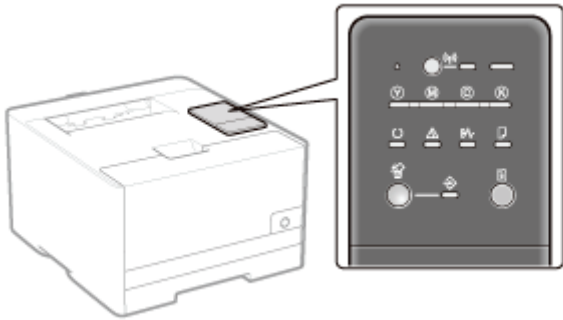

- Although the power cord used in this manual is as the one in the following illustration, the form of the power cord may differ depending on the country or region.

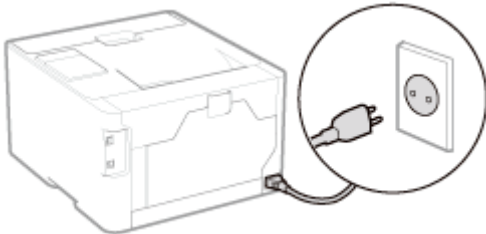

### About the Supplied CD-ROM

Although the e-Manual states that this printer is supplied with CD-ROMs, in certain countries or regions the printer is supplied with a DVD-ROM in place of CD-ROMs.

If your printer is supplied with a DVD-ROM, please take each mention of "the supplied CD-ROM" or "the supplied CD-ROMs" in this manual as referring to "the supplied DVD-ROM."

### Abbreviations Used in the e-Manual

#### Abbreviations of Operating Systems

In the e-Manual, operating systems are abbreviated as follows.

Microsoft Windows XP operating system	Windows XP
Microsoft Windows Vista operating system	Windows Vista
Microsoft Windows 7 operating system	Windows 7
Microsoft Windows Server 2003 operating system	Windows Server 2003
Microsoft Windows Server 2008 operating system	Windows Server 2008
Microsoft Windows operating system	Windows

## Disclaimers

---

- The information in this manual is subject to change without notice.
  - CANON INC. MAKES NO WARRANTY OF ANY KIND WITH REGARD TO THIS MATERIAL, EITHER EXPRESS OR IMPLIED, EXCEPT AS PROVIDED HEREIN, INCLUDING WITHOUT LIMITATION, THEREOF, WARRANTIES AS TO MARKETABILITY, MERCHANTABILITY, FITNESS FOR A PARTICULAR PURPOSE OF USE OR AGAINST INFRINGEMENT OF ANY PATENT. CANON INC. SHALL NOT BE LIABLE FOR ANY DIRECT, INCIDENTAL, OR CONSEQUENTIAL DAMAGES OF ANY NATURE, OR LOSSES OR EXPENSES RESULTING FROM THE USE OF THIS MATERIAL.
-

## Copyright

---

- Copyright 2013 by Canon Inc. All rights reserved.
  - No part of this publication may be reproduced or transmitted in any form or by any means, electronic or mechanical, including photocopying and recording, or by any information storage or retrieval system without the prior written permission of Canon Inc.
-

## Trademarks

---

- Canon, the Canon logo, LBP, and PageComposer are trademarks of Canon Inc.
  - Adobe, Adobe Acrobat, and Adobe Reader are trademarks of Adobe Systems Incorporated.
  - Apple, Mac, Mac OS, OS X, and Macintosh are trademarks of Apple Inc.
  - Microsoft, Windows, Windows Vista, Windows Server and Internet Explorer are either registered trademarks or trademarks of Microsoft Corporation in the United States and/or other countries.
  - Ethernet is a trademark of Xerox Corporation.
  - Other product and company names herein may be the trademarks of their respective owners.
-



## Important Safety Instructions

---

Read these "Important Safety Instructions" thoroughly before operating the printer.

As these instructions are intended to prevent injury to the user and other persons or destruction of property, always pay attention to these instructions.

Also, as it may result in unexpected accidents or injuries, do not perform any operation unless otherwise specified in the manual. Improper operation or use of this machine could result in personal injury and/or damage requiring extensive repair that may not be covered under your Limited Warranty.

### [\*\*↳ Important Safety Instructions\*\*](#)

---

### [\*\*↳ Wireless LAN Regulatory Information \(LBP7110Cw Only\)\*\*](#)

---

# Important Safety Instructions

---

Read the following precautions thoroughly before operating the printer.

## ▸ **Installation**

---

## ▸ **Power Supply**

---

## ▸ **Handling**

---

## ▸ **Maintenance and Inspections**

---

## ▸ **Consumables**

---

## Installation

### **WARNING**

- Do not install the printer in a location near alcohol, paint thinner, or other flammable substances. If flammable substances come into contact with electrical parts inside the printer, this may result in a fire or electrical shock.
- Do not place the following items on the printer.

- Necklaces and other metal objects
- Cups, vases, flowerpots, and other containers filled with water or liquids

If these items come into contact with a high-voltage area inside the printer, this may result in a fire or electrical shock.

If these items are dropped or spilled inside the printer, immediately turn OFF the power switch (1) and disconnect the interface cables if they are connected (2). Then, unplug the power plug from the AC power outlet (3) and contact your local authorized Canon dealer.

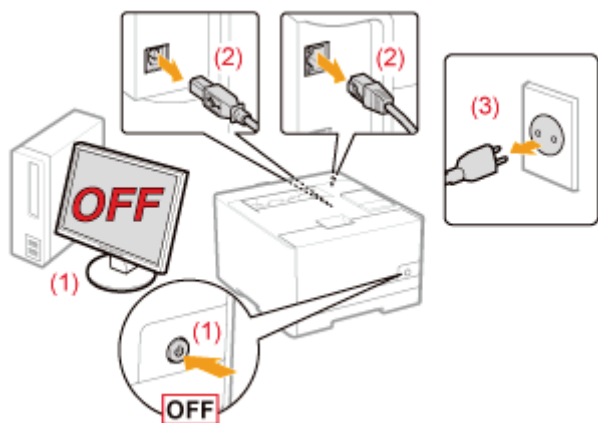

### **CAUTION**

- Do not install the printer in unstable locations, such as on unsteady platforms or inclined floors, or in locations subject to excessive vibrations, as this may cause the printer to fall or tip over, resulting in personal injury.
- The ventilation slots are provided for proper ventilation of working parts inside the printer. Never place the printer on a soft surface, such as a bed, sofa, or rug. Blocking the slots can cause the printer to overheat, resulting in a fire.
- Do not install the printer in the following locations, as this may result in a fire or electrical shock.
  - A damp or dusty location
  - A location exposed to smoke and steam, such as near a cookery or humidifier
  - A location exposed to rain or snow
  - A location near a water faucet or water
  - A location exposed to direct sunlight
  - A location subject to high temperatures
  - A location near open flames
- When installing the printer, gently lower the printer to the installation site so as not to catch your hands between the printer and the floor or between the printer and other equipment, as this may result in personal injury.
- When connecting the interface cable, connect it properly by following the instructions in the e-Manual. If not connected properly, this may result in malfunction or electrical shock.
- When moving the printer, follow the instructions in the e-Manual to hold it correctly. Failure to do so may cause you to drop the printer, resulting in personal injury.
  - ["Moving the Printer"](#)

### **IMPORTANT**

#### **At high altitudes of about 3,000 meters above sea level, or higher**

Machines with a hard disk may not operate properly when used at high altitudes of about 3,000 meters above sea level, or higher.

## Power Supply

### **WARNING**

- Do not damage or modify the power cord. Also, do not place heavy objects on the power cord or pull on or excessively bend it, as this can cause electrical damage, resulting in fire or electrical shock.
- Keep the power cord away from all heat sources. Failure to do so can cause the power cord insulation to melt, resulting in a fire or electrical shock.
- The power cord should not be taut, as this may lead to a loose connection and cause overheating, which could result in a fire.
- The power cord may become damaged if it is stepped on, fixed with staples, or if heavy objects are placed on it. Continued use of a damaged power cord can lead to an accident, such as a fire or electrical shock.
- Do not plug or unplug the power plug with wet hands, as this can result in electrical shock.
- Do not plug the power cord into a multi-plug power strip, as this can result in a fire or electrical shock.
- Do not bundle up or tie up the power cord in a knot, as this can result in a fire or electrical shock.
- Insert the power plug completely into the AC power outlet. Failure to do so can result in a fire or electrical shock.
- If excessive stress is applied to the connection part of the power cord, it may damage the power cord or the wires inside the machine may disconnect. This could result in a fire. Avoid the following situations:
  - Connecting and disconnecting the power cord frequently.
  - Tripping over the power cord.
  - The power cord is bent near the connection part, and continuous stress is being applied to the power outlet or the connection part.
  - Applying a shock to the power connector.
- Do not use power cords other than the one provided, as this can result in a fire or electrical shock.
- As a general rule, do not use extension cords. Using an extension cord may result in a fire or electrical shock.

### **CAUTION**

- Do not use a power supply voltage other than that listed herein, as this may result in a fire or electrical shock.
- Always grasp the power plug when unplugging the power plug. Do not pull on the power cord, as this may expose the core wire of the power cord or damage the cord insulation, causing electricity to leak, resulting in a fire or electrical shock.
- Leave sufficient space around the power plug so that it can be unplugged easily. If objects are placed around the power plug, you may be unable to unplug it in an emergency.

### **WARNING**

- Do not disassemble or modify the printer. There are high-temperature and high-voltage components inside the printer which may result in a fire or electrical shock.
- Electrical equipment can be hazardous if not used properly. Do not allow children to touch the power cord, cables, internal gears, or electrical parts.
- If the printer makes an unusual noise or emits smoke, heat, or an unusual smell, immediately turn OFF the power switch and disconnect the interface cables if they are connected. Then, unplug the power plug from the AC power outlet and contact your local authorized Canon dealer. Continued use can result in a fire or electrical shock.
- Do not use flammable sprays near the printer. If flammable substances come into contact with electrical parts inside the printer, this may result in a fire or electrical shock.
- Always turn OFF the power switch and unplug the power plug and interface cables before moving the printer. Failure to do so can damage the cables or cords, resulting in a fire or electrical shock.
- Confirm that the power plug or power connector is inserted completely after moving the printer. Failure to do so can result in an overheating and fire.
- Do not drop paper clips, staples, or other metal objects inside the printer. Also, do not spill water, liquids, or other flammable substances (alcohol, benzene, paint thinner, and so on) inside the printer. If these items come into contact with a high-voltage area inside the printer, this may result in a fire or electrical shock. If these items are dropped or spilled inside the printer, immediately turn OFF the power switch and disconnect the interface cables if they are connected. Then, unplug the power plug from the AC power outlet and contact your local authorized Canon dealer.
- When plugging or unplugging a USB cable when the power plug is plugged into an AC power outlet, do not touch the metal part of the connector, as this can result in electrical shock.

### **CAUTION**

- Do not place heavy objects on the printer. The object or the printer may fall, resulting in personal injury.
- Turn OFF the power switch when the printer will not be used for a long period of time, such as overnight. Turn OFF the printer and unplug the power plug if the printer will not be used for an extended period of time, such as for several days.
- Open or close covers and install or remove drawers gently and carefully. Be careful not to hurt your fingers.
- Keep your hands and clothing away from the roller in the output area. Even if the printer is not printing, the roller may suddenly rotate and catch your hands or clothing, resulting in personal injury.
- The output slot is hot during and immediately after printing. Do not touch the area surrounding the output slot, as this may result in burns.

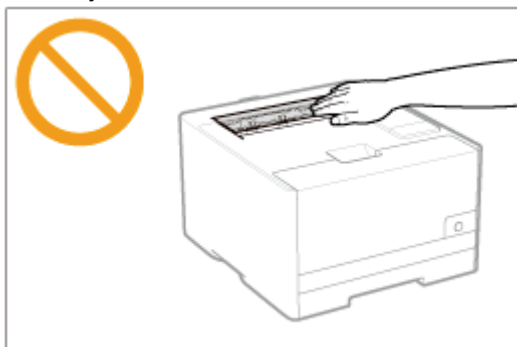

- Printed paper may be hot immediately after being output. Be careful when removing the paper and aligning the removed paper, especially after continuous printing. Failure to do so may result in burns.
- The laser beam used in the printer can be harmful to human bodies. The laser beam is confined in the laser scanner unit by a cover, so there is no danger of the laser beam escaping during normal printer operation. Read the following remarks and instructions for safety.
  - Never open covers other than those indicated in this manual.
  - Do not remove the caution label attached to the cover of the laser scanner unit.

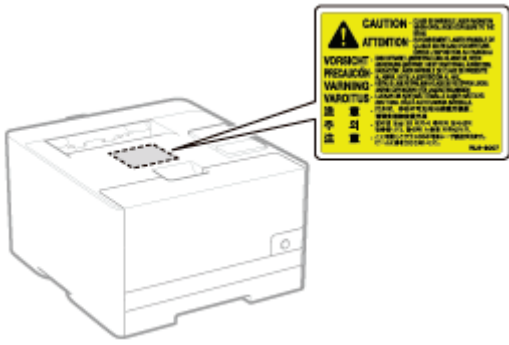

- If the laser beam should escape and enter your eyes, exposure may cause damage to your eyes.

## Maintenance and Inspections

### **WARNING**

- When cleaning the printer, turn OFF the printer and computer, remove the interface cables, and then unplug the power plug. Failure to do so can result in a fire or electrical shock.
- Unplug the power plug from the AC power outlet periodically and clean the area around the base of the power plug's metal pins and the AC power outlet with a dry cloth to remove all dust and grime. In damp, dusty, or smoky locations, dust can build up around the power plug and become damp, which can cause a short circuit, resulting in a fire.
- Clean the printer with a well wrung out cloth dampened with water or mild detergent diluted with water. Do not use alcohol, benzene, paint thinner, or other flammable substances. If flammable substances come into contact with electrical parts inside the printer, this may result in a fire or electrical shock.
- Some areas inside the printer are subject to high voltage. When removing jammed paper or when inspecting the inside of the printer, be careful not to allow necklaces, bracelets, or other metal objects to touch the inside of the printer, as this can result in burns or electrical shock.
- Do not dispose of used toner cartridges in open flames. This may cause the toner remaining inside the cartridges to ignite, resulting in burns or fire.
- If you accidentally spill or scatter toner, carefully gather the toner particles together or wipe them up with a soft, damp cloth in a way that prevents inhalation.  
Never use a vacuum cleaner that does not have safeguards against dust explosions to clean up spilled toner. Doing so may cause a malfunction in the vacuum cleaner, or result in a dust explosion due to static discharge.
- Confirm that the power plug or power connector is inserted completely after cleaning the printer. Failure to do so can result in an overheating and fire.
- Check the power cord and plug regularly. The following conditions may result in fire, so contact your local authorized Canon dealer or the Canon help line.
  - There are burn marks on the power plug.
  - The blade on the power plug is deformed or broken.
  - The power is turned OFF or ON when bending the power cord.
  - The coating of the power cord is damaged, cracked, or dented.
  - A part of the power cord becomes hot.
- Check regularly that the power cord and plug are not handled in the following manner. Failure to do so can result in a fire or electrical shock.
  - The power connector is loosened.
  - Stress is being applied to the power cord by a heavy object or by fixing it with staples.
  - The power plug is loosened.
  - The power cord is tied in a bundle.
  - A part of the power cord is put in an aisle.
  - The power cord is put in front of the heating appliance.

### **CAUTION**

- Never attempt to service this printer yourself, except as explained in this manual. There are no user serviceable parts inside the printer. Adjust only those controls that are covered in the operating instructions. Improper adjustment could result in personal injury and/or damage requiring extensive repair that may not be covered under your Limited Warranty.

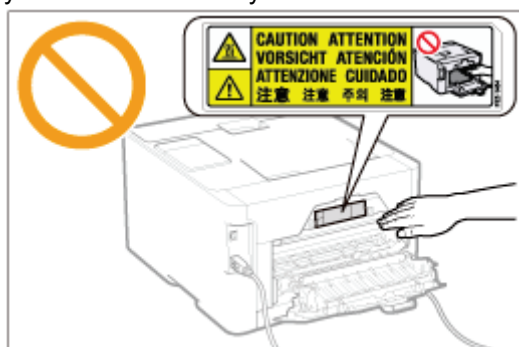

- The fixing unit and its surroundings inside the printer become hot during use. When removing jammed paper or

when inspecting the inside of the printer, do not touch the fixing unit and its surroundings, as this may result in burns.

- When removing jammed paper or when inspecting the inside of the machine, do not expose yourself to the heat emitted from the fixing unit and its surroundings for a prolonged period of time. Doing so may result in low temperature burns, even though you did not touch the fixing unit and its surroundings directly, as this may result in burns.
- If paper is jammed, remove the jammed paper so that any pieces of paper do not remain inside the printer according to the displayed message. Also, do not put your hands forcibly into the parts other than those directed on the screen. Failure to do so may result in burns or injuries.
- When removing jammed paper or replacing a toner cartridge, be careful not to get any toner on your hands or clothing, as this will dirty your hands or clothing. If toner gets on your hands or clothing, wash them immediately with cold water. Washing with warm water sets the toner, making it impossible to remove the toner stains.
- When removing jammed paper, be careful not to allow the toner on the paper to scatter. The toner may get into your eyes or mouth. If toner gets into your eyes or mouth, wash them immediately with cold water and consult a physician.
- When loading paper or removing jammed paper, be careful not to cut your hands with the edges of the paper.
- When removing a toner cartridge, remove the toner cartridge carefully so as to prevent the toner from scattering and getting into your eyes or mouth. If toner gets into your eyes or mouth, wash them immediately with cold water and consult a physician.
- Do not attempt to disassemble the toner cartridge. The toner may scatter and get into your eyes or mouth. If toner gets into your eyes or mouth, wash them immediately with cold water and consult a physician.
- If toner leaks from the toner cartridge, be careful not to inhale the toner or allow it to come into direct contact with your skin. If the toner comes into contact with your skin, wash with soap. If the skin becomes irritated or you inhale the toner, consult a physician immediately.



## Consumables

### **WARNING**

- Do not dispose of used toner cartridges in open flames. This may cause the toner to ignite, resulting in burns or fire.
- Do not store toner cartridges or paper in a location exposed to open flames. This may cause the toner or paper to ignite, resulting in burns or fire.
- When disposing of a toner cartridge, place the toner cartridge into a bag to prevent the toner from scattering, and then dispose of the toner cartridge according to local regulations.
- If you accidentally spill or scatter toner, carefully gather the toner particles together or wipe them up with a soft, damp cloth in a way that prevents inhalation.  
Never use a vacuum cleaner that does not have safeguards against dust explosions to clean up spilled toner. Doing so may cause a malfunction in the vacuum cleaner, or result in a dust explosion due to static discharge.

### **CAUTION**

- Keep the toner cartridges and other consumables out of the reach of small children. If the toner or other parts are ingested, consult a physician immediately.
- Do not attempt to disassemble the toner cartridge. The toner may scatter and get into your eyes or mouth. If toner gets into your eyes or mouth, wash them immediately with cold water and consult a physician.
- If toner leaks from the toner cartridge, be careful not to inhale the toner or allow it to come into direct contact with your skin. If the toner comes into contact with your skin, wash with soap. If the skin becomes irritated or you inhale the toner, consult a physician immediately.
- If the sealing tape is pulled out forcefully or stopped at midpoint, toner may spill out. If the toner gets into your eyes or mouth, wash them immediately with cold water and immediately consult a physician.

## Wireless LAN Regulatory Information (LBP7110Cw Only)

i-SENSYS LBP7110Cw includes approved Wireless LAN Module (Model name: FM48944).

### Regulatory information

Users in the European Union and other European countries

### R&TTE Declaration of Conformity (Wireless LAN Module)



Česky [Czech]	Společnost CANON INC. tímto prohlašuje, že zařízení FM48944 je v souladu se základními požadavky a dalšími příslušnými ustanoveními směrnice 1999/5/ES.
Dansk [Danish]	Undertegnede CANON INC. erklærer herved, at FM48944 overholder de væsentlige krav og øvrige relevante krav i direktiv 1999/5/EF.
Deutsch [German]	Hiermit erklärt CANON INC., dass sich das Gerät FM48944 in Übereinstimmung mit den grundlegenden Anforderungen und den übrigen einschlägigen Bestimmungen der Richtlinie 1999/5/EG befindet.
Eesti [Estonian]	Käesolevaga kinnitab CANON INC. seadme FM48944 vastavust direktiivi 1999/5/EÜ olulistele nõuetele ja muudele asjakohastele sätetele.
English	Hereby, CANON INC., declares that FM48944 is in compliance with the essential requirements and other relevant provisions of Directive 1999/5/EC.
Español [Spanish]	Por medio de la presente CANON INC. declara que el FM48944 cumple con los requisitos esenciales y cualesquiera otras disposiciones aplicables o exigibles de la Directiva 1999/5/CE.
Ελληνική [Greek]	Με την παρούσα, η CANON INC., δηλώνει ότι το μοντέλο FM48944 συμμορφώνεται προς τις ουσιώδεις απαιτήσεις και τις λοιπές σχετικές διατάξεις της Οδηγίας 1999/5/EK.
Français [French]	Par la présente, CANON INC. déclare que l'appareil FM48944 est conforme aux exigences essentielles et aux autres dispositions pertinentes de la directive 1999/5/CE.
Italiano [Italian]	Con la presente CANON INC. dichiara che FM48944 è conforme ai requisiti essenziali ed alle altre disposizioni pertinenti stabilite dalla direttiva 1999/5/CE.
Latviski [Latvian]	Ar šo CANON INC. deklarē, ka FM48944 atbilst Direktīvas 1999/5/EK būtiskajām prasībām un citiem ar to saistītajiem noteikumiem.
Lietuvių [Lithuanian]	Šiuo bendrovė „CANON INC.“ deklaruoja, kad FM48944 atitinka pagrindinius Direktyvoje 1999/5/EB išdėstytus reikalavimus ir kitas jos nuostatas.
Nederlands [Dutch]	Hierbij verklaart CANON INC. dat FM48944 in overeenstemming is met de essentiële eisen en de andere relevante bepalingen van richtlijn 1999/5/EG.
Malti [Maltese]	Hawnhekk, CANON INC., jiddikjara li l-FM48944 jikkonforma mal-ħtiġijiet essenzjali u ma' dispożizzjonijiet rilevanti oħra tad-Direttiva 1999/5/KE.
Magyar [Hungarian]	Alulírott CANON INC. nyilatkozom, hogy a FM48944 megfelel a vonatkozó alapvető követelményeknek és az 1999/5/EC irányelv egyéb előírásainak.
Polski [Polish]	Niniejszym CANON INC. oświadcza, że model FM48944 jest zgodny z zasadniczymi wymogami oraz pozostałymi stosownymi postanowieniami Dyrektywy 1999/5/EC.
Português [Portuguese]	Por este documento, a CANON INC. declara que o FM48944 está em conformidade com os requisitos essenciais e outras disposições relevantes da Diretiva 1999/5/CE.
Slovenščina [Slovenian]	Družba CANON INC. izjavlja, da je tiskalnik FM48944 skladni z bistvenimi zahtevami in ostalimi relevantnimi določili direktive 1999/5/ES.
Slovensky [Slovak]	CANON INC. týmto vyhlasuje, že FM48944 spĺňa základné požiadavky a všetky príslušné ustanovenia Smernice 1999/5/ES.
Suomi [Finnish]	CANON INC. vakuuttaa täten, että FM48944 -laite on direktiivin 1999/5/ EY oleellisten vaatimusten ja sitä koskevien direktiivin muiden ehtojen mukainen.

Svenska [Swedish]	Härmed intygar CANON INC. att denna FM48944 står i överensstämmelse med de väsentliga egenskapskrav och övriga relevanta bestämmelser som framgår av direktiv 1999/5/EG.
Română [Romanian]	Prin prezenta, CANON INC., declară faptul că aparatul FM48944 este în conformitate cu cerințele esențiale și cu alte prevederi relevante incluse în Directiva 1999/5/CE.
Български език [Bulgarian]	С настоящето CANON INC. декларира, че FM48944 отговаря на съществените изисквания и другите приложими изисквания на Директива 1999/5/ЕС.
Íslenska [Icelandic]	Hér með lýsir CANON INC. því yfir að FM48944 sé í samræmi við grunnkröfur og aðrar kröfur, sem gerðar eru í tilskipun 1999/5/EC.
Norsk [Norwegian]	CANON INC. erklærer herved at utstyret FM48944 er i samsvar med de grunnleggende krav og øvrige relevante krav i direktiv 1999/5/EF.
Gaeilge [Irish]	Dearbhaíonn CANON INC. leis seo go gcloíonn FM48944 le ceanglais riachtanacha agus le forálacha ábhartha eile na Treorach 1999/5/CE.



CANON INC. TORIDE PLANT  
5-1 HAKUSAN 7-CHOME TORIDE-SHI IBARAKI-KEN 302-8501 JAPAN  
PHONE : 0292174-2111

## DECLARATION of CONFORMITY

We, **Canon Inc.**  
5-1, Hakusan 7-chome, Toride-shi, Ibaraki-ken 302-8501, Japan

declare under our sole responsibility that the product:

**Product : Wireless LAN Module**  
**Model/Type : FM48944**

to which this declaration relates is in conformity with the essential requirements and other relevant requirements of the R&TTE Directive (1999/5/EC).  
The product is in conformity with the following standards:

**RADIO : EN 300 328 V1.7.1: 2006-10**  
**EMC : EN 301 489-1 V1.8.1: 2008-04**  
**EN 301 489-17 V2.1.1: 2009-05**  
**SAFETY : EN 60950-1: 2006+Amd.11: 2009**

# CE 1731 !

Date : January 13, 2011

Signature : 

Name : Masayuki Hiraide  
Title : Manager

Česky [Czech]	* Toto zařízení může být provozováno na území AT, BE, BG, CH, CY, CZ, DE, DK, EE, ES, FI, FR, GB, GR, HU, IE, IS, IT, LI, LT, LU, LV, MT, NL, NO, PL, PT, RO, SE, SI, SK.* Poznámky týkající se použití tohoto produktu.
---------------	--

	Francie: Tento produkt nelze používat mimo uzavřené prostory.
Dansk [Danish]	* Dette produkt må anvendes i AT, BE, BG, CH, CY, CZ, DE, DK, EE, ES, FI, FR, GB, GR, HU, IE, IS, IT, LI, LT, LU, LV, MT, NL, NO, PL, PT, RO, SE, SI, SK.* Bemærkninger for anvendelse af dette produkt. Frankrig: Dette produkt kan ikke anvendes udendøre.
Deutsch [German]	* Dieses Gerät darf in folgenden Ländern betrieben werden AT, BE, BG, CH, CY, CZ, DE, DK, EE, ES, FI, FR, GB, GR, HU, IE, IS, IT, LI, LT, LU, LV, MT, NL, NO, PL, PT, RO, SE, SI, SK.* Hinweise zur Verwendung dieses Produkts. Frankreich: Dieses Produkt darf nicht im Freien verwendet werden.
Eesti [Estonian]	* Seda seadet võib kasutada AT, BE, BG, CH, CY, CZ, DE, DK, EE, ES, FI, FR, GB, GR, HU, IE, IS, IT, LI, LT, LU, LV, MT, NL, NO, PL, PT, RO, SE, SI, SK.* Teadaanne selle toote kasutamise kohta.Prantsusmaa: seda toodet saab kasutada vaid siseruumides.
English	* This equipment may be operated in AT, BE, BG, CH, CY, CZ, DE, DK, EE, ES, FI, FR, GB, GR, HU, IE, IS, IT, LI, LT, LU, LV, MT, NL, NO, PL, PT, RO, SE, SI, SK.* Notice for use of this product.France : This product cannot be used outdoors.
Español [Spanish]	* Este equipo puede ser utilizado en AT, BE, BG, CH, CY, CZ, DE, DK, EE, ES, FI, FR, GB, GR, HU, IE, IS, IT, LI, LT, LU, LV, MT, NL, NO, PL, PT, RO, SE, SI, SK.* Aviso relativo al uso de este producto.Francia: este producto no puede utilizarse en exteriores.
Français [French]	* Cet équipement peut être utilisable en AT, BE, BG, CH, CY, CZ, DE, DK, EE, ES, FI, FR, GB, GR, HU, IE, IS, IT, LI, LT, LU, LV, MT, NL, NO, PL, PT, RO, SE, SI, SK. * Avis concernant l'utilisation de ce produit.France : Ce produit ne peut pas être utilisé à l'extérieur.
Italiano [Italian]	* Questo dispositivo può essere utilizzato in AT, BE, BG, CH, CY, CZ, DE, DK, EE, ES, FI, FR, GB, GR, HU, IE, IS, IT, LI, LT, LU, LV, MT, NL, NO, PL, PT, RO, SE, SI, SK. * Nota per l'uso del prodotto.Francia: il prodotto non può essere utilizzato all'aperto.
Latviski [Latvian]	* Šo aprīkojumu drīkst lietot AT, BE, BG, CH, CY, CZ, DE, DK, EE, ES, FI, FR, GB, GR, HU, IE, IS, IT, LI, LT, LU, LV, MT, NL, NO, PL, PT, RO, SE, SI, SK. * Piezīmes par šī izstrādājuma lietošanu.Frāncija: šo izstrādājumu nedrīkst lietot ārpus telpām.
Lietuvių [Lithuanian]	* Šį įrenginį galima eksploatuoti AT, BE, BG, CH, CY, CZ, DE, DK, EE, ES, FI, FR, GB, GR, HU, IE, IS, IT, LI, LT, LU, LV, MT, NL, NO, PL, PT, RO, SE, SI, SK. * Pastaba apie šio produkto naudojimą.Prancūzija: šio produkto negalima naudoti lauke.
Nederlands [Dutch]	* Deze apparatuur kan worden gebruikt in de volgende landen AT, BE, BG, CH, CY, CZ, DE, DK, EE, ES, FI, FR, GB, GR, HU, IE, IS, IT, LI, LT, LU, LV, MT, NL, NO, PL, PT, RO, SE, SI, SK. * Kennisgeving voor gebruik van dit product.Frankrijk: dit product kan niet buiten worden gebruikt.
Suomi [Finnish]	* Laitetta voidaan käyttää seuraavassa maassa AT, BE, BG, CH, CY, CZ, DE, DK, EE, ES, FI, FR, GB, GR, HU, IE, IS, IT, LI, LT, LU, LV, MT, NL, NO, PL, PT, RO, SE, SI, SK. * Huomautuksia tämän tuotteen käytöstä.Ranska: Tuotetta ei saa käyttää ulkoilmassa.
Malti [Maltese]	* Dan l-apparat jista' jintuza f' AT, BE, BG, CH, CY, CZ, DE, DK, EE, ES, FI, FR, GB, GR, HU, IE, IS, IT, LI, LT, LU, LV, MT, NL, NO, PL, PT, RO, SE, SI, SK. * Avviż għall-użu ta' dan il-prodott.Franza: Dan il-prodott ma jistax jintuza fuq barra.
Magyar [Hungarian]	* Ez a készülék AT, BE, BG, CH, CY, CZ, DE, DK, EE, ES, FI, FR, GB, GR, HU, IE, IS, IT, LI, LT, LU, LV, MT, NL, NO, PL, PT, RO, SE, SI, SK üzemeltethető. * Megjegyzések a termék használatához.Franciaország: A termék csak beltérben használható.
Polski [Polish]	* To urządzenie może być eksploatowane w AT, BE, BG, CH, CY, CZ, DE, DK, EE, ES, FI, FR, GB, GR, HU, IE, IS, IT, LI, LT, LU, LV, MT, NL, NO, PL, PT, RO, SE, SI, SK. * Uwaga dotycząca użytkowania produktu.Franca: produktu nie należy używać na zewnątrz.
Português [Portuguese]	* Este equipamento pode ser utilizado em AT, BE, BG, CH, CY, CZ, DE, DK, EE, ES, FI, FR, GB, GR, HU, IE, IS, IT, LI, LT, LU, LV, MT, NL, NO, PL, PT, RO, SE, SI, SK. * Aviso referente ao uso deste produto.França: Este produto não pode ser usado em áreas externas.
Slovenščina [Slovenian]	* To opremo je dovoljeno uporabljati v AT, BE, BG, CH, CY, CZ, DE, DK, EE, ES, FI, FR, GB, GR, HU, IE, IS, IT, LI, LT, LU, LV, MT, NL, NO, PL, PT, RO, SE, SI, SK. * Obvestilo glede uporabe tega izdelka.Frāncija: Tega izdelka ni mogoče uporabiti na odprtem.

Slovensky [Slovak]	<p>* Toto zariadenie môže byť používané na území AT, BE, BG, CH, CY, CZ, DE, DK, EE, ES, FI, FR, GB, GR, HU, IE, IS, IT, LI, LT, LU, LV, MT, NL, NO, PL, PT, RO, SE, SI, SK.</p> <p>* Upozornenie k používaniu tohto výrobku.Francúzsko: Tento výrobok sa nesmie používať vonku.</p>
Ελληνική [Greek]	<p>* Το παρόν προϊόν μπορεί να χρησιμοποιηθεί στην AT, BE, BG, CH, CY, CZ, DE, DK, EE, ES, FI, FR, GB, GR, HU, IE, IS, IT, LI, LT, LU, LV, MT, NL, NO, PL, PT, RO, SE, SI, SK.</p> <p>* Σημείωση για τη χρήση αυτού του προϊόντος.Γαλλία: Αυτό το προϊόν δεν μπορεί να χρησιμοποιηθεί σε εξωτερικούς χώρους.</p>
Svenska [Swedish]	<p>* Den här utrustningen kanske fungerar i AT, BE, BG, CH, CY, CZ, DE, DK, EE, ES, FI, FR, GB, GR, HU, IE, IS, IT, LI, LT, LU, LV, MT, NL, NO, PL, PT, RO, SE, SI, SK.</p> <p>* Meddelande för användning av denna produkt.Frankrike: Denna produkt får inte användas utomhus.</p>
Română [Romanian]	<p>* Acest echipament poate fi operat în AT, BE, BG, CH, CY, CZ, DE, DK, EE, ES, FI, FR, GB, GR, HU, IE, IS, IT, LI, LT, LU, LV, MT, NL, NO, PL, PT, RO, SE, SI, SK.</p> <p>* Notă privind utilizarea acestui produs.Franța: Acest produs nu se va utiliza în exterior.</p>
Български език [Bulgarian]	<p>* Това оборудване може да се използва в AT, BE, BG, CH, CY, CZ, DE, DK, EE, ES, FI, FR, GB, GR, HU, IE, IS, IT, LI, LT, LU, LV, MT, NL, NO, PL, PT, RO, SE, SI, SK.</p> <p>* Забележка по използването на този продукт.Франция: Този продукт не може да се използва извън територията на фирмата.</p>
Íslenska [Icelandic]	<p>* Viðgerð á þessu tæki má annast á AT, BE, BG, CH, CY, CZ, DE, DK, EE, ES, FI, FR, GB, GR, HU, IE, IS, IT, LI, LT, LU, LV, MT, NL, NO, PL, PT, RO, SE, SI, SK.</p> <p>* Tilkynning vegna notkunar vörunnar.Frakkland : Þessa vöru má ekki nota utan dyra.</p>
Norsk [Norwegian]	<p>* Dette produktet må anvendes i AT, BE, BG, CH, CY, CZ, DE, DK, EE, ES, FI, FR, GB, GR, HU, IE, IS, IT, LI, LT, LU, LV, MT, NL, NO, PL, PT, RO, SE, SI, SK.</p> <p>* Merknad for bruk av dette produktet.Frankrike: Produktet kan ikke brukes utendørs.</p>
Gaeilge [Irish]	<p>* Féadfar an trealamh seo a fheidmiú in AT, BE, BG, CH, CY, CZ, DE, DK, EE, ES, FI, FR, GB, GR, HU, IE, IS, IT, LI, LT, LU, LV, MT, NL, NO, PL, PT, RO, SE, SI, SK.</p> <p>* Fógra maidir le húsáid an táirge seo.An Fhrainc : Ní féidir an táirge seo a úsáid amuigh faoin aer.</p>

### Regulatory information for users in Jordan

Contains Wireless LAN Module approved by TRC/SS/2011/32

### Regulatory information for users in UAE

TRA REGISTERD No: ER0058948/11

DEALER No: DA0058934/11

## About This Printer

---

➤ [\*\*Printer Specifications\*\*](#)

---

➤ [\*\*System Requirements for Printing\*\*](#)

---

➤ [\*\*Names and Dimensions of Each Part\*\*](#)

---

➤ [\*\*Control Panel\*\*](#)

---

➤ [\*\*Printer Status Window\*\*](#)

---

➤ [\*\*Introduction of the Utilities\*\*](#)

---

➤ [\*\*Energy-saving Mode\*\*](#)

---

➤ [\*\*Cautions for Handling the Printer\*\*](#)

---

➤ [\*\*Consumables\*\*](#)

---

# Printer Specifications

## Hardware Specifications

	LBP7100Cn	LBP7110Cw
Type	Desktop Page Printer	
Printing method	Semiconductor laser + xerographic system	
Toner fixing system	On-demand fixing system	
Printing speed (Plain paper (60 to 90 g/m <sup>2</sup> ), when printing A4 paper continuously)	<ul style="list-style-type: none"> <li>Black and white printing: 14 pages/min.</li> <li>Color printing: 14 pages/min.</li> </ul> † The print speed may drop depending on the output resolution, number or copies, and paper settings for the size, type, and orientation.	
Warm up time (Time from power on to printer ready)	20 seconds or less  † May vary depending on the usage conditions, such as the installation environment.	
Recovery time (Time from sleep mode to printer ready)	Approx. 4 seconds  † May vary depending on the output environment.	
First print time (When printing A4 paper)	<ul style="list-style-type: none"> <li>Black and white printing: 18 seconds</li> <li>Color printing: 18 seconds</li> </ul> † May vary depending on the output environment.	
Paper size	<ul style="list-style-type: none"> <li>Standard sizes: A4, B5, A5, Legal, Letter, Executive, Statement, Foolscap, 16K, Index Card, Envelope DL, Envelope No. 10 (COM10), Envelope C5, and Envelope Monarch</li> <li>Custom paper sizes*: Width 83.0 to 215.9 mm, Length (Height) 127.0 to 355.6 mm</li> </ul> * The width must be less than the length (height).	
Paper capacity (Paper Drawer)	Approx. 150 sheets	
Paper output	Face-down	
Output capacity (Output tray)	Approx. 125 sheets  † Actual paper capacity varies depending on the installation environment and paper type to be used.	
Noise (measured in accordance with ISO 7779, declared noise emission in accordance with ISO 9296)	<ul style="list-style-type: none"> <li>LwAd (declared A-weighted sound power level (1 B = 10 dB))               <ul style="list-style-type: none"> <li>- During standby: Inaudible*</li> <li>- During operation: 6.52 B or less</li> </ul> </li> <li>LpAm (declared A-weighted sound pressure level (bystander position))               <ul style="list-style-type: none"> <li>- During standby: Inaudible*</li> <li>- During operation: Approx. 49 dB</li> </ul> </li> </ul> * Indicates the sound pressure level of each bystander position is below the ISO	

	7779 absolute criteria for the background noise level.	
Operating environment (Printer unit only)	<p>Operating environment</p> <ul style="list-style-type: none"> <li>- Temperature range: 10 to 30 °C (50 to 86 °F)</li> <li>- Humidity range: 20 to 80 % RH (no condensation)</li> </ul>	
Host interface	<ul style="list-style-type: none"> <li>• USB interface <ul style="list-style-type: none"> <li>- Hi-Speed USB/USB</li> </ul> </li> <li>• Network interface <ul style="list-style-type: none"> <li>- Shared 10BASE-T/100BASE-TX (RJ-45)</li> <li>Full duplex/Half duplex</li> </ul> </li> </ul>	<ul style="list-style-type: none"> <li>• USB interface <ul style="list-style-type: none"> <li>- Hi-Speed USB/USB</li> </ul> </li> <li>• Network interface <ul style="list-style-type: none"> <li>- Shared 10BASE-T/100BASE-TX (RJ-45)</li> <li>Full duplex/Half duplex</li> <li>- IEEE 802.11b/g/n</li> </ul> </li> </ul>
User interface	<ul style="list-style-type: none"> <li>• Eleven LED indicators</li> <li>• One operation button/two operation keys</li> </ul>	<ul style="list-style-type: none"> <li>• Twelve LED indicators</li> <li>• One operation button/three operation keys</li> </ul>
Power supply	220 to 240 V (± 10 %), 50/60 Hz (± 2 Hz)	
Power consumption (at 20 °C (68 °F))	<ul style="list-style-type: none"> <li>• Maximum: 800 W or less</li> <li>• During operation: Approx. 340 W</li> <li>• During standby: Approx. 10 W</li> <li>• During the sleep mode: Approx. 0.9 W</li> <li>• When the power of the printer is turned OFF: 0.5 W or less</li> </ul>	<ul style="list-style-type: none"> <li>• Maximum: 800 W or less</li> <li>• During operation: Approx. 340 W</li> <li>• During standby: Approx. 10 W</li> <li>• During the sleep mode (USB connection/Wired LAN connection): Approx. 0.9 W</li> <li>• During the sleep mode (Wireless LAN connection): Approx. 4 W</li> <li>• When the power of the printer is turned OFF: 0.5 W or less</li> </ul>
	<p>† Even if the power of the printer is turned OFF, power is consumed only slightly while the power plug is inserted into the AC power outlet. To cut the power consumption completely, unplug the power plug from the AC power outlet.</p>	
Consumables	<p>Toner cartridges</p> <ul style="list-style-type: none"> <li>• Canon Cartridge 731 Black</li> <li>• Canon Cartridge 731 H Black</li> <li>• Canon Cartridge 731 Yellow</li> <li>• Canon Cartridge 731 Magenta</li> <li>• Canon Cartridge 731 Cyan</li> </ul> <p>† For details on the yield, see "Replacement Timing" in "<a href="#">Consumables</a>."</p>	
Weight	<ul style="list-style-type: none"> <li>• Printer unit and included parts <ul style="list-style-type: none"> <li>- Printer unit (excluding the toner cartridges): Approx. 16.6 kg</li> <li>- Toner cartridge (each): Approx. 0.6 kg</li> </ul> </li> <li>• Consumables <ul style="list-style-type: none"> <li>- Toner cartridge (each) (Canon Genuine Cartridge): Approx. 0.6 kg</li> </ul> </li> </ul>	

## Software Specifications

Printing software	UFR II
Printable area	<p>Data can be printed with a margin of 5.0 mm. (10 mm for envelopes)</p> <p>† For details, see "<a href="#">Printable Area</a>."</p>



## Wireless LAN Specification (LBP7110Cw Only)

Standard	IEEE 802.11b/g/n
Transmission Scheme	DS-SS System/OFDM System
Frequency Range	2412 to 2472 MHz
Data Transmission Rate	<ul style="list-style-type: none"><li>• IEEE 802.11b<ul style="list-style-type: none"><li>– 1/2/5.5/11 Mbps</li></ul></li><li>• IEEE 802.11g<ul style="list-style-type: none"><li>– 6/9/12/18/24/36/48/54 Mbps</li></ul></li><li>• IEEE 802.11n<ul style="list-style-type: none"><li>– SGI Invalidated 20 MHz : 6.5/13/19.5/26/39/52/58.5/65 Mbps</li><li>– SGI Validated 20 MHz : 7.2/14.4/21.7/28.9/43.3/57.8/72.2 Mbps</li><li>– SGI Invalidated 40 MHz : 13.5/27/40.5/81/108/121.5/135 Mbps</li><li>– SGI Validated 40 MHz : 15/30/45/60/90/120/150 Mbps</li></ul></li></ul>
Communication Mode	Infrastructure Mode
Security	WEP, WPA-PSK (TKIP/AES-CCMP), WPA2-PSK (TKIP/AES-CCMP)

# System Requirements for Printing

---

The printer driver is software required for printing with this printer.

The following system environment is required to use the printer driver.

## Operating System

---

- Windows XP Professional or Home Edition
- Windows XP Professional x64 Edition
- Windows Vista (32-bit or 64-bit version)
- Windows 7 (32-bit or 64-bit version)
- Windows Server 2003
- Windows Server 2003 x64 Editions
- Windows Server 2008 (32-bit or 64-bit version)

† For details on the latest status of the supported operating systems and Service Pack, see the Canon Web site (<http://www.canon.com/>).

## Computer

---

A computer on which any one of the above operating systems can run

## Interface

---

### When connecting with USB

Hi-Speed USB/USB

### When connecting with wired LAN

Connector: 10BASE-T/100BASE-TX

Protocol: TCP/IP

### When connecting with wireless LAN (LBP7110Cw Only)

Standard: IEEE 802.11b/g/n

Protocol: TCP/IP

#### NOTE

#### **About unidirectional communication equipment**

The printer performs bi-directional communication. Operation of the printer when connected via unidirectional communication equipment is not tested, and as a result, Canon cannot guarantee printer operation if the printer is connected using unidirectional print servers, USB hubs or switching devices.

## Names and Dimensions of Each Part

### Part Name

### Front View



- |                      |                   |                  |
|----------------------|-------------------|------------------|
| (1) Output Tray      | (4) Control Panel | (6) Power Switch |
| (2) Lift Handle      | (5) Front Cover   | (7) Paper Drawer |
| (3) Drawer Top Cover |                   |                  |

### Rear View

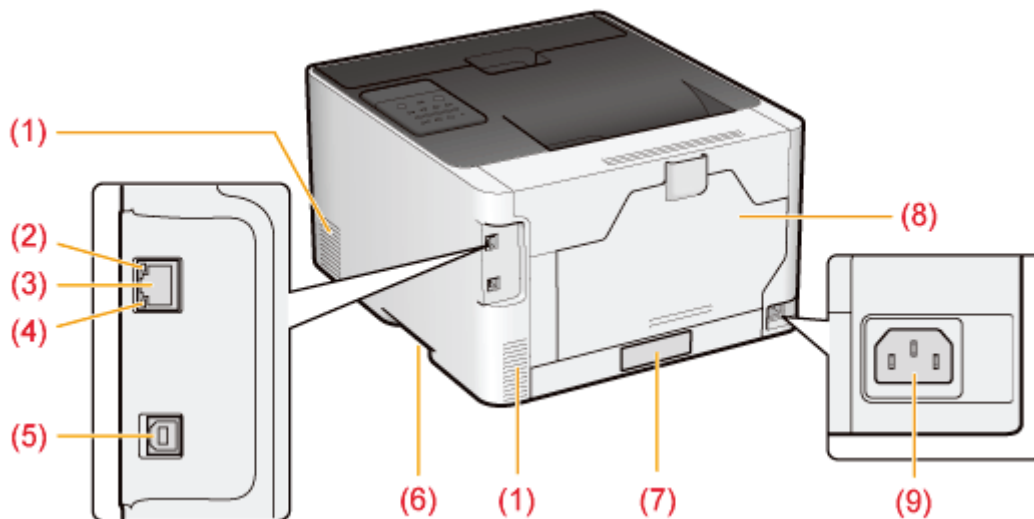

- |                            |                           |                  |
|----------------------------|---------------------------|------------------|
| (1) Ventilation Slot       | (4) LNK Indicator (Green) | (7) Rating Label |
| (2) ACT Indicator (Yellow) | (5) USB Connector         | (8) Rear Cover   |
| (3) LAN Connector          | (6) Lift Handle           | (9) Power Socket |

### Interior View

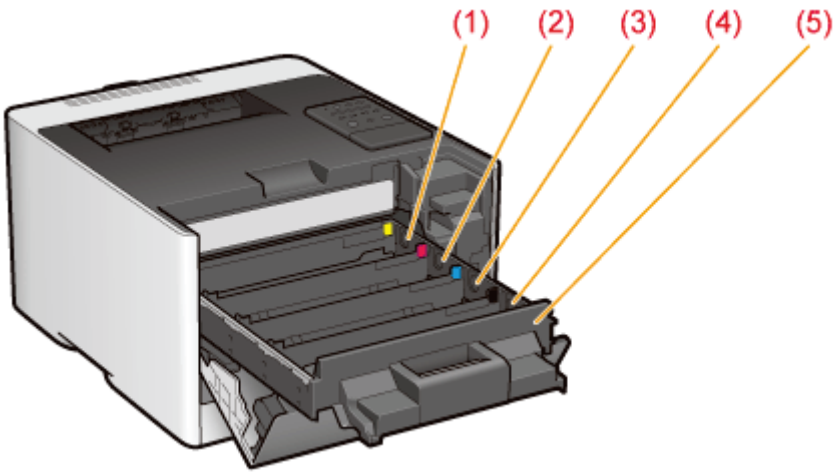

- (1) Y (Yellow) Toner Cartridge Slot
- (2) M (Magenta) Toner Cartridge Slot
- (3) C (Cyan) Toner Cartridge Slot
- (4) K (Black) Toner Cartridge Slot
- (5) Toner Cartridge Tray

### Paper Drawer

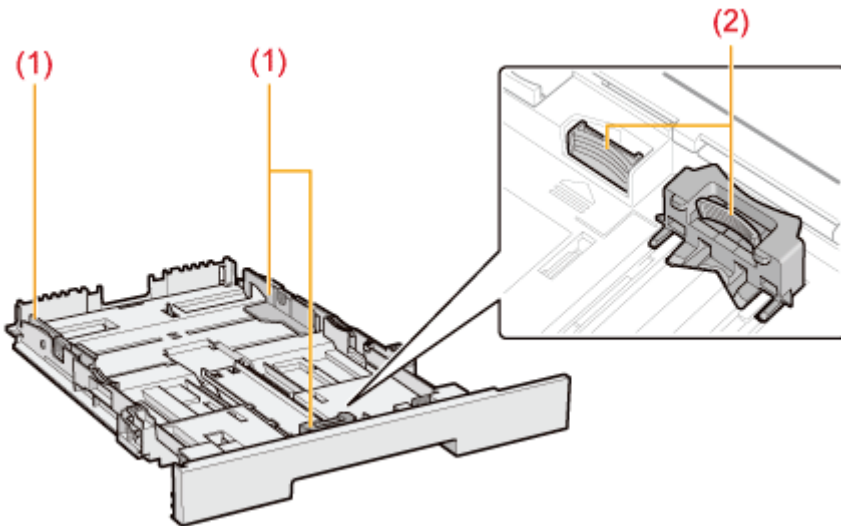

- (1) Paper Guide
- (2) Lock Release Lever

### Dimensions of Each Part

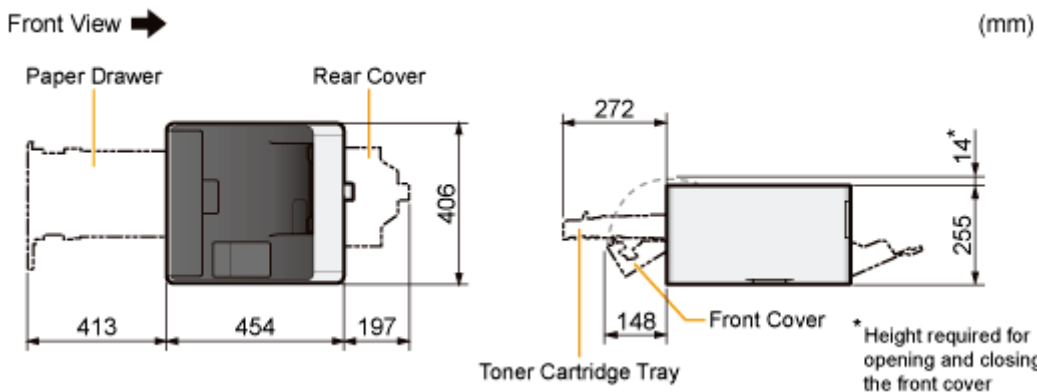



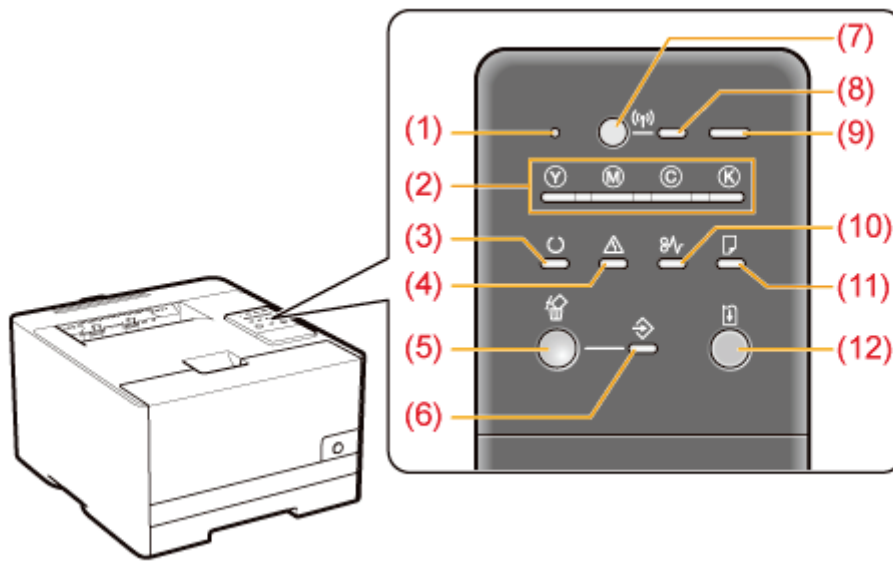





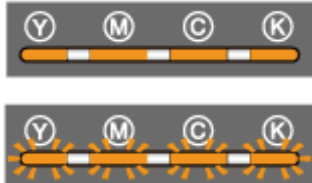





## Control Panel



† Unlike in the above illustration, the indicator names are indicated above the respective icons depending on the country or region.

## Indicators

Name	Status	Solution
<b>(2) Toner Indicator</b>	 <p>(On or Blinking)</p> <p>An error is occurring for the toner cartridges. (Such as when the toner cartridges have reached the end of their life)</p>	<p>Solve the problem following the message displayed in the Printer Status Window.*<sup>1</sup></p> <ul style="list-style-type: none"> <li>❖ "A Message Appears in the Printer Status Window"</li> </ul>
<b>(3) Ready Indicator</b>	 <p>(On)</p> <p>The printer is ready to print.</p>	—
	 <p>(Blinking)</p> <p>The printer is busy printing, preparing to print, or cleaning.</p>	
<b>(4) Alarm Indicator</b>	 <p>(On)</p> <p>A service error is occurring.</p>	<p>Solve the problem following the message displayed in the Printer Status Window.*<sup>1</sup></p> <ul style="list-style-type: none"> <li>❖ "A Message Appears in the Printer Status Window"</li> </ul>
	 <p>An error is occurring.</p>	

	(Blinking)		
<b>(6) Job Indicator</b>	 (On)	A job is being printed or is waiting to be printed.	—
	 (Blinking)	A job is being canceled.	
<b>(8) Wi-Fi Indicator (LBP7110Cw Only)</b>	 (On)	The printer is connected by wireless LAN.	—
	 (Blinking)	The wireless LAN is configured.	
<b>(9) Main Power Indicator</b>	 (On)	The printer is turned ON.	—
	 (Blinking)	The printer is being turned OFF.	
<b>(10) Paper Jam Indicator</b>	 (Blinking)	A paper jam is occurring.	Remove the paper jam. ➤ <a href="#">"Paper Jams"</a>
<b>(11) Load Paper Indicator</b>	 (Blinking)	Paper needs to be checked. (Such as when paper runs out and when paper cannot be fed properly)	Load the paper properly. ➤ <a href="#">"Loading Paper"</a>
<b>(12) Go Indicator</b>	 (Blinking)	An error occurred, but you can ignore the error and continue printing.	To skip the error and continue printing, press the [  ] (Go) key.* <sup>2</sup>

\*<sup>1</sup> For details on the procedure for displaying the Printer Status Window, see "[Printer Status Window](#)."

\*<sup>2</sup> Skipping the error and continuing printing (by pressing the [  ] (Go) key) may cause unexpected print results.

## Button/Keys

Name	Function
<b>(1) Reset Button</b>	Turning ON the printer while pressing this button initializes the system settings.* <sup>1</sup>
<b>(5) Cancel Job Key</b>	Press this key to cancel the job that is currently being printed or a job with an error.* <sup>2</sup>
<b>(7) Wi-Fi Key (LBP7110Cw Only)</b>	Use this key when configuring the wireless LAN connection settings with the Button System (WPS).
<b>(12) Go Key</b>	<ul style="list-style-type: none"> <li>• <b>When the Go indicator is blinking:</b> Press this key to skip the error and continue printing.</li> <li>• <b>When the Job indicator is off:</b></li> </ul>

Press and hold this key (for 3 seconds) when the Ready indicator is on or blinking to print the "User Data List."<sup>\*3</sup>

\*1 For details, see ["Initializing Using the Reset Button."](#)

\*2 For details, see ["Canceling a Print Job Being Printed Using the Cancel Job Key."](#)

\*3 For details, see ["Printing the "User Data List"."](#)







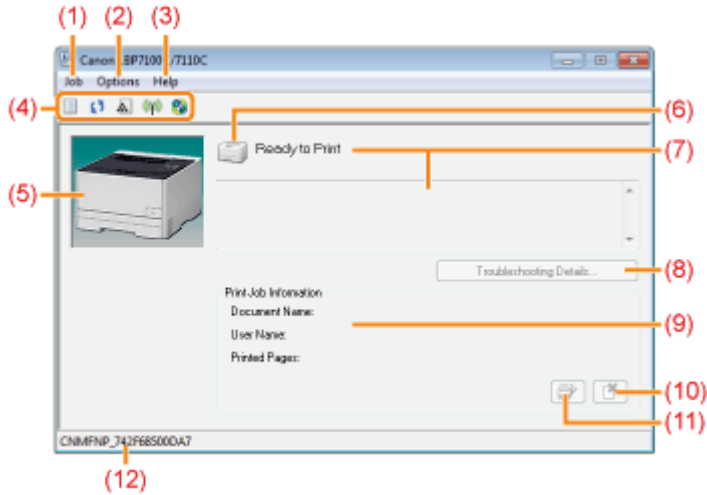

---

# Printer Status Window





The Printer Status Window allows you to check the printer status, perform utility functions, specify the settings for the printer unit, and so on.

† If you are using Macintosh, use the Statusmonitor. (For details on the Statusmonitor, see the Printer Driver Guide for Macintosh (how to display: "For Macintosh Users").)



<p><b>(1) [Job] Menu</b></p>	<p>You can cancel or check a job or resume a job which is paused during printing for some reason.</p>
<p><b>(2) [Options] Menu</b></p>	<p>You can perform utility functions, specify the settings for the printer unit, and so on.</p>
<p><b>(3) [Help] Menu</b></p>	<p>Use this menu to display Help and the version information.</p>
<p><b>(4) Toolbar</b></p>	<p><b>[  ] (Print queue)</b>          Displays the print queue, a function of Windows.          For details on the print queue, see Windows Help.</p> <p><b>[  ] (Refresh)</b>          Obtains the printer status and refreshes the Printer Status Window display.</p> <p><b>[  ] (Consumables Information)</b>          Allows you to check the status of consumables.          ➤ "Checking the Consumables Status"</p> <p><b>[  ] (Wireless LAN Status) (LBP7110Cw Only)</b>          Allows you to check the wireless LAN connection status (signal strength).</p> <p><b>[  ] (Remote UI)</b>          Starts the Remote UI.          ➤ "Remote UI"</p> <p>† If the printer and computer cannot communicate via a network, [  ] (Remote UI) cannot be clicked.</p>
<p><b>(5) Animation Area</b></p>	<p>Displays the printer status using an animated graphic. This area displays the printing progress or error conditions depending on the printer status.</p>
	<p>Displays the printer status.</p> <ul style="list-style-type: none"> <li> The printer is ready to print or in the sleep mode.</li> <li> The printer problems need to be corrected.</li> </ul>



<b>(6) Icon</b>	 Communication cannot be performed with the printer.  A service call is occurring.
<b>(7) Message Area</b>	<p>Displays messages about the printer status.</p> <p>Displays additional information (such as situation explanation and solutions) below the message if an error or other such event occurs.</p>
<b>(8) [Troubleshooting Details]</b>	<p>Allows you to display "Troubleshooting Details" and check details on how to deal with an error depending on the displayed message.</p> 
<b>(9) Job Information Area</b>	Displays information about the job.
<b>(10) [  ] (Cancel Job)</b>	Cancels the current job being printed.
<b>(11) [  ] (Resolve Error)</b>	You can resume a job when it is paused during printing for some reason.
<b>(12) [Status Bar]</b>	Displays the device to which the printer is connected.

 **NOTE**

**For details on each option in the Printer Status Window**

See Help.

 ["How to Use Help"](#)

## Displaying the Printer Status Window

Click [  ] in the Windows task tray, and then select the printer name.



 **NOTE**

**When displaying the Printer Status Window from the printer driver**

Click [  ] (Display Printer Status Window) in locations such as in the [Page Setup] sheet.

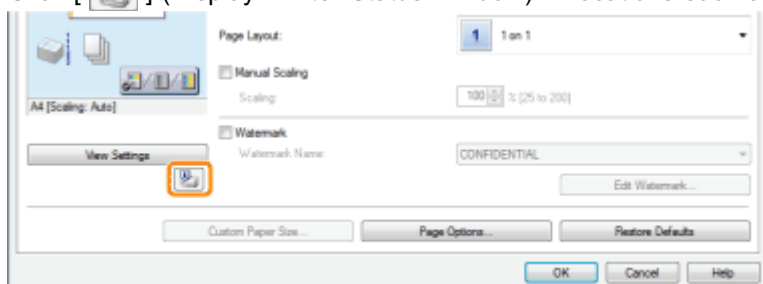

## Displaying the Printer Status Window automatically

The Printer Status Window is displayed automatically under the following situations.

- When an error occurs during printing
  - When the consumables need to be replaced soon during printing
  - When the consumables have reached the end of their life during printing
- † You can change the display settings in the [Preferences (Users)] or [Preferences (Administrators)] dialog box in the Printer Status Window. For more details, see Help.
- ❖ ["How to Use Help"](#)

## Introduction of the Utilities

The following useful utilities are available to perform the printer management and so on.

### Using "Remote UI" to specify the various settings and operate the printer from a remote location

By accessing and operating the printer from the Web browser via a network, you can manage the printer using a computer in a remote location.

You can perform various operations, such as checking the current printer status or job logs and specifying various network settings.

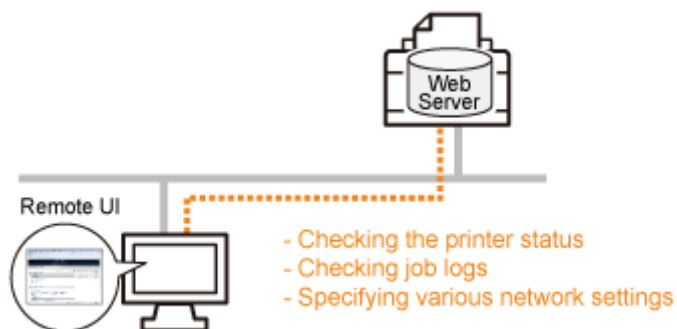

#### No specific software is needed.

The Remote UI can be operated in a Web browser. You do not need specific software to operate the Remote UI.

#### Central management of all the printer settings with the manager password (PIN)

Only the manager can configure the settings or perform the operations related to the printer management by setting the manager password (PIN).

### Using "MF/LBP Network Setup Tool" to specify the initial settings for the network connection

You can initialize the network settings by following the instructions in the wizard.

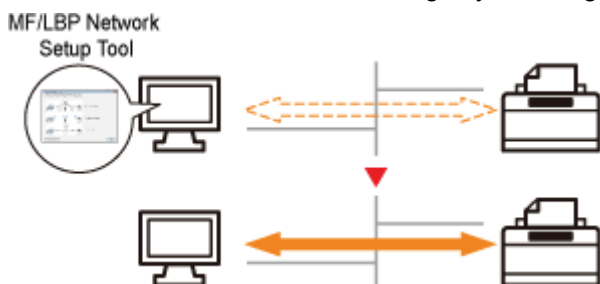

#### Easily navigating the setting procedures

You can easily navigate the setting procedures by using the graphical displays of the wizard.

#### You do not need to install "MF/LBP Network Setup Tool"

"MF/LBP Network Setup Tool" is software included in the supplied CD-ROM. You can start "MF/LBP Network Setup Tool" directly from the CD-ROM without installing it.

## Energy-saving Mode

---

You can reduce power consumption of the printer efficiently by using sleep mode or auto shutdown when the printer is not used for a certain time.

### ⌄ Sleep Mode

---

You can configure the printer to enter the standby mode for low power consumption when data is not sent from the computer or the printer does not operate for a specified time.

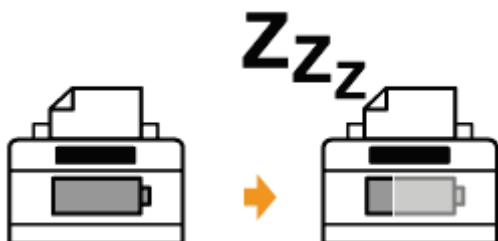

### ⌄ Auto Shutdown

---

You can configure the printer to turn OFF automatically when the time specified for the sleep mode elapses.



# Sleep Mode

You can specify the settings for sleep mode using the following procedure.

1

Click [  ] in the Windows task tray, and then select the printer name.

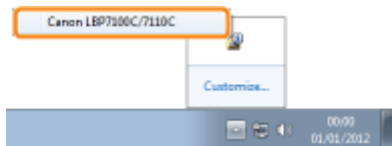

2

From the [Options] menu, select [Device Settings] → [Sleep Settings].

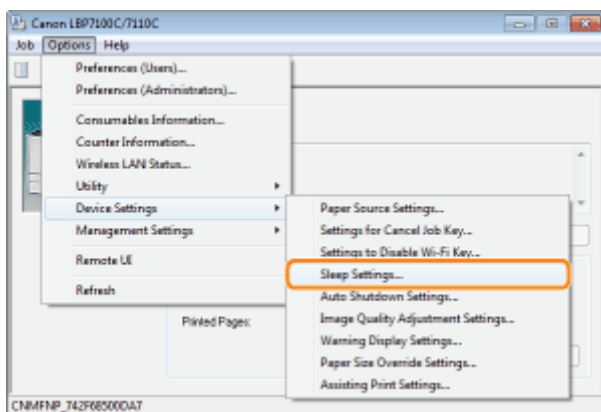

3

Specify the settings for the sleep mode.

- (1) Select the [Enter Sleep Mode after Fixed Period] check box.
- (2) Specify the time until the printer enters the sleep mode in [Enter Sleep Mode After].
- (3) Click [OK].



## NOTE

### About the setting for the time to enter the sleep mode

You can select [1], [5], [10], [15], [30], [60], [90], [120], [150], or [180] minutes for [Enter Sleep Mode After]. The default value is [5] minutes.

† We recommend that you use this option in the default setting.

# Auto Shutdown

You can specify the settings for auto shutdown using the following procedure.

1

Click [  ] in the Windows task tray, and then select the printer name.



2

From the [Options] menu, select [Device Settings] → [Auto Shutdown Settings].

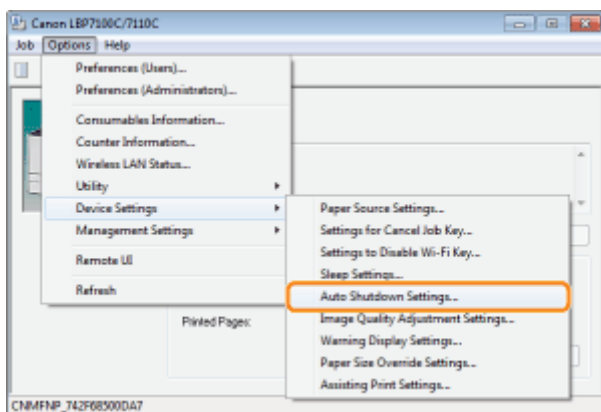

3

Specify the settings for auto shutdown.

- (1) Select the [Auto Shutdown after Fixed Period] check box.
- (2) Specify the time until the printer turns OFF automatically after entering sleep mode in [Auto Shutdown After].
- (3) Click [OK].

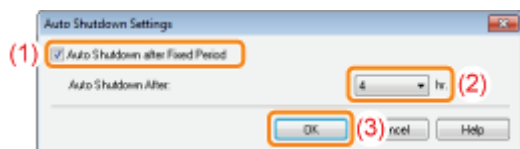

## NOTE

### About the setting for the time to execute auto shutdown

When [Auto Shutdown After] is changed during sleep mode, the specified time to execute auto shutdown is reset. You can specify [Auto Shutdown After] for auto shutdown with 1 hour increments between [1] and [8] hours.

- † If you specify the setting for this option shorter than the default setting, this may shorten the life of the toner cartridges (the default setting is [4] hours).

## Cautions for Handling the Printer

This printer consists of various electronic and precision optical parts. Read the following section so that you can handle the printer properly.

See ["Important Safety Instructions"](#) also.

- Do not place any objects other than printing paper on the printer, trays, or covers. This may result in damage to the printer.

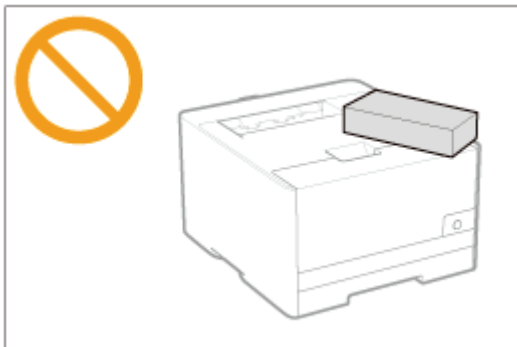

- Avoid shaking the printer. This may result in poor print quality or damage to the printer.



- Do not leave any covers open longer than required. Exposing the printer to direct sunlight or strong light may result in deterioration in print quality.
- Do not open the covers on the printer during printing. This may result in damage to the printer.
- Handle the tray or cover gently. This may result in damage to the printer.
- If you want to put a cover on the printer to prevent dust from entering the printer, turn the power OFF and allow the printer to cool down sufficiently before covering the printer.
- If you do not plan to use the printer for a long period of time, unplug the power plug from the AC power outlet.
- Do not use or store the printer in a room where chemicals are used.

## Consumables

The following consumables are provided for this printer. Purchase them at your local authorized Canon dealer.

Use the following table as rough guides to replace consumables. However, you may need the replacement earlier than the described lifetimes depending on the printer installation environment, paper size, or document type.

Consumables	Replacement Timing	Replacement Method
Canon Cartridge 731 Black	Average yield of the toner cartridge: 1,400 pages *1 *2	➤ "Toner Cartridge Replacement"
Canon Cartridge 731 H Black	Average yield of the toner cartridge: 2,400 pages *1 *2	
Canon Cartridge 731 Yellow Canon Cartridge 731 Magenta Canon Cartridge 731 Cyan	Average yield of Composite Y (Yellow), M (Magenta), and C (Cyan) toner cartridges: 1,500 pages *1 *2	

\*1 The average yield is on the basis of "ISO/IEC 19798"\* when printing A4 size paper with the default print density setting.

\* "ISO/IEC 19798" is the global standard related to "Method for the determination of toner cartridge yield for monochromatic electrophotographic printers and multi-function devices that contain printer components" issued by ISO (International Organization for Standardization).

\*2 When the toner cartridges need to be replaced soon, a message will appear in the Printer Status Window. Also, you can check the toner cartridges status in the [Consumables Information] dialog box in the Printer Status Window.

➤ "Checking the Consumables Status"

### IMPORTANT

#### About replacement toner cartridges

For optimum print quality, using Canon genuine toner cartridges is recommended.

Model Name	Supported Canon Genuine Toner Cartridge
LBP7100Cn/LBP7110Cw	Canon Cartridge 731 Black Canon Cartridge 731 H Black Canon Cartridge 731 Yellow Canon Cartridge 731 Magenta Canon Cartridge 731 Cyan

#### Be careful of counterfeit toner cartridges.

Please be aware that there are counterfeit Canon toner cartridges in the marketplace.

Use of counterfeit toner cartridge may result in poor print quality or machine performance.

Canon is not responsible for any malfunction, accident or damage caused by the use of counterfeit toner cartridge.

For more information, see <http://www.canon.com/counterfeit>.

### NOTE

#### Toner and Toner Cartridge Availability

Toner cartridge for this machine will be available for at least seven (7) years (or any such longer period as required by applicable laws) after production of this machine model has been discontinued.



## Checking the Consumables Status

You can check the current consumables status in the [Consumables Information] dialog box in the Printer Status Window.

† For details on the Printer Status Window, see "[Printer Status Window](#)."

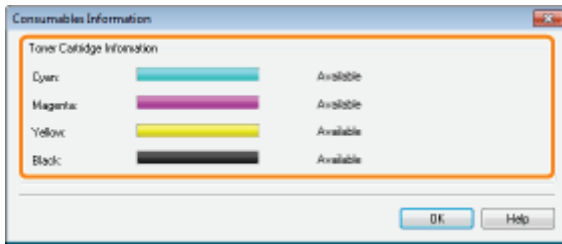

### [Toner Cartridge Information]

You can check the status of the toner cartridges of each color.

Status Bar (Example:Black)	Message	Status	Solution
	Available	Continue using as normal.	—
	Replacement Needed Soon	The toner cartridge is nearing the end of its life.	Have ready replacement toner cartridge. We recommend that you replace the toner cartridge before printing a large amount of data.
	Replace Cartridge	The toner cartridge has reached the end of its life.	Replace the toner cartridge.
		Print quality cannot be guaranteed due to the toner cartridge reaching the end of its life and so on.	Solve the problem following the message displayed in the Printer Status Window. <a href="#">"A Message Appears in the Printer Status Window"</a>
	Insert Cartridge	The toner cartridge is not installed. Wrong color toner cartridge is installed.	Install the toner cartridge properly.

#### NOTE

#### Replacement procedure for the toner cartridges

["Toner Cartridge Replacement"](#)

# Maintenance

---

## ➤ **Toner Cartridge Replacement**

---

- Replacing the Toner Cartridge
- Storing Toner Cartridges

## ➤ **Moving the Printer**

---

## ➤ **Cleaning the Printer**

---

- Adjusting Colors and Correcting Color Mismatches (Calibration/Color Mismatch Correction)
- Cleaning the Inside of the Printer
- Cleaning the Outside of the Printer

## ➤ **Location of the Serial Number**

---

# Toner Cartridge Replacement

Toner cartridges are consumable products. When the toner cartridges are nearing the end of their life, a message will appear in the [Printer Status Window](#). Follow the directions in the message.

† For details on the yield of the toner cartridges or replacement toner cartridges, see "[Consumables](#)."

Message	Solution
 <p>The toner cartridges need to be replaced soon. [&lt;Toner Colors&gt;*] See the instruction manual for more information on how to replace a toner cartridge.</p>	<p>Have ready the replacement toner cartridges of the displayed colors.</p> <p>It is recommended that you replace the toner cartridges before printing a large amount of data.</p> <ul style="list-style-type: none"> <li>✦ "<a href="#">Replacing the Toner Cartridge</a>"</li> </ul>
 <p>Toner cartridges reached lifetime. [&lt;Toner Colors&gt;*] To prevent a device malfunction, replacing these toner cartridges with new toner cartridges is recommended. See the instruction manual for more information on how to replace a toner cartridge.</p>	<p>It is recommended that you replace the toner cartridges of the displayed colors.</p> <ul style="list-style-type: none"> <li>✦ "<a href="#">Replacing the Toner Cartridge</a>"</li> </ul> <p>† You can continue printing as is, however, as this may result in damage to the printer.</p>
 <p>Cannot guarantee print quality because the toner cartridges are reaching the end of their lifetime, etc. [&lt;Toner Colors&gt;*] Replacing these toner cartridges with new toner cartridges is recommended. See the instruction manual for more information on how to replace a toner cartridge.</p>	<p>It is recommended that you replace the toner cartridges of the displayed colors.</p> <ul style="list-style-type: none"> <li>✦ "<a href="#">Replacing the Toner Cartridge</a>"</li> </ul> <p>† You can continue printing as is, however, print quality may deteriorate.</p>
 <p>The toner cartridges have reached the end of their lifetime. [&lt;Toner Colors&gt;*] To prevent a device malfunction, replacing these toner cartridges with new toner cartridges is recommended. Click [Troubleshooting Details] for more information.</p>	<p>Replace the toner cartridges of the displayed colors.</p> <ul style="list-style-type: none"> <li>✦ "<a href="#">Replacing the Toner Cartridge</a>"</li> </ul> <p>† You can continue printing as is by clicking [  ] (Resolve Error), however, as this may result in damage to the printer.</p>
	<p>It is recommended that you replace the toner cartridges of the displayed colors.</p> <ul style="list-style-type: none"> <li>✦ "<a href="#">Replacing the Toner Cartridge</a>"</li> </ul> <p>† You can continue printing as is by clicking [  ]</p>

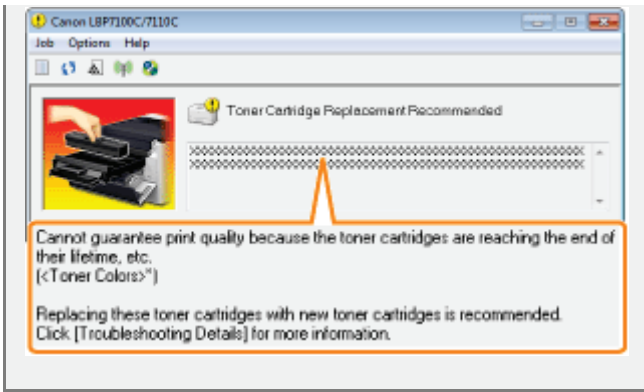

(Resolve Error), however, print quality may deteriorate.

\* <Toner Colors> displays the colors of the toner cartridges targeted for messages. (Multiple colors of the toner cartridges may be displayed.)

**<In cases such as where you do not immediately replace the toner cartridge with a replacement toner cartridge after purchasing it>**

Pay attention to the points described in the following section to store it.

➤ ["Storing Toner Cartridges"](#)

## Attention (Toner Cartridge)

See "Important Safety Instructions" or "Storing Toner Cartridges" also.

### IMPORTANT

#### About replacement toner cartridges

For optimum print quality, using Canon genuine toner cartridges is recommended.

Model Name	Supported Canon Genuine Toner Cartridge
LBP7100Cn/LBP7110Cw	Canon Cartridge 731 Black Canon Cartridge 731 H Black Canon Cartridge 731 Yellow Canon Cartridge 731 Magenta Canon Cartridge 731 Cyan

#### Be careful of counterfeit toner cartridges.

Please be aware that there are counterfeit Canon toner cartridges in the marketplace.

Use of counterfeit toner cartridge may result in poor print quality or machine performance.

Canon is not responsible for any malfunction, accident or damage caused by the use of counterfeit toner cartridge.

For more information, see <http://www.canon.com/counterfeit>.

#### Hold the toner cartridge properly.

When handling the toner cartridge, hold it properly as shown in the figure. Do not place it vertically or upside-down.

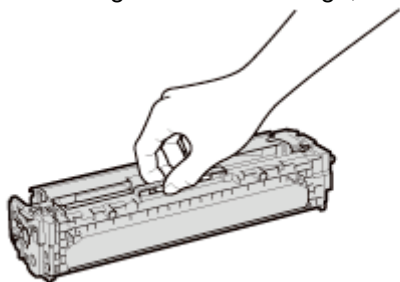

#### Do not touch the electrical contacts (A), the toner cartridge memory (B), or the photosensitive drum (C).

If you touch the electrical contacts (A) or the toner cartridge memory (B), this may result in damage to the cartridge. Also, print quality may deteriorate if you touch or damage the photosensitive drum (C). Do not touch with your hands.

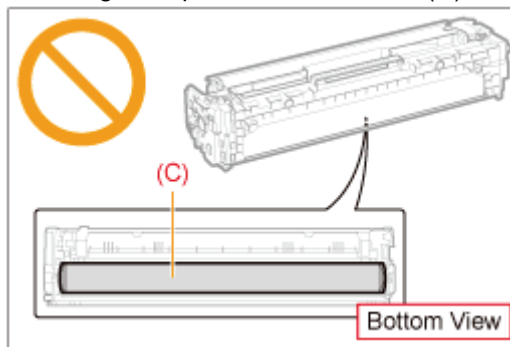
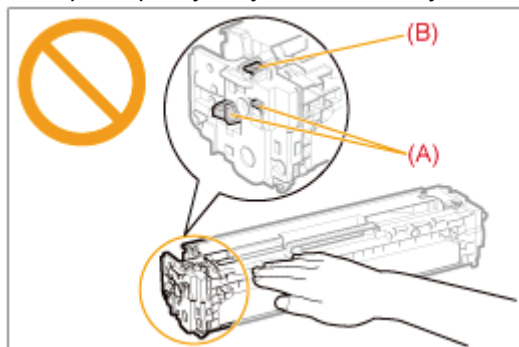

#### Do not touch the high-voltage contacts (D).

If you touch the high-voltage contacts (D), this may result in damage to the printer.

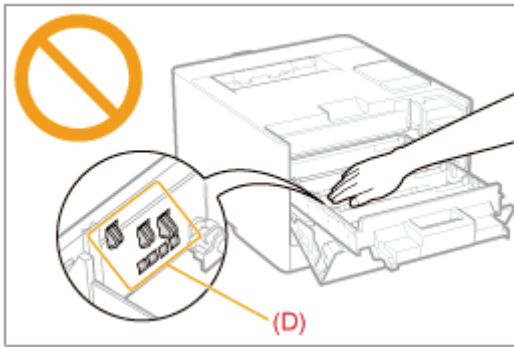

### Precautions when installing toner cartridges

The position of the toner cartridges in the printer is determined by the toner color. Install the toner cartridges in the slots that have labels of the same color.

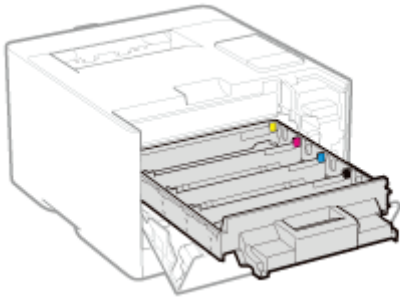

### Other precautions

- Do not expose the toner cartridges to direct sunlight or strong light.
- Do not attempt to disassemble or modify the toner cartridges.
- Condensation (water droplets on the inside or outside) may form on the toner cartridges when they are brought into an environment with a sudden change in temperature or humidity.  
When moving a new toner cartridge to a location with change in temperature, leave the cartridge in the protective bag at the new location for two or more hours to allow it to adjust to the new temperature.
- Do not leave the front cover open for a long time with the toner cartridges installed.
- Keep the toner cartridges away from products that generate magnetic waves, such as a computer or computer display.

### NOTE

#### About the packing materials

The packing materials may be changed in form or placement, or may be added or removed without notice.

# Replacing the Toner Cartridge

† You can check the current toner cartridges status of each color in the [Consumables Information] dialog box in the Printer Status Window.

➤ "Checking the Consumables Status"

Before replacing the toner cartridge, see "Attention (Toner Cartridge)."

**1**

**Open the front cover.**

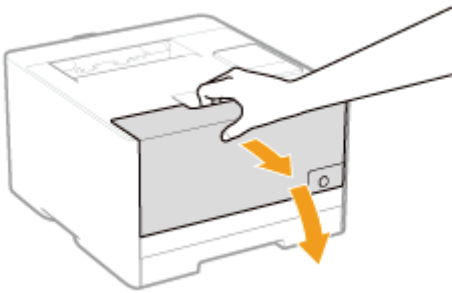

**2**

**Press the lever and pull out the toner cartridge tray.**

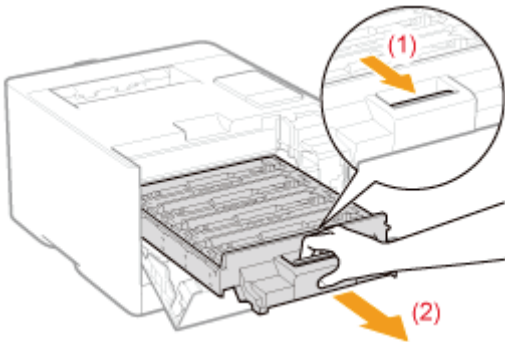

**3**

**Hold the toner cartridge to be replaced by its handle and pull it straight up and out of the printer.**

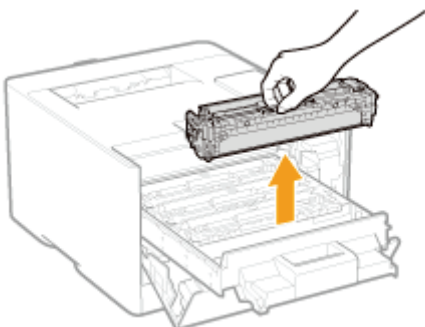

## 4

### Take out the new toner cartridge from the protective bag.

You can open the protective bag with your hands from the notch.

When opening the protective bag with scissors, be careful not to damage the toner cartridge.

- † Keep the protective bag. Do not discard it. You will need it when you remove the toner cartridge for printer maintenance or other purposes.

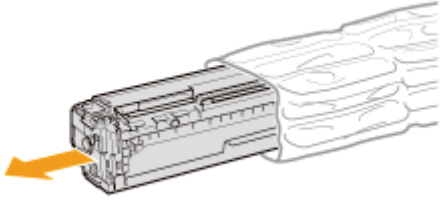

## 5

### Shake the toner cartridge five or six times as shown in the figure to evenly distribute the toner inside the cartridge.

Do not remove the drum protective cover (A).

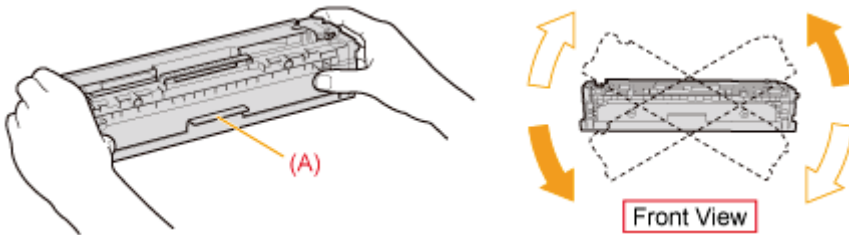

## 6

### Place the toner cartridge on a flat surface.

## 7

### Remove the tab, and then pull out the sealing tape (approx. 50 cm).

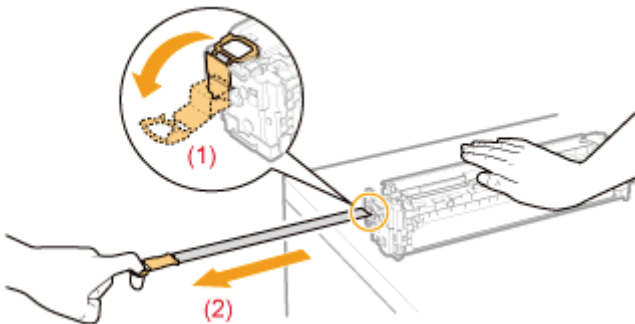

#### IMPORTANT

##### Precautions when pulling out the sealing tape

- Do not pull the sealing tape diagonally, upward, or downward. If the tape is severed, this may become difficult to



pull out completely.

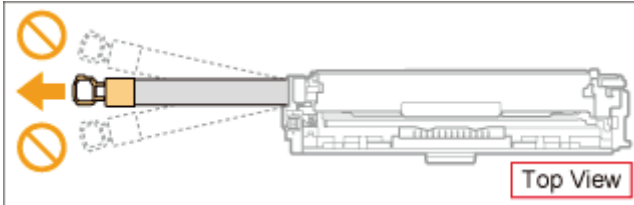

- If the sealing tape stops at midpoint, pull it out of the toner cartridge completely. If any tape remains in the toner cartridge, this may result in poor print quality.
- Dispose of the removed sealing tape according to local regulations.

## 8

### Remove the drum protective cover (A).

† Keep the drum protective cover. Do not discard it. You will need it when you remove the toner cartridge for printer maintenance or other purposes.

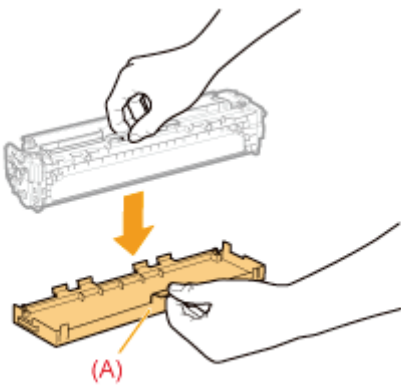

## 9

### Install the toner cartridge.

Be careful not to let the drum impact the frame of the toner cartridge tray.

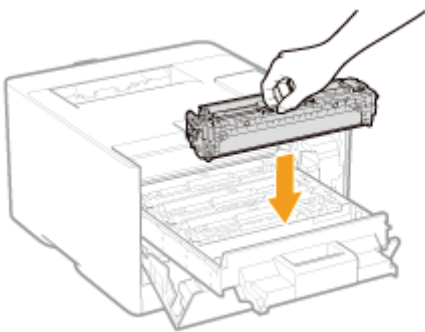

## 10

### Push in the toner cartridge tray.

## 11

### Close the front cover.

**? If you cannot close the front cover**

Make sure that the toner cartridge tray is closed. Do not try to forcefully close the front cover, as this may damage the printer.

---

## Storing Toner Cartridges

Be careful of the following points when storing a new toner cartridge or handling a toner cartridge that was taken out of the printer for maintenance or moving the printer.

### IMPORTANT

#### Precautions when storing toner cartridges

To use toner cartridges in a safe and trouble-free manner, store them in a place that fulfills the following conditions.

- Do not store toner cartridges in a location exposed to direct sunlight.
- Do not store toner cartridges in a location subject to high temperature or humidity or in a location with dramatic changes in temperature or humidity.
  - Storage temperature range: 0 to 35 °C
  - Storage humidity range: 35 to 85% RH (no condensation)
- Do not store toner cartridges in a place where corrosive gases, such as ammonia, are generated, or where a considerable amount of salt is contained in the air, or where there is a lot of dust.
- Keep toner cartridges out of the reach of small children.

#### Store toner cartridges in the same orientation as when they are installed in the printer.

Do not store toner cartridges vertically or upside-down.

#### When removing the toner cartridges which are being used from the printer

Immediately attach the drum protective cover (A) to the toner cartridges and place them into the original protective bag, or wrap them with thick cloth.

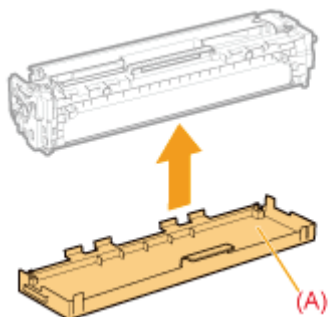

#### About a new toner cartridge

Do not take a new toner cartridge out of the protective bag until it is ready to be used.

### NOTE

#### About condensation

Even within the storable humidity range, water droplets may develop both inside and outside toner cartridges due to the difference in temperature. The formation of water droplets is called condensation.

Condensation will adversely affect the quality of toner cartridges.

## Moving the Printer

When changing the location of the printer or moving the printer for maintenance, be sure to perform the following procedure.

† For details on the installation location, see "[Confirming the Supplied Accessories and Checking the Installation Location.](#)"

See "[Important Safety Instructions](#)" also.

### 1

**Turn the printer OFF, then disconnect the cables or cords from the printer.**

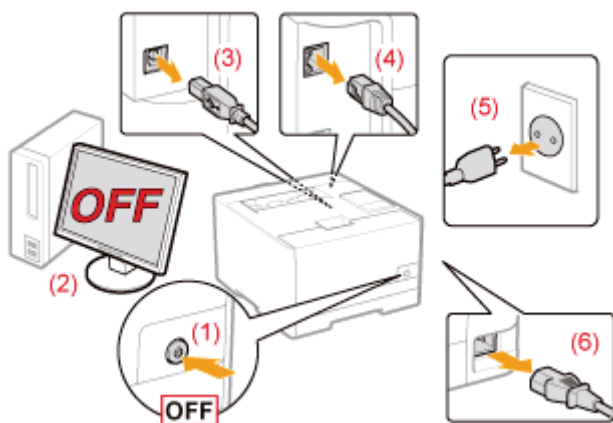

#### <How to disconnect the cable or cord>

USB cable*	(2) Turn the computer off. (3) Disconnect the cable from the printer.
LAN cable*	(4) Disconnect the cable from the printer.
Power cord	(5) Disconnect the power plug from the AC power outlet. (6) Disconnect the cable from the printer.

\* Whether the cable is connected or not varies depending on your environment.

### 2

**Pull out the paper drawer.**

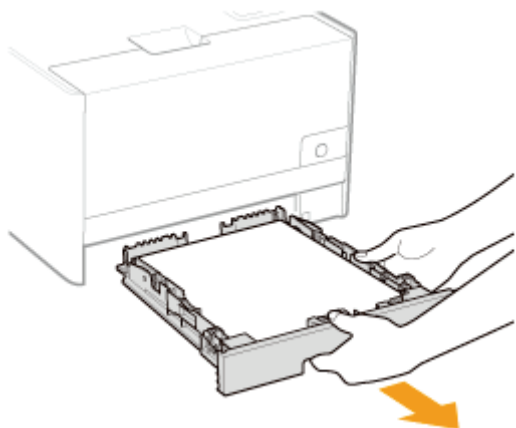

### 3

#### Carry the printer unit to the installation location.

Carry the printer by holding it by the lift handles from the front side.  
Check the weight of the printer, and carry the printer carefully.

➤ "Printer Specifications"

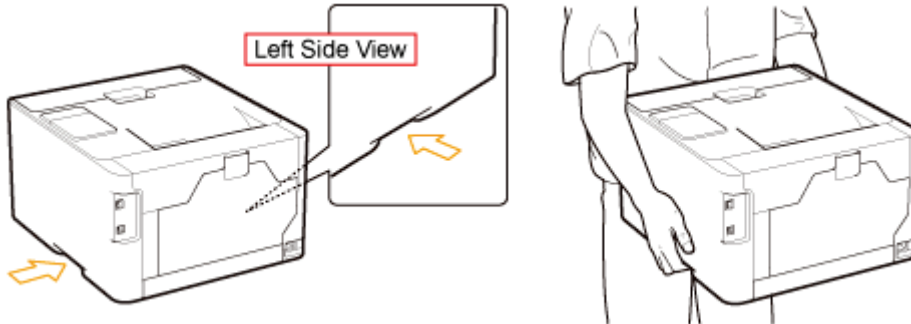

### 4

#### Set the paper drawer in the printer.

### 5

#### Connect the removed cable or cord.

##### <How to connect the cable or cord>

USB cable*	Connect to the USB connector on the printer.
LAN cable*	Connect to the LAN connector on the printer.
Power cord	(1) Plug the power cord to the power socket on the printer. (2) Plug the power plug into the AC power outlet.

\* Whether the cable is connected or not varies depending on your environment.

#### When transporting the printer unit

To prevent damage to the printer during transport, perform the following.

- **Remove the toner cartridges.**

† See "Storing Toner Cartridges" also.

- **Securely pack the printer in the original box with packing materials in the box.**

† If the original box and packing materials in the box are not available, find an appropriate box along with packing materials and pack the printer and the parts appropriately.

## Cleaning the Printer

---

### Adjusting Colors and Correcting Color Mismatches (Calibration/Color Mismatch Correction)

---

Perform calibration or color mismatch correction when the colors have changed or color mismatches have occurred and the data is not printed in the correct colors (specified colors).



### Cleaning the Inside of the Printer

---

If the printed paper has smudge marks or the print quality has deteriorated, clean the inside of the printer. Cleaning the inside of the printer can prevent print quality deterioration.

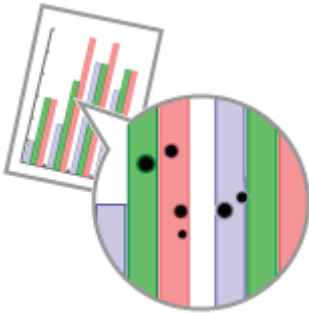

### Cleaning the Outside of the Printer

---

Periodically clean the outer surfaces and ventilation slots of the printer to maintain the optimal printing quality.



# Adjusting Colors and Correcting Color Mismatches (Calibration/Color Mismatch Correction)

---

## Adjusting Color (Calibration)

---

Perform calibration of the printer when the colors have changed and the data is not printed in the correct colors (specified colors).

## Correcting Color Mismatches (Color Mismatch Correction)

---

Perform color mismatch correction of the printer when color mismatches have occurred and the data is not printed in the correct colors (specified colors).

### NOTE

#### **Performing calibration or color mismatch correction at the designated time or immediately after the printer is turned ON**

You can set the printer to automatically perform calibration at the designated time every day or to perform calibration or color mismatch correction immediately after the printer is turned ON.

 ["Auto Image Quality Adjustment Settings"](#)

# Adjusting Color (Calibration)

This section describes the procedure for performing calibration manually.

## IMPORTANT

### Precautions when performing calibration

- If you perform calibration frequently, this may affect the life of the toner cartridges.
  - Perform calibration after making sure that the toner remains in the toner cartridges.
- † You can check the current toner cartridges status of each color in the [Consumables Information] dialog box in the Printer Status Window.
- "Checking the Consumables Status"
- † If you perform calibration in the state where the toner cartridges have reached the end of their life, calibration may not finish properly. In this case, replace the toner cartridges, and then perform calibration again.
- "Toner Cartridge Replacement"

## 1

Click [  ] displayed in the task tray, and then select a printer name.



## 2

From the [Options] menu, select [Utility] → [Calibration].

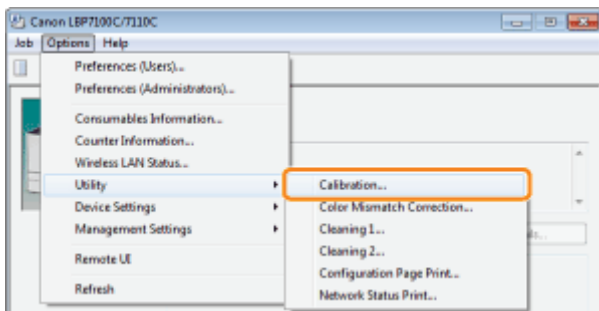

## 3

Click [OK].

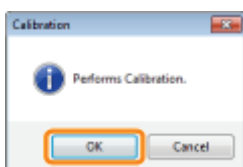

## NOTE

### Calibration time

It takes approximately 130 seconds.





# Correcting Color Mismatches (Color Mismatch Correction)

This section describes the procedure for performing color mismatch correction manually.

## IMPORTANT

### Precautions when correcting color mismatches

- If you perform color mismatch correction frequently, this may affect the life of the toner cartridges.
  - Perform color mismatch correction after making sure that the toner remains in the toner cartridges.
- † You can check the current toner cartridges status of each color in the [Consumables Information] dialog box in the Printer Status Window.
- "Checking the Consumables Status"
- † If you perform color mismatch correction in the state where the toner cartridges have reached the end of their life, color mismatch correction may not finish properly. In this case, replace the toner cartridges, and then perform color mismatch correction again.
- "Toner Cartridge Replacement"

## 1

Click  displayed in the task tray, and then select a printer name.



## 2

From the [Options] menu, select [Utility] → [Color Mismatch Correction].

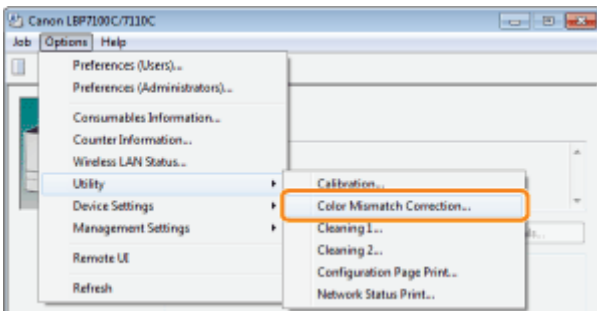

## 3

Click [OK].

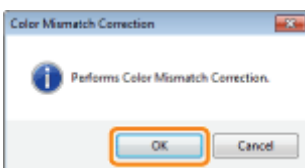

## NOTE

**Color mismatch correction time**

It takes approximately 60 seconds.

---

# Auto Image Quality Adjustment Settings

You can use the following procedure to set the printer to automatically perform calibration at the designated time everyday or to perform calibration or color mismatch correction immediately after the printer is turned ON.

1

Click [  ] displayed in the task tray, and then select a printer name.



2

From the [Options] menu, select [Device Settings] → [Image Quality Adjustment Settings].

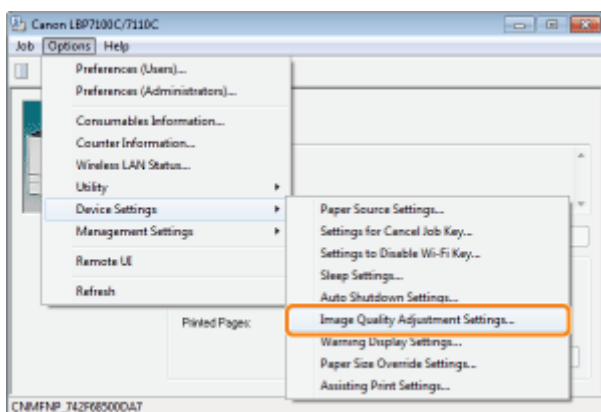

3

Specify the auto image quality adjustment settings.

**When performing calibration automatically at the designated time everyday**

- (1) Select the [Use Periodical Calibration Timer] check box.
- (2) Specify the time to perform calibration in [Time].

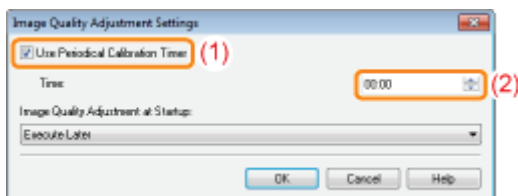

## ? If calibration is not automatically performed

When the printer is under the following circumstances, calibration is not performed even if [Use Periodical Calibration Timer] is specified.

- When the printer is busy printing or an error is occurring
- When the time specified in [Time] has come within 30 minutes after performing calibration last time (Calibration is performed if the power of the printer is cycled before the specified time.)

## When you perform calibration or color mismatch correction immediately after the printer is turned ON

Select [Execute Immediately (Level 1)] or [Execute Immediately (Level 2)] in [Image Quality Adjustment at Startup].

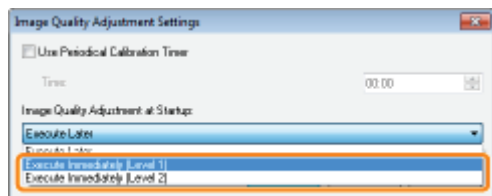

[Execute Immediately (Level 1)]	Only color mismatch correction is performed immediately after the printer is turned ON.
[Execute Immediately (Level 2)]	Calibration and color mismatch correction are performed immediately after the printer is turned ON.

- † When calibration or color mismatch correction is performed immediately after the printer is turned ON, extra time is required until the printer is ready to print.
- † If eight or more hours has elapsed from the time the printer entered the sleep mode until the time the sleep mode was canceled, calibration or color mismatch correction will be performed according to the [Image Quality Adjustment at Startup] setting when the sleep mode is canceled.  
(Depending on your environment, calibration or color mismatch correction may be performed even if less than eight hours has elapsed.)

### **?** If calibration or color mismatch correction is not automatically performed

- Depending on the internal state of the printer, even if [Execute Immediately (Level 1)] or [Execute Immediately (Level 2)] is selected, calibration or color mismatch correction may not be performed immediately after the printer is turned ON.
- If less than eight hours has elapsed from the time the printer was turned OFF until the time the printer was turned ON again, calibration or color mismatch correction may not be performed immediately after the printer is turned ON.

## 4

Click [OK].

# Cleaning the Inside of the Printer

---

## ▣ Cleaning the Fixing Roller of the Printer

---

If the printed paper has smudge marks, clean the fixing roller of the printer.

## ▣ Cleaning the Transfer Belt of the Printer

---

If the transfer belt of the printer has dirt, this may result in deterioration in print quality. In this case, clean the transfer belt.

---

# Cleaning the Fixing Roller of the Printer

† A4 plain paper is required to clean the fixing roller. Have A4 plain paper ready.

## 1

**Load A4 plain paper in the paper drawer.**

➤ "Loading Paper"

## 2

**Click [ ] in the Windows task tray, and then select the printer name.**



## 3

**From the [Options] menu, select [Utility] → [Cleaning 1].**

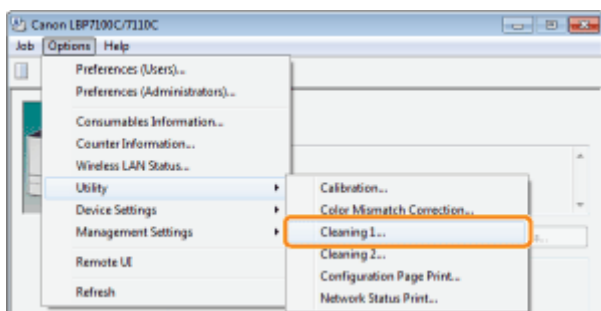

## 4

**Click [OK].**

→ The paper is fed into the printer, and the printer starts cleaning the fixing roller.

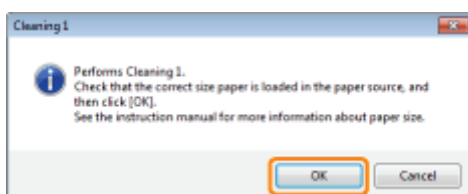

### NOTE

#### Cleaning time

It takes approximately 30 seconds.

† Cleaning the fixing roller cannot be canceled. Please wait until it is completed. (The cleaning is finished when the paper is output completely.)





# Cleaning the Transfer Belt of the Printer

1

Click [  ] in the Windows task tray, and then select the printer name.



2

From the [Options] menu, select [Utility] → [Cleaning 2].

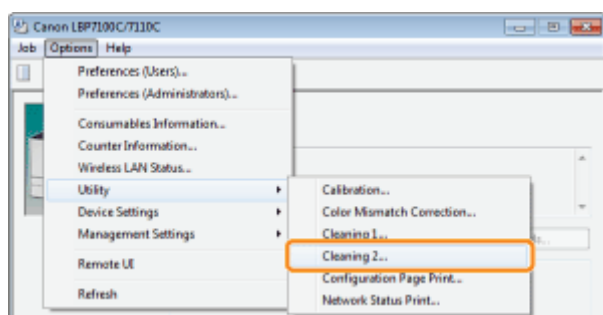

3

Click [OK].

→ The message <Cleaning> appears in the Printer Status Window, and the printer starts cleaning the transfer belt.

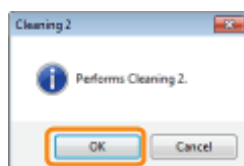

## NOTE

### **Cleaning time**

It takes approximately 50 seconds.

↑ Cleaning the transfer belt cannot be canceled. Please wait until it is completed.

# Cleaning the Outside of the Printer

Before cleaning the outside of the printer, see "Attention (Cleaning)."

## 1

**Turn the printer OFF, then disconnect the cables or cords from the printer.**

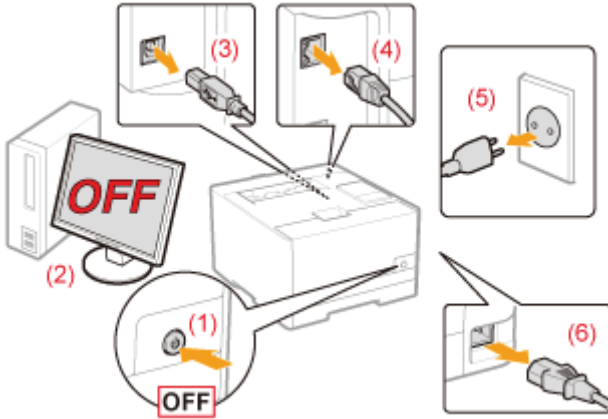

### <How to disconnect the cable or cord>

USB cable*	(2) Turn the computer off. (3) Disconnect the cable from the printer.
LAN cable*	(4) Disconnect the cable from the printer.
Power cord	(5) Disconnect the power plug from the AC power outlet. (6) Disconnect the cable from the printer.

\* Whether the cable is connected or not varies depending on your environment.

## 2

**Firmly wring a soft cloth dampened with water or a mild detergent diluted with water, and wipe off the dirt.**



## 3

**After wiping off the dirt, wipe the printer with a dry cloth.**

# 4

**When the printer is completely dry, connect the removed cable or cord.**

## <How to connect the cable or cord>

USB cable*	Connect to the USB connector on the printer.
LAN cable*	Connect to the LAN connector on the printer.
Power cord	(1) Plug the power cord to the power socket on the printer. (2) Plug the power plug into the AC power outlet.

\* Whether the cable is connected or not varies depending on your environment.

## Attention (Cleaning)

---

See "Important Safety Instructions" also.

### **IMPORTANT**

#### **Precautions when cleaning the outside of the printer**

- Do not use a cleaning agent other than water or a mild detergent diluted with water, as this may deform or crack the plastic materials in the printer.
- When using a mild detergent, be sure to dilute it with water.  
Also, if you use a mild detergent for cleaning, be sure to wipe away the detergent with a soft cloth dampened with water.
- Grease or oil does not have to be applied to this printer. Do not apply grease or oil.

## Location of the Serial Number

The serial number is required for receiving maintenance service.  
You can find the serial number at the location shown in the following figure.

† Do not remove the labels on which the serial number is indicated.

### Rear of the printer

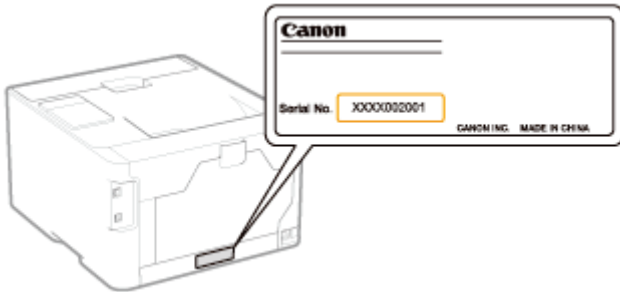

### Outside view of the packaging box

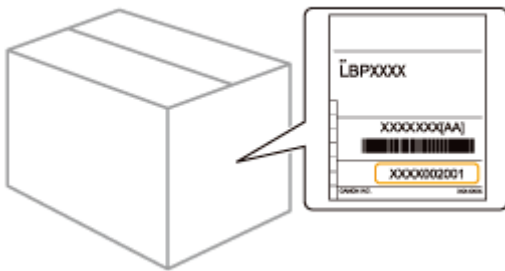

# Printer Installation

When installing the printer, perform the following procedures.

Before installing the printer, see "Attention (Printer Installation)."

<b>1</b>	<b>Checking before Installing the Printer</b> <ul style="list-style-type: none"><li>• Confirming the Supplied Accessories</li><li>• Checking the Installation Location</li></ul>	<a href="#">"Confirming the Supplied Accessories and Checking the Installation Location"</a>
<b>2</b>	<b>Removing the Packing Materials</b>	<a href="#">"Removing the Packing Materials"</a>
<b>3</b>	<b>Installing the Printer</b> <ul style="list-style-type: none"><li>• Carrying the Printer to the Installation Location</li><li>• Connecting the Power Cord</li></ul>	<a href="#">"Installing the Printer"</a>
<b>4</b>	<b>Loading Paper</b>	<a href="#">"Loading Paper"</a>
<b>5</b>	<b>Installing the Printer Driver</b>	<a href="#">"Installing the Printer Driver"</a>
<b>6</b>	<b>Registering the Paper Size and Type</b>	<a href="#">"Registering the Paper Size and Type"</a>
<b>7</b>	<b>Checking the Printing Operation</b>	Check the operations by Configuration Page Print. <a href="#">"Checking the Printer Settings"</a>

## Attention (Printer Installation)

See "Important Safety Instructions" also.

### IMPORTANT

#### Protecting the printer from condensation

- To prevent condensation from forming inside the printer in the following cases, adjust the printer to the ambient temperature and humidity for at least two hours before use.
  - When the room where the printer is installed is heated rapidly
  - When the printer is moved from a cool or dry location to a hot or humid location
- If water droplets (condensation) form inside the printer, this can result in paper jams or poor print quality.

#### Precautions for the power supply

- Use an AC power outlet exclusively for the printer. Do not use the other sockets of the AC power outlet.
- Do not plug the power plug into the auxiliary outlet on a computer.
- Do not use the same AC power outlet for both the printer and any of the following equipment.
  - Copy machine
  - Air conditioner
  - Shredder
  - Equipment that consumes a large amount of electricity
  - Equipment that generates electrical noise
- The maximum power consumption of the printer is 800 W or less.
- Electrical noise or a dramatic drop in mains voltage may cause the printer or computer to operate incorrectly or lose data.

#### Do not install the printer in the following locations, as this may result in damage to the printer.

- A location subject to dramatic changes in temperature or humidity
- A location subject to condensation
- A poorly ventilated location  
(If you use the printer for a long time or to perform a large amount of printing in a poorly ventilated room, the ozone or other odors generated by the printer may create an uncomfortable working environment. In addition, chemical particles are dispersed during printing. Therefore, it is important to provide adequate ventilation.)
- A location near equipment that generates magnetic or electromagnetic waves
- A laboratory or location where chemical reactions occur
- A location exposed to salt air, corrosive gases, or toxic gases
- A location, such as on a carpet or mat, that may warp from the weight of the printer or where the printer is liable to sink

#### Precautions when preparing the toner cartridge

- If the sealing tape stops at midpoint, pull it out of the toner cartridge completely. If any tape remains in the toner cartridge, this may result in low print quality.
- For details on the other precautions, see "[Attention \(Toner Cartridge\)](#)."

#### Precautions when connecting the power cord

- Do not plug the power plug of the printer into an auxiliary outlet on a computer.
- One AC power outlet should be used exclusively for the printer.
- Do not connect this printer to an uninterruptible power source.  
This may cause printer malfunction or breakdown in the event of a power failure.

#### When turning ON the printer for the first time after the printer installation

- Before turning ON the printer, be sure to remove the sealing tape from the toner cartridges installed in the printer.
- Before turning ON the printer, be sure to insert the paper drawer in the printer.
- Although a sheet of blank paper may be output, this is not an error.

### NOTE

#### About the consumables included with this printer

- The replacement timing of the included consumables is as follows.

K (Black) Toner Cartridge	Average yield of the toner cartridge: 800 pages*
Y (Yellow) Toner Cartridge M (Magenta) Toner Cartridge C (Cyan) Toner Cartridge	Average yield of Composite Y (Yellow), M (Magenta), and C (Cyan) toner cartridges: 800 pages*

\* The average yield is on the basis of "ISO/IEC 19798"<sup>\*\*</sup> when printing A4 size paper with the default print density setting.

\*\* "ISO/IEC 19798" is the global standard related to "Method for the determination of toner cartridge yield for color printers and multi-function devices that contain printer components" issued by ISO (International Organization for Standardization).

- For purchasing consumables, see "[Consumables](#)."







# Confirming the Supplied Accessories and Checking the Installation Location

## Confirming the Supplied Accessories

Make sure that all the supplied accessories are contained in the box before installing the printer.

If an item is missing or damaged, please contact your local authorized Canon dealer.

- |   |  |
|---|--|
| <br><input type="checkbox"/> Printer<br>The following parts are already installed.<br>- Paper Drawer<br>- Toner Cartridges   | <br><input type="checkbox"/> Power Cord<br>(The form of the supplied power cord may differ from the one in the above illustration.) |
| <br><input type="checkbox"/> CD-ROMs: "User Software"<br>The following are included.<br>- Printer Driver<br>- MF/LBP Network Setup Tool<br>- e-Manual<br>- Getting Started Guide<br>(Arabic, Bulgarian, Croatian, Czech, Estonian, Greek, Hungarian, Latvian, Lithuanian, Persian, Portuguese, Romanian, Slovakian, Slovenian, Turkish, Ukrainian) | <br><input type="checkbox"/> USB Cable<br>(LBP7110Cw Only)  |
|   | <br><input type="checkbox"/> Quick Setup Guide  |

### NOTE

#### **This printer includes two "User Software" CD-ROMs.**

You can use either CD-ROM.

#### **About interface cables**

- LBP7110Cw comes with a USB cable.

† When you connect a USB cable and specify the settings using "MF/LBP Network Setup Tool", use the supplied USB cable.

When you use LBP7100Cn or this printer with a method other than USB connection, have an appropriate interface cable available for the computer you are using or the connecting method.

- Use a USB cable with the following symbol.



## About the Supplied Manuals

The manuals supplied with this printer consist of the following. Read these manuals according to your purpose and make full use of this printer.

Manual Name	Contents
<b>Quick Setup Guide</b>	Explains the procedure for installing the printer.
<b>e-Manual</b>	Explains all the operations of this printer, such as how to use the printer and troubleshooting. (The contents of "Quick Setup Guide" are also included.)
	This is the simple manual (PDF format) written in the following languages. -

## Getting Started Guide

– Arabic, Bulgarian, Croatian, Czech, Estonian, Greek, Hungarian, Latvian, Lithuanian, Persian, Portuguese, Romanian, Slovakian, Slovenian, Turkish, Ukrainian

† To view the manual in PDF format, Adobe Reader/Adobe Acrobat Reader is required.  
If Adobe Reader/Adobe Acrobat Reader is not installed on your system, download it from the Adobe Systems Incorporated Web site.

## Checking the Installation Location

In order to use this printer in a safe and trouble-free manner, install the printer in a place that fulfills the following conditions.

### Temperature and Humidity Conditions

Temperature range	10 to 30 °C (50 to 86 °F)
Humidity range	20 to 80 % RH (no condensation)

### Power Supply Requirements

220 to 240 V ( $\pm 10\%$ ), 50/60 Hz ( $\pm 2$  Hz)

### Installation Requirements

- A location with sufficient space

† Refer to the following dimensions of each part and ensure the installation space. (Secure space more than 100 mm on the right side.)

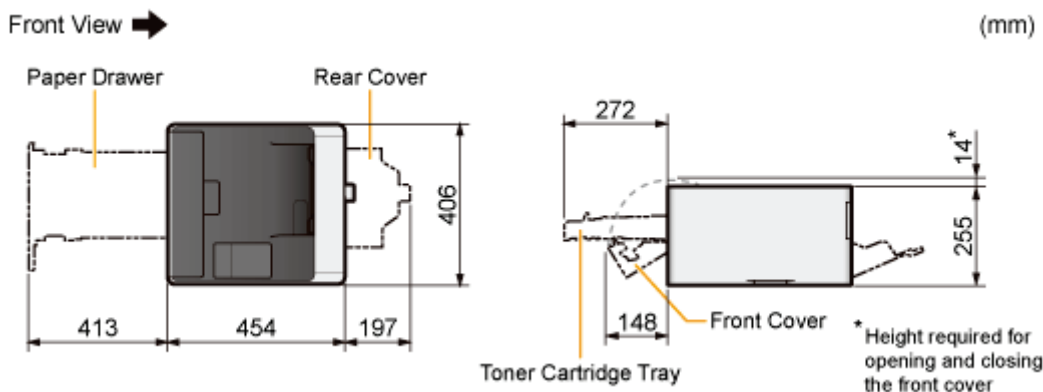

- A location with good ventilation
- A location with a flat, even surface
- A location able to fully support the weight of the printer

## Removing the Packing Materials

### NOTE

#### **Store the packing materials come up during unpacking.**

The box comes with when you purchased the printer and the packing materials in the box are required when transporting the printer for relocation or maintenance.

#### **About the packing materials**

The packing materials may be changed in form or placement, or may be added or removed without notice.

**Remove all the orange tape if it is attached to the printer when performing the following procedure.**

**1**

**Open the rear cover.**

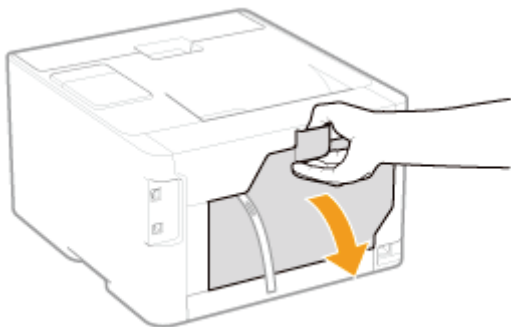

**2**

**Remove the packing material with tape on the transfer roller.**

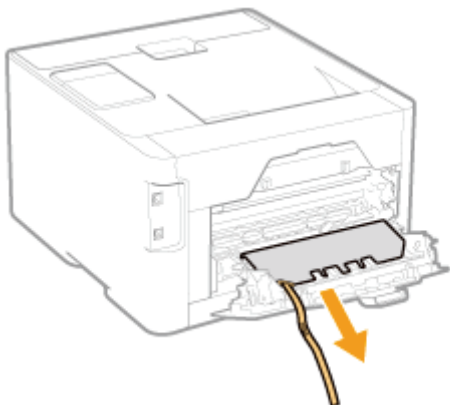

**3**

**Close the rear cover.**

**4**

**Open the front cover.**

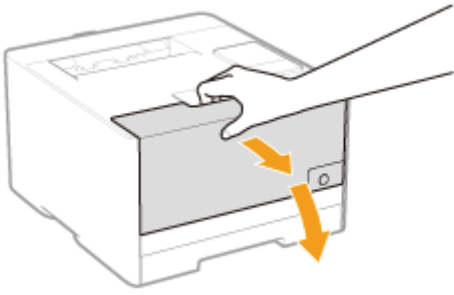

**5**

**Press the lever and pull out the toner cartridge tray.**

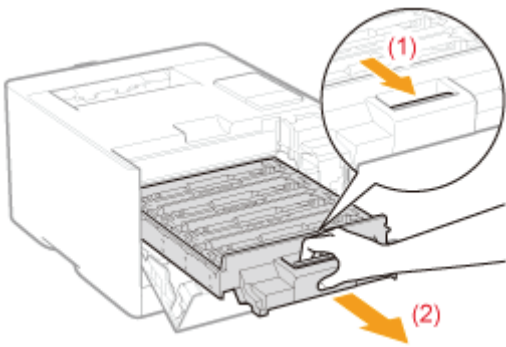

**6**

**Hold down the toner cartridge as shown in the figure.**

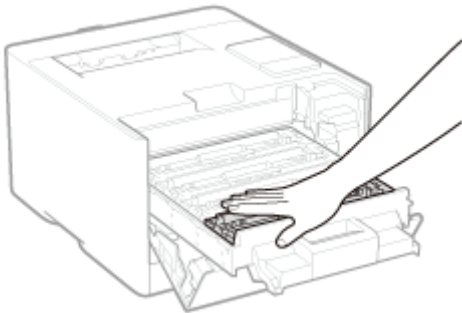

**7**

**Remove the tab, and then pull out the sealing tape (approx. 50 cm).**

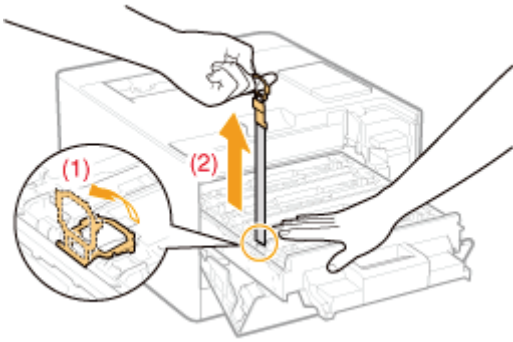

## **IMPORTANT**

### **Precautions when pulling out the sealing tape**

- Do not pull out the sealing tape in the direction other than the arrow. If the tape is severed, this may become difficult to pull out completely.
- If the sealing tape stops at midpoint, pull it out of the toner cartridge completely. If any tape remains in the toner cartridge, this may result in poor print quality.
- Dispose of the removed sealing tape according to local regulations.

## **8**

### **Pull out the sealing tapes of all the toner cartridges.**

Make sure that all four pieces of sealing tape have been removed.

## **9**

### **Push in the toner cartridge tray.**

## **10**

### **Close the front cover.**

#### **? If you cannot close the front cover**

Make sure that the toner cartridge tray is closed. Do not try to forcefully close the front cover, as this may damage the printer.

#### **✓ Check !**

#### **Checking if the packing materials are removed**

Make sure that the following packing materials are completely removed.



Packing material with tape

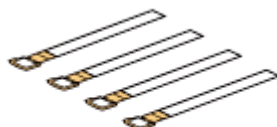

Sealing tape x 4

† Dispose of the above packing materials according to local regulations.

† Make sure that all the orange tape is completely removed.

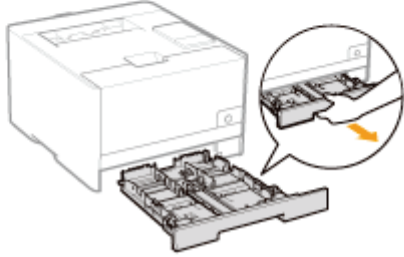
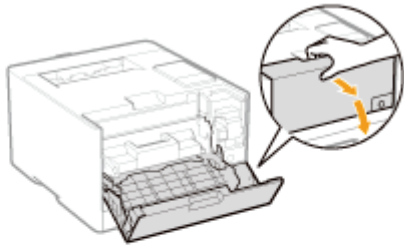

† Close the covers and insert the paper drawer after you finish checking.

Next, install the printer.  
➤ "Installing the Printer"

# Installing the Printer

## Carrying the Printer to the Installation Location

1

**Pull out the paper drawer of the printer.**

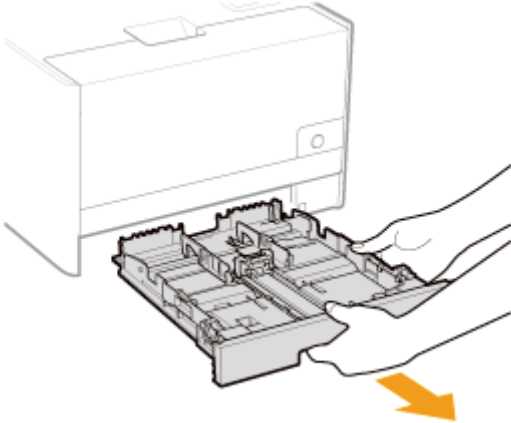

2

**Carry the printer unit to the installation location.**

Carry the printer by holding it by the lift handles from the front side.  
Check the weight of the printer, and carry the printer carefully.

❖ ["Printer Specifications"](#)

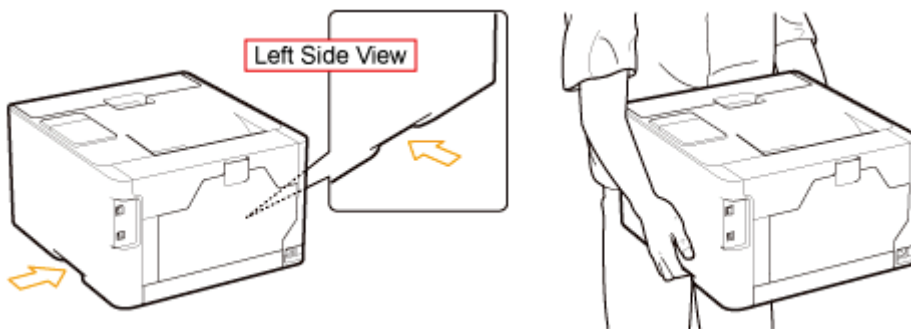

3

**Insert the paper drawer in the printer.**

## Connecting the Power Cord

1

**Connect the power cord.**

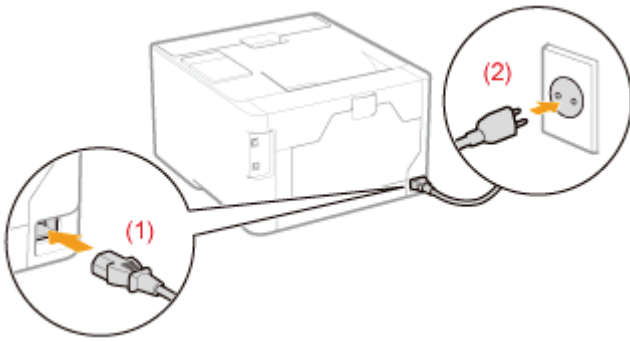

**NOTE**

**The form of the supplied power cord**

The form of the supplied power cord may differ from the one in the above illustration.

Next, perform the following procedures.

<b>1</b>	<b>Loading Paper</b>	➤ "Loading Paper"
<b>2</b>	<b>Installing the Printer Driver</b>	➤ "Installing the Printer Driver"
<b>3</b>	<b>Registering the Paper Size and Type</b>	➤ "Registering the Paper Size and Type"
<b>4</b>	<b>Checking the Printing Operation</b>	Check the operations by Configuration Page Print. ➤ "Checking the Printer Settings"



## **Driver Installation**

---

[↳ Installing the Printer Driver](#)

[↳ Uninstalling the Printer Driver](#)

---

## Installing the Printer Driver

The printer driver is software required for printing with this printer.

† For details on the system environment required to use the printer driver, see "[System Requirements for Printing](#)."

The procedure for installing the printer driver varies depending on the system environment. See the following according to your system environment.

### If You Use the Printer by Direct Connection



It is recommended that normally the printer driver be installed using "Easy Installation" on the supplied CD-ROM (CD-ROM Setup).

You can specify the printer connection settings and install the printer driver using "Easy Installation" as a series of operations. The e-Manual is also installed simultaneously.

#### [Easy Installation](#)

#### NOTE

##### **Installing the printer driver with Plug and Play (USB connection)**

See "[Basic Operations/Various Information for Windows](#)."

† If you are using Windows 7 or Server 2008 R2, install the printer driver using "Easy Installation."  
(You may not be able to install the printer driver properly due to the Windows restriction even after detecting the printer with Plug and Play.)

##### **Setting a port and installing the printer driver from the printer folder (network connection)**

See "[Setting a Port and Installing the Printer Driver](#)."

† To specify the connection settings, see "[Specifying the Connection Settings](#)."

### If You Use the Printer with via the Print Server

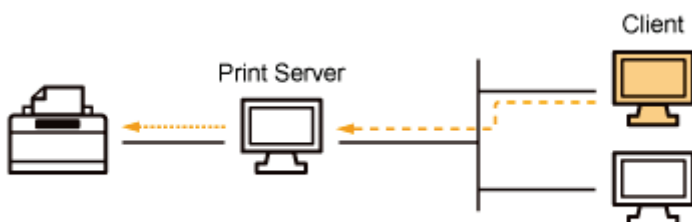

There are two ways to install the printer driver: local installation and download installation.

## Local Installation

You can install the printer driver using the supplied CD-ROM. The e-Manual is also installed simultaneously in "Easy Installation."

### [Easy Installation](#)

## Download Installation

You can install the printer driver without using the supplied CD-ROM, but by downloading the printer driver from the print server.

There are the following two ways to download and install the printer driver.

### [Installing from the Printer Folder](#)

### [Installing from \[Windows Explorer\]](#)

#### NOTE

##### **Precautions when downloading and installing the printer driver**

If a 64-bit operating system is running on the print server, the download installation for a client computer on which any of the following 32-bit operating systems is running is not supported due to the Windows restriction.

- Windows XP (on which no service pack or SP1 is installed)
- Windows Server 2003 (on which no service pack is installed)

† If you download and install the printer driver on any of the above 32-bit operating systems, you may fail to install the driver and may not be able to open the printing preferences dialog box.

##### **To configure the print server**

See "[Configuring the Print Server.](#)"

# Easy Installation

## 1

Turn the computer on, and then log on to Windows as a user with administrative rights.

### **?** If a screen appears through the Plug and Play automatic setup (USB connection)

Click [Cancel], turn OFF the printer, and then use this procedure to install the printer driver.

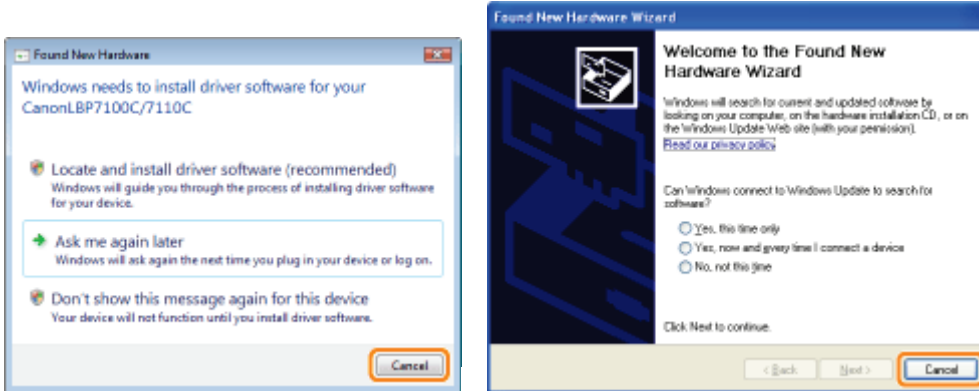

## 2

Insert the supplied CD-ROM "User Software" into the CD-ROM drive of your computer.

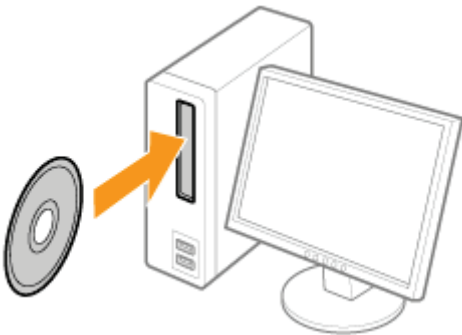

## 3

Click [Easy Installation].

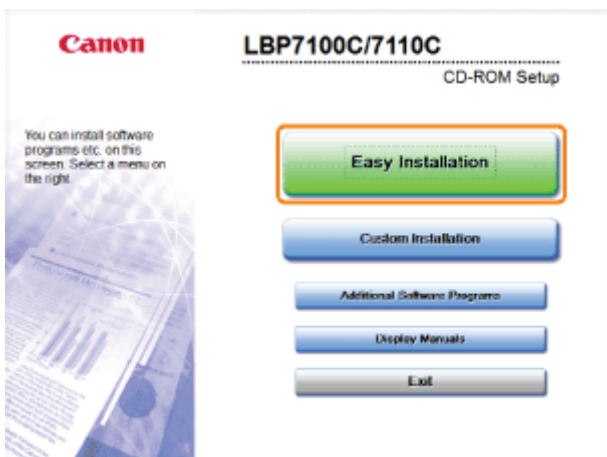

**? If the above screen does not appear**

➤ "Basic Operations/Various Information for Windows"

**? If the [AutoPlay] dialog box appears**

Click [Run AUTORUN.EXE].

**? If the [User Account Control] dialog box appears**

Click [Yes] or [Continue].

## 4

**Click [Start].**

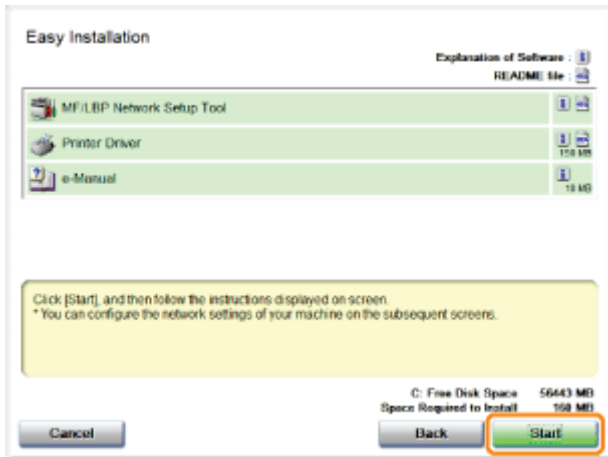

## 5

**Read the contents of License Agreement, and then click [Yes].**

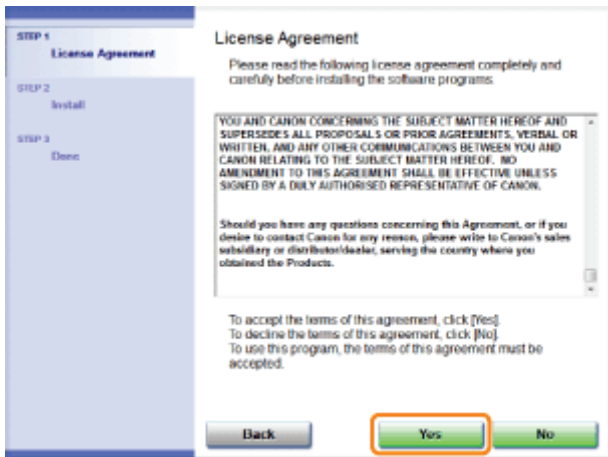

## 6

**Specify the printer connection settings as needed.**

Before specifying the settings, see "Connecting the Printer and Computer."

**The setting procedure varies depending on your environment. Follow the instructions on the screen to specify the settings.**

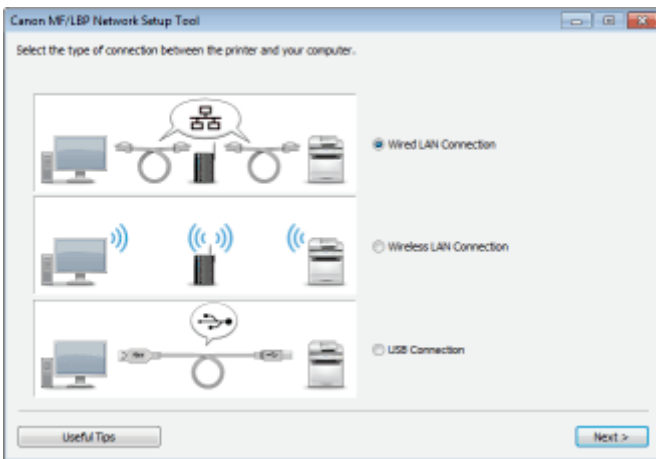

## **?** If you have a problem during the connection settings

Click [Useful Tips] at the bottom left of the screen and see the help contents.

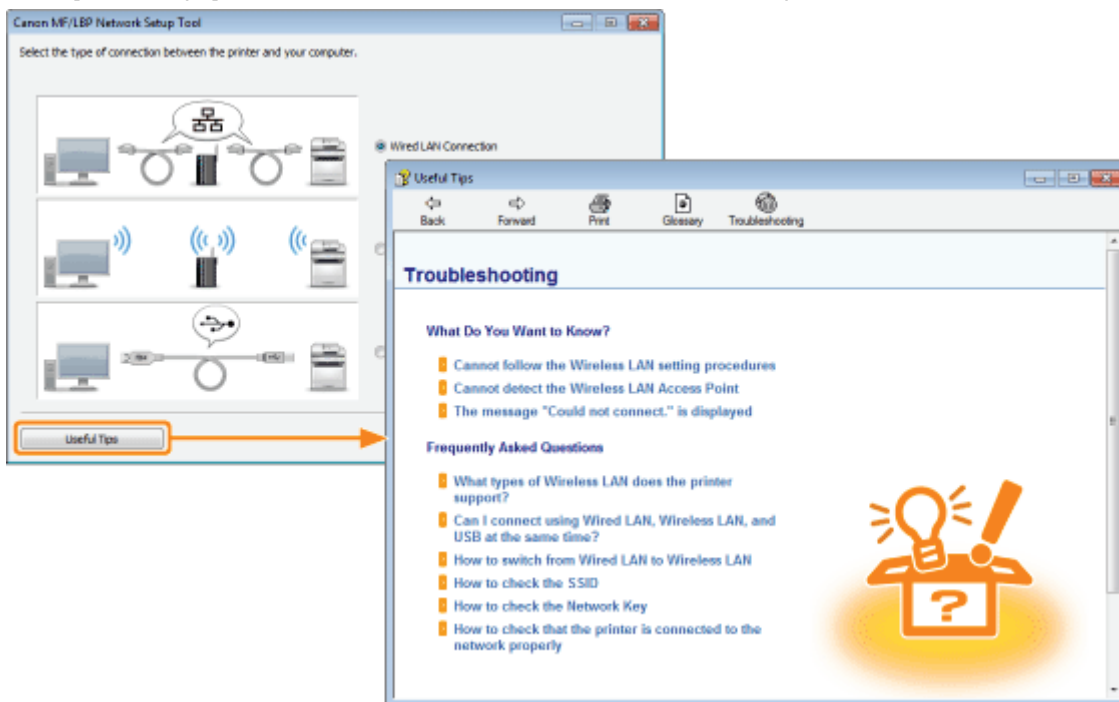

## **7**

**Install the printer driver after specifying the printer connection settings.**

### **1. Click [Display Readme File].**

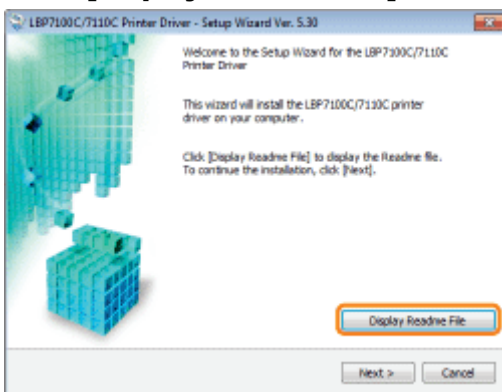

### **2. Read the contents of the Readme file and then close the file.**

It contains important information and special information not found in the e-Manual.

### **3. Click [Next].**



**4. Select the method of installation.**

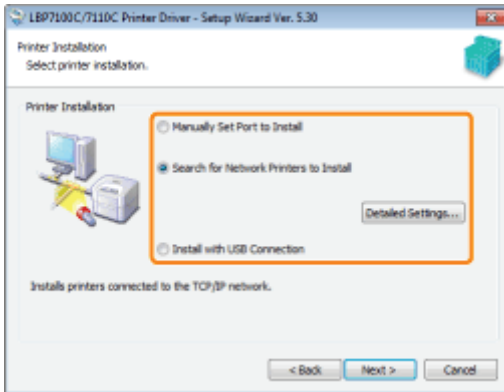

**When connecting with USB**

Select [Install with USB Connection].

**When connecting to a network**

Select [Search for Network Printers to Install].

**When connecting via the print server (client)**

Select [Manually Set Port to Install].

**NOTE**

**To select the port type (network connection)**

Click [Detailed Settings].

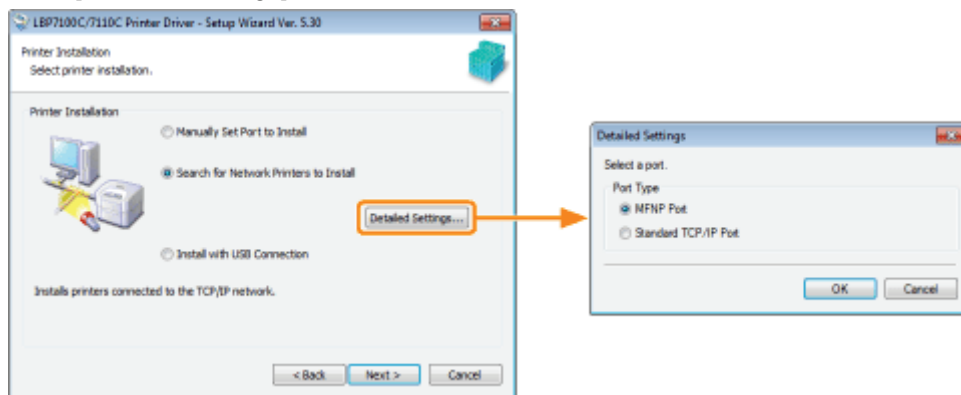

<p>[MFNP Port]</p>	<p>The port that can automatically detect the IP address of the printer. Even if the IP address of the printer changes, the port does not have to be changed because a new IP address is detected automatically when the printer and computer are on the same subnet.</p> <p>† MFNP Port only supports IPv4. (It does not support IPv6.)</p>
<p>[Standard TCP/IP Port]</p>	<p>TCP/IP Port that is standard with Windows. If the IP address of the printer is changed, the port to be used with the printer driver should be changed.</p>

**5. The installation procedure varies depending on the installation method. Follow the instructions on the screen to install the printer driver.**

**? If you do not understand using the following screen**

Click the links on each screen to see the provided description.

#### ❖ [Select Printers to Install] Screen

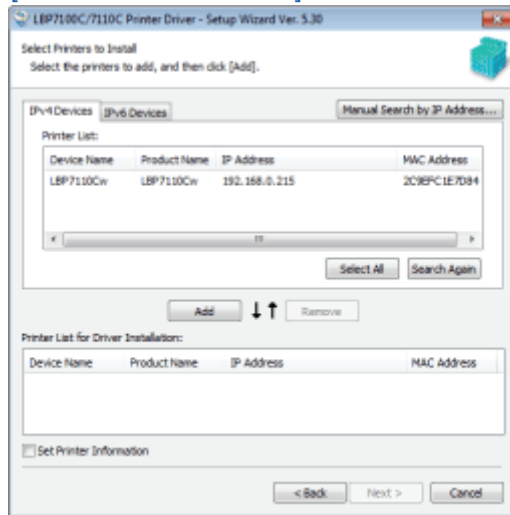

#### ❖ [Printer Information] Screen

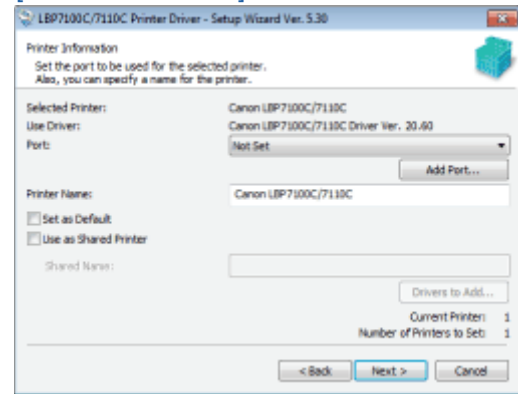

**? If the USB cable is connected but the printer is not automatically recognized (USB connection)**

❖ "The Printer Is Not Recognized Automatically"

## 8

**After the printer driver is installed, installation of the e-Manual starts.**

Please wait a moment until the installation is complete. (It may take a long time to install the e-Manual.)

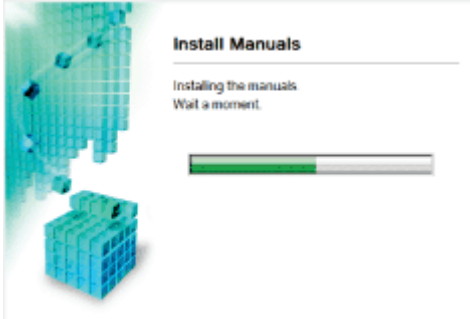

## 9

**Click [Exit].**



## 10

**Confirm that [  ] appears in [Install], and then click [Next].**



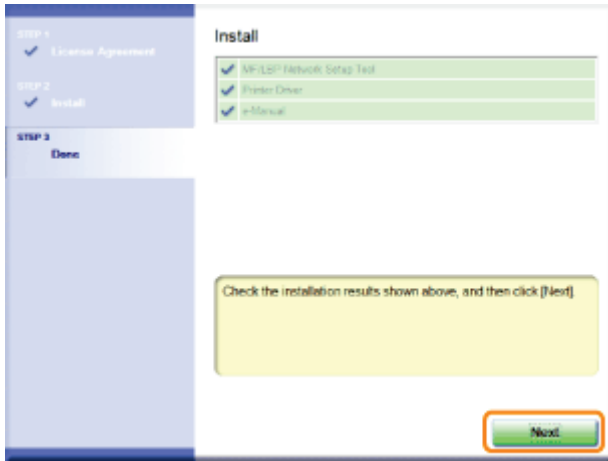

**? If [ X ] appears**

↳ "You Cannot Install the Printer Driver"

# 11

## Restart your computer.

- (1) Select the [Restart Computer Now] check box.
- (2) Click [Restart].

† When the following screen appears, you can remove the CD-ROM.

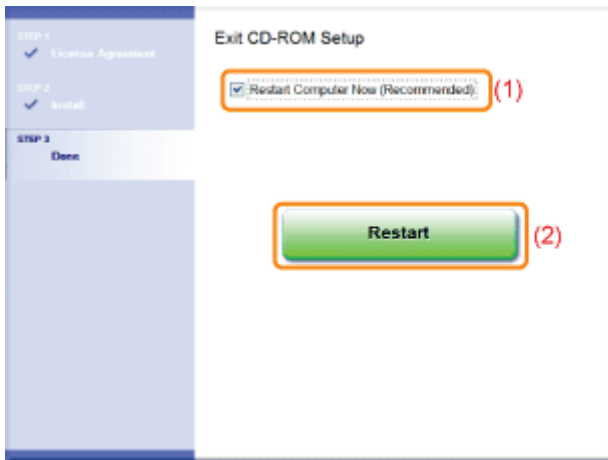

📁 When the installation is complete, an icon and folder for this printer will be created.

↳ "After Installation"

† If you want to change the network settings for the printer, see "[Changing the Network Settings for the Printer.](#)"

## Connecting the Printer and Computer

The following are the procedure and precautions when connecting the printer to a computer.

- ❖ USB Connection
- ❖ Wired LAN Connection
- ❖ Wireless LAN Connection (LBP7110Cw Only)

### NOTE

#### **You cannot use a wired LAN and wireless LAN at the same time**

When using the printer with a wireless LAN connection, do not connect a LAN cable to the printer. This may result in malfunction.

## USB Connection

See "Important Safety Instructions" also.

### IMPORTANT

#### **Do not plug or unplug the USB cable while the printer or computer is ON**

This may cause the printer to malfunction.

#### **About unidirectional communication equipment**

The printer performs bi-directional communication. Operation of the printer when connected via unidirectional communication equipment is not tested, and as a result, Canon cannot guarantee printer operation if the printer is connected using unidirectional print servers, USB hubs or switching devices.

### NOTE

#### **About the USB cable**

- LBP7110Cw comes with a USB cable. When you use LBP7100Cn, have an appropriate USB cable available for the computer you are using.
- Use a USB cable with the following symbol.



# 1

**Make sure that the printer and computer are OFF.**

# 2

**Connect the USB cable.**

- Flat end (A): Connects to a USB port on your computer.
- Square end (B): Connects to the USB connector on this printer.

† Do not turn the printer ON at this stage even if you want to install the printer driver.

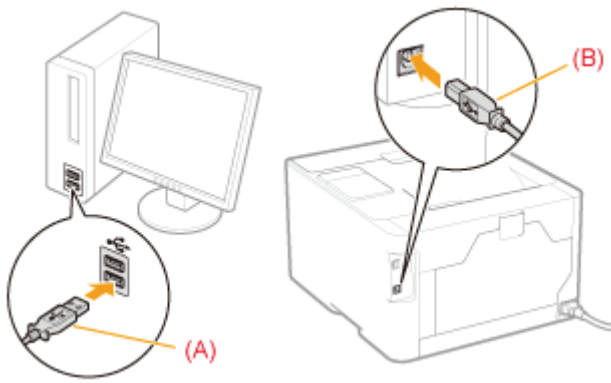

## Wired LAN Connection

See "Attention (Wired LAN Connection)" before connecting the printer to a wired LAN.

**1**

**Connect the LAN cable.**

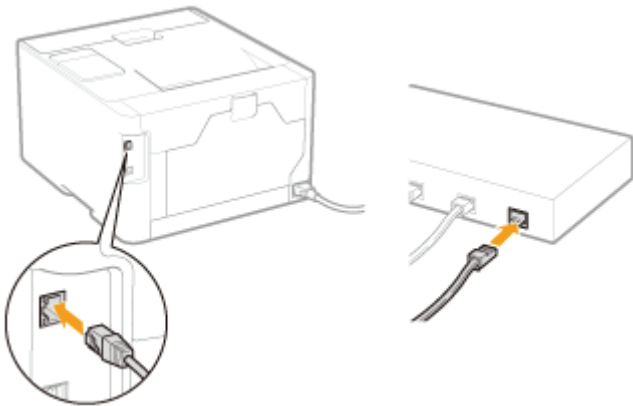

**2**

**Turn the printer ON.**

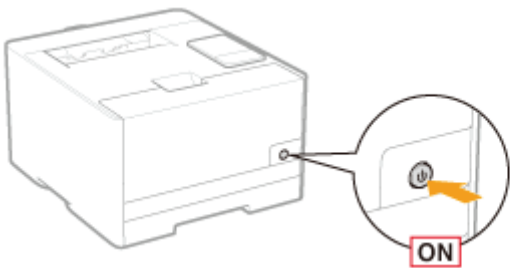

**3**

**Make sure that the LNK indicator (A) on the network interface is on.**

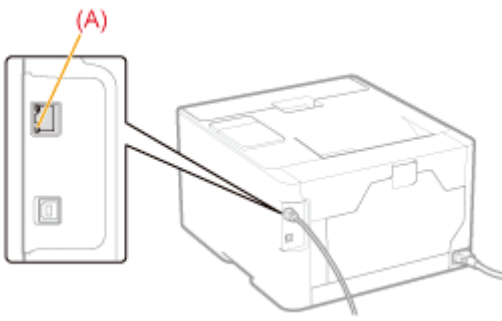

**? When the LNK indicator is off**

↳ "All the Indicators on the Network Interface Are Off"

**Wireless LAN Connection (LBP7110Cw Only)**

See "Attention (Wireless LAN Connection) (LBP7110Cw Only)" before connecting the printer to a wireless LAN.

**1**

**Follow the instructions of "MF/LBP Network Setup Tool" to specify the connection settings.**

† To directly start "MF/LBP Network Setup Tool," see "[Directly Starting the MF/LBP Network Setup Tool.](#)"

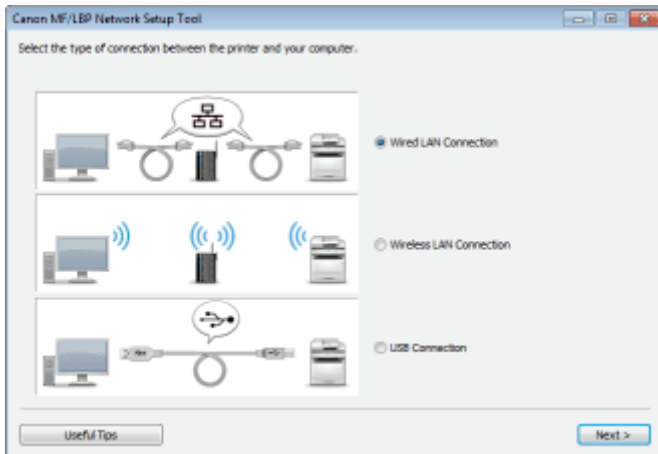

## Attention (Wired LAN Connection)

### IMPORTANT

#### About network security

Connecting to an unsecured network environment creates a risk that personal information and other data may be leaked to a third party. Please be careful.

### NOTE

#### Use in an office

For details on the network settings, consult your network administrator.

#### About the network environment

This printer supports 10BASE-T and 100BASE-TX connections.

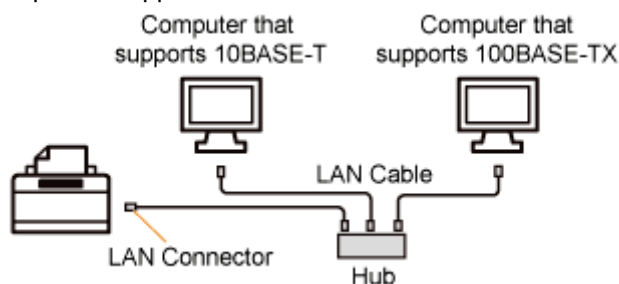

#### About the LAN cable

- This printer does not come with a LAN cable or a hub. Have cables or a hub ready as needed. Use a Category 5 or higher twisted pair cable for the LAN.
- If you want to connect the printer to a 100BASE-TX Ethernet network, all the devices to be connected to the LAN (hub, LAN cable, and network board for computer) must support 100BASE-TX. For details, see the instruction manual of each device or contact the manufacturer.

#### If the printer is connected to a switching hub

Even if the network settings are correct, the printer may not be able to connect to the network. This is because communication cannot be performed between the printer and switching hub immediately after connecting the two devices due to the spanning tree process between the devices.

In this case, you must have the printer waiting to start the network connection.

- ["Specifying the Waiting Time Until Connected to the Network"](#)

† For details on the spanning tree process and other switching hub functions, contact the manufacturer.

## Attention (Wireless LAN Connection) (LBP7110Cw Only)

### Precautions Regarding Security When Using Wireless LAN Products

Wireless LAN offers the advantage of sending and receiving information to and from a computer by radio waves between wireless LAN access points instead of a LAN cable in the range of the wireless signal.

However, the radio waves can reach all areas within range even through obstructions (such as walls), so if security settings are not configured, the following problems can occur.

- **Snooping of transmitted information**

A malicious third party can deliberately intercept the radio signal to snoop for transmitted information, including your ID, password, credit card information and other personal information, and contents of sent e-mail.

- **Illegal access to a network**

A malicious third party can access a personal or corporate network without authorization to commit the following acts.

- Obtaining personal and confidential information (information leak)
- Deceiving a specific person and sending unauthorized information (spoofing)
- Rewriting intercepted information and sending it (tampering)
- Damaging data or a system by spreading a computer virus (cracking)

Wireless LAN cards and wireless LAN access points have security measures to help prevent these problems when used with the security features configured.

It is recommended that you configure the security settings to use your products at your discretion LAN device, and you are responsible for all actions should you choose not to configure the security settings.

### IMPORTANT

#### About security

- Connecting to an unsecured network environment creates a risk that personal information and other data may be leaked to a third party. Please be careful.
- This printer supports the following security systems.
  - 128 (104)/64 (40) bit WEP
  - WPA-PSK (TKIP/AES-CCMP)
  - WPA2-PSK (TKIP/AES-CCMP)
- † For details on the security of your wireless LAN access point, see the instruction manual of the wireless LAN access point or contact the manufacturer.
- This printer does not support IEEE 802.1X authentication.

#### About signal strength

Wireless LAN uses radio waves; therefore, nearby wireless LAN access points may be detected.

If the specified access point name (SSID) has been manually entered and there are multiple wireless LAN access points with the same SSID and security information, connect to the wireless LAN access point with the strongest signal (RSSI).

### NOTE

#### Use in an office

For details on the network settings, consult your network administrator.

#### Equipment required for a wireless LAN connection

- This printer does not come with a wireless LAN access point or other related devices. Have a wireless LAN access point ready as needed.
- When using this printer in a wireless LAN environment, you must use a wireless LAN access point with a 2.4-GHz frequency that conforms to IEEE 802.11b/g/n.  
For details, see the instruction manual of each device or contact the manufacturer.



## [Select Printers to Install] Screen

Use this screen to select the printer to be installed, as shown below.

### 1

#### Add the printer to [Printer List for Driver Installation].

- (1) Select the printer to install.
- (2) Click [Add].

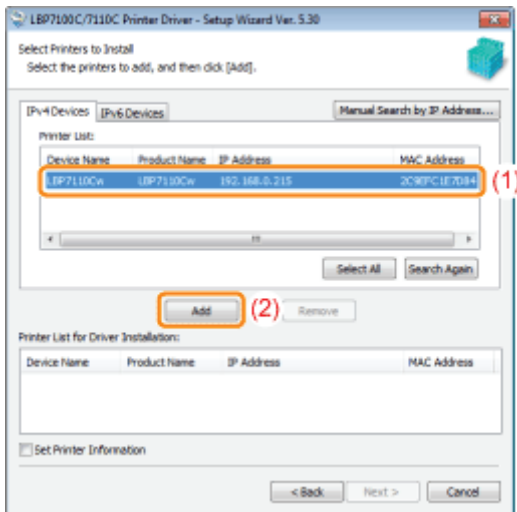

#### ? If no devices are displayed in [Printer List]

- "The Printer Cannot Be Searched for"

#### NOTE

##### About [IPv6 Devices] tab

This tab is displayed only when Standard TCP/IP Port is used.

- † You can select the port to use from the [Detailed Settings] dialog box, which appears when [Detailed Settings] is clicked on the [Printer Installation] screen.

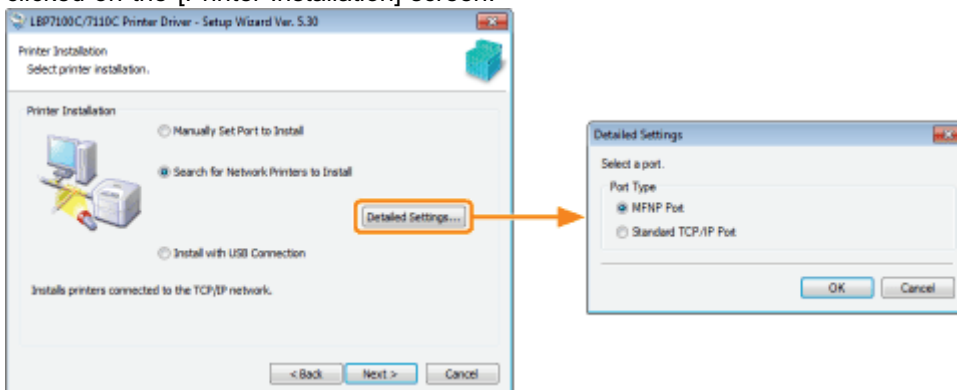

### 2

#### Perform the following procedure.

- (1) Select the [Set Printer Information] check box.



(2) Click [Next].

→ Proceed to the [Printer Information] Screen.

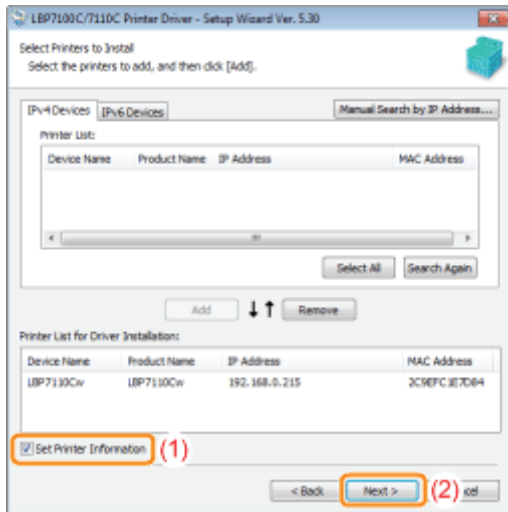

## [Printer Information] Screen

Use this screen to specify the port to use with the printer, the printer name, and other printer information.

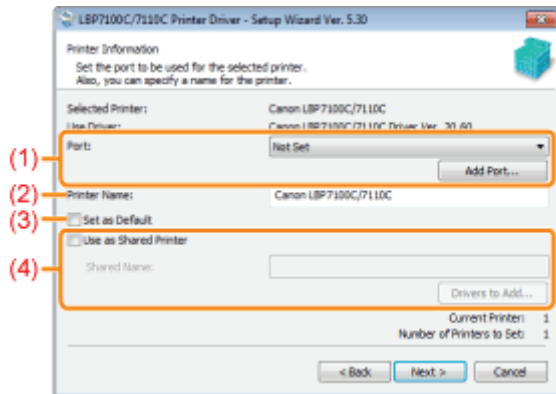

<p>(1) [Port]</p>	<p><b>When using a port that has already been specified</b></p> <p>Select the port to use with the printer.</p> <p><b>When adding a port</b></p> <p>Click [Add Port].</p> <p>† For details on the port settings, see Step 4 and subsequent steps in "<a href="#">Configuring and Changing the Port.</a>"</p> <p><b>When connecting via the print server (client)</b></p> <p>See "<a href="#">Port Setting When Using the Printer via the Print Server.</a>"</p> <p>† When connecting via the print server (selecting [Network] with [Add Port]), you cannot specify (2) [Printer Name] and (4) [Use as Shared Printer] below.</p>
<p>(2) [Printer Name]</p>	<p>Enter a new name if you want to change the printer name.</p>
<p>(3) [Set as Default]</p>	<p>Select the check box if you want to use this printer as the default printer.</p>
<p>(4) [Use as Shared Printer]</p>	<p>Select the check box to use the computer on which the printer driver is being installed as the print server.</p> <p>† For details on the printer sharing (print server environment), see "<a href="#">If You Use the Printer in the Print Server Environment.</a>"</p> <p><b>[Shared Name]</b></p> <p>Change the shared name as needed.</p> <p><b>[Drivers to Add]</b></p> <p>When sharing a printer, use the following procedure to install the additional driver.</p> <p>(1) Click [Drivers to Add].</p> <p>(2) Select an operating system displayed in [Drivers to Add].</p> <p>(3) Click [OK].</p>

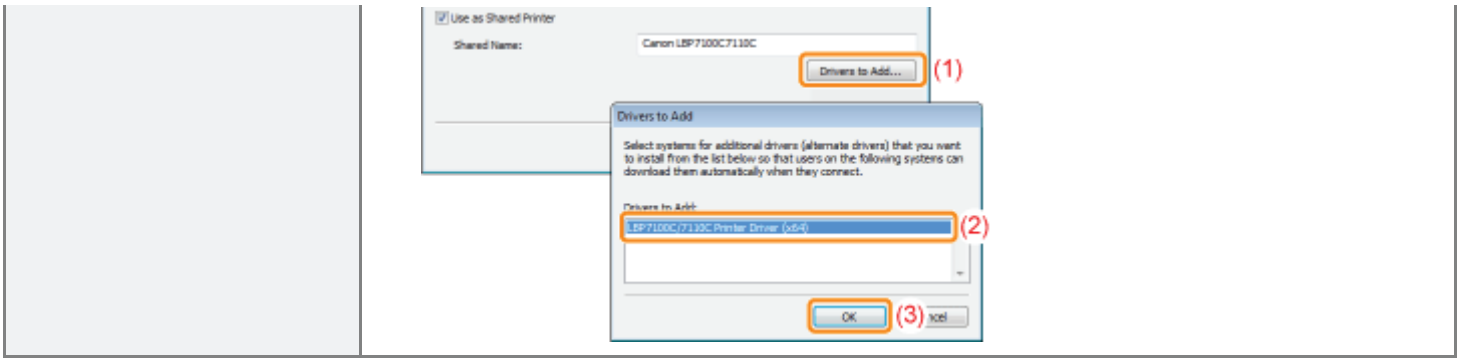

## Port Setting When Using the Printer via the Print Server

Specify the port using the following procedure.

### 1

Click [Add Port].

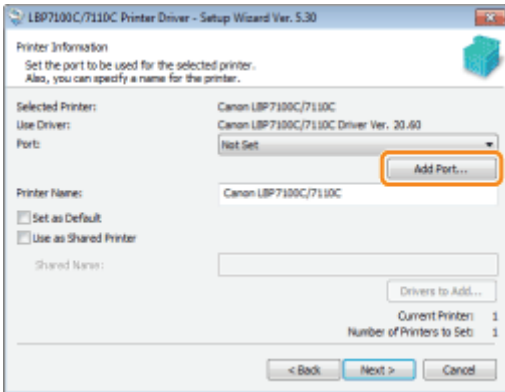

### 2

Select a port to be added.

- (1) Select [Network].
- (2) Click [OK].

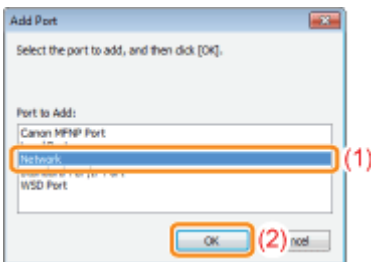

### 3

Select a shared printer.

- (1) Select a shared printer on the print server.
- (2) Click [OK].

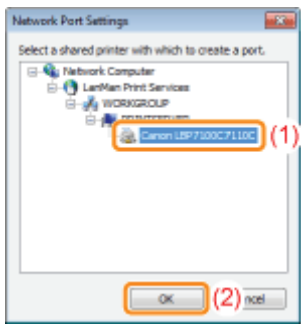

## After Installation

If the printer driver is installed properly, the following icons, folders, and so on are added to the following locations.

- **Printer folder** (↗ "Basic Operations/Various Information for Windows")

Printer icon for this printer

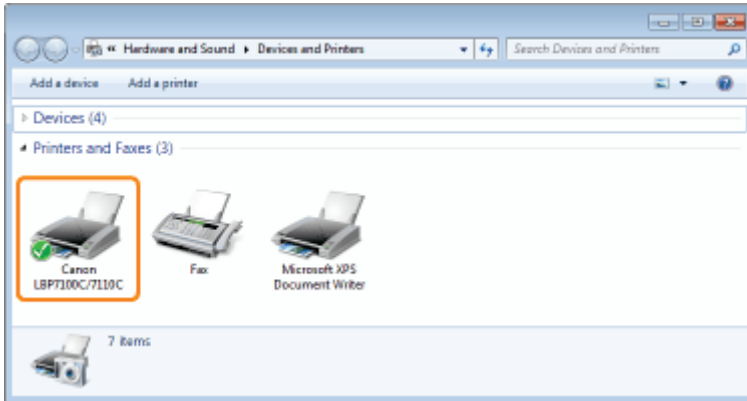

- **Task tray**

Printer Status Window icon

† The icon does not appear if you did not restart your computer after the printer driver installation.



- **[All Programs] under the [Start] menu**

[Canon Printer Uninstaller] - [Canon LBP7100C 7110C Uninstaller]

† Use this option when uninstalling the printer driver.

† This option does not appear if you install the printer driver using a method other than Easy Installation.

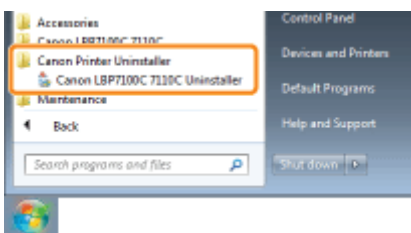

- **Desktop**

[LBP7100C 7110C e-Manual]

† This icon does not appear if you install the printer driver using a method other than Easy Installation.

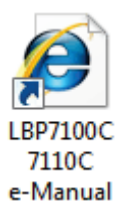

- **[All Programs] under the [Start] menu**

† This option does not appear if you install the printer driver using a method other than Easy Installation.

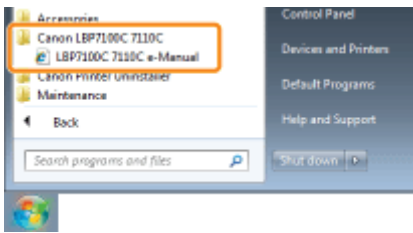

**? If the icons and folders are not added**

The installation is not completed properly.

See "[You Cannot Install the Printer Driver](#)" and install the printer driver again.

## Uninstalling the Printer Driver

The process of removing the printer driver to restore the computer to the same state as before the printer driver was installed is referred to as uninstallation. To uninstall the printer driver, perform the following procedure.

### 1

**If a USB cable is connected, turn OFF the printer and computer, and then remove the USB cable.**

### 2

**Turn the computer on, and then log on to Windows as a user with administrative rights.**

### 3

**Close the following files and programs if open.**

- Help files
- Printer Status Window
- Control Panel
- Other applications

### 4

**Start the uninstaller.**

From the [Start] menu, select [All Programs] → [Canon Printer Uninstaller] → [Canon LBP7100C 7110C Uninstaller].

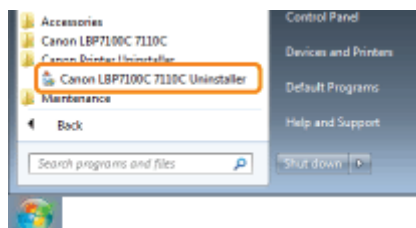

**? If the uninstaller is not found in the [Start] menu**

- "Starting the Uninstaller from the CD-ROM"

**? If the [User Account Control] dialog box appears**

Click [Yes] or [Allow].

### 5

**Perform the following procedure.**

**If this printer is displayed**

- (1) Select this printer.
- (2) Click [Delete].

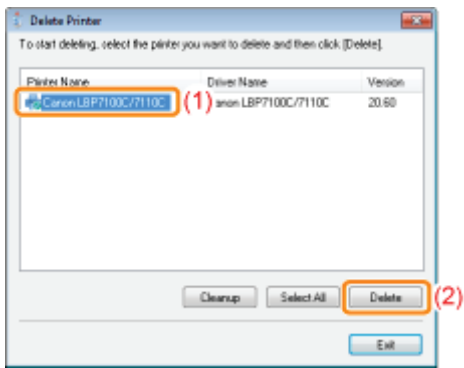

## IMPORTANT

### About [Cleanup]

Clicking [Cleanup] deletes all driver files and registry information displayed on the list, including the selected driver. Normally, uninstall the printer driver using [Delete].

### If this printer is not displayed

Click [Cleanup].

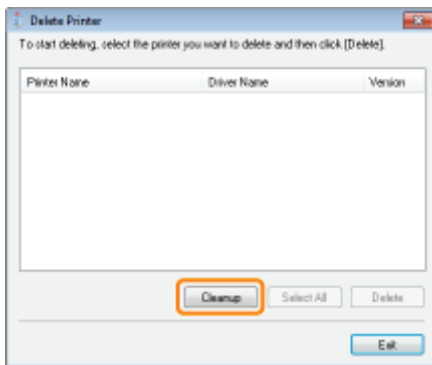

## 6

### Click [Yes] to start the uninstallation.

Please wait a moment until the uninstallation is complete. (It may take a long time to uninstall the printer driver.)



When the following screen appears, click [Yes] or [Yes To All].

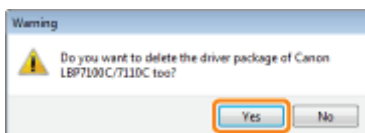

## 7

### Click [Exit].



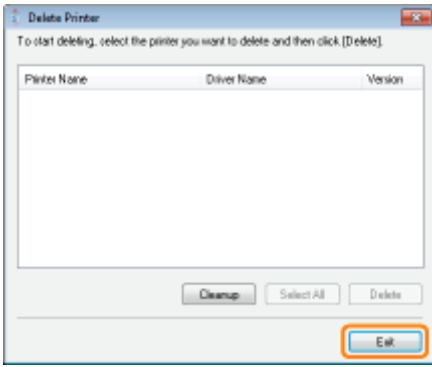

## 8

**Open the printer folder.**

➤ "Basic Operations/Various Information for Windows"

## 9

**Confirm that the icon for this printer is not found.**

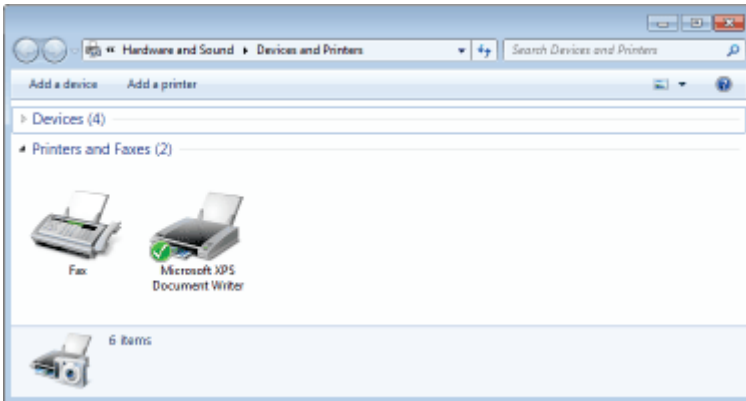

### **IMPORTANT**

**If the icon for this printer is displayed**

1. Right-click the icon, and then select [Remove device] or [Delete] from the pop-up menu.
2. Click [Yes].

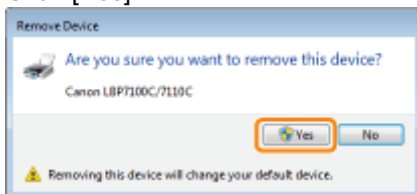

If the [User Account Control] dialog box appears, click [Yes].

## 10

**Restart Windows.**

 Next, uninstall the e-Manual using the following procedure.  
(If you did not install the e-Manual, you do not need to perform the following procedure.)

# 11

Insert the supplied CD-ROM "User Software" into the CD-ROM drive of your computer.

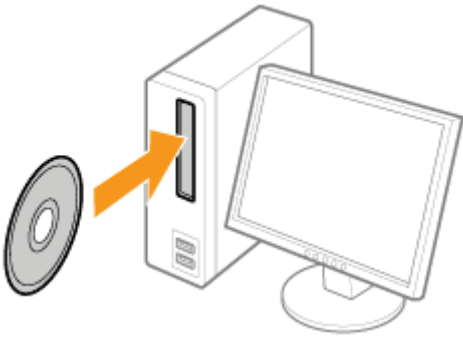

# 12

Click [Additional Software Programs].

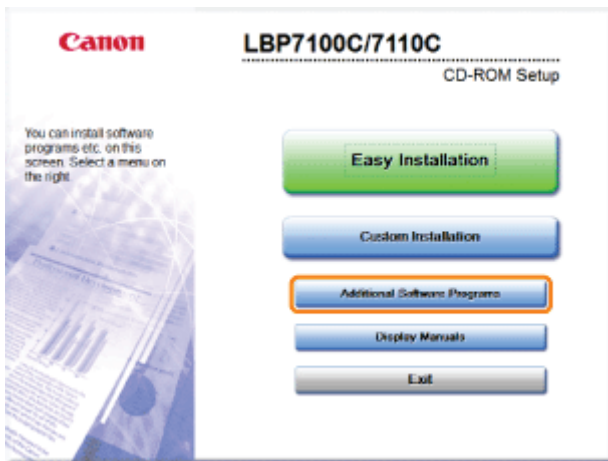

**?** If the above screen does not appear

▣ "Basic Operations/Various Information for Windows"

**?** If the [AutoPlay] dialog box appears

Click [Run AUTORUN.EXE].

**?** If the [User Account Control] dialog box appears

Click [Yes] or [Continue].

# 13

Click [Start] in [Manual Uninstaller].

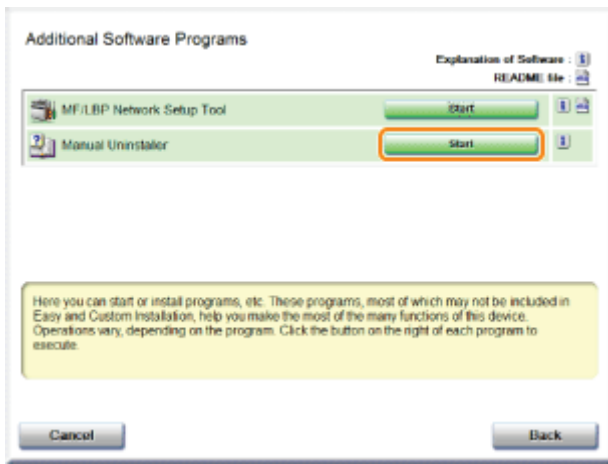

## 14

Click [Uninstall] to start the uninstallation.

Please wait a moment until the uninstallation is complete. (It may take a long time to uninstall the e-Manual.)



## 15

Click [Exit].



## 16

Click [Back].

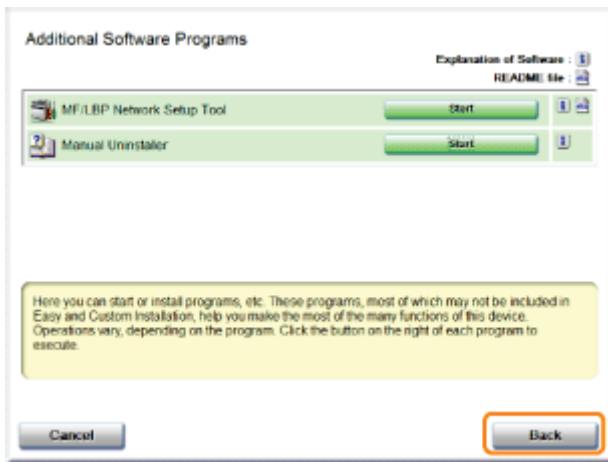

# 17

Click [Exit].

† When the following screen appears, you can remove the CD-ROM.

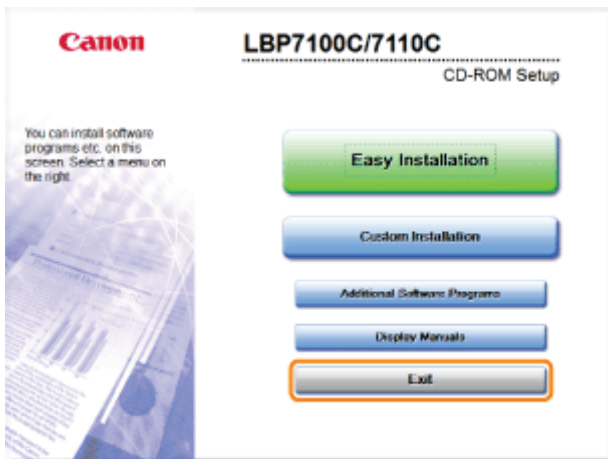

# Basic Printer Operations

---

## ▸ Usable Paper

---

- Precautions for Paper
- Printable Area

## ▸ Paper Loading and Output

---

- Loading Paper

## ▸ Basic Printing Procedure

---

## ▸ How to Use Help

---

## ▸ Canceling a Job

---

## ▸ Checking the Printer Status

---

## Usable Paper

The following shows the paper sizes that can be used with this printer.

Paper Type	Setting for [Paper Type] <sup>*1</sup>	Paper Size
Plain paper <sup>*2</sup> (70 to 85 g/m <sup>2</sup> )	[Plain 1] <sup>*3</sup> (Default)	A4
		B5
		A5
		Legal
		Letter
		Executive
		Statement
		Foolscap
		16K
		Custom Paper Size <sup>*4</sup>
Plain paper <sup>*2</sup> (75 to 90 g/m <sup>2</sup> )	[Plain 2] <sup>*3 *5</sup>	A4
		B5
		A5
		Legal
		Letter
		Executive
		Statement
		Foolscap
		16K
		Custom Paper Size <sup>*4</sup>
Plain paper <sup>*2</sup> (60 to 74 g/m <sup>2</sup> )	[Thin 1] [Thin 2] <sup>*6</sup>	A4
		B5
		A5
		Legal
		Letter
		Executive
		Statement
		Foolscap
		16K
		Custom Paper Size <sup>*4</sup>
		A4
		B5
		A5
		Legal

Heavy paper (86 to 120 g/m <sup>2</sup> )	[Heavy 1] <sup>*5</sup>	Letter
		Executive
		Statement
		Foolscap
		16K
		Custom Paper Size <sup>*4</sup>
Heavy paper (121 to 163 g/m <sup>2</sup> )	[Heavy 2]	A4
		B5
		A5
		Legal
		Letter
		Executive
		Statement
		Foolscap
		16K
		Custom Paper Size <sup>*4</sup>
Transparency (black and white printing only)	[Transparency]	A4
		Letter
Label	[Labels]	A4
		B5
		A5
		Legal
		Letter
		Executive
		Statement
		Foolscap
		16K
		Custom Paper Size <sup>*4</sup>
Index Card	[Heavy 2]	Index Card
Envelope	[Envelope] [Envelope H] <sup>*7</sup>	Envelope Monarch
		Envelope No. 10 (COM10)
	[Envelope H]	Envelope DL
Coated paper (100 to 220 g/m <sup>2</sup> )	[Coated 1] <sup>*8</sup> [Coated 2] <sup>*8</sup> [Coated 3] <sup>*8</sup> [Coated 4] <sup>*8</sup>	Envelope C5
		A4
		B5
		A5
		Legal
		Letter
		Executive
Statement		

	Foolscap
	16K
	Custom Paper Size <sup>*4</sup>

\*1 The setting is located in the [Paper Source] sheet in the printer driver.

\*2 Recycled paper can be also used.

\*3 If you want to print paper of 75 to 85 g/m<sup>2</sup>, you can specify either of [Plain 1] or [Plain 2].<sup>\*9</sup>

\*4 You can load paper of the following custom paper sizes.

- In case of portrait orientation: Width 83.0 to 215.9 mm, Length (Height) 127.0 to 355.6 mm
- In case of landscape orientation: Width 127.0 to 215.9 mm, Length (Height) 127.0 to 215.9 mm

\*5 If you want to print paper of 86 to 90 g/m<sup>2</sup>, you can specify either of [Plain 2] or [Heavy 1].<sup>\*9</sup>

\*6 If the printed paper curls (the printed side curls outward) when 60 g/m<sup>2</sup> paper is printed with [Thin 1] selected, select [Thin 2].

\*7 If you want to improve the toner fixation when printed with [Envelope] selected, select [Envelope H].

\*8 Specify the setting as follows for coated paper.

- 100 to 110 g/m<sup>2</sup>: [Coated 1]
- 111 to 130 g/m<sup>2</sup>: [Coated 2]
- 131 to 160 g/m<sup>2</sup>: [Coated 3]
- 161 to 220 g/m<sup>2</sup>: [Coated 4]

\*9 If either setting causes the following problems and so on, specify the other setting to print.

- Output paper curls.
- Residual images appear on non-printed areas.
- The toner does not fix onto paper well, and the printing comes out faint.

## IMPORTANT

### About print speed

- The print speed may drop depending on the paper settings for the size, type, orientation, and number of copies.
- When continuously printing paper whose width is less than 190 mm, the print speed may drop gradually.

### Precautions for paper

 ["Precautions for Paper"](#)

## NOTE

### Printable area

 ["Printable Area"](#)

### Envelope sizes

The envelope sizes are as follows.

Envelope Monarch	98.4 mm x 190.5 mm
Envelope No. 10 (COM10)	104.7 mm x 241.3 mm
Envelope DL	110.0 mm x 220.0 mm
Envelope C5	162.0 mm x 229.0 mm



# Precautions for Paper

## Paper Which Requires Attention Before Use

When using the following types of paper, this may cause influence to the printout results or printer in some cases.

### Paper that was stored poorly

- Creased or folded paper
- Torn or damaged paper
- Wrinkled paper
- Curled paper
- Wet or moist paper
- Paper with rough edges
- Irregularly-shaped paper

### Paper with holes or perforations

- Paper with binding holes
- Paper with perforations

### Paper with adhesive or a special coating

- Heat-sensitive paper
- Paper with adhesive
- Carbon paper
- Treated color paper
- Specially coated paper (coated paper for ink jet printers and so on)

### Paper that was printed by another printer

- Paper that was printed by a copy machine or another printer (The reverse side of the paper is also not usable.)

### Paper that is difficult for the toner to fix onto

- Paper with rough surfaces
- Paper containing thick fibers
- Paper with an extremely rough or smooth surface
- Paper that is thicker or thinner than the specified usable paper
  - ▣ "Usable Paper"

## IMPORTANT

### About paper with staples, clips, ribbons or tape

This kind of paper may result in the printer malfunction or damage to the printer.

### About paper that contains ink that melts, burns, evaporates or emits harmful gases at or lower than the heating temperature of the fixing unit

This kind of paper may result in the printer malfunction or damage to the printer.

### Printing on the reverse side of paper that was previously printed (Performing 2-sided printing manually)

This printer enables you to perform 2-sided printing manually by inserting the reverse side of the paper\* that was previously printed.

When printing on the reverse side of paper that was previously printed, flatten the curl and load one sheet of paper at a time in the paper drawer, and perform the following procedure in the printer driver.

1. Display the [Paper Source] sheet.
2. Select the [Print on the Other Side] check box.

\* You can use only paper printed by this printer. Also, you cannot print on the printed side again.

## Storing Paper

The quality of paper may deteriorate if stored improperly even when the paper meets the normal specifications. Inferior paper may cause misfeeds, paper jams, or deterioration in print quality.

### How to store paper

Observe the following guidelines when storing and handling paper.

- Store paper on a flat surface.
- To help paper avoid moisture or dryness, keep paper in its wrapper until it is ready to be used.
- Do not place paper in the condition where it may curl or become creased.
- Do not store paper vertically or store too many stacks of paper in one pile.

Do not store paper in the following locations.

- A location exposed to direct sunlight
- A location subject to high humidity
- A dry location
- A location with a temperature or humidity that differs significantly from the location where it will be used

### If you print on damp paper

If you print on damp paper, steam may be emitted from the printer output area.

Because moisture in the paper is evaporating due to the heat generated when toner fixes, this is not a malfunction. (This is likely to occur when the room temperature is low.)

## Storing Printouts

When handling or storing paper printed by this printer, be careful of the following points.

### How to store printouts

- Store paper on a flat surface.
- Avoid storing printouts in folders made of PVC material, as this may cause the toner to melt and stick to the PVC material. Toner may peel when printouts are folded or creased.
- Store printouts in the condition where they are not folded or creased as toner may peel.
- Put printouts in a binder when storing for a long period of time (two years or longer).
- Printouts may discolor when stored for a long period of time.
- Avoid storing printouts in a location subject to high temperatures.

### Precautions when sticking printouts with adhesive

- Be sure to use insoluble adhesive.
- Test the adhesive on an unneeded printout before using.
- Before stacking printouts that stuck with adhesive, check that the adhesive completely dried.

## Printable Area

### NOTE

#### **If you want to extend the printable area**

Specify the following settings in the printer driver.

1. Click [Advanced Settings] in the [Finishing] sheet.
2. Set [Expand Print Region and Print] to [On].

- † Depending on the print data to be printed, the edge of paper may be missing partly during printing or may blot during color printing.
- † If you are using Macintosh, select the paper that [(Print Area-Large)] or [Borderless] appears in the pull-down menu.

### Plain Paper/Heavy Paper/Transparency/Label/Index Card/Coated Paper

You cannot print on any area within 5 mm of the edges of paper.

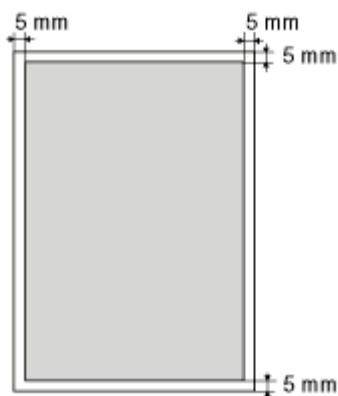

### Envelope

You cannot print on any area within 10 mm of the edges of an envelope.

You may have to change the printable area before printing, depending on the application you use.

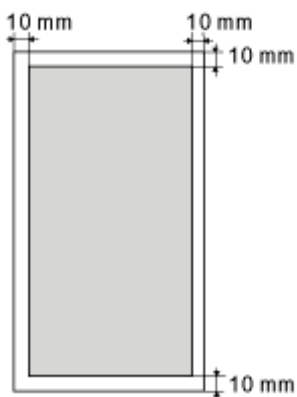

## Paper Loading and Output

This printer has the following paper source and output destination.

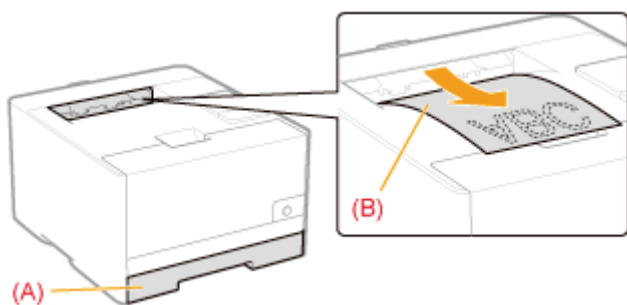

<b>Paper Source</b>	(A): Paper Drawer	➤ "Loading Paper"
<b>Output Destination</b>	(B): Output Tray	Outputs paper with the printed side facing down.

### Paper Capacity of the Paper Source and Output Destination

Paper Type	Paper Source	Output Destination
	Paper Drawer	Output Tray*
Plain paper (Ex. 90 g/m <sup>2</sup> )	Approx. 150 sheets	Approx. 125 sheets
Heavy paper (Ex. 120 g/m <sup>2</sup> )	Approx. 120 sheets	Approx. 50 sheets
Heavy paper (Ex. 163 g/m <sup>2</sup> )	Approx. 100 sheets	Approx. 30 sheets
Transparency	Approx. 50 sheets	1 sheet
Label	Approx. 50 sheets	Approx. 10 sheets
Index Card	Approx. 15 sheets	Approx. 10 sheets
Envelope	Approx. 10 sheets	Approx. 10 sheets
Coated paper	Approx. 100 sheets	Approx. 50 sheets

\* Actual paper capacity varies depending on the installation environment and paper type to be used.

# Loading Paper

† For details on the paper that you can load, "Usable Paper."

Before loading paper, see "Attention (Paper Loading)."

## 1

**Pull out the paper drawer.**

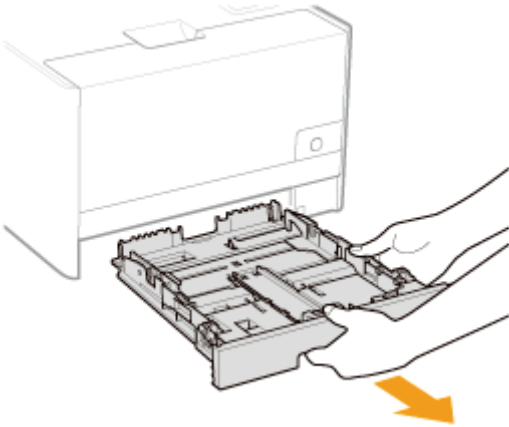

## 2

**Slide the paper guides a little wider and longer than the actual paper size.**

Slide the paper guide at the front center while holding the lock release lever (A).

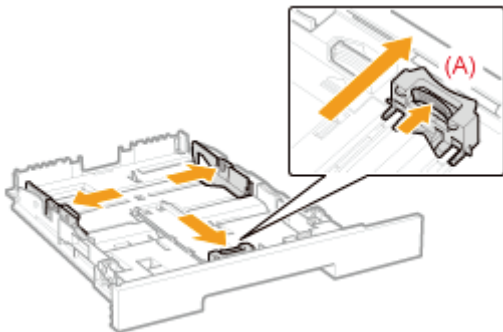

**When loading paper whose length is longer than A4**

Pull out the paper drawer while holding the lock release lever (B) at the front right.

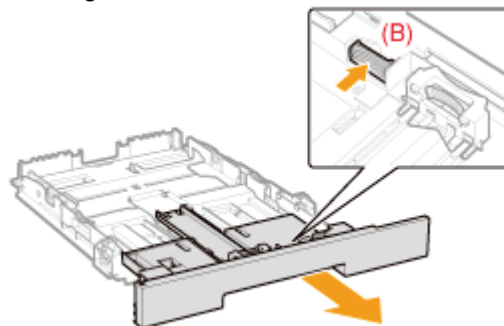

## 3

**Load the paper with the printing side facing up so that the edges of the stacked paper are aligned with the rear edge of the paper drawer.**

Load paper in portrait orientation.

† The following paper can also be loaded in landscape orientation.

•

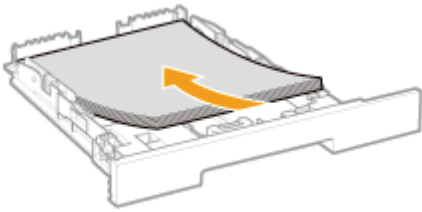

A5 paper

- Statement paper
- Custom size paper with a width and length (height) between 127.0 and 215.9 mm

If loading paper in landscape orientation, select the [Feed A5 Horizontally], [Feed Statement Horizontally], or [Feed Custom Paper Horizontally] check box on the [Paper Source] sheet of the printer driver when printing.

#### **IMPORTANT**

##### **When loading envelopes**

See "Printing on Envelopes" and load the paper in the correct orientation.

#### **NOTE**

##### **When loading paper with a letterhead or logo**

See "Paper Loading Orientation" and load the paper in the correct orientation.

## 4

### **Align the paper guides flush with the loaded paper.**

Slide the paper guide at the front center while holding the lock release lever (A).

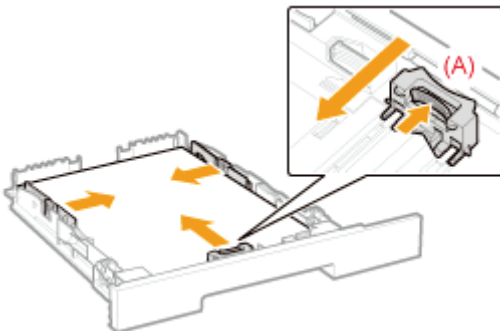

#### **IMPORTANT**

##### **Be sure to align the paper guides flush with the paper.**

If the paper guides are too loose or too tight, this may result in misfeeds or paper jams.

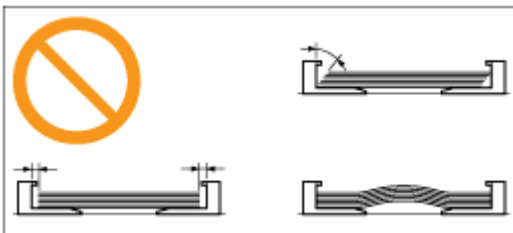

## 5

### **Make sure that the paper stack does not exceed the load limit mark lines (A).**

† Be sure that the paper stack does not exceed the load limit mark lines. If the paper stack exceeds the load limit mark lines, this may result in misfeeds.

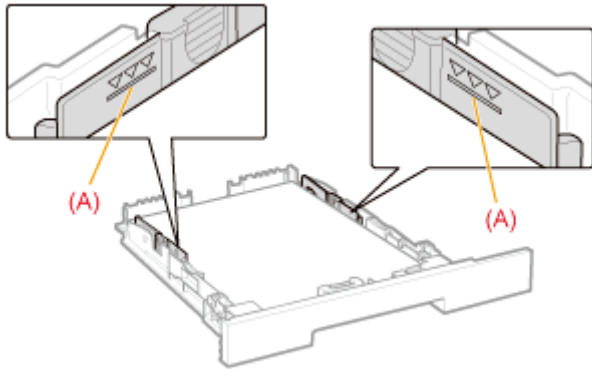

## 6

**Insert the paper drawer in the printer.**

### NOTE

#### **When loading paper whose length is longer than A4**

Although the front side of the paper drawer is not flush with the front surface of the printer as shown in the figure, the printer is ready.

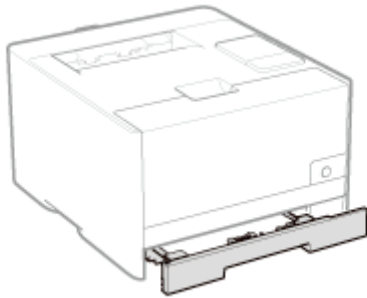

 Next, register the paper size and type.  
["Registering the Paper Size and Type"](#)

## Attention (Paper Loading)

See "Important Safety Instructions" also.

### IMPORTANT

**Do not touch the black rubber pad (A) in the paper drawer.**

This may result in misfeeds.

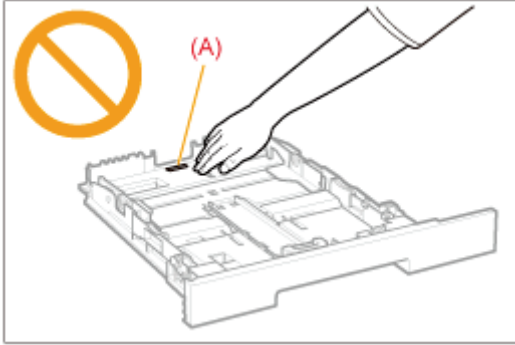

**Do not pull out the paper drawer during printing.**

This may result in paper jams or damage to the printer.

**When using paper that is poorly cut**

Multiple sheets of paper may be fed at a time. In this case, fan the paper thoroughly, and then align the edges of the stack properly on a hard, flat surface.



## Registering the Paper Size and Type

This printer's paper drawer cannot automatically detect the paper size and type. Therefore, you need to register the size and type of the loaded paper.

Register the paper size and type using the following procedure.

### NOTE

#### When registering a paper size and type

As you cannot register a paper size and type while printing is in progress, make sure that the printer is idle before registering the paper size and type.

You can register paper size and type only while one of the following messages is displayed.

- <Specified Paper Different from Set Paper>
- <Out of Paper>

## 1

Click [  ] in the Windows task tray, and then select the printer name.



## 2

From the [Options] menu, select [Device Settings] → [Paper Source Settings].

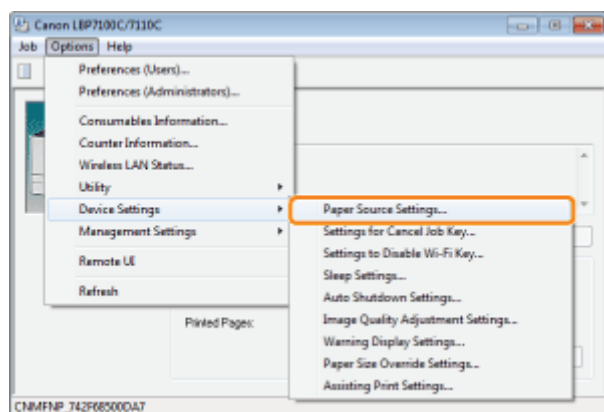

## 3

Register the paper size and type.

- (1) Specify the size and type of the paper loaded in the paper drawer.
- (2) Click [OK].

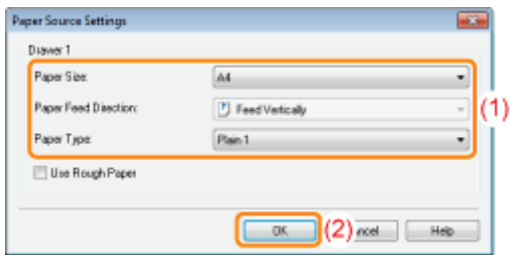

[Paper Size]	<p>Select the size of the paper loaded in the paper drawer.</p> <p>† When [Free] is specified, the paper size of the printed job is registered automatically each time printing is completed.</p>
[Paper Feed Direction]	<p>Select the feed direction (orientation) of paper loaded in the paper drawer when using A5, Statement, or custom size paper.</p>
[Paper Type]	<p>Select the type of the paper loaded in the paper drawer.</p> <p>† When [Free] is specified, printing is performed without checking the paper type. When [Free] is specified, be sure to check that the paper type setting of the printer driver matches the type of paper loaded in the paper drawer at the time of printing.</p>

 For details on the basic printing procedure, see "[Basic Printing Procedure](#)."

- † If printing custom size paper, you need to register the custom paper size in the printer driver previously.
  - "[Registering a Custom Paper Size](#)"

# Basic Printing Procedure

This section describes the basic procedure for printing from an application, taking Adobe Reader as an example.

† The printing procedure may differ depending on the application you are using.

Before printing, see ["Attention \(Basic Printing\)."](#)

## 1

**Load paper in the paper drawer.**

➤ ["Loading Paper"](#)

## 2

**Open the PDF file to be printed using Adobe Reader.**

## 3

**Select [Print] from the [File] menu.**

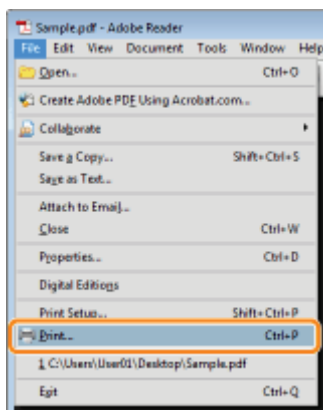

## 4

**Configure the printing preferences.**

(1) Select this printer.

† You can change the printer name in the printer folder (➤ ["Basic Operations/Various Information for Windows"](#)).

(2) Configure the printing preferences.

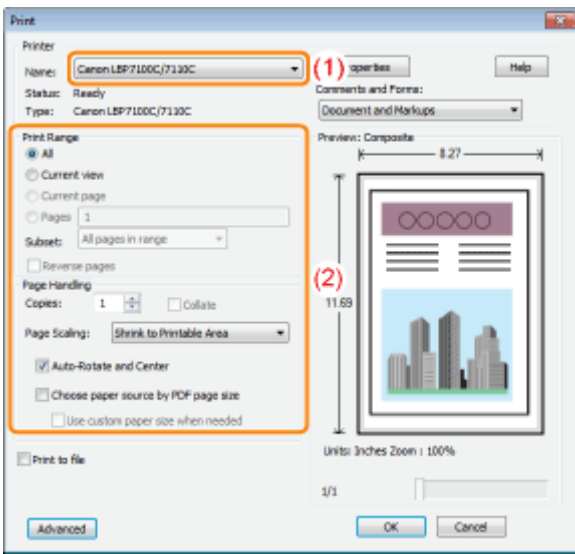

## 5

Click **[Properties]**.

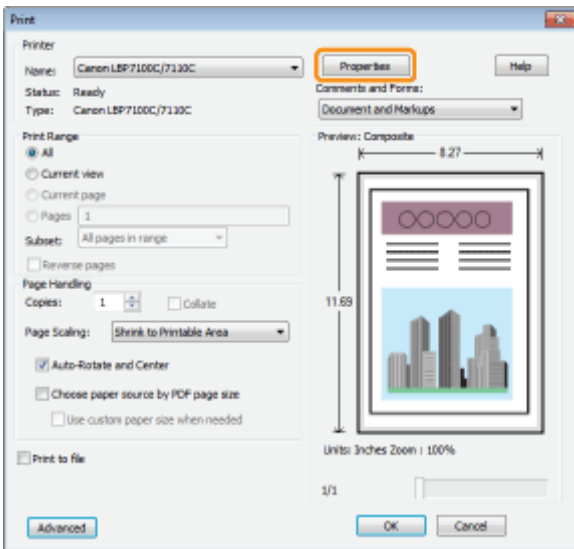

## 6

Specify the settings for **[Page Size]** and **[Output Size]**.

- (1) Display the **[Page Setup]** sheet.
- (2) Select the page size of the document created by an application.
- (3) Select if the size of the paper to be printed is different from that of the data.

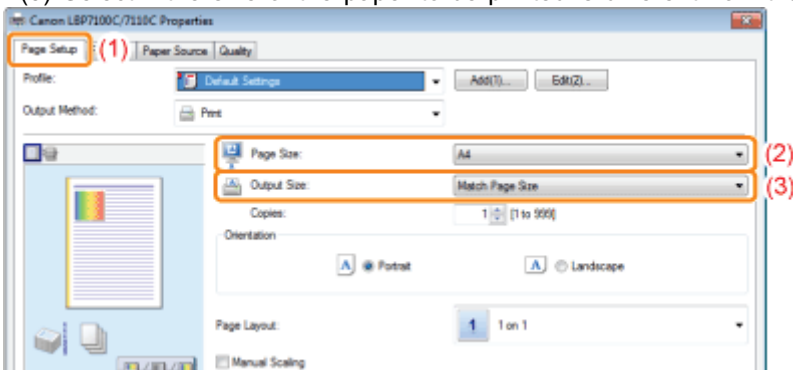

## If the [Page Size] setting and [Output Size] setting are different

The print is automatically reduced or enlarged to fit on the page.

# 7

## Specify the setting for [Paper Type].

(1) Display the [Paper Source] sheet.

(2) Select the type of the paper loaded in the paper source.\*

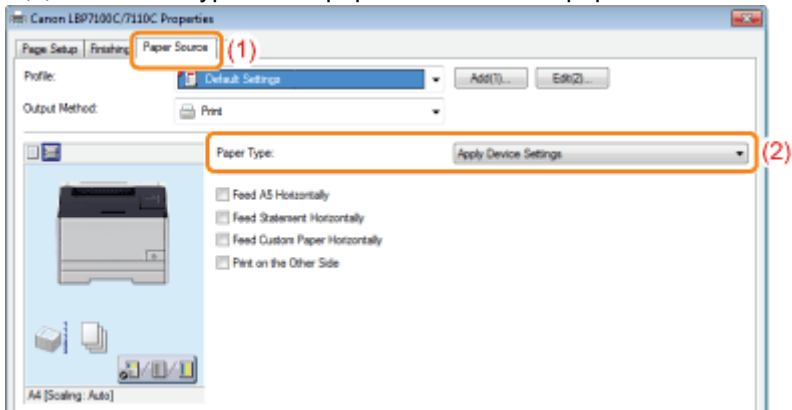

\* Specify the setting according to the paper type as follows.

Paper Type	Setting for [Paper Type]
Plain paper (70 to 85 g/m <sup>2</sup> )	[Plain 1] <sup>*1</sup> (Default)
Plain paper (75 to 90 g/m <sup>2</sup> )	[Plain 2] <sup>*1 *2</sup>
Plain paper (60 to 74 g/m <sup>2</sup> )	[Thin 1] [Thin 2] <sup>*3</sup>
Heavy paper (86 to 120 g/m <sup>2</sup> )	[Heavy 1] <sup>*2</sup>
Heavy paper (121 to 163 g/m <sup>2</sup> )	[Heavy 2]
Transparency (black and white printing only)	[Transparency]
Label	[Labels]
Index Card	[Heavy 2]
Envelope	<ul style="list-style-type: none"><li>Envelope Monarch, Envelope No. 10 (COM10), and Envelope DL: [Envelope] [Envelope H]<sup>*4</sup></li><li>Envelope C5: [Envelope H]</li></ul>
Coated paper (100 to 110 g/m <sup>2</sup> )	[Coated 1]
Coated paper (111 to 130 g/m <sup>2</sup> )	[Coated 2]
Coated paper (131 to 160 g/m <sup>2</sup> )	[Coated 3]
Coated paper (161 to 220 g/m <sup>2</sup> )	[Coated 4]

<sup>\*1</sup> If you want to print paper of 75 to 85 g/m<sup>2</sup>, you can specify either of [Plain 1] or [Plain 2].<sup>\*5</sup>

<sup>\*2</sup> If you want to print paper of 86 to 90 g/m<sup>2</sup>, you can specify either of [Plain 2] or [Heavy 1].<sup>\*5</sup>

<sup>\*3</sup> If the printed paper curls (the printed side curls outward) when 60 g/m<sup>2</sup> paper is printed with [Thin 1] selected, select [Thin 2].

<sup>\*4</sup>

If you want to improve the toner fixation when printed with [Envelope] selected, select [Envelope H].

\*5 If either setting causes the following problems and so on, specify the other setting to print.

- Output paper curls.
- Residual images appear on non-printed areas.
- The toner does not fix onto paper well, and the printing comes out faint.

#### NOTE

##### **About [Apply Device Settings]**

Selecting [Apply Device Settings] uses the [Paper Type] setting in the [Paper Source Settings] dialog box in the Printer Status Window.

(For details on the procedure for setting [Paper Type] in the [Paper Source Settings] dialog box, see "[Registering the Paper Size and Type](#).")

- † When [Apply Device Settings] is selected with the [Paper Type] setting set to [Free] in the [Paper Source Settings] dialog box, the job is printed as [Plain 1].

## 8

### **Specify the other printing preferences as needed.**

- † "[Useful Printing Functions](#)" describes the printing procedures that use the various printing functions. Make full use of the functions of this printer.

#### NOTE

##### **For details on the settings**

See Help.

- ✦ "[How to Use Help](#)"

## 9

### **Confirm the settings, then click [OK].**

→ The [Print] dialog box reappears.

## 10

### **Click [OK].**

→ The printer starts printing.

#### **If the printer cannot print properly**

- ✦ "[Printing Cannot Be Performed \(USB Connection\)](#)"
- ✦ "[Printing Cannot Be Performed \(Wired LAN Connection\)](#)"
- ✦ "[Printing Cannot Be Performed \(Wireless LAN Connection\) \(LBP7110Cw Only\)](#)"
- ✦ "[Printing Cannot Be Performed \(via the Print Server\)](#)"

## Attention (Basic Printing)

---

### IMPORTANT

#### **Checking the paper size and type settings of the paper drawer**

Check that the size and type of the paper loaded in the paper drawer is the same as the registered paper size and type.

➤ ["Registering the Paper Size and Type"](#)

### NOTE

#### **Install the printer driver.**

The printer driver is software required for printing with this printer. Before printing, install the printer driver.

➤ ["Installing the Printer Driver"](#)

#### **When printing on custom size paper**

You need to register the custom paper size in the printer driver previously.

➤ ["Registering a Custom Paper Size"](#)

#### **About the contents specified in "Basic Printing Procedure"**

The specified settings apply only to data to be printed from the same application. Exiting the application resets the changed settings to the default settings.

For details on the procedure for changing the default values for printing preferences, see "[Changing the Default Values for Printing Preferences.](#)"

## How to Use Help

For details on each setting in the printer driver or the Printer Status Window, see the instructions in Help.

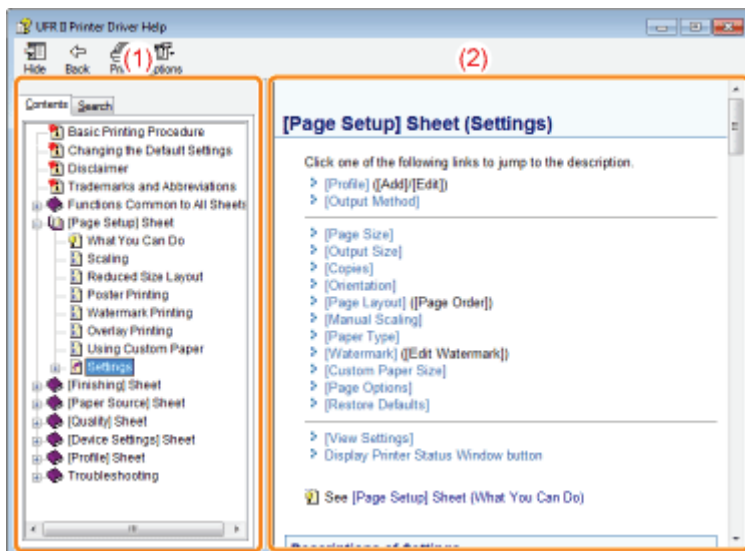

### (1) Navigation pane

Select a topic for your desired option.

- **[Contents]**

In Contents, the titles of the Contexts are displayed.

Click the title of the desired topic to display its description.

- **[Search]**

You can search for all the topics for a particular word or phrase included in the description.

Enter the word or phrase in [Type in the word(s) to search for] and click [List Topics]. Double-click the title of the desired topic to display its description.

### (2) Topic pane

Use the table of contents and full-text search function in the Navigation pane to search for information and display the description of the information.

## How to Display Help

### When displaying Help from the printer driver

Click [Help].

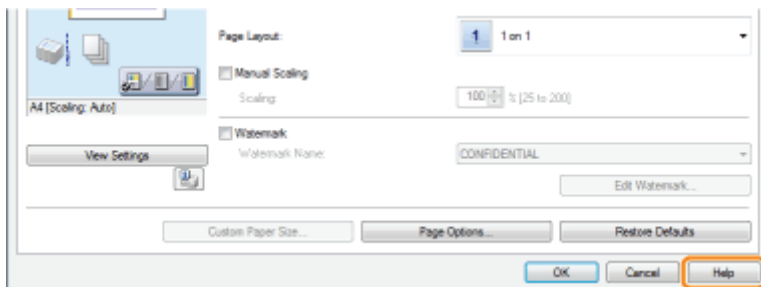

### When displaying Help from the Printer Status Window

From the [Help] menu, select [Help Topics].



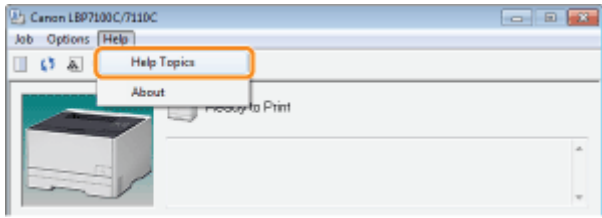

## Canceling a Job

---

You can cancel a print job using either of the following methods.

### **➤ Canceling a Job Being Printed or Waiting to Be Printed from the Computer**

---

You can cancel a job currently being printed with one click or select and cancel a job waiting to be printed from the Printer Status Window.

† If the printer and computer are connected over a network, you can also cancel a print job using the Remote UI.

➤ ["Managing Print Jobs"](#)

### **➤ Canceling a Print Job Being Printed Using the Cancel Job Key**

---

You can cancel a job currently being printed with the Cancel Job Key on the printer.

# Canceling a Job Being Printed or Waiting to Be Printed from the Computer

1

Click [  ] in the Windows task tray, and then select the printer name.



2

Cancel a job.

When canceling a job being printed with one click

Click [  ] (Cancel Job).

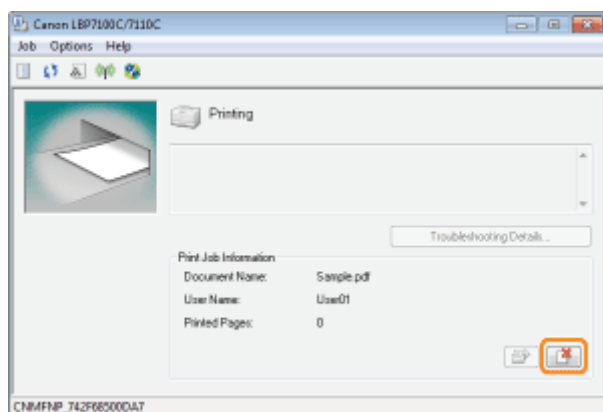

When selecting and canceling a job waiting to be printed

1. Select [Job Status] from the [Job] menu.

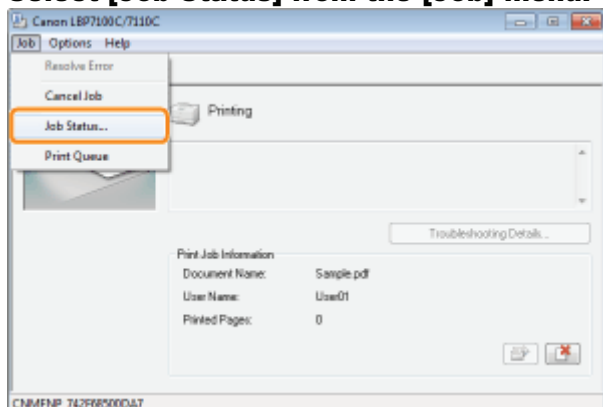

2. Select the job you want to cancel.

- (1) Select the job you want to cancel from [Job List].  
([Job List] displays up to five jobs.)
- (2) Click [Delete].

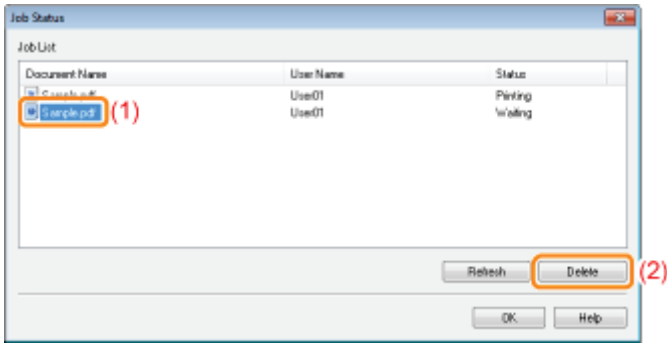

**3. Click [OK].**

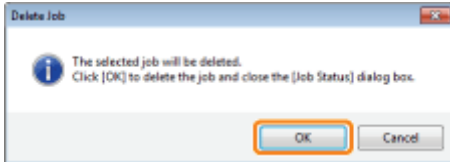

**? If you cannot cancel a job**

You cannot cancel the job whose pages are in the process of printing.

# Canceling a Print Job Being Printed Using the Cancel Job Key

## 1

Pressing the [  ] (Cancel Job) key on the control panel cancels the job being printed.

When the key is released, the printer begins canceling the job.

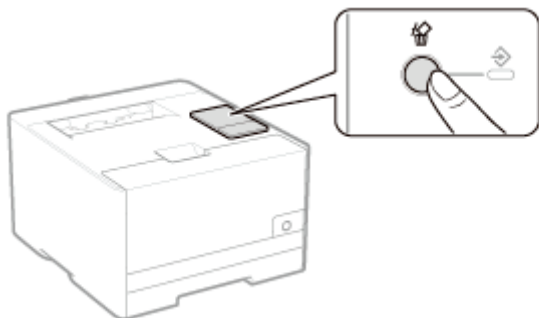

### If you cannot cancel a job

- You cannot cancel the job whose pages are in the process of printing.
- Depending on the settings for the [Settings for Cancel Job Key] dialog box in the Printer Status Window, you may not be able to cancel printing.

### NOTE

#### The meanings of the (Job) indicator (green)

The  (Job) indicator (green) blinks while the printer is canceling a job.

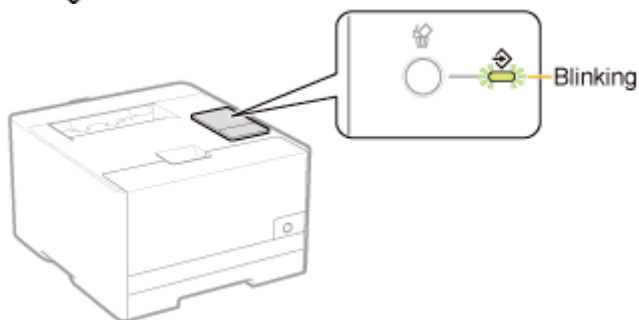

#### Disabling the Cancel Job key

You can disable the Cancel Job key in the [Settings for Cancel Job Key] dialog box in the Printer Status Window. For details on the [Settings for Cancel Job Key] dialog box, see Help.

 ["How to Use Help"](#)

## Checking the Printer Status

You can check the current printer status using the Printer Status Window.

### ❏ "Printer Status Window"

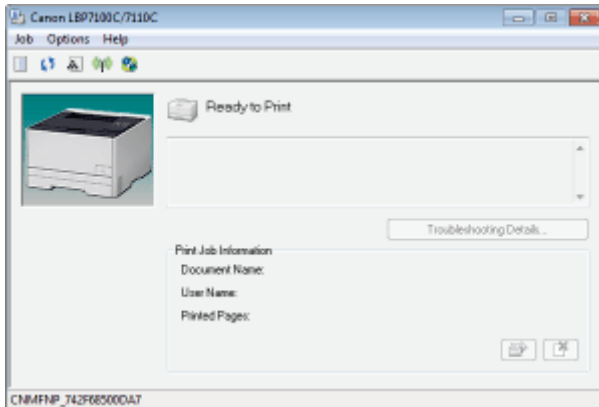

The Printer Status Window shows the current printer status with messages, animations, and icons. If you find any problems with the printer, check the Printer Status Window.

### ✍ NOTE

#### **If the printer and computer are connected via a network**

You can also check the printer status using the Remote UI.

### ❏ "Screen Layout of the Remote UI"

## **Printing on Various Types of Paper**

---

↳ **Printing on Plain Paper, Heavy Paper, or Index Card**

---

↳ **Printing on Transparencies (Black and White Printing Only)**

---

↳ **Printing on Labels**

---

↳ **Printing on Envelopes**

---

↳ **Printing on Coated Paper**

---

↳ **Printing on Custom Size Paper**

---

↳ **Paper Loading Orientation**

---

## Printing on Plain Paper, Heavy Paper, or Index Card

---

### Confirming usable paper

---

This printer can print plain paper (60 to 90 g/m<sup>2</sup>) and heavy paper (86 to 163 g/m<sup>2</sup>) of the following sizes or Index Card.

Standard sizes	A4, B5, A5, Legal, Letter, Executive, Statement, Foolscap, and 16K
Custom paper sizes	<ul style="list-style-type: none"><li>▪ In case of portrait orientation: Width 83.0 to 215.9 mm, Length (Height) 127.0 to 355.6 mm</li><li>▪ In case of landscape orientation: Width 127.0 to 215.9 mm, Length (Height) 127.0 to 215.9 mm</li></ul>

† Recycled paper can be also used.

#### NOTE

##### **When using custom paper sizes**

You need to register the custom paper sizes in the printer driver previously.

➤ ["Registering a Custom Paper Size"](#)

### Loading paper

---

Load paper in the paper drawer.

➤ ["Loading Paper"](#)

### Printing from an application

---

After loading paper, perform printing.

➤ ["Basic Printing Procedure"](#)

† The print speed drops when printing on heavy paper (86 to 163 g/m<sup>2</sup>) or Index Card.  
(The print speed drops when printing on 86 to 90 g/m<sup>2</sup> paper if [Paper Type] is set to [Heavy 1].)



# Printing on Transparencies (Black and White Printing Only)

## Confirming usable transparencies

This printer can use the following sizes of transparencies.

Standard sizes	A4, Letter
----------------	------------

† Transparencies can only be printed in black and white.

## Loading transparencies

Load transparencies in the paper drawer.

➤ ["Loading Paper"](#)

### <Precautions when loading transparencies>

- Thoroughly fan the transparencies, and then align the edges before loading them as they may stick to each other. If they are not fanned enough, multiple sheets of paper may be fed at once, causing paper jams.

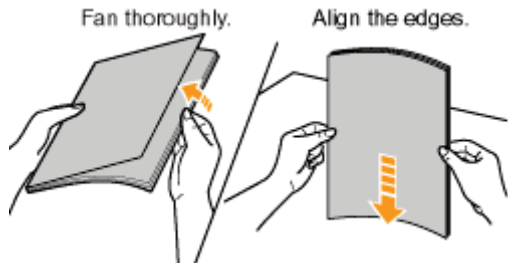

- When fanning or aligning the transparencies, try to hold the edges to avoid touching the printing surface.
- Take care not to mark or stain the printing surface of the transparencies with fingerprints, dust, or oil. This may result in poor print quality.

## Printing from an application

After loading transparencies, perform printing.

➤ ["Basic Printing Procedure"](#)

- † The print speed drops when printing on transparencies.
- † Take out one sheet at a time each time a transparency is output.

# Printing on Labels

## Confirming usable labels

This printer can use the following sizes of labels.

Standard sizes	A4, B5, A5, Legal, Letter, Executive, Statement, Foolscap, and 16K
Custom paper sizes	<ul style="list-style-type: none"><li>• In case of portrait orientation: Width 83.0 to 215.9 mm, Length (Height) 127.0 to 355.6 mm</li><li>• In case of landscape orientation: Width 127.0 to 215.9 mm, Length (Height) 127.0 to 215.9 mm</li></ul>

† Using the following types of labels may result in paper jams that are difficult to clear or may result in damage to the printer.

- Peeled labels or partly used labels
- Coated labels that are easily peeled off from the backing sheet
- Labels with uneven adhesive

### NOTE

#### When using custom paper sizes

You need to register the custom paper sizes in the printer driver previously.

➤ ["Registering a Custom Paper Size"](#)

## Loading labels

Load labels in the paper drawer.

➤ ["Loading Paper"](#)

### <Precautions when loading labels>

- Fan the labels thoroughly, and then align the edges before loading them. If they are not fanned enough, multiple sheets of paper may be fed at once, causing paper jams.

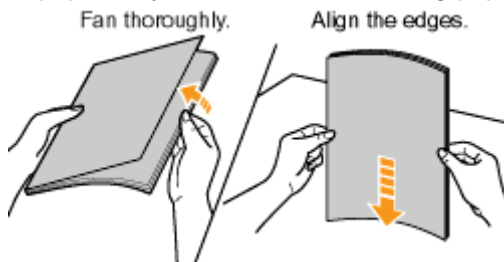

- Take care not to mark or stain the printing surface of the labels with fingerprints, dust, or oil. This may result in poor print quality.

## Printing from an application

After loading labels, perform printing.

➤ ["Basic Printing Procedure"](#)

† The print speed drops when printing labels.

# Printing on Envelopes

## Confirming usable envelopes

This printer can use the following envelopes.

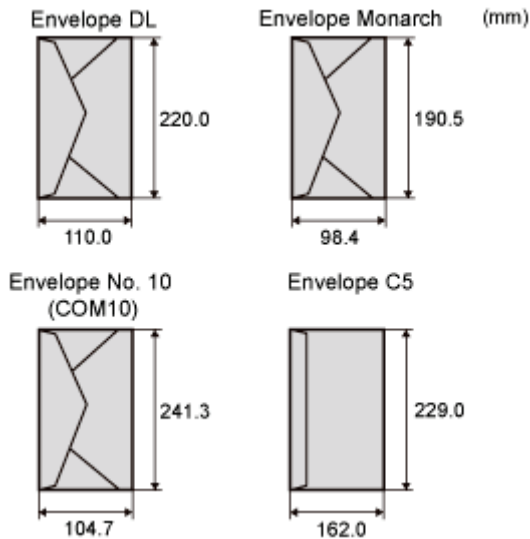

† Using the following types of envelopes may result in paper jams that are difficult to clear or may result in damage to the printer.

- Envelopes with fasteners or snaps
- Envelopes with address windows
- Envelopes with adhesive on the surface
- Wrinkled or creased envelopes
- Poorly manufactured envelopes in which the glued parts are uneven
- Irregularly-shaped envelopes

## Loading envelopes

Load envelopes in the paper drawer.

❖ "Loading Paper"

### <Precautions when loading envelopes>

- Load envelopes in the correct orientation as follows.

(←: Feeding direction)

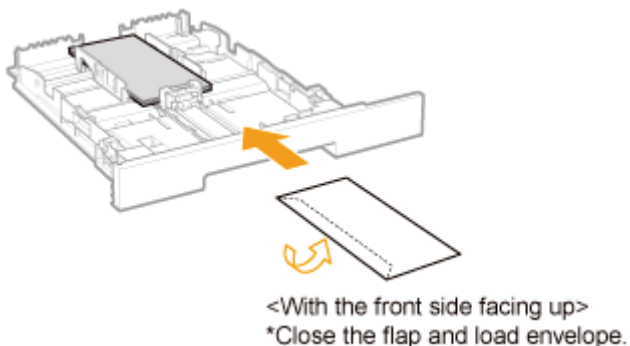

- Before loading envelopes, align them as follows.

1. Place the stack of envelopes on a flat surface, and then flatten them to release any remaining air.

Then, press the edges tightly.

2. Loosen any stiff corners of the envelopes and flatten curls as shown in the figure.

3. Align the edges of the envelopes on a flat surface.

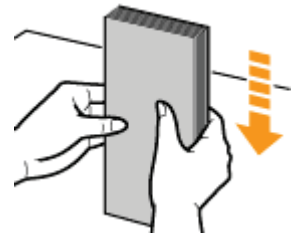
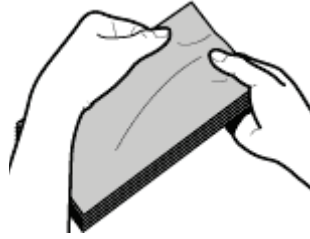
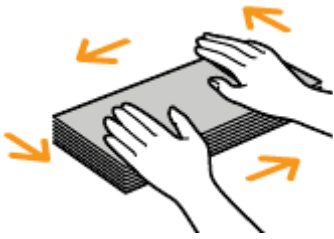

## Printing from an application

---

After loading envelopes, perform printing.

### ➤ "Basic Printing Procedure"

- † Do not print on the reverse side (glued side) of envelopes.
  - † The print speed drops when printing on envelopes.
  - † When envelopes are printed, they may be creased.
-

# Printing on Coated Paper

## Confirming usable coated paper

This printer can use the following sizes of coated paper (100 to 220 g/m<sup>2</sup>).

Standard sizes	A4, B5, A5, Legal, Letter, Executive, Statement, Foolscap, and 16K
Custom paper sizes	<ul style="list-style-type: none"><li>• In case of portrait orientation: Width 83.0 to 215.9 mm, Length (Height) 127.0 to 355.6 mm</li><li>• In case of landscape orientation: Width 127.0 to 215.9 mm, Length (Height) 127.0 to 215.9 mm</li></ul>

### NOTE

#### When using custom paper sizes

You need to register the custom paper sizes in the printer driver previously.

 ["Registering a Custom Paper Size"](#)

## Loading coated paper

Load coated paper in the paper drawer.

 ["Loading Paper"](#)

### <Precautions when loading coated paper>

- Fan the paper stack thoroughly, and then align the edges before loading them. If they are not fanned enough, multiple sheets of paper may be fed at once, causing paper jams.

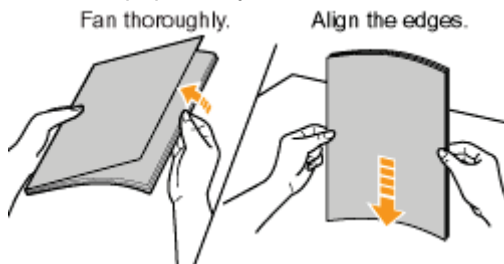

- When fanning or aligning coated paper, try to hold the edges to avoid touching the printing surface.
- Take care not to mark or stain the printing surface of coated paper with fingerprints, dust, or oil. This may result in poor print quality.

## Printing from an application

After loading coated paper, perform printing.

 ["Basic Printing Procedure"](#)

† The print speed drops when printing on coated paper.

# Printing on Custom Size Paper

---

## Confirming usable custom size paper

---

This printer can use the following custom size paper.

- In case of portrait orientation:  
Width 83.0 to 215.9 mm, Length (Height) 127.0 to 355.6 mm
- In case of landscape orientation:  
Width 127.0 to 215.9 mm, Length (Height) 127.0 to 215.9 mm

## Loading custom size paper

---

Load paper in the paper drawer.

- ❖ ["Loading Paper"](#)

## Registering a custom paper size

---

If printing custom size paper, you need to register the custom paper size in the printer driver previously.

- ❖ ["Registering a Custom Paper Size"](#)

## Printing from an application

---

After loading custom size paper, perform printing.

- ❖ ["Basic Printing Procedure"](#)

- † The print speed drops when printing on heavy paper (86 to 163 g/m<sup>2</sup>).  
(The print speed drops when printing on 86 to 90 g/m<sup>2</sup> paper if [Paper Type] is set to [Heavy 1].)

# Registering a Custom Paper Size

## 1

Open the printer folder.

❖ "Basic Operations/Various Information for Windows"

## 2

Right-click the icon for this printer, then select [Printing Preferences] from the pop-up menu.

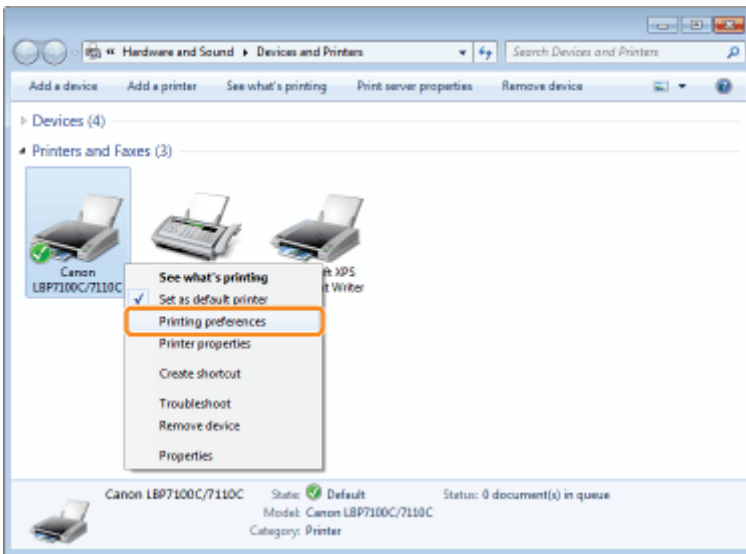

## 3

Display the [Custom Paper Size Settings] dialog box.

- (1) Display the [Page Setup] sheet.
- (2) Click [Custom Paper Size].

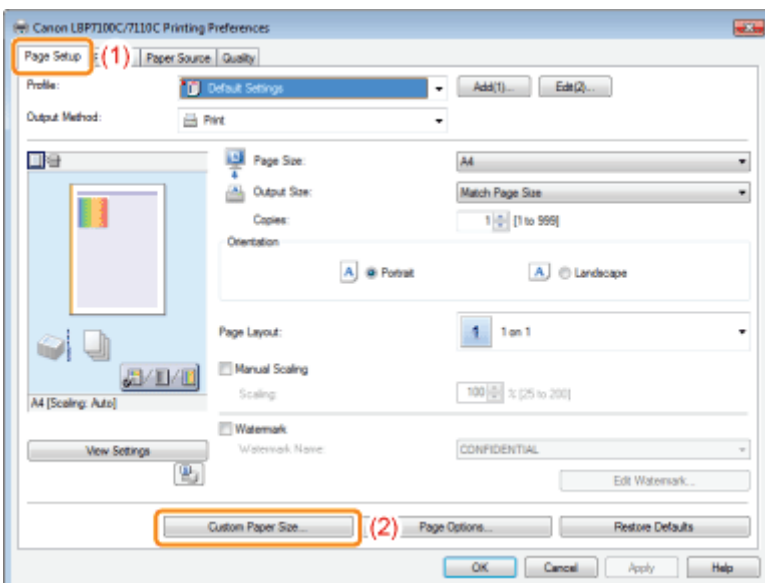

# 4

## Specify the custom paper size.

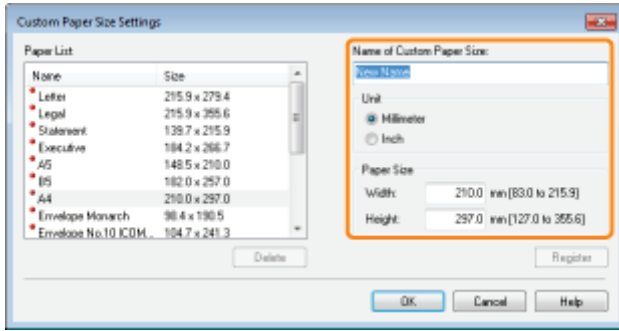

[Name of Custom Paper Size]	Enter the name of the custom paper size to be added. You can enter up to 31 characters.
[Unit]	Select the unit to be used when setting the custom paper size.
[Paper Size]	Specify the height and width of the custom paper size ([Height] ≧ [Width]). Specify the custom paper size in portrait orientation ([Height] ≧ [Width]) within user-definable sizes.

# 5

## Register the custom paper size.

(1) Click [Register].

† The number of custom paper sizes that you can add depends on the system environment.

(2) Confirm that the registered custom paper size is added to [Paper List].

(3) Click [OK].

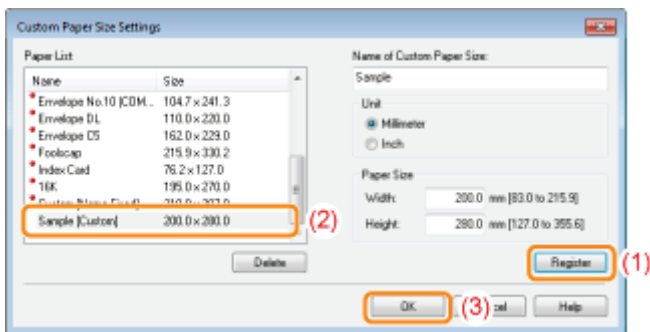

For details on the basic printing procedure, see "[Basic Printing Procedure](#)."



## Paper Loading Orientation

To print paper with letterheads or logos, load the paper in the proper orientation as follows.

† When printing on envelopes, see "Printing on Envelopes."

(←: Feeding direction)

### <Portrait Layout>

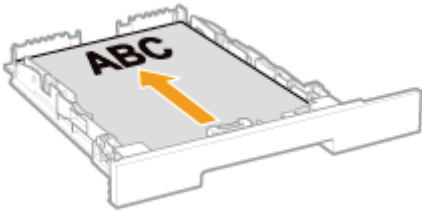

(With the printing side facing up)

### <Landscape Layout>

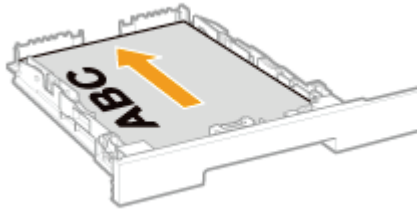

(With the printing side facing up)

### NOTE

#### When loading in landscape orientation

The following paper can also be loaded in landscape orientation.

- A5 paper
- Statement paper
- Custom size paper with a width and length (height) between 127.0 and 215.9 mm

The orientation when loading paper in landscape orientation is as follows.

(←: Feeding direction)

### <Portrait Layout>

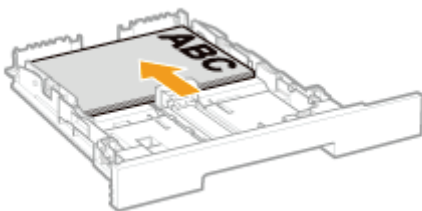

(With the printing side facing up)

### <Landscape Layout>

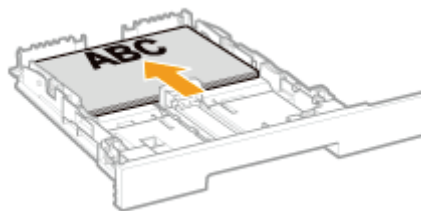

(With the printing side facing up)

# Useful Printing Functions

---

† Parts of the print setting items are not supported for Macintosh. (For items that you can specify in the printer driver for Macintosh, see the Printer Driver Guide for Macintosh (how to display: "[For Macintosh Users](#)") or Help.)

## ↳ [Displaying the Setting Screen](#)

---

## ↳ [Scaling Print Output](#)

---

## ↳ [Layout Printing \(N-page Print\)](#)

---

## ↳ [Printing an Image Larger than A4 \(Poster Printing\)](#)

---

## ↳ [Adding a Watermark to a Document to Be Printed \(Watermark Printing\)](#)

---

## ↳ [Printing Borders, the Printing Date, and so on](#)

---

## ↳ [Printing a Color Document in Black and White](#)

---

## ↳ [Combining Data before Printing](#)

---

## ↳ [Changing the Output Method According to the Print Data or Number of Copies](#)

---

## ↳ [Adjusting the Image Quality or Colors](#)

---

## ↳ [Registering the Printing Preferences](#)

---

- ↳ [Changing the Default Values for Printing Preferences](#)
- ↳ [Saving Frequently Used Printing Preferences \(Adding/Editing/Deleting a "Profile"\)](#)

## Displaying the Setting Screen

You can specify the various printing preferences in the setting screen of the printer driver.  
There are the following methods to display the setting screen.

### Displaying from an application

The specified settings apply only to data to be printed from the same application. Exiting the application resets the changed settings to the default settings.

- **How to display**

(The procedure may differ depending on the application you are using.)

1. Select [Print] from the [File] menu in the application.
2. Select this printer, and then click [Properties] or [Preferences].

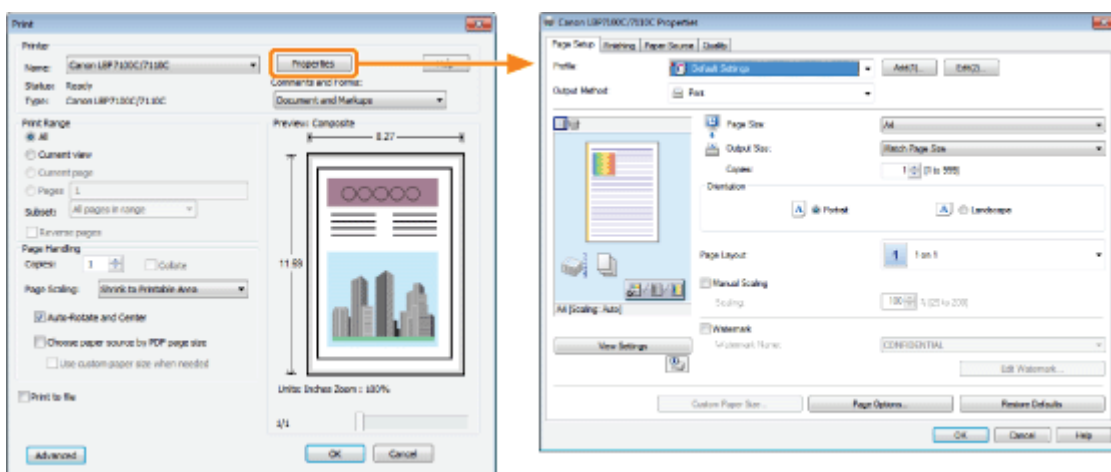

### Displaying from the printer folder (↳ "Basic Operations/Various Information for Windows")

#### <Printing preferences screen>

You can change the default values for printing preferences which apply to all data.

- **How to display**

Right-click the icon for this printer, then select [Printing Preferences] from the pop-up menu.

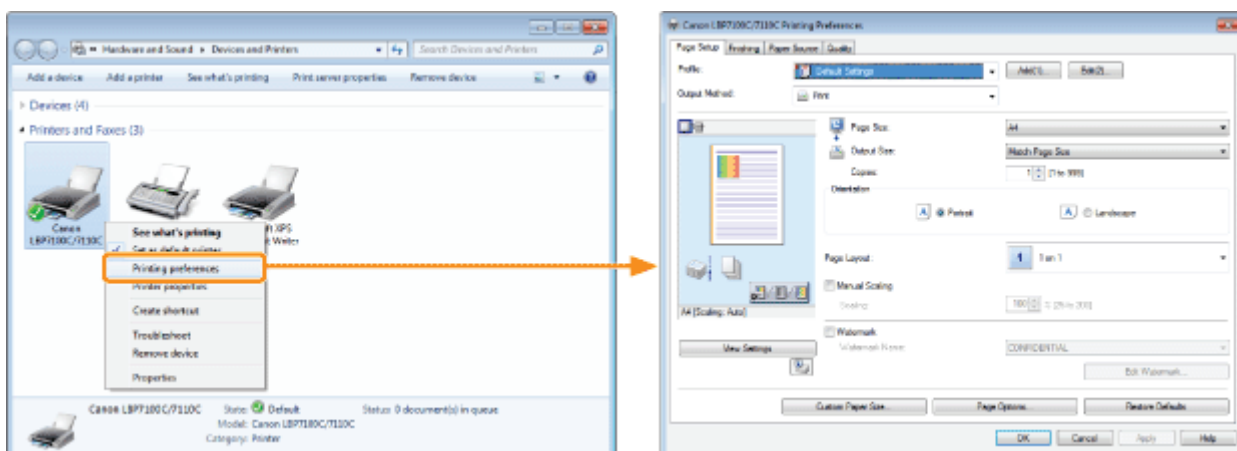

#### <Printer properties screen>

You can specify the settings for the print data processing method, "Profiles" to be added to the server, and so on.

- **How to display**

Right-click the icon for this printer, and then select [Printer properties] or [Properties] from the pop-up menu.

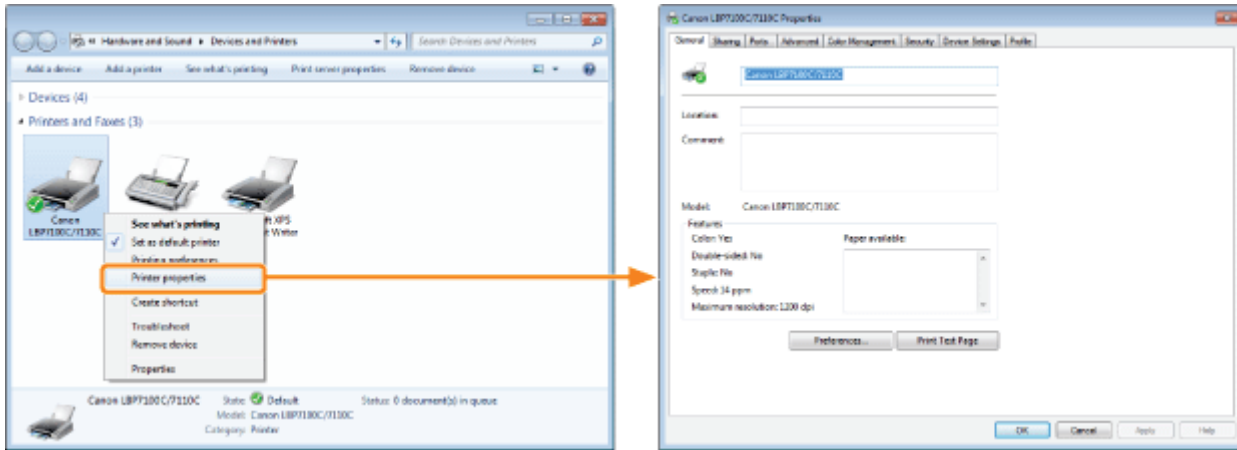

**NOTE**

**For details on the settings**

See Help.

["How to Use Help"](#)

**About the sheets displayed by Windows**

The following sheets are displayed by Windows. For more details, see Windows Help.

- [General] sheet
- [Sharing] sheet
- [Ports] sheet
- [Advanced] sheet
- [Color Management] sheet
- [Security] sheet

**About the printer driver**

The functions of the printer driver may be changed due to upgrade.

## Scaling Print Output

You can print with automatic scaling according to the paper size or arbitrary scaling.

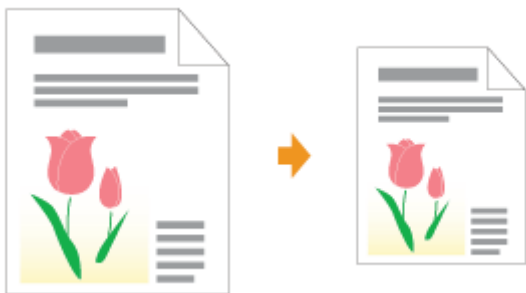

### 1

**Display the setting screen of the printer driver.**

❖ "Displaying the Setting Screen"

### 2

**Specify the settings for scaling.**

#### When printing with automatic scaling according to the paper size

- (1) Display the [Page Setup] sheet.
- (2) Select the page size of the document created by an application.
- (3) Select the size of the paper loaded in the paper source.

If you select a different paper size from [Page Size], the print data will be automatically enlarged or reduced.

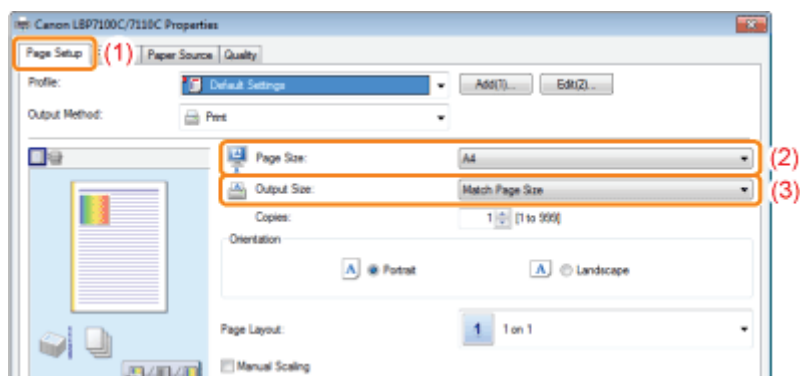

#### When printing with arbitrary scaling

- (1) Display the [Page Setup] sheet.
- (2) Select the [Manual Scaling] check box.
- (3) Specify the desired scaling factor.

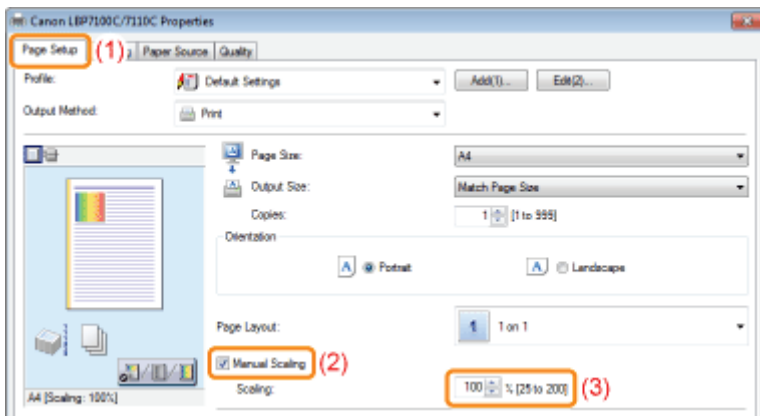

### 3

**Click [OK].**

† For details on the basic printing procedure, see "[Basic Printing Procedure.](#)"

# Layout Printing (N-page Print)

You can print multiple pages on one sheet.

This is a printing method which is referred to as intensive printing or N-page Print.



## IMPORTANT

### About the application function to print a document as a collated set of copies

Some applications provide a function to print a document as a collated set of copies. Do not use this function when printing multiple pages on one sheet. The document may not be printed properly.

## 1

**Display the setting screen of the printer driver.**

❖ "Displaying the Setting Screen"

## 2

**Specify the setting for [Page Layout].**

(1) Display the [Page Setup] sheet.

(2) Select the number of pages to be printed on one sheet.

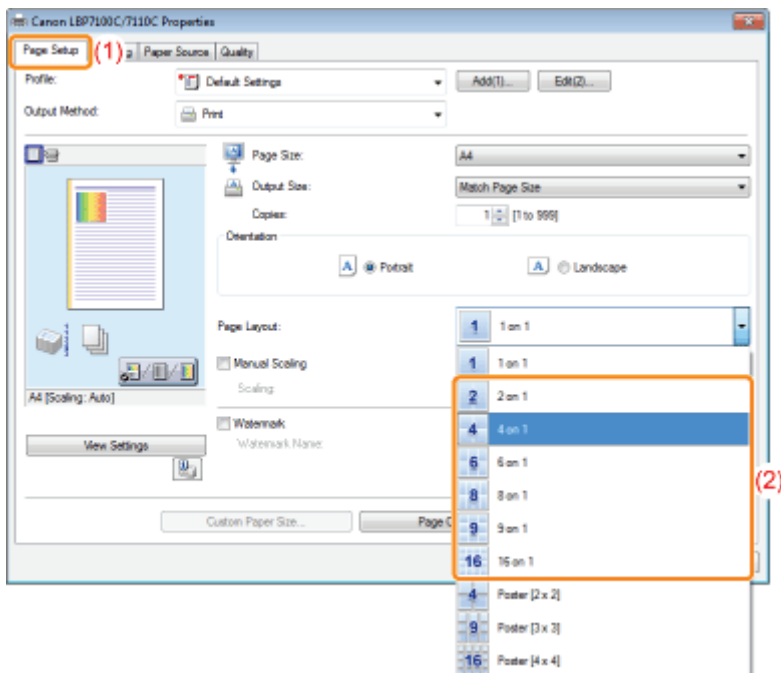

### If you cannot specify the setting

❖ "The Printer Driver Settings Cannot Be Changed"

## NOTE

### Using Preview to specify the setting

You can also specify a page layout by clicking within the document image on Preview when [  ] is selected. (Using Preview to be able to specify is [2 on 1] and [4 on 1] only.)

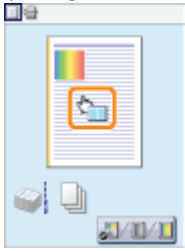

## 3

**Specify the page order layout on paper.**



## 4

**Click [OK].**

† For details on the basic printing procedure, see "[Basic Printing Procedure.](#)"



## Printing an Image Larger than A4 (Poster Printing)

You can enlarge and divide a single page image to print it out on multiple sheets of paper. You can make one large poster by joining these printouts together.



### 1

Display the setting screen of the printer driver.

❖ "Displaying the Setting Screen"

### 2

Specify the setting for poster printing.

- (1) Display the [Page Setup] sheet.
- (2) Select [Poster [N x N]] (N = 2, 3, 4) from [Page Layout].

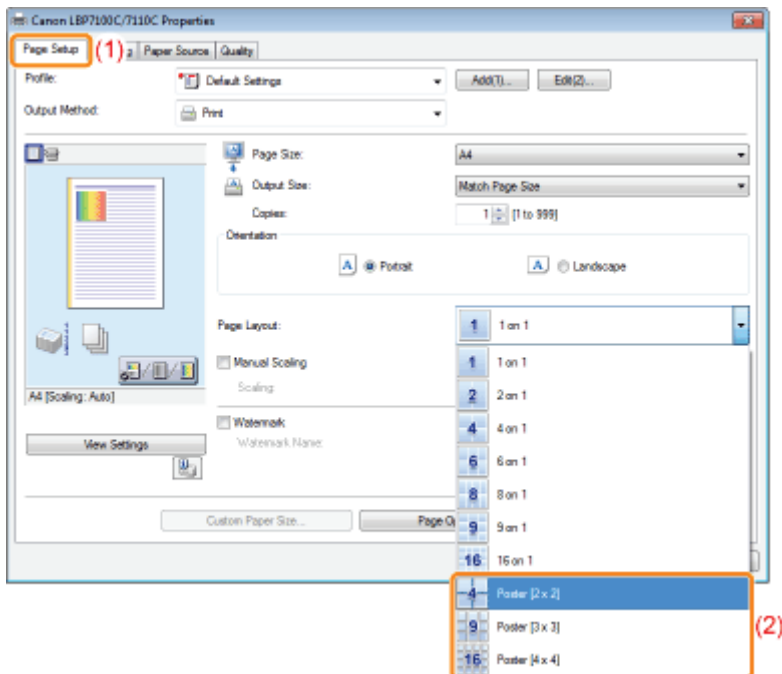

### ? If you cannot specify the setting

❖ "The Printer Driver Settings Cannot Be Changed"

### 3

Click [OK].

† For details on the basic printing procedure, see "[Basic Printing Procedure.](#)"

---

# Adding a Watermark to a Document to Be Printed (Watermark Printing)

You can superimpose watermarks (such as [COPY] and [DRAFT]) over the documents created by an application. Additionally, you can add new watermarks and edit or delete the added watermarks.



## 1

**Display the setting screen of the printer driver.**

➤ "Displaying the Setting Screen"

## 2

**Select a watermark.**

- (1) Display the [Page Setup] sheet.
- (2) Select the [Watermark] check box.
- (3) Select the character string to be printed as a watermark.

† When adding, editing, or deleting a watermark, see "Adding, Editing, or Deleting a Watermark."

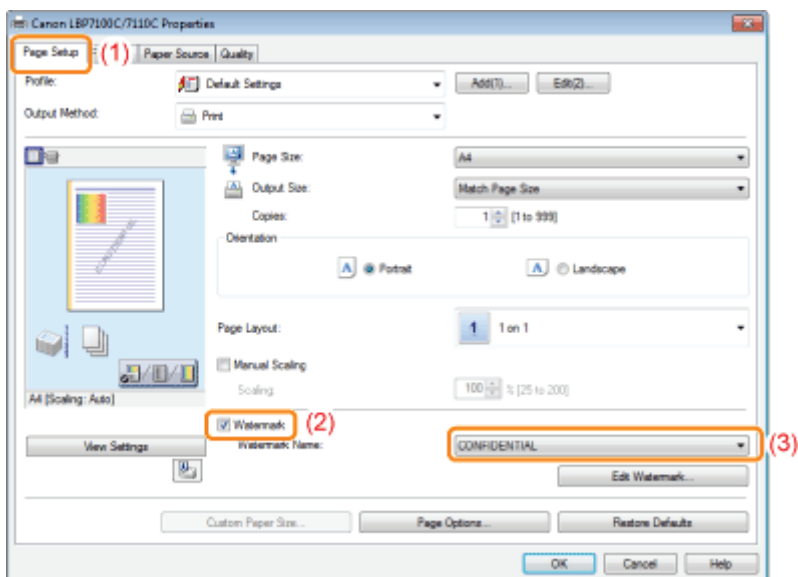

**?** If you cannot select the [Watermark] check box

➤ "The Printer Driver Settings Cannot Be Changed"

## 3

**Click [OK].**

† For details on the basic printing procedure, see "[Basic Printing Procedure.](#)"

---

# Adding, Editing, or Deleting a Watermark

## 1

### Display the [Edit Watermark] dialog box.

- (1) Display the [Page Setup] sheet.
- (2) Select the [Watermark] check box.
- (3) Click [Edit Watermark].

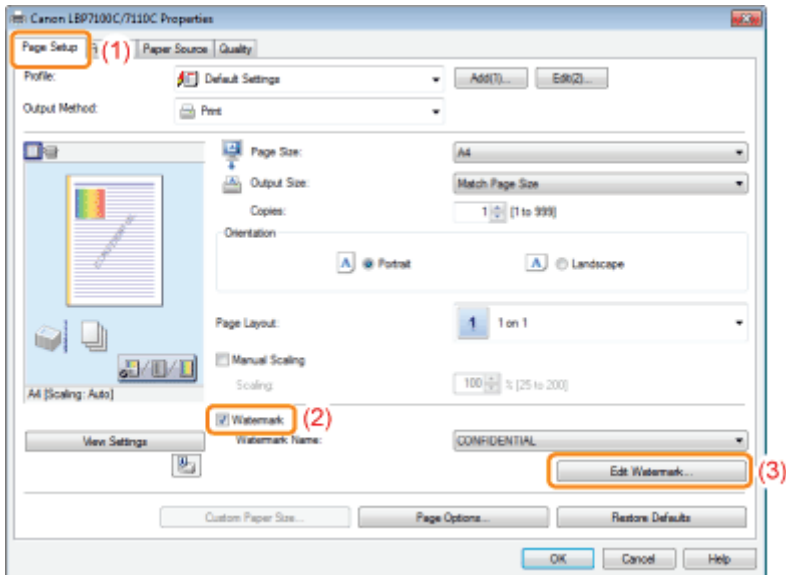

### ? If you cannot select the [Watermark] check box

- ⚡ "The Printer Driver Settings Cannot Be Changed"

## 2

### Add, edit, or delete a watermark.

#### When adding a watermark

- (1) Click [Add].
- (2) Specify each setting.
  - ↑ For more details on each setting, see Help.
    - ⚡ "How to Use Help"

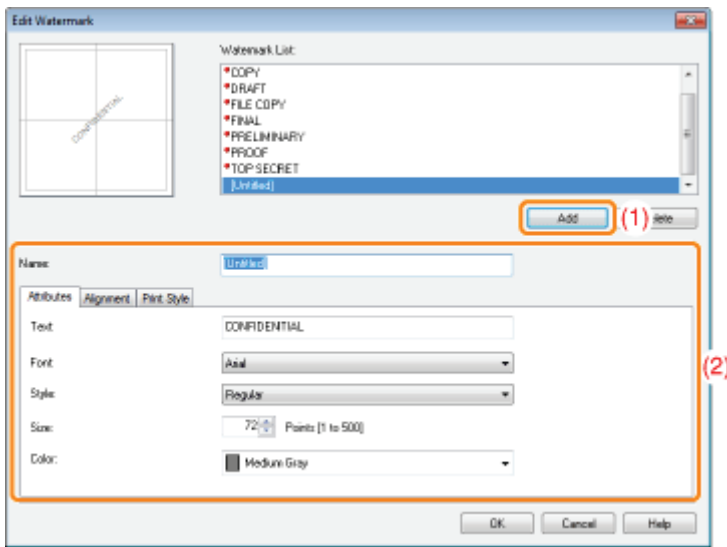

### When editing a watermark

- (1) Select a watermark you want to edit from [Watermark List].
- (2) Edit the watermark.

- † You cannot edit the default watermarks.
- † For more details on each setting, see Help.
  - ["How to Use Help"](#)

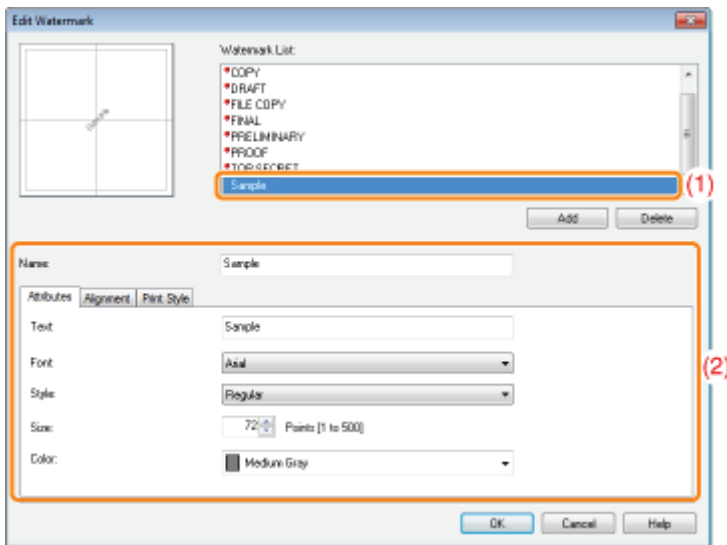

### When deleting a watermark

- (1) Select a watermark you want to delete from [Watermark List].
- (2) Click [Delete].

- † You cannot delete the default watermarks or a watermark which is being selected in the printing preferences dialog box.

- (3) Click [Yes].

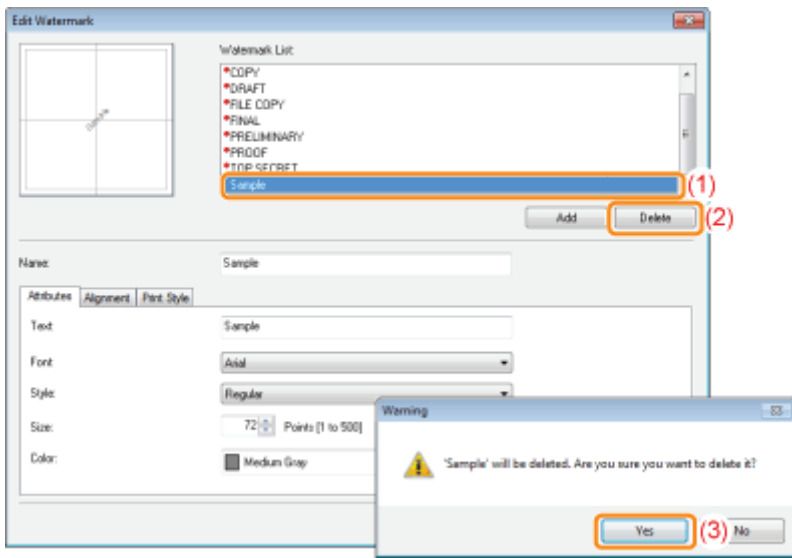

### 3

Click [OK]. Then, the [Page Setup] sheet reappears.

## Printing Borders, the Printing Date, and so on

You can print a border, the date, and page numbers on the document to be printed.



### 1

**Display the setting screen of the printer driver.**

❖ "Displaying the Setting Screen"

### 2

**Display the [Page Options] dialog box.**

- (1) Display the [Page Setup] sheet.
- (2) Click [Page Options].

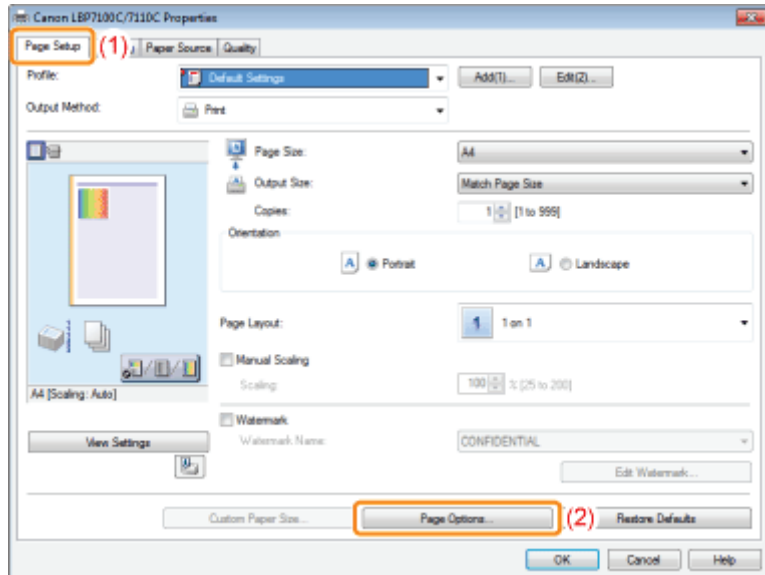

**?** If you cannot click [Page Options]

❖ "The Printer Driver Settings Cannot Be Changed"

### 3

**Specify the settings for borders, the printing date, and so on.**

- (1) Specify each setting.

† For more details on each setting, see Help.





## "How to Use Help"

(2) Click [OK]. Then, the [Page Setup] sheet reappears.

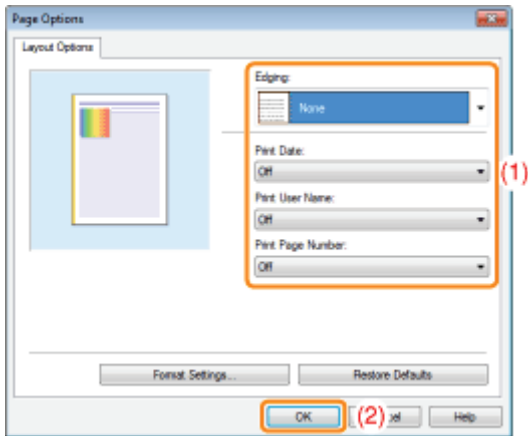

## 4

**Click [OK].**

† For details on the basic printing procedure, see "[Basic Printing Procedure.](#)"

---

# Printing a Color Document in Black and White

Color documents can be printed in black and white using only black toner.

It is convenient if you use this option when printing a test page of color documents.



## 1

**Display the setting screen of the printer driver.**

➤ "Displaying the Setting Screen"

## 2

**Specify the setting for [Color Mode].**

(1) Display the [Quality] sheet.

(2) Select [Black and White].

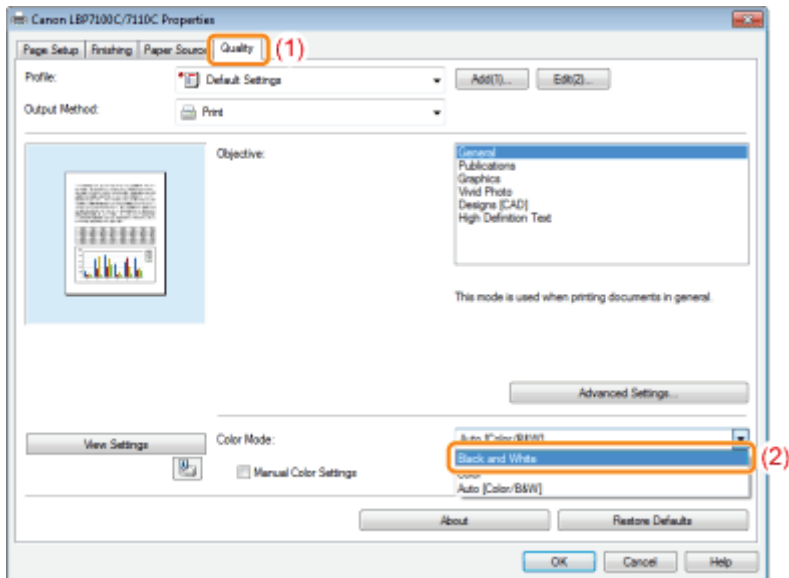

### NOTE

#### Using Preview to specify the setting

You can also specify the setting by clicking the button on Preview in the [Page Setup] sheet, the [Finishing] sheet, and the [Paper Source] sheet.

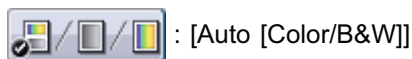

: [Black and White]



### 3

**Click [OK].**

† For details on the basic printing procedure, see "[Basic Printing Procedure.](#)"

## Combining Data before Printing

You can combine two or more data into one.

You can also change the settings for the combined print data and edit print data of different applications.

You can also preview the print data.



### 1

**Display the setting screen of the printer driver from an application.**

➤ "Displaying the Setting Screen"

### 2

**Select [Edit and Preview] from [Output Method].**

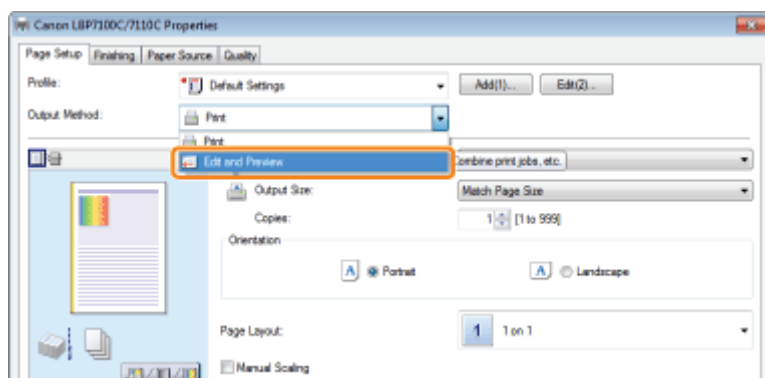

**?** If you cannot select [Edit and Preview]

➤ "The Printer Driver Settings Cannot Be Changed"

### 3

**Click [OK].**



### 4

**Configure the printing preferences.**

- (1) Specify the printing preferences in each sheet as needed.
- (2) Click [OK].

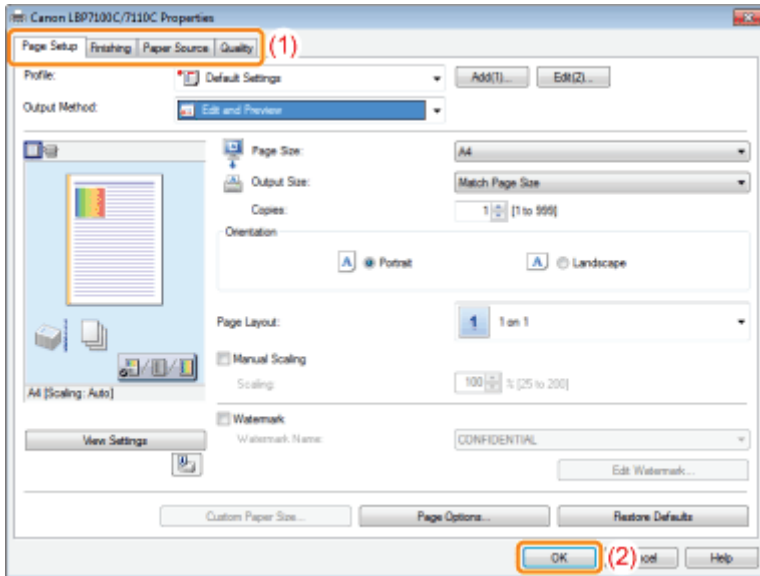

## 5

### Perform printing from an application.

→ The list of print data is displayed in the [Canon PageComposer] dialog box.

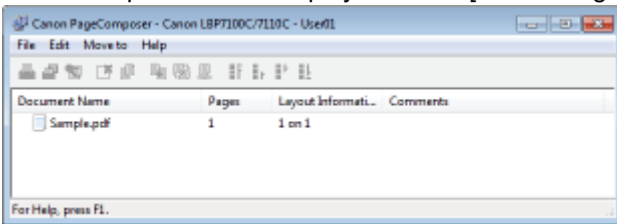

#### NOTE

#### To specify the setting to always display the [Canon PageComposer] dialog box when performing printing

Set [Output Method] to [Edit and Preview] as a default value for printing preferences, and then select the [Lock] check box.

- † For details on the procedure for changing the default values for printing preferences, see "[Changing the Default Values for Printing Preferences.](#)"

## 6

### Repeat Step 1 to 5 to combine the desired data.

## 7

### Combine the print data.

- (1) Select the print data that you want to combine.
- (2) Select [Combine] from the [Edit] menu.

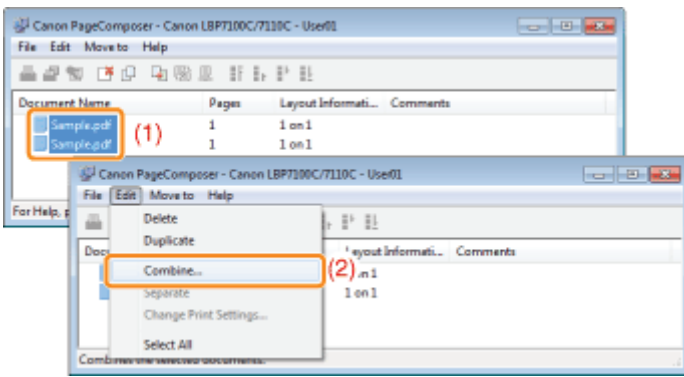

When the following screen appears, read the contents, and then click [OK].

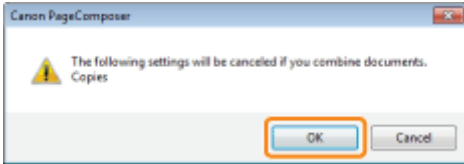

## 8

**Perform the following procedure.**

- (1) Enter the name of the combined print data.
- (2) Click [Combine].

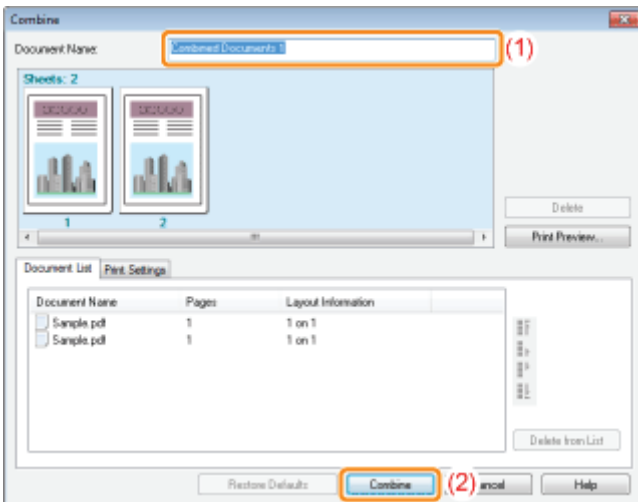

## 9

**Print the combined print data.**

- (1) Select the combined print data.
- (2) Select [Print] from the [File] menu. Then the printer starts printing.

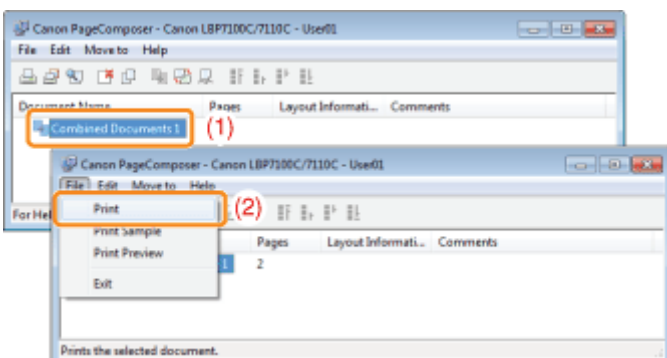

 **NOTE**

**Combined print data are not saved.**

After the combined print data is printed, the print data is deleted from Canon PageComposer.  
The print data is also deleted if Canon PageComposer is closed without printing the print data.

**For more details on Canon PageComposer**

See Help for Canon PageComposer.

† Help is displayed by clicking [Help] in the [Help] menu.

# Changing the Output Method According to the Print Data or Number of Copies

---

[\*\*↳ Printing with a Gutter\*\*](#)

---

[\*\*↳ Selecting the Paper Output Method\*\*](#)

---

[\*\*↳ Printing with the Page 180 Degrees Rotated\*\*](#)

---



## Printing with a Gutter

You can specify a gutter of 0 to 50 mm for the paper to be printed.



### 1

**Display the setting screen of the printer driver.**

❖ "Displaying the Setting Screen"

### 2

**Specify the setting for [Binding Location].**

- (1) Display the [Finishing] sheet.
- (2) Select an edge on which the gutter is to be located.

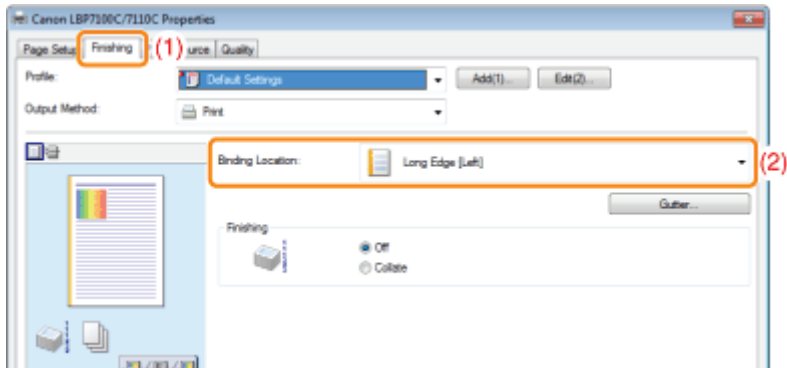

#### NOTE

##### Using Preview to specify the setting

You can also specify the gutter by clicking an edge of the document image on Preview when [ ] is selected.

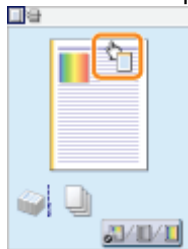

### 3

**Specify the setting for [Gutter].**

- (1) Click [Gutter].
- (2) Specify the gutter width.
- (3) Click [OK]. Then, the [Finishing] sheet reappears.

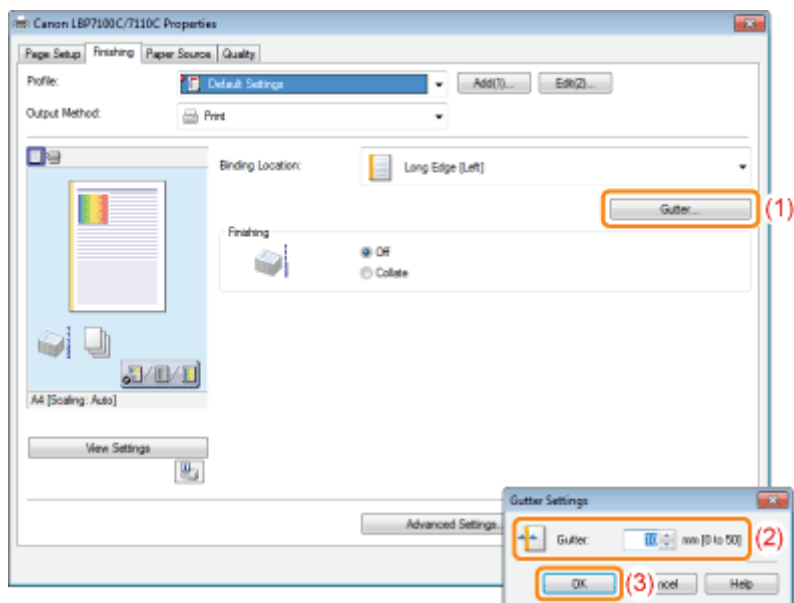

#### **? If you cannot specify the setting**

- "The Printer Driver Settings Cannot Be Changed"

## 4

**Click [OK].**

† For details on the basic printing procedure, see "[Basic Printing Procedure.](#)"

## Selecting the Paper Output Method

You can select the paper output method before printing.

### <If you do not specify the paper output method>

Printouts of a complete job are grouped.



### <If you collate the printouts>

Printouts of a complete job are collated.



## 1

Display the setting screen of the printer driver.

➤ "Displaying the Setting Screen"

## 2

Specify the setting for [Finishing].

- (1) Display the [Finishing] sheet.
- (2) Select a paper output method.

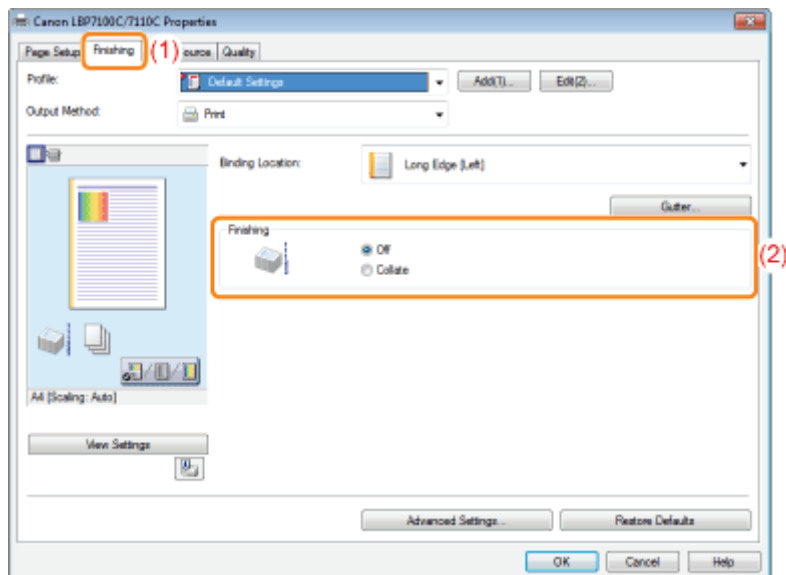

### ? If you cannot specify the setting

➤ "The Printer Driver Settings Cannot Be Changed"

### NOTE

#### Using Preview to specify the setting

You can also specify a paper output method by right-clicking on Preview when [  ] is selected.



### 3

**Click [OK].**

† For details on the basic printing procedure, see "[Basic Printing Procedure.](#)"

## Printing with the Page 180 Degrees Rotated

You can print with the print data rotated 180 degrees when the orientation of the paper loaded in a paper source differs from the orientation of the document.

This option is useful for printing envelopes and Index Card that can be fed only in specific orientations.

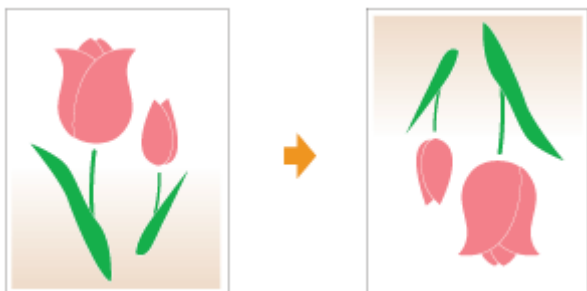

### 1

**Display the setting screen of the printer driver.**

➤ "Displaying the Setting Screen"

### 2

**Display the [Advanced Settings] dialog box.**

- (1) Display the [Finishing] sheet.
- (2) Click [Advanced Settings].

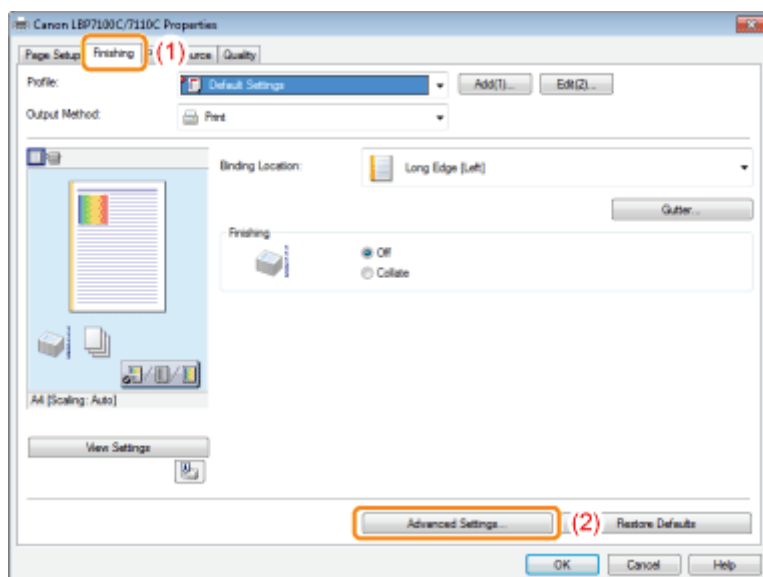

### 3

**Specify the setting for [Rotate Print Data 180 Degrees].**

- (1) Select [Rotate Print Data 180 Degrees].
- (2) Select [On].
- (3) Click [OK]. Then, the [Finishing] sheet reappears.

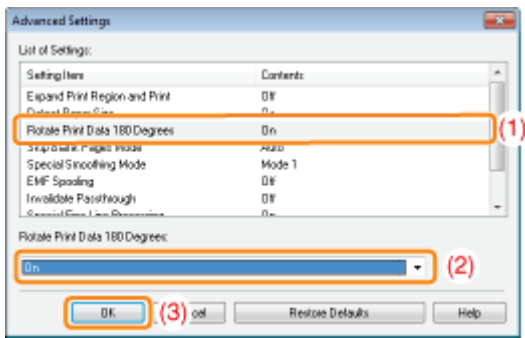

## 4

**Click [OK].**

↑ For details on the basic printing procedure, see "[Basic Printing Procedure.](#)"

## **Adjusting the Image Quality or Colors**

---

**↳ Performing Printing Appropriate for Particular Print Data**

---

**↳ Adjusting the Toner Density**

---

**↳ Printing with Brightness and Contrast Adjusted**

---

**↳ Adjusting the Color**

---

**↳ Matching the Color with the Screen**

---

# Performing Printing Appropriate for Particular Print Data

Selecting the appropriate mode for the contents of the document allows you to perform printing with appropriate setting. For example, if selecting [Vivid Photo] when printing a photo, the setting for printing preferences are changed to the optimum settings for printing photos.

## 1

**Display the setting screen of the printer driver.**

➤ "Displaying the Setting Screen"

## 2

**Specify the setting for [Objective].**

(1) Display the [Quality] sheet.

(2) Select the appropriate mode for the contents of the document.

† Selecting each mode displays a comment on the mode under the list.

† If you want to change the printing preferences for the selected mode to meet your needs, click [Advanced Settings].

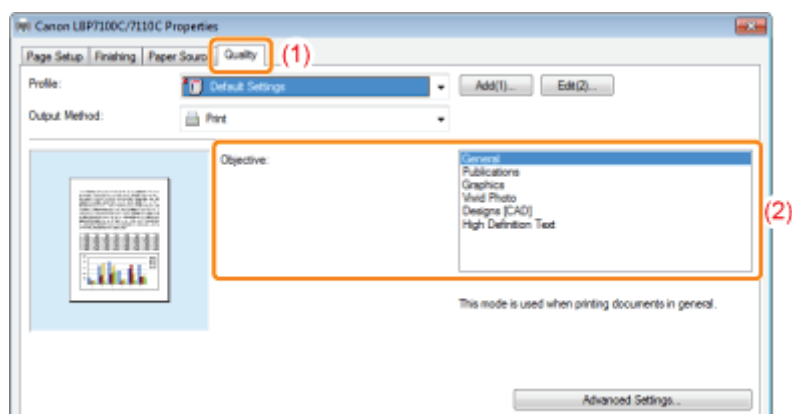

## 3

**Click [OK].**

† For details on the basic printing procedure, see "[Basic Printing Procedure.](#)"



# Adjusting the Toner Density

You can print with toner density adjusted.

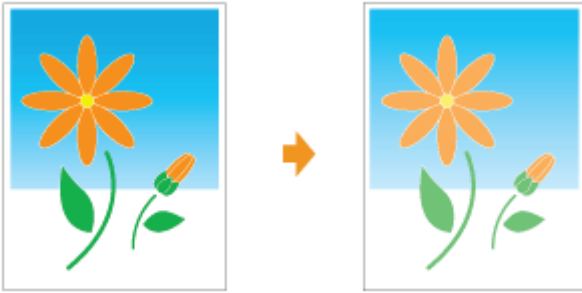

## 1

**Display the setting screen of the printer driver.**

❏ "Displaying the Setting Screen"

## 2

**Display the [Advanced Settings] dialog box.**

- (1) Display the [Quality] sheet.
- (2) Click [Advanced Settings].

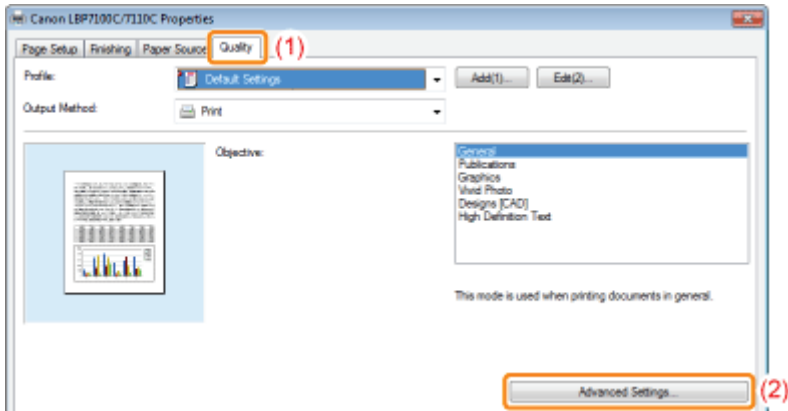

## 3

**Display the [Toner Density Details] dialog box.**

- (1) Select [Toner Density].
- (2) Select [Adjust].
- (3) Click [Details].

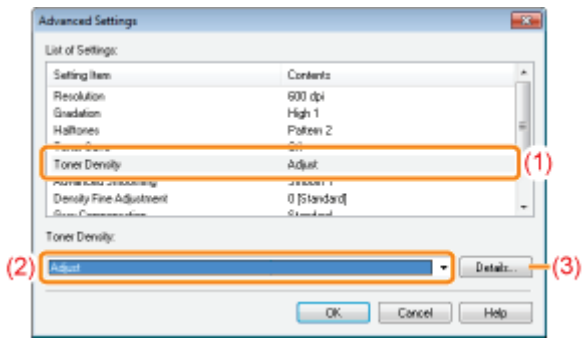

## 4

### Adjust the toner density.

(1) Adjust the density by dragging the slider of each color horizontally.

† You can also adjust the toner density of each color for each density range.

‣ ["Adjusting the Toner Density of Each Color for Each Density Range"](#)

(2) Click [OK]. Then, the [Advanced Settings] dialog box reappears.

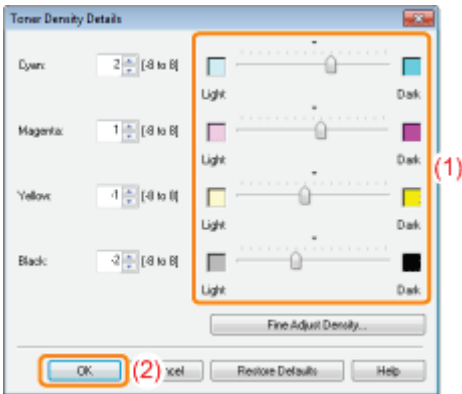

## 5

### Click [OK]. Then, the [Quality] sheet reappears.

## 6

### Click [OK].

† For details on the basic printing procedure, see ["Basic Printing Procedure."](#)

# Adjusting the Toner Density of Each Color for Each Density Range

## 1

Click [Fine Adjust Density].

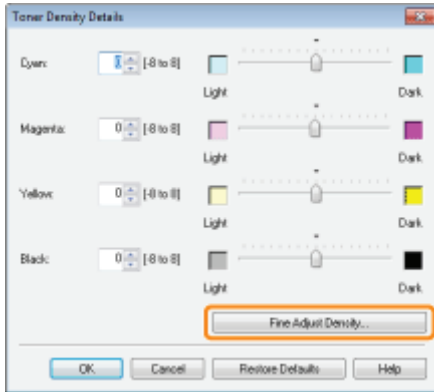

## 2

Adjust the toner density of each color for each density range.

- (1) Display the sheet of the colors that you want to adjust.
- (2) Adjust the density by dragging the slider of each density range horizontally.
- (3) Click [OK]. Then, the [Toner Density Details] dialog box reappears.

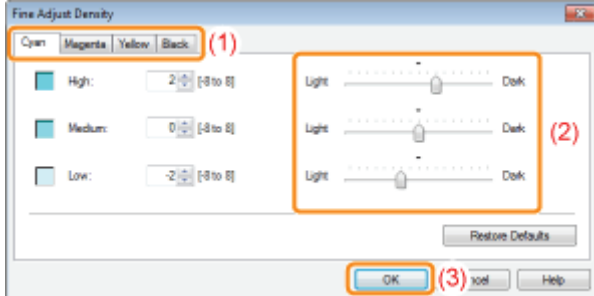

<Adjusting example of each density range> (Example: Cyan)

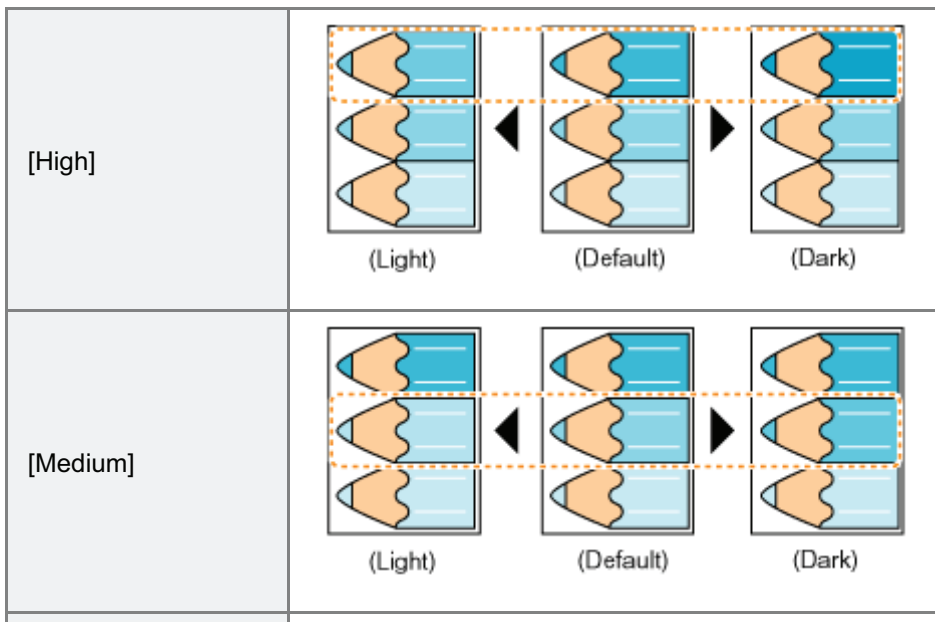

[Low]

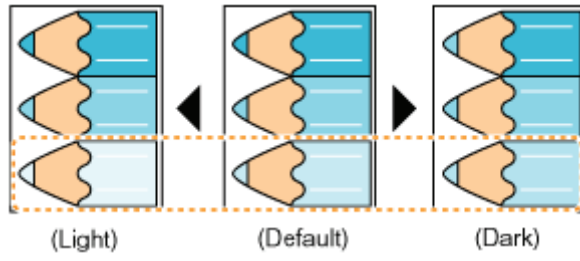

## Printing with Brightness and Contrast Adjusted

You can print with the brightness and contrast adjusted.



### 1

**Display the setting screen of the printer driver.**

❖ "Displaying the Setting Screen"

### 2

**Display the [Color Settings] dialog box.**

- (1) Display the [Quality] sheet.
- (2) Select the [Manual Color Settings] check box.
- (3) Click [Color Settings].

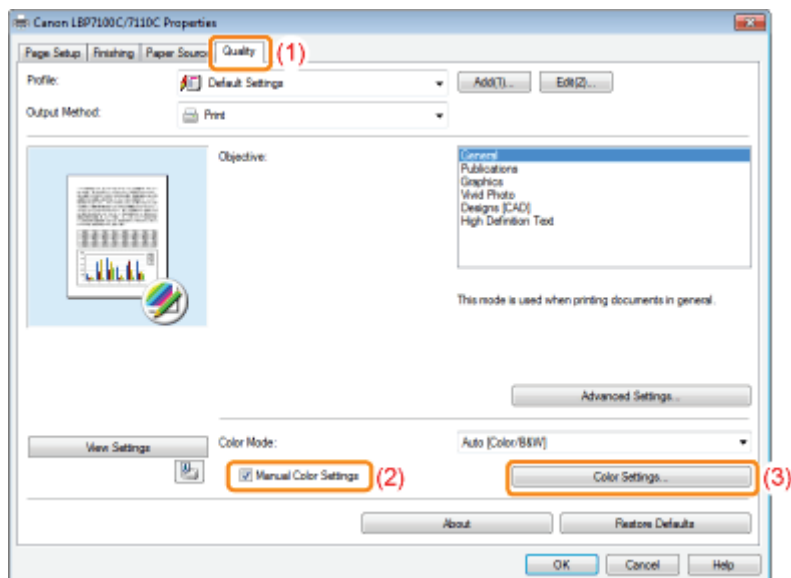

### 3

**Adjust the brightness and contrast.**

- (1) Display the [Color Adjustment] sheet.
- (2) Adjust the brightness and contrast by dragging the [Brightness] and [Contrast] sliders.

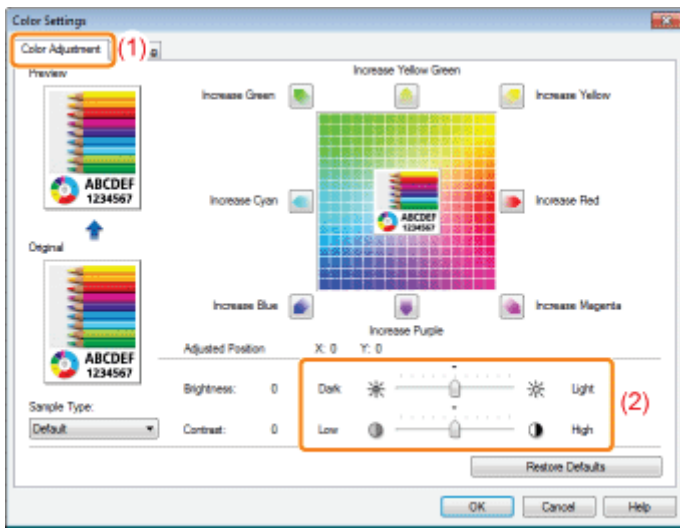

4

Click [OK]. Then, the [Quality] sheet reappears.

5

Click [OK].

† For details on the basic printing procedure, see "[Basic Printing Procedure.](#)"

# Adjusting the Color

You can perform color printing with the color adjusted.



† This section describes the procedure for adjusting the color when printing in the printer driver. Perform calibration when the colors have changed and the data is not printed in the correct colors (specified colors).

❖ "Adjusting Color (Calibration)"

## 1

**Display the setting screen of the printer driver.**

❖ "Displaying the Setting Screen"

## 2

**Display the [Color Settings] dialog box.**

- (1) Display the [Quality] sheet.
- (2) Select the [Manual Color Settings] check box.
- (3) Click [Color Settings].

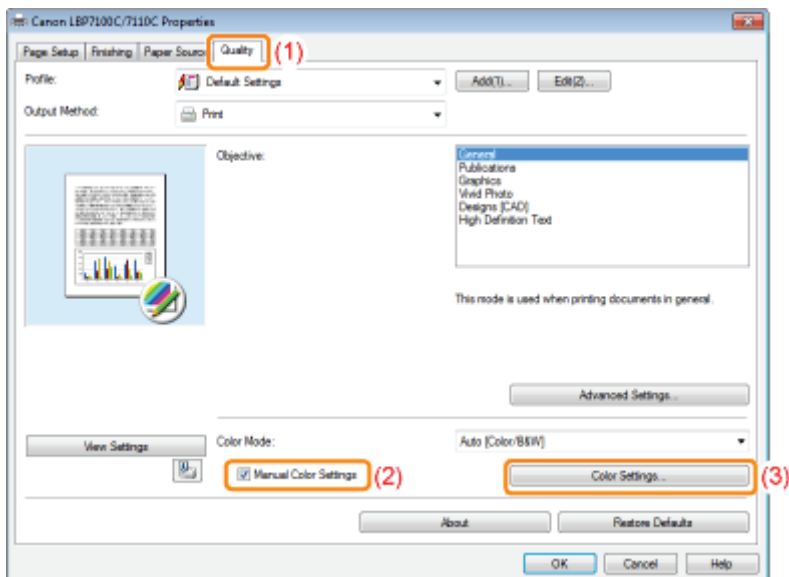

## 3

**Adjust the color.**

- (1) Display the [Color Adjustment] sheet.

(2) Adjust the colors by moving [Preview Image] at the center of the Adjustment Grid horizontally and vertically.\*

- † When [Preview Image] is in the center, the image has not been adjusted.
- † A sample image after adjustment is displayed in [Preview].

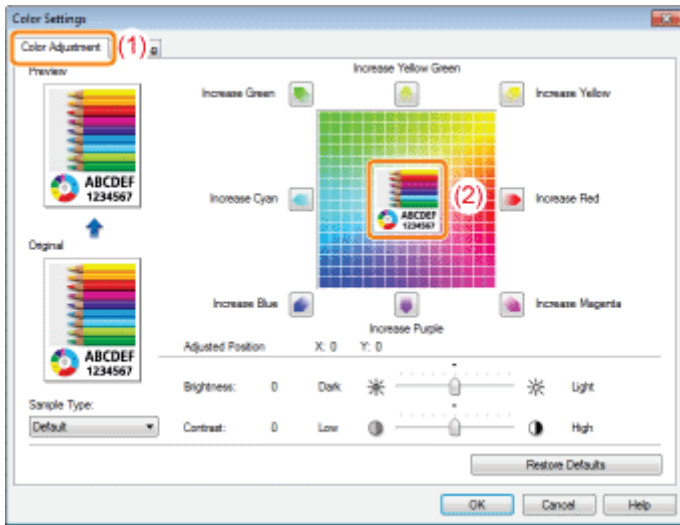

\* Move [Preview Image] by either of the following procedures.

- Click the buttons of each color around the Adjustment Grid (the color is deepened by one increment).
- Click any desired color on the Adjustment Grid ([Preview Image] is moved to the position you clicked).
- Drag [Preview Image] onto the desired color.

#### NOTE

##### **Confirm [Preview Image] position by values.**

You can confirm the position of [Preview Image] by the X (horizontal) and Y (vertical) values for [Adjusted Position]. (The central position is X: 0, Y: 0.)

## 4

**Click [OK]. Then, the [Quality] sheet reappears.**

## 5

**Click [OK].**

† For details on the basic printing procedure, see "[Basic Printing Procedure](#)."



## Matching the Color with the Screen

The methods for adjusting the color on the screen (RGB) and in the printer (YMC) are different. Therefore, color in a photo and so on viewed on the screen may not match that of the printout.

Using the color matching function to correct color of a printout, you can adjust the color of the printout to more closely match the color you see on the screen.

You can also correct the colors by adjusting brightness without performing matching.



### 1

**Display the setting screen of the printer driver.**

➤ "Displaying the Setting Screen"

### 2

**Display the [Color Settings] dialog box.**

- (1) Display the [Quality] sheet.
- (2) Select the [Manual Color Settings] check box.
- (3) Click [Color Settings].

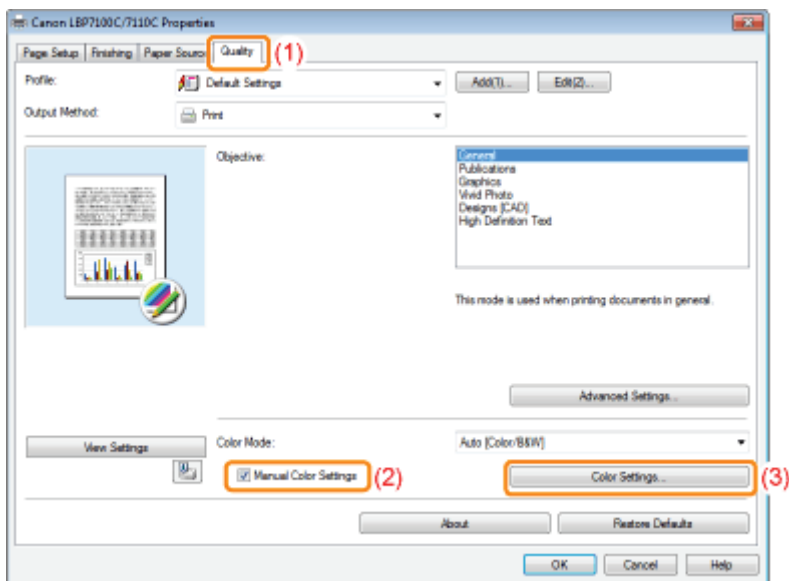

### 3

**Operation procedure varies depending on the procedure for color correction.**

➤ Using the Matching Function to Correct Color

Using the color matching function, you can adjust the color of the printout to more closely match the color you see on the screen.

### ❖ Correcting Color by Adjusting Brightness (Gamma Adjustment)

You can adjust the brightness of the printout results without spoiling the lightest parts and darkest parts of the image data.

Use this option when the printout result is brighter than the original image or when you want to change the brightness of the image.

## Using the Matching Function to Correct Color

### 1. Specify the setting for [Matching Mode].

- (1) Display the [Matching] sheet.
- (2) Select [Driver Matching Mode].

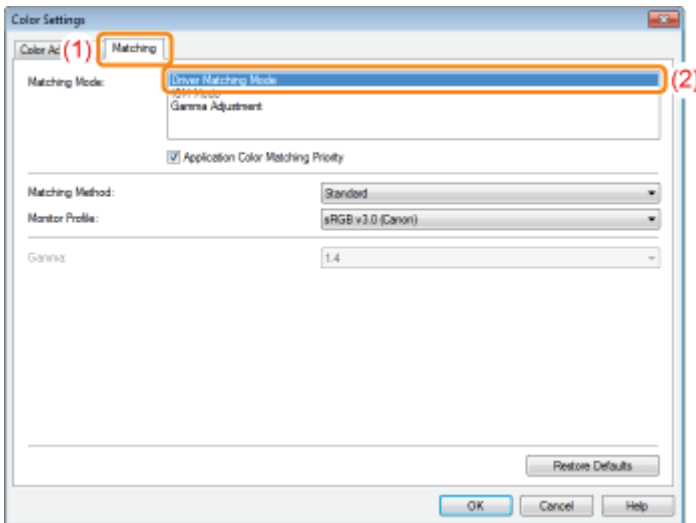

### 2. Specify the setting for [Matching Method].

- (1) Set [Matching Method] to [Perceptual [Monitor Color Matched]].
- (2) Select a profile you want to use.
- (3) Click [OK]. Then, the [Quality] sheet reappears.

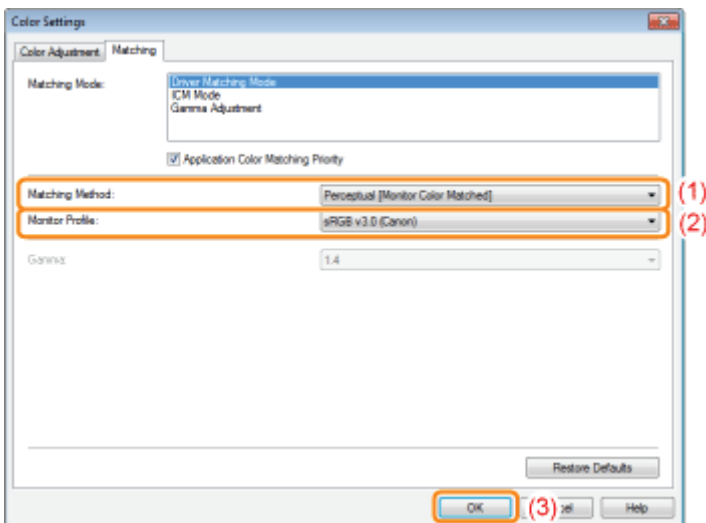

#### NOTE

#### About the options for [Monitor Profile]

The profiles registered in your computer are displayed.

### About [Application Color Matching Priority]

If the check box is cleared, you can prioritize the color matching process specified in the printer driver. If you want to prioritize the color matching in the application, select the check box.

### 3. Click [OK].

† For details on the basic printing procedure, see "[Basic Printing Procedure.](#)"

## Correcting Color by Adjusting Brightness (Gamma Adjustment)

### 1. Specify the setting for [Matching Mode].

- (1) Display the [Matching] sheet.
- (2) Select [Gamma Adjustment].

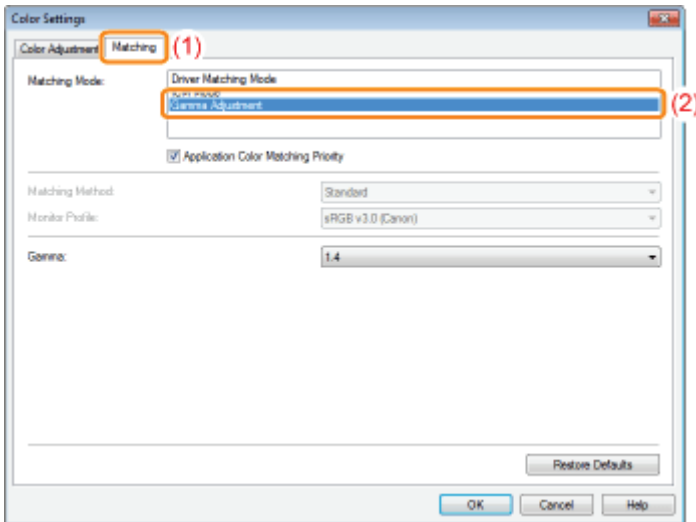

### 2. Specify the setting for [Gamma Adjustment].

- (1) Select a value for gamma.  
† The larger the number is, the darker in color the data is printed.
- (2) Click [OK]. Then, the [Quality] sheet reappears.

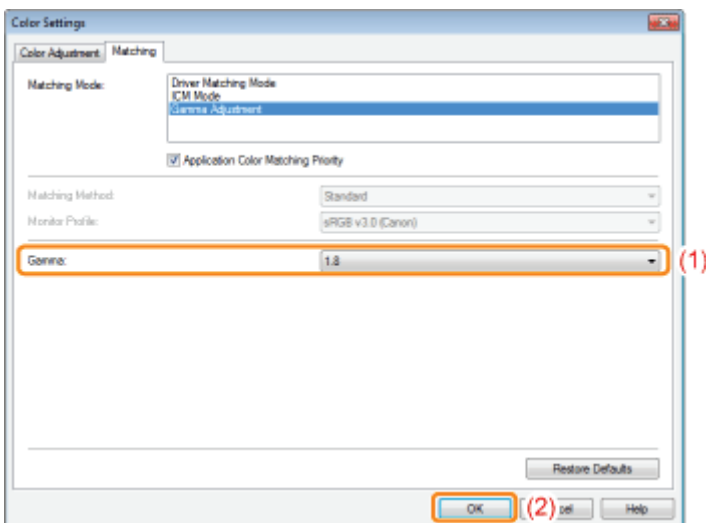

### 3. Click [OK].

† For details on the basic printing procedure, see "[Basic Printing Procedure.](#)"

## Registering the Printing Preferences

### Changing the Default Values for Printing Preferences

Change the default values for printing preferences which apply to all data.

For example, if you perform layout printing frequently, you do not need to change the settings each time you print by changing the default values for [Page Layout].

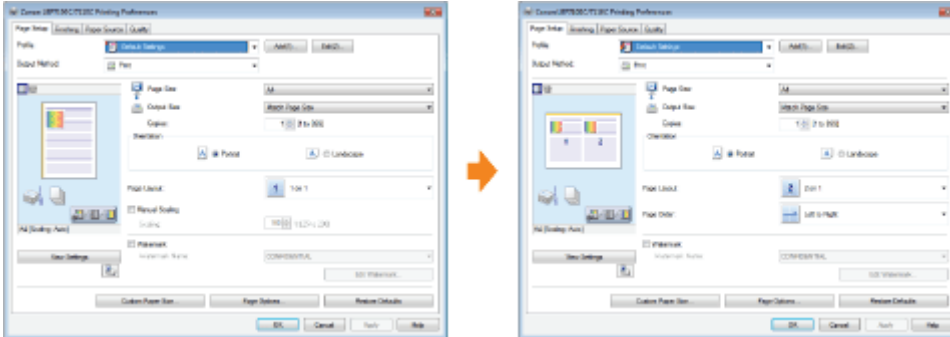

### Saving Frequently Used Printing Preferences (Adding/Editing/Deleting a "Profile")

You can save frequently used multiple printing preferences as "Profiles." You can perform printing with the registered settings by only selecting the desired "Profile."

Also, some settings that support various jobs are registered as the default "Profiles."

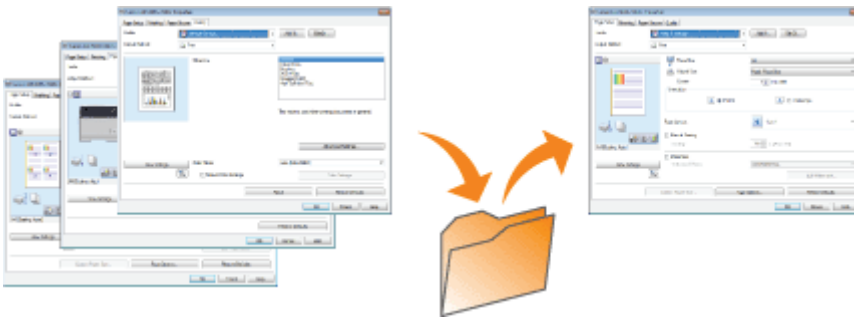

# Changing the Default Values for Printing Preferences

† This function is not supported for Macintosh.

## 1

**Open the printer folder.**

❖ "Basic Operations/Various Information for Windows"

## 2

**Right-click the icon for this printer, then select [Printing Preferences] from the pop-up menu.**

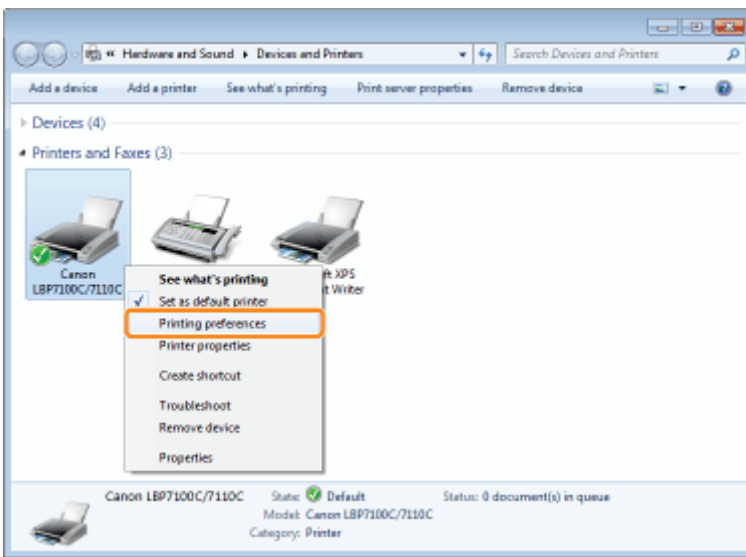

## 3

**Change the printing preferences in the [Page Setup], [Finishing], [Paper Source], and [Quality] sheets.**

The settings changed here become the default values.

For more details on the settings, see Help.

❖ "How to Use Help"

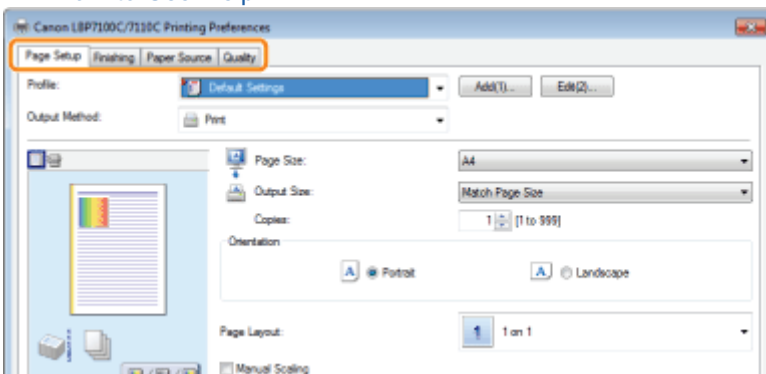

### IMPORTANT

#### **The setting options that are not being changed the default values**

The default values in the settings for [Sample Type] in the [Quality] - [Color Settings] - [Color Adjustment] sheet are not

changed.

---

**4**

**Confirm the settings, then click [OK].**

→ The printer folder reappears.

---

# Saving Frequently Used Printing Preferences (Adding/Editing/Deleting a "Profile")

## Adding a "Profile"

### 1

Display the setting screen of the printer driver.

➤ ["Displaying the Setting Screen"](#)

### 2

Specify the printing preferences in the [Page Setup], [Finishing], [Paper Source], and [Quality] sheets.

The contents specified here is registered in "Profiles."

For more details on the settings, see Help.

➤ ["How to Use Help"](#)

#### IMPORTANT

#### The setting options that are not adding to a "Profile"

The settings for the following options are not added to a "Profile."

Sheet/Dialog Box	Option
[Quality] sheet - [Advanced Settings] dialog box	[Halftones]
	[Gray Compensation]
[Quality] - [Color Settings] - [Color Adjustment] sheet	[Sample Type]

### 3

Click [Add].

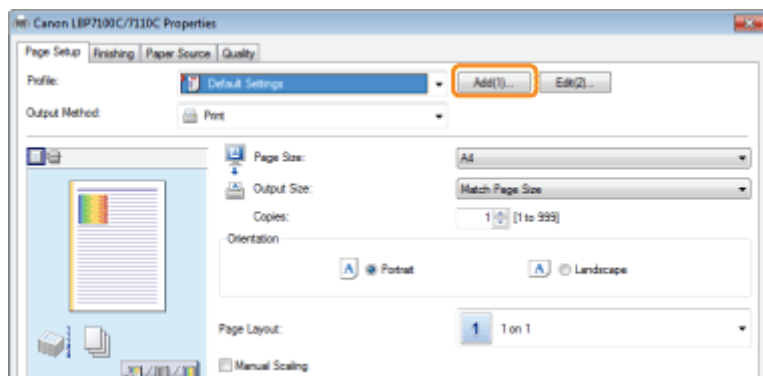

#### If you cannot click [Add]

➤ [""Profiles" Cannot Be Selected or Edited"](#)

# 4

## Specify information about a "Profile."

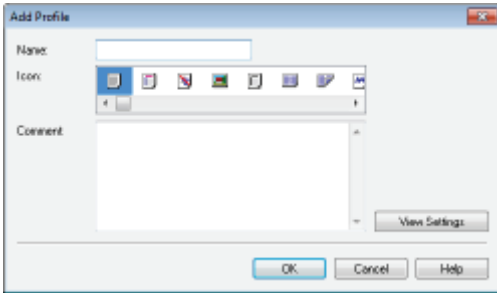

[Name]	Enter the name for "Profiles." You can enter up to 31 characters.
[Icon]	You can select the icon for the "Profile."
[Comment]	Enter the comment for the "Profile." You can enter up to 255 characters.
[View Settings]	Display the [View Settings] dialog box. You can check the current printer driver settings.

# 5

## Click [OK] to register the "Profile."

- The setting screen of the printer driver reappears.  
Make sure that the name of the added "Profile" is in [Profile].

 For details on the procedure for using a "Profile", see "[Selecting a "Profile" .](#)"

## Editing an Added "Profile"

You can change information about an added "Profile" or export a "Profile" as a file.

# 1

## Display the setting screen of the printer driver.

- ❖ "[Displaying the Setting Screen](#)"

# 2

## Click [Edit].

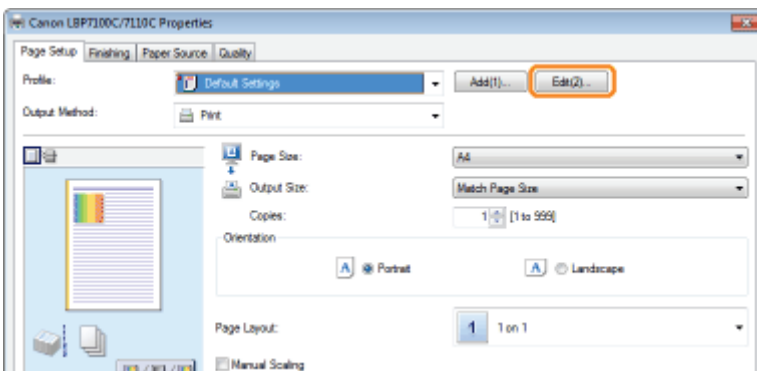



## **?** If you cannot click [Edit]

➤ "'Profiles" Cannot Be Selected or Edited"

# 3

## **Edit information about a "Profile."**

For more details on the settings, see Help.

➤ "How to Use Help"

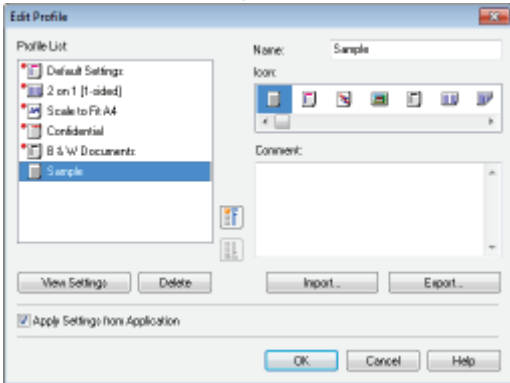

# 4

**Click [OK].**

→ The setting screen of the printer driver reappears.

## **Deleting an Added "Profile"**

# 1

**Display the setting screen of the printer driver.**

➤ "Displaying the Setting Screen"

# 2

**Click [Edit].**

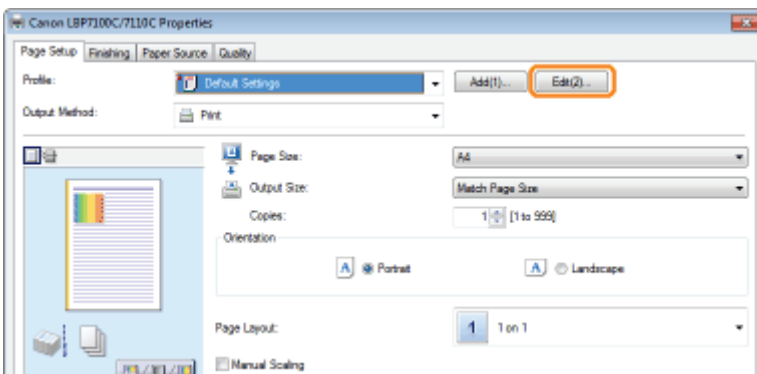

## **?** If you cannot click [Edit]

➤ "'Profiles" Cannot Be Selected or Edited"

# 3

## Delete a "Profile."

- (1) Select a "Profile" you want to delete.
- (2) Click [Delete].

† You cannot delete the default "Profiles" or a "Profile" which is being selected in the setting screen of the printer driver.

- (3) Click [Yes].

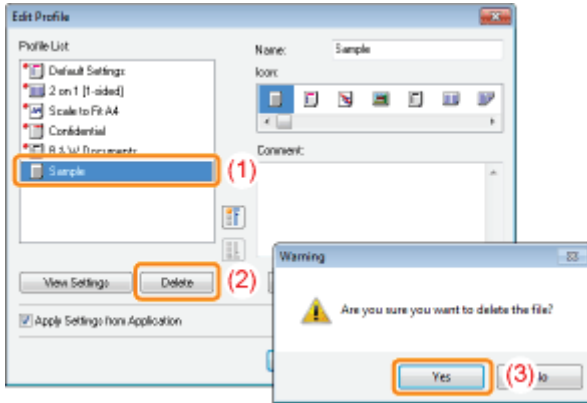

# 4

## Click [OK].

→ The setting screen of the printer driver reappears.

# Selecting a "Profile"

## 1

Display the setting screen of the printer driver.

➤ "Displaying the Setting Screen"

## 2

Select a "Profile."

† If the printer name is changed, any added "Profiles" cannot be used. To use the added "Profile", change the printer name to its previous one.

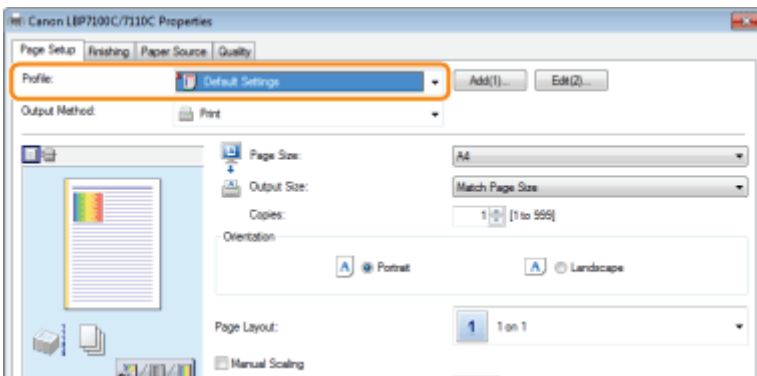

### ❓ If you cannot select a "Profile"

➤ ""Profiles" Cannot Be Selected or Edited"

### NOTE

#### When selecting [Default Settings]

Reset all the settings to the default values other than the following options.

Sheet/Dialog Box	Option
[Quality] sheet - [Advanced Settings] dialog box	[Halftones]
	[Gray Compensation]
[Quality] - [Color Settings] - [Color Adjustment] sheet	[Sample Type]

## 3

Click [OK].

† For details on the basic printing procedure, see "Basic Printing Procedure."

# Configuring the Network Settings (Sharing the Printer)

---

## ❏ Checking Your Printing Environment

---

### ❏ If You Use the Printer by Direct Connection

---

- ❏ Basic Network Settings
- ❏ Changing the Network Settings for the Printer
- ❏ Checking the IP Address of the Printer
- ❏ Checking the MAC Address of the Printer
- ❏ Checking the Wireless LAN Information (LBP7110Cw Only)
- ❏ Configuring and Changing the Port

### ❏ If You Use the Printer in the Print Server Environment

---

- ❏ Configuring the Print Server
  - ❏ Installation on Clients
-

## Checking Your Printing Environment

When you share the printer with multiple computers, the setting procedure varies depending on your environment.

### ▸ If You Use the Printer by Direct Connection

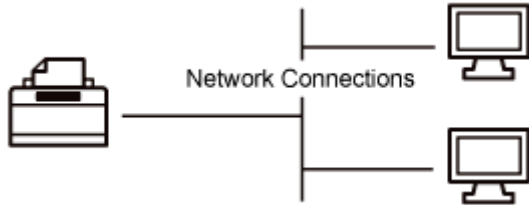

### ▸ If You Use the Printer in the Print Server Environment

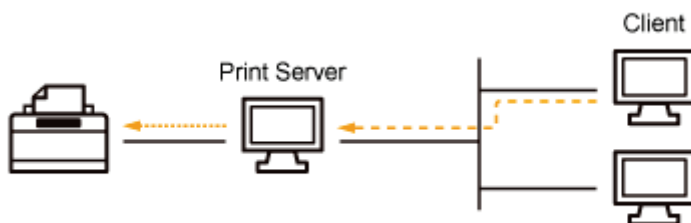

#### <About the print server environment>

If you set one of the computers on a network as the print server, you can manage the printer efficiently as follows.

- You can manage the clients' printing preferences on the print server.
- Clients can download and install the printer driver from the print server. (The CD-ROM is not required.)

## If You Use the Printer by Direct Connection

You can use this printer as a printer directly connected to a network.

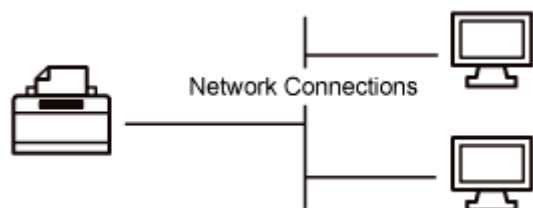

Because the printer is configured to obtain the IP address automatically, you can use the network without making any special settings, and you may be able to change the network settings to suit your environment.

### ➤ Basic Network Settings

---

- Switching Between Wireless LAN and Wired LAN for the Connection (LBP7110Cw Only)
- Specifying the Connection Settings
- Setting a Port and Installing the Printer Driver

### ➤ Changing the Network Settings for the Printer

---

- Configuring the Protocol Settings
- Specifying the Wired LAN Communication Mode and Transmission Speed
- Specifying the Waiting Time Until Connected to the Network
- Initializing the System Settings

### ➤ Checking the Wireless LAN Information (LBP7110Cw Only)

---

### ➤ Checking the MAC Address of the Printer

---

### ➤ Configuring and Changing the Port

---

- Changing the Port Configuration

#### 📌 NOTE

##### **When installing the printer driver**

It is recommended that normally the printer driver be installed using "Easy Installation" on the supplied CD-ROM (CD-ROM Setup).

You can specify the printer connection settings and install the printer driver using "Easy Installation" as a series of operations. The e-Manual is also installed simultaneously.

- "Easy Installation"

##### **If you changed the IP address after installing the printer driver**

When you use MFNP Port, the port does not have to be changed because a new IP address is detected automatically when the printer and computer are on the same subnet.

When you use Standard TCP/IP Port, the port to be used with the printer driver should be changed.

- "Configuring and Changing the Port"

† If you do not know which port you are using, see "[Basic Operations/Various Information for Windows.](#)"

---

## Basic Network Settings

---

**Before you use the printer on the network, the settings of the computer and network devices must be completed.**

- † If the settings are not completed, you cannot use the printer on the network.
- † For details, see the instruction manual of your network device or contact the manufacturer.
- † LBP7110Cw supports wireless LAN, but a wireless LAN connection cannot be used at the same time as a wired LAN connection.
- † For use in an office, consult your network administrator.

### ➤ **Switching Between Wireless LAN and Wired LAN for the Connection (LBP7110Cw Only)**

---

### ➤ **Specifying the Connection Settings**

---

### ➤ **Setting a Port and Installing the Printer Driver**

---

- † It is recommended that normally the printer driver be installed using "Easy Installation" on the supplied CD-ROM (CD-ROM Setup).  
You can specify the printer connection settings and install the printer driver using "Easy Installation" as a series of operations. The e-Manual is also installed simultaneously.
  - "Easy Installation"



# Switching Between Wireless LAN and Wired LAN for the Connection (LBP7110Cw Only)

† The wired LAN connection is set by default.

## Switching from Wired LAN to Wireless LAN

Perform the following procedure.

**1. If the printer driver is installed, uninstall it.**

➤ ["Uninstalling the Printer Driver"](#)

**2. Using "Easy Installation" to specify the settings of the wireless LAN connection and install the printer driver**

➤ ["Easy Installation"](#)

† You can specify the printer connection settings and install the printer driver using "Easy Installation" as a series of operations.

### NOTE

**You cannot use a wired LAN and wireless LAN at the same time.**

When using the printer with a wireless LAN connection, do not connect a LAN cable to the printer. This may result in malfunction.

## Switching from Wireless LAN to Wired LAN

Perform the following procedure.

**1. If the printer driver is installed, uninstall it.**

➤ ["Uninstalling the Printer Driver"](#)

**2. Using "Easy Installation" to specify the settings of the wired LAN connection and install the printer driver**

➤ ["Easy Installation"](#)

† You can specify the printer connection settings and install the printer driver using "Easy Installation" as a series of operations.

† To specify the printer connection settings, select [Custom Setup].

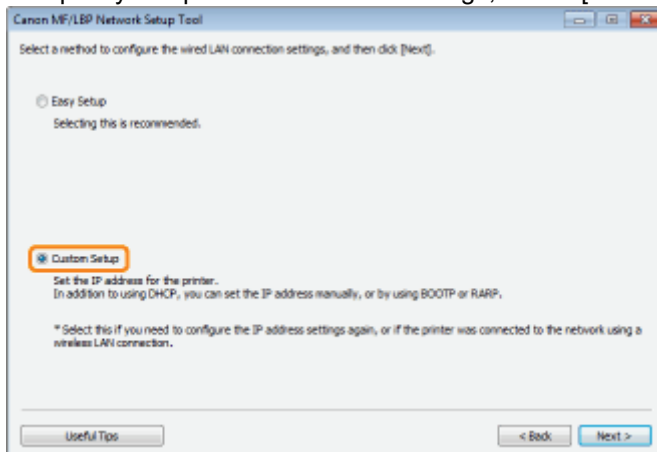

† To set a port and install the printer driver from the printer folder, specify the printer connection settings (➤ ["Specifying the Connection Settings"](#)), and then see ["Setting a Port and Installing the Printer Driver"](#) to install the printer driver.

## Specifying the Connection Settings

Use "MF/LBP Network Setup Tool" to specify the network connection settings.

### ❖ "Directly Starting the MF/LBP Network Setup Tool"

† For the system requirements of "MF/LBP Network Setup Tool," see "[MF/LBP Network Setup Tool](#)."

† When you install the printer driver using "Easy Installation," "MF/LBP Network Setup Tool" starts automatically.

### ❖ "Easy Installation"

Before specifying the settings, see "[Connecting the Printer and Computer](#)."

The setting procedure varies depending on your environment. Follow the instructions on the screen to specify the settings.

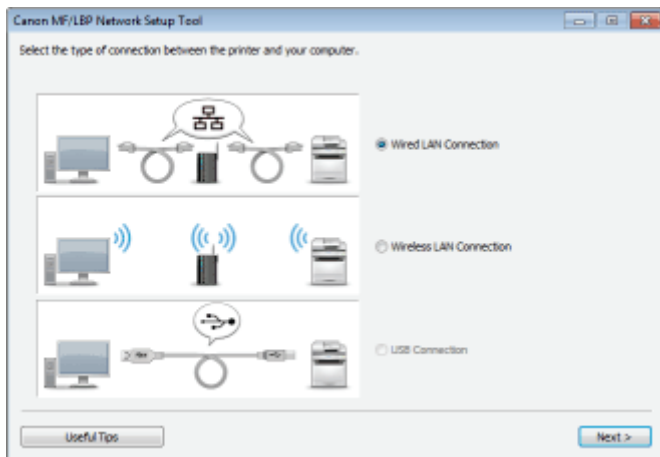

### ? If you have a problem during the connection settings

Click [Useful Tips] at the bottom left of the screen and see the help contents.

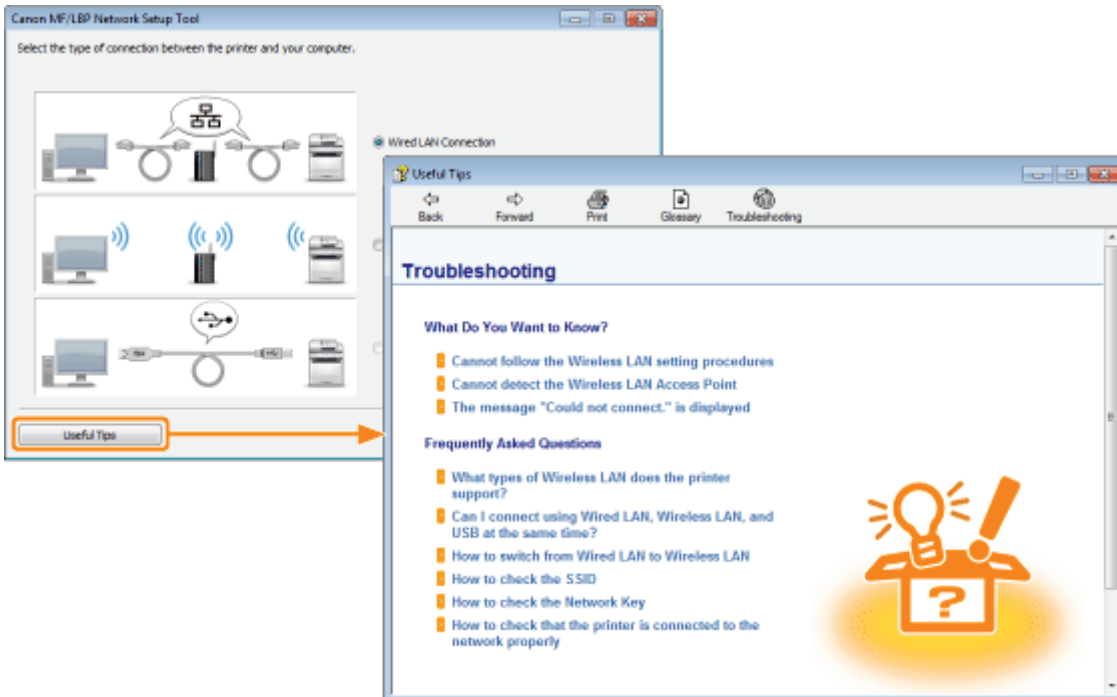

### NOTE

#### Setting the IP address using the ARP/PING command

You can also set the IP address using the ARP/PING command in Command Prompt.

### ❖ "[Basic Operations/Various Information for Windows](#)"

## Setting a Port and Installing the Printer Driver

The installation procedure varies depending on the operating system. See the appropriate procedure according to your operating system.

- ❖ [Windows Vista, 7, and Server 2008](#)
- ❖ [Windows XP and Server 2003](#)

† It is recommended that normally the printer driver be installed using "Easy Installation" on the supplied CD-ROM (CD-ROM Setup).

You can specify the printer connection settings and install the printer driver using "Easy Installation" as a series of operations. The e-Manual is also installed simultaneously.

- ❖ ["Easy Installation"](#)

### Windows Vista, 7, and Server 2008

## 1

**Make sure that the printer and computer are connected properly, and the printer is turned ON.**

- ❖ ["Connecting the Printer and Computer"](#)

## 2

**Turn the computer on, and then log on to Windows as a user with administrative rights.**

## 3

**Open the printer folder.**

- ❖ ["Basic Operations/Various Information for Windows"](#)

## 4

**Click [Add a printer].**

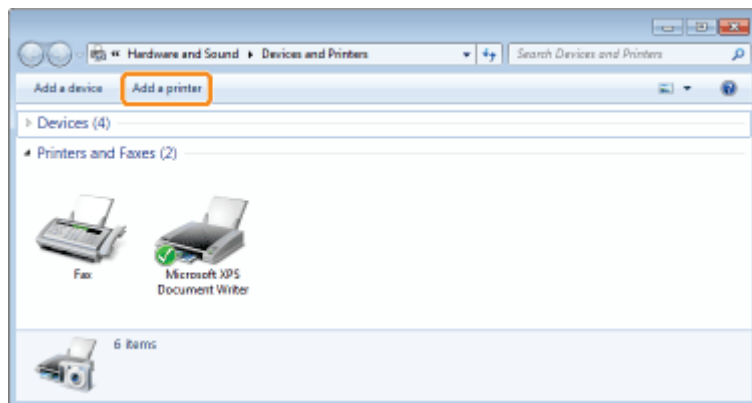

## 5

**Click [Add a local printer].**

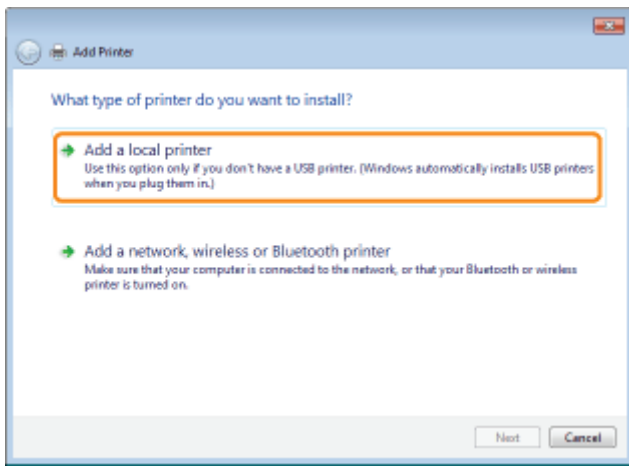

## 6

### Create a port.

- (1) Select [Create a new port].
- (2) Select [Standard TCP/IP Port].
- (3) Click [Next].

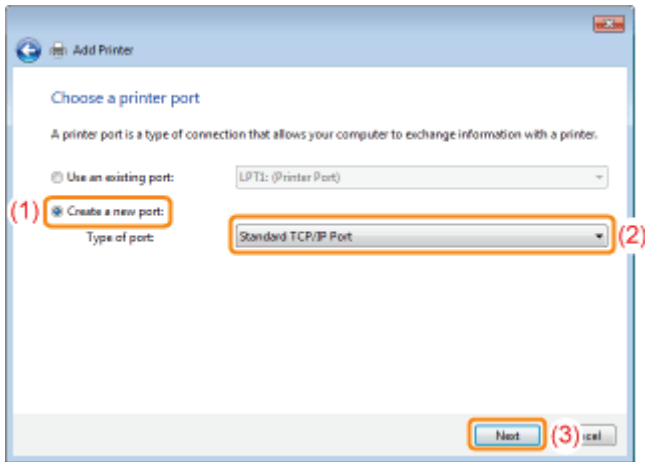

## 7

### Enter the IP address or name of the printer.

- (1) Select [Autodetect] or [TCP/IP Device].
- (2) Enter the IP address or name\* of the printer in [Hostname or IP address].
  - \* The DNS name to be registered on the DNS server (up to 78 characters)
- (3) Clear the [Query the printer and automatically select the driver to use] check box.
- (4) Click [Next].

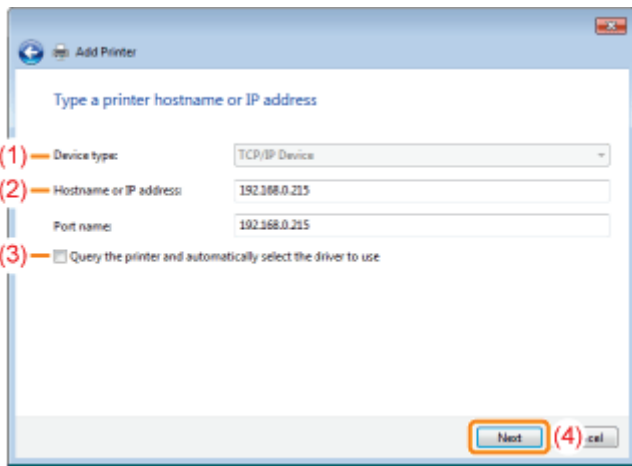

**? If you are not sure about the value to be entered in [Hostname or IP address]**

The value to be entered varies depending on how the IP address of the printer was set.

For more details, see "[Basic Operations/Various Information for Windows](#)" or ask your network administrator.

**? If the printer is not detected**

Follow the on-screen instructions and search again for the printer, or see "[Basic Operations/Various Information for Windows](#)" and specify [Device Type].

## 8

**Click [Have Disk].**

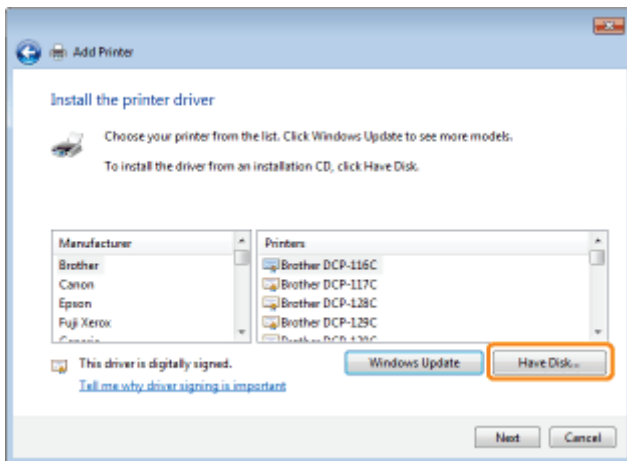

## 9

**Insert the supplied CD-ROM "User Software" into the CD-ROM drive of your computer, and then click [Browse].**

If CD-ROM Setup appears, click [Exit].

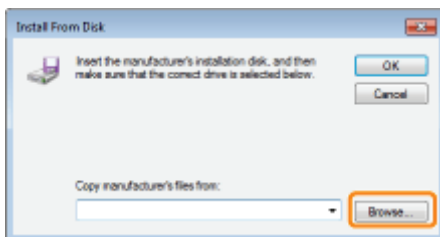

## 10

**Open the folder in which the printer driver is included.**

### **For a 32-bit operating system**

Open the folders in the supplied CD-ROM: [English] - [32bit] - [Driver].

### **For a 64-bit operating system**

Open the folders in the supplied CD-ROM: [English] - [x64] - [Driver].

**? If you are not sure whether you are using a 32-bit operating system or 64-bit operating system**

➤ "Basic Operations/Various Information for Windows"

## **11**

**Open the INF file.**

- (1) Select the INF file.
- (2) Click [Open].

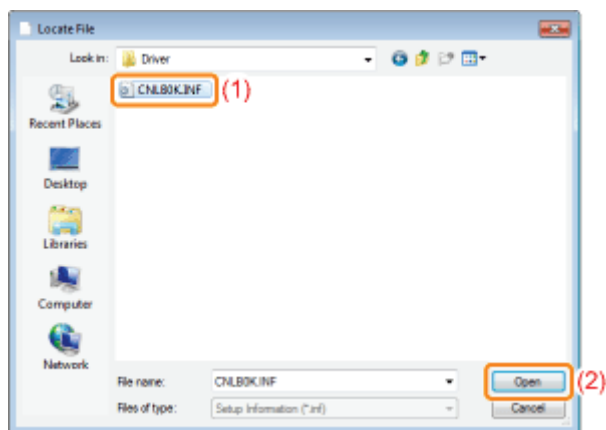

## **12**

**Click [OK].**

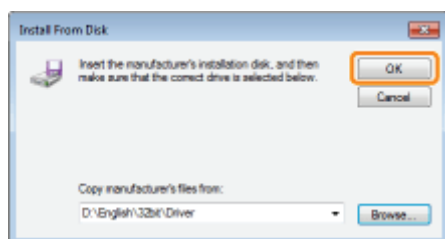

## **13**

**Click [Next].**

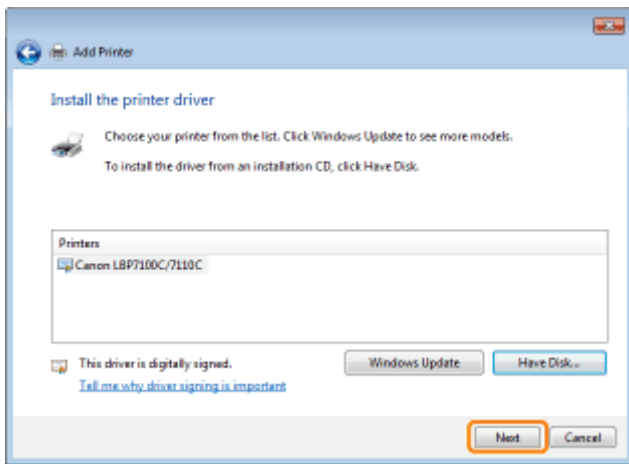

## 14

### Specify the printer name.

(1) Enter a new name if you want to change the printer name.

↑ When [Set as the default printer] is displayed, select whether or not to use the printer as the default printer. (Windows Vista and Server 2008)

(2) Click [Next].

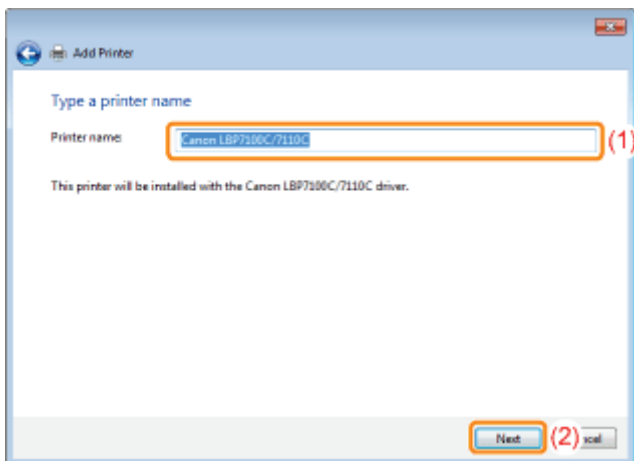

→ The installation starts. Wait until the following screen disappears.

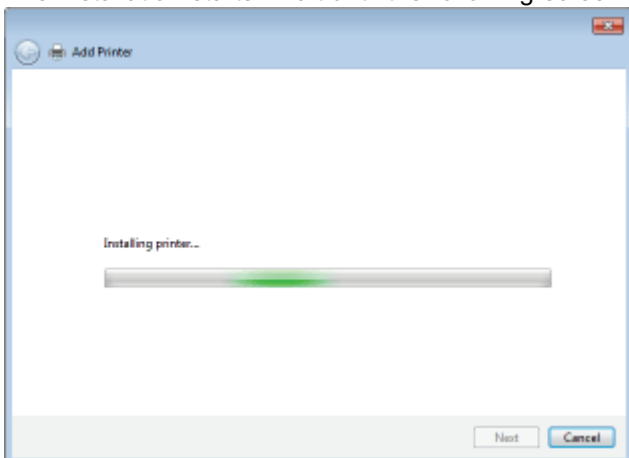

**?** If the [User Account Control] dialog box appears

Click [Yes] or [Continue].

# 15

**When the following screen appears, select whether or not to share the printer.**

(1) Select whether or not to share the printer (whether or not to use the computer on which the printer driver is being installed as the print server).

- † For details on the printer sharing (print server environment), see ["If You Use the Printer in the Print Server Environment."](#)
- † When you share the printer, specify [Share Name], [Location], or [Comment] as needed.

(2) Click [Next].

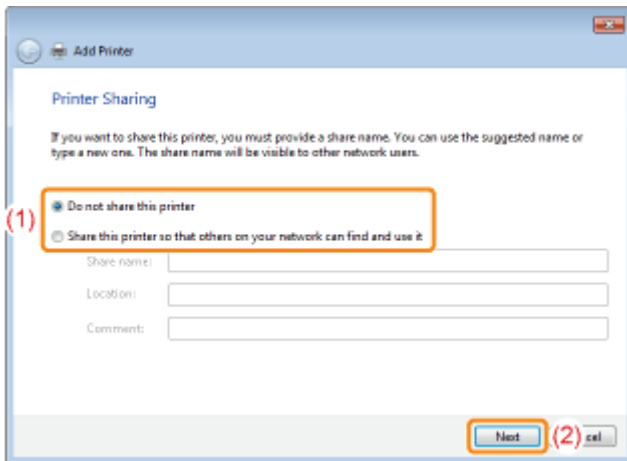

# 16

**Click [Finish].**

If you want to print a test page, click [Print a test page].

- † When [Set as the default printer] is displayed, select whether or not to use the printer as the default printer. (Windows 7 and Server 2008 R2)
- † When the following screen appears, you can remove the CD-ROM.

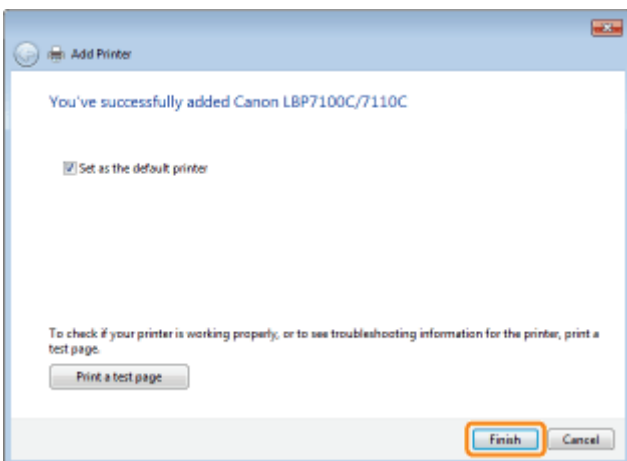

When the installation is complete, an icon for this printer will be created.

## ➤ "After Installation"

- † If you want to change the network settings for the printer, see ["Changing the Network Settings for the Printer."](#)

**NOTE**



### **If you changed the IP address after installing the printer driver**

When you install the printer driver using this procedure, Standard TCP/IP Port is created.

When you use Standard TCP/IP Port, if the IP address of the printer is changed, the port to be used with the printer driver should be changed.

➤ ["Configuring and Changing the Port"](#)

## **Windows XP and Server 2003**

### **1**

**Make sure that the printer and computer are connected properly, and the printer is turned ON.**

➤ ["Connecting the Printer and Computer"](#)

### **2**

**Turn the computer on, and then log on to Windows as a user with administrative rights.**

### **3**

**Open the printer folder.**

➤ ["Basic Operations/Various Information for Windows"](#)

### **4**

**Display [Add Printer Wizard].**

#### **Windows XP**

Click [Add a printer].

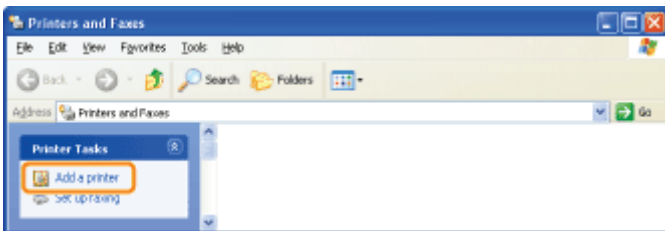

#### **Windows Server 2003**

Double-click [Add Printer].

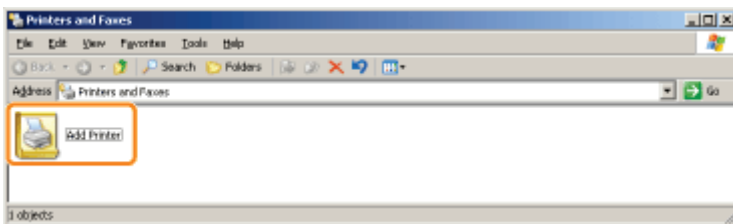

### **5**

**Click [Next].**



## 6

### Specify the type of printer to be used.

- (1) Select [Local printer attached to this computer].
- (2) Clear the [Automatically detect and install my Plug and Play printer] check box.
- (3) Click [Next].

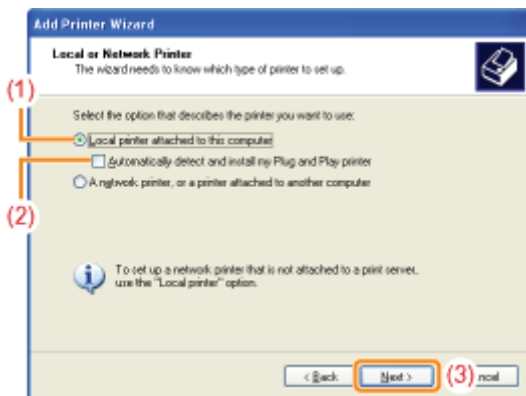

## 7

### Create a port.

- (1) Select [Create a new port].
- (2) Select [Standard TCP/IP Port].
- (3) Click [Next].

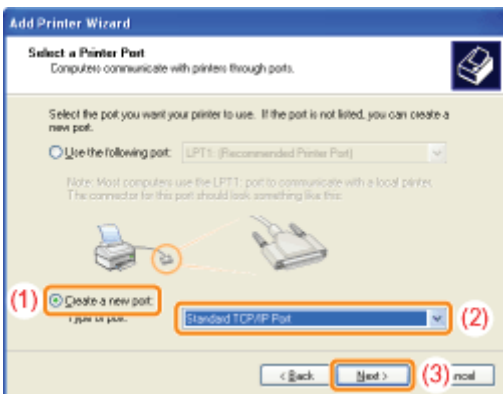

## 8

### Click [Next].

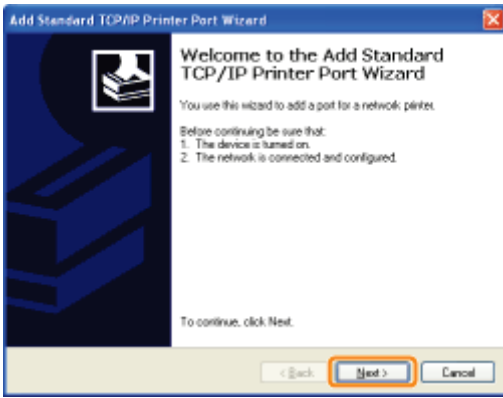

## 9

**Enter the IP address or name of the printer.**

(1) Enter the IP address or name\* of the printer in [Printer Name or IP Address].

\* The DNS name to be registered on the DNS server (up to 78 characters)

(2) Click [Next].

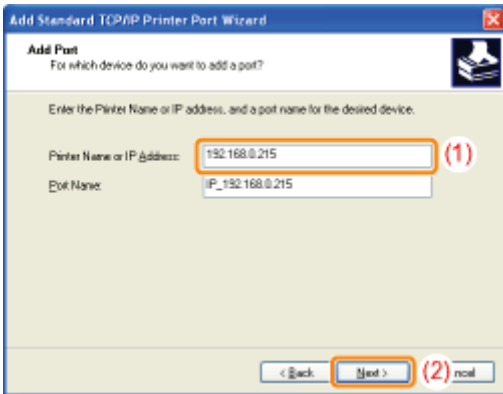

### **? If you are not sure about the value to be entered in [Printer Name or IP Address]**

The value to be entered varies depending on how the IP address of the printer was set.

For more details, see "[Basic Operations/Various Information for Windows](#)" or ask your network administrator.

### **? If the printer is not detected**

Follow the on-screen instructions and search again for the printer, or see "[Basic Operations/Various Information for Windows](#)" and specify [Device Type].

## 10

**Click [Finish].**

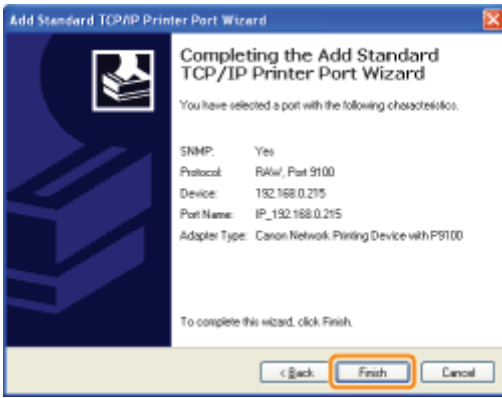

## 11

Click **[Have Disk]**.

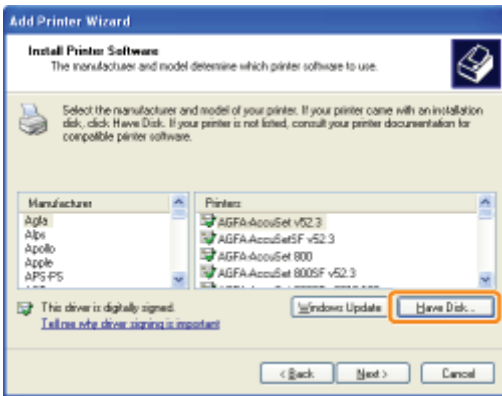

## 12

Insert the supplied **CD-ROM "User Software"** into the CD-ROM drive of your computer, and then click **[Browse]**.

If CD-ROM Setup appears, click **[Exit]**.

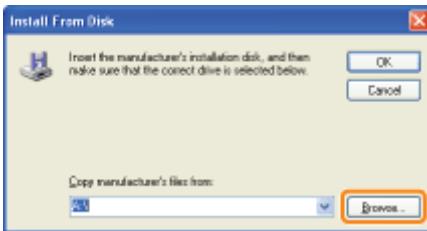

## 13

Open the folder in which the printer driver is included.

### For a 32-bit operating system

Open the folders in the supplied CD-ROM: **[English] - [32bit] - [Driver]**.

### For a 64-bit operating system

Open the folders in the supplied CD-ROM: **[English] - [x64] - [Driver]**.

## 14

Open the **INF** file.

- (1) Select the INF file.
- (2) Click [Open].

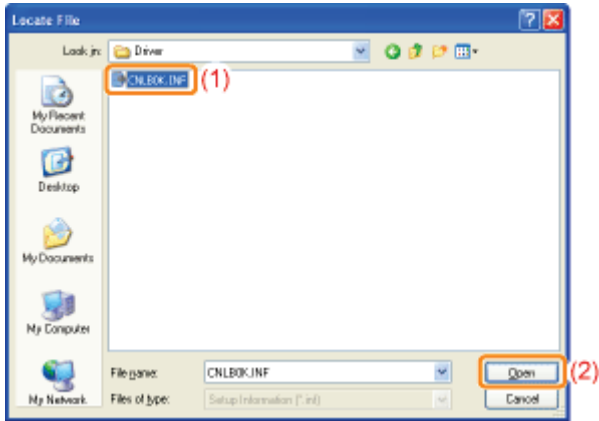

## 15

Click [OK].

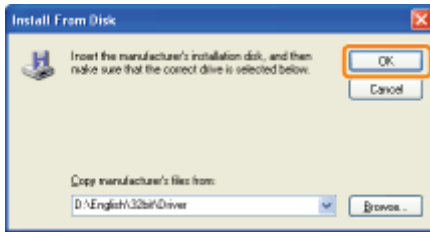

## 16

Click [Next].

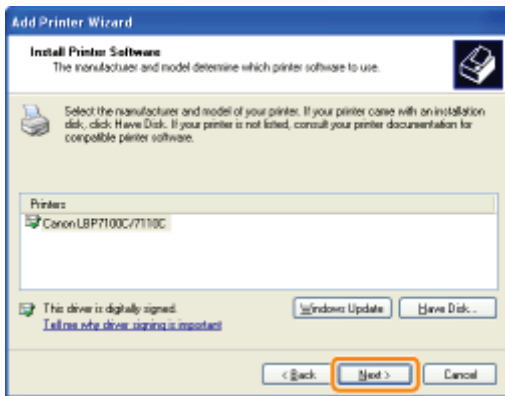

## 17

Specify the printer name.

- (1) Enter a new name if you want to change the printer name.
  - ↑ When the message <Do you want to use this printer as the default printer?> appears, select [Yes] or [No].
- (2) Click [Next].

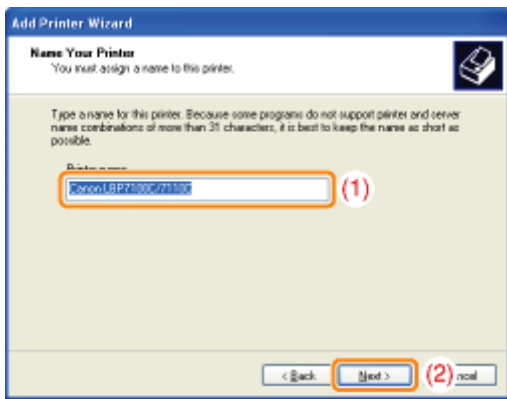

## 18

Click [Next].

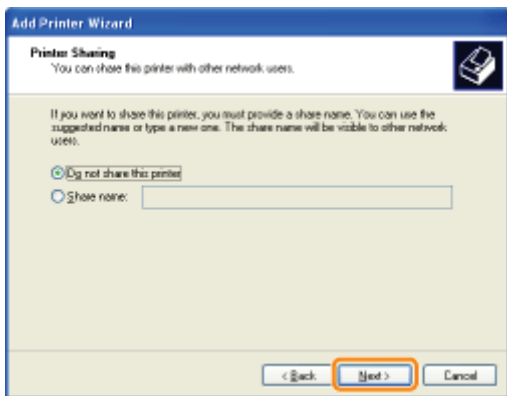

### NOTE

**When sharing the printer (When using the computer on which the printer driver is being installed as the print server).**

† For details on the printer sharing (print server environment), see "[If You Use the Printer in the Print Server Environment.](#)"

Perform the following procedure.

1. Select [Share name] and enter a name for the shared printer.
2. Click [Next].
3. The window for entering [Location] and [Comment] is displayed. Enter them as needed.
4. Click [Next].

## 19

Select whether to print a test page.

- (1) Select whether to print a test page.
- (2) Click [Next].

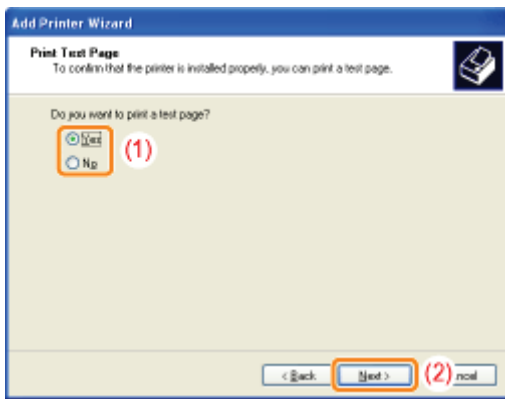

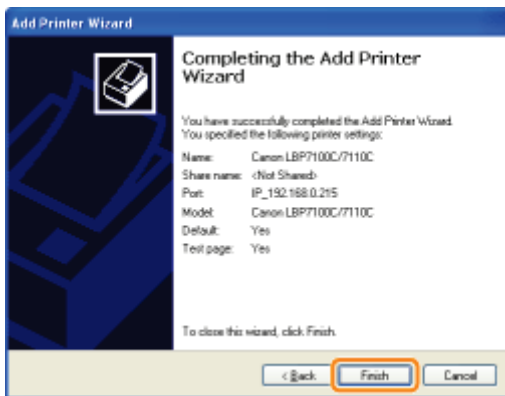

## 20

Click **[Finish]**.

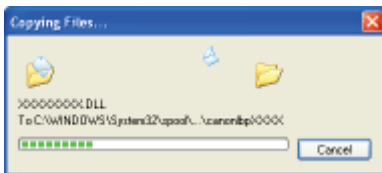

- The installation starts. Wait until the following screen disappears.
- ↑ When the following screen disappears, you can remove the CD-ROM.



 When the installation is complete, an icon for this printer will be created.

➤ ["After Installation"](#)

- ↑ If you want to change the network settings for the printer, see ["Changing the Network Settings for the Printer."](#)

### NOTE

#### **If you changed the IP address after installing the printer driver**

When you install the printer driver using this procedure, Standard TCP/IP Port is created.

When you use Standard TCP/IP Port, if the IP address of the printer is changed, the port to be used with the printer driver should be changed.

➤ ["Configuring and Changing the Port"](#)

# Changing the Network Settings for the Printer

---

## ➤ **Configuring the Protocol Settings**

---

- IPv4 Settings
- IPv6 Settings
- Other Protocol Settings

## ➤ **Specifying a Dedicated Port**

---

## ➤ **Specifying the Waiting Time Until Connected to the Network**

---

## ➤ **Specifying the Wired LAN Communication Mode and Transmission Speed**

---

### **NOTE**

**When setting the items for the printer management (such as setting the manager password)**

- "Managing the Printer"

**When setting the items for security (such as restricting the users who can print)**

- "Security Settings"

**When initializing the network settings (resetting to the default values)**

- "Initializing the System Settings"



# Configuring the Protocol Settings

Before specifying the settings, see "Attention (Protocol Settings)."

## 1

Start the Remote UI, and then log in as Management Mode.

➤ "Starting the Remote UI"

## 2

Click [Settings/Registration].

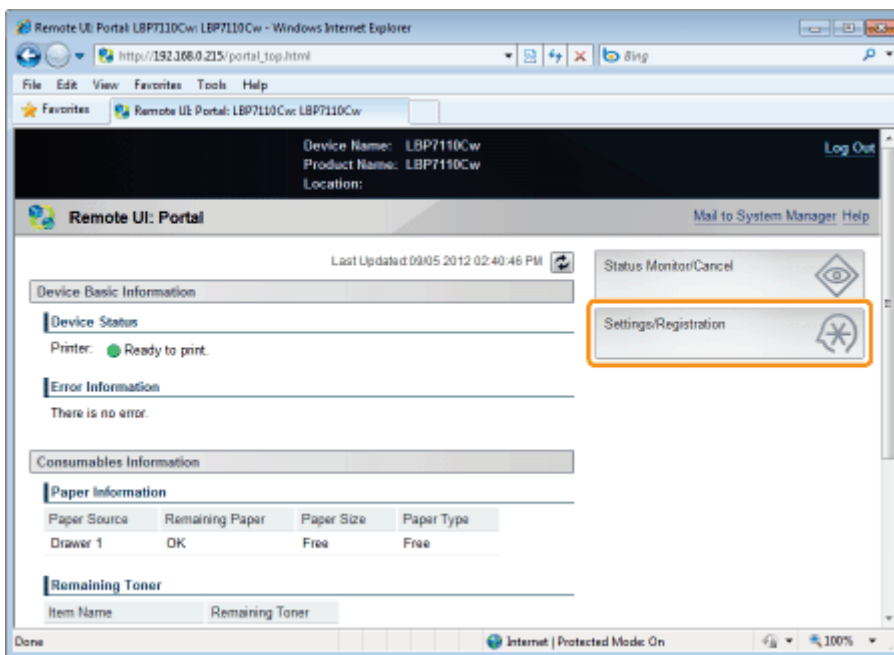

## 3

Display the [TCP/IP Settings] page.

- (1) Select [Network Settings].
- (2) Click [TCP/IP Settings].

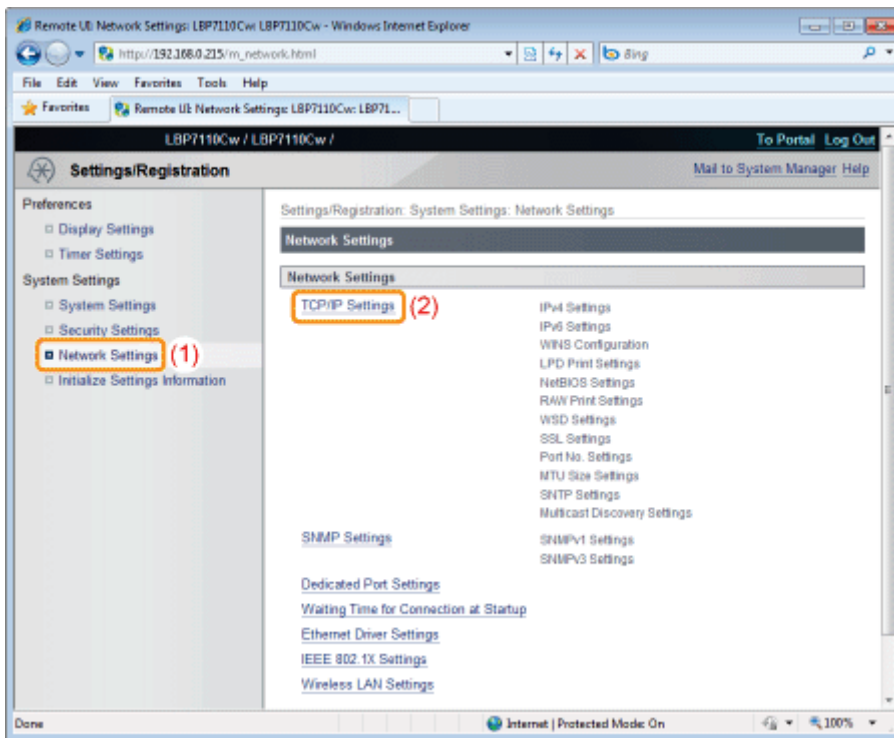

## 4

### Configure the protocol settings.

The setting procedure varies depending on the settings. See the appropriate procedure according to settings.

- "IPv4 Settings"
- "IPv6 Settings"
- "Other Protocol Settings"

## Attention (Protocol Settings)

### When setting the IP address (IPv4)

#### NOTE

##### **If you changed the IP address after installing the printer driver**

When you use MFNP Port, the port does not have to be changed because a new IP address is detected automatically when the printer and computer are on the same subnet.

When you use Standard TCP/IP Port, the port to be used with the printer driver should be changed.

➤ ["Configuring and Changing the Port"](#)

† If you do not know which port you are using, see ["Basic Operations/Various Information for Windows."](#)

##### **When using DHCP, BOOTP, or RARP**

- You can select DHCP, BOOTP, or RARP.
- After the printer restarts, the values obtained from DHCP, BOOTP, and RARP are displayed. (If the values have been specified previously, they overwrite the obtained ones.)
- Because it takes two minutes to check whether DHCP, BOOTP, and RARP are available, we recommend that you set [Select Protocol] to [Off] for the unused protocols.

##### **When using DHCP**

When you use Standard TCP/IP Port, if you cycle the power of the printer, you may not be able to print. This is because a different IP address from the one that was used is assigned.

To use DHCP, use MFNP Port (➤ ["Configuring and Changing the Port"](#)) or consult your network administrator and specify either of the following settings.

- Specifying the DNS Dynamic Update function
- Specifying the settings so that the same IP address is always assigned when the printer starts

##### **IP address obtained with DHCP, BOOTP, or RARP**

Specifying the IP address takes priority even when [Auto IP] is set to [On].

### When setting the IP address (IPv6)

#### IMPORTANT

##### **About IPv6**

- You cannot use IPv6 alone without using IPv4.
- IPsec (Security Architecture for Internet Protocol) encryption is not supported.

#### NOTE

##### **If you changed the IP address after installing the printer driver**

Specify the port to be used again in the printer driver.

➤ ["Configuring and Changing the Port"](#)

##### **About IPv6 addresses**

This printer can have up to nine of the following IPv6 addresses. (You can only register one address manually.) You can use multiple IPv6 addresses for IPv6 communication.

Type	Registrable Number	Outline
Link-Local Address	1	The link-local address is specified automatically using the prefix (information indicating the network to which it belongs) "fe80::" and an interface identifier generated from the MAC address of the printer. Because the address is valid only within the same prefix, it cannot traverse the router. One link-local address is specified for this printer whenever IPv6 is being used.

Manual Address	0 to 1	This is a fixed address that is entered manually. When specifying the IP address manually, you can specify the prefix length and default router address.
Stateless Address	0 to 6	The stateless address is specified automatically using the prefix (information indicating the network to which it belongs) included in RA (Router Advertisement) transmitted by the router and the MAC address of the printer.
Stateful Address	0 to 1	The stateful address can be obtained from the DHCP server using DHCPv6.

### About stateless addresses

Stateless addresses are deleted when the printer restarts (when the printer turns ON).

## When configuring the DNS Settings

### IMPORTANT

#### DNS Dynamic Update

DNS Dynamic Update is a function that adds the IP address of the device and the names specified as the host name and domain name to the DNS server automatically.

This function can be used in the environment in which a Dynamic DNS server is being used.

#### When using the DNS Dynamic Update function

You need to set the IP address, host name, and domain name of the DNS server.

#### For details on the procedure for setting a port when using DNS

See "[Basic Operations/Various Information for Windows](#)" or ask your network administrator.

## When Configuring WINS

### IMPORTANT

#### About WINS

WINS (Windows Internet Name Service) is a service to correspond the NetBIOS names (names of computers and printers) to IP addresses. A WINS server is required to use WINS.

### NOTE

#### When using the IP address settings with DHCP

When the IP address of the WINS server is obtained from the DHCP server, the IP address obtained from the DHCP server is overwritten.

#### WINS cannot be used in an IPv6 environment

Use WINS in an IPv4 environment.

## When configuring the Multicast Discovery Settings

### NOTE

#### Multicast discovery

This is a function that searches for certain devices using Service Location Protocol (SLP).

By using the multicast discovery function, you can search for only the devices whose values in [Scope Name] are verified, using the service location protocol (SLP) from utility software.

# IPv4 Settings

† For details on the procedure before displaying the [TCP/IP Settings] page (the procedure before Step 1), see "Configuring the Protocol Settings."

1

Click [Edit] in [IPv4 Settings].

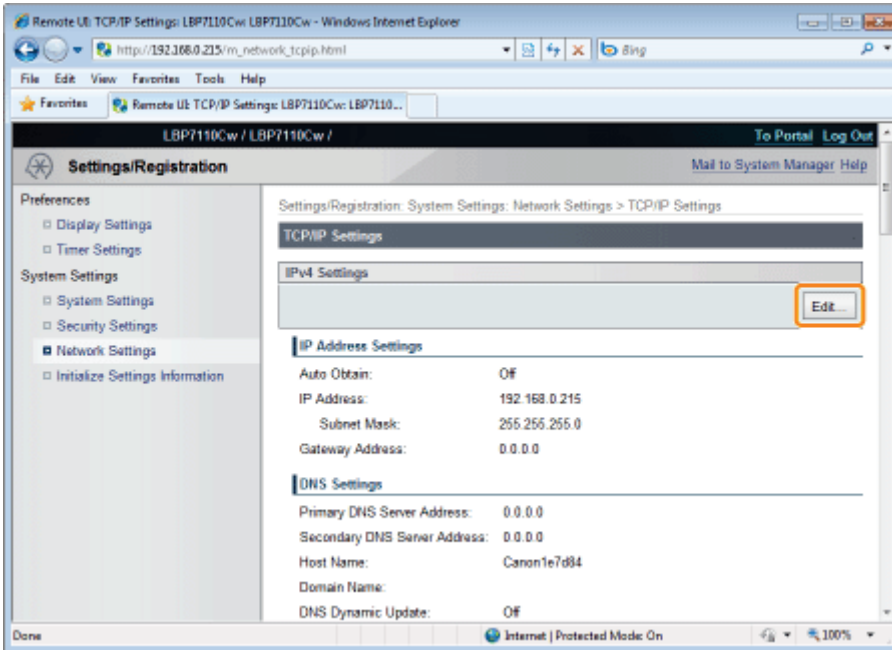

2

Set the IP address.

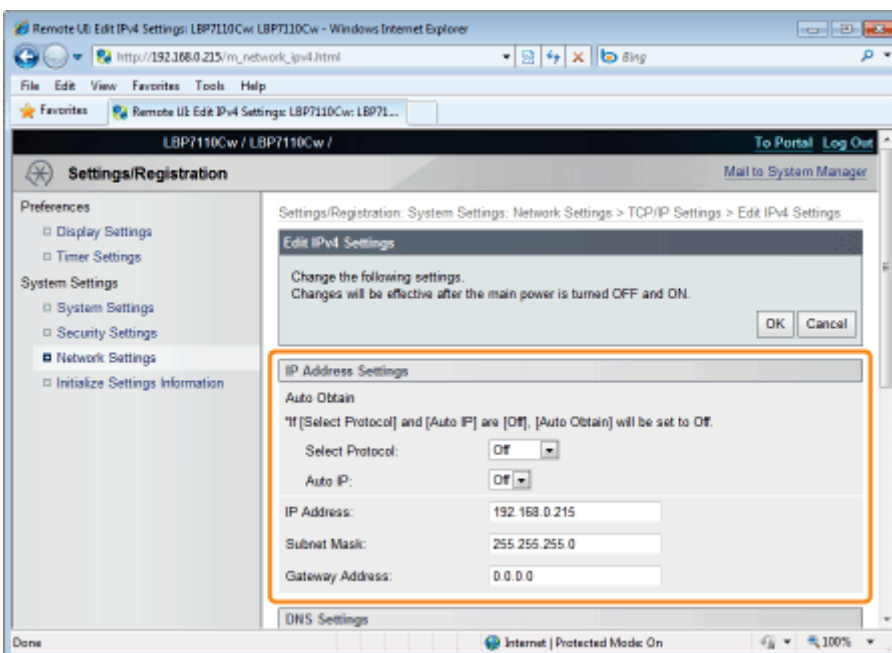

## When obtaining the IP address automatically

Use DHCP, BOOTP, RARP, or Auto IP to obtain the IP address automatically.

[Select Protocol]	<ul style="list-style-type: none"> <li>• <b>[Off]</b> An IP address that uses RARP, BOOTP, or DHCP cannot be obtained automatically.</li> <li>• <b>[DHCP]</b> Obtains an IP address using DHCP. (The DHCP server needs to be running.)</li> <li>• <b>[BOOTP]</b> Obtains an IP address using BOOTP. (The BOOTP daemon needs to be running.)</li> <li>• <b>[RARP]</b> Obtains an IP address using RARP. (The RARP daemon needs to be running.)</li> </ul>
[Auto IP]	<ul style="list-style-type: none"> <li>• <b>[Off]</b> An IP address that uses Auto IP cannot be obtained automatically.</li> <li>• <b>[On]</b> The printer obtains the IP address automatically.</li> </ul>

### When setting the IP address manually

Allows you to directly set the IP address manually.

[Select Protocol]	Select [Off].
[Auto IP]	
[IP Address]	Enter the IP address of the printer.
[Subnet Mask]	Enter the subnet mask that is used on the TCP/IP network.
[Gateway Address]	Enter the gateway address that is being used on the TCP/IP network.

## 3

### Specify the DNS.

Proceed to Step 4 when not using DNS.

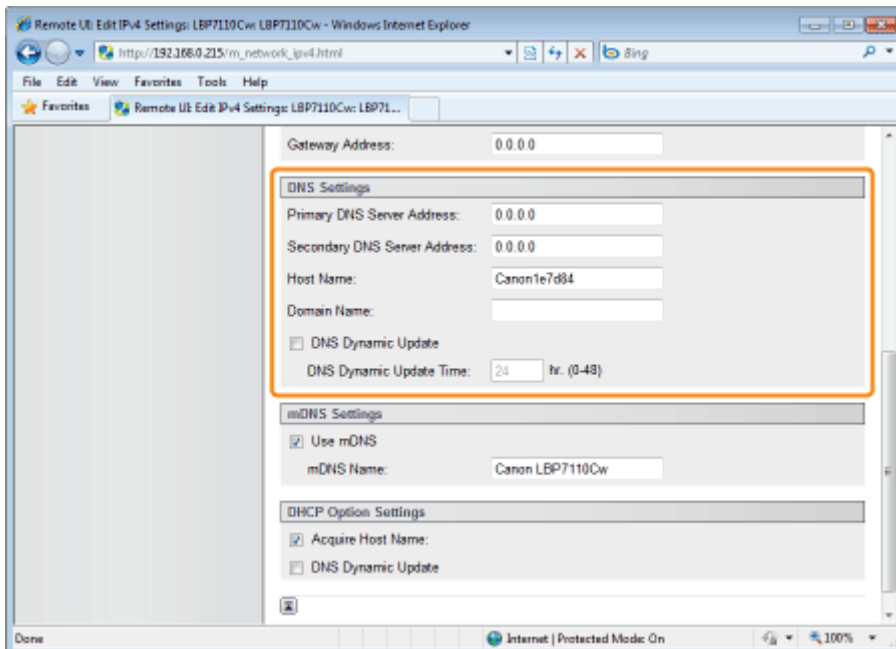

[Primary DNS Server Address]	Enter the IP address of the primary DNS server.
[Secondary DNS Server Address]	Enter the IP address of the secondary DNS server.
[Host Name]	Enter the host name to be added to the DNS server. You can enter up to 47 single-byte alphanumeric characters.

[Domain Name]	Enter the name of the domain to which the printer belongs. You can enter up to 47 single-byte alphanumeric characters. <ul style="list-style-type: none"> <li>• <b>Input Example:</b> "example.com"</li> </ul>
[DNS Dynamic Update]	To use the DNS Dynamic Update function, select the check box.
[DNS Dynamic Update Time]	Specify the interval at which to perform the dynamic update.

## 4

### Specify the mDNS.

Proceed to Step 5 when not using mDNS.

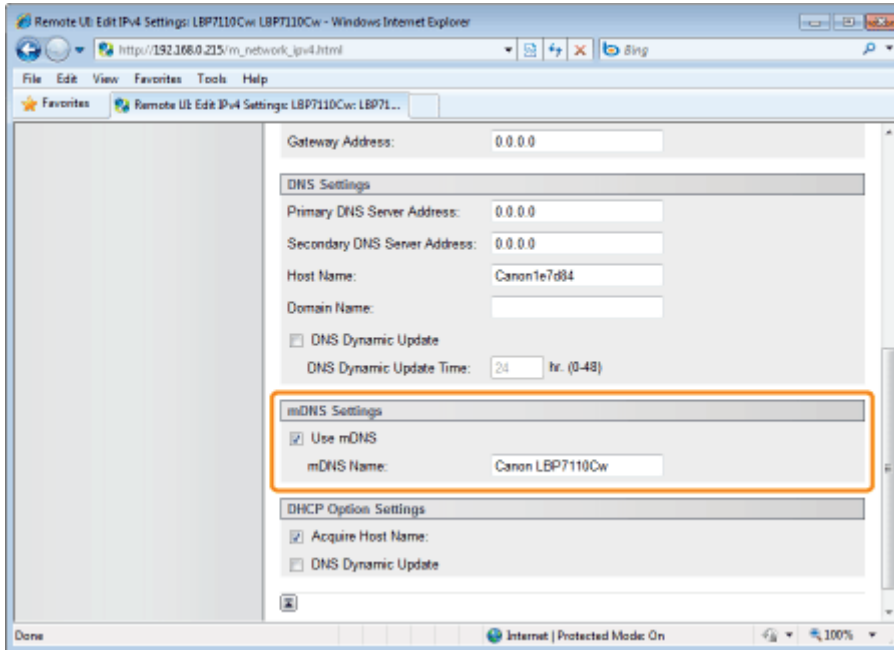

[Use mDNS]	To use mDNS settings, select the check box.
[mDNS Name]	Enter the mDNS name.

## 5

### Specify the DHCP options.

Proceed to Step 6 when not using DHCP options.

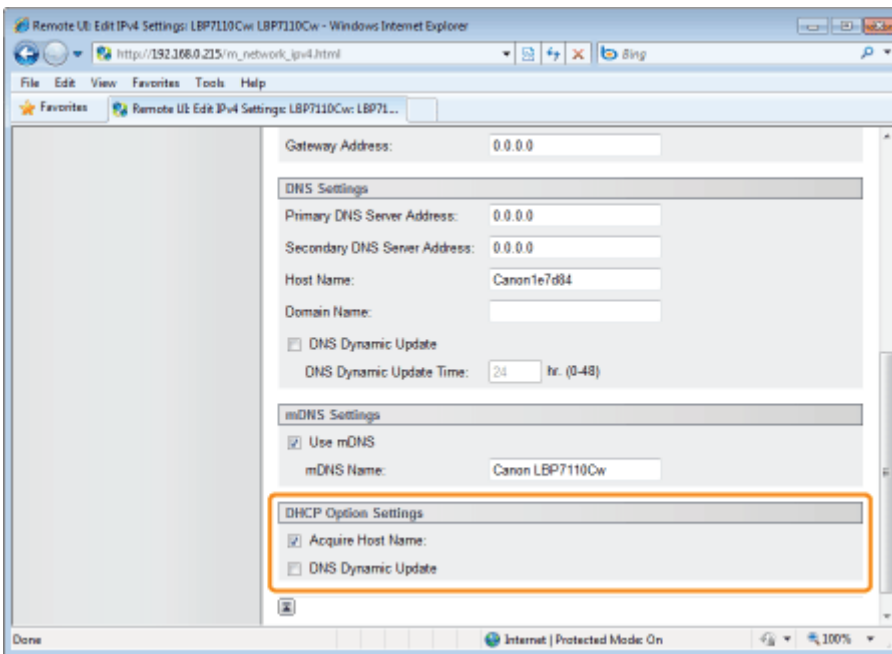

[Acquire Host Name]	To obtain the host name from the DHCP server, select the check box.
[DNS Dynamic Update]	To dynamically update the obtained host name, select the check box.

## 6

Click [OK].

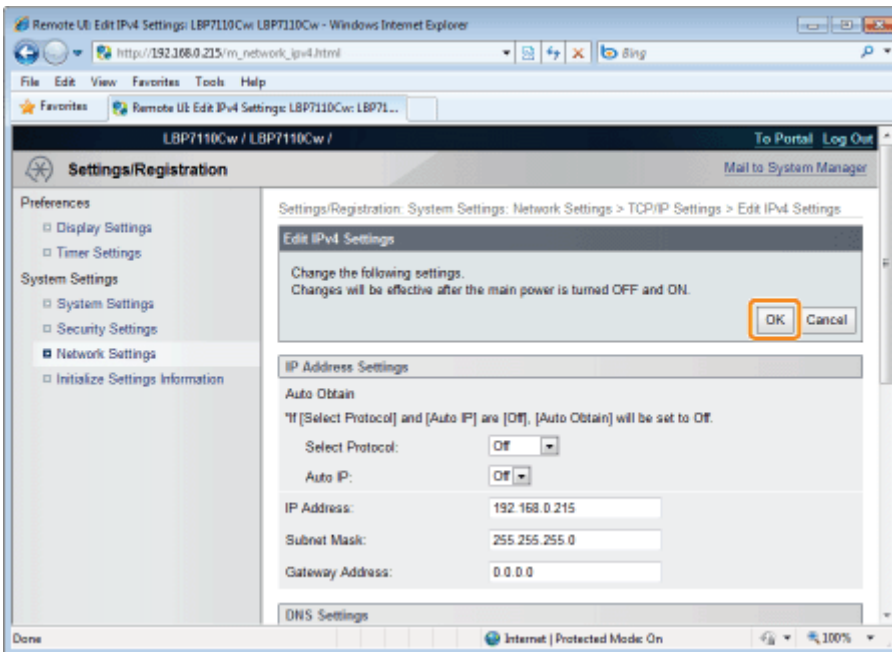

## 7

Restart the printer.

Turn the printer OFF, make sure that the Main Power indicator is off, wait for 10 seconds or longer, and then turn it ON again.

→ After the printer is restarted, the settings become effective.



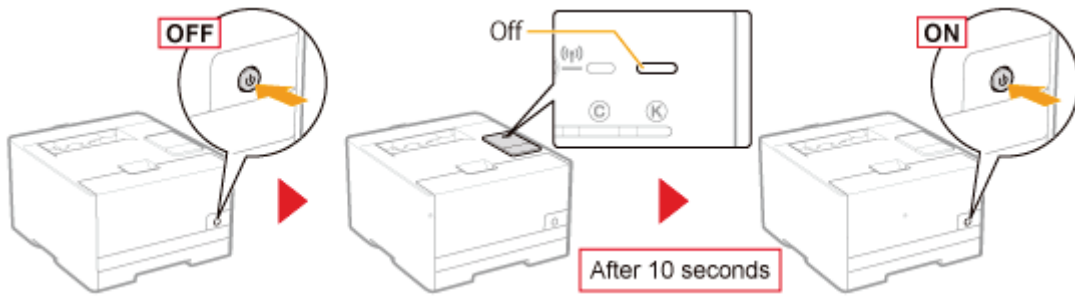

# IPv6 Settings

- † Specify the IPv6 settings after specifying the IPv4 settings.
- † For details on the procedure before selecting the settings (the procedure before Step 1), see "[Configuring the Protocol Settings.](#)"

## 1

Click [Edit] in [IPv6 Settings].

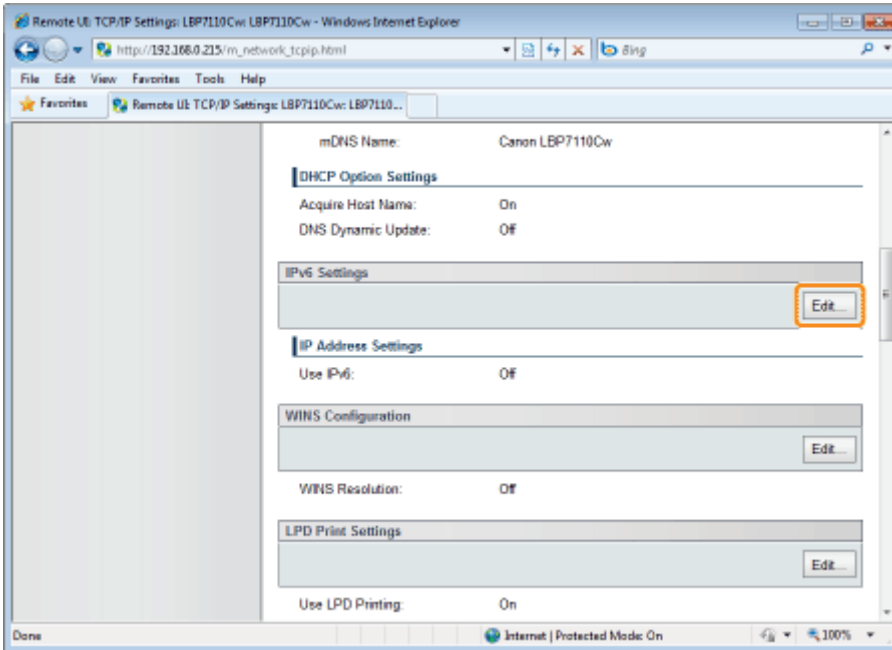

## 2

Select the [IPv6] check box.

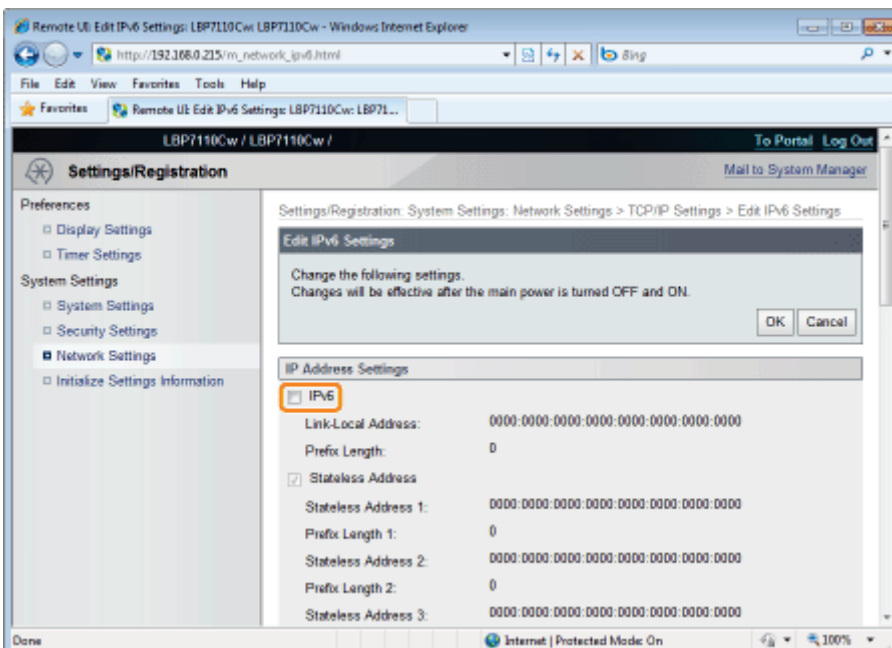

### 3

#### Specify the stateless address.

Proceed to Step 4 when not using a stateless address.

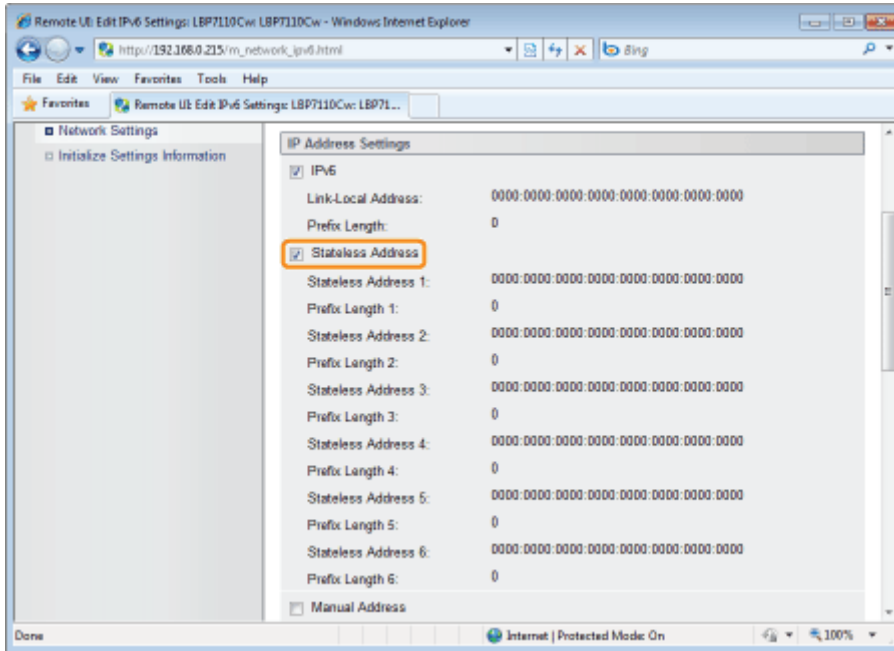

[Stateless Address]	To use a stateless address, select the check box.
---------------------	---

### 4

#### Specify the manual address.

Proceed to Step 5 when not using a manual address.

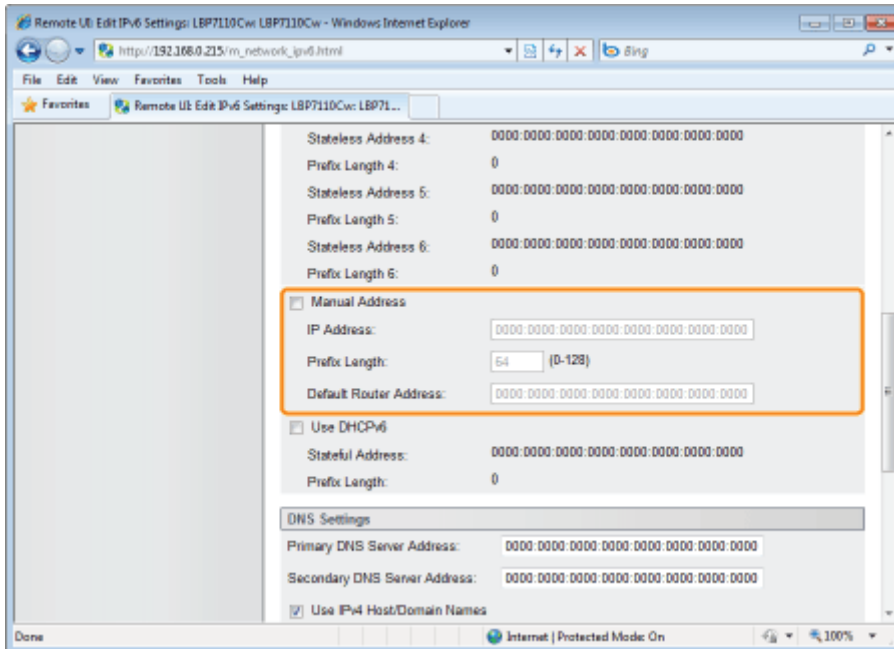

[Manual Address]	To use a manual address, select the check box.
------------------	--

[IP Address]	Enter the IP address of the printer.
--------------	--------------------------------------

[Prefix Length]	Enter the prefix length.
-----------------	--------------------------

[Default Router]	Enter the default router address as needed.
------------------	---

Address]

## IMPORTANT

### Addresses that cannot be entered in [IP Address] and [Default Router Address]

- Addresses that begin with "ff" (multicast address)
- "::1" (loopback address)

## 5

### Specify DHCPv6.

Proceed to Step 6 when not using DHCPv6.

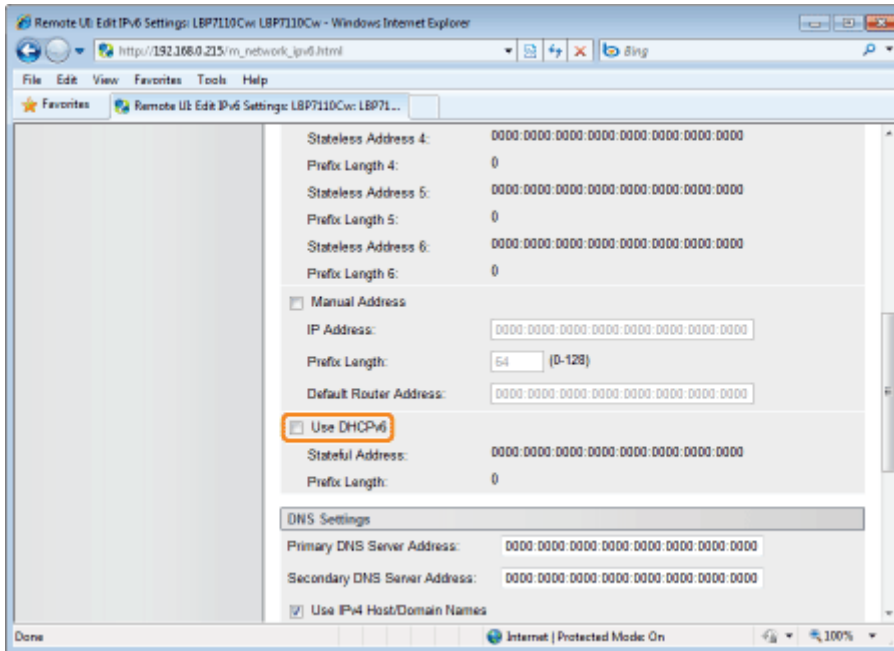

[Use DHCPv6]

To use DHCPv6, select the check box.

## 6

### Specify the DNS.

Proceed to Step 7 when not using DNS.

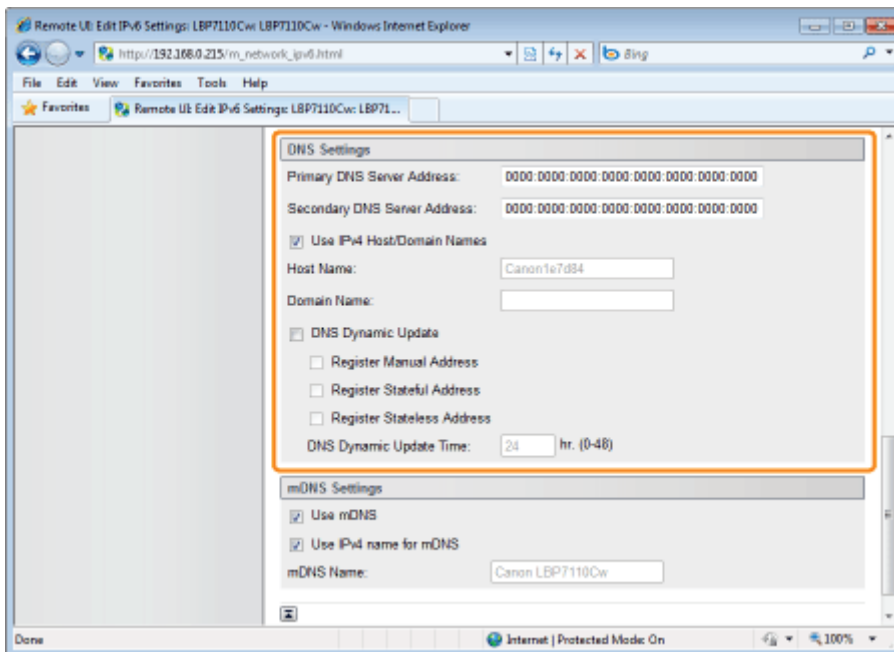

[Primary DNS Server Address]	Enter the IP address of the primary DNS server.
[Secondary DNS Server Address]	Enter the IP address of the secondary DNS server.
[Use IPv4 Host/Domain Names]	To use the same name as IPv4, select the check box.
[Host Name]	Enter the host name to be added to the DNS server. You can enter up to 47 single-byte alphanumeric characters.
[Domain Name]	Enter the name of the domain to which the printer belongs. You can enter up to 47 single-byte alphanumeric characters. <ul style="list-style-type: none"> <li>• <b>Input Example:</b> "example.com"</li> </ul>
[DNS Dynamic Update]	To use the DNS Dynamic Update function, select the check box.
[Register Manual Address]	To register a manual address to the DNS server, select the check box.
[Register Stateful Address]	To register a stateful address to the DNS server, select the check box.
[Register Stateless Address]	To register a stateless address to the DNS server, select the check box.
[DNS Dynamic Update Time]	Specify the interval at which to perform the dynamic update.

## 7

### Specify the mDNS.

Proceed to Step 8 when not using mDNS.

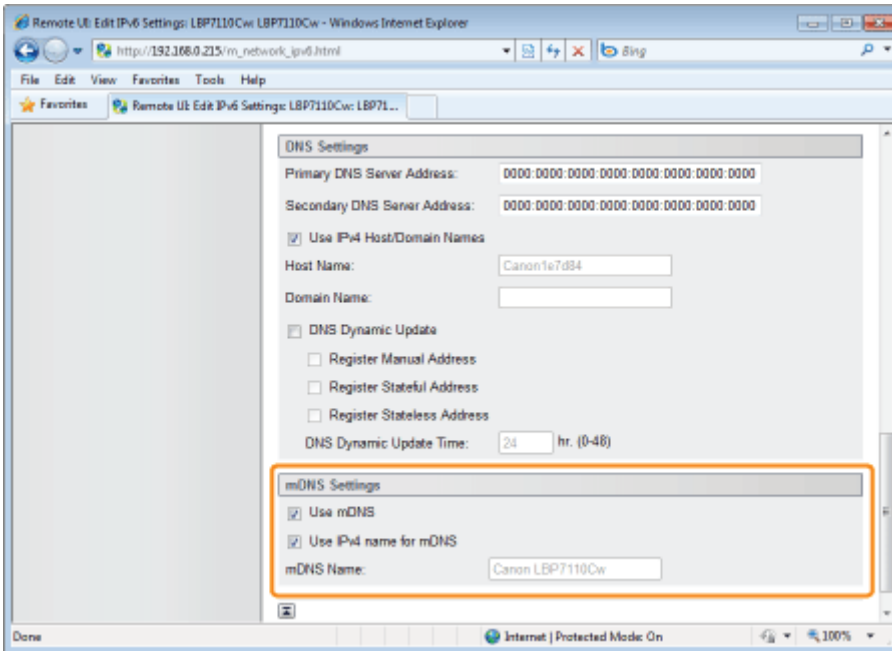

[Use mDNS]	To use mDNS settings, select the check box.
[Use IPv4 name for mDNS]	To use the same name as IPv4, select the check box.
[mDNS Name]	Enter the mDNS name when not selecting the [Use IPv4 name for mDNS] check box.

## 8

Click [OK].

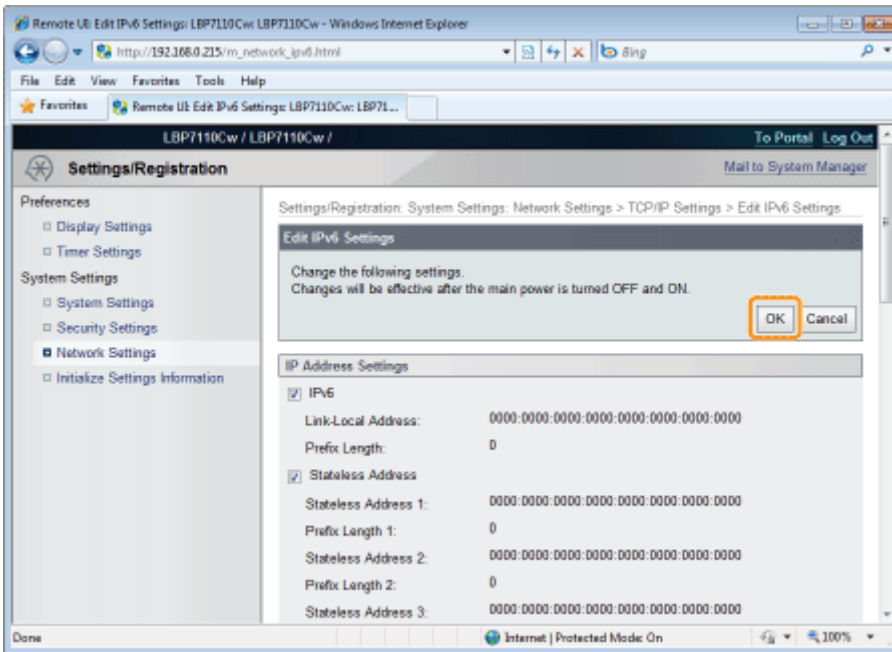

## 9

Restart the printer.

Turn the printer OFF, make sure that the Main Power indicator is off, wait for 10 seconds or longer, and then turn it ON again.

→ After the printer is restarted, the settings become effective.

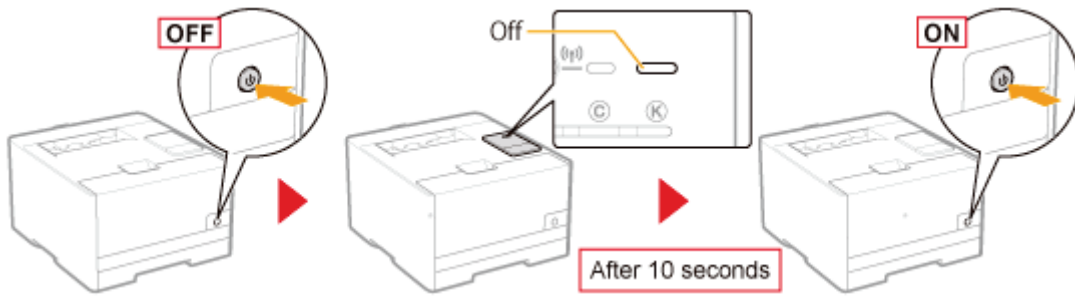

## Other Protocol Settings

- † For details on the procedure before displaying the [TCP/IP Settings] page (the procedure before Step 1), see "[Configuring the Protocol Settings.](#)"
- † For details on the SSL settings, see "[Setting the SSL Encrypted Communication Function.](#)"

### 1

Click [Edit] for the option you want to specify.

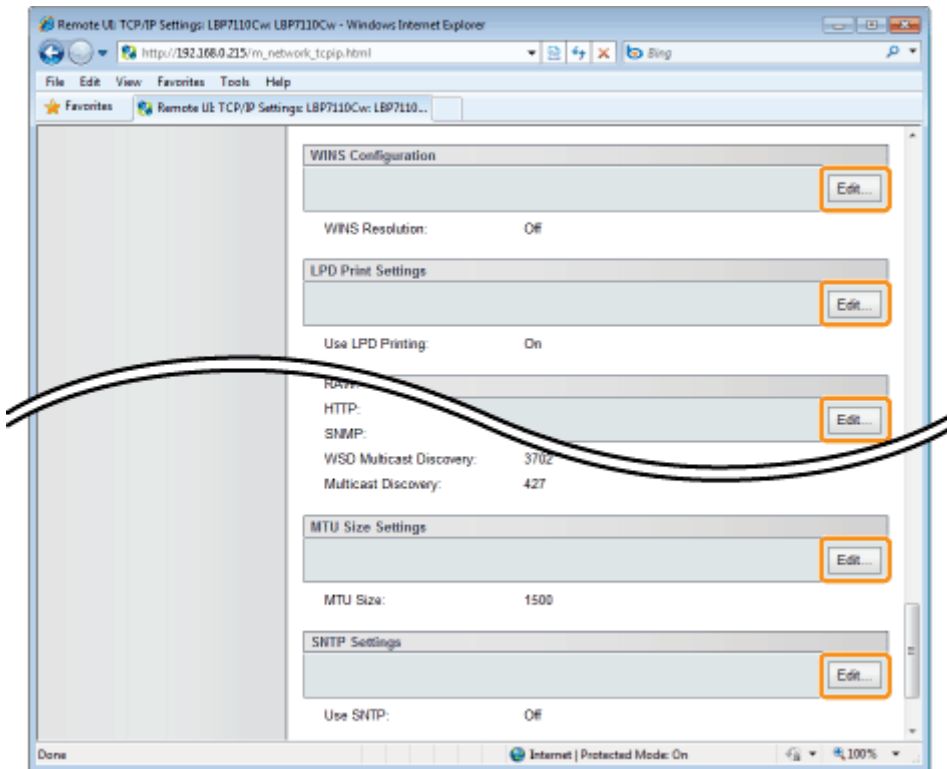

### 2

Specify each setting.

- ❖ WINS Configuration
- ❖ LPD Print Settings
- ❖ NetBIOS Settings
- ❖ RAW Print Settings
- ❖ WSD Settings
- ❖ Multicast Discovery Settings
- ❖ Port No. Settings
- ❖ MTU Size Settings
- ❖ SNTP Settings

### WINS Configuration

- (1) Specify the settings for WINS.
- (2) Click [OK].



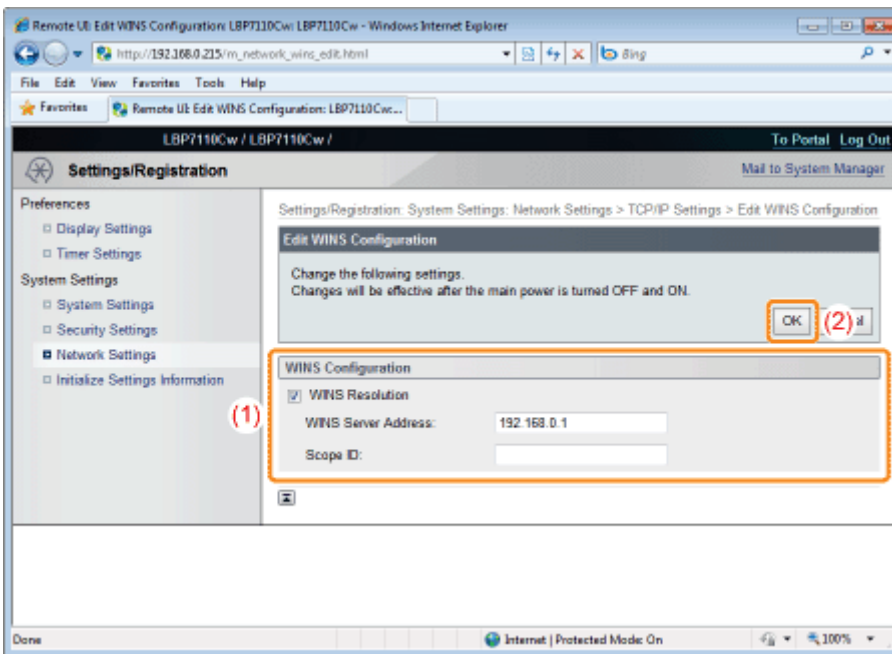

[WINS Resolution]	To use WINS resolution, select the check box.
[WINS Server Address]	Enter the IP address of the WINS server.
[Scope ID]	<p>Enter the scope ID. You can enter up to 63 single-byte alphanumeric characters.</p> <ul style="list-style-type: none"> <li>† The scope ID is an identifier used to determine the scope for use of devices and the computer. It references the scope ID regardless of the WINS resolution setting.</li> <li>† Leave [Scope ID] blank when not specifying the scope ID on computers of your network environment.</li> </ul>

† To register the printer on a WINS server, you must specify the NetBIOS name and workgroup name settings of the printer.

❖ ["NetBIOS Settings"](#)

📄 Proceed to Step 3 if you do not specify the settings for the other options.

## LPD Print Settings

(1) Specify the settings for LPD printing.

(2) Click [OK].

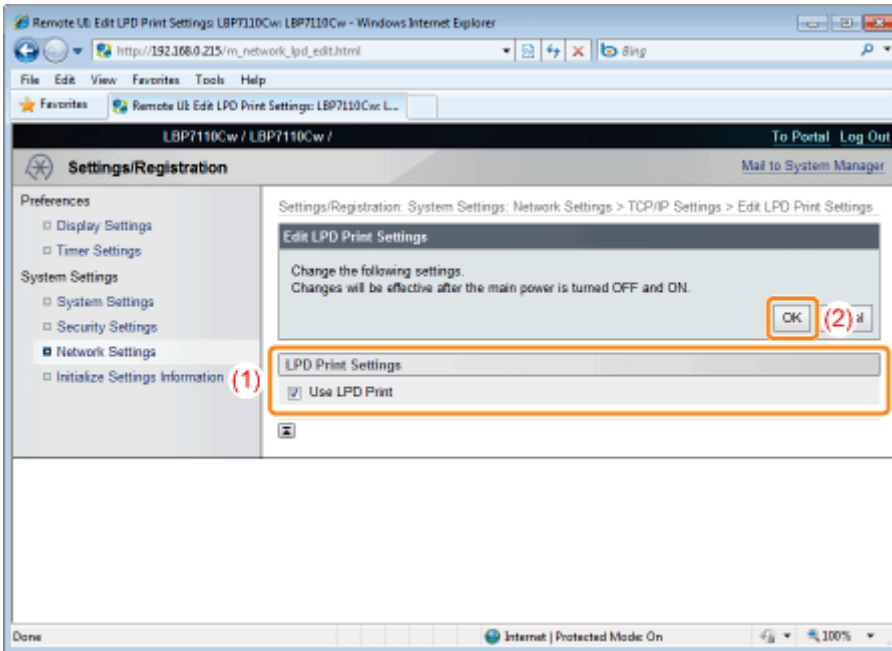

[Use LPD Print]	To use LPD printing, select the check box.
-----------------	--

Proceed to Step 3 if you do not specify the settings for the other options.

## NetBIOS Settings

- (1) Specify the settings for NetBIOS.
- (2) Click [OK].

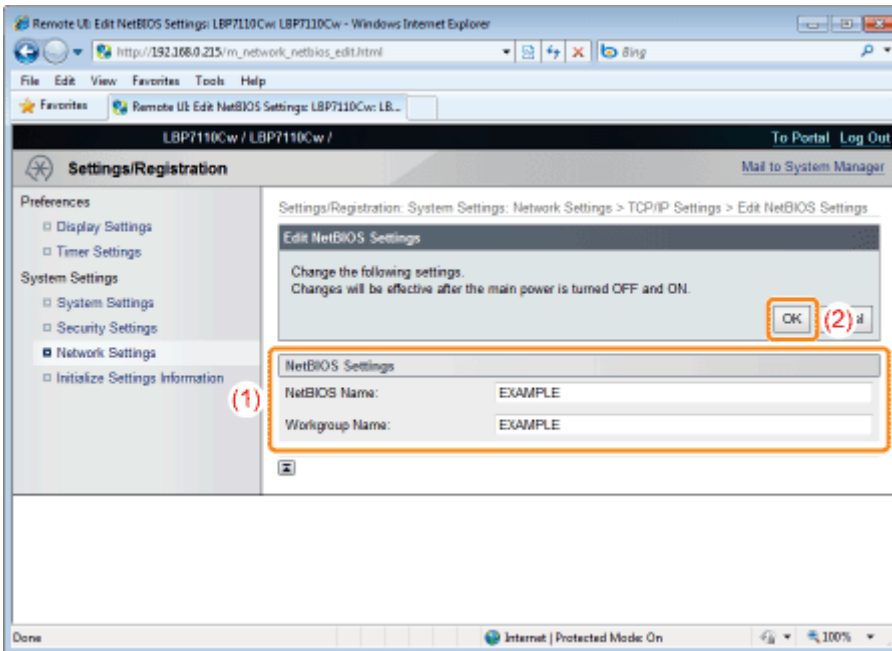

[NetBIOS Name]	Enter the NetBIOS name of the printer.
[Workgroup Name]	Enter the workgroup to which the printer belongs.

Proceed to Step 3 if you do not specify the settings for the other options.

## RAW Print Settings

↑ Usually, it is not required to change the settings.

- (1) Specify the settings for RAW printing.
- (2) Click [OK].

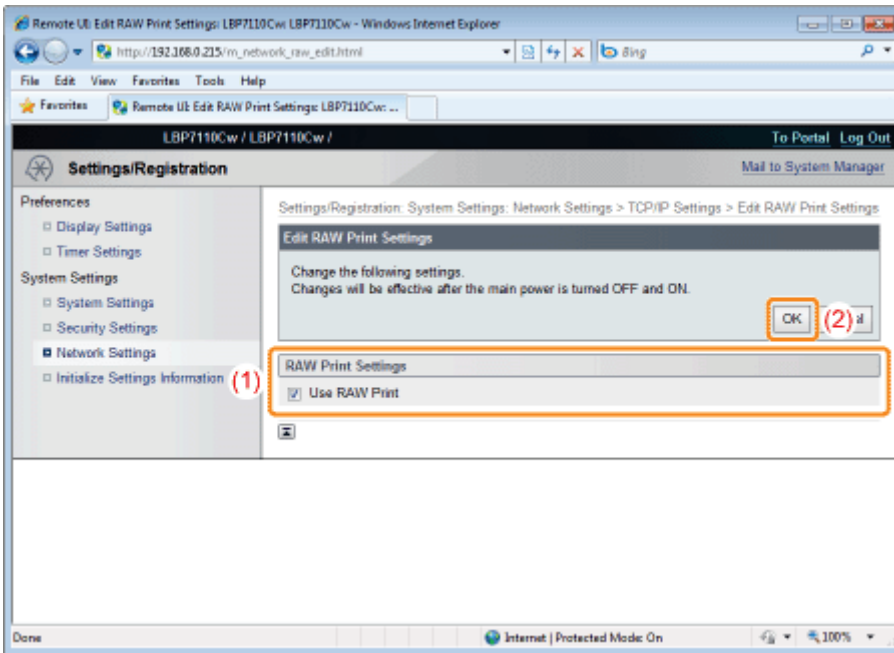

[Use RAW Print]	To use RAW printing, select the check box.
-----------------	--

Proceed to Step 3 if you do not specify the settings for the other options.

## WSD Settings

† To use the printer with a network connection, use MFNP Port or Standard TCP/IP Port to perform printing.

- (1) Specify the settings for WSD.
- (2) Click [OK].

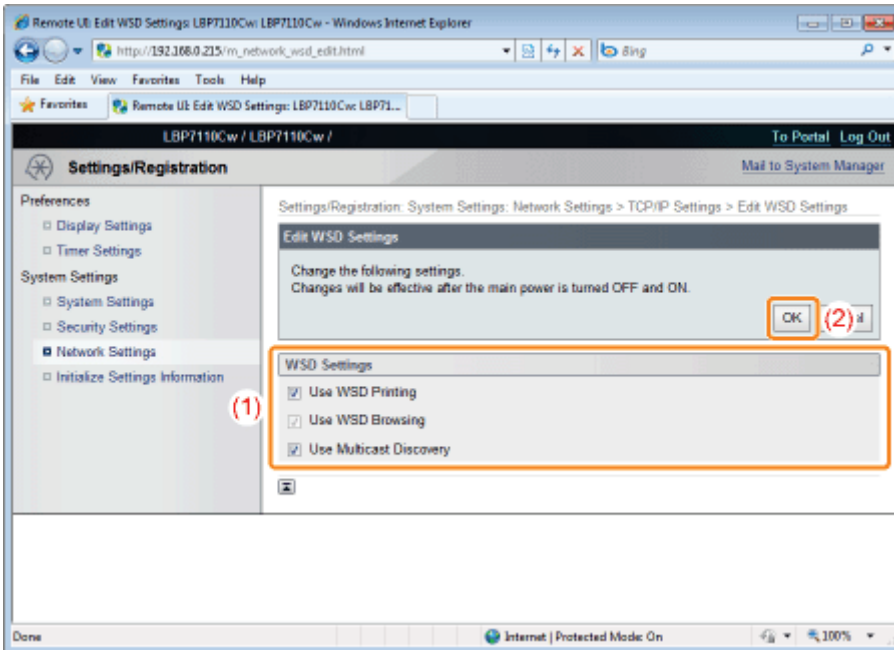

[Use WSD Printing]	To use WSD printing, select the check box.
[Use WSD Browsing]	To use WSD to obtain the printer information, select the check box. (If the [Use WSD Printing] check box is selected, the [Use WSD Browsing] check box is automatically selected and you cannot clear the check box.)
[Use Multicast]	

Discovery]	To respond to search commands by multicast, select the check box.
------------	---

Proceed to Step 3 if you do not specify the settings for the other options.

## Multicast Discovery Settings

- (1) Specify the multicast discovery settings.
- (2) Click [OK].

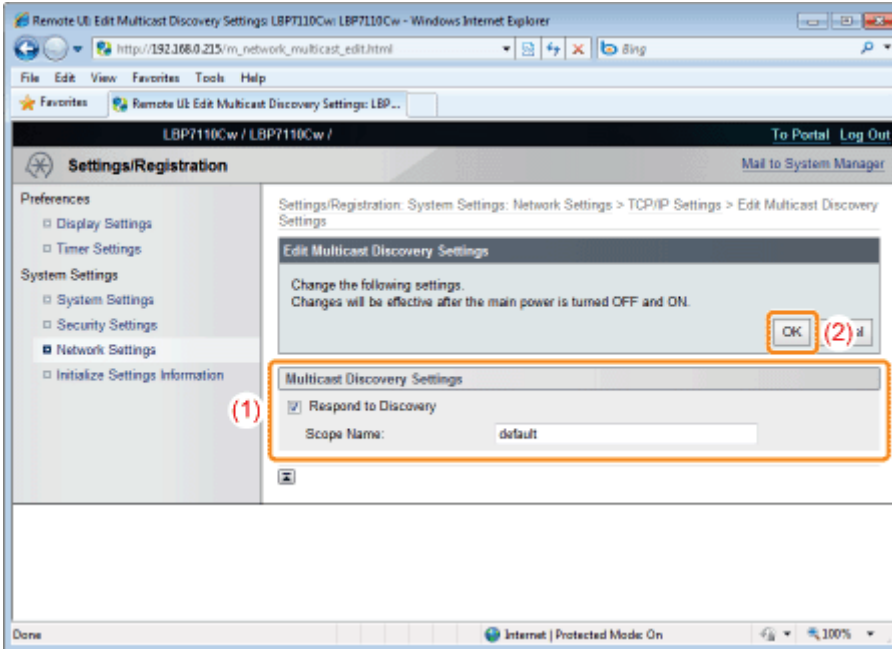

[Respond to Discovery]	To allow a response to multicast discovery, select the check box.
[Scope Name]	Enter the scope name to be used when searching for certain devices from utility software by multicast. You can enter up to 32 single-byte alphanumeric characters.

Proceed to Step 3 if you do not specify the settings for the other options.

## Port No. Settings

- (1) Specify the port number for each protocol.
- (2) Click [OK].

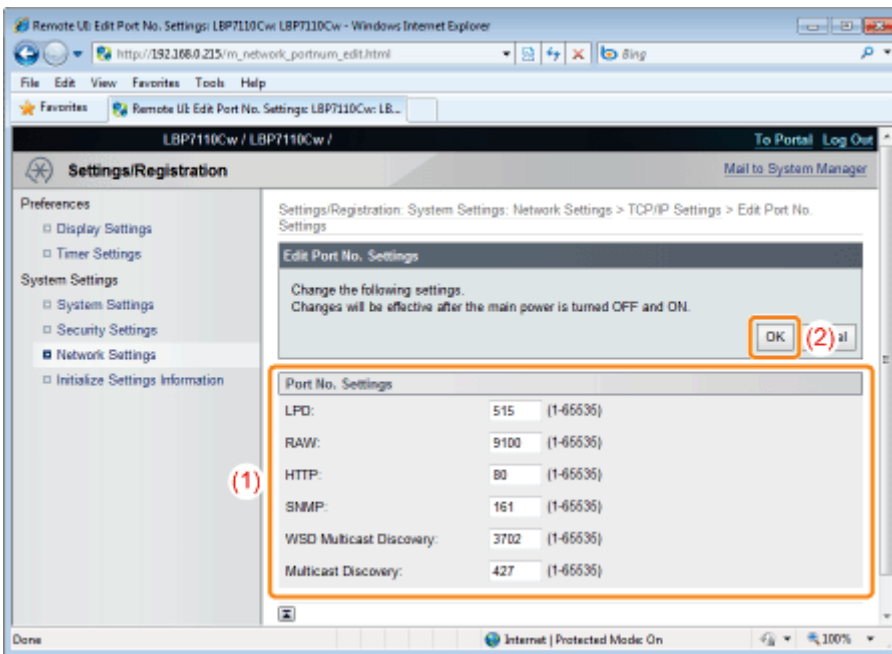

[LPD]	Enter the LPD port number.
[RAW]	Enter the RAW port number.
[HTTP]	Enter the HTTP port number.
[SNMP]	Enter the SNMP port number.
[WSD Multicast Discovery]	Enter the WSD multicast discovery port number.
[Multicast Discovery]	Enter the multicast discovery (SLP) port number.

Proceed to Step 3 if you do not specify the settings for the other options.

## MTU Size Settings

- (1) Specify the MTU size.
- (2) Click [OK].

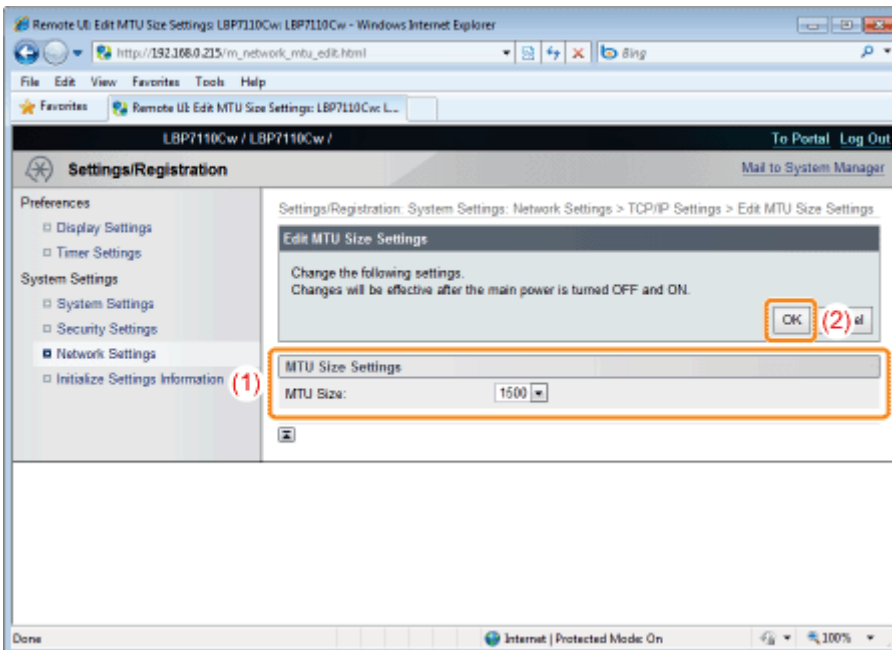

[MTU Size]	Select the MTU size.
------------	----------------------

Proceed to Step 3 if you do not specify the settings for the other options.

## SNTP Settings

- (1) Specify the settings for SNTP.
- (2) Click [OK].

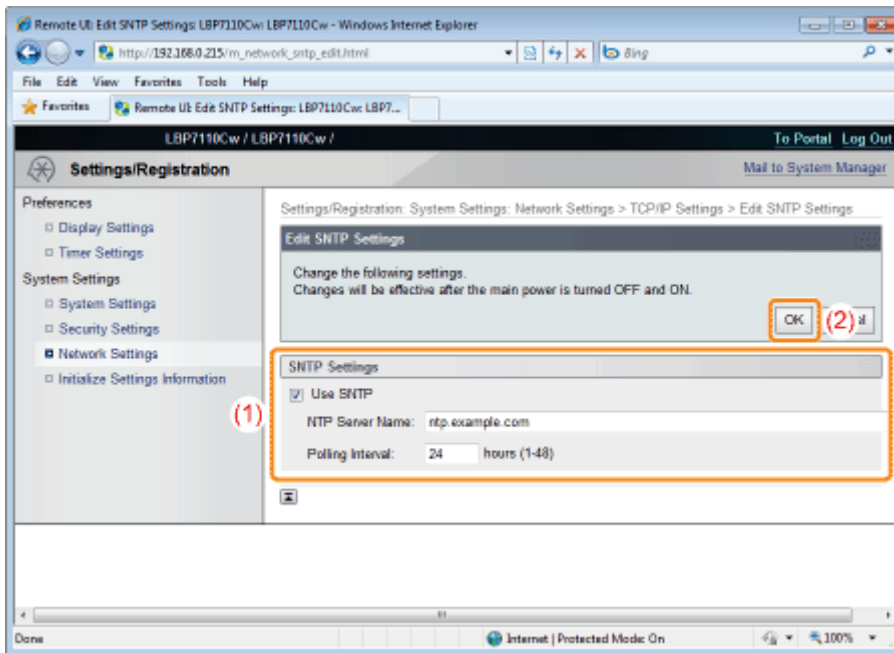

[Use SNTP]	<p>If you use the SNTP client function to obtain the time information from the NTP server (public time information server on the Internet), select the check box.</p> <p>↑ When obtaining the time information from the NTP server, be sure to specify the correct time zone and daylight saving time settings.</p> <p>➤ <a href="#">"Specifying the Time Zone and Daylight Saving Time Settings of the Printer"</a></p>
[NTP Server Name]	<p>If you have specified the DNS settings, enter the name of the NTP server.</p> <p>If you have not specified the DNS settings, enter the IP address of the NTP server.</p>
[Polling Interval]	<p>Specify the interval at which to request the time information from the NTP server.</p>

### **?** If an NTP server is not available

↑ This function is not supported for Macintosh.

You can notify the printer of the time set on the computer using the following procedure.

1. Display the Printer Status Window.
  - ["Printer Status Window"](#)
2. Select [Preferences (Administrators)] from the [Options] menu.
3. Select the [Notify the Printer of the Time] check box.

### **NOTE**

#### **Checking communication with the NTP server**

You can check communication with the NTP server by clicking [Check NTP Server Connection] on the [TCP/IP Settings] page.

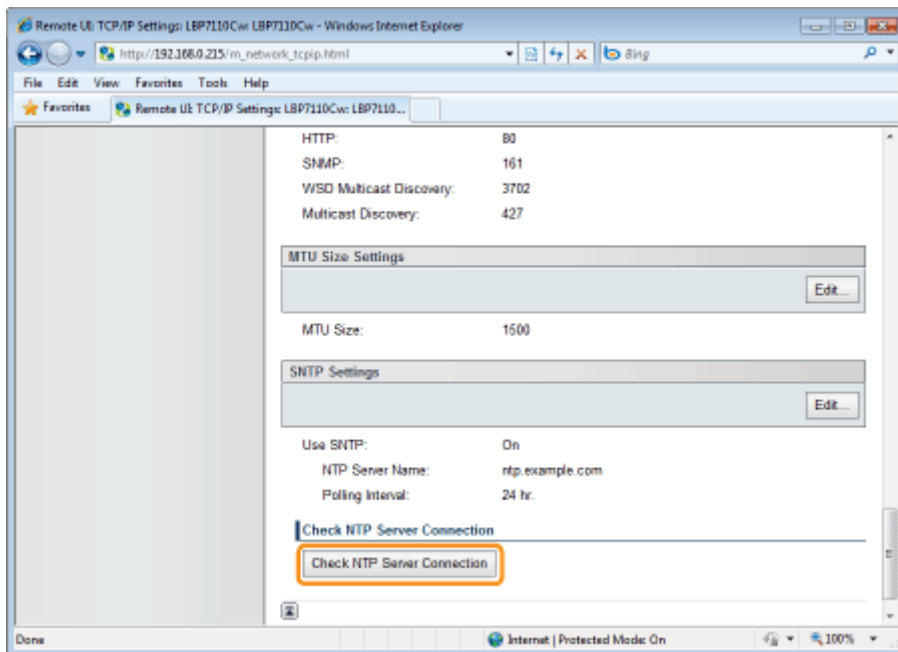

Clicking [Check NTP Server Connection] initiates communication with the NTP server specified in [NTP Server Name], and the communication result is shown in [NTP Server Connection Check Result] as follows.

[OK]	Able to successfully communicate with the NTP server
[Error]	Unable to communicate with the NTP server due to incorrect setting or communication error

Proceed to Step 3 if you do not specify the settings for the other options.

### 3

#### Restart the printer.

Turn the printer OFF, make sure that the Main Power indicator is off, wait for 10 seconds or longer, and then turn it ON again.

→ After the printer is restarted, the settings become effective.

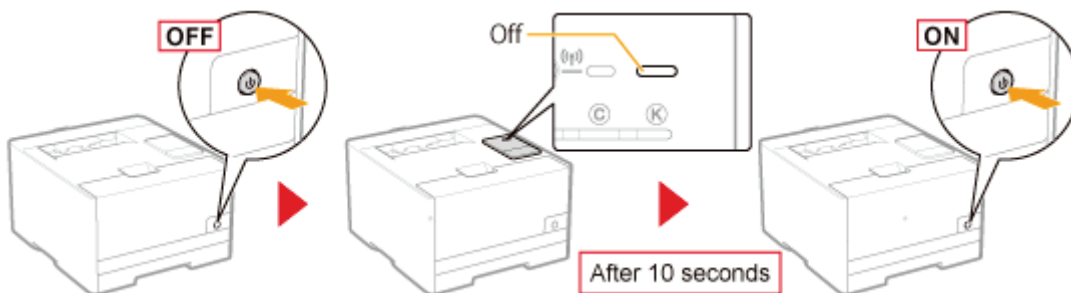

# Specifying a Dedicated Port

Specify the dedicated port settings to use when communicating with the computer.

## 1

**Start the Remote UI, and then log in as Management Mode.**

➤ "Starting the Remote UI"

## 2

**Click [Settings/Registration].**

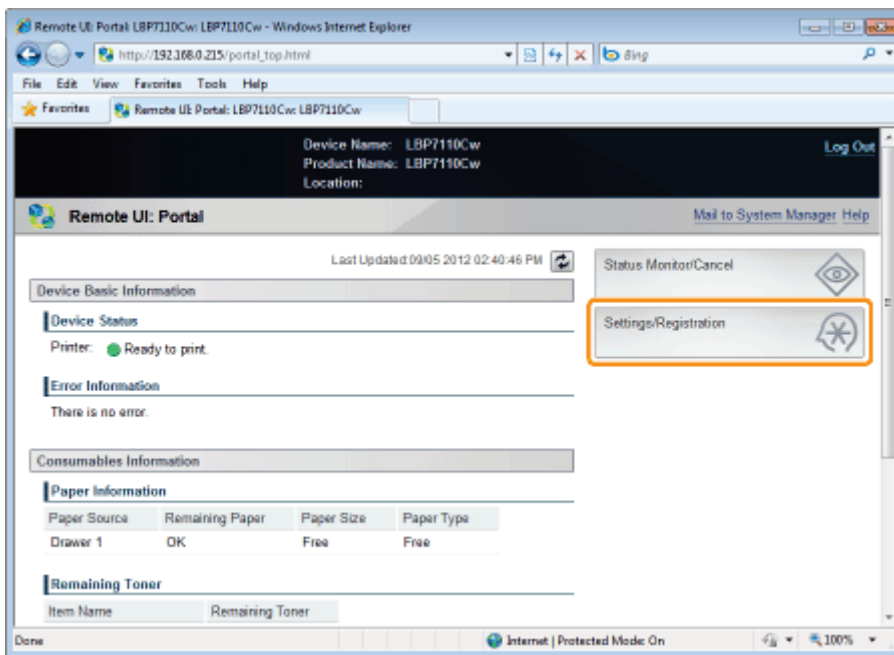

## 3

**Display the [Dedicated Port Settings] page.**

- (1) Select [Network Settings].
- (2) Click [Dedicated Port Settings].



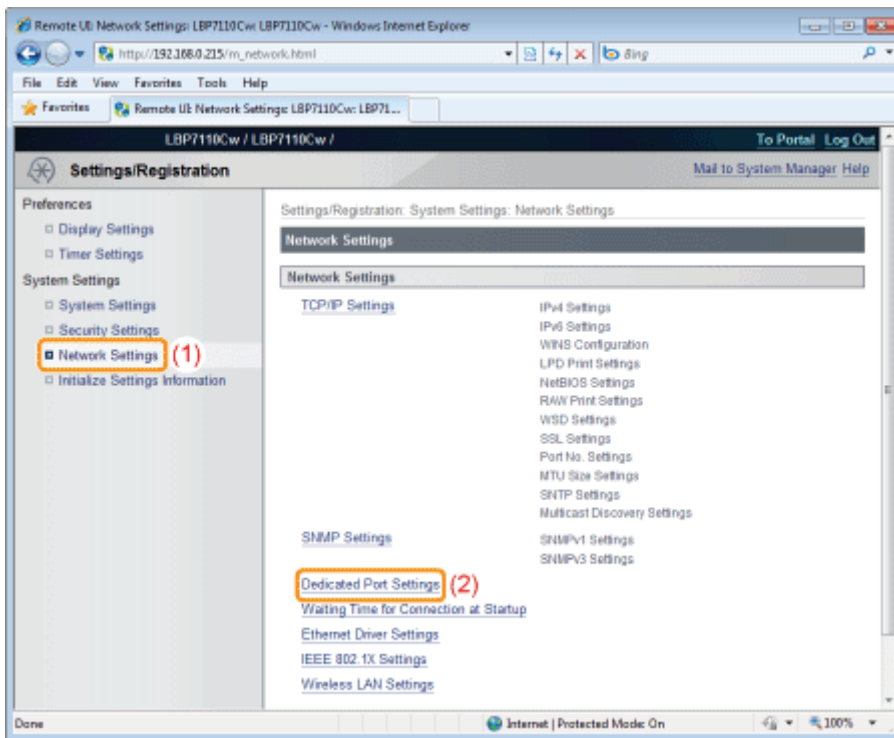

## 4

Click [Edit].

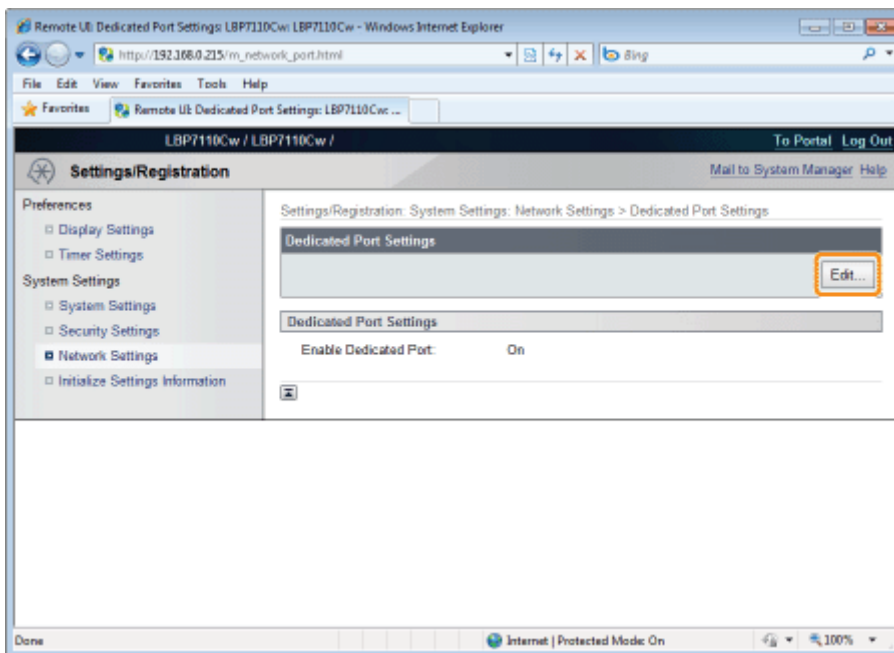

## 5

Specify the dedicated port settings.

- (1) Specify the dedicated port settings.
- (2) Click [OK].

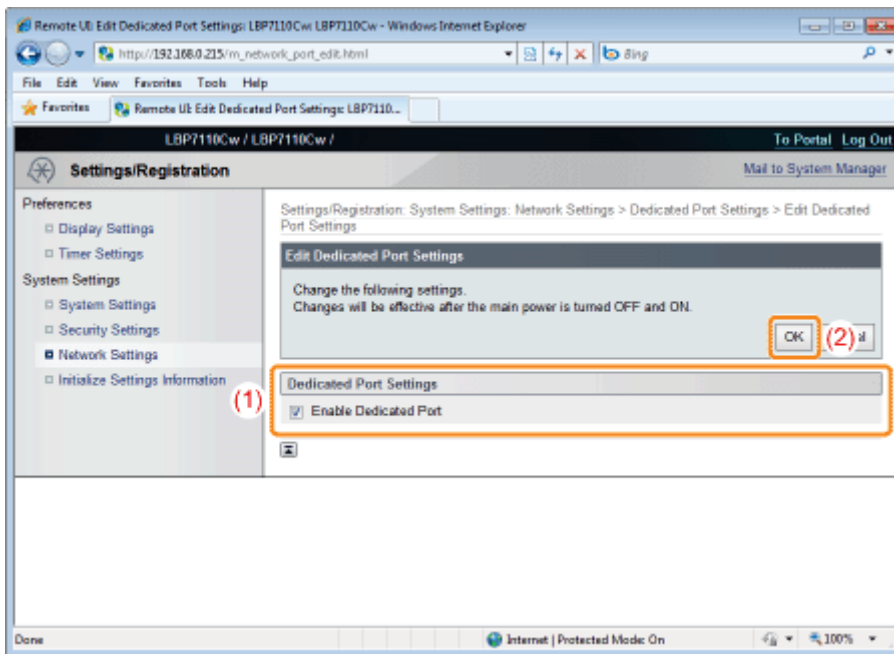

<p>[Enable Dedicated Port]</p>	<p>To enable a dedicated port, select the check box.</p> <p>↑ If you do not use a dedicated port (the check box is cleared), the printer information cannot be obtained when you use the printer driver or Printer Status Window with a network connection.</p>
--------------------------------	---

## 6

### Restart the printer.

Turn the printer OFF, make sure that the Main Power indicator is off, wait for 10 seconds or longer, and then turn it ON again.

→ After the printer is restarted, the settings become effective.

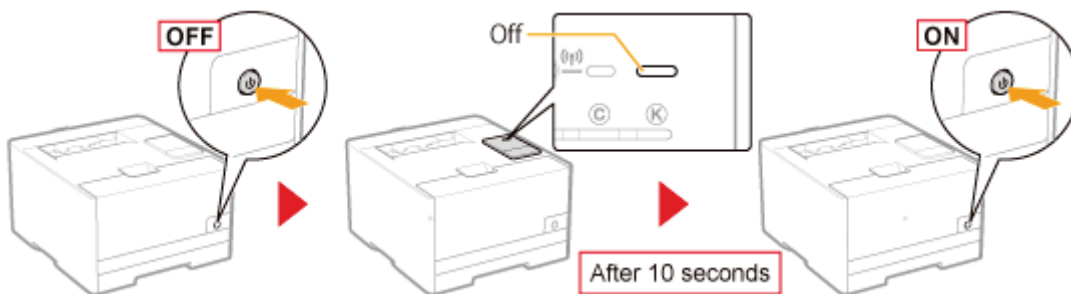

## Specifying the Waiting Time Until Connected to the Network

Specify the waiting time from when the printer is turned ON to when the printer is connected to the network.

### NOTE

#### If the printer is connected to a switching hub

Even if the network settings are correct, the printer may not be able to connect to the network. This is because communication cannot be performed between the printer and switching hub immediately after connecting the two devices due to the spanning tree process between the devices.

In this case, you must have the printer waiting to start the network connection.

† For details on the spanning tree process and other switching hub functions, contact the manufacturer.

## 1

**Start the Remote UI, and then log in as Management Mode.**

➤ "Starting the Remote UI"

## 2

**Click [Settings/Registration].**

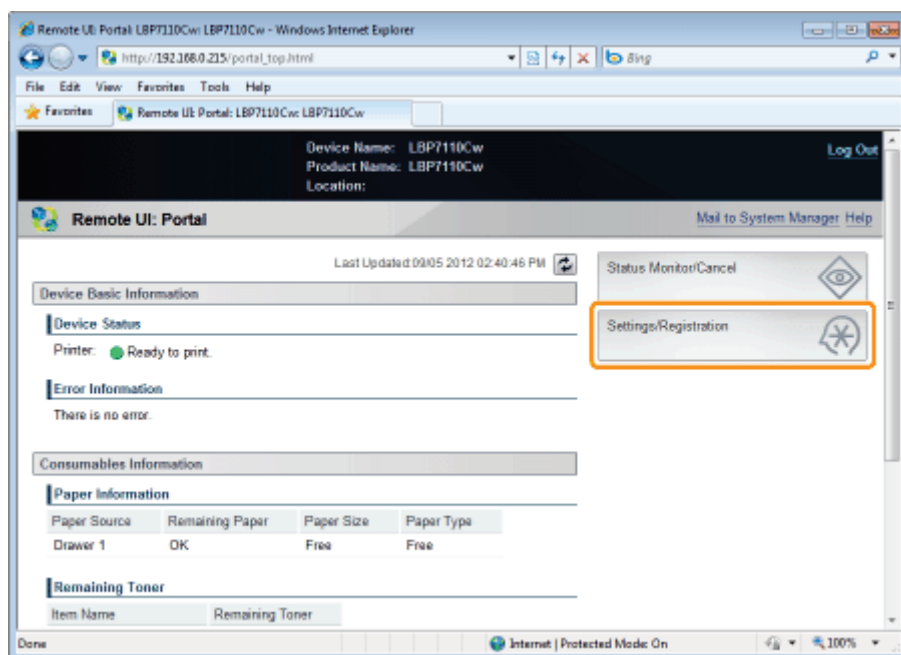

## 3

**Display the [Waiting Time for Connection at Startup] page.**

- (1) Select [Network Settings].
- (2) Click [Waiting Time for Connection at Startup].

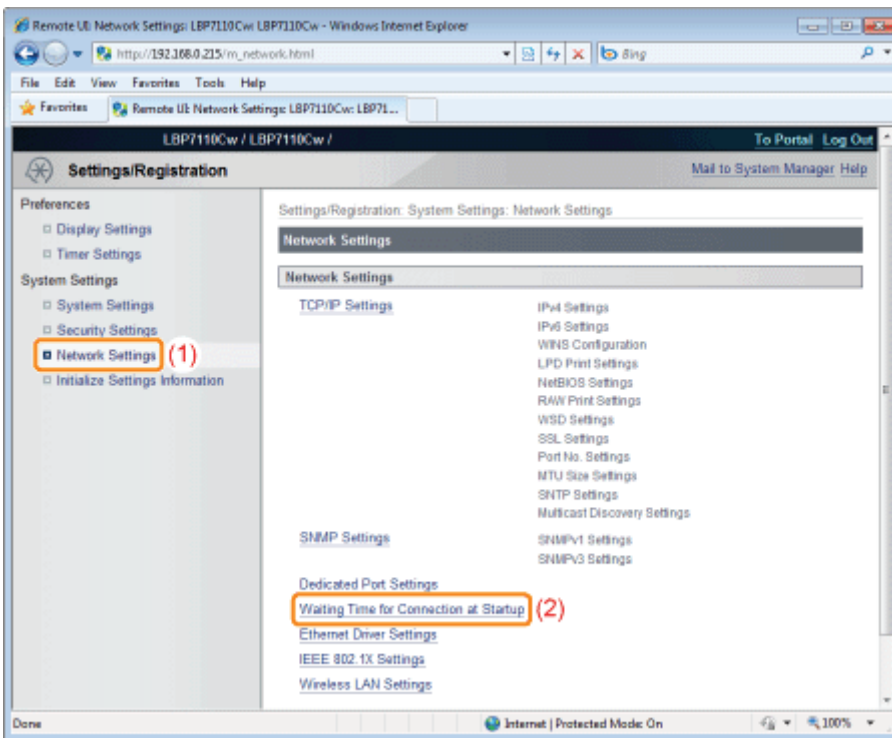

## 4

Click [Edit].

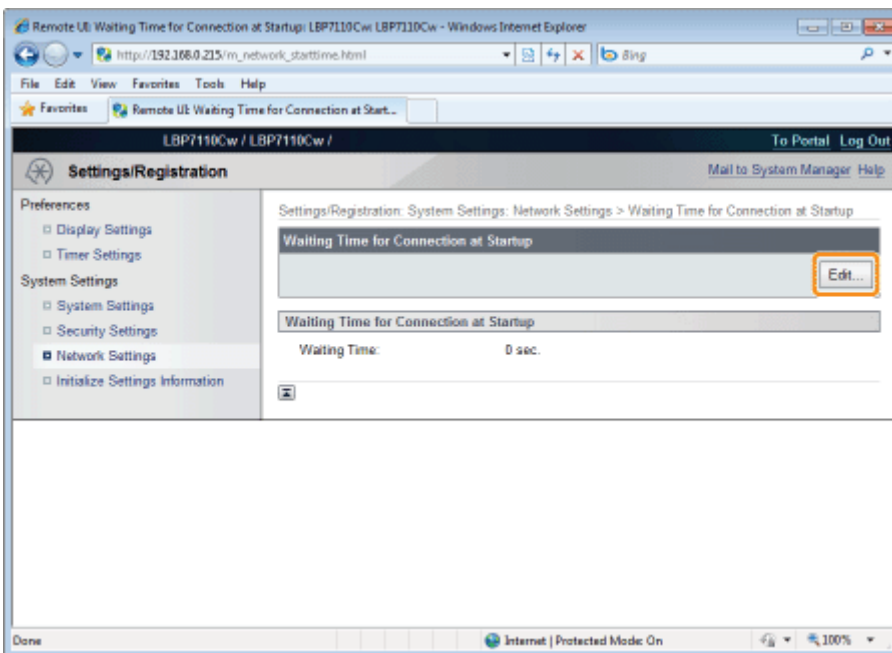

## 5

Specify the waiting time until connected to the network.

- (1) Specify the waiting time.
- (2) Click [OK].

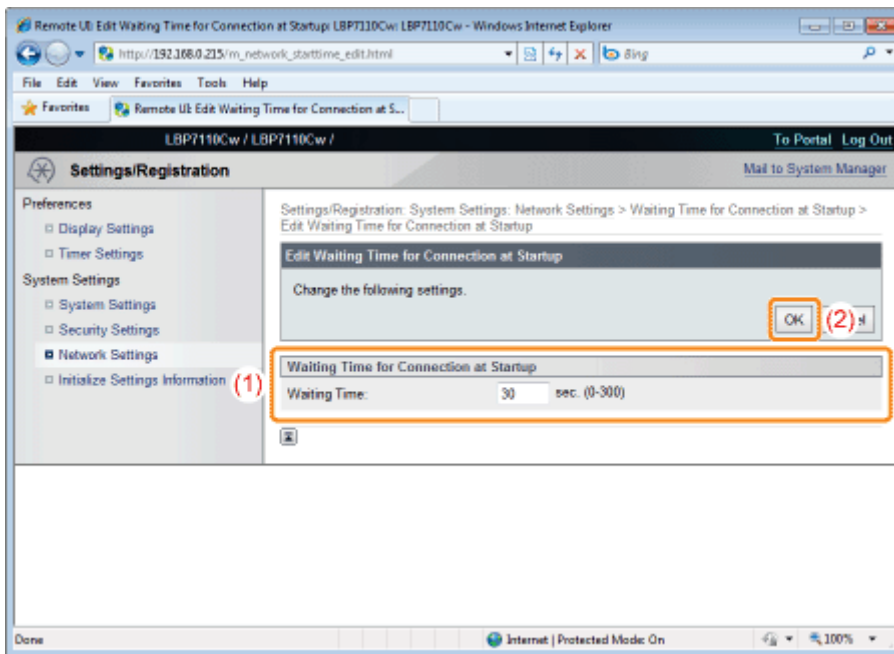

[Waiting Time]	Enter the waiting time from when the printer is turned ON to when the printer is connected to the network.
----------------	--

## 6

### Restart the printer.

Turn the printer OFF, make sure that the Main Power indicator is off, wait for 10 seconds or longer, and then turn it ON again.

→ After the printer is restarted, the settings become effective.

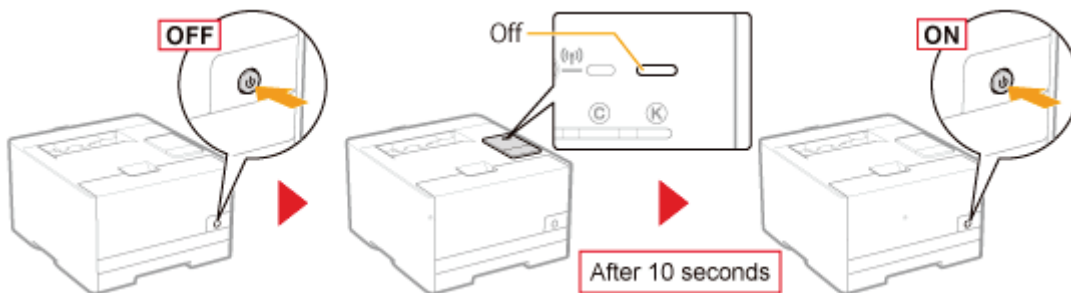

# Specifying the Wired LAN Communication Mode and Transmission Speed

Specify the communication mode and transmission speed (Ethernet type) settings of wired LAN.

## 1

**Start the Remote UI, and then log in as Management Mode.**

➤ "Starting the Remote UI"

## 2

**Click [Settings/Registration].**

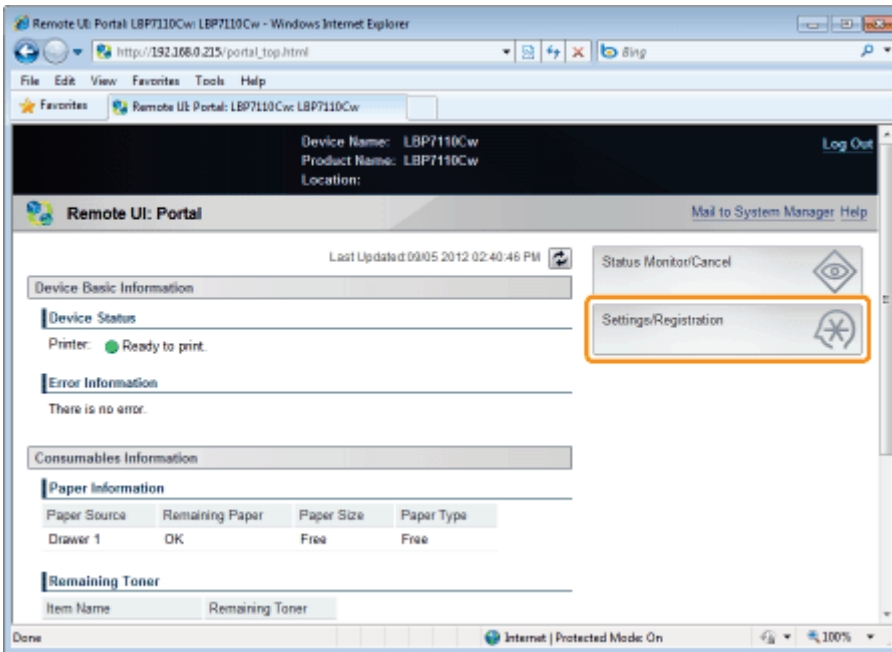

## 3

**Display the [Ethernet Driver Settings] page.**

- (1) Select [Network Settings].
- (2) Click [Ethernet Driver Settings].

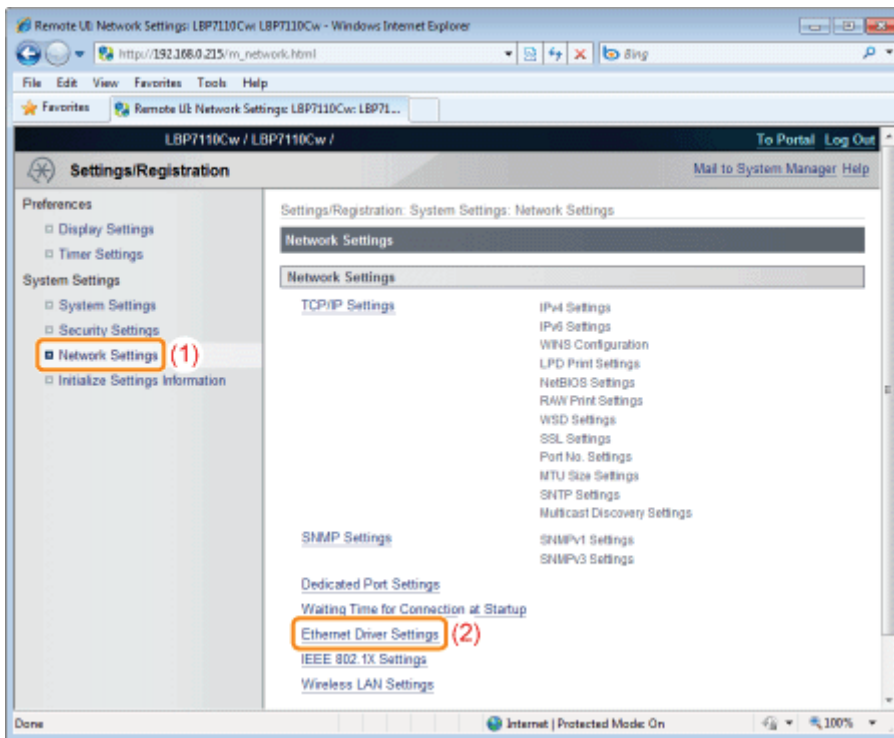

4

Click [Edit].

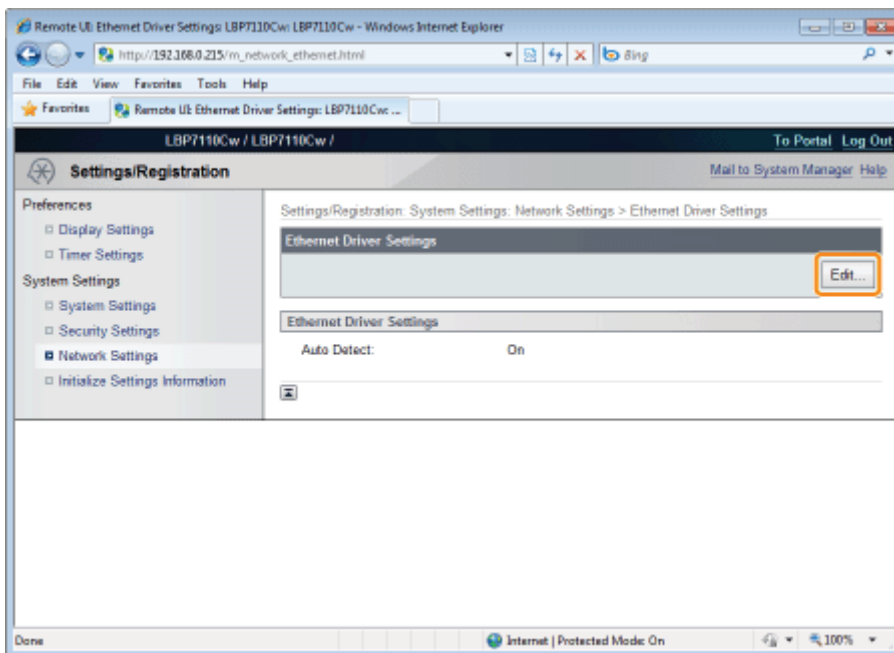

5

Specify the communication mode and transmission speed (Ethernet type) of wired LAN.

(1) Specify the Ethernet driver settings.

(2) Click [OK].

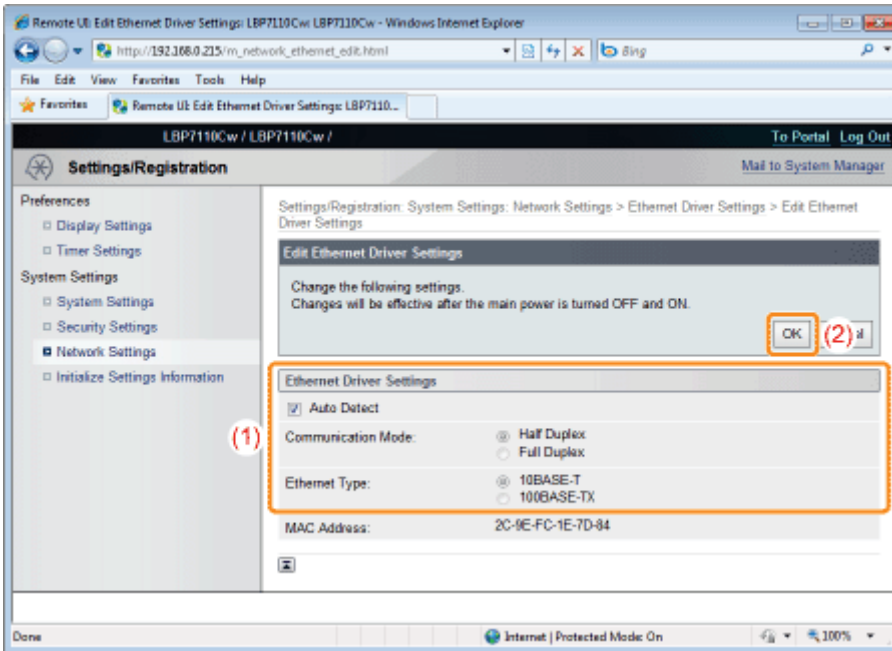

### When the communication mode and transmission speed are obtained automatically

[Auto Detect]	Select the check box.
---------------	-----------------------

### When the communication mode and transmission speed are obtained manually

[Auto Detect]	Clear the check box.
[Communication Mode]	<p>Select the communication mode that corresponds to your network environment.</p> <ul style="list-style-type: none"> <li>• <b>[Half Duplex]</b> Sending and receiving are alternated and are not performed at the same time.</li> <li>• <b>[Full Duplex]</b> Sending and receiving are performed at the same time.</li> </ul>
[Ethernet Type]	<p>Select the transmission speed that corresponds to your network environment.</p> <ul style="list-style-type: none"> <li>• <b>[10BASE-T]</b> Set to 10BASE-T network connection.</li> <li>• <b>[100BASE-TX]</b> Set to 100BASE-TX network connection.</li> </ul>

## 6

### Restart the printer.

Turn the printer OFF, make sure that the Main Power indicator is off, wait for 10 seconds or longer, and then turn it ON again.

→ After the printer is restarted, the settings become effective.

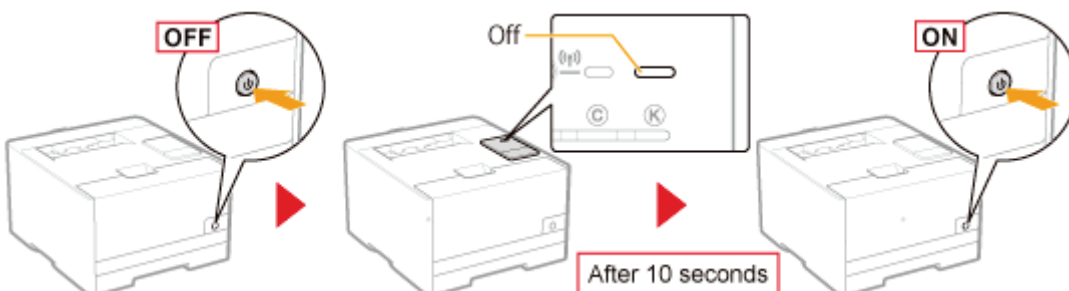



# Checking the IP Address of the Printer

This section describes the procedure for checking the IP address of IPv4 using the Go key on the printer to print the "User Data List."

† You can also print and check Network Status Print from the Printer Status Window.

† To check the IP address of IPv6, use Network Status Print.

➤ "Checking the Printer Settings"

## 1

### Print the "User Data List."

➤ "Printing the "User Data List""

## 2

### Check the IP address.



#### NOTE

##### About the default setting

This setting is configured to automatically obtain the IP address using DHCP or the Auto IP function.

##### Checking and configuring the subnet

Use the following procedure to make sure that the computer and printer are on the same subnet.

1. From the [Start] menu, select [All Programs] → [Accessories] → [Command Prompt].
2. Enter "ipconfig" as a command in Command Prompt.
3. The network setting information of the computer appears. Confirm that the computer and printer are on the same subnet.

##### <Example>

Setting in a computer

- Subnet mask: "255.255.255.0" ▶ The IP address of the printer needs to be "192.168.0.xxx". (xxx indicates an arbitrary number.)
- IP Address: "192.168.0.10"

# Checking the MAC Address of the Printer

This section describes the procedure for checking the MAC address of the printer using the Go key on the printer to print the "User Data List."

† You can also use the following procedure to check the MAC address.

- Printing Network Status Print from the Printer Status Window
  - ❖ "Checking the Printer Settings"
- Starting the Remote UI (❖ "Starting the Remote UI"), logging in as Management Mode, and checking with the following page
  - **When checking the MAC address of the wired LAN**  
[Settings/Registration] - [Network Settings] - [Ethernet Driver Settings] page
  - **When checking the MAC address of the wireless LAN (LBP7110Cw Only)**  
[Settings/Registration] - [Network Settings] - [Wireless LAN Settings] page

## 1

### Print the "User Data List."

❖ "Printing the "User Data List""

## 2

### Check the MAC address.

#### When checking the MAC address of the wired LAN

[MAC Address] in [3.Ethernet Driver Settings]

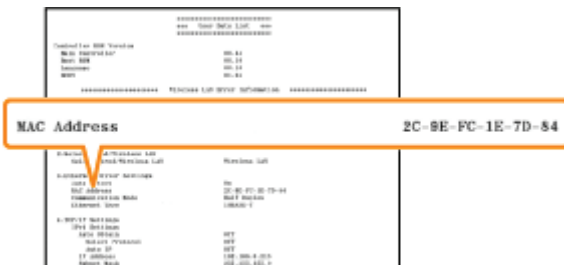

#### When checking the MAC address of the wireless LAN (LBP7110Cw Only)

[MAC Address] in [5.Wireless LAN Settings]

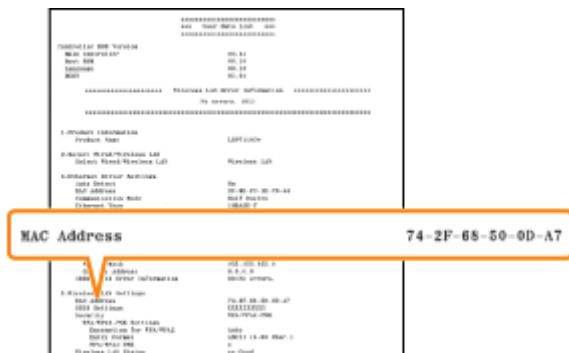

## Checking the Wireless LAN Information (LBP7110Cw Only)

This section describes the procedure for checking the wireless LAN information using the Remote UI.

† You can also use the following procedure to check the wireless LAN information.

- Printing Network Status Print from the Printer Status Window
  - ❏ "Checking the Printer Settings"
- Printing the "User Data List" using the Go key on the printer
  - ❏ "Printing the "User Data List"'"

### 1

**Start the Remote UI, and then log in as Management Mode.**

❏ "Starting the Remote UI"

### 2

**Click [Settings/Registration].**

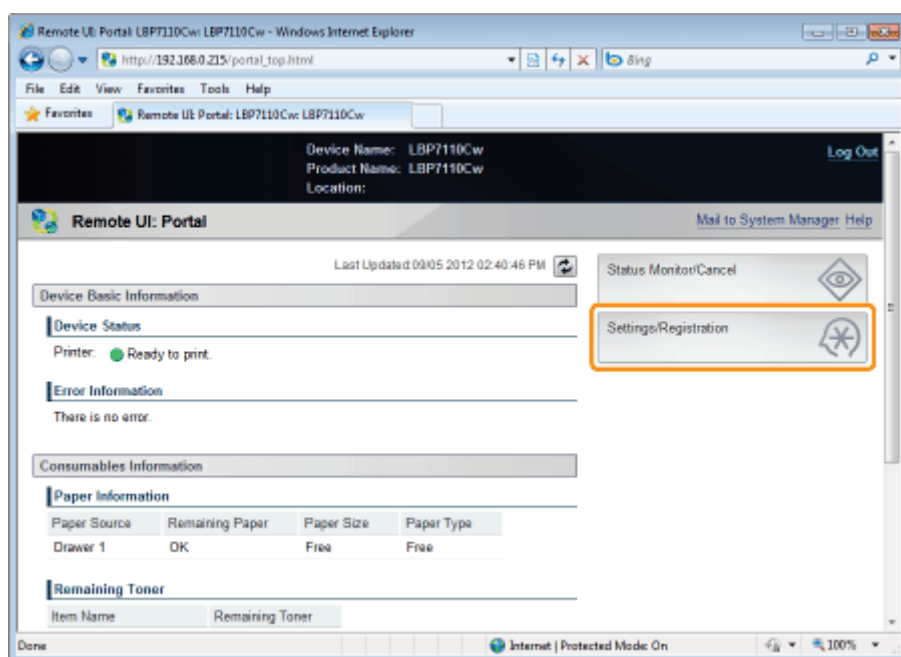

### 3

**Display the [Wireless LAN Settings] page.**

- (1) Select [Network Settings].
- (2) Click [Wireless LAN Settings].

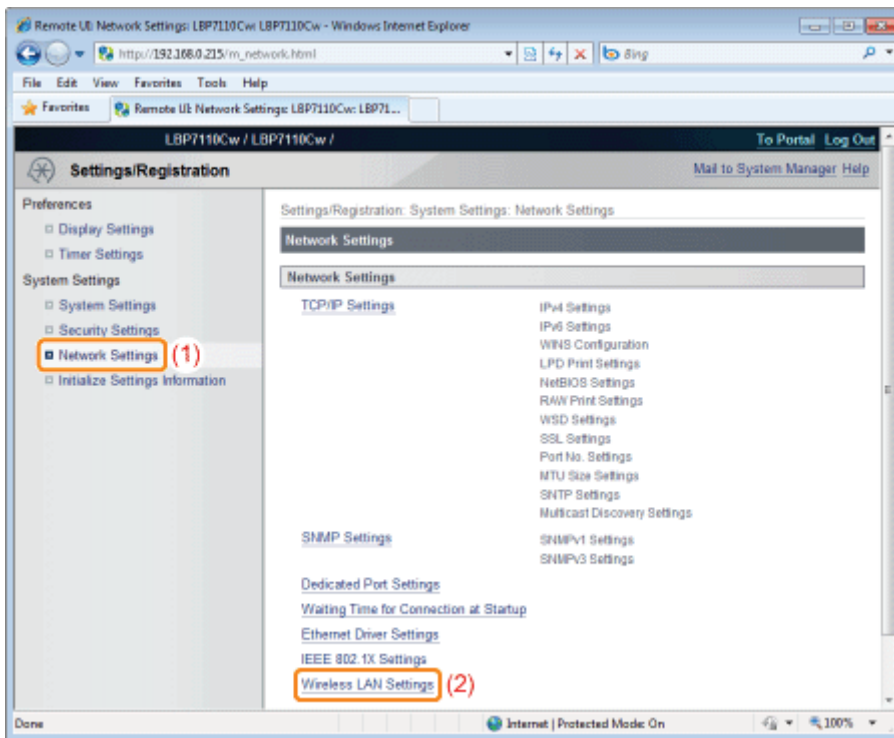

## 4

**Check the wireless LAN information.**

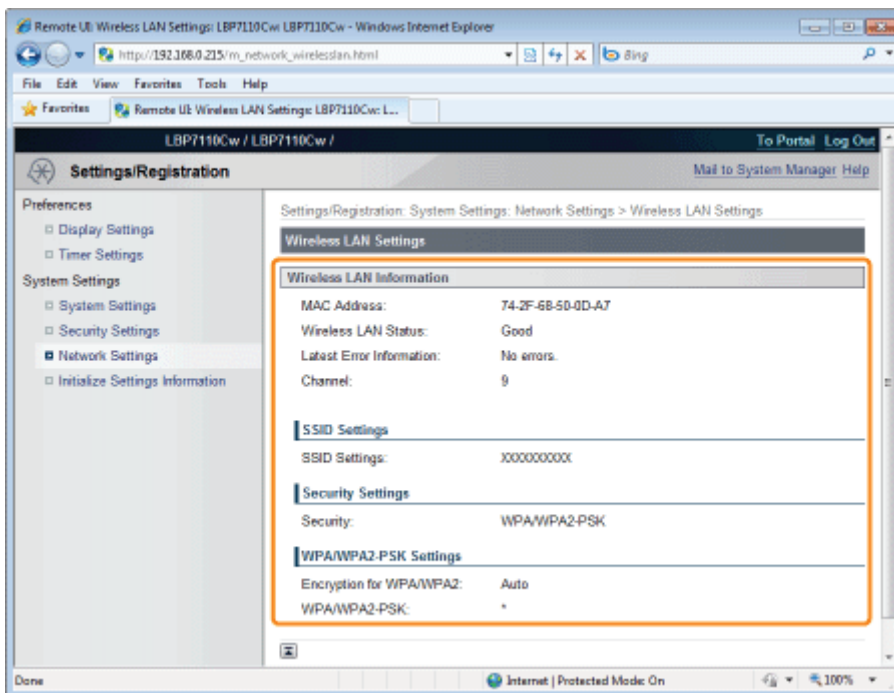

[MAC Address]	Displays the MAC address of the printer (wireless LAN).
[Wireless LAN Status]	Displays the connection status (signal strength) of the wireless LAN.
[Latest Error Information]	Displays the latest error information when the wireless LAN connection fails.
[Channel]	Displays the wireless LAN channel that is being used.
[SSID Settings]	Displays the SSID of the access point that is set.
[Security Settings]	Displays the type of encryption that is set.

[WPA/WPA2-PSK Settings]	Displays the WPA/WPA2-PSK setting.
[WEP Settings]	Displays the WEP setting.

---

# Configuring and Changing the Port

Use the following procedure to manually configure and change the port.

† To change the port configuration (printing protocol), see "[Changing the Port Configuration.](#)"

## 1

**Open the printer folder.**

➤ "Basic Operations/Various Information for Windows"

## 2

**Right-click the icon for this printer, and then select [Printer properties] or [Properties] from the pop-up menu.**

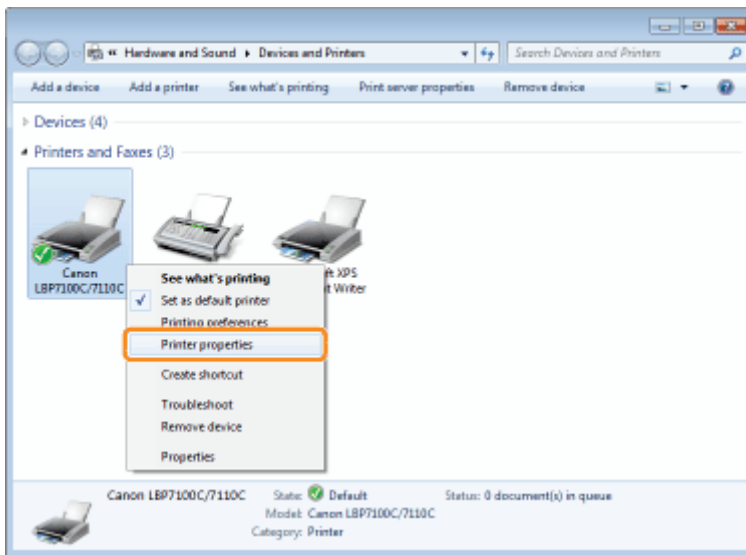

## 3

**Perform the following procedure.**

- (1) Display the [Ports] sheet.
- (2) Click [Add Port].

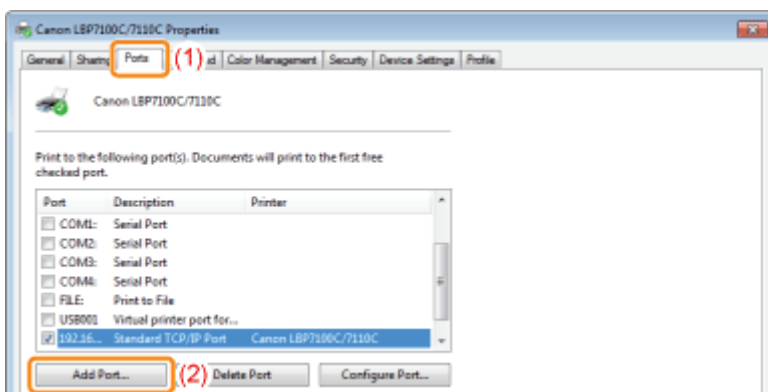

# 4

## Select the port type.

- (1) Select [Canon MFNP Port] or [Standard TCP/IP Port].
- (2) Click [New Port].

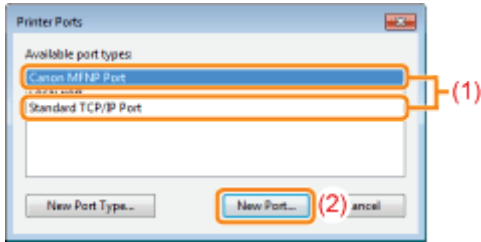

[Canon MFNP Port]	<p>The port that can automatically detect the IP address of the printer. Even if the IP address of the printer changes, the port does not have to be changed because a new IP address is detected automatically when the printer and computer are on the same subnet.</p> <ul style="list-style-type: none"><li>† MFNP Port only supports IPv4. (It does not support IPv6.)</li><li>† This option does not appear if you install the printer driver using a method other than Easy Installation. (You cannot specify MFNP Port.)</li></ul>
[Standard TCP/IP Port]	<p>TCP/IP Port that is standard with Windows. If the IP address of the printer is changed, the port to be used should be changed.</p>

# 5

## Operation procedures vary depending on the type of port to be configured.

- ❖ When configuring MFNP Port
- ❖ When configuring Standard TCP/IP Port

### When configuring MFNP Port

#### 1. Select the printer with Auto Detect.

- (1) Select [Auto Detect].
- (2) Select the printer to configure a port.

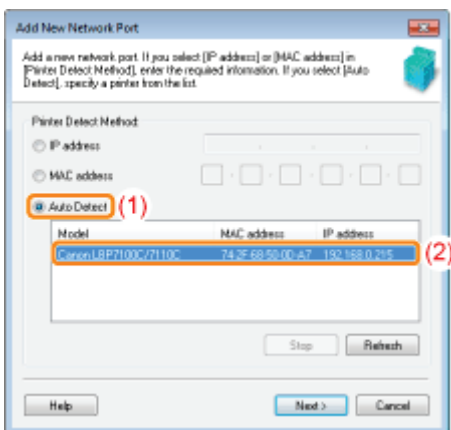

#### ? When a port cannot be detected automatically

Enter the IP address or MAC address of the printer.

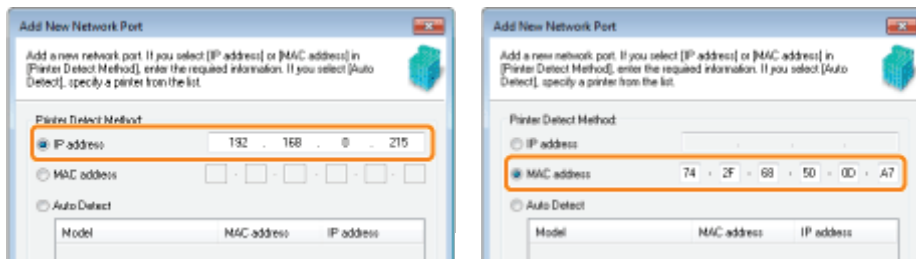

† If you are not sure about the IP address or MAC address of the printer, see "Checking the IP Address of the Printer" or "Checking the MAC Address of the Printer."

## 2. Click [Next].



## 3. Click [Add].

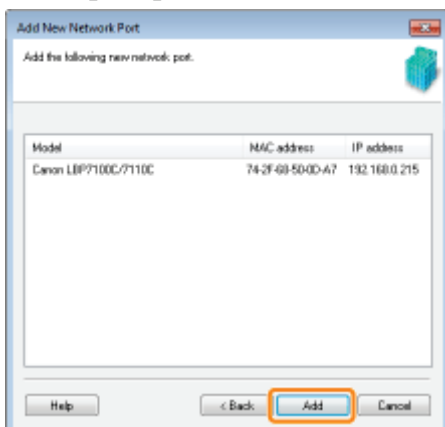

## 4. Click [Finish].

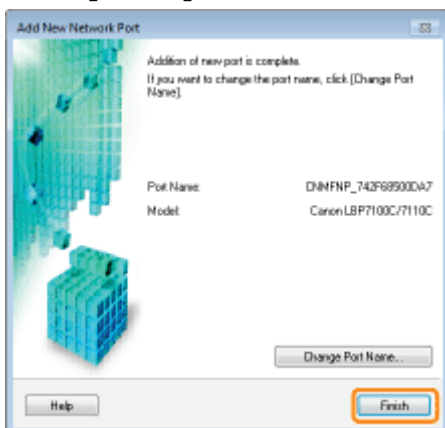

## 5. Proceed to Step 6.

### When configuring Standard TCP/IP Port

## 1. Click [Next].



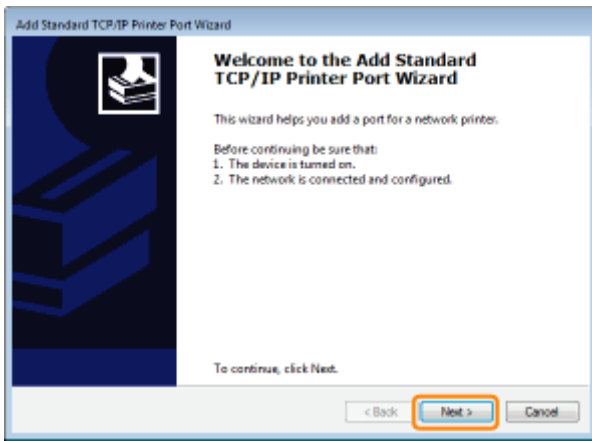

## 2. Enter the IP address or name of the printer.

(1) Enter the new IP address or name\* of the printer.

\* The DNS name to be registered on the DNS server (up to 78 characters)

(2) Click [Next].

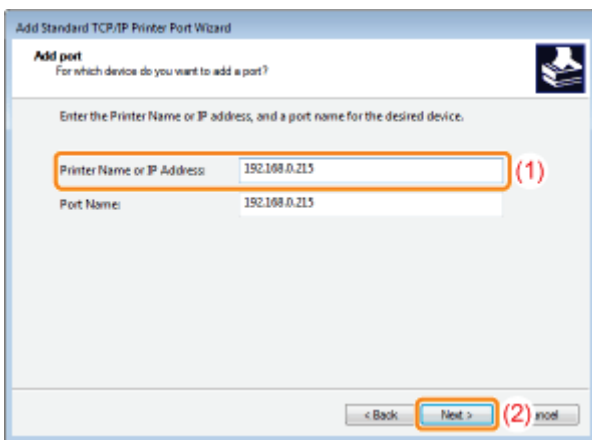

### ? If you are not sure about the value to be entered in [Printer Name or IP Address]

The value to be entered varies depending on how the IP address of the printer was set.

For more details, see "[Basic Operations/Various Information for Windows](#)" or ask your network administrator.

### ? If the printer is not detected

Follow the on-screen instructions and search again for the printer, or see "[Basic Operations/Various Information for Windows](#)" and specify [Device Type].

## 3. Click [Finish].

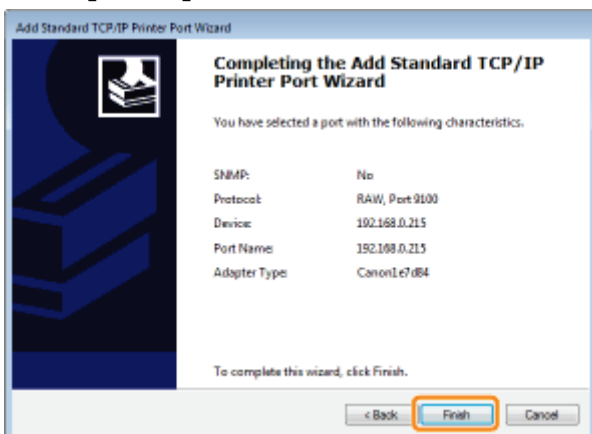

## 4. Proceed to Step 6.

# 6

Click [Close].

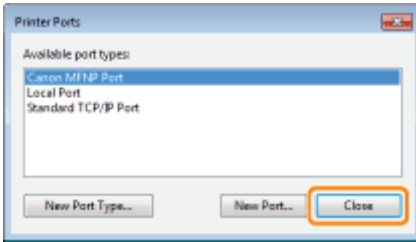

# 7

Click [Apply].

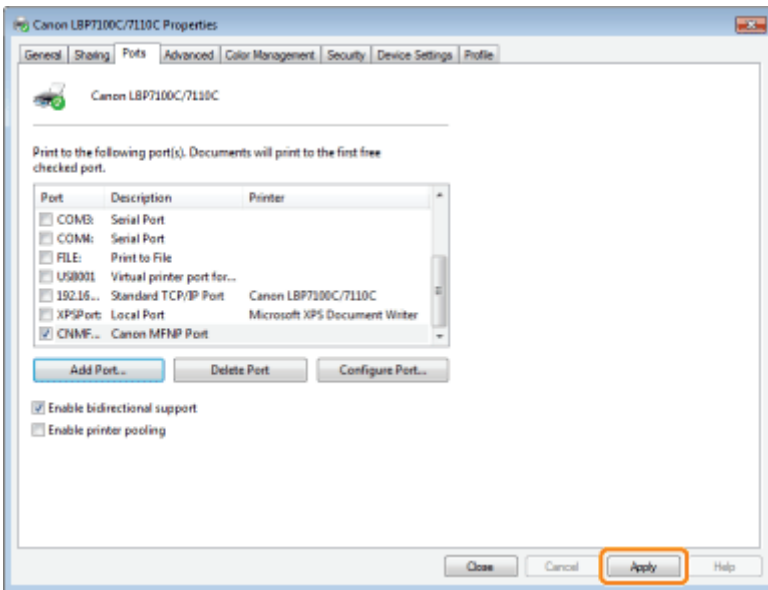

# 8

Click [OK].

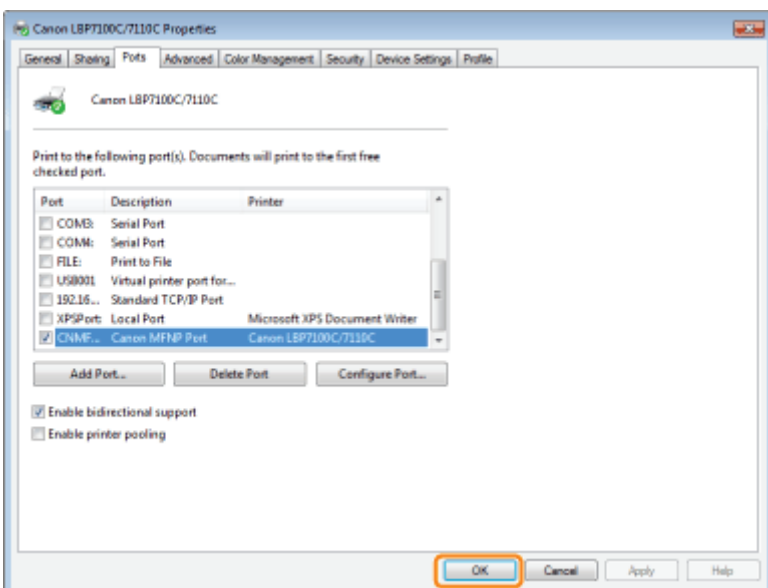

 **NOTE**

### **When changing the port configuration (printing protocol)**

➤ ["Changing the Port Configuration"](#)

### **When deleting an unnecessary port**

Select the port you want to delete on the [Ports] sheet, and then click [Delete Port].

# Changing the Port Configuration

Use the following procedure to change the port configuration (printing protocol).

## 1

**Open the printer folder.**

❖ "Basic Operations/Various Information for Windows"

## 2

**Right-click the icon for this printer, and then select [Printer properties] or [Properties] from the pop-up menu.**

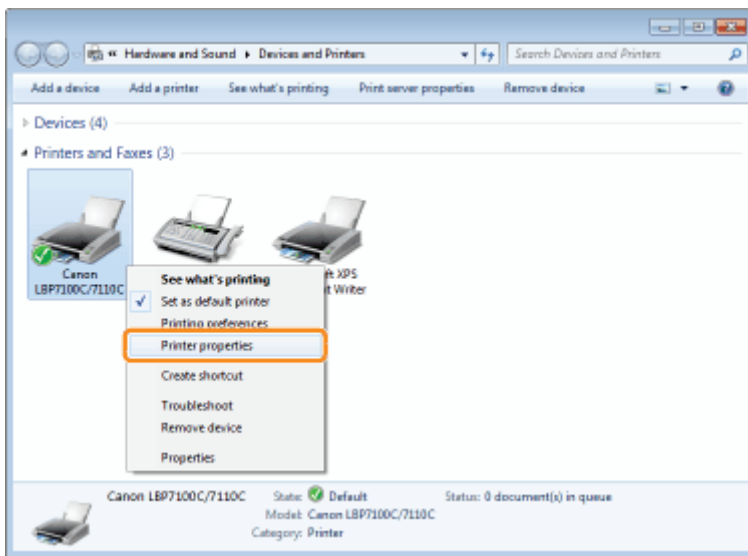

## 3

**Perform the following procedure.**

- (1) Display the [Ports] sheet.
- (2) Click [Configure Port].

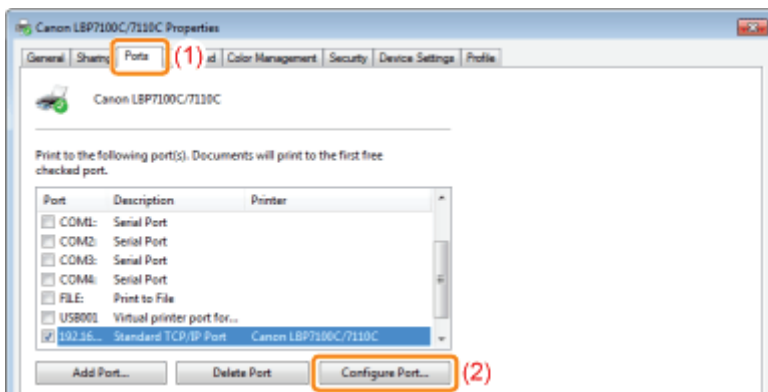

## 4

**Change the port configuration information.**

- (1) Configure the printing protocol settings.
- (2) Click [OK].

### For MFNP Port

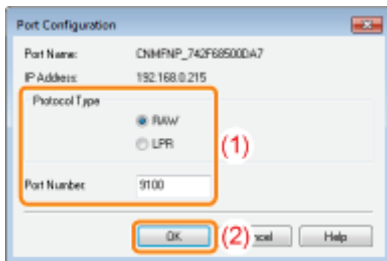

[Protocol Type]	Select the printing protocol (RAW or LPR).
[Port Number]	Enter the port number of the printing protocol configured on the printer.

### For Standard TCP/IP Port

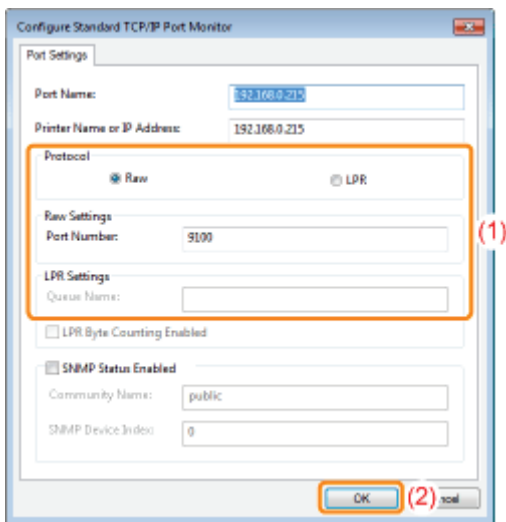

[Protocol]	Select the printing protocol (RAW or LPR).
[Raw Settings]	Enter the port number for RAW configured on the printer in [Port Number].
[LPR Settings]	Enter "lp" in [Queue Name].

#### NOTE

#### About printing protocols

- **RAW (RAW printing):**  
Printing protocol to use with Windows XP/Vista/7/Server 2003/Server 2008. Enables faster printing than with LPR (LPD printing).
- **LPR (LPD printing):**  
Printing protocol normally used with TCP/IP.

#### Setting the printer port number

- "Other Protocol Settings"

## 5

Click [Close].

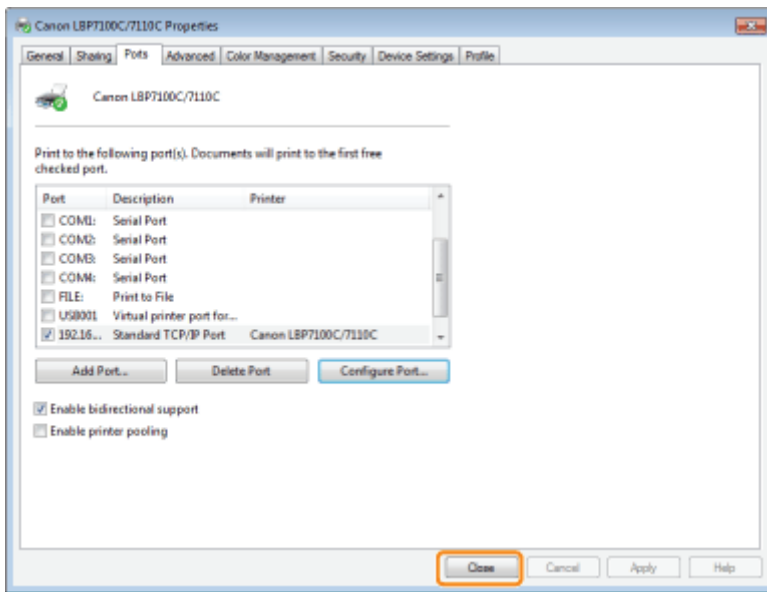

## If You Use the Printer in the Print Server Environment

If you use the printer in the print server environment, you can perform printing from other computers (clients) that are not directly connected to this printer.

- † The computer directly connected to the printer is called "print server", and the other computers which use the printer via the print server are called "clients."
- † This function is not supported for Macintosh.

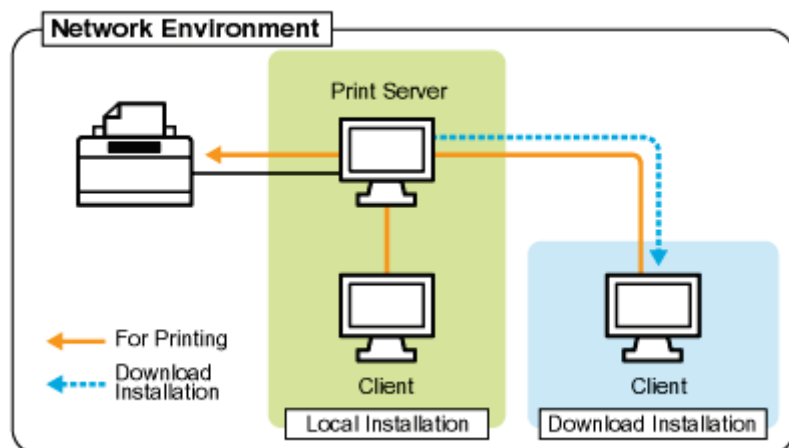

Also, if you set the print server, you can manage the printer efficiently as follows.

- You can manage the clients' printing preferences on the print server.
- Clients can download and install the printer driver from the print server. (The CD-ROM is not required.)

If you want to use the printer in the print server environment, perform any one of the following tasks.

### If your computer is the print server

#### 1. Install the printer driver.

##### ❖ "Installing the Printer Driver"

- † If the printer driver is already installed, you do not need to install it.
- † You can connect the printer and the print server via USB or the network. Select a connecting method according to your environment.

#### 2. Configure the print server.

##### ❖ "Configuring the Print Server"

### If your computer is a client computer

#### Install the printer driver.

There are two ways to install the printer driver on client computers: Local installation and download installation.

##### <Local Installation>

You can install the printer driver using the supplied CD-ROM. The e-Manual is also installed simultaneously when selecting "Easy Installation."

##### ❖ "Easy Installation"

##### <Download Installation>

You can install the printer driver without using the supplied CD-ROM, but by downloading the printer driver from the print server.

There are the following two ways to download and install the printer driver.

- "Installing from the Printer Folder"
- "Installing from [Windows Explorer]"

 **NOTE**

**Precautions when downloading and installing the printer driver**

If a 64-bit operating system is running on the print server, the download installation for a client computer on which any of the following 32-bit operating systems is running is not supported due to the Windows restriction.

- Windows XP (on which no service pack or SP1 is installed)
- Windows Server 2003 (on which no service pack is installed)

† If you download and install the printer driver on any of the above 32-bit operating systems, you may fail to install the driver and may not be able to open the printing preferences dialog box.



# Configuring the Print Server

Before configuring the print server, check the settings of your network environment.  
➤ "Checking the Settings of Your Network"

## 1

**Open the printer folder.**

➤ "Basic Operations/Various Information for Windows"

## 2

**Display the [Sharing] sheet.**

Windows XP Windows Vista Windows Server 2003 Windows Server 2008

Right-click the icon for this printer, and then select [Sharing] from the pop-up menu.

Windows 7 Windows Server 2008 R2

1. Right-click the icon for this printer, and then select [Printer properties] from the pop-up menu.
2. Display the [Sharing] sheet.

## 3

**Perform the following procedure.**

Windows XP Windows Server 2003

Select [Share this printer]. Change [Share name] as needed.

Windows Vista Windows 7 Windows Server 2008

Select the [Share this printer] check box. Change [Share name] as needed.

† Do not use spaces or special characters for the share name.

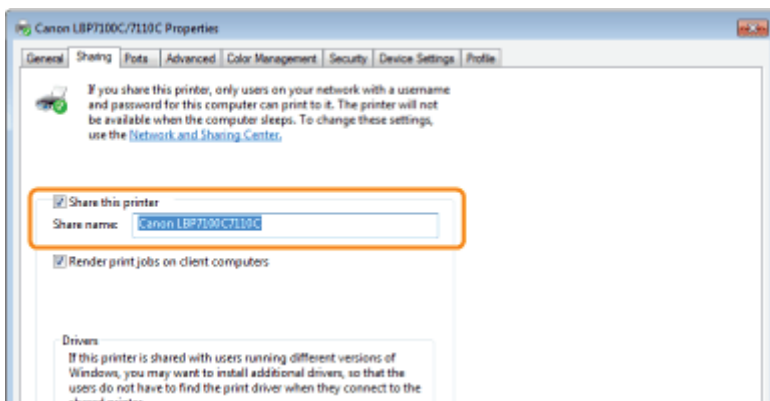

### ? If [Change sharing options] appears

Click [Change sharing options].

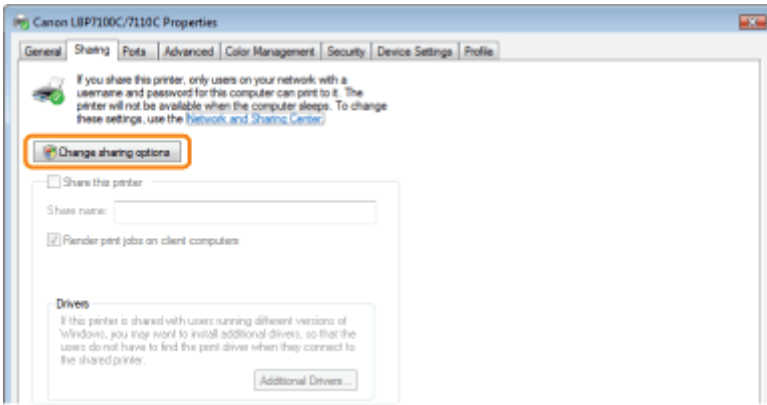

If the [User Account Control] dialog box appears, click [Continue].

Next, install the additional driver using the following procedure.

## 4

**Insert the supplied CD-ROM "User Software" into the CD-ROM drive of your computer, and then click [Additional Drivers].**

If CD-ROM Setup appears, click [Exit].

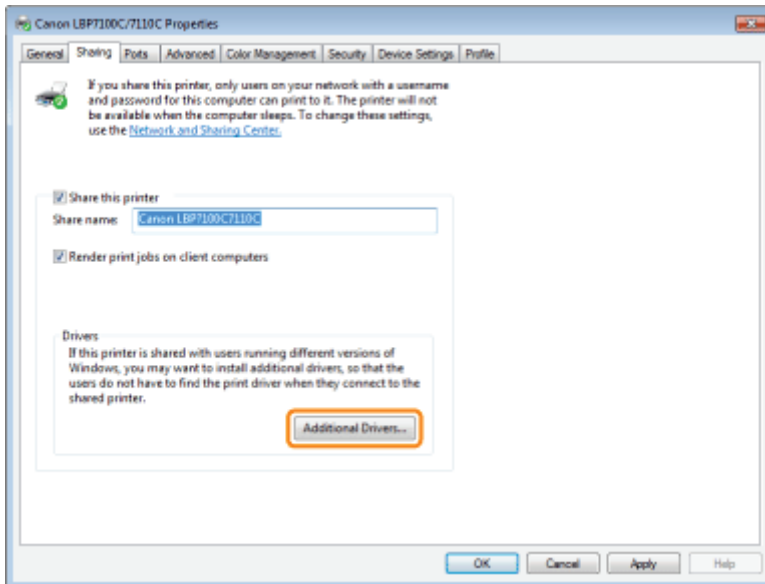

### NOTE

#### **When updating an additional driver (replacement driver)**

Perform the following procedure.

1. Uninstall the printer driver on the print server.
  - ❖ "Uninstalling the Printer Driver"
2. Install the new printer driver on the print server.
  - ❖ "Installing the Printer Driver"
3. Reinstall the additional driver.

## 5

**Select the additional driver.**

- (1) Select the additional driver.\*

(2) Click [OK].

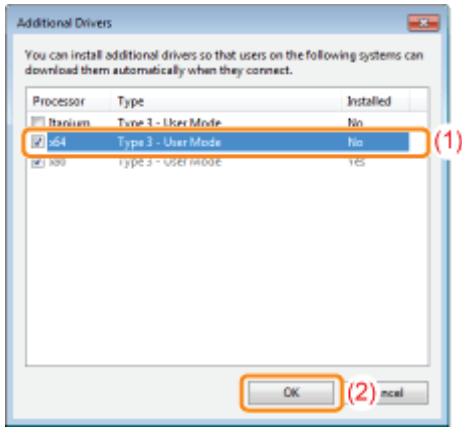

\* Select the additional driver as follows according to the operating system on the print server.

Print Server	Additional Driver to Be Selected
32-bit operating system	Select the [x64] check box.
64-bit operating system (Windows XP and Server 2003)	Select the check box for [Windows 2000, Windows XP and Windows Server 2003] in the [Version] column.
64-bit operating system (Windows Vista, 7, and Server 2008)	Select the check box for [x86] in the [Processor] column.

**?** If you are not sure whether you are using a 32-bit operating system or 64-bit operating system (Windows Vista, 7, and Server 2008)

➤ ["Basic Operations/Various Information for Windows"](#)

## 6

Click [Browse].

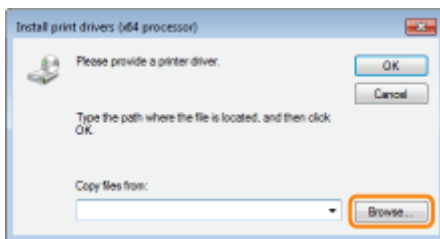

## 7

Open the folder in which the printer driver is included.

**If a 32-bit operating system is running on the print server**

Open the folders in the supplied CD-ROM: [English] - [x64] - [Driver].

**If a 64-bit operating system is running on the print server**

Open the folders in the supplied CD-ROM: [English] - [32bit] - [Driver].

## 8

Open the INF file.

- (1) Select the INF file.
- (2) Click [Open].

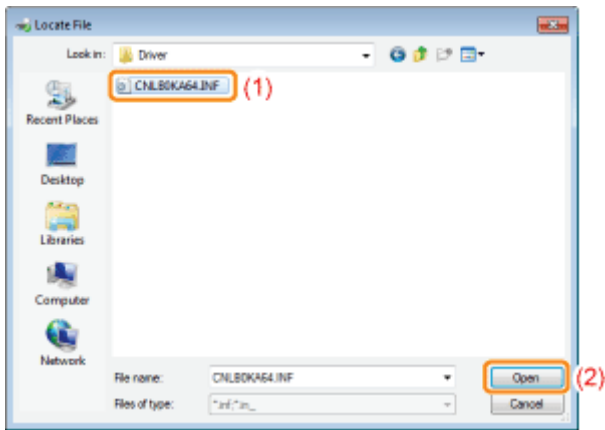

## 9

Click [OK] to start the installation of the additional driver.

→ Wait a moment until the [Sharing] sheet automatically reappears. (It may take a long time to install the additional driver.)



**?** If the [User Account Control] dialog box appears

Click [Yes].

## 10

Click [Close] or [OK].

† When the following screen appears, you can remove the CD-ROM.

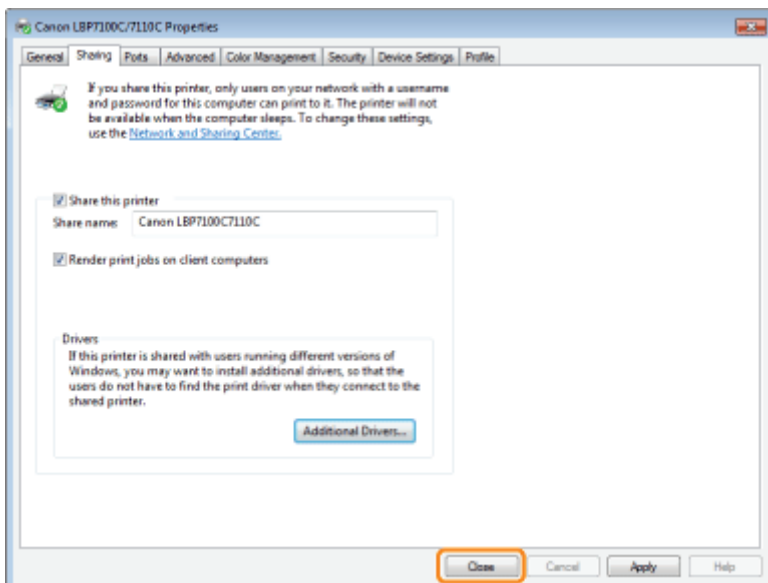

→ [State] or the printer icon change to those for the sharing settings.

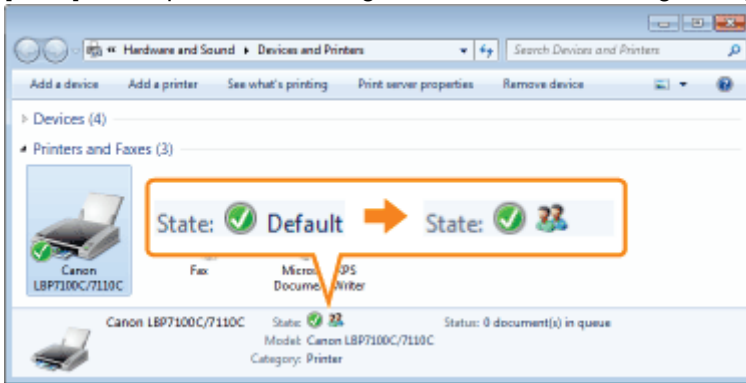

## **IMPORTANT**

### **To clear the printer sharing settings**

Clear it using the following procedure.

**Windows XP** **Windows Server 2003**

Select [Do not share this printer] in the [Sharing] sheet.

**Windows Vista** **Windows 7** **Windows Server 2008**

Clear the [Share this printer] check box in the [Sharing] sheet.

- † If [Change sharing options] appears, click [Change sharing options].  
If the [User Account Control] dialog box appears, click [Continue].

# Checking the Settings of Your Network

Before configuring the print server, check the settings of your network environment using the following procedure.

## 1

**Perform the following procedure.**

### Windows XP

From the [Start] menu, select [Control Panel], and then click [Network and Internet Connections] → [Network Connections].

### Windows Vista

From the [Start] menu, select [Control Panel], and then click [View network status and tasks] → [Manage network connections].

### Windows 7 Windows Server 2008 R2

From the [Start] menu, select [Control Panel], and then click [View network status and tasks] → [Change adapter settings].

### Windows Server 2003

From the [Start] menu, select [Control Panel] → [Network Connections] → [Local Area Connection].

### Windows Server 2008

From the [Start] menu, select [Control Panel], double-click [Network and Sharing Center], and then click [Manage network connections].

## 2

**Display the [Local Area Connection Properties] dialog box.**

### Windows XP Windows Vista Windows 7 Windows Server 2008

Right-click the [Local Area Connection] icon, then select [Properties] from the pop-up menu.

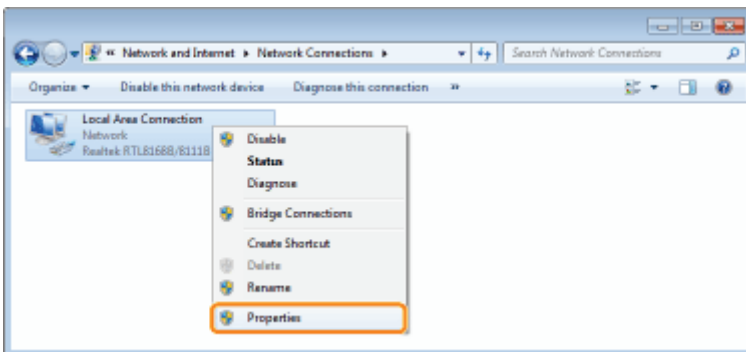

### Windows Server 2003

Click [Properties].

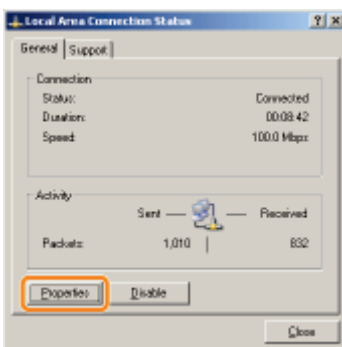

### **?** If the [User Account Control] dialog box appears

Click [Yes] or [Continue].

### 3

**Make sure that [File and Printer Sharing for Microsoft Networks] is selected.**

- (1) Make sure that the [File and Printer Sharing for Microsoft Networks] check box is selected.  
(If the check box is not selected, select it.)
- (2) Click [OK].

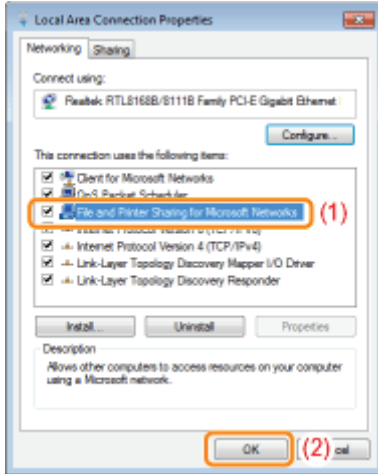

#### NOTE

##### **If you are using Windows XP**

You cannot configure the print server with the operating system default settings (the settings immediately after installation).

Before configuring the print server, run [Network Setup Wizard] to enable the printer sharing settings.

For more details, see Windows Help.

## Installation on Clients

---

There are two ways to install the printer driver on client computers: Local installation and download installation.

### Local Installation

---

You can install the printer driver using the supplied CD-ROM. The e-Manual is also installed simultaneously when selecting "Easy Installation."

➤ "Easy Installation"

### Download Installation

---

You can install the printer driver without using the supplied CD-ROM, but by downloading the printer driver from the print server.

There are the following two ways to download and install the printer driver.

➤ "Installing from the Printer Folder"

➤ "Installing from [Windows Explorer]"

#### NOTE

##### **Precautions when downloading and installing the printer driver**

If a 64-bit operating system is running on the print server, the download installation for a client computer on which any of the following 32-bit operating systems is running is not supported due to the Windows restriction.

- Windows XP (on which no service pack or SP1 is installed)
- Windows Server 2003 (on which no service pack is installed)

† If you download and install the printer driver on any of the above 32-bit operating systems, you may fail to install the driver and may not be able to open the printing preferences dialog box.



# Installing from the Printer Folder

The procedure for installing the printer driver from the printer folder varies depending on your operating system. See the following according to your operating system.

- ❖ Windows Vista, 7, and Server 2008
- ❖ Windows XP and Server 2003

## Windows Vista, 7, and Server 2008

### 1

**Turn the computer on, and then log on to Windows.**

### 2

**Open the printer folder.**

- ❖ "Basic Operations/Various Information for Windows"

### 3

**Click [Add a printer].**

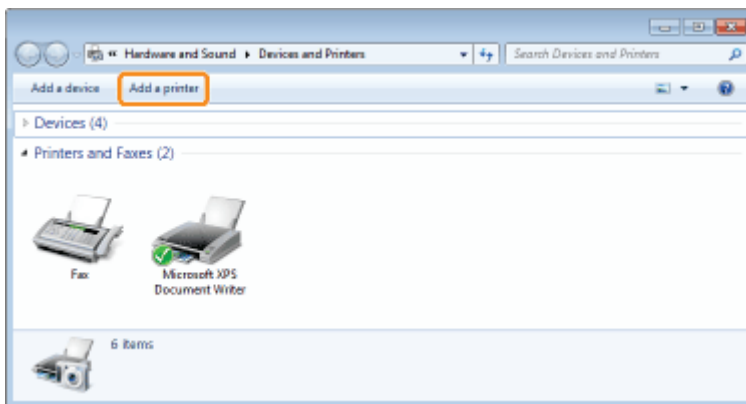

### 4

**Click [Add a network, wireless or Bluetooth printer].**

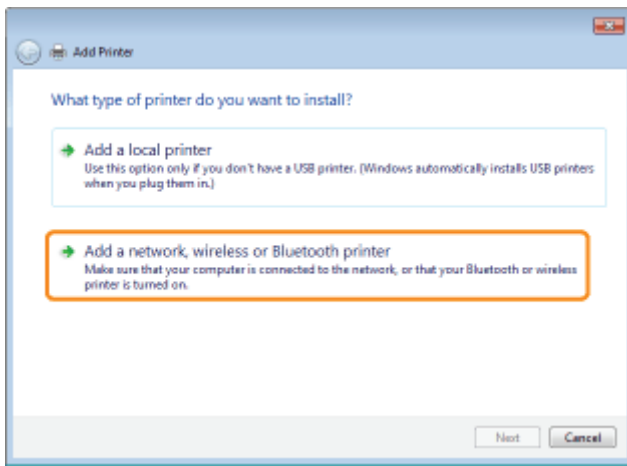

## 5

Click [The printer that I want isn't listed].

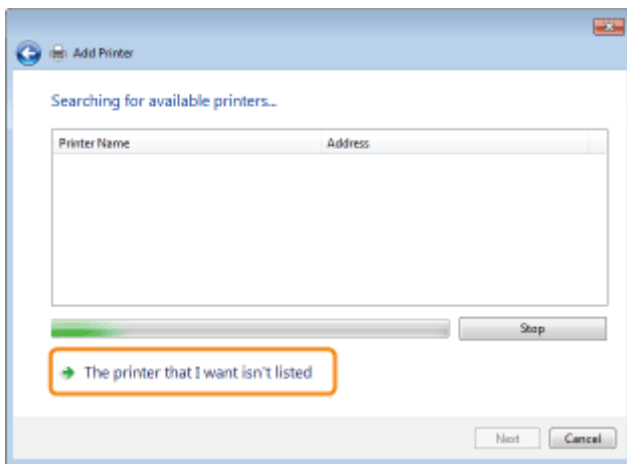

## 6

Perform the following procedure.

- (1) Select [Select a shared printer by name].
- (2) Click [Next].

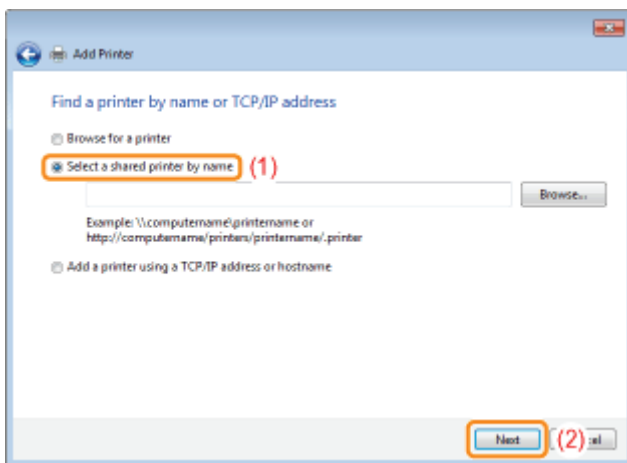

## 7

Select a shared printer.

- (1) Select a shared printer on the print server.
- (2) Click [Select].

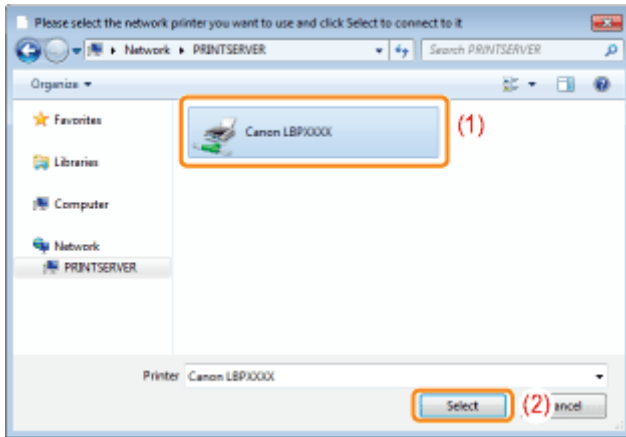

#### NOTE

##### **Specifying the network path directly**

Specify the network path as "\\the print server name (the computer name of the print server)\the printer name."

## 8

**Click [Install driver].**

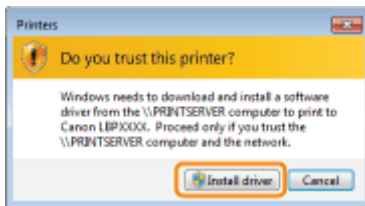

#### **If the [User Account Control] dialog box appears**

Click [Yes] or [Continue].

## 9

**Click [Next].**

† When [Set as the default printer] is displayed, select whether or not to use the printer as the default printer. (Windows Vista and Server 2008)

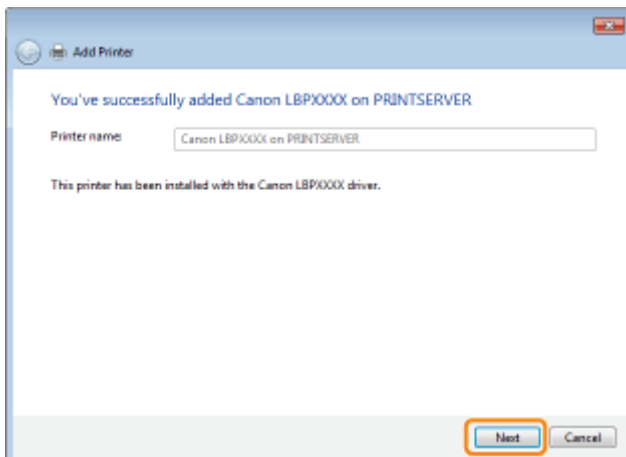

# 10

Click **[Finish]**.

If you want to print a test page, click **[Print a test page]**.

† When **[Set as the default printer]** is displayed, select whether or not to use the printer as the default printer. (Windows 7 and Server 2008 R2)

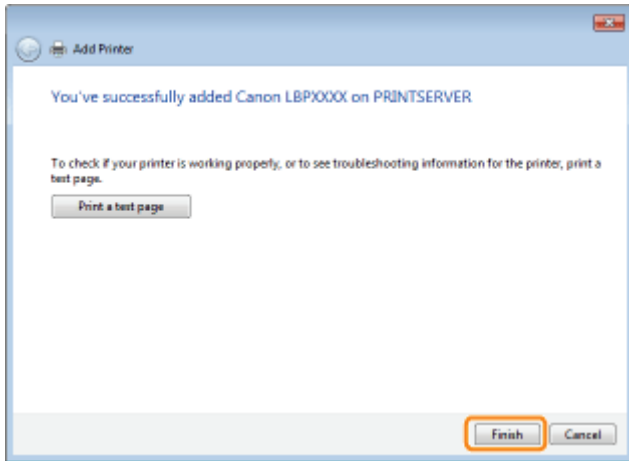

## Windows XP and Server 2003

### 1

**Turn the computer on, and then log on to Windows.**

### 2

**Open the printer folder.**

❖ "Basic Operations/Various Information for Windows"

### 3

**Display **[Add Printer Wizard]**.**

#### Windows XP

Click **[Add a printer]**.

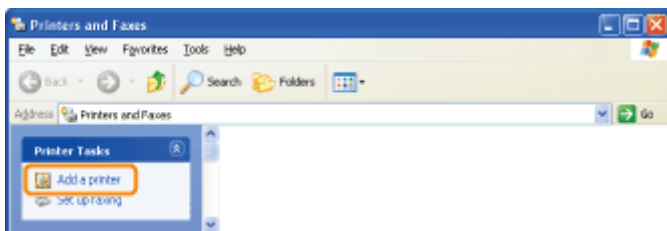

#### Windows Server 2003

Double-click **[Add Printer]**.

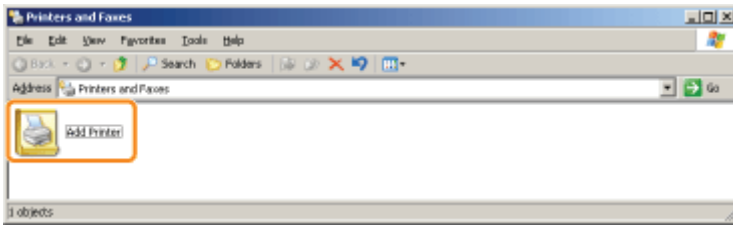

## 4

Click [Next].

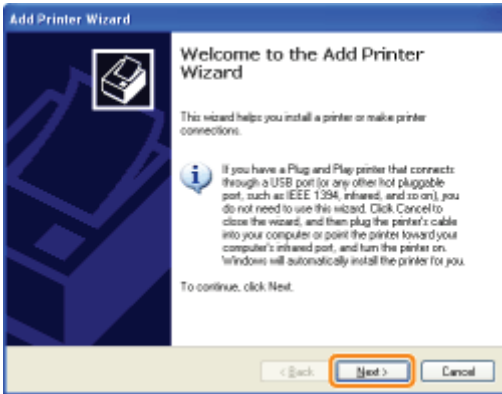

## 5

Select a printer type.

- (1) Select [A network printer, or a printer attached to another computer].
- (2) Click [Next].

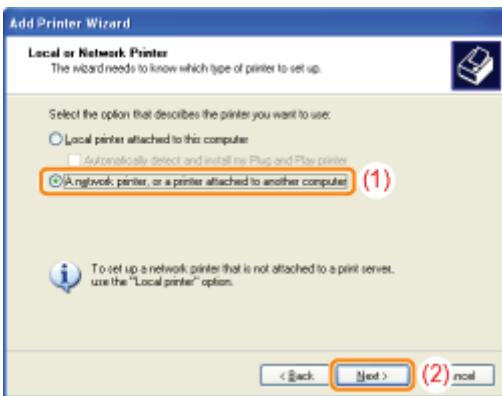

## 6

Perform the following procedure.

- (1) Select [Connect to this printer].
- (2) Click [Next].

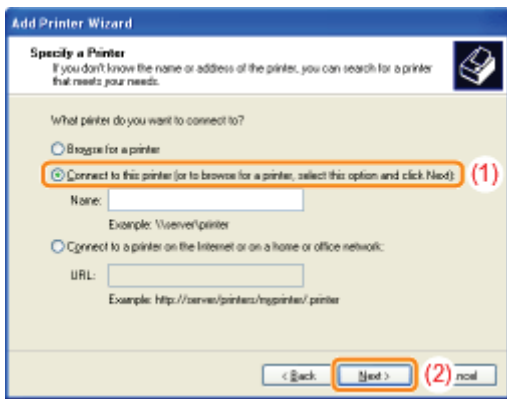

## 7

### Select a shared printer.

- (1) Select a shared printer on the print server.
- (2) Click [Next].

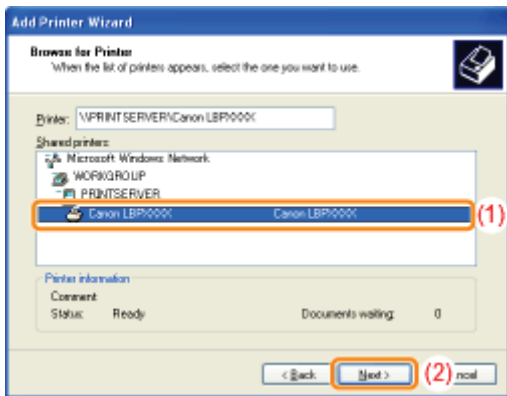

#### **?** If the [Connect to Printer] dialog box appears

Follow the directions in the message.

#### **NOTE**

#### **Specifying the network path directly**

Specify the network path as "\\the print server name (the computer name of the print server)\the printer name."

## 8

### When the following screen appears, select whether or not to use this printer as the default printer.

- (1) If you want to use the printer as the default printer, select [Yes].
- (2) Click [Next].

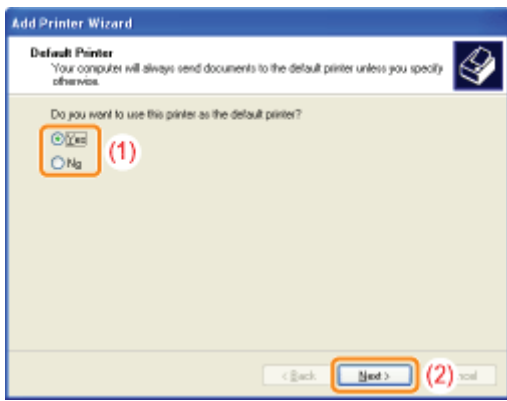

## 9

Click **[Finish]**.

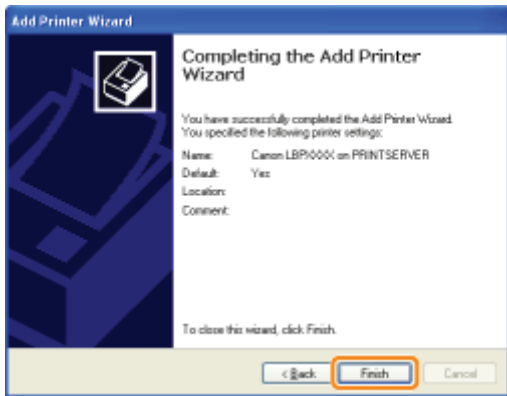

## Installing from [Windows Explorer]

### 1

**Turn the computer on, and then log on to Windows.**

### 2

**Display [Windows Explorer].**

From the [Start] menu, select [All Programs] → [Accessories] → [Windows Explorer].

### 3

**Perform the following procedure.**

- (1) Select the print server from [My Network Places] or [Network].
- (2) Double-click the shared printer icon or drag and drop the icon into the printer folder.

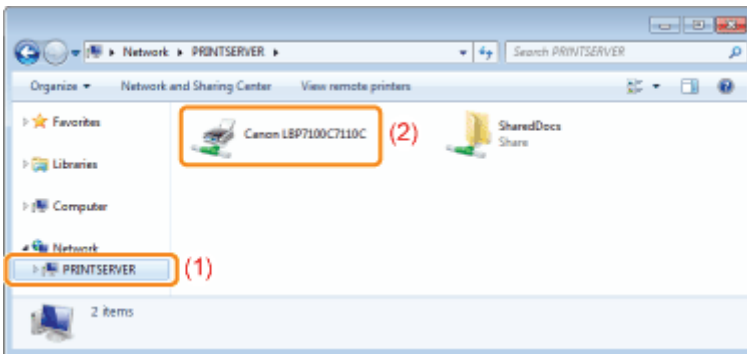

### 4

**Follow the on-screen instructions to install the printer driver.**



# Managing the Printer

---

## ➤ Software That Can Be Used for Managing the Printer

---

- Remote UI
- MF/LBP Network Setup Tool

## ➤ Managing Print Jobs

---

## ➤ Checking the Printer Settings

---

- Printing the "User Data List"

## ➤ Specifying the System Manager Information

---

## ➤ Specifying the Device Name and Installation Location

---

## ➤ Specifying the Time Zone and Daylight Saving Time Settings of the Printer

---

## ➤ Initializing the System Settings

---

- Initializing Using the Remote UI
  - Initializing Using the Reset Button
-

## Software That Can Be Used for Managing the Printer

You can manage the printer using the following software.

Because the items you can manage differ depending on the software, use each software according to your environment or the item you want to manage.

○: Can be managed

—: Cannot be managed

△: Can be managed partly

Management Item	Printer Status Window	Remote UI	MF/LBP Network Setup Tool
Managing Print Jobs	△	○	—
Checking the Printer Settings	○	△	—
Specifying the System Manager Information	—	○	—
Specifying the Device Name and Installation Location	—	○	—
Specifying the Time Zone and Daylight Saving Time Settings of the Printer	—	○	—
Changing the Network Settings for the Printer	—	○	△
Security Settings	—	○	—

# Remote UI

The Remote UI allows you to manage the printer using a Web browser.

## <Features of the Remote UI>

- **No specific software is needed.**

You can operate the Remote UI in a Web browser. You do not need specific software to operate the Remote UI.

- **You can manage the printer from a remote location.**

By accessing and operating the printer from the Web browser via a network, you can manage the printer using a computer in a remote location.

You can perform various operations, such as checking the current printer status or job logs and specifying various network settings in the Remote UI.

- **Central management of all the printer settings with the manager password (PIN)**

Only the manager can configure the settings or perform the operations related to the printer management by setting the manager password (PIN).

## ➤ [Starting the Remote UI](#)

## ➤ [Screen Layout of the Remote UI](#)

## ➤ [Displaying or Changing the Support Link](#)

## ➤ [Changing the Display Language of the Remote UI](#)

## System Requirements of the Remote UI

Web Browser	Internet Explorer 7.0 or later
Operating System	<ul style="list-style-type: none"><li>• Windows XP</li><li>• Windows Vista</li><li>• Windows 7</li></ul>
Display	Resolution: 1024 x 768 pixels or more

# Starting the Remote UI

There are the following two ways to start the Remote UI.

- ❖ Starting the Remote UI from the Printer Status Window
- ❖ Starting the Remote UI Directly from a Web Browser

Before starting the Remote UI, see "Attention (Remote UI)."

## Starting the Remote UI from the Printer Status Window

### 1

Click [  ] in the Windows task tray, and then select the printer name.



### 2

Click [  ] (Remote UI).

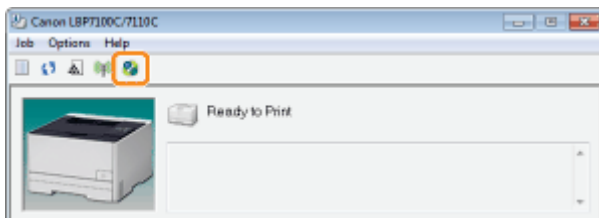

### If you cannot click [ ] (Remote UI)

Check the following points.

- The printer and computer are connected properly via a network.
- The printer is turned ON.

### 3

Log in to the Remote UI.

- (1) Select the login mode.
- (2) Click [Log In].

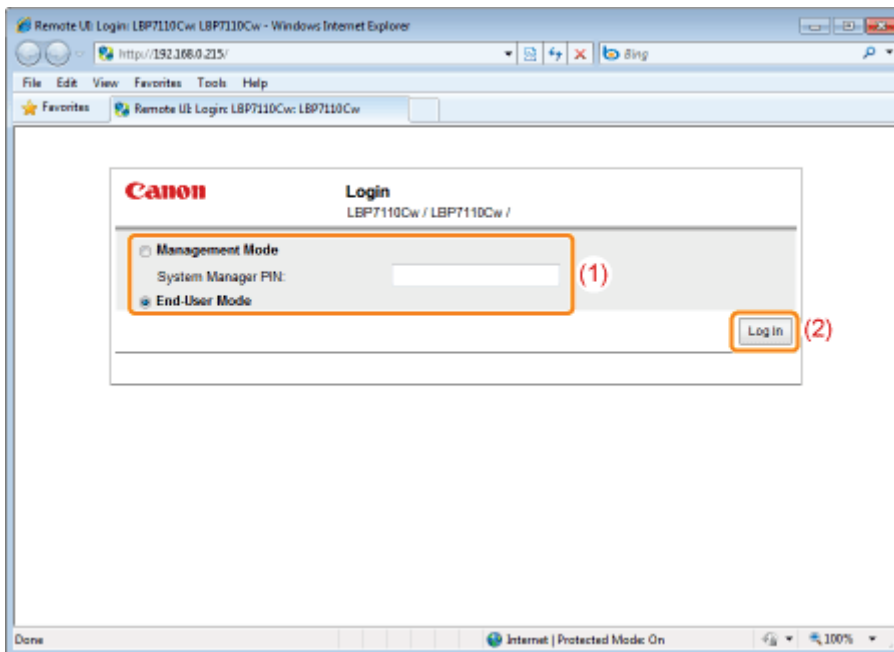

[Management Mode]	Select this mode when logging in as manager. † You can perform all operations and specify all settings of the Remote UI.
[System Manager PIN]	When selecting [Management Mode], enter the PIN. † If the PIN is not specified, you do not need to enter it. † <a href="#">"Specifying the System Manager Information"</a>
[End-User Mode]	Select this mode when logging in as a general user. † You can check the printer status, manage print jobs, and so on.

## Starting the Remote UI Directly from a Web Browser

### 1

**Start the Web browser.**

### 2

**Enter "http://<the IP address of the printer>" in the address field, and then press the [ENTER] key on your keyboard.**

- **Input Example:** "http://192.168.0.215/"

† If you are not sure about the IP address of the printer, see ["Checking the IP Address of the Printer."](#)

† If the host name of the printer is registered in the DNS server, you can enter ["host name"."domain name"] instead of the IP address.

- **Input Example:** "http://my\_printer.xy\_dept.company.com/"

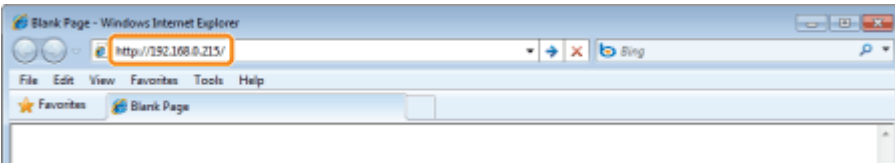

### ? If the Remote UI does not start

Check the following points.

- The printer and computer are connected properly via a network.
- The printer is turned ON.
- The IP address or ["host name"."domain name"] is entered correctly.

## 3

### Log in to the Remote UI.

- (1) Select the login mode.
- (2) Click [Log In].

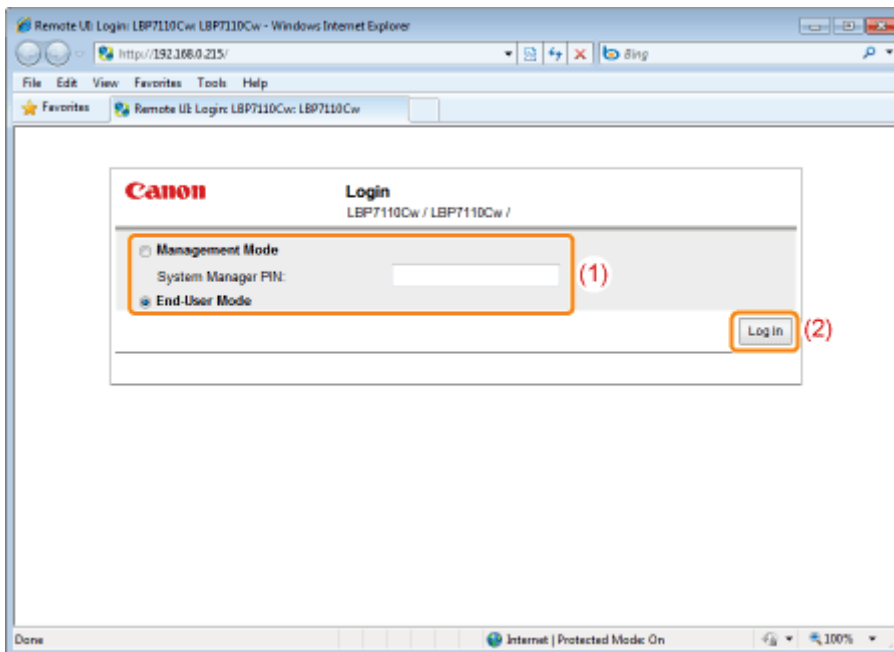

[Management Mode]	Select this mode when logging in as manager. † You can perform all operations and specify all settings of the Remote UI.
[System Manager PIN]	When selecting [Management Mode], enter the PIN. † If the PIN is not specified, you do not need to enter it. † <a href="#">"Specifying the System Manager Information"</a>
[End-User Mode]	Select this mode when logging in as a general user. † You can check the printer status, manage print jobs, and so on.

## Attention (Remote UI)

### NOTE

#### **When using SSL encrypted communication**

To use SSL encrypted communication, a key and certificate must be created, and the key must be registered as the default key.

For details on the SSL encryption communication function and the procedure for registering a key, see "[Setting the SSL Encrypted Communication Function](#)" and "[Specifying Keys and Certificates/CA Certificates](#)."

#### **When SSL is enabled and the display of certificate error (security warning) or a message appears**

Follow the directions in the message.

#### **When SSL is enabled and the Remote UI does not start**

The key management file may be damaged, so perform the following procedure.

1. Initialize the system settings using the reset button on the printer.
  - ❖ "[Initializing Using the Reset Button](#)"
2. Specify the network connection settings.
  - ❖ "[Specifying the Connection Settings](#)"
3. Create the key and certificate again, and specify the SSL settings using the Remote UI.
  - ❖ "[Specifying Keys and Certificates/CA Certificates](#)"
  - ❖ "[Setting the SSL Encrypted Communication Function](#)"

#### **When using a proxy server**

On the settings for the proxy server of the Web browser, add the IP address of the printer to [Exceptions] (the addresses that do not use the proxy server).

The settings vary depending on the network environment. Consult your network administrator.

#### **About cookies**

Configure your Web browser to enable cookies.

#### **Starting the Remote UI**

If the Remote UI is running on multiple computers at a time, the latest settings are valid.

If you want to log in as Management Mode, we recommend that only one Remote UI should be running at a time.

#### **If no operations are performed after login**

If no operations are performed for 5 minutes, you must log in again before using the Remote UI.

# Screen Layout of the Remote UI

## Portal page

The following screen displayed when you log in to the Remote UI is called the "portal page."

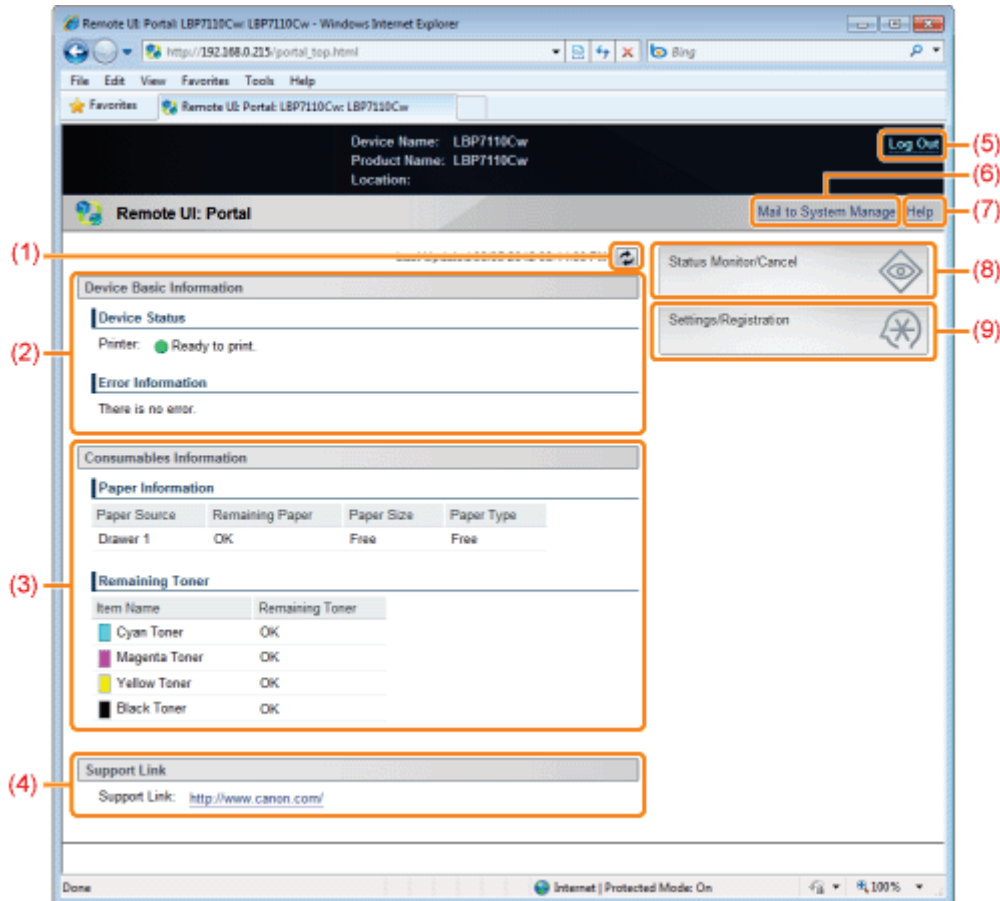

- (1) Updates the information in the currently displayed page to the latest one.
- (2) Displays the current status of the printer and error information.  
Displays the link to the error information when an error occurs.
- (3) Displays information related to the paper and the remaining toner.
- (4) Displays the support link specified with [Device Information].
  - ❖ "[Displaying or Changing the Support Link](#)"
- (5) Logs out and displays the top page (login screen) of the Remote UI.
- (6) Creates an e-mail to the system manager specified with [System Manager Information].
- (7) Displays Help for the currently displayed page in a new window.
- (8) Displays the status, history, and so on for printer jobs.
  - ❖ "[\[Status Monitor/Cancel\] page](#)"
- (9) Displays/changes the information about the settings of the printer.
  - ❖ "[\[Settings/Registration\] page](#)"

## [Status Monitor/Cancel] page



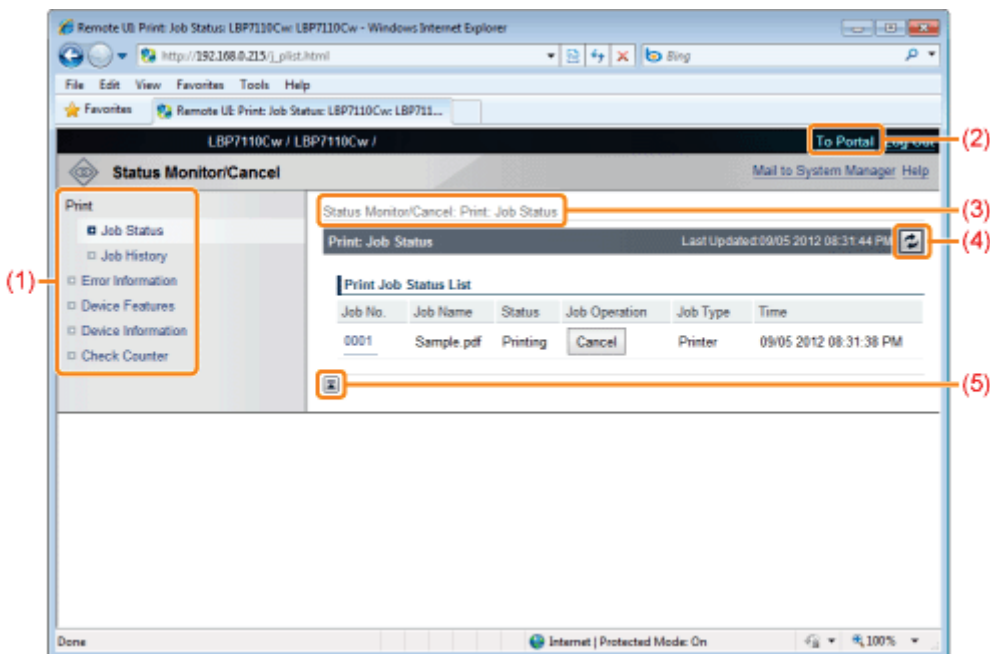

(1) Display the following pages.

[Job Status] page	You can display and cancel jobs that are currently being printed and waiting to be printed. <a href="#">❖ "Managing Print Jobs"</a>
[Job History] page	Displays the job history. <a href="#">❖ "Managing Print Jobs"</a>
[Error Information] page	Displays the error information of the printer. † You can also click messages displayed in [Error Information] on the portal page to display this page when an error occurs.
[Device Features] page	Displays information such as the maximum print speed of the printer (A4 or Letter).
[Device Information] page	Displays information related to the printer, such as the printer name, installation location, and system manager.
[Check Counter] page	Displays the total number of printed pages to date.

(2) Displays the portal page of the Remote UI.

(3) Displays the hierarchy of the page currently being displayed.

(4) Updates the information in the currently displayed page to the latest one.

(5) If the page is scrolled down, moves the scroll box up to the top of the page.

## [Settings/Registration] page

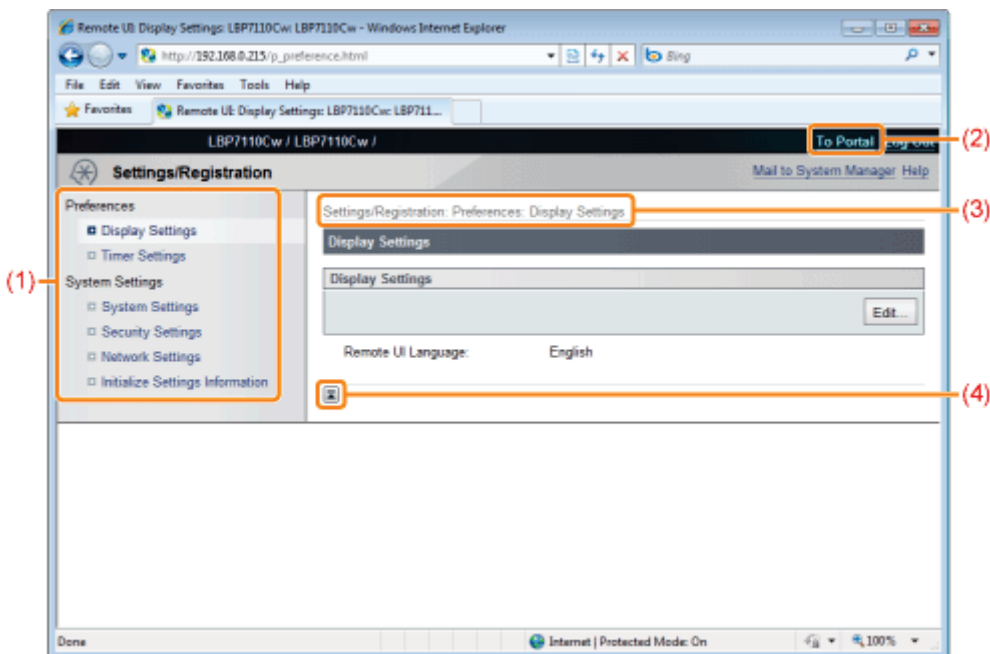

(1) Display the following pages.

[Display Settings] page	Displays/changes the information about the language display settings of the Remote UI. <ul style="list-style-type: none"> <li>❖ <a href="#">"Changing the Display Language of the Remote UI"</a></li> </ul>
[Timer Settings] page	Displays/changes the information about the time zone and daylight saving time settings of the printer. <ul style="list-style-type: none"> <li>❖ <a href="#">"Specifying the Time Zone and Daylight Saving Time Settings of the Printer"</a></li> </ul>
[System Settings] page	Displays/changes the information about the general printer settings, such as information about the system manager. <ul style="list-style-type: none"> <li>❖ <a href="#">"Specifying the System Manager Information"</a></li> <li>❖ <a href="#">"Specifying the Device Name and Installation Location"</a></li> <li>❖ <a href="#">"Displaying or Changing the Support Link"</a></li> </ul>
[Security Settings] page	Displays/changes the information about the security settings, such as the access restrictions and key and certificate settings. <ul style="list-style-type: none"> <li>❖ <a href="#">"Restricting the Users Who Can Print and Specify Settings"</a></li> <li>❖ <a href="#">"Specifying Keys and Certificates/CA Certificates"</a></li> </ul>
[Network Settings] page	Displays/changes the information about the network settings, such as the protocol settings. <ul style="list-style-type: none"> <li>❖ <a href="#">"Changing the Network Settings for the Printer"</a></li> <li>❖ <a href="#">"Checking the Wireless LAN Information (LBP7110Cw Only)"</a></li> <li>❖ <a href="#">"Monitoring/Controlling Devices by SNMP (SNMP Settings)"</a></li> <li>❖ <a href="#">"Setting the SSL Encrypted Communication Function"</a></li> <li>❖ <a href="#">"Setting IEEE 802.1X Authentication"</a></li> </ul>
[Initialize Settings Information] page	You can initialize (reset to the default values) the system settings and the key and certificate. <ul style="list-style-type: none"> <li>❖ <a href="#">"Initializing the System Settings"</a></li> <li>❖ <a href="#">"Initializing Keys and Certificates/CA Certificates"</a></li> </ul>

(2) Displays the portal page of the Remote UI.

(3) Displays the hierarchy of the page currently being displayed. Click to display the page.

(4) If the page is scrolled down, moves the scroll box up to the top of the page.

**NOTE**

**Changing the system settings**

- When you log in using [End-User Mode], only the [System Settings] page is displayed.
- You can only change the settings if you log in using [Management Mode].

## Displaying or Changing the Support Link

With the Remote UI, you can specify the link to the site that provides information about the printer support, and you can access the site from the Remote UI as needed.

If you logged in as Management Mode, you can change the link settings.

### Displaying the Support Link

#### 1

Start the Remote UI, and then log in.

➤ "Starting the Remote UI"

#### 2

Click a specified link from [Support Link] in the portal page.

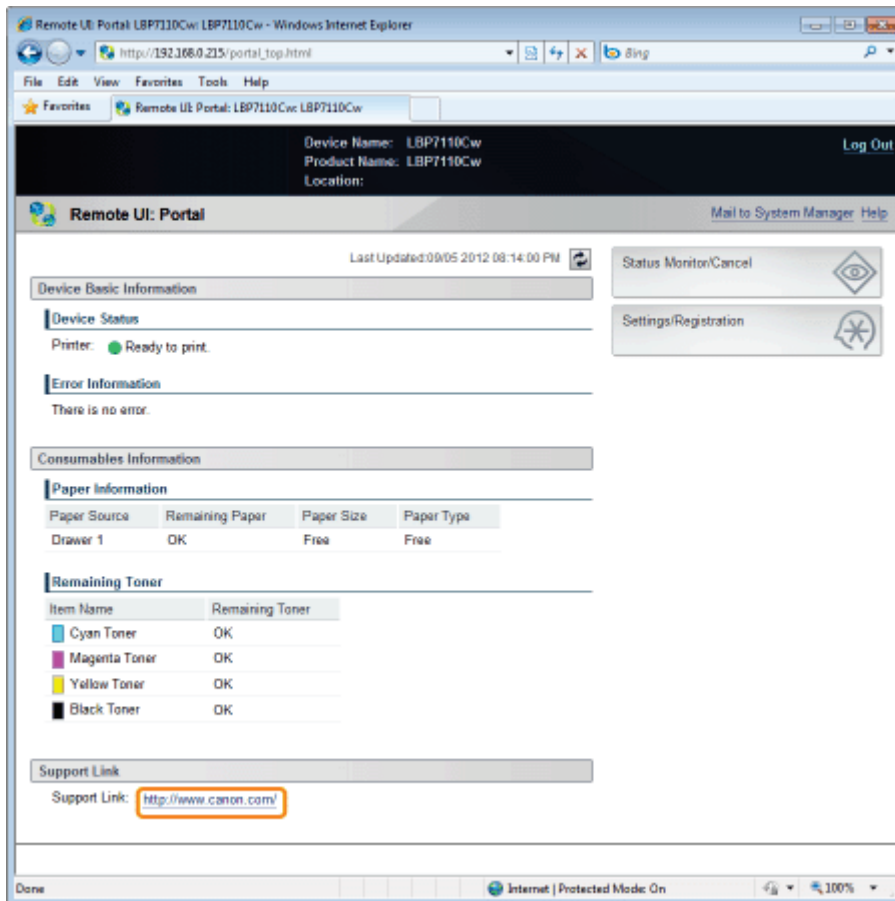

### Changing the Support Link

#### 1

Start the Remote UI, and then log in as Management Mode.

➤ "Starting the Remote UI"

## 2

Click [Settings/Registration].

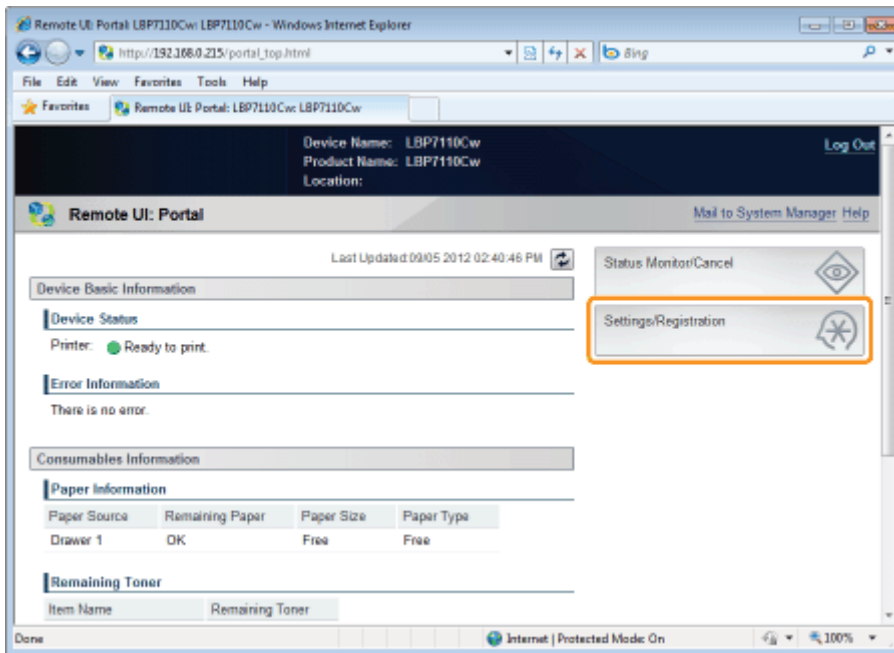

## 3

Display the [Edit System Settings] page.

- (1) Select [System Settings].
- (2) Click [Edit].

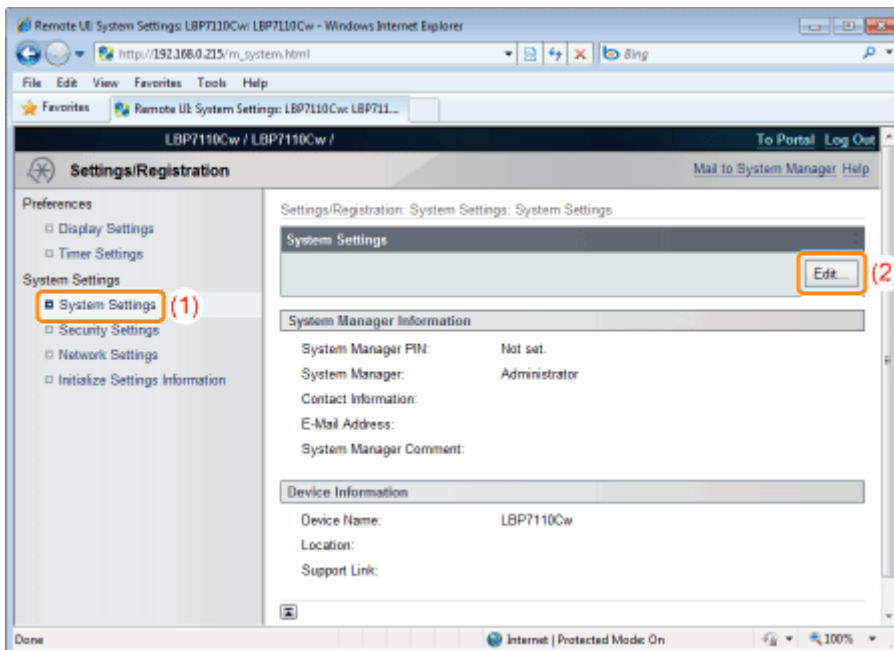

## 4

Change the link.

- (1) Enter the URL of the link in [Support Link] in [Device Information].

(2) Click [OK].

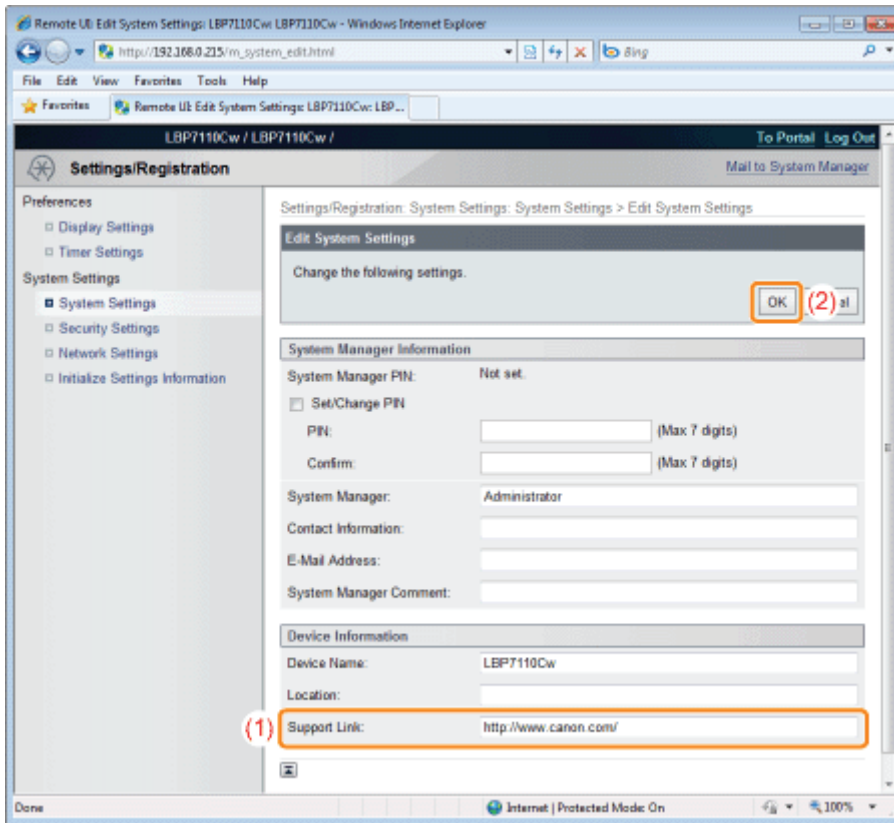

# Changing the Display Language of the Remote UI

If you logged in as Management Mode, you can change the displayed language of the Remote UI.

## 1

**Start the Remote UI, and then log in as Management Mode.**

➤ "Starting the Remote UI"

## 2

**Click [Settings/Registration].**

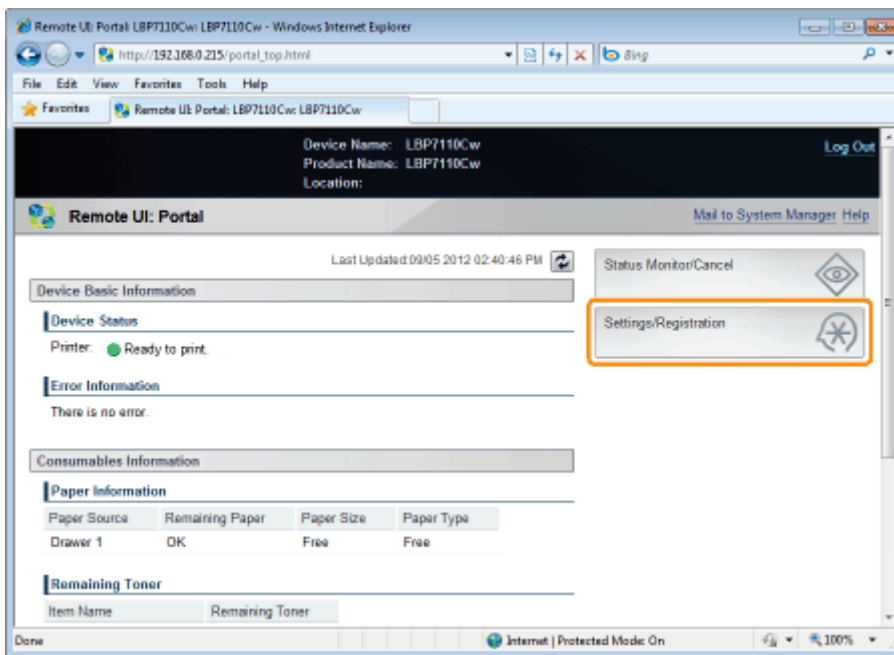

## 3

**Display the [Edit Display Settings] page.**

- (1) Select [Display Settings].
- (2) Click [Edit].

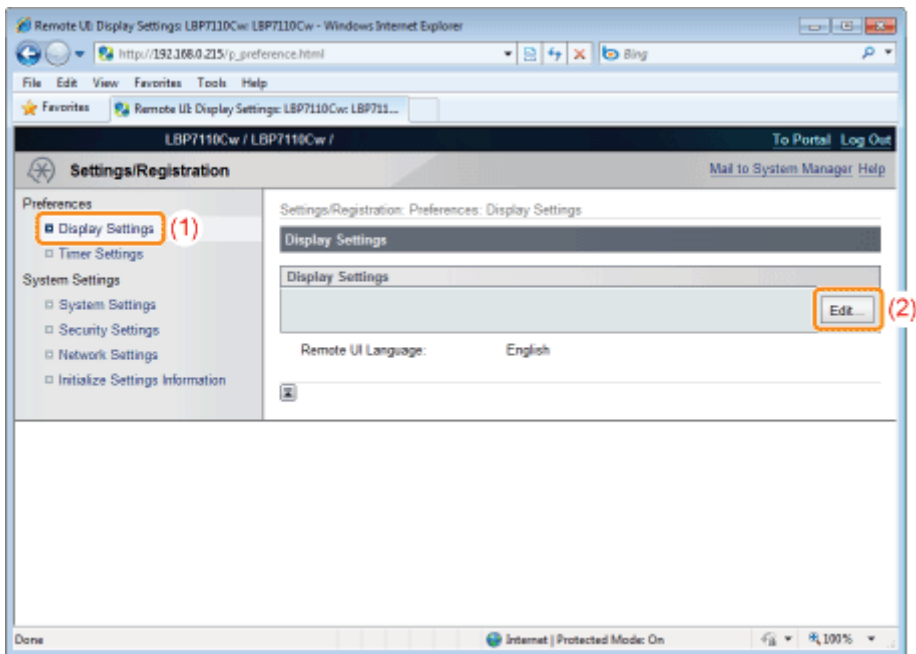

## 4

### Change the display language.

- (1) Select a display language.
- (2) Click [OK].

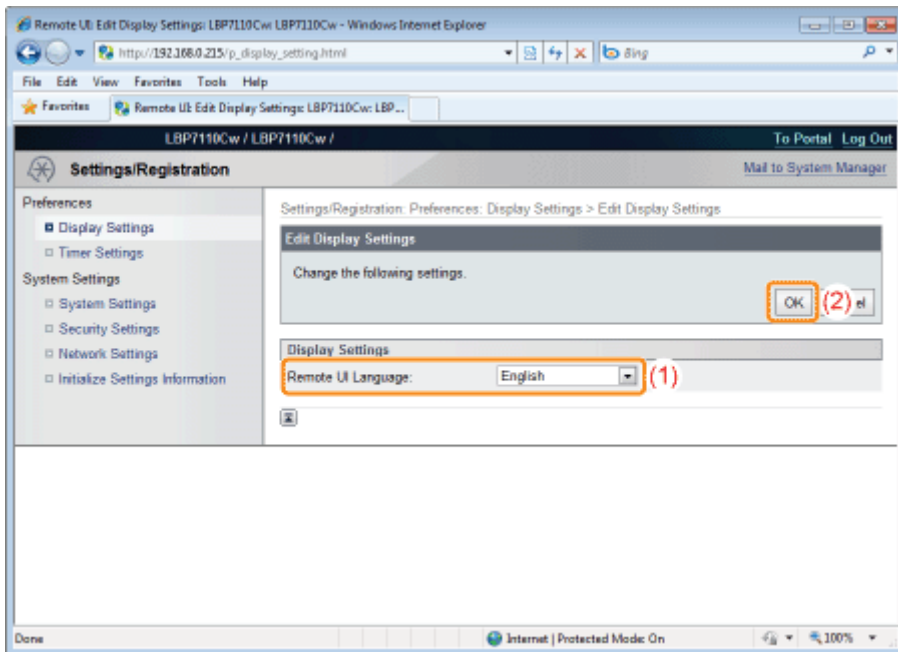

## MF/LBP Network Setup Tool

You can use "MF/LBP Network Setup Tool" to initialize the network settings.

### <Features of "MF/LBP Network Setup Tool">

- **Easily navigating the setting procedures**

You can easily navigate the setting procedures by using the graphical displays of the wizard.

- **No installation is required**

"MF/LBP Network Setup Tool" is software provided in the supplied CD-ROM. You can start "MF/LBP Network Setup Tool" directly from the CD-ROM without installing it.

### ➤ Directly Starting the MF/LBP Network Setup Tool

↑ When you install the printer driver using "Easy Installation," "MF/LBP Network Setup Tool" starts automatically.

➤ "Easy Installation"

## Specifying the Connection Settings Using "MF/LBP Network Setup Tool"

Before specifying the settings, see "[Connecting the Printer and Computer.](#)"

The setting procedure varies depending on your environment. Follow the instructions on the screen to specify the settings.

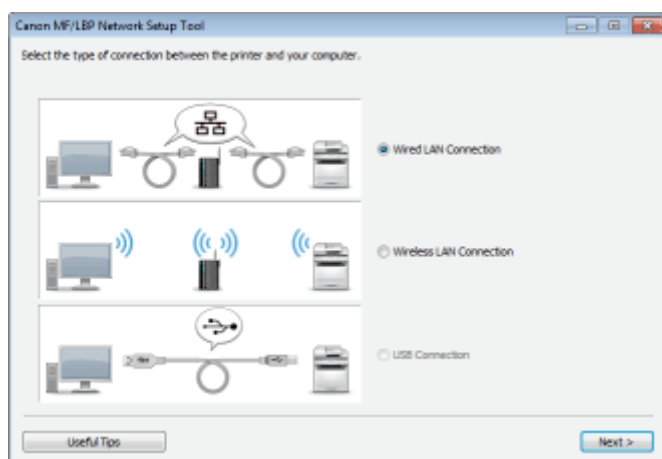

### ❓ If you have a problem during the connection settings

Click [Useful Tips] at the bottom left of the screen and see the help contents.



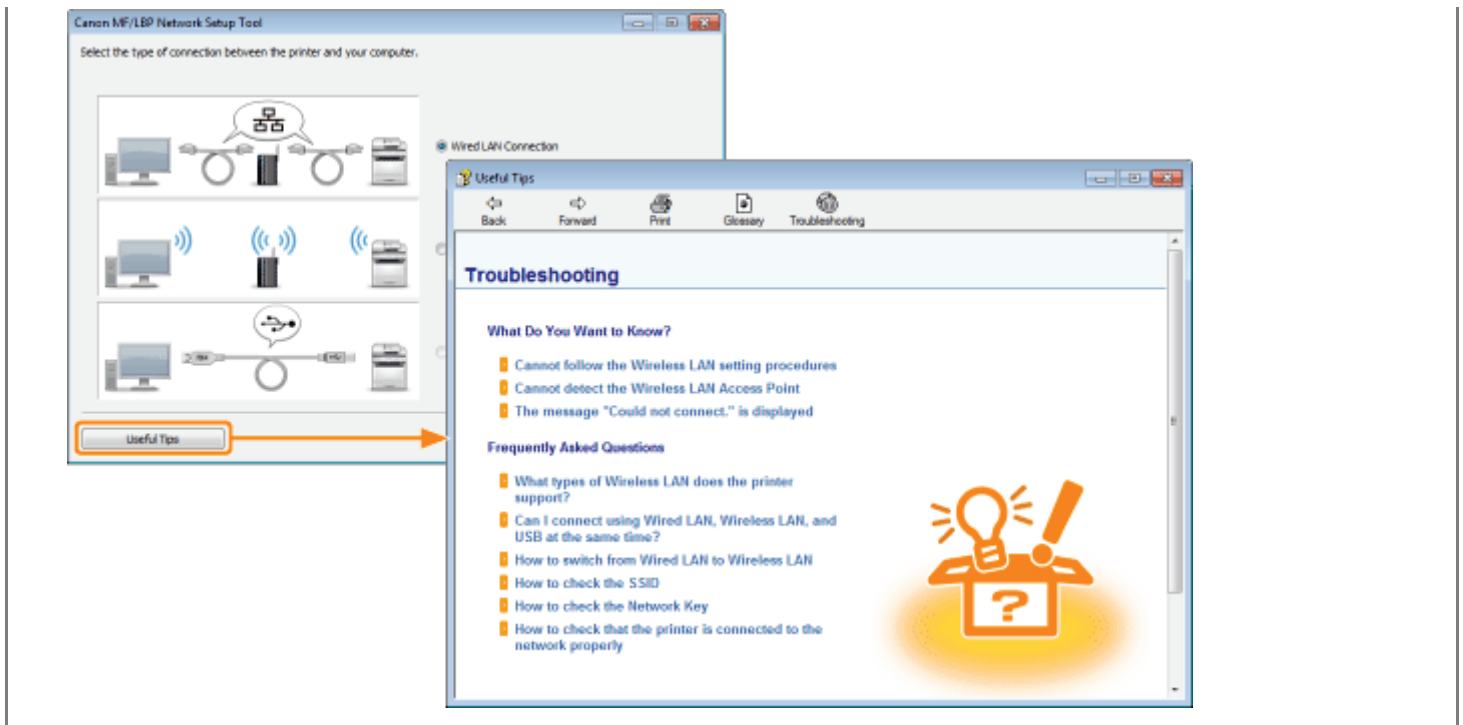

## System Requirements of "MF/LBP Network Setup Tool"

### Operating System

- Windows XP Professional or Home Edition
- Windows XP Professional x64 Edition
- Windows Vista (32-bit or 64-bit version)
- Windows 7 (32-bit or 64-bit version)
- Windows Server 2003
- Windows Server 2003 x64 Editions
- Windows Server 2008 (32-bit or 64-bit version)

† For details on the latest "MF/LBP Network Setup Tool," see the Canon Web site (<http://www.canon.com/>).

### Computer

A computer on which any one of the above operating systems can run

### Interface

#### When connecting with the USB cable

Hi-Speed USB/USB

#### When connecting with wired LAN

Connector: 10BASE-T/100BASE-TX

Protocol: TCP/IP

#### When connecting with wireless LAN (LBP7110Cw Only)

Standard: IEEE 802.11b/g/n

Protocol: TCP/IP

## Directly Starting the MF/LBP Network Setup Tool

1

Turn the computer on, and then log on to Windows as a user with administrative rights.

2

Insert the supplied CD-ROM "User Software" into the CD-ROM drive of your computer.

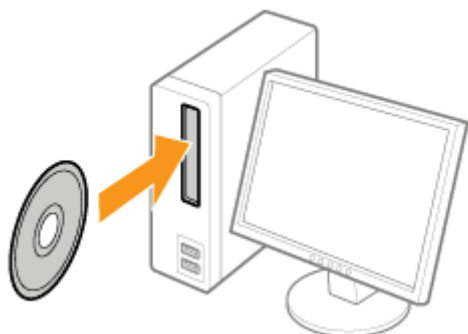

3

Click [Additional Software Programs].

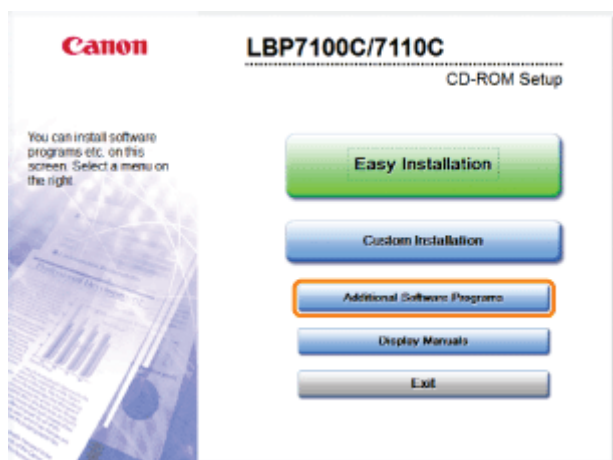

**? If the above screen does not appear**  
☛ "Basic Operations/Various Information for Windows"

**? If the [AutoPlay] dialog box appears**  
Click [Run AUTORUN.EXE].

**? If the [User Account Control] dialog box appears**  
Click [Yes] or [Continue].

4

Click [Start] in [MF/LBP Network Setup Tool].

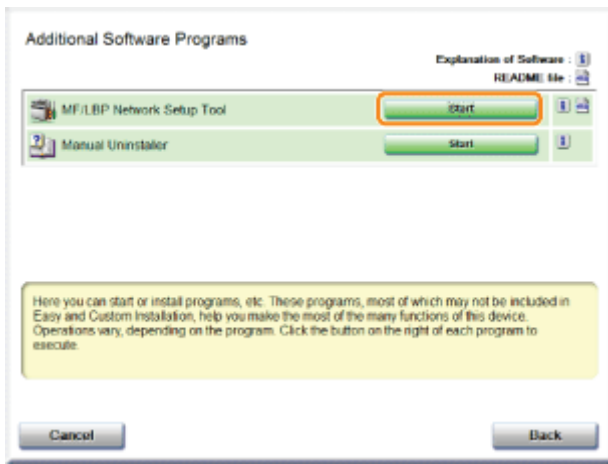

# Managing Print Jobs

Using the Remote UI, you can check/cancel the jobs currently being printed or waiting to be printed, or you can check print logs.

- † You can also cancel print jobs using a method other than the Remote UI.
  - "Canceling a Job"

## Checking/Canceling the Job Currently Being Printed or Waiting to Be Printed

### 1

**Start the Remote UI, and then log in.**

- "Starting the Remote UI"

### 2

**Click [Status Monitor/Cancel].**

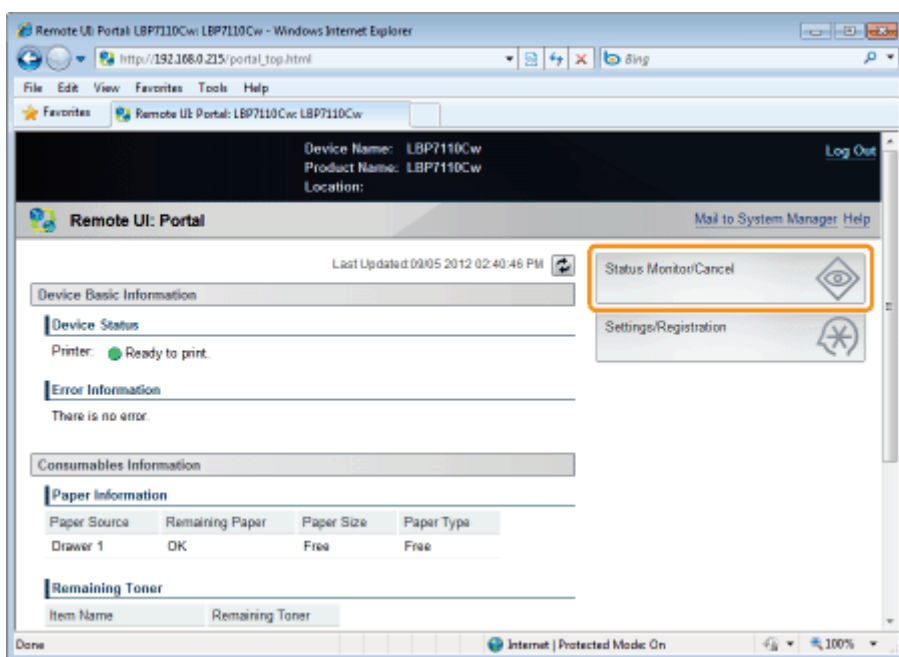

### 3

**Select [Job Status].**

Displays a list of jobs currently being printed and waiting to be printed.

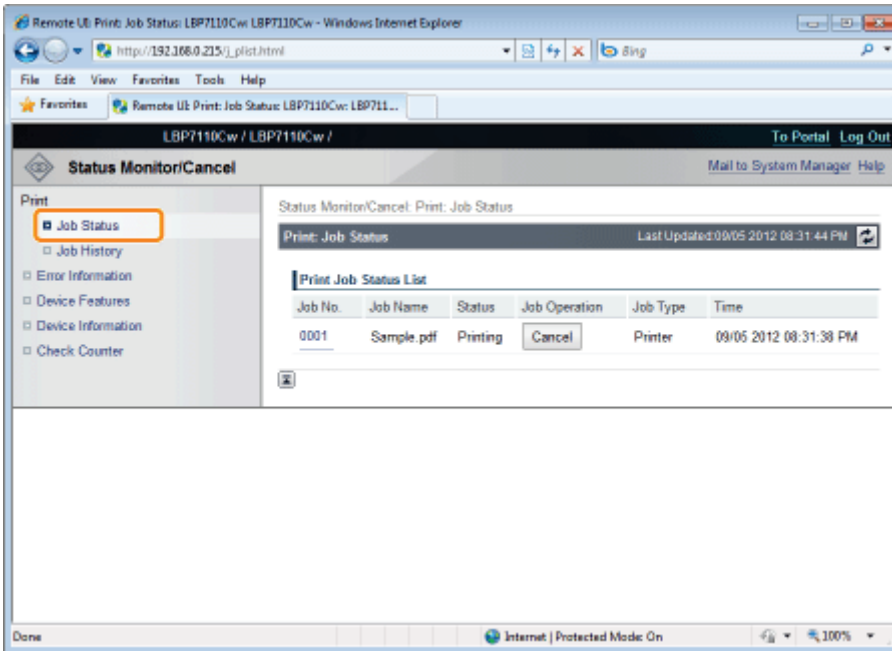

## 4

To cancel a job, click [Cancel] for the job you want to cancel.

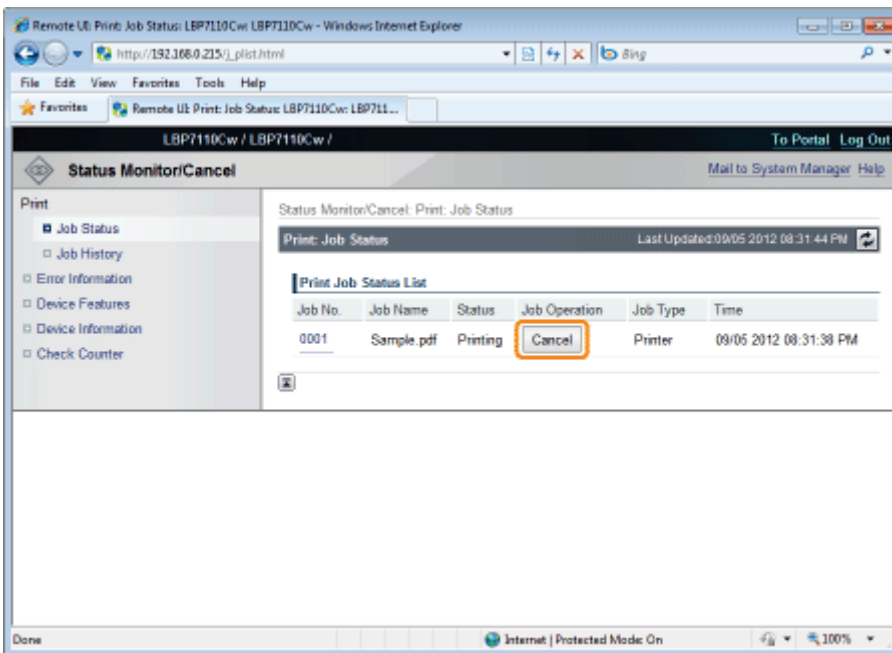

### If you cannot cancel a job

You cannot cancel the job whose pages are in the process of printing.

## Checking Print Logs

### 1

Start the Remote UI, and then log in.

 "Starting the Remote UI"

## 2

Click [Status Monitor/Cancel].

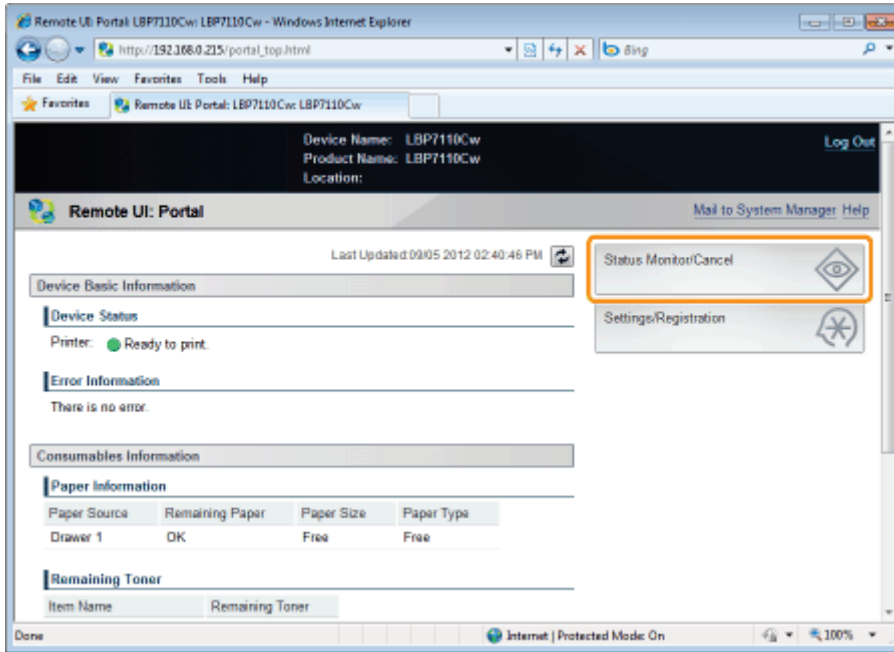

## 3

Select [Job History].

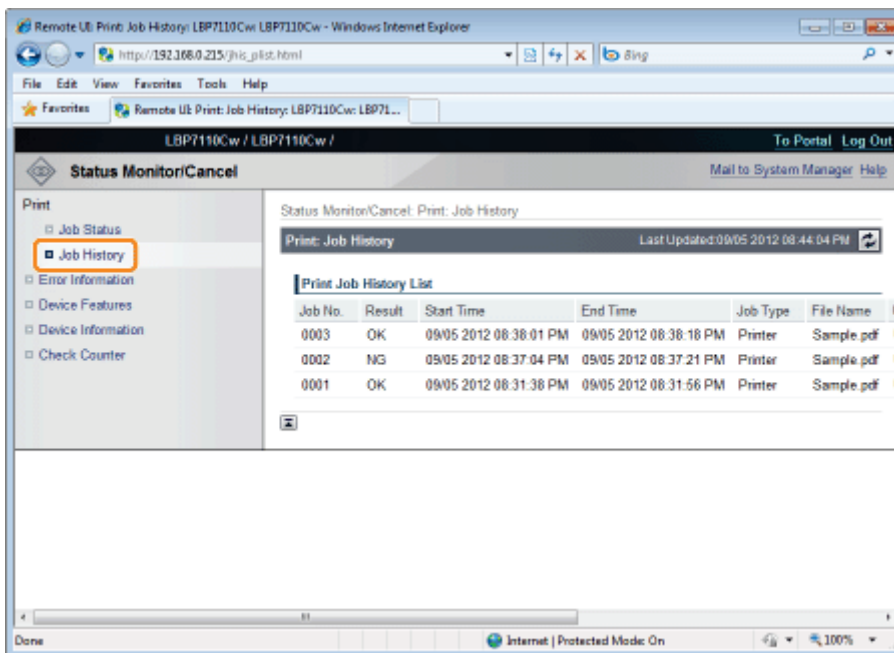

### NOTE

#### Print logs

- Up to 50 jobs can be displayed.
- When the number of jobs exceeds 50, the print logs are automatically deleted starting from the oldest one.

# Checking the Printer Settings

You can check the printer status, network settings, and so on by printing Status Print.

† Status Print is designed to be printed on A4 paper. Be sure to use A4 paper.

† You can also check the network settings and so on using the following procedure.

- Printing the "User Data List" using the Go key on the printer
  - "Printing the "User Data List""
- Starting the Remote UI (➤ "Starting the Remote UI"), logging in as Management Mode, and checking with the [Settings/Registration] - [Network Settings] page

## 1

**Load A4 paper in the paper drawer.**

➤ "Loading Paper"

## 2

**Click [  ] in the Windows task tray, and then select the printer name.**



## 3

**From the [Options] menu, select [Utility] → [Configuration Page Print] or [Network Status Print].**

### [Configuration Page Print]

Prints the settings of the printer unit and other current printer information.

### [Network Status Print]

Prints the TCP/IP settings including the IP address and information including security settings.

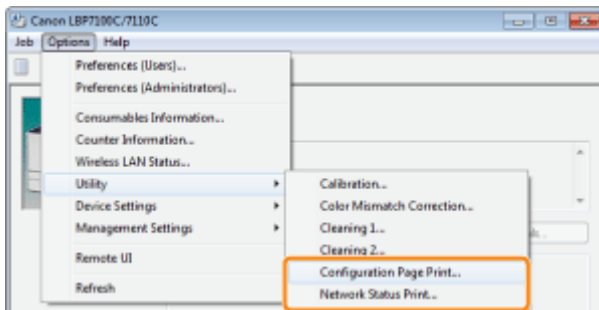

## 4

**Click [OK] to print Status Print.**

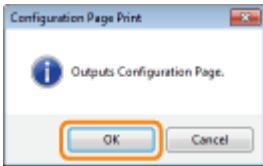

### **? If Status Print is not printed**

- ❖ "Printing Cannot Be Performed (USB Connection)"
- ❖ "Printing Cannot Be Performed (Wired LAN Connection)"
- ❖ "Printing Cannot Be Performed (Wireless LAN Connection) (LBP7110Cw Only)"
- ❖ "Printing Cannot Be Performed (via the Print Server)"





# Specifying the System Manager Information

Specify the manager password (PIN) and manager information of the printer.

## 1

**Start the Remote UI, and then log in as Management Mode.**

➤ "Starting the Remote UI"

## 2

**Click [Settings/Registration].**

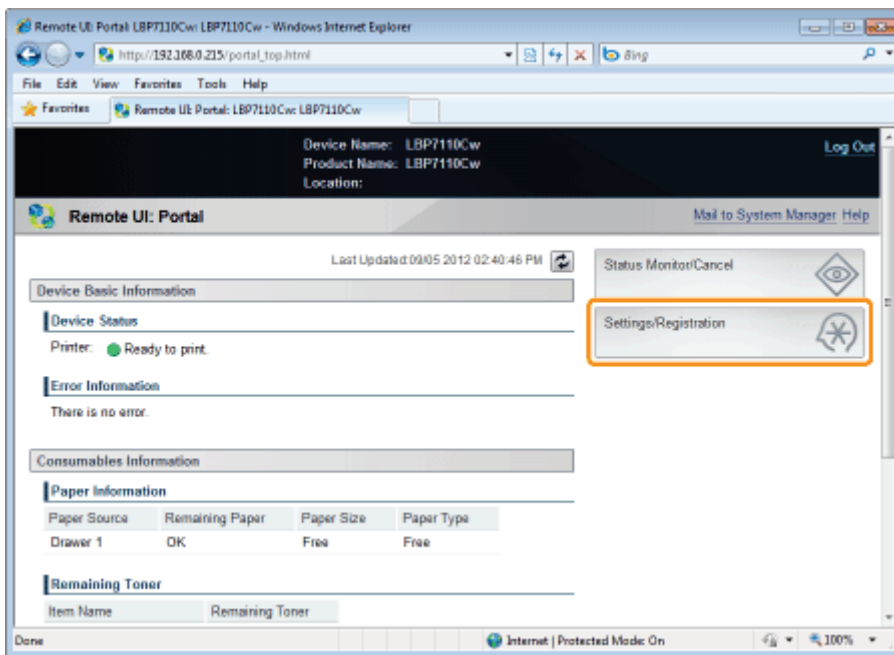

## 3

**Display the [Edit System Settings] page.**

- (1) Select [System Settings].
- (2) Click [Edit].

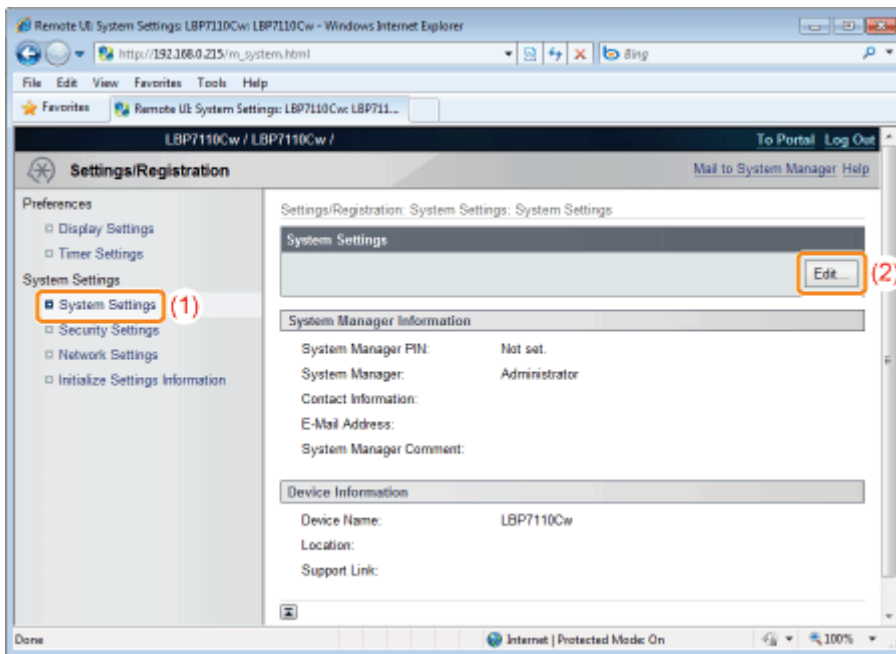

## 4

### Specify the system manager information.

- (1) Specify the manager password (PIN) and manager information of the printer.  
 (2) Click [OK].

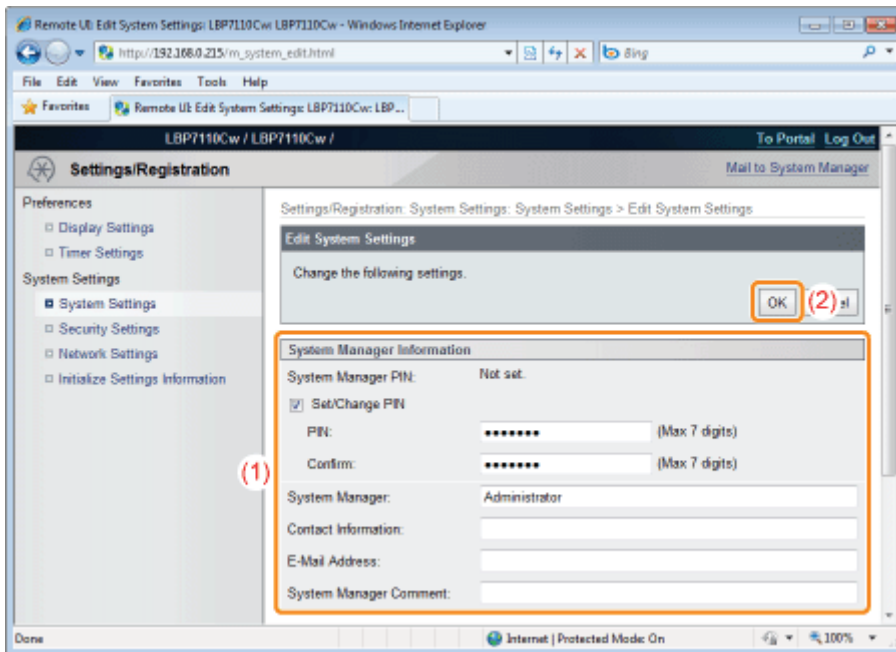

[Set/Change PIN]	To specify a PIN, select the check box.
[PIN]	Enter a new desired PIN.
[Confirm]	To confirm the PIN, enter the PIN again.
[System Manager]	Enter the name of the system manager.
[Contact Information]	Enter the contact information of the system manager.
[E-Mail Address]	Enter the e-mail address of the system manager.
[System Manager Comment]	Enter the comments of the system manager.

 **NOTE**

**Setting the PIN**

You can set up to a 7-digit number.

- If you enter less than 7 digits  
**<Example>:** You enter "321" → "0000321" is set.
- If you enter a number beginning with "0"  
**<Example>:** You enter "02" or "002" → "0000002" is set.
- You cannot register a PIN consisting of a series of zeros, such as "00."

# Specifying the Device Name and Installation Location

Specify the printer name, installation location, and so on.

## 1

**Start the Remote UI, and then log in as Management Mode.**

➤ "Starting the Remote UI"

## 2

**Click [Settings/Registration].**

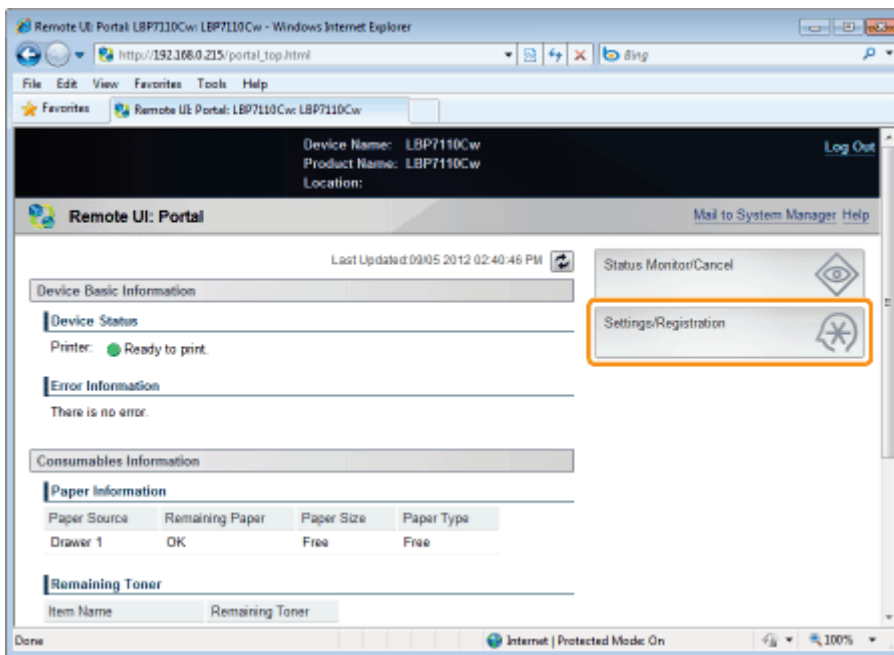

## 3

**Display the [Edit System Settings] page.**

- (1) Select [System Settings].
- (2) Click [Edit].

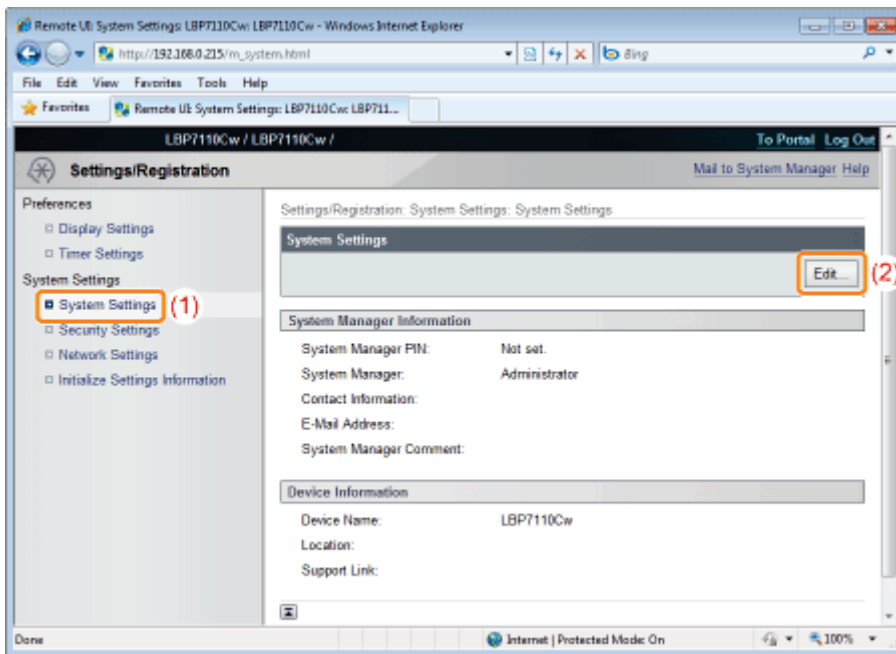

## 4

### Specify the device information.

- (1) Specify the printer name, installation location, and so on.
- (2) Click [OK].

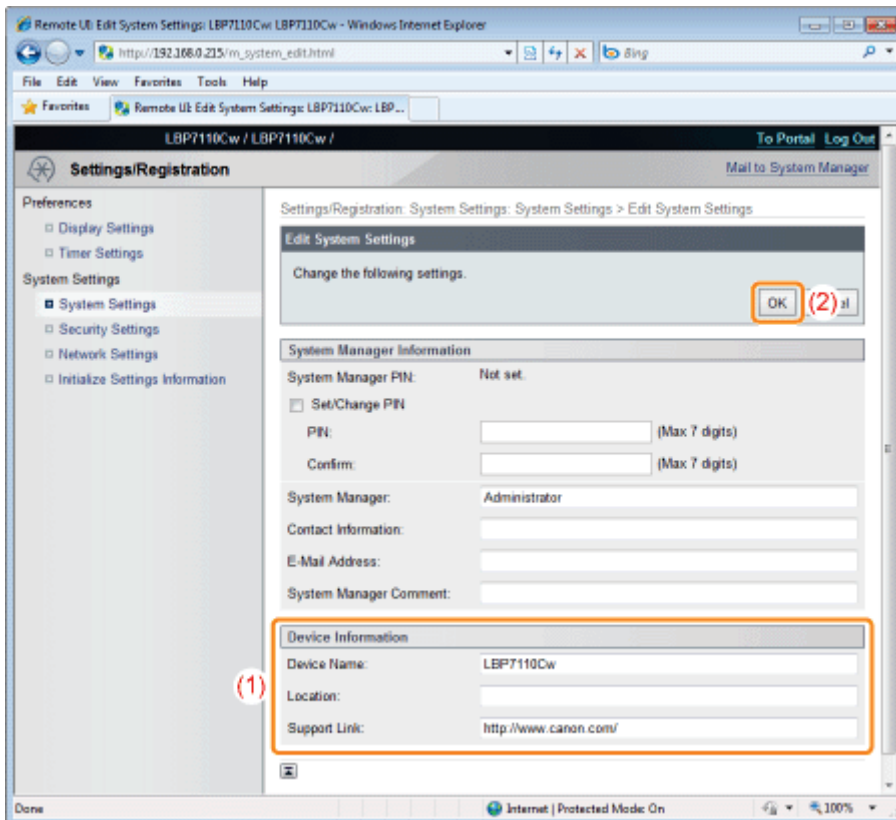

[Device Name]	Enter the printer name.
[Location]	Enter the installation location of the printer.
[Support Link]	Enter the URL of the link of the support link. † For details on the support link, see " <a href="#">Displaying or Changing the Support Link.</a> "

# Specifying the Time Zone and Daylight Saving Time Settings of the Printer

Specify the time zone of the region where the printer is being used and whether to use daylight saving time.

† The standard time for each region is shown as the time difference (up to  $\pm 12$  hours) from the Coordinated Universal Time (UTC). A time zone is a region throughout which the standard time is the same.

## 1

**Start the Remote UI, and then log in as Management Mode.**

❏ "Starting the Remote UI"

## 2

**Click [Settings/Registration].**

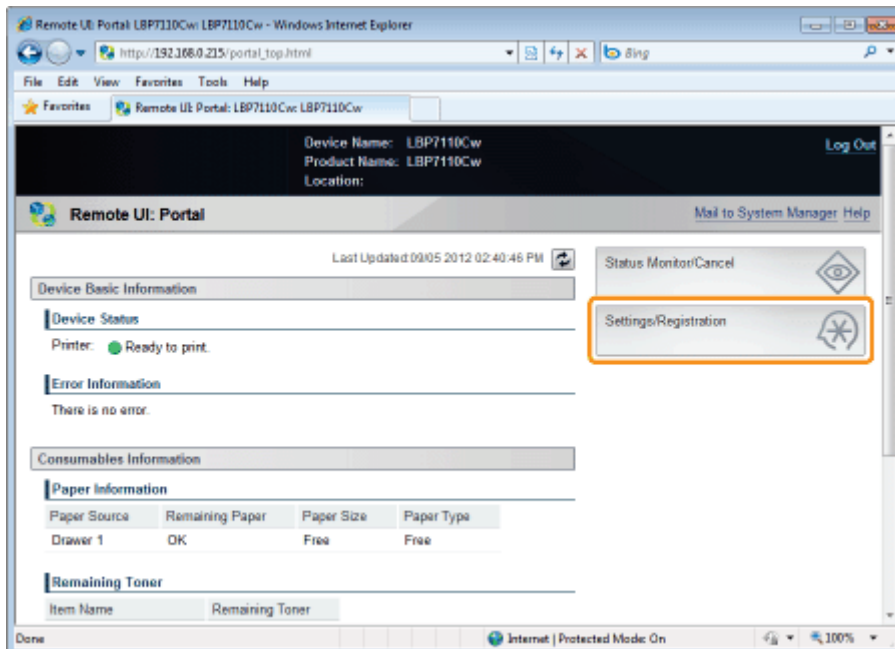

## 3

**Display the [Edit Timer Settings] page.**

- (1) Select [Timer Settings].
- (2) Click [Edit].

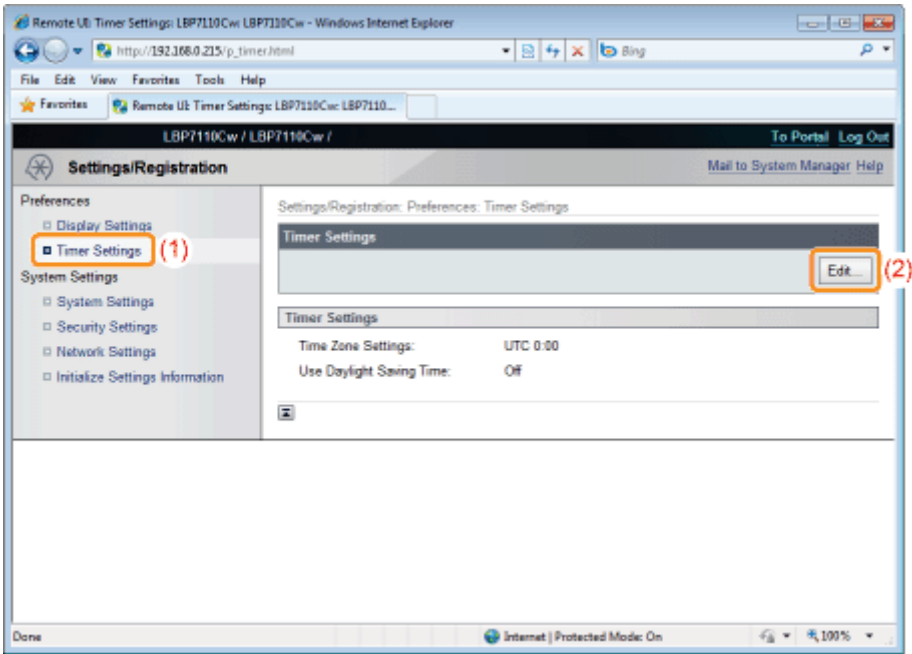

## 4

### Specify the time zone and daylight saving time settings.

- (1) Specify the time zone of the region where the printer is being used and whether to use daylight saving time.
- (2) Click [OK].

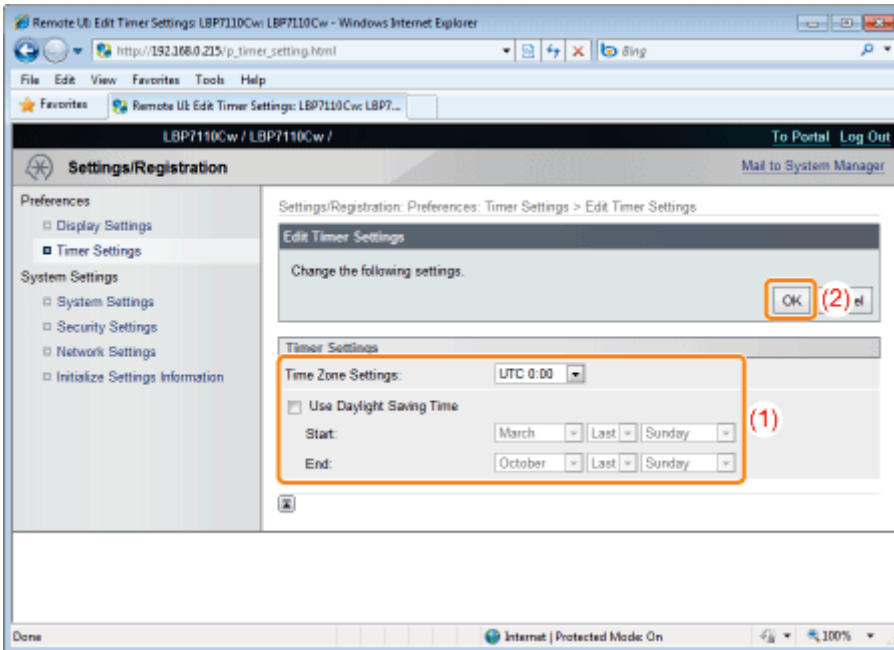

[Time Zone Settings]	Select the time zone of the region where the printer is being used. ↑ For the time zone, select the time difference from the Coordinated Universal Time (UTC).
[Use Daylight Saving Time]	To use daylight saving time, select the check box.
[Start]	Select the day daylight saving time starts.
[End]	Select the day daylight saving time ends.



## Initializing the System Settings

You can initialize (reset to the default values) the following setting information using the Remote UI or the reset button.

- System Manager Information<sup>\*1</sup>
- Device Information<sup>\*2</sup>
- Security Settings
- Network Settings

<sup>\*1</sup> When you use the reset button, [System Manager] is not initialized.

<sup>\*2</sup> When you use the reset button, [Device Name] and [Location] are not initialized.

### Initializing Using the Remote UI

You can initialize setting information individually and initialize the system settings all at once.

### Initializing Using the Reset Button

You can initialize the system settings all at once using the reset button on the printer.

#### IMPORTANT

##### **Precautions when initializing the system settings**

Make sure that the printer is not operating before initializing the system settings.

If you initialize the system settings while the printer is printing or receiving data, the received data may not be printed properly, or may result in paper jams or damage to the printer.

#### NOTE

##### **Initializing the key and certificate or CA certificate**

-  "Initializing Keys and Certificates/CA Certificates"

# Initializing Using the Remote UI

You can initialize (reset to the default values) the following setting information individually or all at once.

- System Manager Information
- Device Information
- Security Settings
- Network Settings

## 1

**Start the Remote UI, and then log in as Management Mode.**

➤ "Starting the Remote UI"

## 2

**Click [Settings/Registration].**

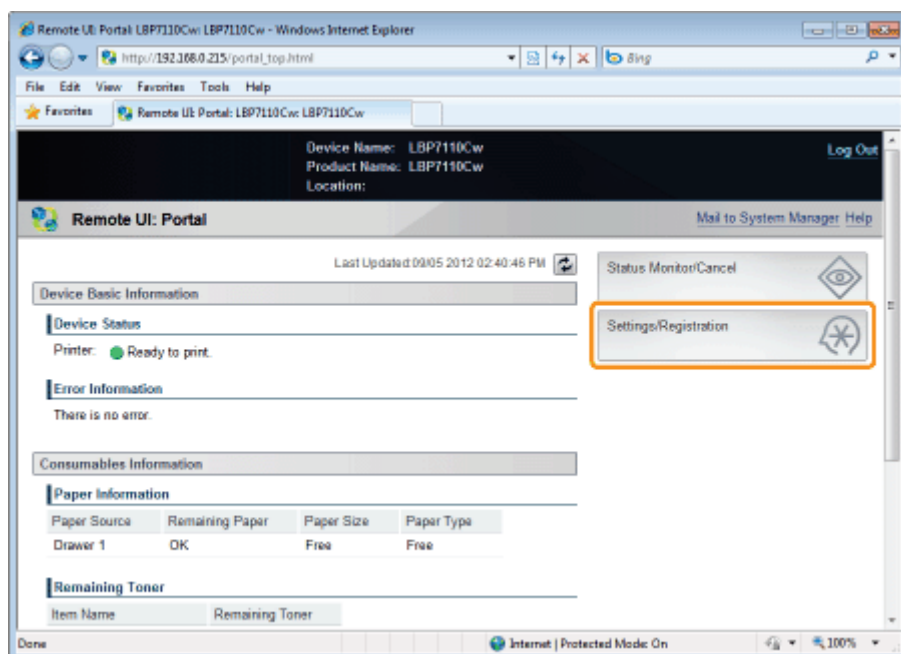

## 3

**Display the [Initialize System Settings] page.**

- (1) Select [Initialize Settings Information].
- (2) Click [Initialize System Settings].

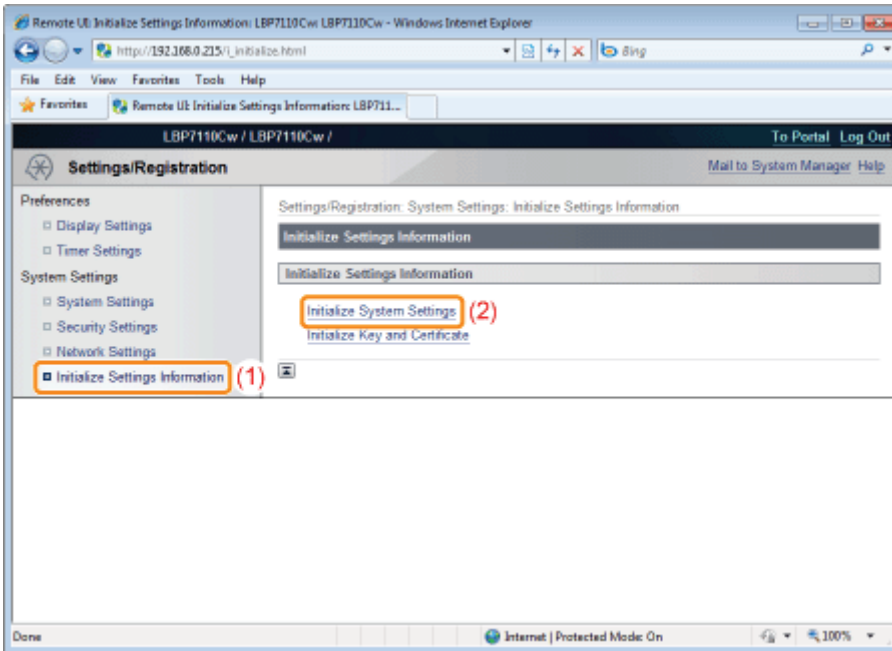

## 4

### Initialize the system settings.

- (1) Select the setting information to initialize.
- (2) Click [Initialize].

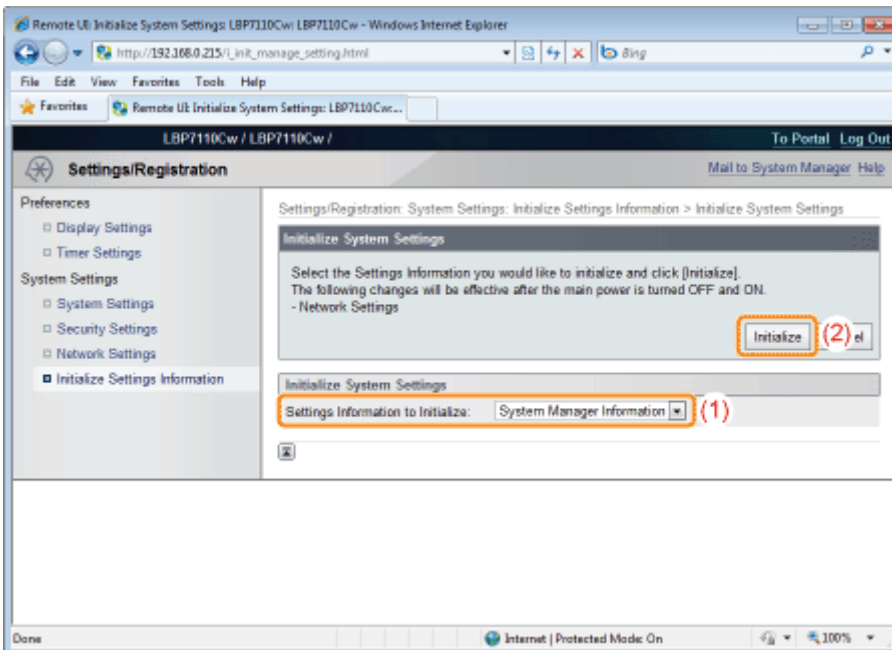

## 5

### Clicking [OK] initializes the selected setting information.

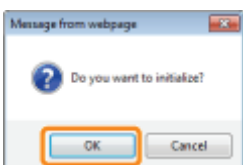

# 6

## Restart the printer after initializing the network settings.

Turn the printer OFF, make sure that the Main Power indicator is off, wait for 10 seconds or longer, and then turn it ON again.

→ After the printer is restarted, the initialization is complete.

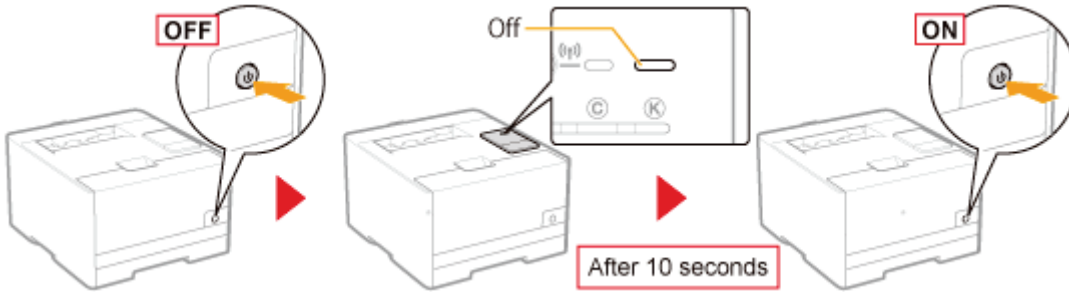

# Initializing Using the Reset Button

You can initialize (reset to the default values) the following setting information all at once.

- System Manager Information<sup>\*1</sup>
- Device Information<sup>\*2</sup>
- Security Settings
- Network Settings

<sup>\*1</sup> [System Manager] is not initialized.

<sup>\*2</sup> [Device Name] and [Location] are not initialized.

## 1

### Turn the printer OFF.

→ Check that the Main Power indicator is off.

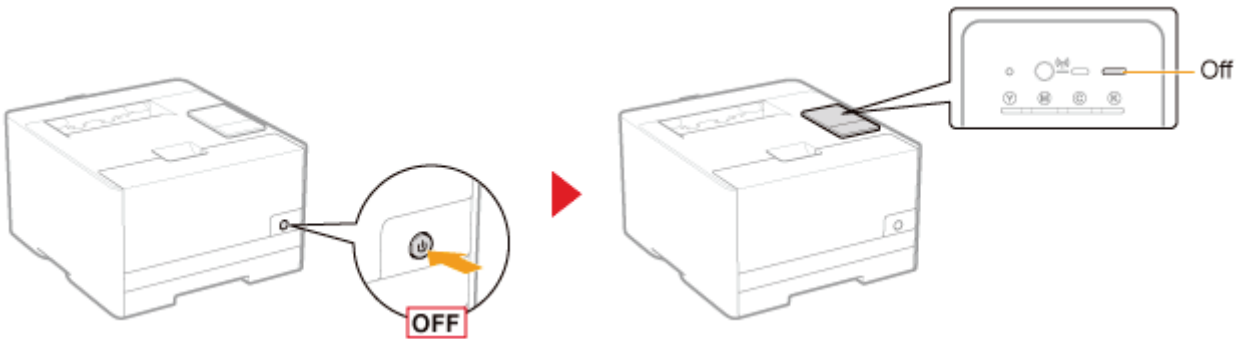

## 2

### Turning ON the printer while pressing the reset button (A) initializes the system settings.

Press the reset button with the tip of a pen, thin pin, or similar item.

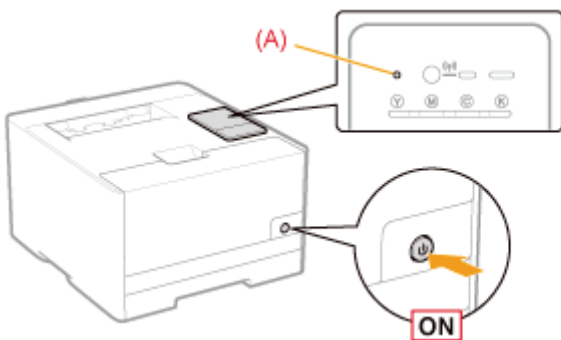

# Security Settings

---

## ➤ **Restricting the Users Who Can Print and Specify Settings**

## ➤ **Monitoring/Controlling Devices by SNMP (SNMP Settings)**

## ➤ **Specifying Keys and Certificates/CA Certificates**

- Creating Keys and Certificates
- Installing Keys and Certificates/CA Certificates
- Checking Keys and Certificates/CA Certificates
- Deleting Keys and Certificates/CA Certificates

## ➤ **Setting the SSL Encrypted Communication Function**

## ➤ **Setting IEEE 802.1X Authentication**

---

# Restricting the Users Who Can Print and Specify Settings

You can restrict the users who can print and specify settings (the users who can send/receive data) based on their IP addresses and MAC addresses.

- ❖ Restricting Based on IP Addresses
- ❖ Restricting Based on MAC Addresses

## NOTE

### If restricted users try to print

The message <Network Communication Error> appears in the Printer Status Window.

## Restricting Based on IP Addresses

### 1

Start the Remote UI, and then log in as Management Mode.

- ❖ "Starting the Remote UI"

### 2

Click [Settings/Registration].

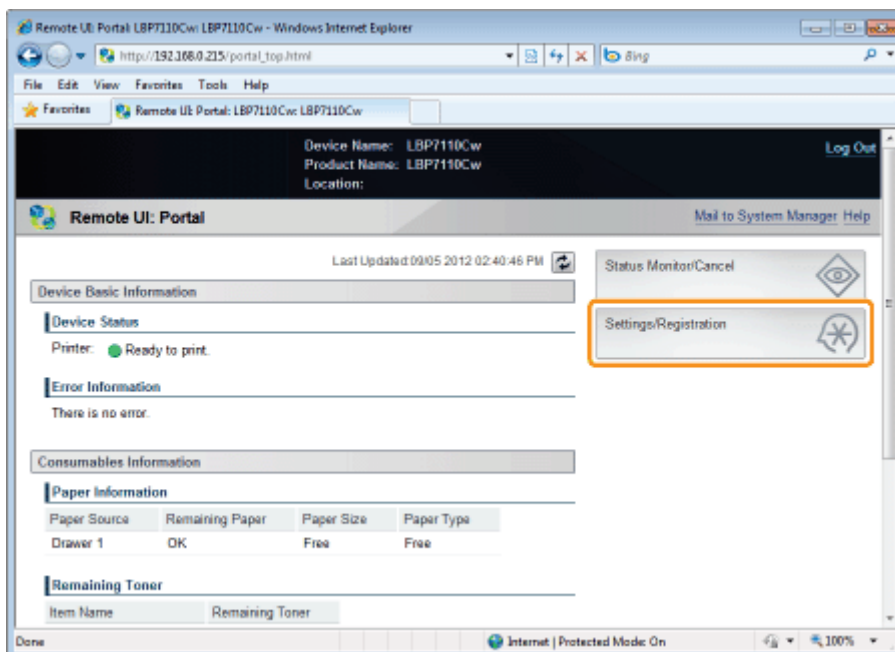

### 3

Display the [IP Address Filter] page.

- (1) Select [Security Settings].
- (2) Click [IP Address Filter].

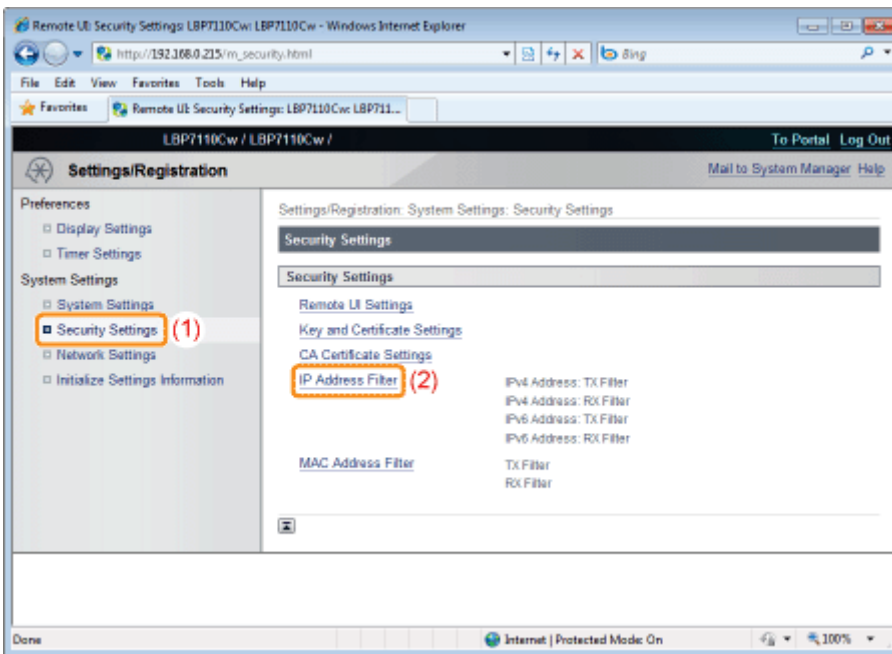

## 4

Click **[Edit]** in the filter which you want to specify.

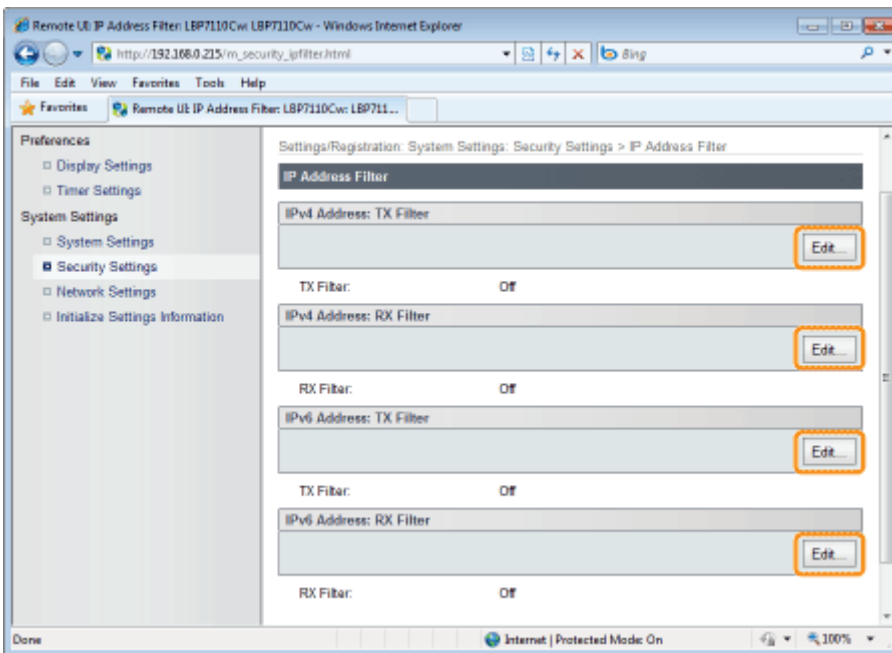

[IPv4 Address: TX Filter]	Restricts data transmission from the printer based on the specified IPv4 addresses.
[IPv4 Address: RX Filter]	Restricts data reception to the printer based on the specified IPv4 addresses.
[IPv6 Address: TX Filter]	Restricts data transmission from the printer based on the specified IPv6 addresses.
[IPv6 Address: RX Filter]	Restricts data reception to the printer based on the specified IPv6 addresses.

(The following describes the procedure for the [IPv4 Address: TX Filter] screen as an example.)

## 5

Select the **[Use Filter]** check box.



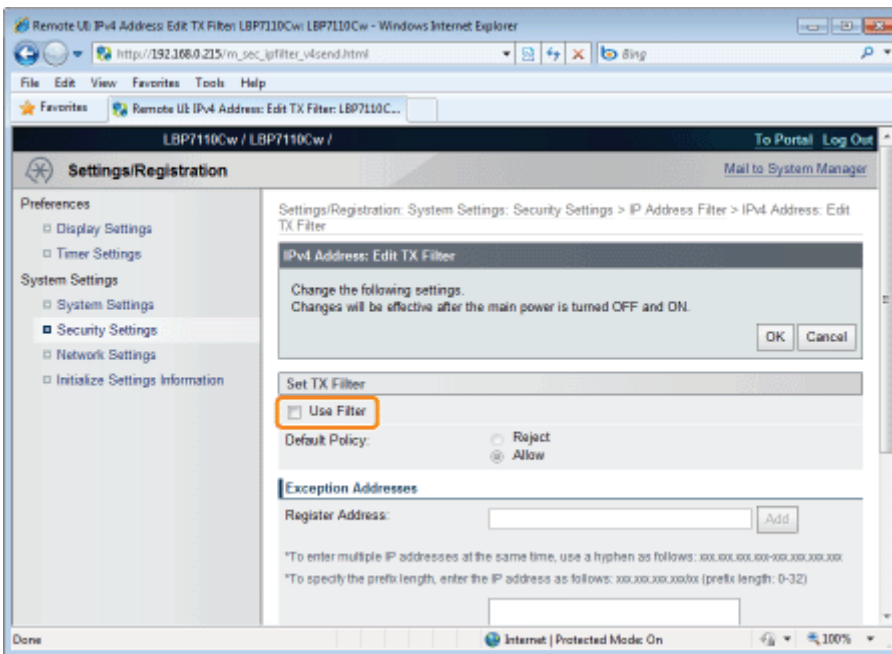

## 6

### Select [Default Policy].

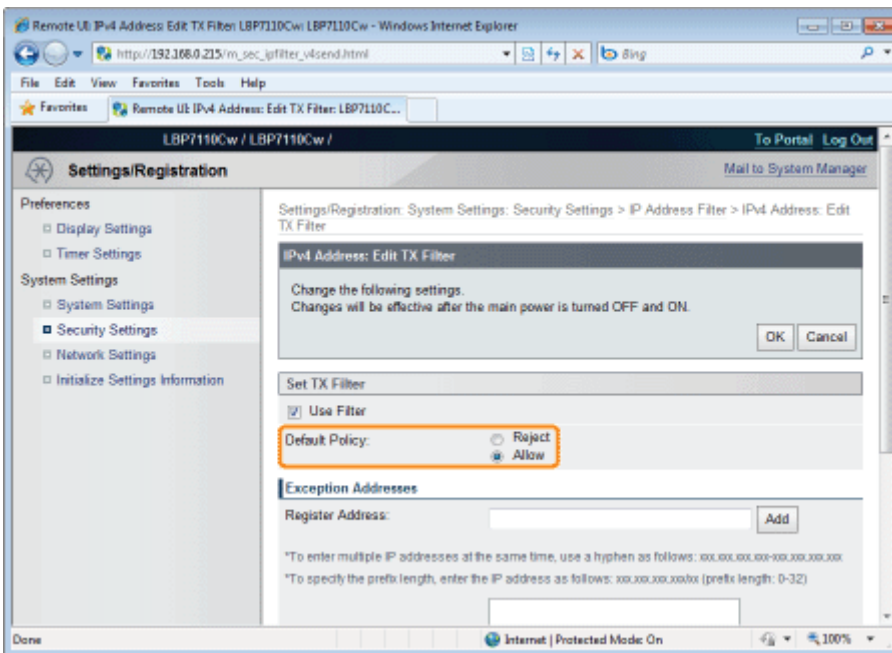

[Reject]	Restricts data transmission to or data reception from IP addresses other than those specified in [Exception Addresses]. (Only the IP addresses specified in [Exception Addresses] are available for transmission or reception.)
[Allow]	Allows data transmission to or data reception from IP addresses other than those specified in [Exception Addresses]. (Only the IP addresses specified in [Exception Addresses] are restricted.)

## 7

### Specify the exception IP address for [Default Policy].

- (1) Enter the exception IP address for the policy selected in [Default Policy] at Step 6.

(2) Click [Add].

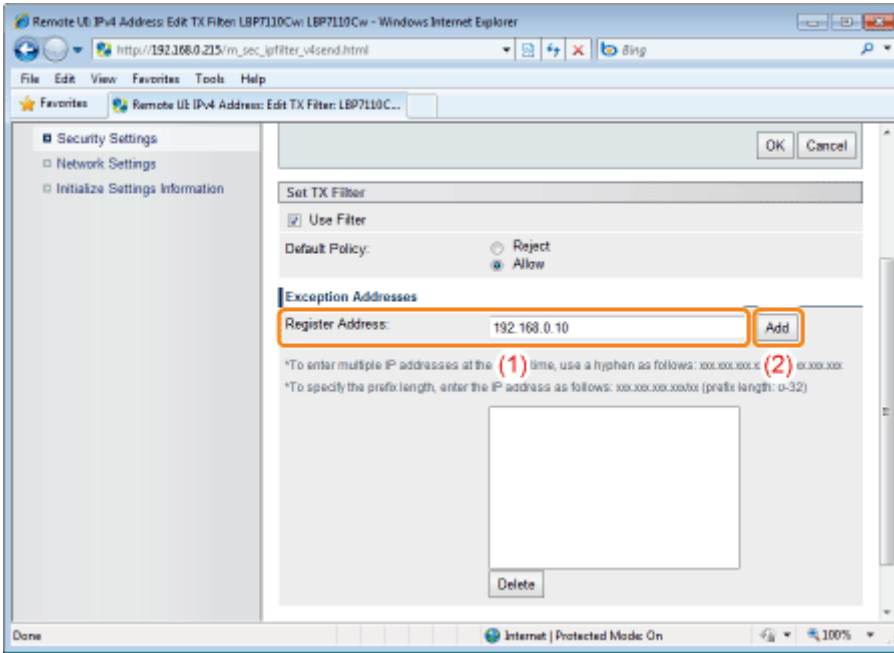

**<Method for entering IPv4 addresses>**

Specification Method	Input Method	Input Example
Single Address	Enter the IP address, with the numbers separated by periods (.).	192.168.0.10
Multiple Addresses	To enter the IP addresses of consecutive numbers, place a hyphen (-) between the address of the smallest number and that of the largest number. This setting specifies the range of IP addresses to be excepted. This setting is useful when you want to specify a series of addresses at a time.	192.168.0.10-192.168.0.20
Prefix Address	To specify with a prefix (0 to 32), place a slash (/) between the prefix address and the prefix length. This setting specifies the prefix to be excepted. This setting is useful when you want to specify addresses having the same prefix at a time.	192.168.0.10/24

† Up to 16 addresses (or 16 ranges of addresses) can be specified for the single address, multiple addresses, and prefix address combined.

† An address consisting of only zeros cannot be specified.

**<Method for entering IPv6 addresses>**

Specification Method	Input Method	Input Example
Single Address	Enter the IP address, with the alphanumeric characters separated by a colon (:).	fe80::10
Multiple Addresses	To enter the IP addresses of consecutive numbers, place a hyphen (-) between the address of the smallest number and that of the largest number. This setting specifies the range of IP addresses to be excepted. This setting is useful when you want to specify a series of addresses at a time.	fe80::10-fe80::20
Prefix Address	To specify with a prefix (0 to 128), place a slash (/) between the prefix address and the prefix length. This setting specifies the prefix to be excepted. This setting is useful when you want to specify addresses having the same prefix at a time.	fe80::10/64

- † Up to 16 addresses (or 16 ranges of addresses) can be specified for the single address, multiple addresses, and prefix address combined.
- † An address consisting of only zeros cannot be specified.

**NOTE**

**When deleting a set IP address**

- (1) Select an IP address you want to delete.
- (2) Click [Delete].

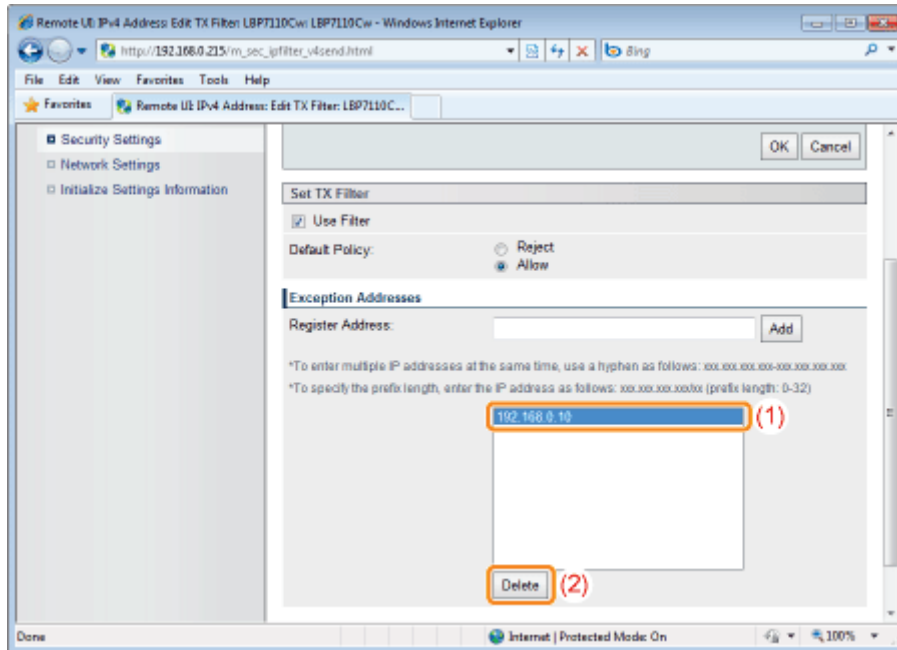

**8**

Click [OK].

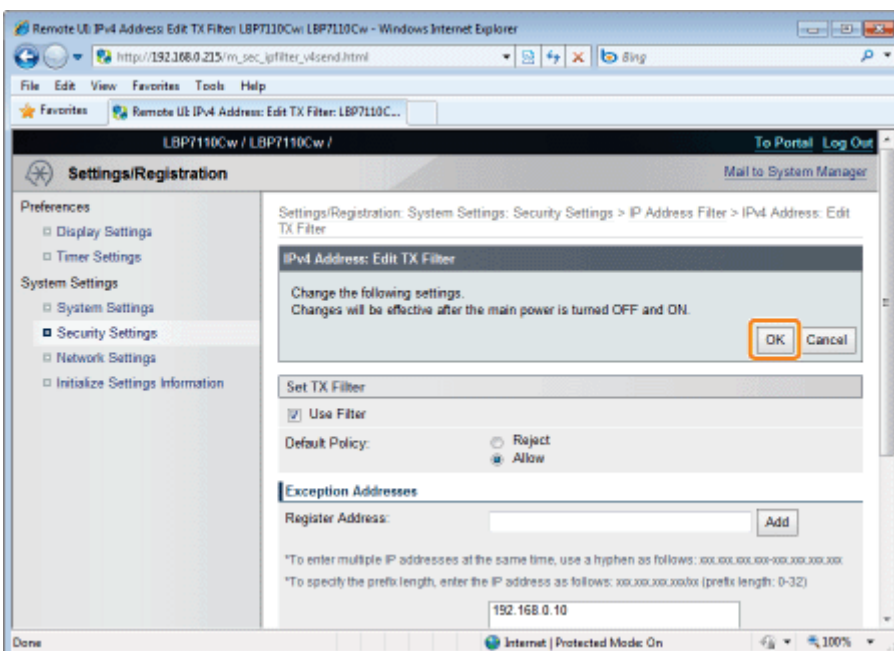

# 9

## Restart the printer.

Turn the printer OFF, make sure that the Main Power indicator is off, wait for 10 seconds or longer, and then turn it ON again.

→ After the printer is restarted, the settings become effective.

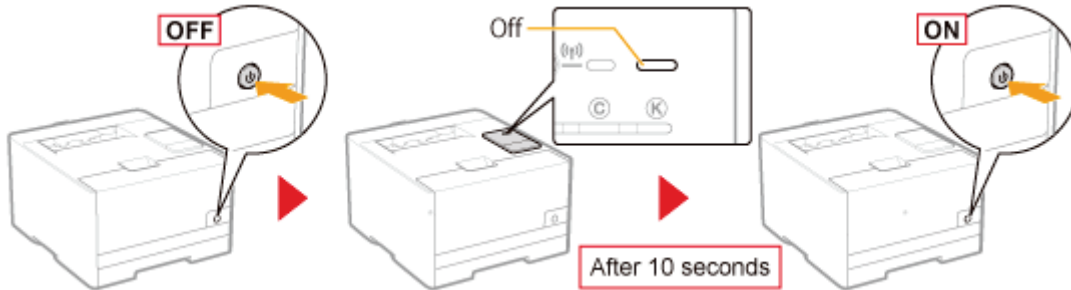

## Restricting Based on MAC Addresses

# 1

## Start the Remote UI, and then log in as Management Mode.

➤ "Starting the Remote UI"

# 2

## Click [Settings/Registration].

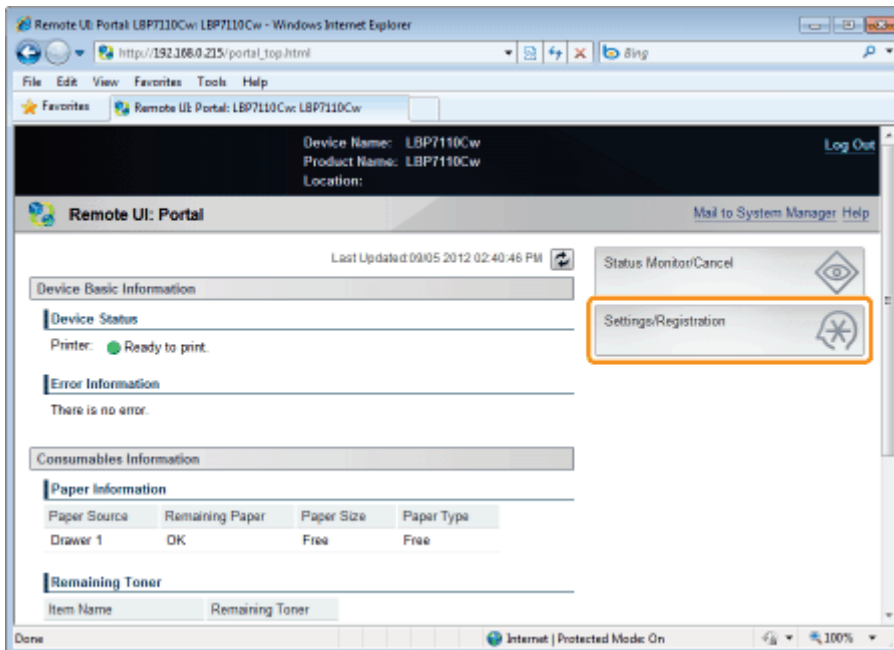

# 3

## Display the [MAC Address Filter] page.

(1) Select [Security Settings].

(2) Click [MAC Address Filter].

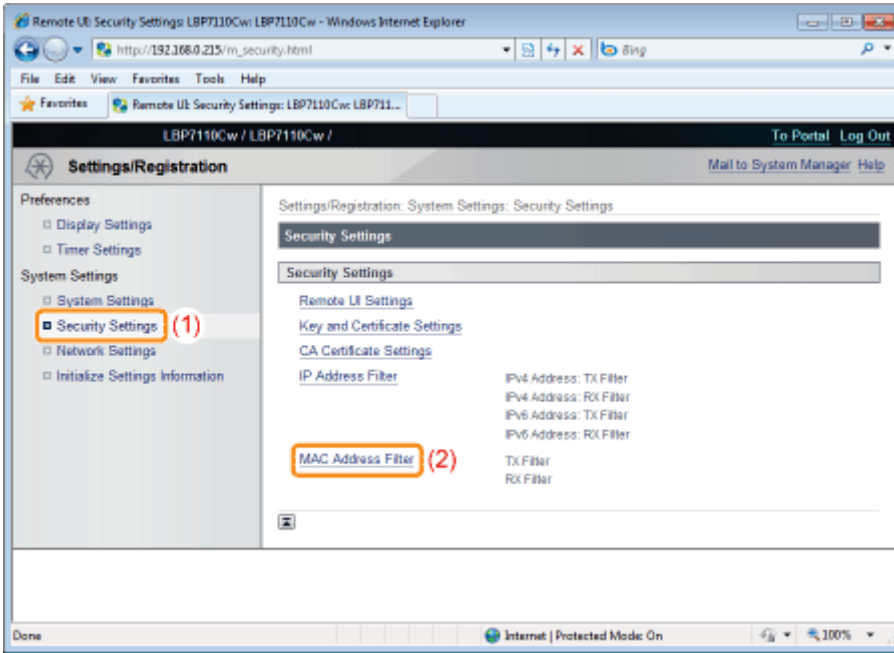

## 4

Click [Edit] in the filter which you want to specify.

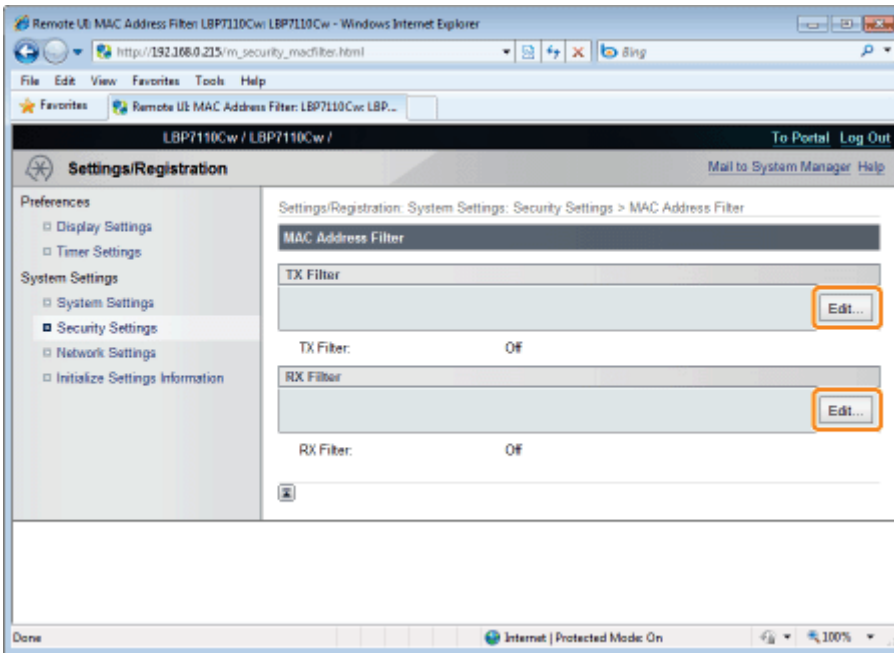

[TX Filter]	Restricts data transmission from the printer.
[RX Filter]	Restricts data reception to the printer.

(The following describes the procedure for the [TX Filter] screen as an example.)

## 5

Select the [Use Filter] check box.

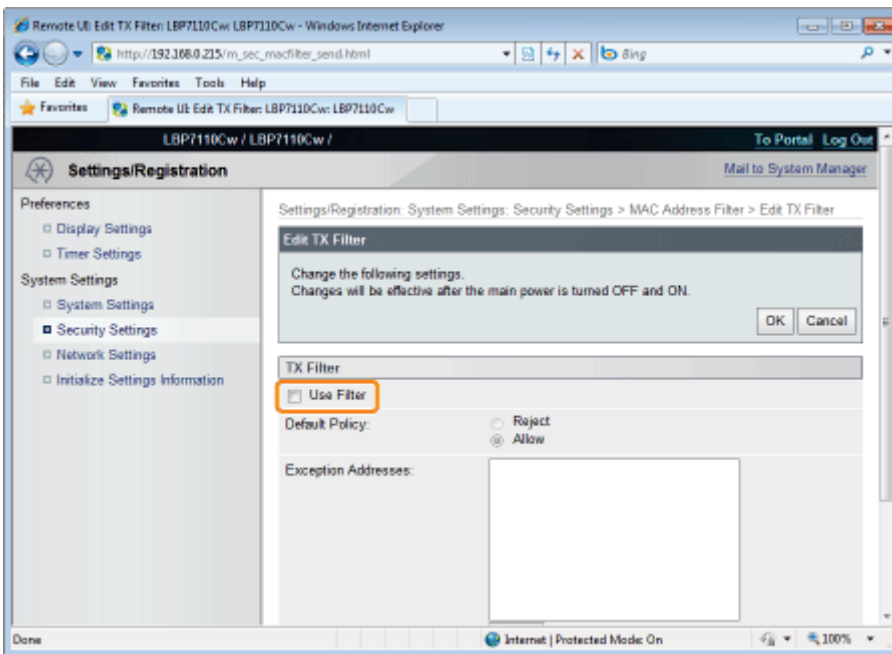

## 6

### Select [Default Policy].

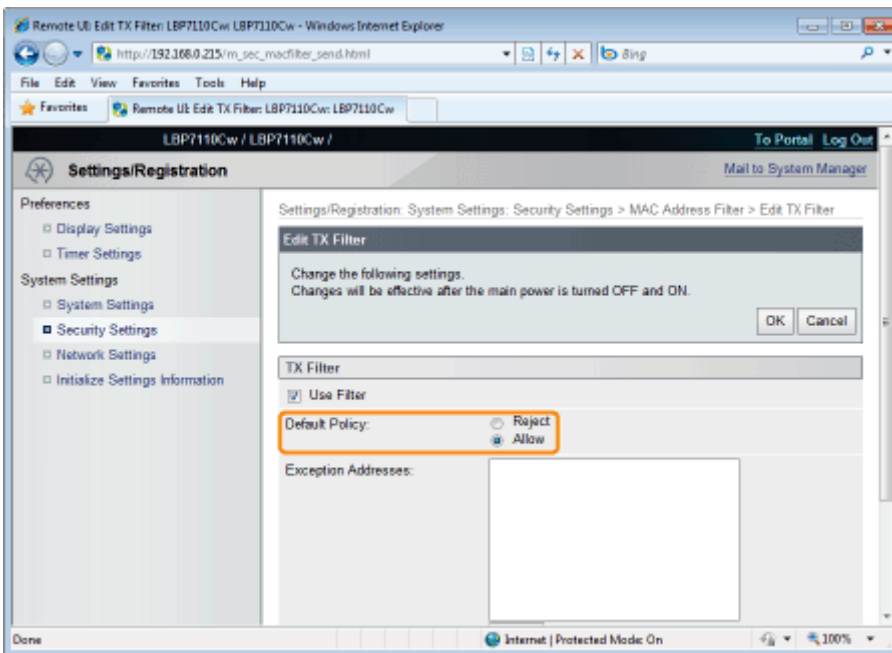

[Reject]	Restricts data transmission to or data reception from MAC addresses other than those specified in [Exception Addresses]. (Only the MAC addresses specified in [Exception Addresses] are available for transmission or reception.)
[Allow]	Allows data transmission to or data reception from MAC addresses other than those specified in [Exception Addresses]. (Only the MAC addresses specified in [Exception Addresses] are restricted.)

### IMPORTANT

#### When selecting [Reject]

You cannot access from a MAC address not set in [Exception Addresses]. Therefore, confirm the MAC address when entering it.

↑ If there is no corresponding MAC address, you cannot access the network. In this case, you can access the

network by initializing the system settings using the reset button on the printer.

- ❖ "Initializing Using the Reset Button"

## 7

### Specify the exception MAC address for [Default Policy].

(1) Enter the exception MAC address for the policy selected in [Default Policy] at Step 6.

- ↑ Enter the MAC address without the hyphens (-), for example, AABCCDDEEFF.

(2) Click [Add].

- ↑ Up to 32 addresses can be specified.

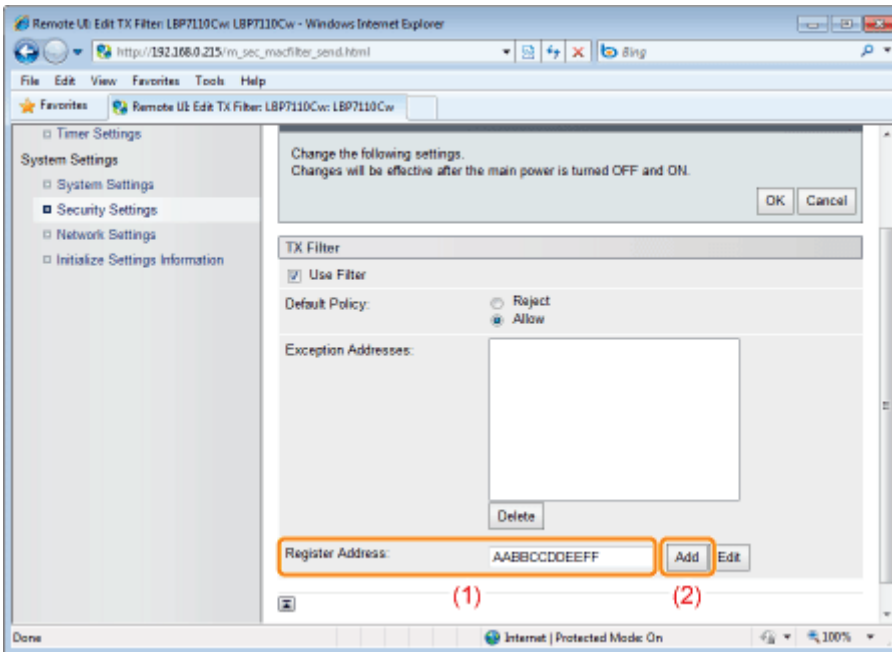

#### NOTE

#### When deleting a set MAC address

- (1) Select a MAC address you want to delete.
- (2) Click [Delete].

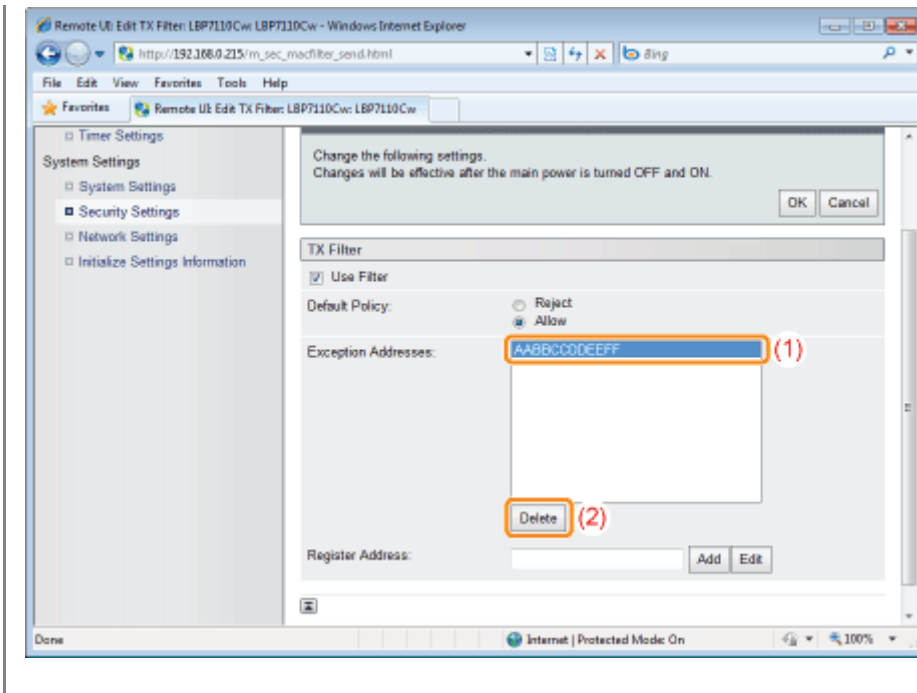

## 8

Click [OK].

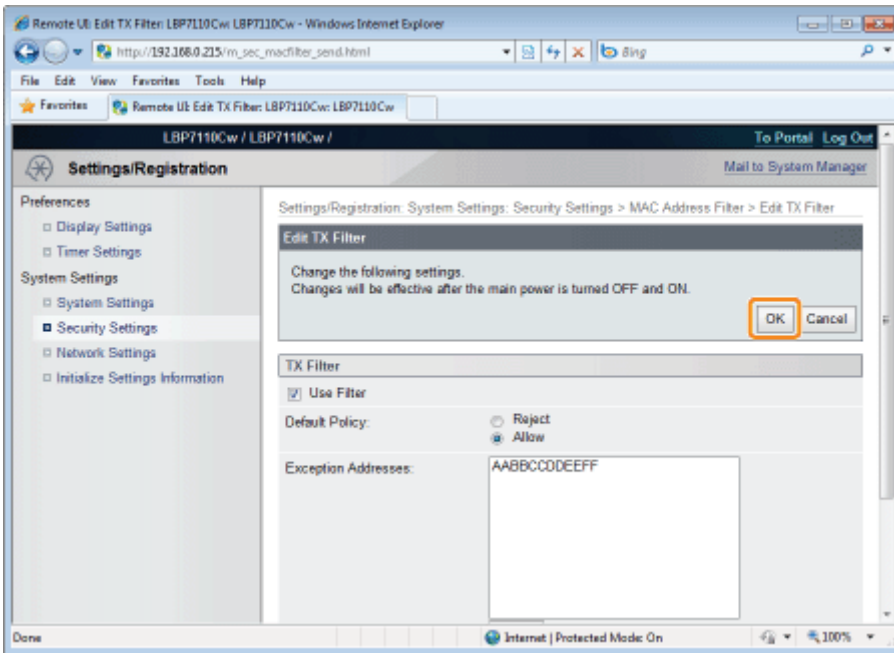

## 9

Restart the printer.

Turn the printer OFF, make sure that the Main Power indicator is off, wait for 10 seconds or longer, and then turn it ON again.

→ After the printer is restarted, the settings become effective.



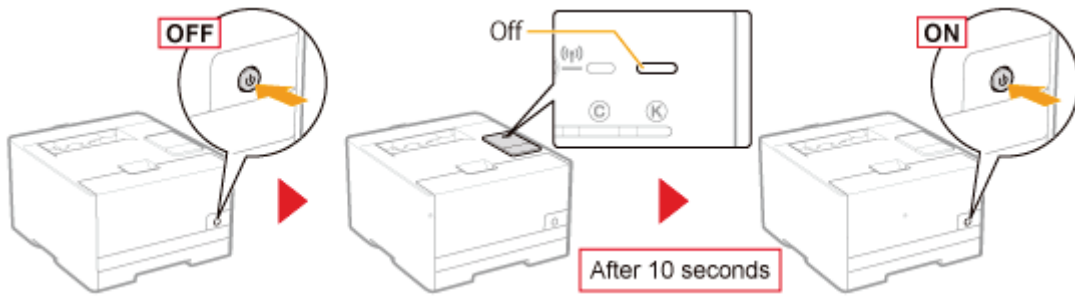

# Monitoring/Controlling Devices by SNMP (SNMP Settings)

You can monitor and control the printer by using SNMP support devices such as computers connected to networks. This printer supports SNMPv1, and SNMPv3 with enhanced security and authentication features.

## 1 Start the Remote UI, and then log in as Management Mode.

➤ "Starting the Remote UI"

## 2 Click [Settings/Registration].

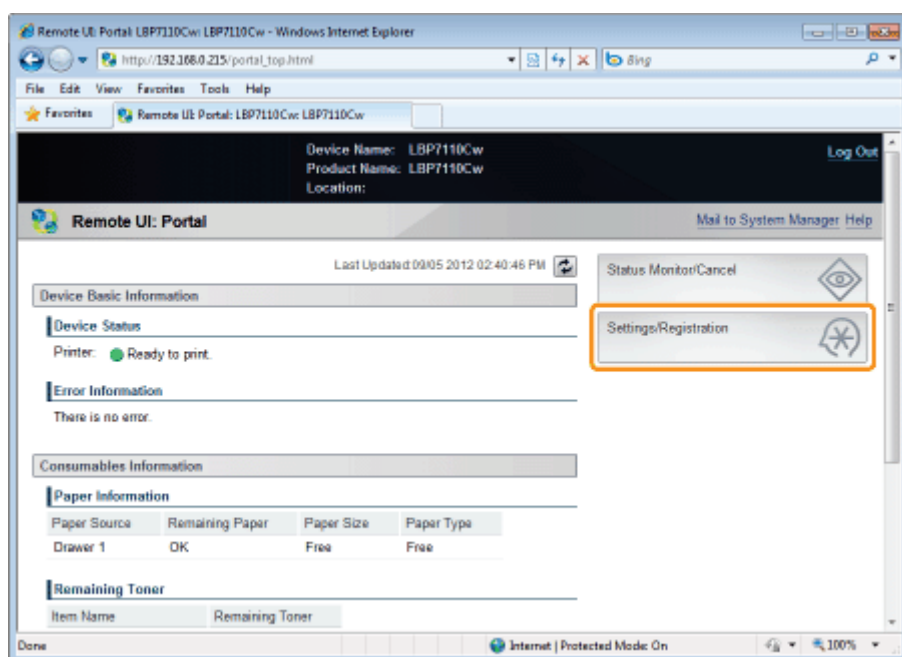

## 3 Display the [SNMP Settings] page.

- (1) Select [Network Settings].
- (2) Click [SNMP Settings].

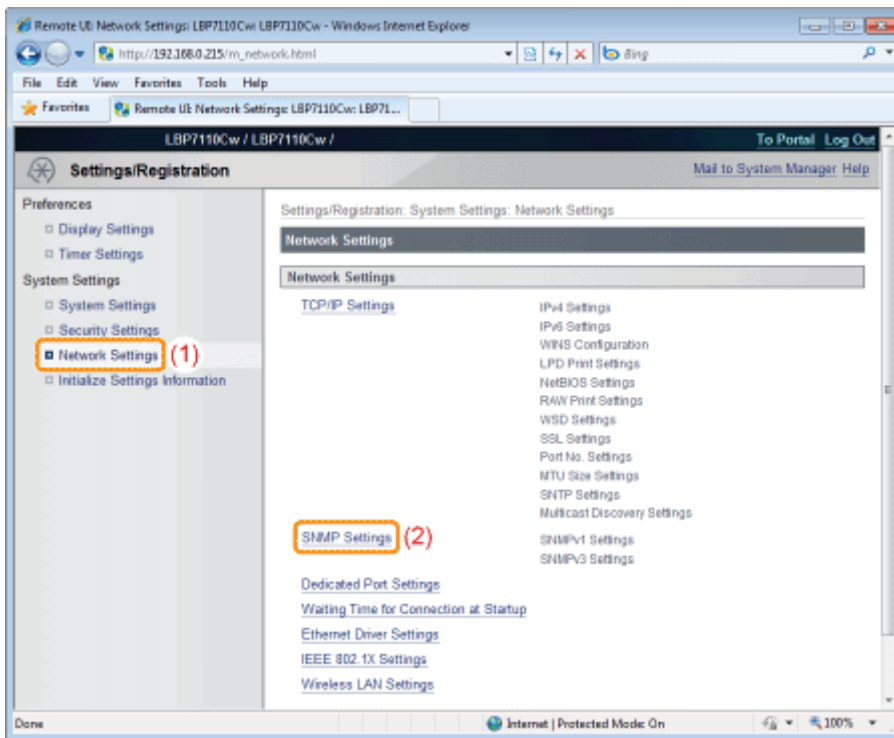

4

Click [Edit].

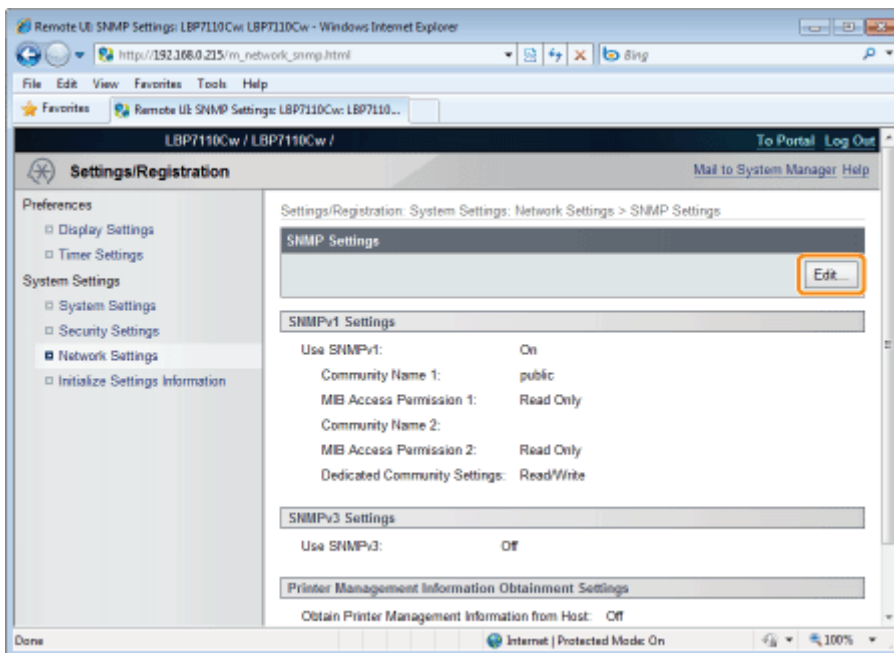

5

Configure the SNMPv1 protocol.

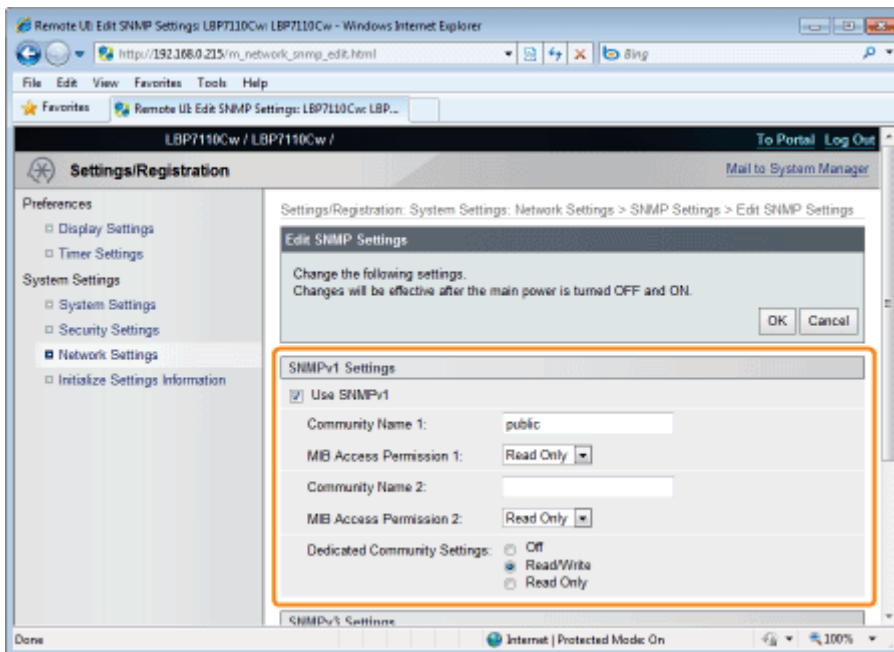

[Use SNMPv1]	Select the check box to use the SNMPv1 protocol.
[Community Name 1]	Specify an SNMPv1 community name. You can enter up to 32 single-byte alphanumeric characters. The default value is [public].
[MIB Access Permission 1]	Specify the MIB access authority of [Community Name 1]. When both reading and writing are permitted, you can access the printer from a computer on the network and change settings. <ul style="list-style-type: none"> <li>• <b>[Read/Write]</b> Both reading and writing are permitted.</li> <li>• <b>[Read Only]</b> Reading only is permitted.</li> </ul>
[Community Name 2]	Specify an SNMPv1 community name. You can enter up to 32 single-byte alphanumeric characters.
[MIB Access Permission 2]	Specifies the MIB access authority of [Community Name 2]. When both reading and writing are permitted, you can access the printer from a computer on the network and change settings. <ul style="list-style-type: none"> <li>• <b>[Read/Write]</b> Both reading and writing are permitted.</li> <li>• <b>[Read Only]</b> Reading only is permitted.</li> </ul>
[Dedicated Community Settings]	Specify a dedicated community and its MIB access right. <ul style="list-style-type: none"> <li>• <b>[Off]</b> The dedicated community is deactivated.</li> <li>• <b>[Read/Write]</b> Both reading and writing are permitted.</li> <li>• <b>[Read Only]</b> Reading only is permitted.</li> </ul>

## 6

### Configure the SNMPv3 protocol.

† To specify SNMPv3, you need to activate SSL features in advance.

❖ ["Setting the SSL Encrypted Communication Function"](#)

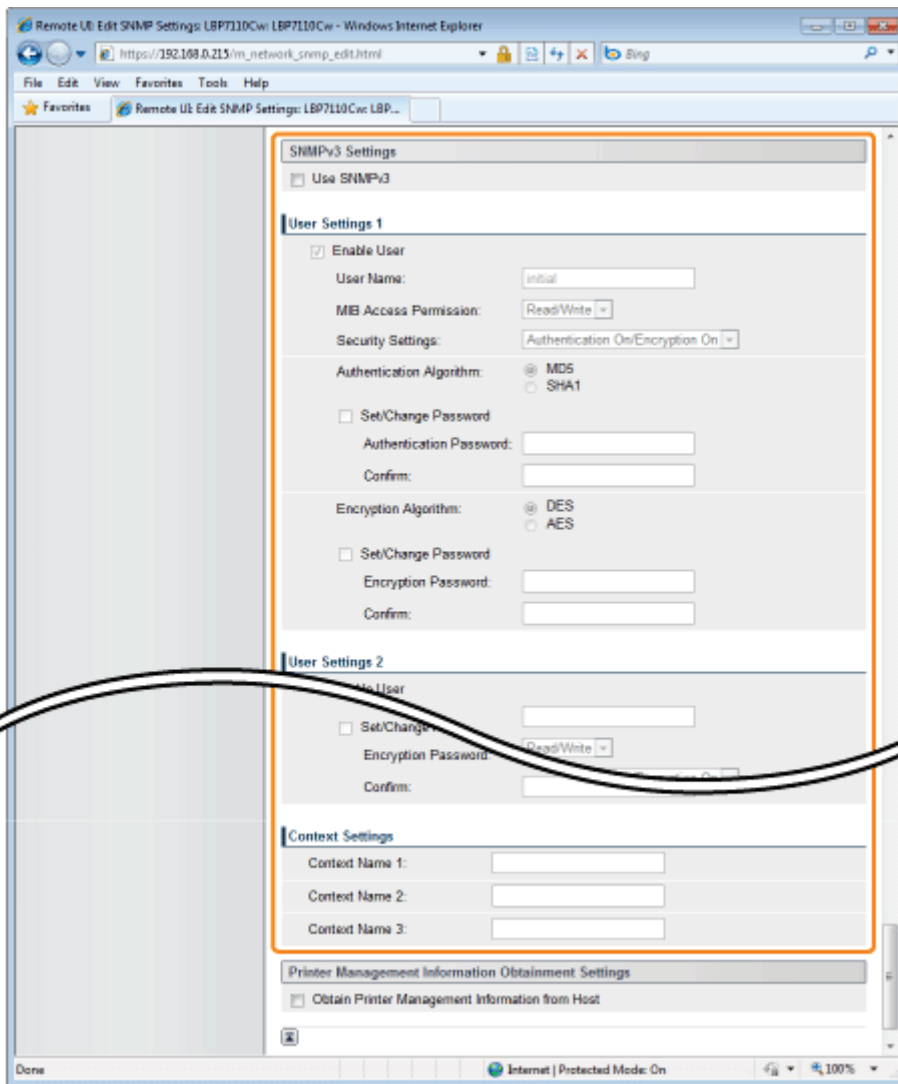

[Use SNMPv3]	Select the check box to use the SNMPv3 protocol.
--------------	--

### [User Settings 1]/[User Settings 2]/[User Settings 3]

[Enable User]	Select the check box if you want to register/edit user information or enable the registered user information.
[User Name]	Enter the user name to be used for the SNMPv3 protocol. You can enter up to 32 single-byte alphanumeric characters.
[MIB Access Permission]	Specify the MIB access authority. When both reading and writing are permitted, a user can access the printer from a computer on the network and change settings. <ul style="list-style-type: none"> <li>• <b>[Read/Write]</b> Both reading and writing are permitted.</li> <li>• <b>[Read Only]</b> Reading only is permitted.</li> </ul>
[Security Settings]	Specify the security settings. <ul style="list-style-type: none"> <li>• <b>[Authentication On/Encryption On]</b> Both authentication and encryption are adopted.</li> <li>• <b>[Authentication On/Encryption Off]</b> Only authentication is adopted.</li> <li>• <b>[Authentication Off/Encryption Off]</b> Neither authentication nor encryption is adopted.</li> </ul>
	Select the algorithm to be used for authentication. <ul style="list-style-type: none"> <li>• <b>[MD5]</b> MD5 is used.</li> <li>• <b>[SHA1]</b></li> </ul>

[Authentication Algorithm]	<p>SHA1 is used.</p> <p><b>To set or change the authentication password</b></p> <p>Select the [Set/Change Password] check box, and then enter the password to [Authentication Password] and [Confirm].</p> <p>You can enter 6 to 16 single-byte alphanumeric characters.</p>
[Encryption Algorithm]	<p>Select the encryption algorithm.</p> <ul style="list-style-type: none"> <li>• <b>[DES]</b> DES is used.</li> <li>• <b>[AES]</b> AES is used.</li> </ul> <p><b>To set or change the encryption password</b></p> <p>Select the [Set/Change Password] check box, and then enter the password to [Encryption Password] and [Confirm].</p> <p>You can enter 6 to 16 single-byte alphanumeric characters.</p>

### [Context Settings]

[Context Name 1]	<p>Enter a context name to be used in the SNMPv3 protocol. You can enter up to 32 single-byte alphanumeric characters.</p>
[Context Name 2]	
[Context Name 3]	

## 7

**Specify whether or not to obtain the printer management information as needed.**

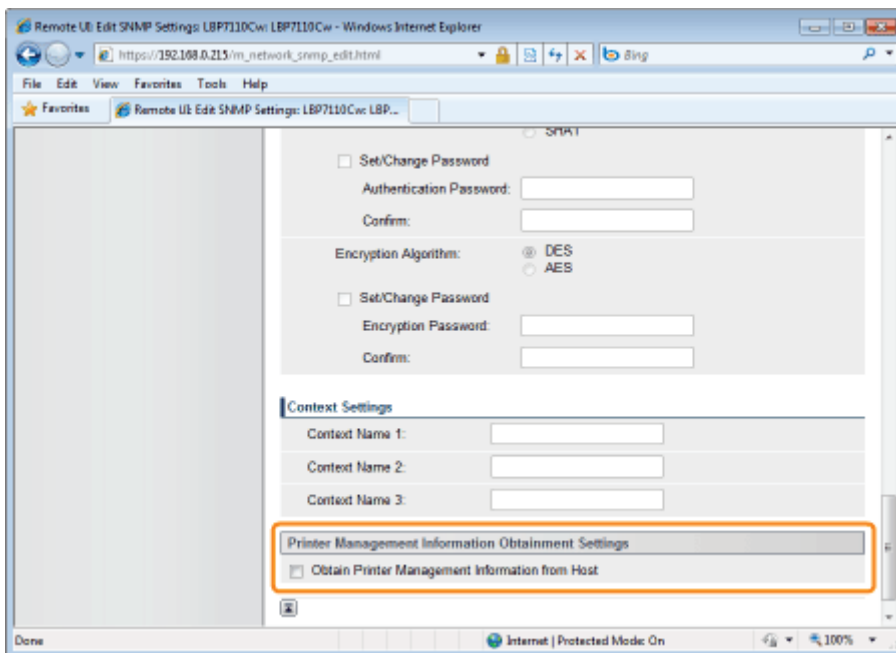

[Obtain Printer Management Information from Host]	<p>Select the check box if you want to periodically obtain the printer management information such as print applications and ports from host computers on the network by using SNMP.</p>
---	--

## 8

**Click [OK].**

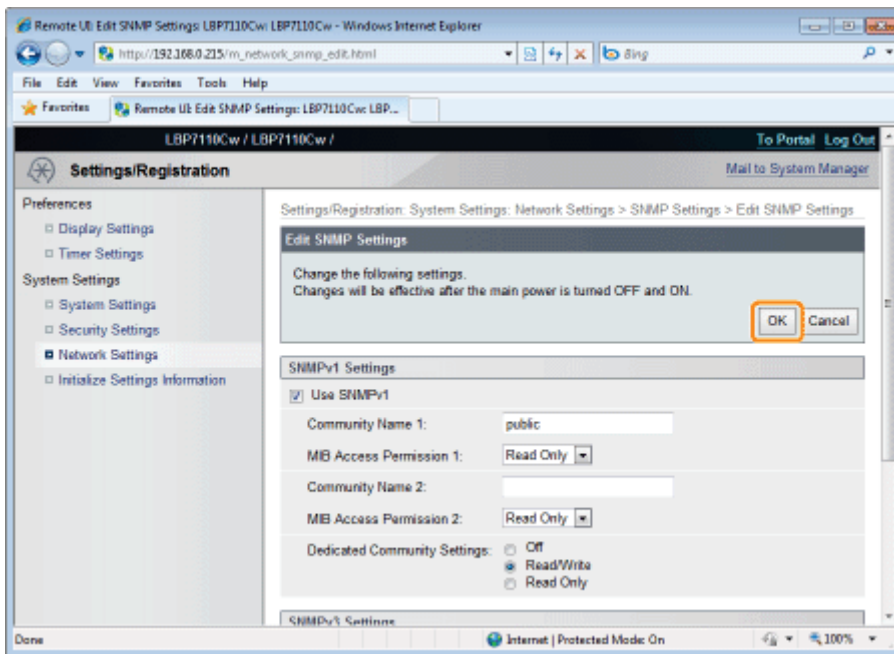

## 9

### Restart the printer.

Turn the printer OFF, make sure that the Main Power indicator is off, wait for 10 seconds or longer, and then turn it ON again.

→ After the printer is restarted, the settings become effective.

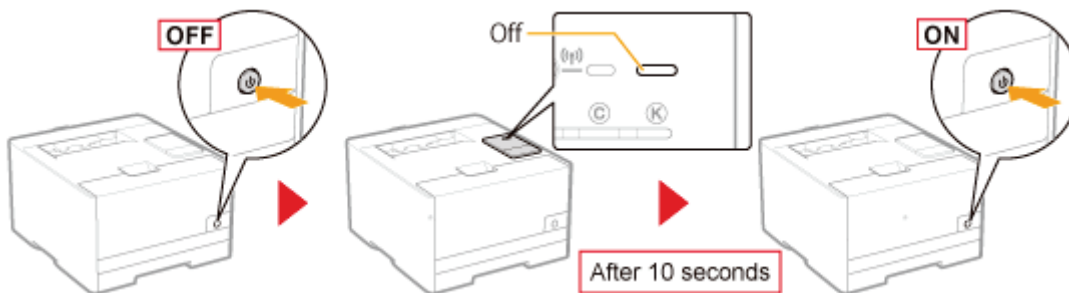

## Specifying Keys and Certificates/CA Certificates

You need to register keys and certificates to use SSL encrypted communication.

You need to register keys and certificates or CA certificates to perform IEEE 802.1X authentication.

The procedure for registering keys and certificates/CA certificates varies depending on the system environment. See the registration procedure according to your environment.

### To create keys and certificates

When using the printer by creating keys and server certificates (self-signed certificates), perform the following tasks.

**1. Create keys and certificates.**

➤ ["Creating Keys and Certificates"](#)

**2. Check the created key and certificate.**

➤ ["Checking Keys and Certificates/CA Certificates"](#)

### To use the key and certificate/CA certificate saved in the computer on the printer

When using a key and certificate file/CA certificate file to install (register) in the printer, perform the following tasks.

**1. Install the key and certificate/CA certificate in the printer.**

➤ ["Installing Keys and Certificates/CA Certificates"](#)

**2. Check the installed key and certificate/CA certificate.**

➤ ["Checking Keys and Certificates/CA Certificates"](#)

#### **IMPORTANT**

**About the number of keys and certificates/CA certificates that can be created or installed (registered)**

You can register up to 3 sets of keys and certificates/CA certificates.

If you cannot create or install (register) the keys and certificates/CA certificates, delete any unnecessary ones.

➤ ["Deleting Keys and Certificates/CA Certificates"](#)



# Creating Keys and Certificates

Create a key and server certificate (self-signed certificate) on the printer.

## 1

**Start the Remote UI, and then log in as Management Mode.**

➤ "Starting the Remote UI"

## 2

**Click [Settings/Registration].**

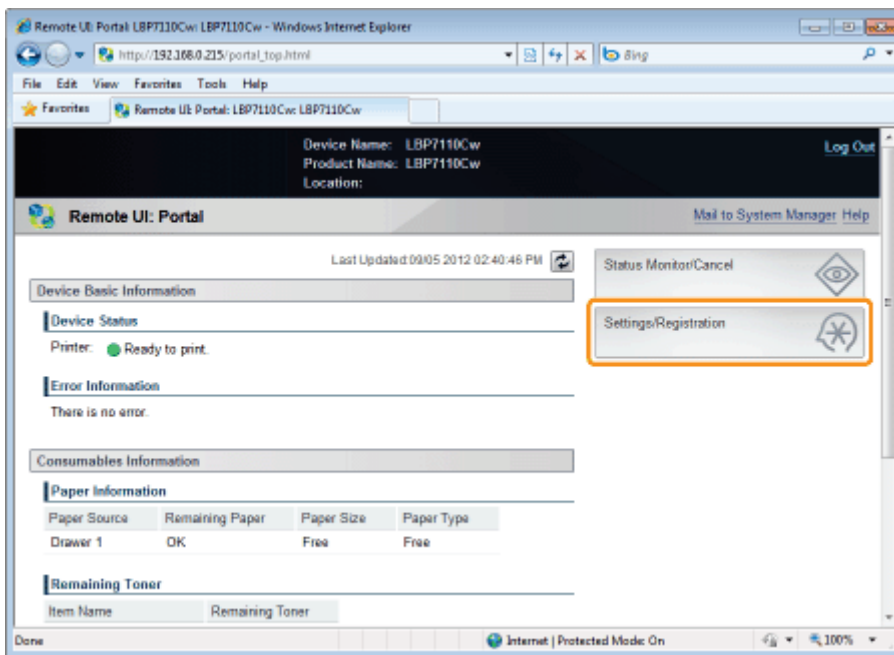

## 3

**Display the [Key and Certificate Settings] page.**

- (1) Select [Security Settings].
- (2) Click [Key and Certificate Settings].

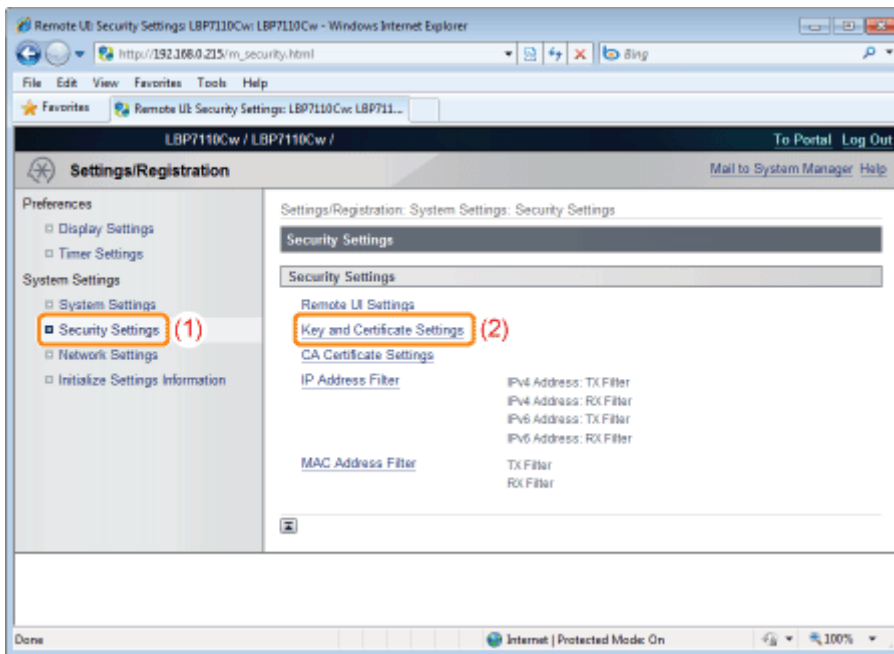

4

Click [Generate Key].

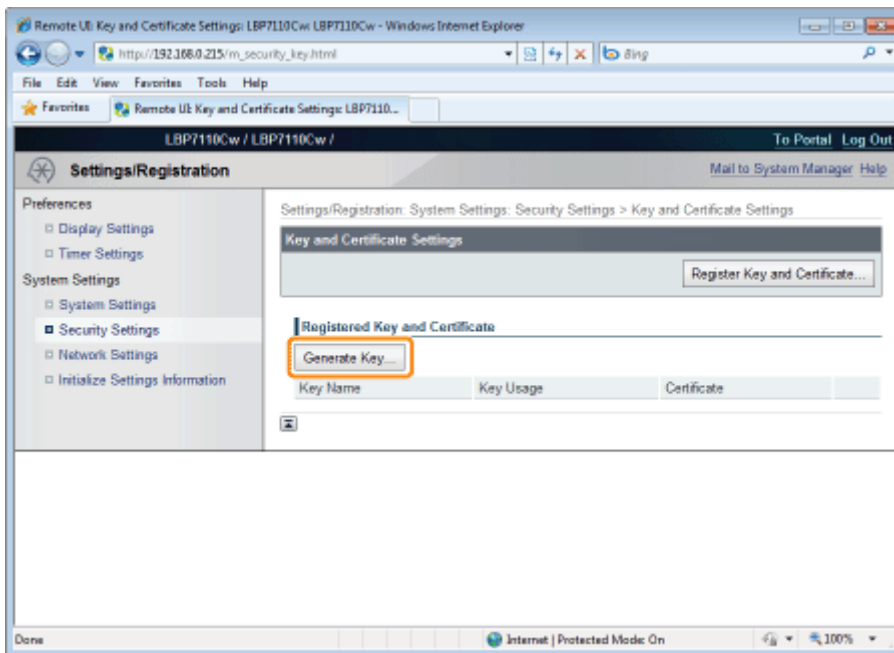

5

Specify a key to be created.

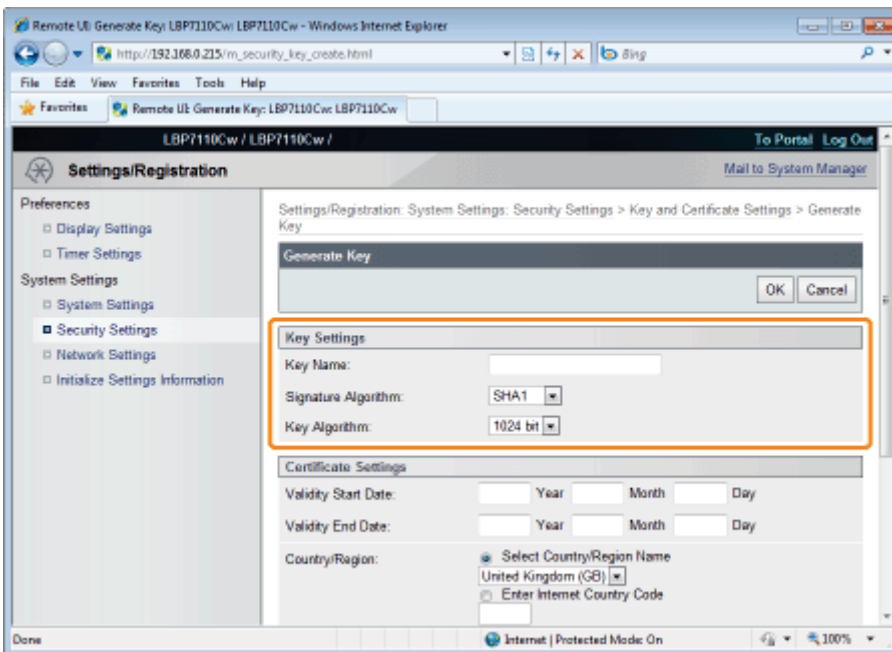

[Key Name]	Specify the name of the encryption key. You can enter up to 24 single-byte alphanumeric characters.
[Signature Algorithm]	Select the signature algorithm.
[Key Algorithm]	Select the key algorithm.

**NOTE**

**About the key generation algorithm**

The algorithm for generating a new key on this printer is RSA.

**About the key length**

As the key is longer, it is more difficult to decrypt the encrypted key, but the processing speed of encryption and decryption drops. Select the key length according to the need for security in data communications.

## 6

### Specify the certificate.

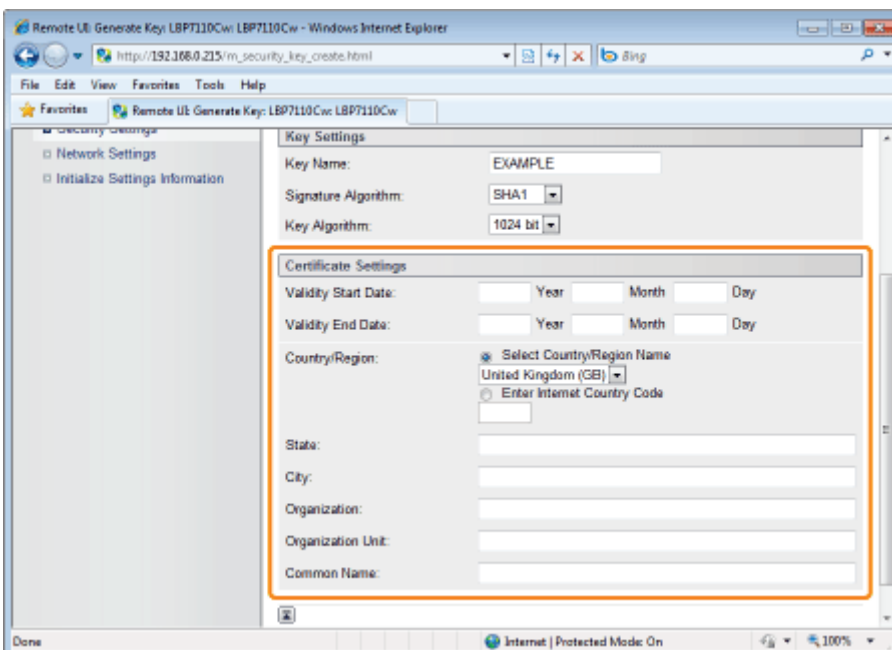

[Validity Start Date]	Specify the date on which the validity of the certificate starts. Enter the date (January 1, 2000 to December 31, 2037).
[Validity End Date]	Specify the date on which the validity of the certificate ends. Enter the date (January 1, 2000 to December 31, 2037).
[Country/Region]	Specify the country/region name.  <b>When selecting the country/region from a list of registered country codes</b> Select the [Select Country/Region Name] check box, and then select the country/region name from the pull-down menu.  <b>When directly entering an Internet country code</b> Select the [Enter Internet Country Code] check box, and then enter the Internet country code.
[State]	Enter the state name. You can enter up to 24 single-byte alphanumeric characters.
[City]	Enter the city name. You can enter up to 24 single-byte alphanumeric characters.
[Organization]	Enter the organization name. You can enter up to 24 single-byte alphanumeric characters.
[Organization Unit]	Enter the unit of the organization such as a department name. You can enter up to 24 single-byte alphanumeric characters.
[Common Name]	Enter the IP address or FQDN (in the format such as xyz.company.com) of the printer. You can enter up to 48 single-byte alphanumeric characters.

## 7

**Click [OK] to start creation of a key and certificate.**

† It takes approximately 10 to 15 minutes to create a key and certificate depending on the length of the key to be created.

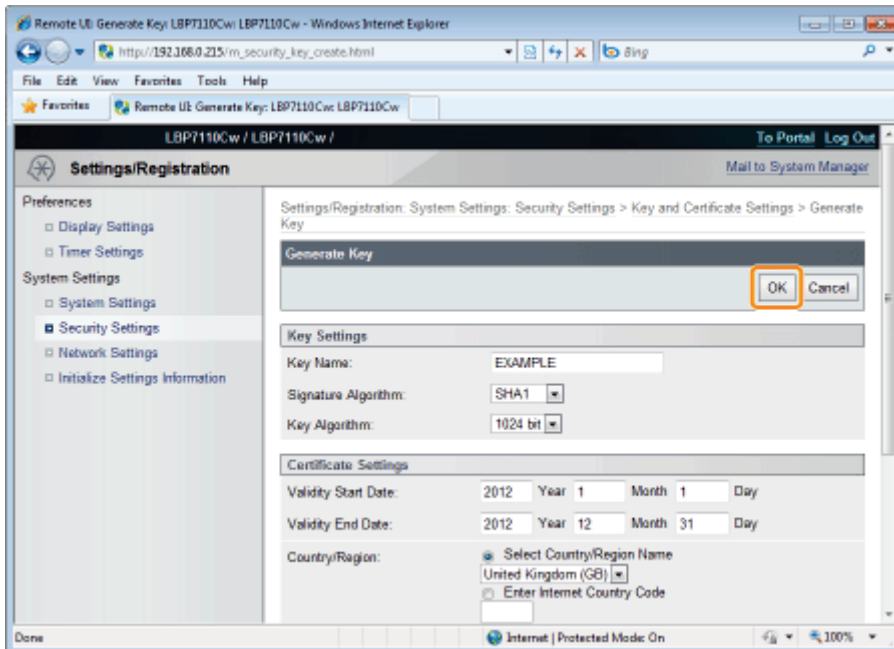

# Installing Keys and Certificates/CA Certificates

Install keys and certificates (PKCS#12 format) or CA certificates (X.509 format) saved in a computer on the printer. One CA certificate is pre-installed in the printer by default.

- ❖ Installing Keys and Certificates
- ❖ Installing CA Certificates

## Installing Keys and Certificates

### 1

Start the Remote UI, and then log in as Management Mode.

- ❖ "Starting the Remote UI"

### 2

Click [Settings/Registration].

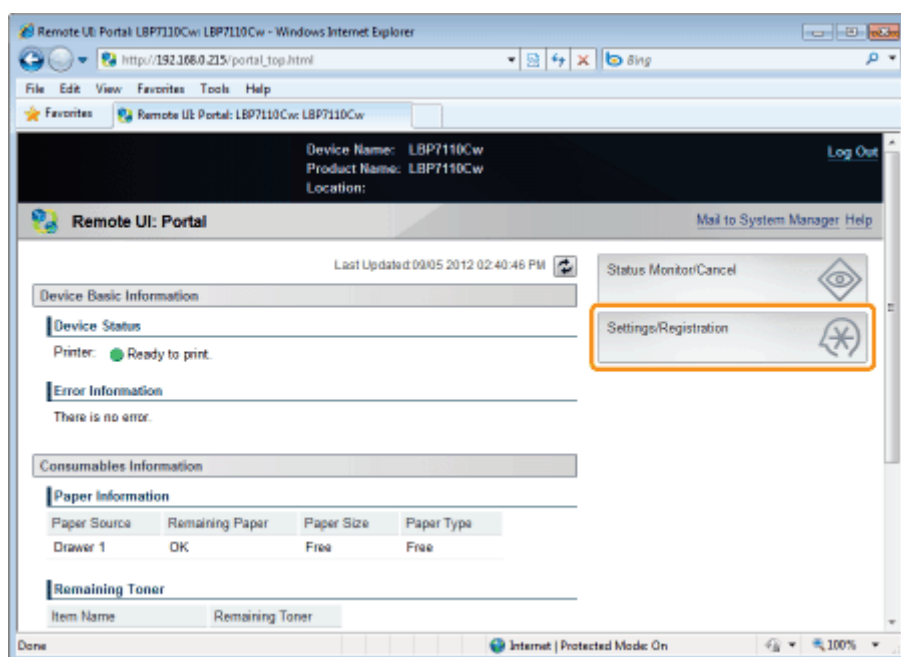

### 3

Display the [Key and Certificate Settings] page.

- (1) Select [Security Settings].
- (2) Click [Key and Certificate Settings].

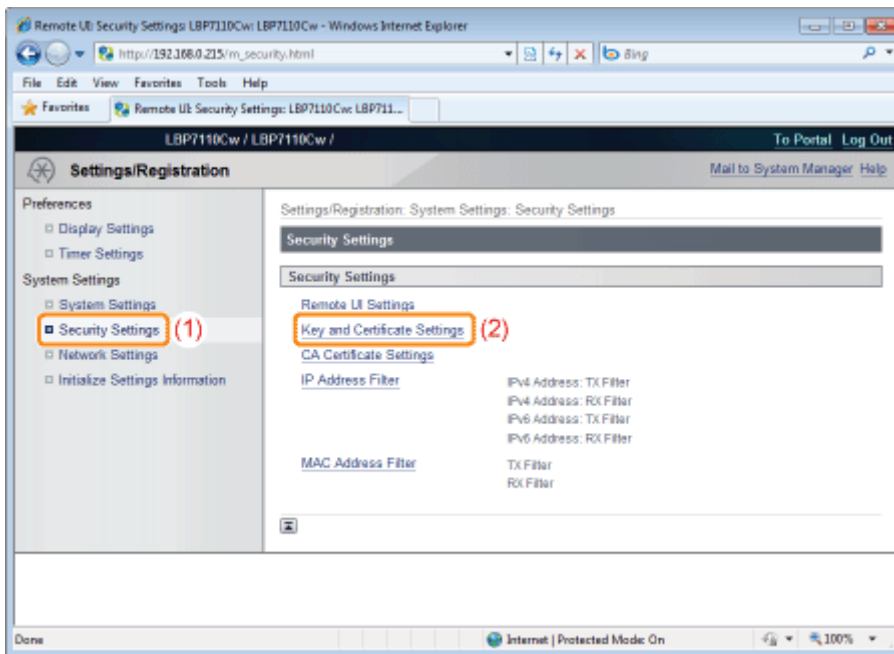

4

Click [Register Key and Certificate].

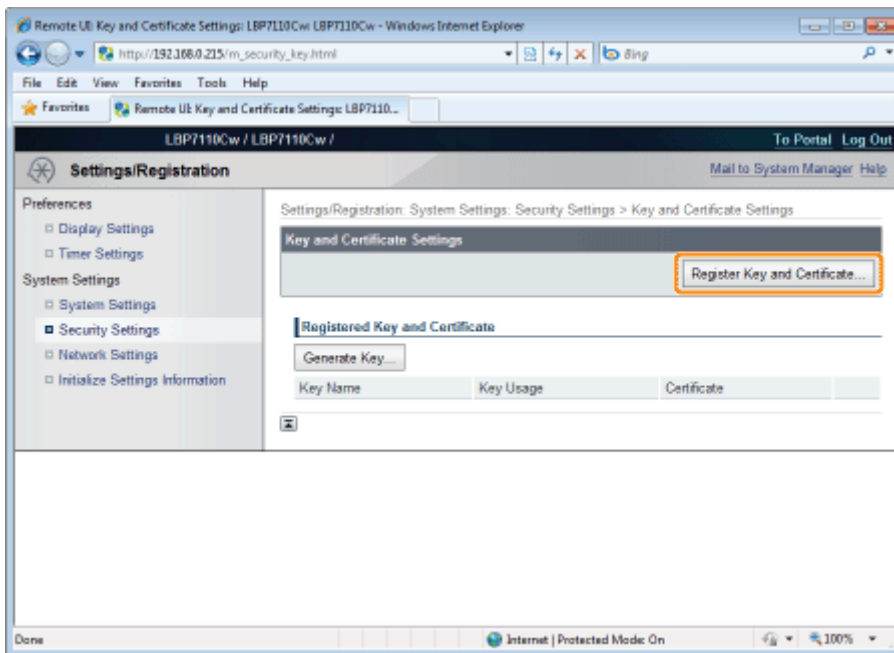

5

Click [Install].

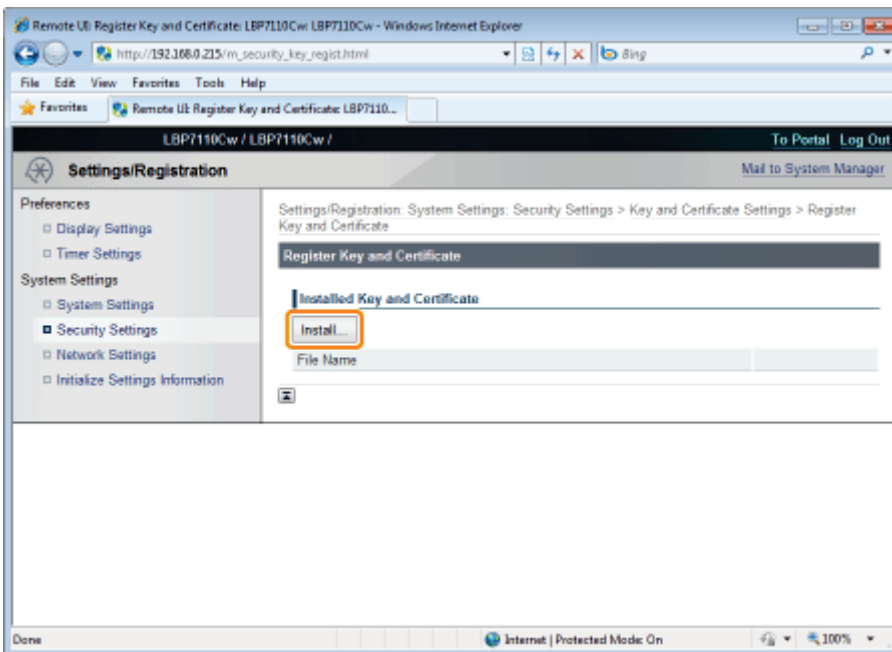

## IMPORTANT

### About the number of key and certificate files that can be installed

Only one file can be installed.

If a key and certificate file is already installed, click [Delete], and then delete the installed file.

## 6

Click [Browse], and then select a key and certificate file to install.

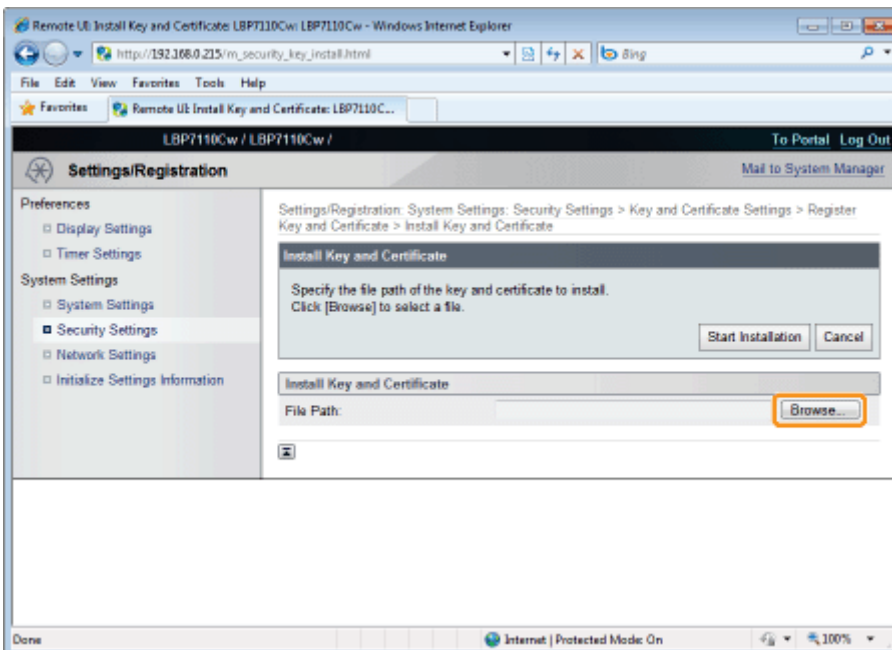

## 7

Click [Start Installation].

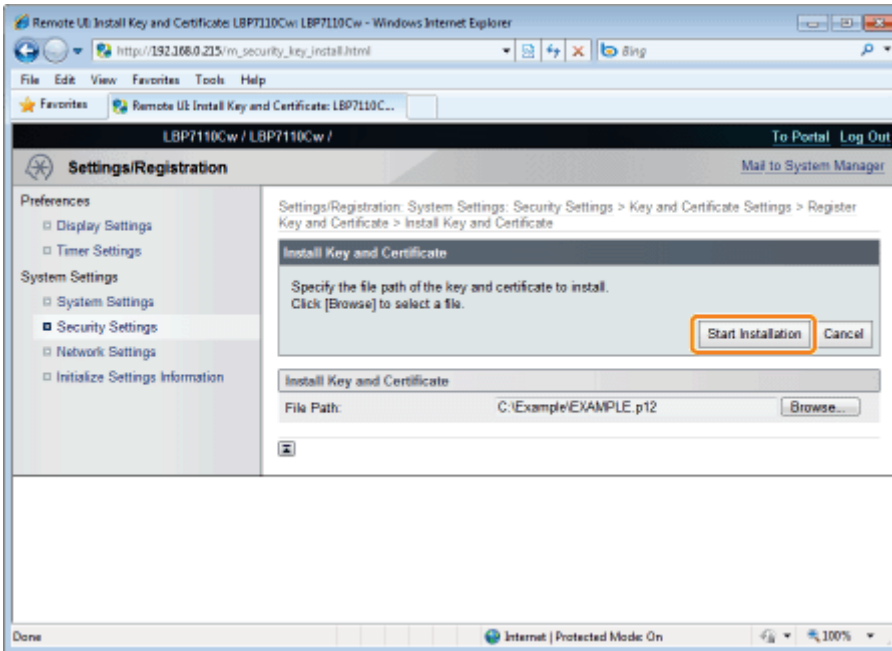

## 8

Click [Register].

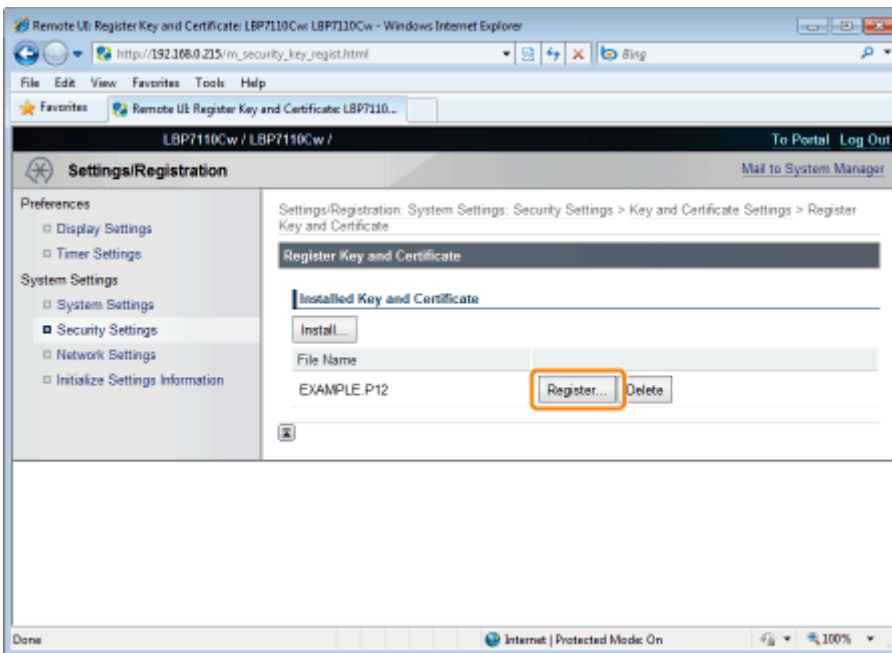

## 9

Enter the private key password of the installed key and certificate file.

(1) Enter [Key Name] and [Password].

† Up to 24 alphanumeric characters can be entered.

(2) Click [OK].



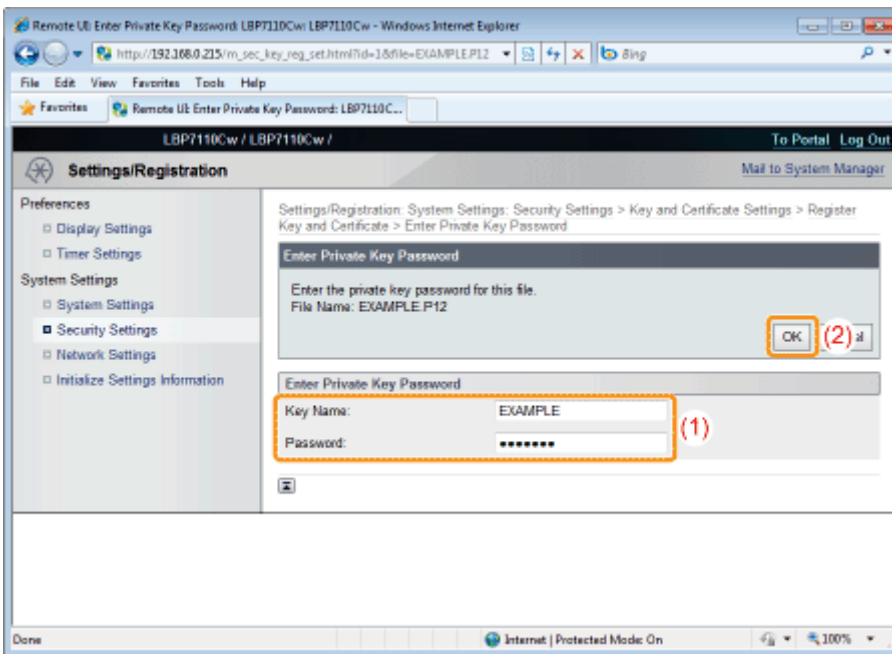

## Installing CA Certificates

1

Start the Remote UI, and then log in as Management Mode.

➤ "Starting the Remote UI"

2

Click [Settings/Registration].

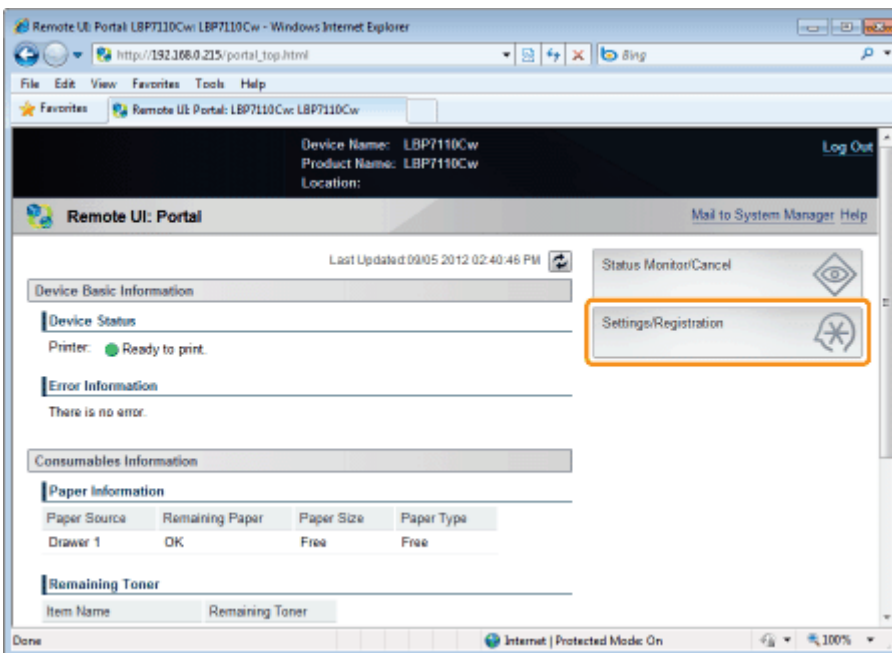

3

Display the [CA Certificate Settings] page.

- (1) Select [Security Settings].
- (2) Click [CA Certificate Settings].

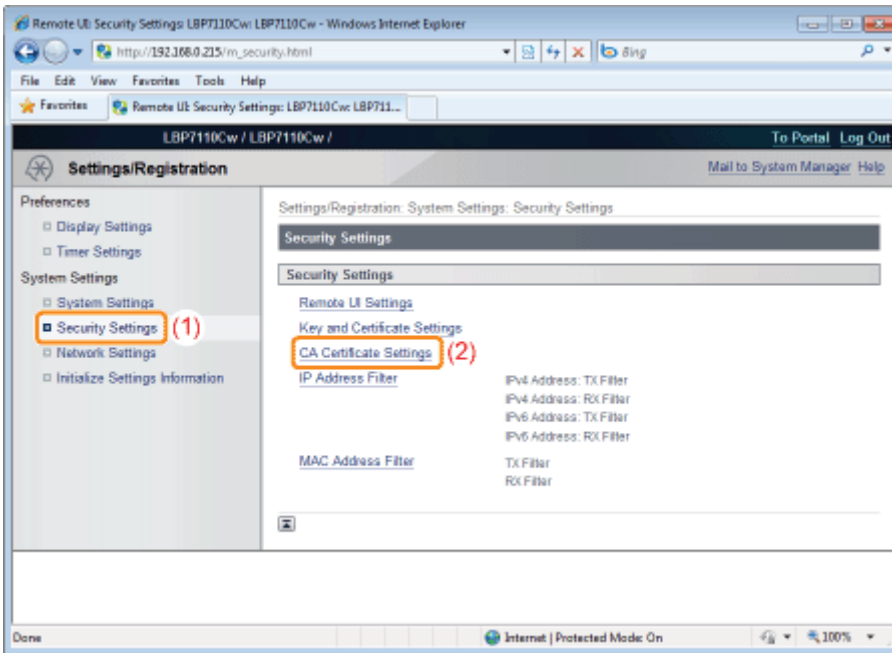

## 4

Click [Register CA Certificate].

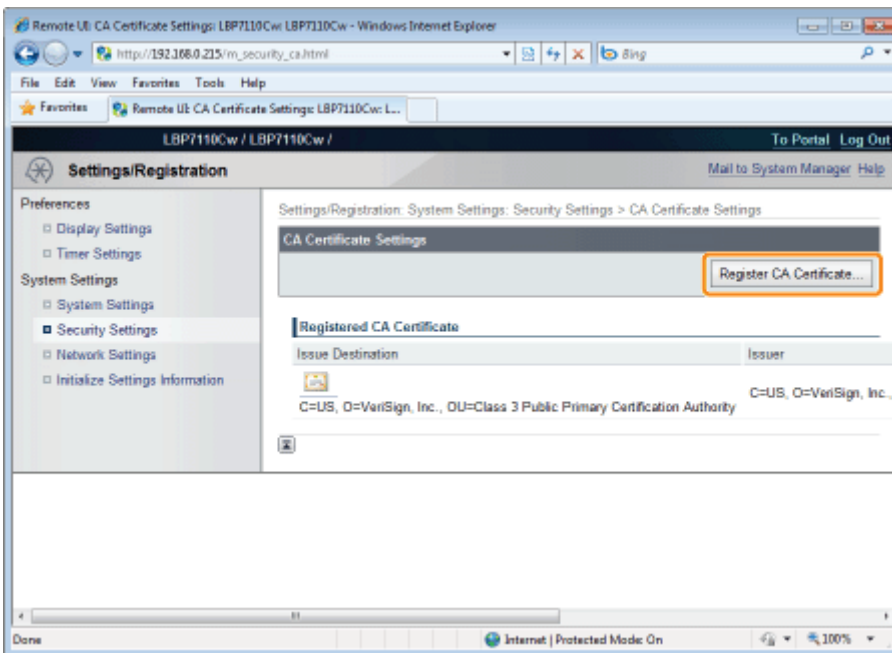

## 5

Click [Install].

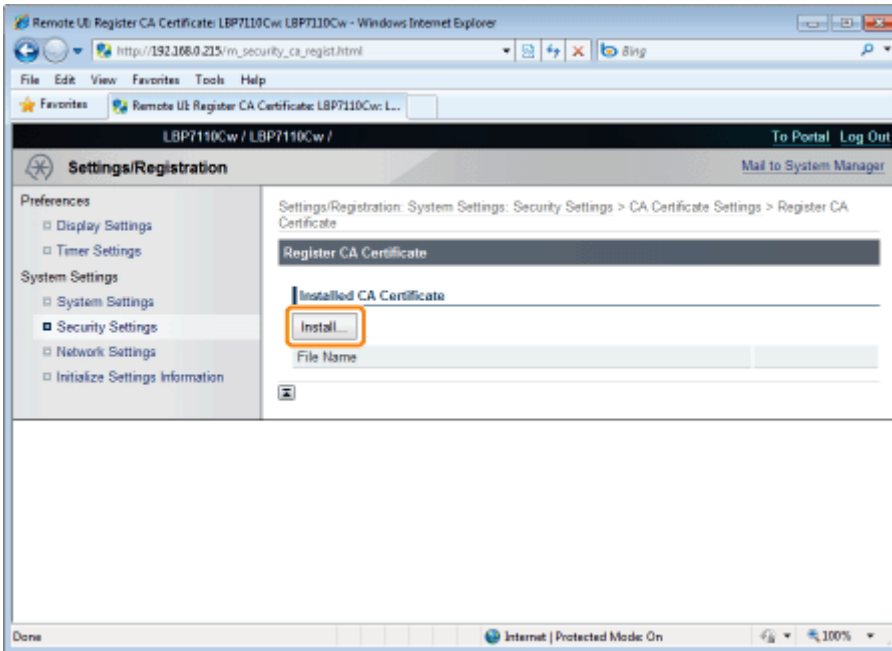

## IMPORTANT

### About the number of CA certificate files that can be installed

Only one file can be installed.

If a CA certificate file is already installed, click [Delete], and then delete the installed file.

## 6

Click [Browse], and then select a CA certificate file to install.

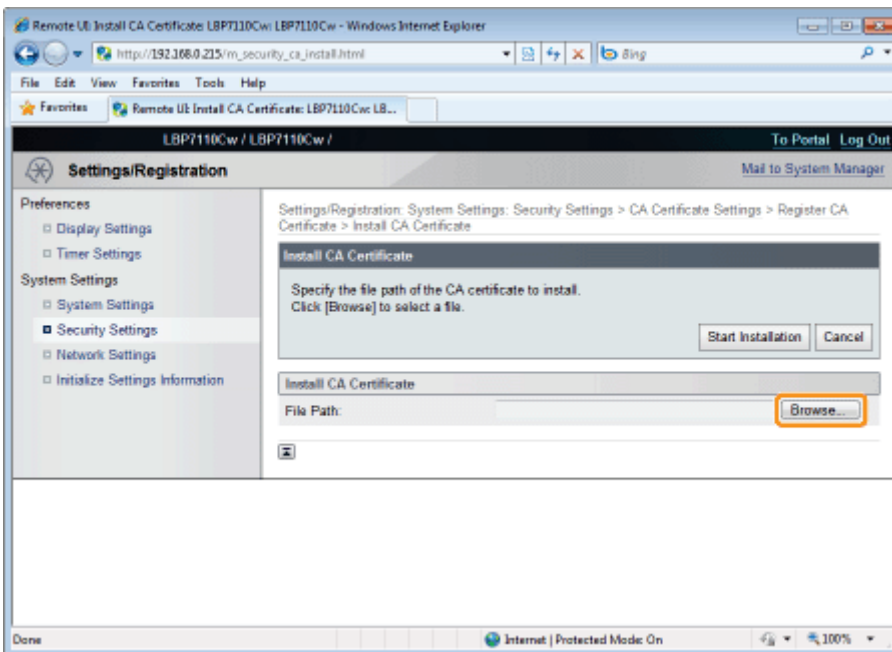

## 7

Click [Start Installation].

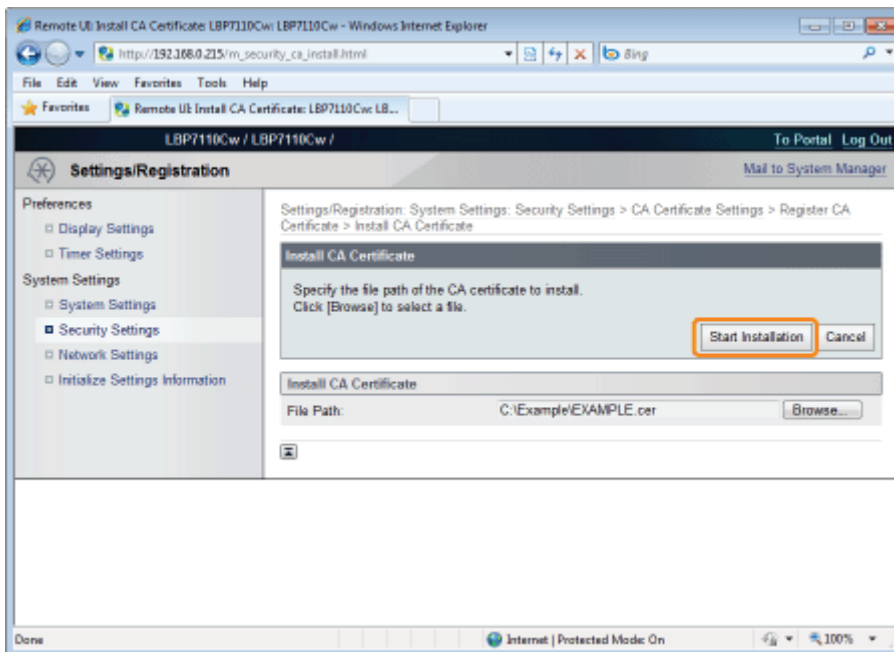

## 8

Click [Register].

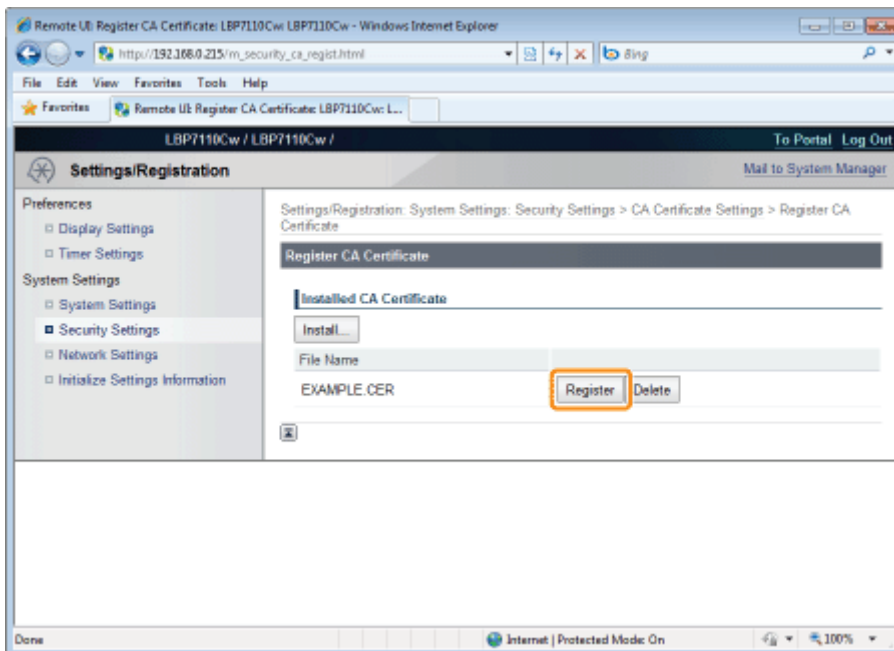

# Checking Keys and Certificates/CA Certificates

You can check contents of keys and certificates or CA certificates, and verify whether the certificate is correctly registered.

- ❖ Checking Keys and Certificates
- ❖ Checking CA Certificates

## Checking Keys and Certificates

### 1

Start the Remote UI, and then log in as Management Mode.

- ❖ "Starting the Remote UI"

### 2

Click [Settings/Registration].

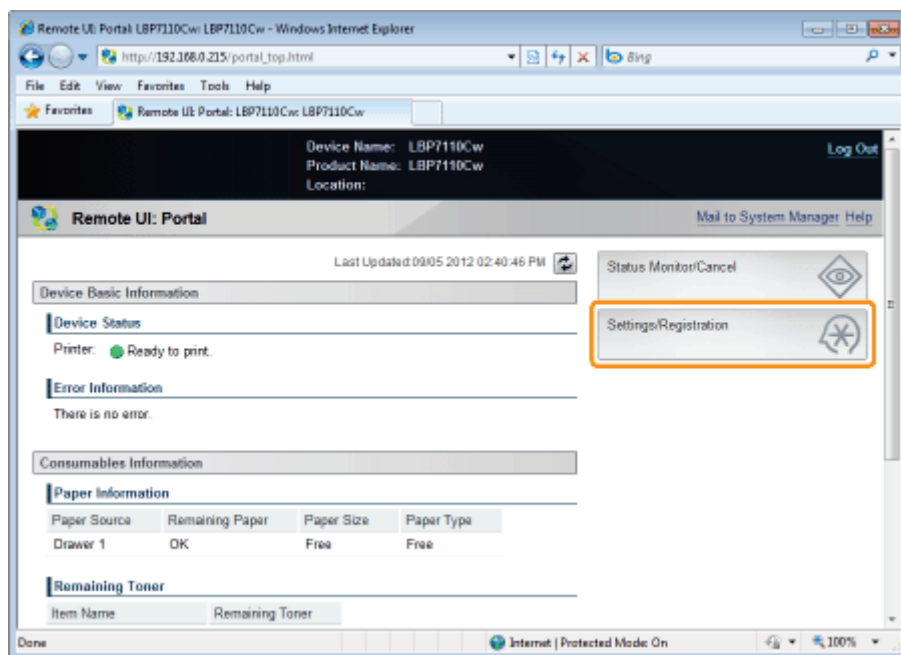

### 3

Display the [Key and Certificate Settings] page.

- (1) Select [Security Settings].
- (2) Click [Key and Certificate Settings].

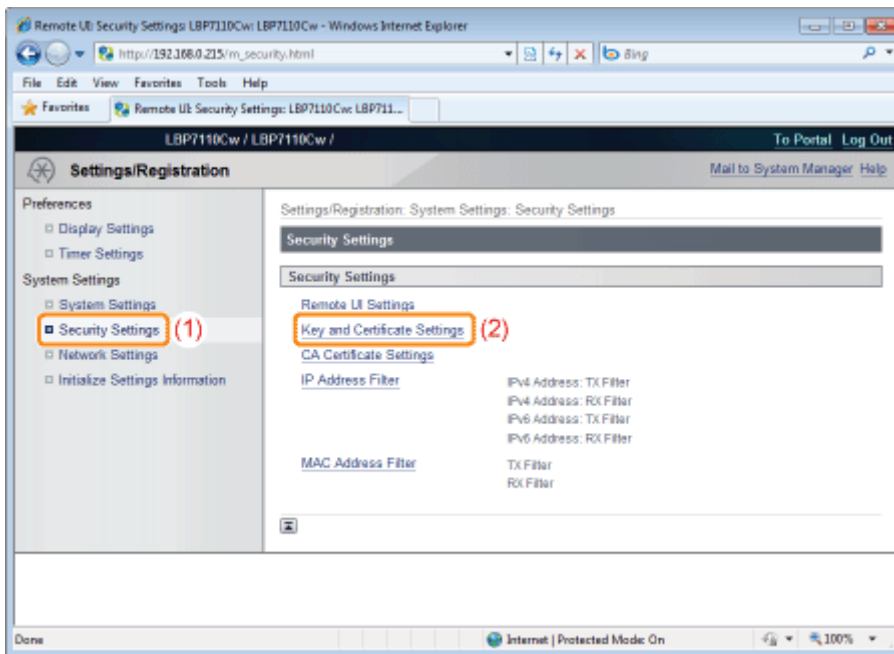

4

Click [  ] (Certificate) of the key which you want to check.

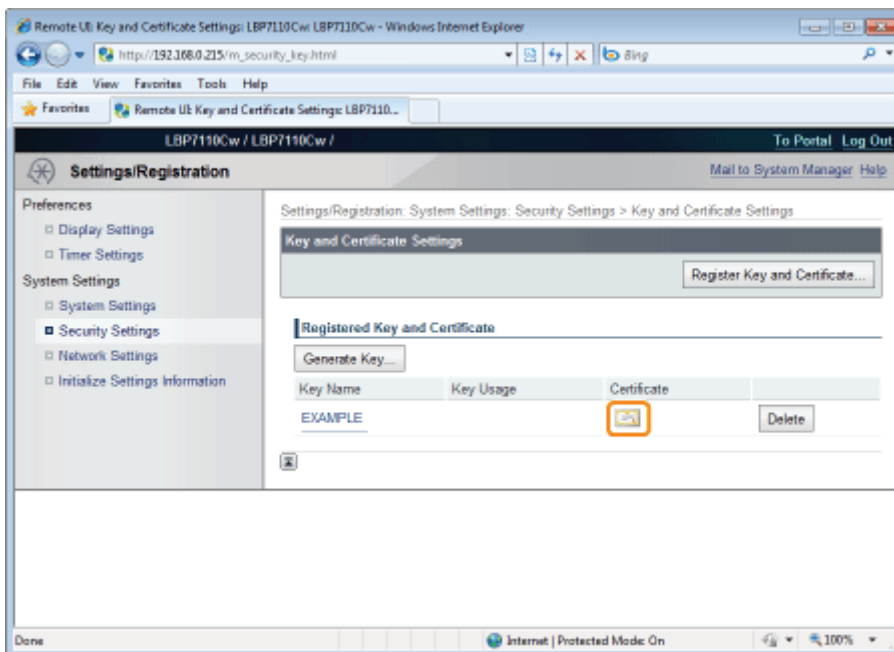

5

If you want to verify the certificate, click [Certificate Verification].

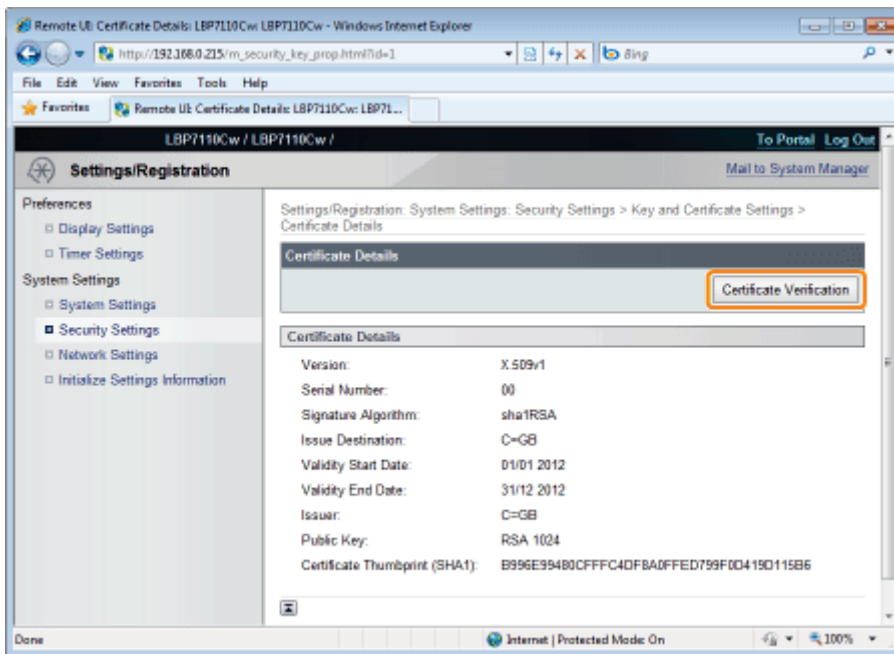

## 6

Check the verification result, and then click **[Back to Certificate Details]**.

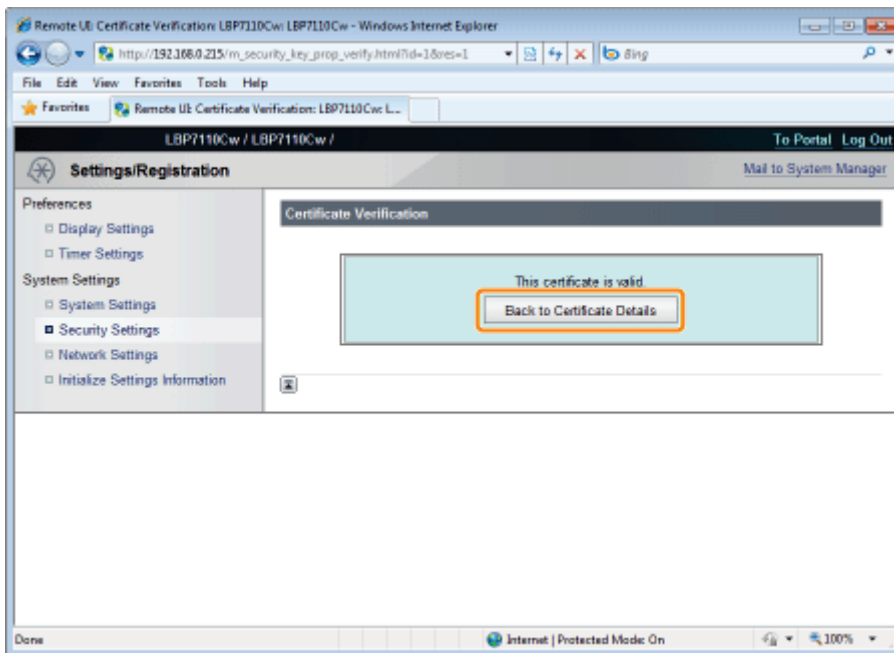

## Checking CA Certificates

### 1

Start the Remote UI, and then log in as Management Mode.

➤ "Starting the Remote UI"

### 2

Click **[Settings/Registration]**.

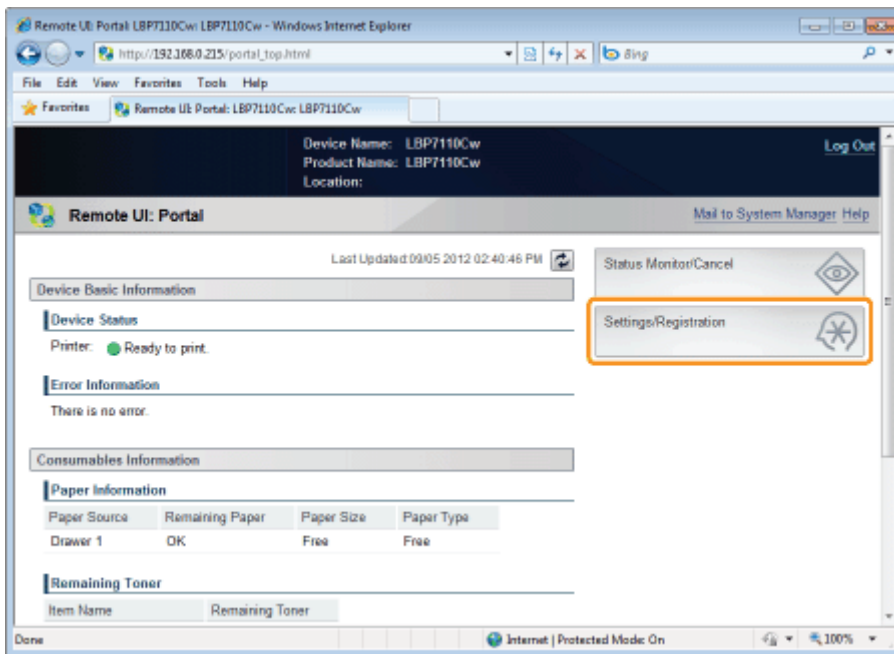

### 3

Display the [CA Certificate Settings] page.

- (1) Select [Security Settings].
- (2) Click [CA Certificate Settings].

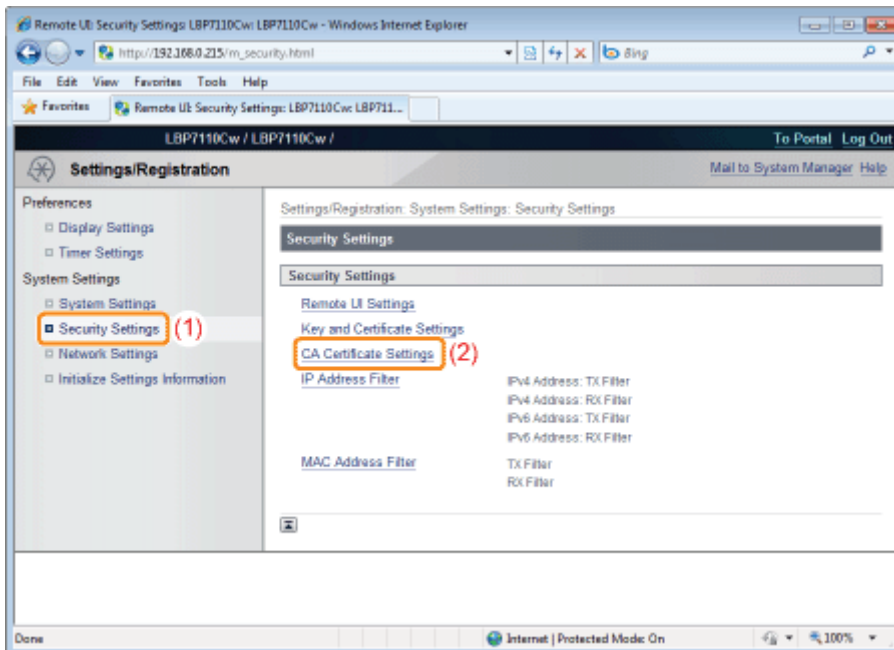

### 4

Click [  ] (Certificate) of the CA certificate which you want to check.



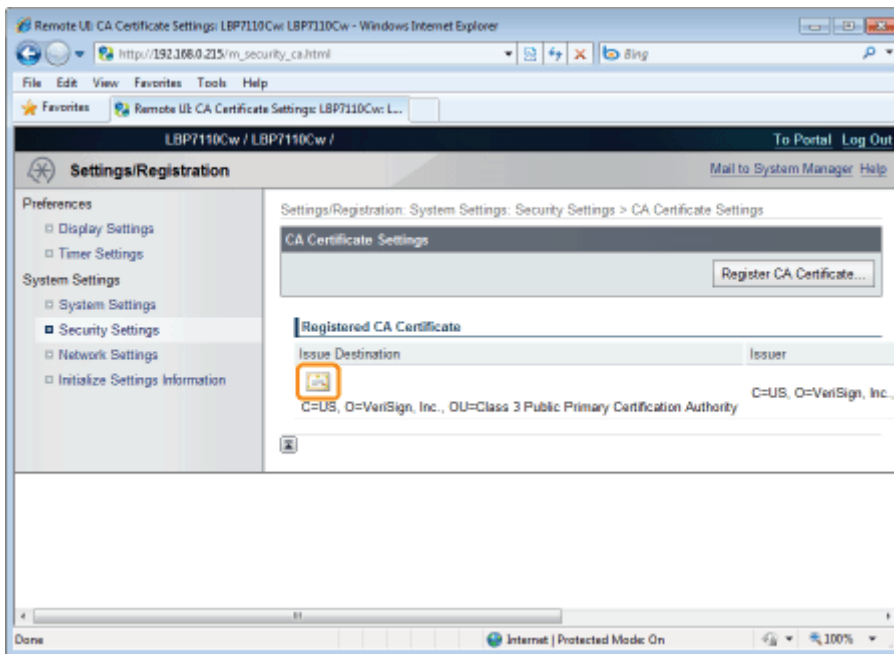

**5**  
If you want to verify the certificate, click [Certificate Verification].

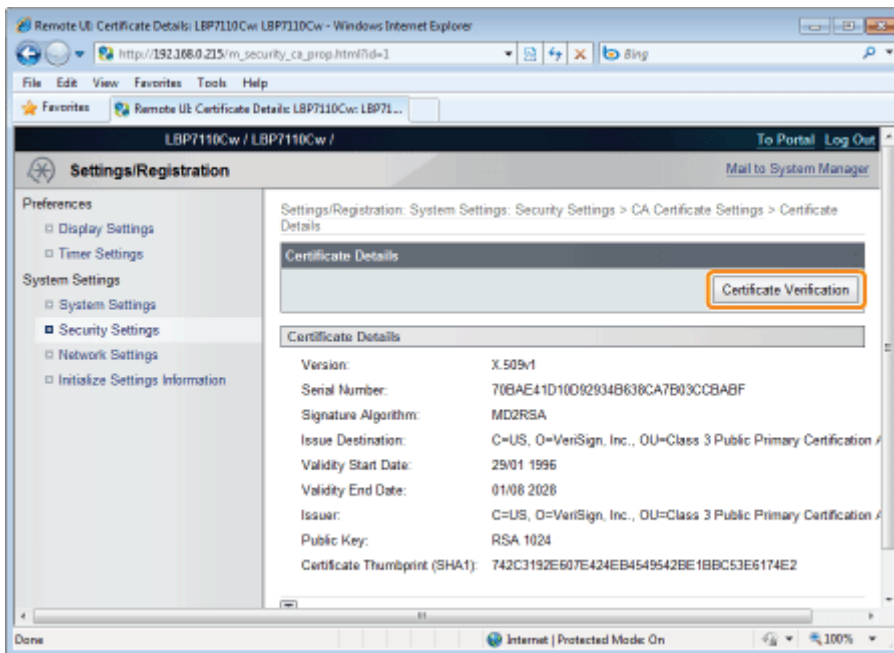

**6**  
Check the verification result, and then click [Back to Certificate Details].

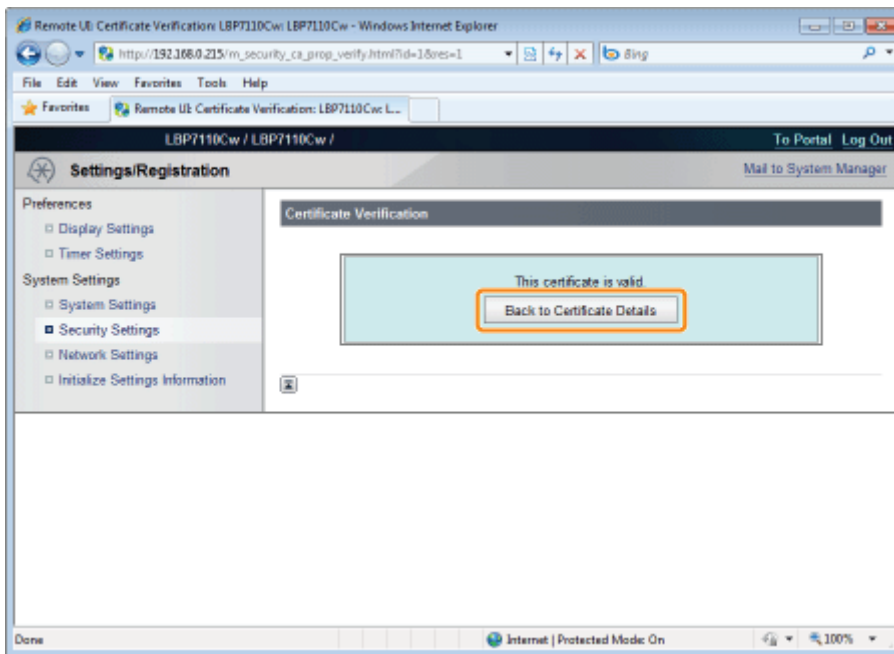

# Deleting Keys and Certificates/CA Certificates

Delete created or installed (registered) keys and certificates/CA certificates.

- ❖ Deleting Keys and Certificates
- ❖ Deleting CA Certificates

## NOTE

### About initialization of keys and certificates/CA certificates

You can reset the keys and certificates as well as CA certificates to the default state.

- ❖ "Initializing Keys and Certificates/CA Certificates"

## Deleting Keys and Certificates

### 1

Start the Remote UI, and then log in as Management Mode.

- ❖ "Starting the Remote UI"

### 2

Click [Settings/Registration].

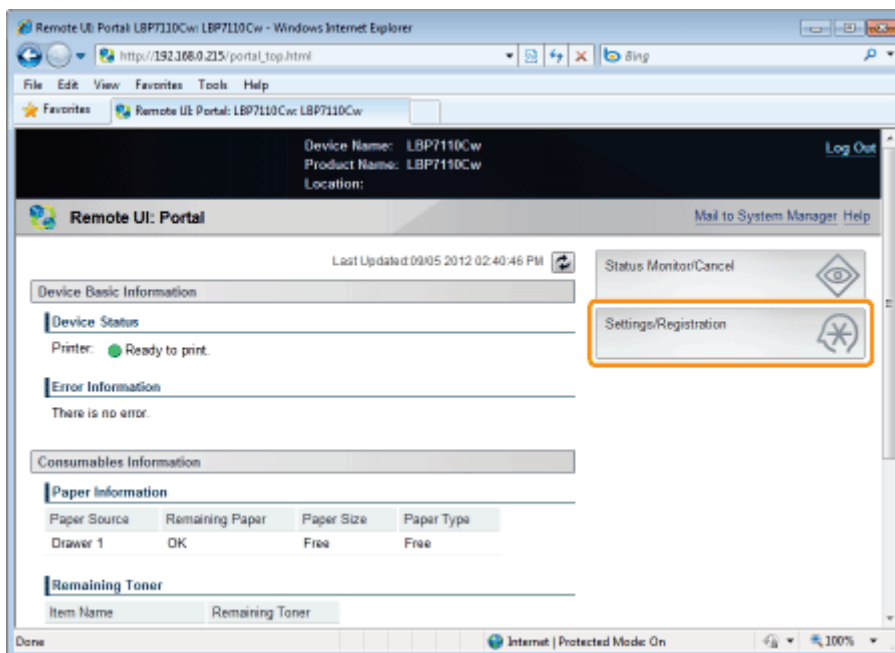

### 3

Display the [Key and Certificate Settings] page.

- (1) Select [Security Settings].
- (2) Click [Key and Certificate Settings].

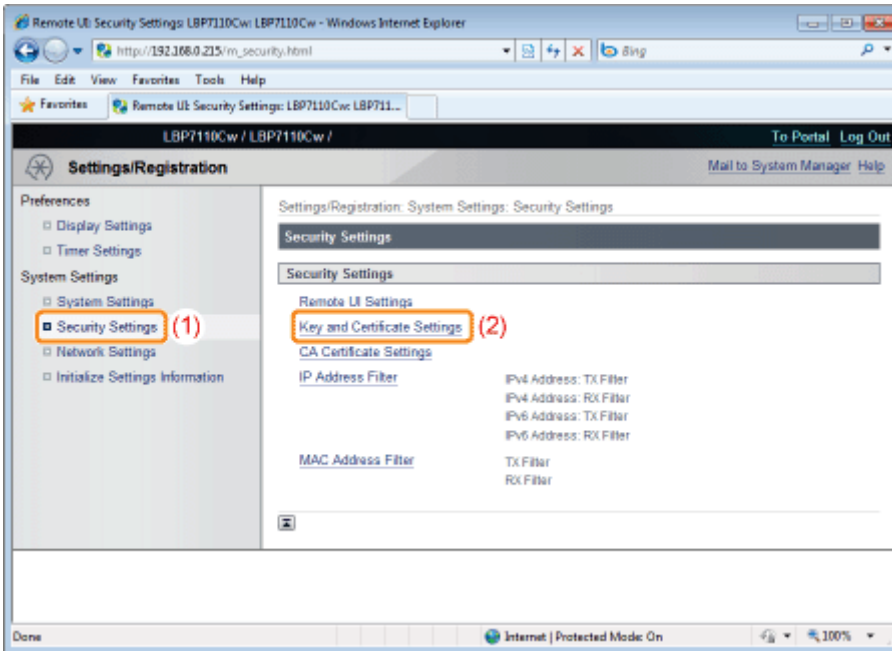

## 4

Click **[Delete]** for the key and certificate which you want to delete.

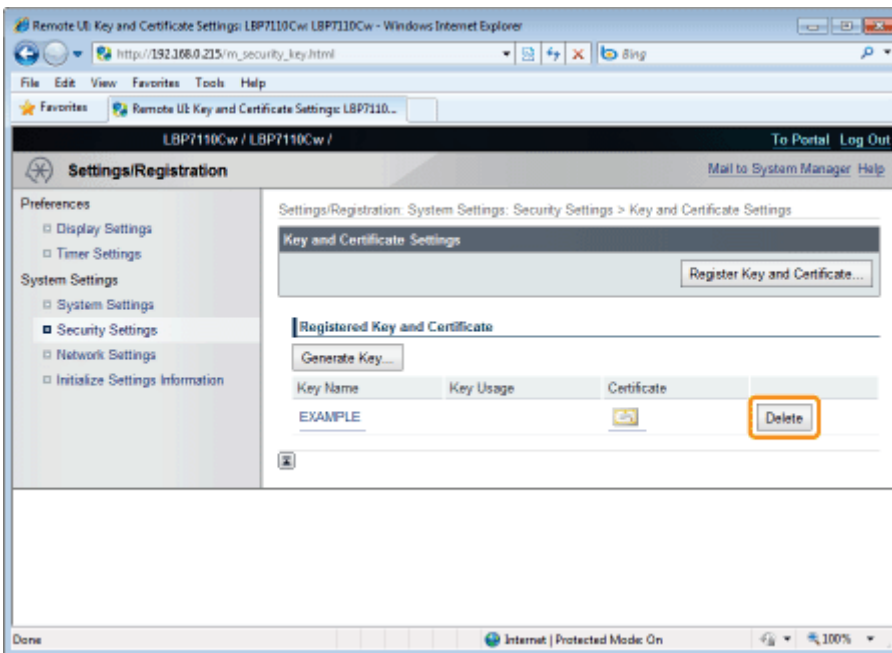

### **[Delete]** is not displayed.

[Delete] is not displayed for the keys and certificates which are used in SSL encrypted communication or IEEE 802.1X authentication.

## 5

Click **[OK]** to delete the key and certificate.

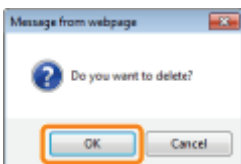

## Deleting CA Certificates

### 1

Start the Remote UI, and then log in as Management Mode.

➤ "Starting the Remote UI"

### 2

Click [Settings/Registration].

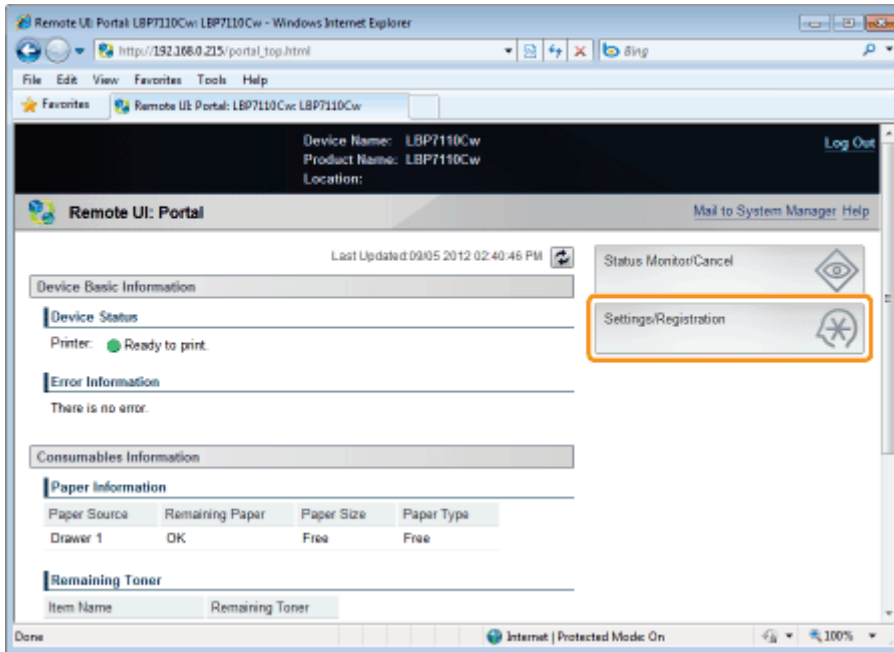

### 3

Display the [CA Certificate Settings] page.

- (1) Select [Security Settings].
- (2) Click [CA Certificate Settings].

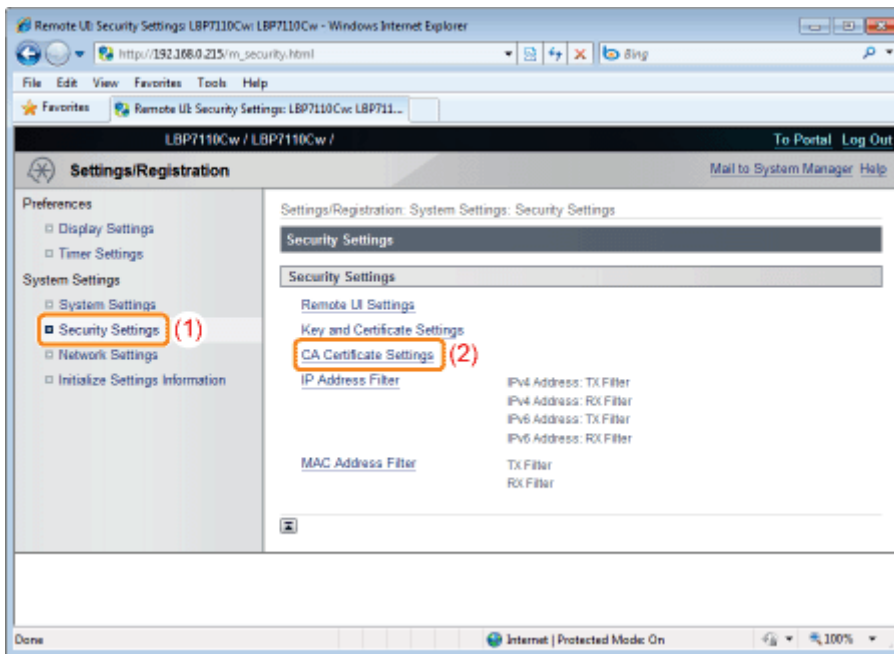

## 4

Click **[Delete]** for the CA certificate which you want to delete.

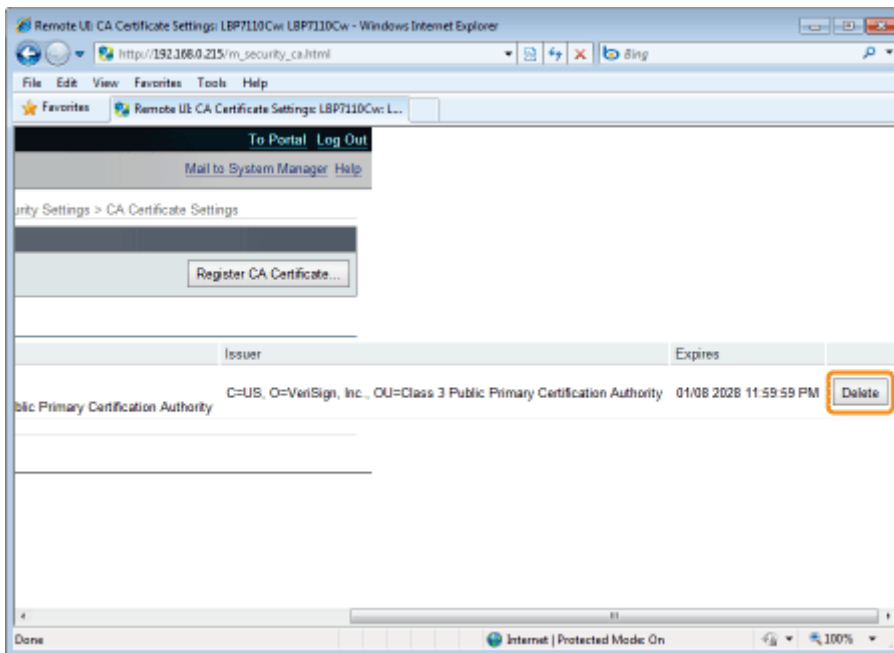

**[Delete]** is not displayed.

[Delete] is not displayed for the CA certificates which are used in IEEE 802.1X authentication.

## 5

Click **[OK]** to delete the CA certificate.

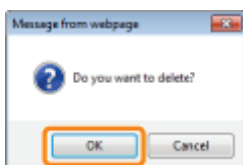

# Initializing Keys and Certificates/CA Certificates

Reset the key and certificate/CA certificate to the following default values.

Key and certificate	None (all have been deleted)
CA certificate	1 (CA certificate pre-installed by default)

## IMPORTANT

### About SSL encrypted communication and IEEE 802.1X authentication after initialization

Initializing the key and certificate/CA certificate sets the following items to off.

- [Security Settings] - [Remote UI Settings] - [Use SSL]
- [Network Settings] - [IEEE 802.1X Settings] - [Use IEEE 802.1X]

## 1

**Start the Remote UI, and then log in as Management Mode.**

➤ "Starting the Remote UI"

## 2

**Click [Settings/Registration].**

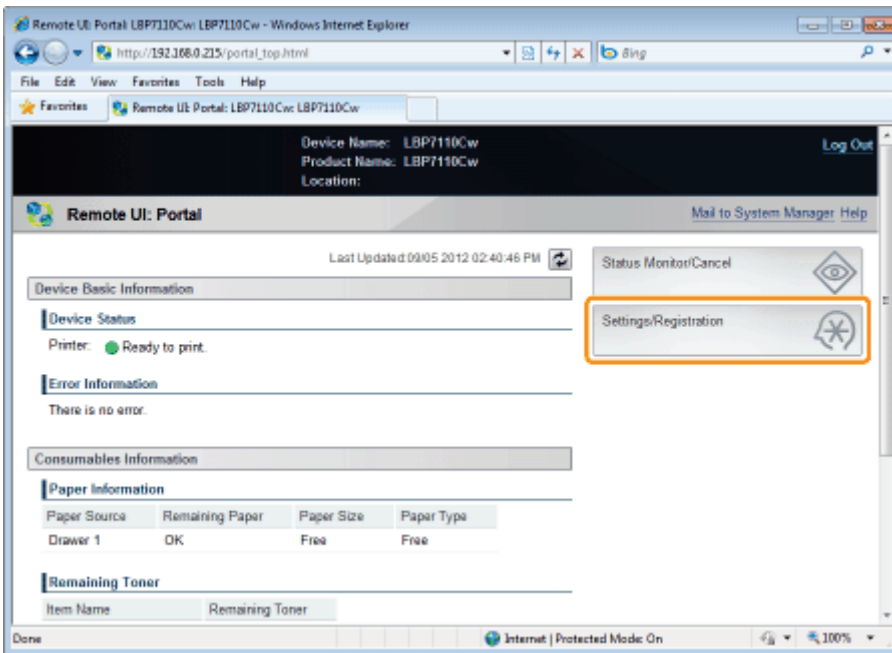

## 3

**Display the [Initialize Key and Certificate] page.**

- (1) Select [Initialize Settings Information].
- (2) Click [Initialize Key and Certificate].

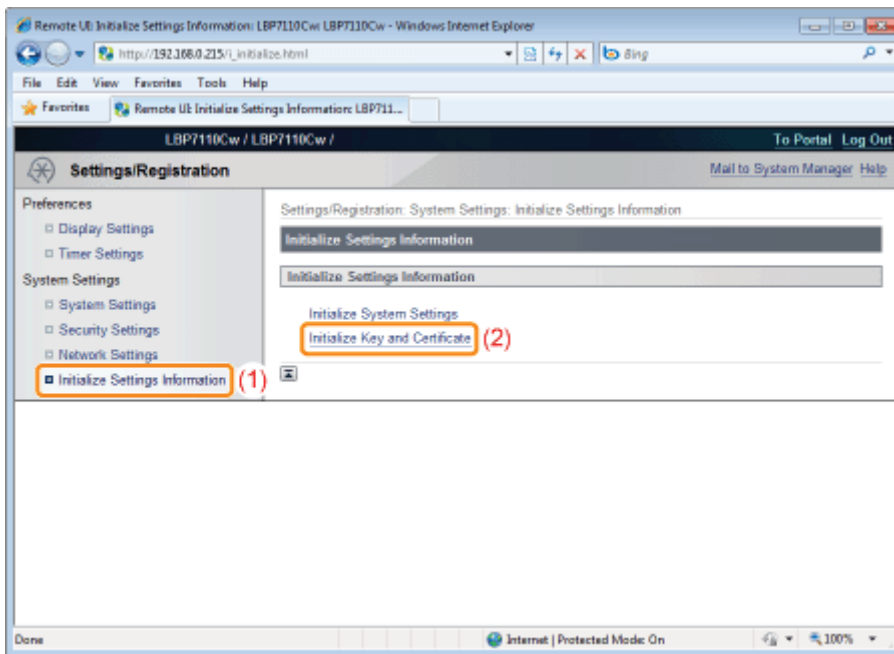

4

Click [Initialize].

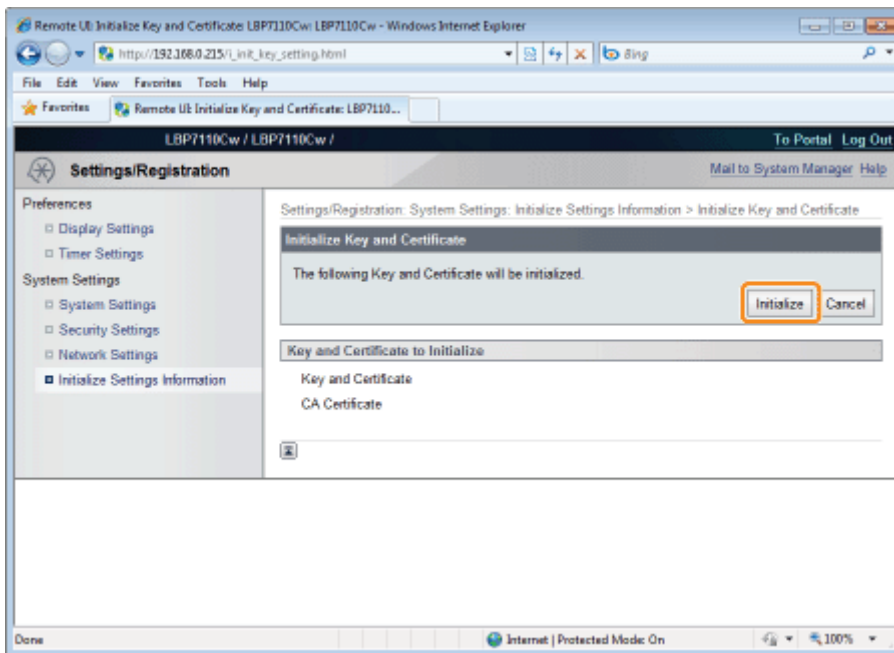

5

Click [OK] to initialize the key and certificate/CA certificate.





# Setting the SSL Encrypted Communication Function

Specify the settings for using the SSL encrypted communication function in this printer.

Before specifying the settings, see "Attention (SSL Encrypted Communication)."

- ❖ Selecting Keys and Certificates
- ❖ Enabling the SSL encrypted communication function

## Selecting Keys and Certificates

Select the key and certificate to be used for the SSL encrypted communication function.

### 1

Start the Remote UI, and then log in as Management Mode.

- ❖ "Starting the Remote UI"

### 2

Click [Settings/Registration].

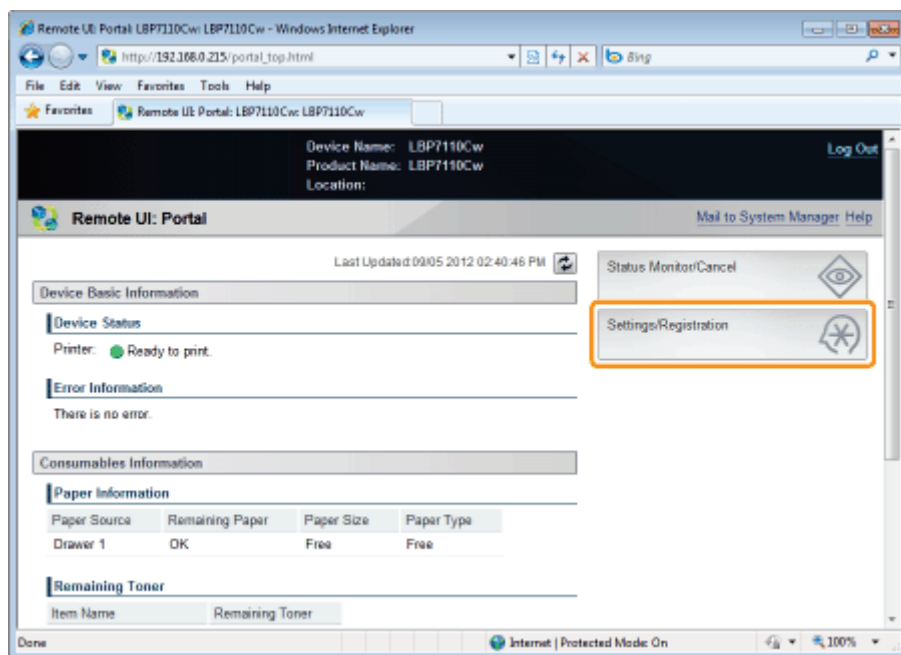

### 3

Display the [TCP/IP Settings] page.

- (1) Select [Network Settings].
- (2) Click [TCP/IP Settings].

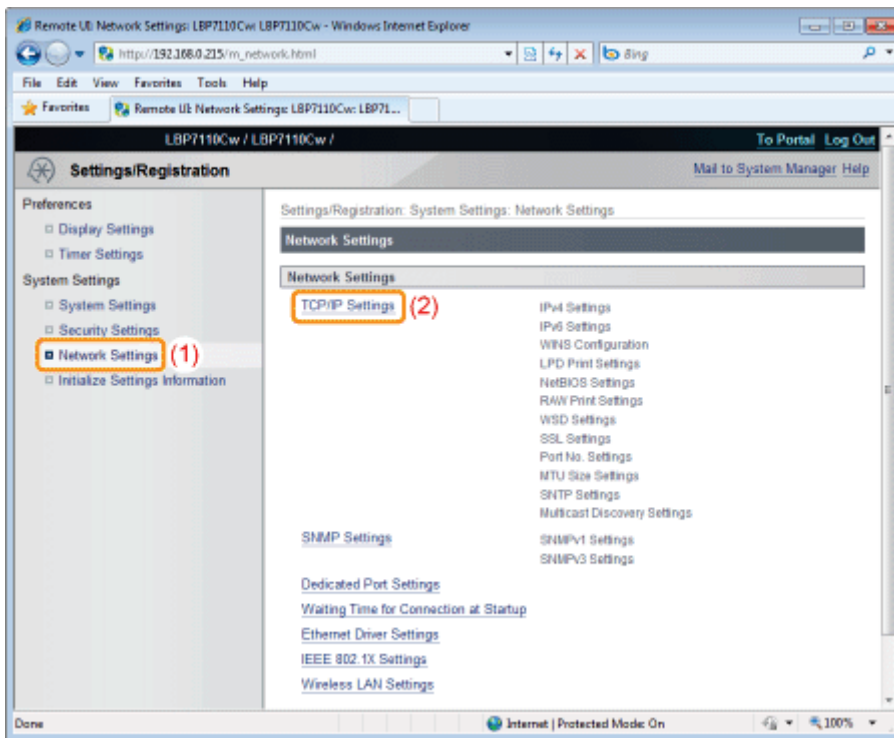

## 4

Click [Key and Certificate] in [SSL Settings].

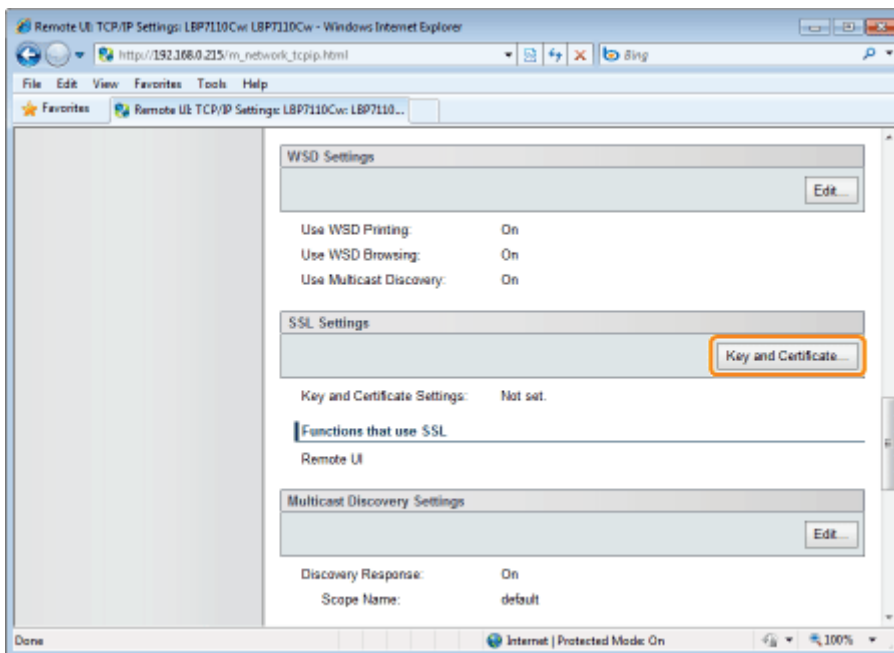

## 5

Specify a key and certificate to be used for SSL encrypted communication.

(1) Select the key to use from a list of registered keys and certificates.

- † When you click [  ] (Certificate), you can check and verify detailed information of certificates.
  - ❖ "Checking Keys and Certificates/CA Certificates"

(2) Click [Default Key Settings].

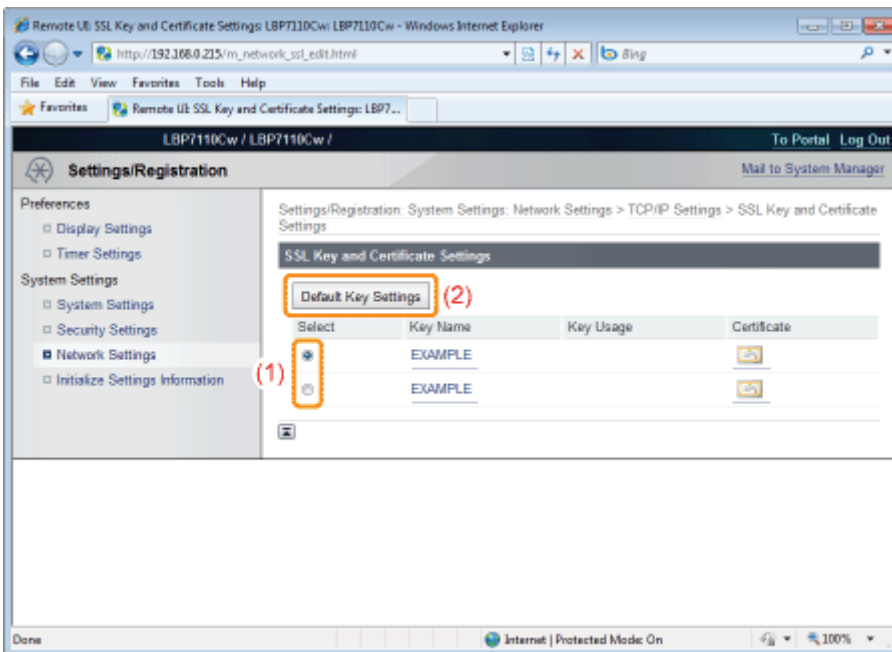

## Enabling the SSL encrypted communication function

Specify the settings to enable the SSL encrypted communication function to be used, for example, when you use the remote UI.

### 1

Display the [Remote UI Settings] page.

- (1) Select [Security Settings].
- (2) Click [Remote UI Settings].

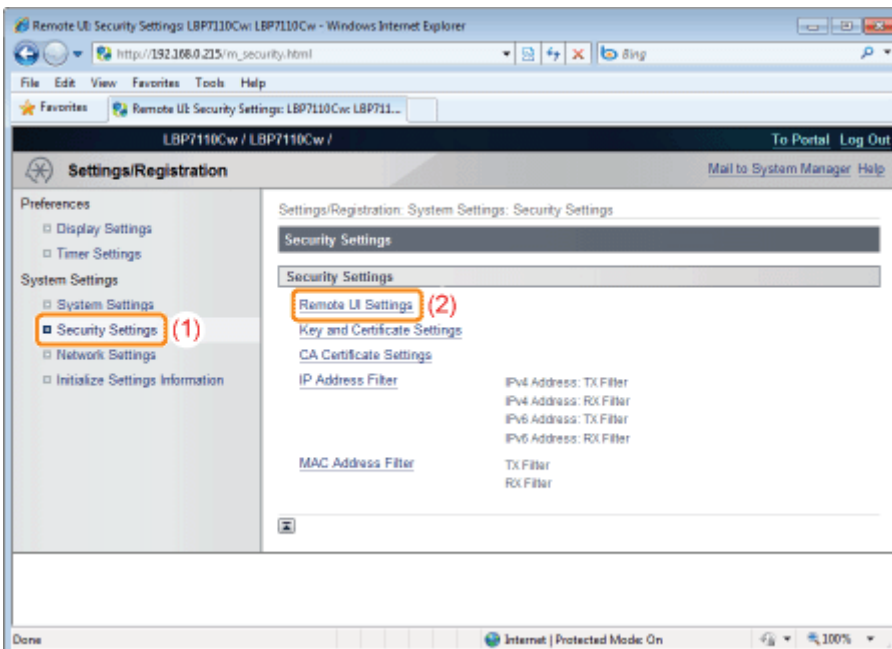

### 2

Click [Edit].

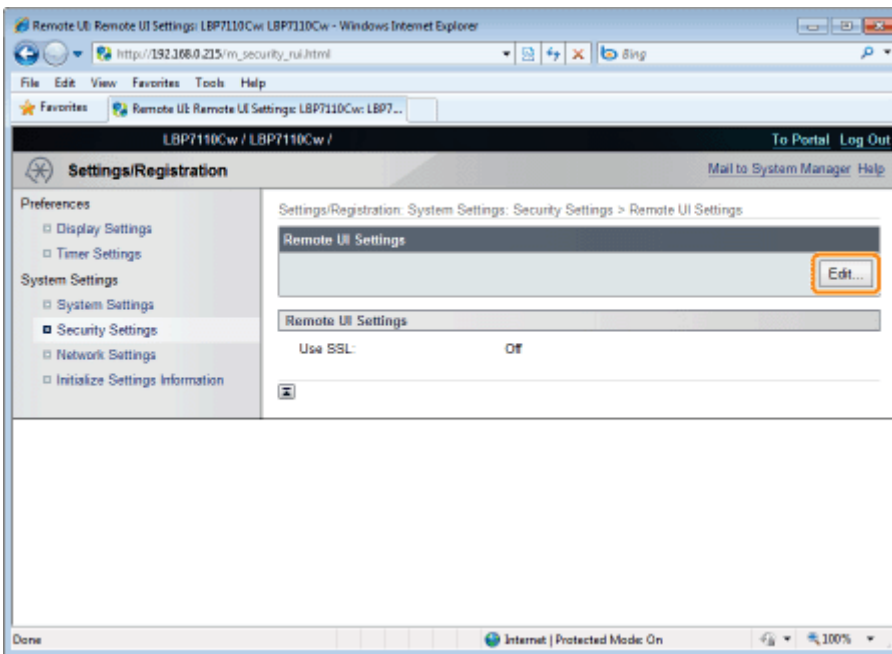

### 3

#### Enable the SSL encrypted communication function.

(1) Select the [Use SSL] check box.

↑ Clearing the check box disables the SSL encrypted communication function.

(2) Click [OK].

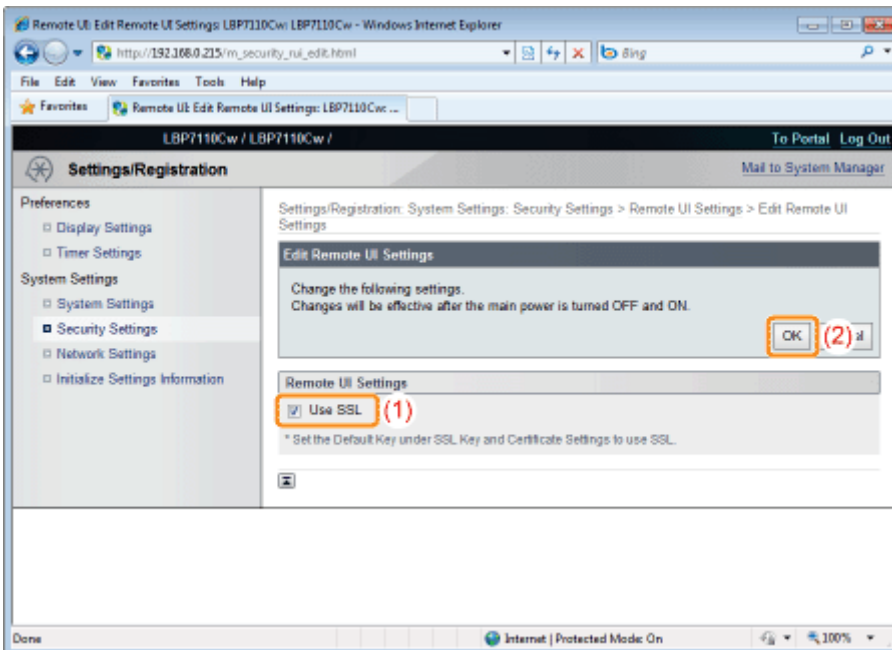

### 4

#### Restart the printer.

Turn the printer OFF, make sure that the Main Power indicator is off, wait for 10 seconds or longer, and then turn it ON again.

→ After the printer is restarted, the settings become effective.

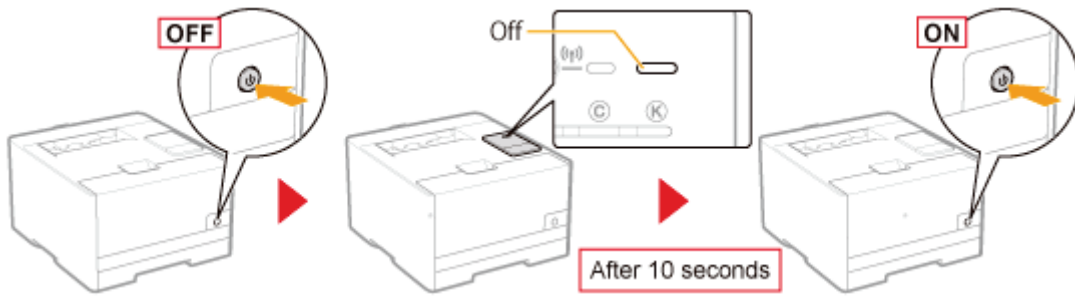

## Attention (SSL Encrypted Communication)

### IMPORTANT

#### When using the SSL encrypted communication function

Specify the time information for the printer.

† You can obtain the time information using either of the following methods.

- Notifying the printer of the time information using the NTP server (Specifying SNTP)
  - "Other Protocol Settings"
- Notifying the printer of the time set on the computer using the following procedure
  1. Display the Printer Status Window.
    - "Printer Status Window"
  2. Select [Preferences (Administrators)] from the [Options] menu.
  3. Select the [Notify the Printer of the Time] check box.

### NOTE

#### SSL encrypted communication function

This function encrypts data between the printer and your computer, for example, when using the Remote UI to manage the printer with a Web browser. The SSL encrypted communication function can prevent data from being stolen or tampered, thereby enabling a safer management environment.

#### To specify SSL encrypted communication

You need to specify keys and certificates to be used for SSL encrypted communication.

- "Specifying Keys and Certificates/CA Certificates"

# Setting IEEE 802.1X Authentication

Specify various protocols (TLS, TTLS, or PEAP) for IEEE 802.1X authentication.

Before specifying the settings, see "Attention (IEEE 802.1X Authentication)."

- Setting TLS Authentication Information
- Setting TTLS/PEAP Authentication Information

## Setting TLS Authentication Information

Specify authentication information for using TLS during IEEE 802.1X authentication.

### IMPORTANT

#### To specify TLS authentication

You need to specify keys and their certificates or CA certificates to be used for authentication.

- "Specifying Keys and Certificates/CA Certificates"

## 1

Start the Remote UI, and then log in as Management Mode.

- "Starting the Remote UI"

## 2

Click [Settings/Registration].

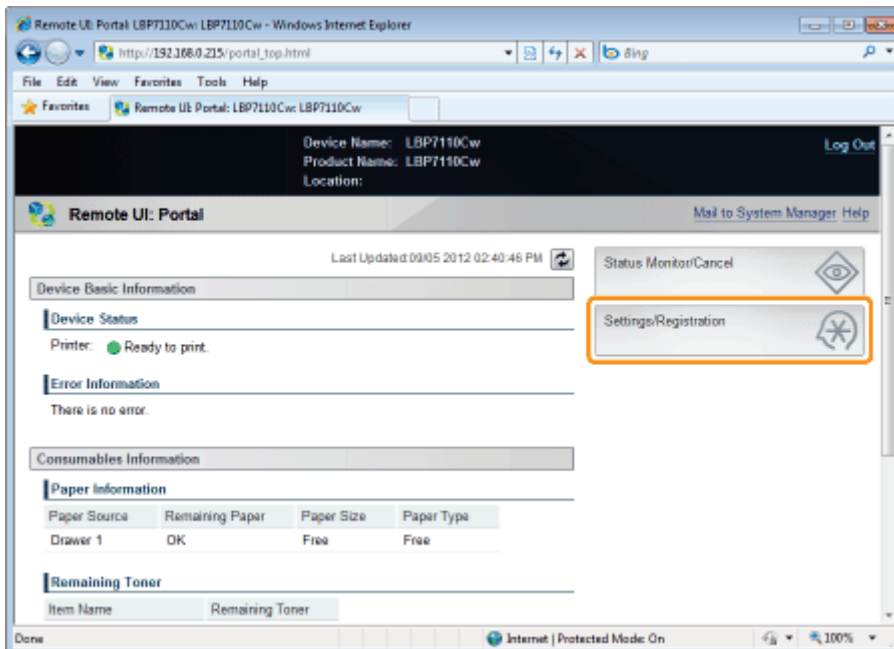

## 3

Display the [IEEE 802.1X Settings] page.

- (1) Select [Network Settings].

(2) Click [IEEE 802.1X Settings].

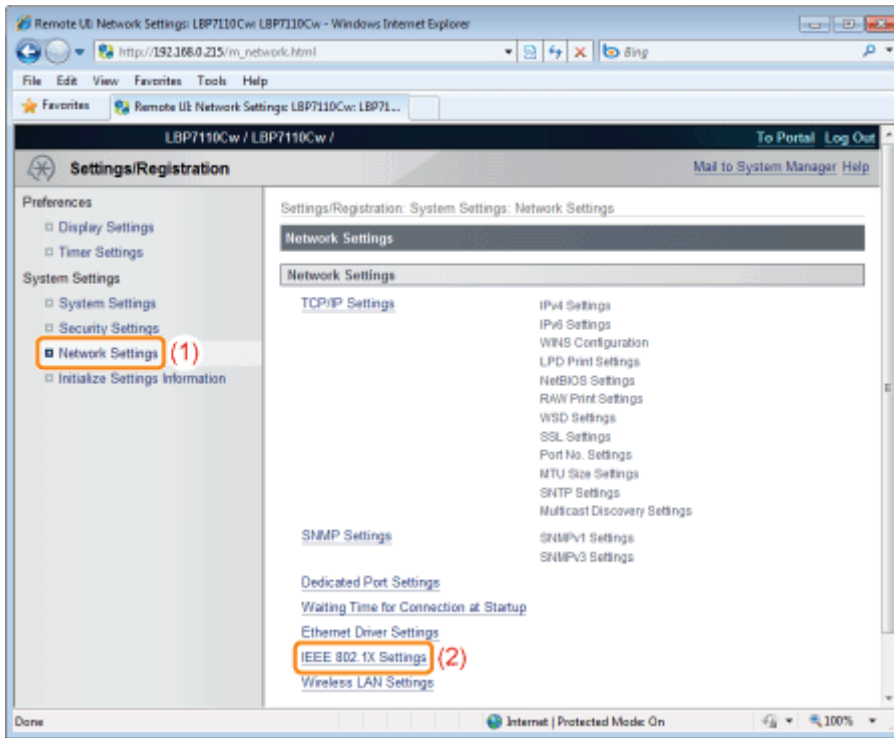

4

Click [Edit].

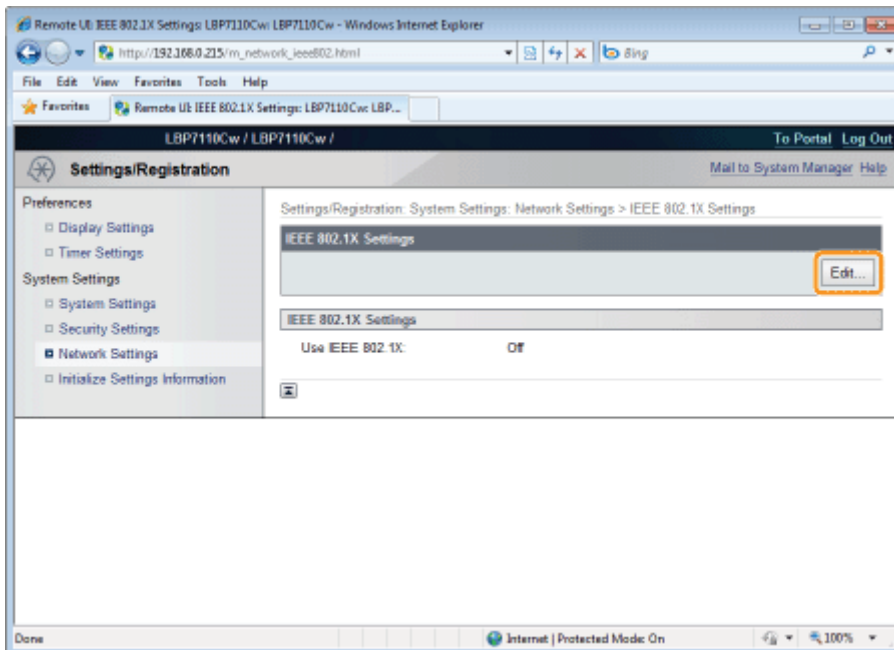

5

Select the [Use IEEE 802.1X] check box.



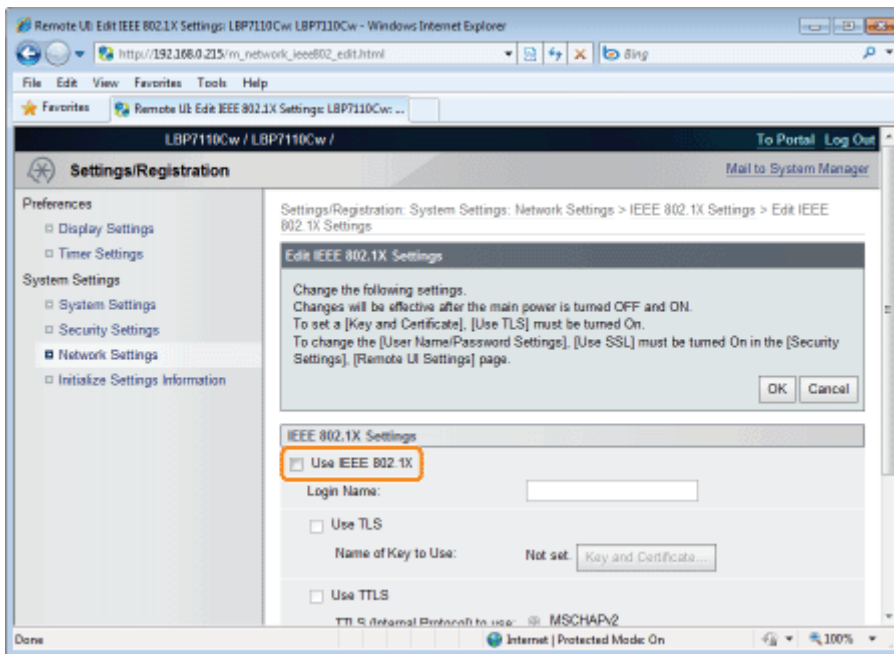

6

Enter a login name.

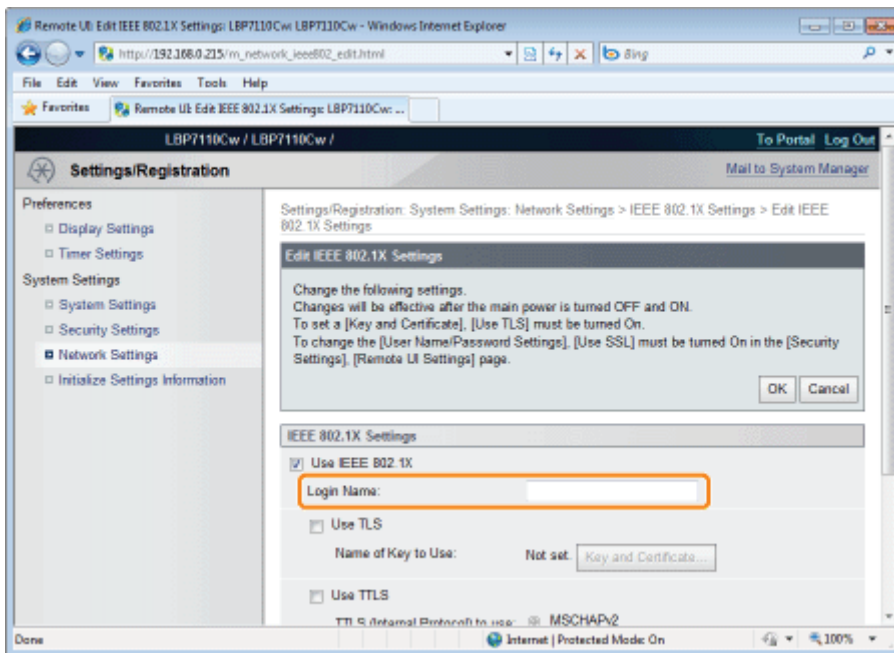

7

Select the [Use TLS] check box.

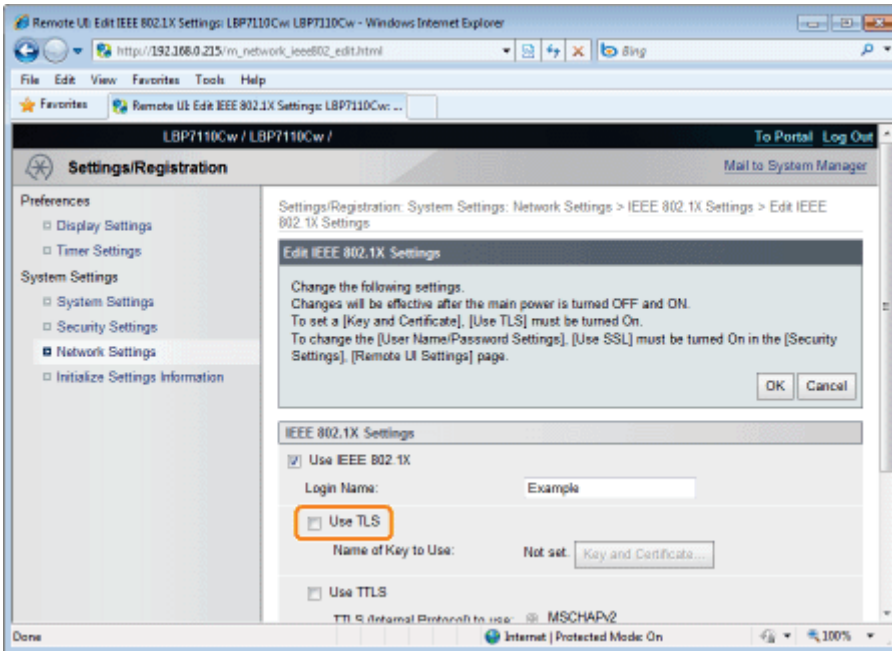

8

Click [Key and Certificate].

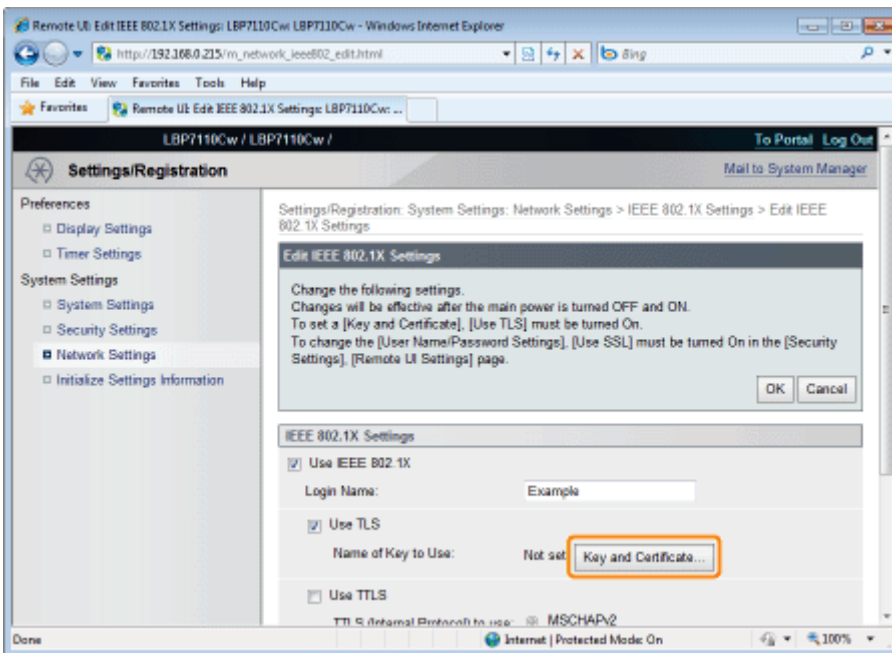

9

Specify keys and certificates to be used for authentication.

(1) Select the key to use from a list of registered keys and certificates.

- † When you click [  ] (Certificate), you can check and verify detailed information of certificates.
  - ▣ "Checking Keys and Certificates/CA Certificates"

(2) Click [Default Key Settings].

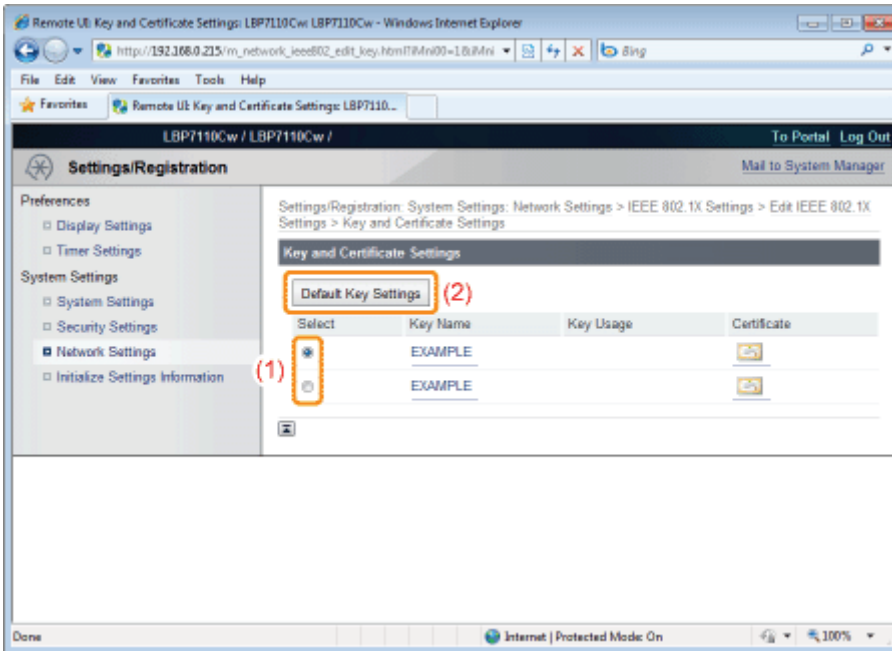

# 10

Click [OK].

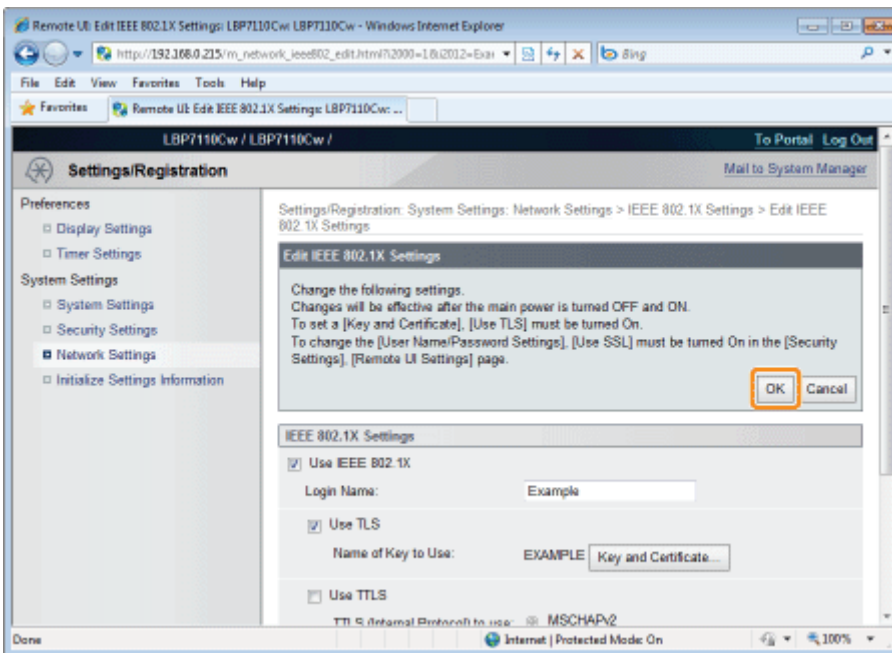

# 11

Restart the printer.

Turn the printer OFF, make sure that the Main Power indicator is off, wait for 10 seconds or longer, and then turn it ON again.

→ After the printer is restarted, the settings become effective.

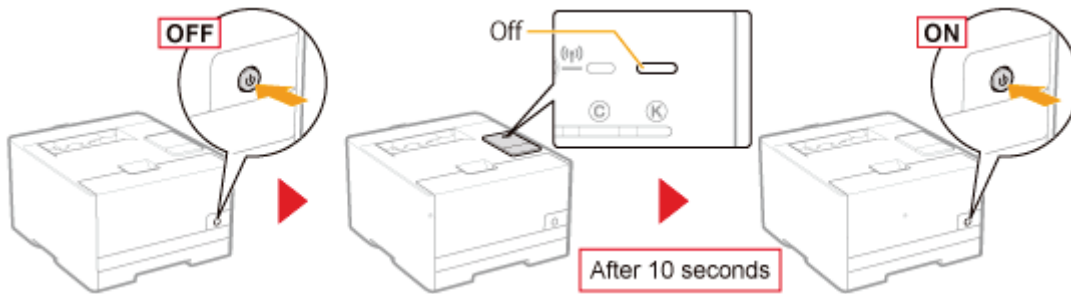

## Setting TTLS/PEAP Authentication Information

Specify authentication information for using TTLS or PEAP during IEEE 802.1X authentication.

### IMPORTANT

#### To specify TTLS/PEAP authentication

You need to specify the SSL encrypted communication function.

- "Setting the SSL Encrypted Communication Function"

## 1

**Start the Remote UI, and then log in as Management Mode.**

- "Starting the Remote UI"

## 2

**Click [Settings/Registration].**

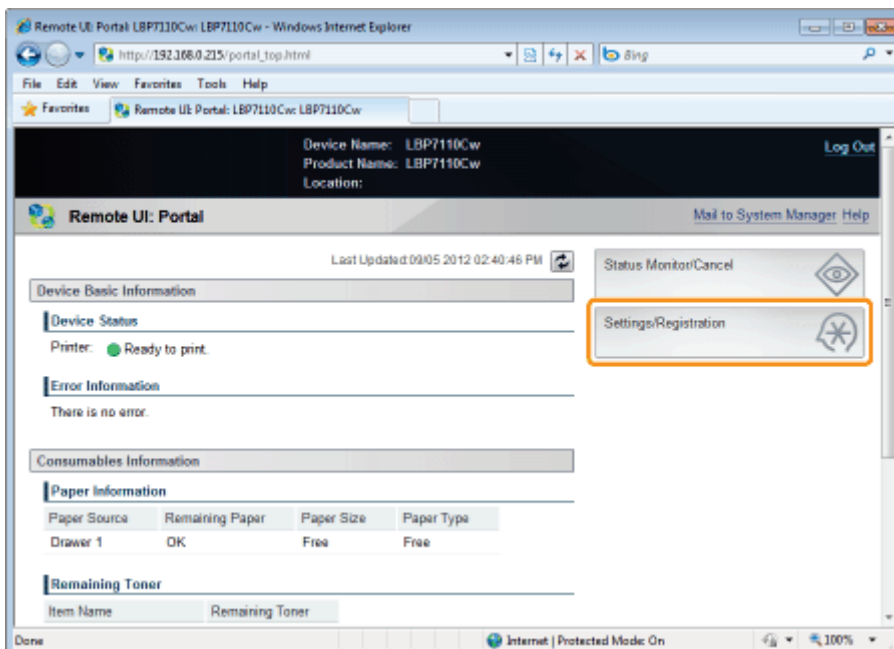

## 3

**Display the [IEEE 802.1X Settings] page.**

- (1) Select [Network Settings].
- (2) Click [IEEE 802.1X Settings].

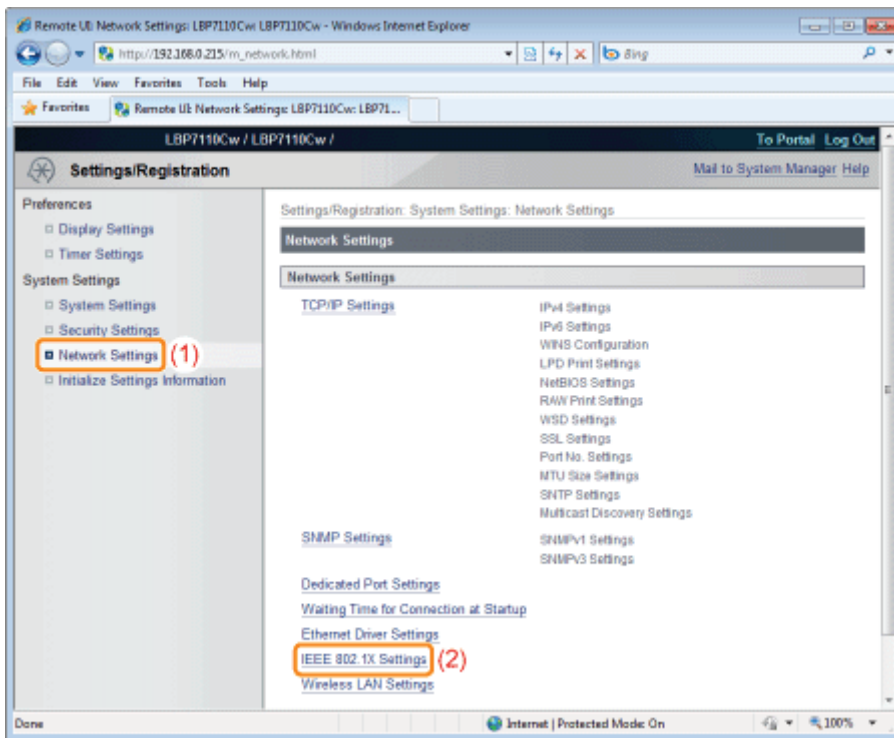

4

Click [Edit].

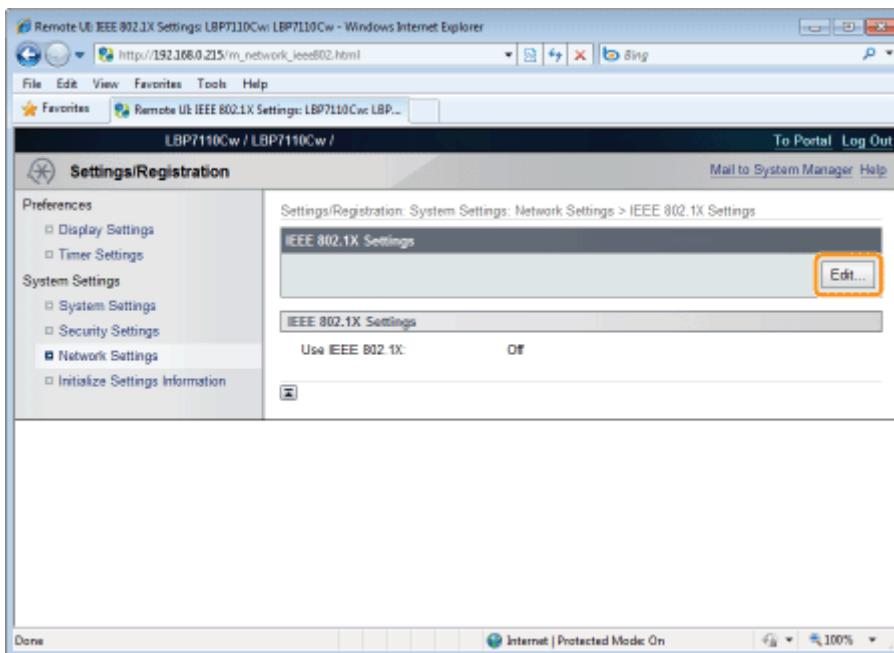

5

Select the [Use IEEE 802.1X] check box.

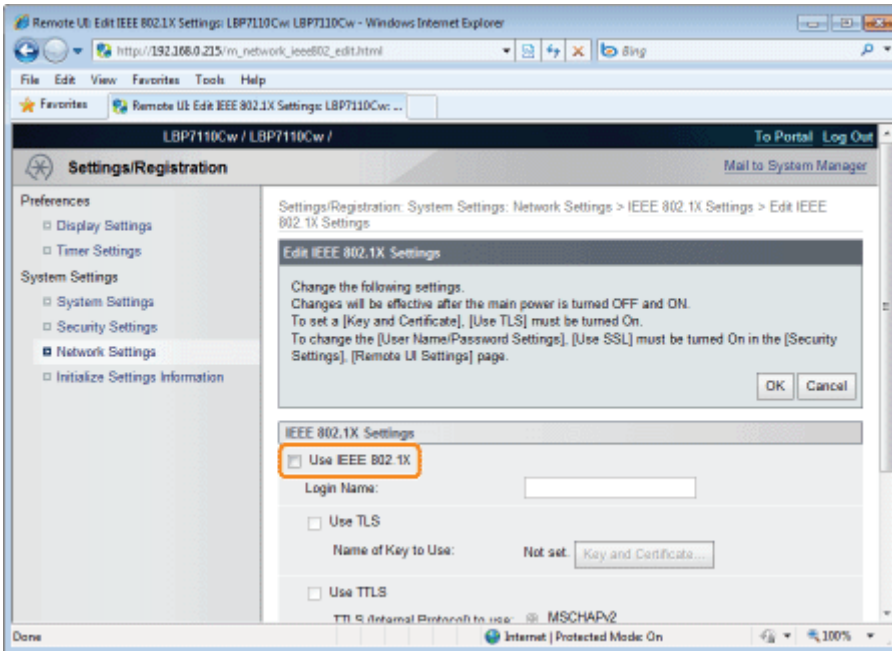

## 6

Enter a login name.

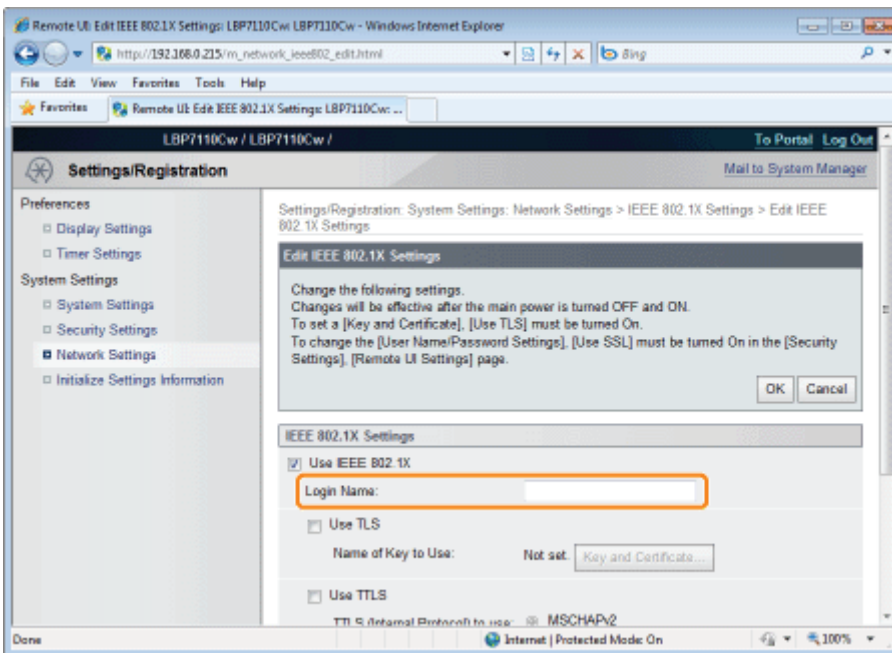

## 7

Select the [Use TTLS] or [Use PEAP] check box.

To use TTLS, select the TTLS internal protocol ([MSCHAPv2] or [PAP]).

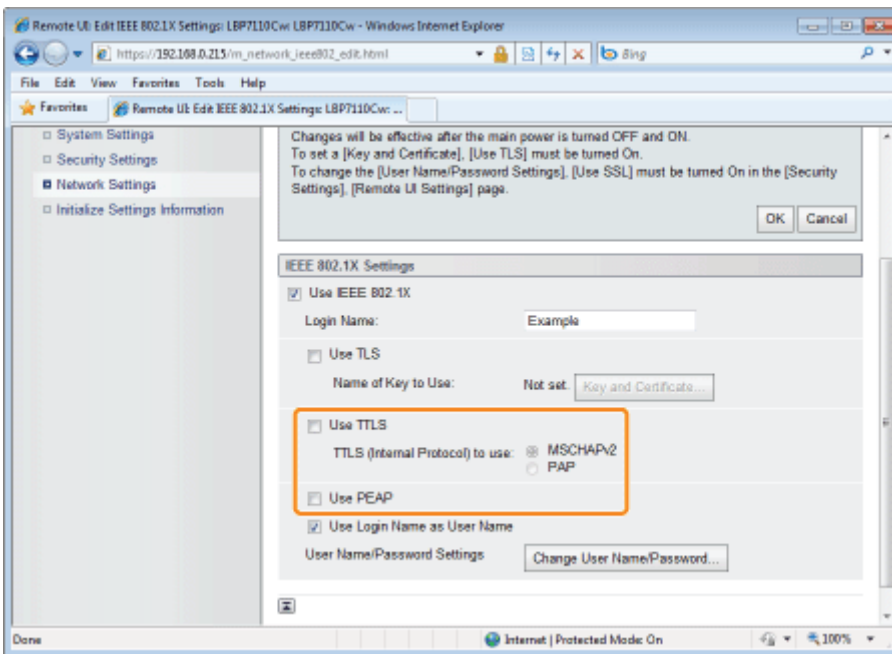

8

**Click [Change User Name/Password].**

To use the login name entered to the user name at Step 6, select the [Use Login Name as User Name] check box.

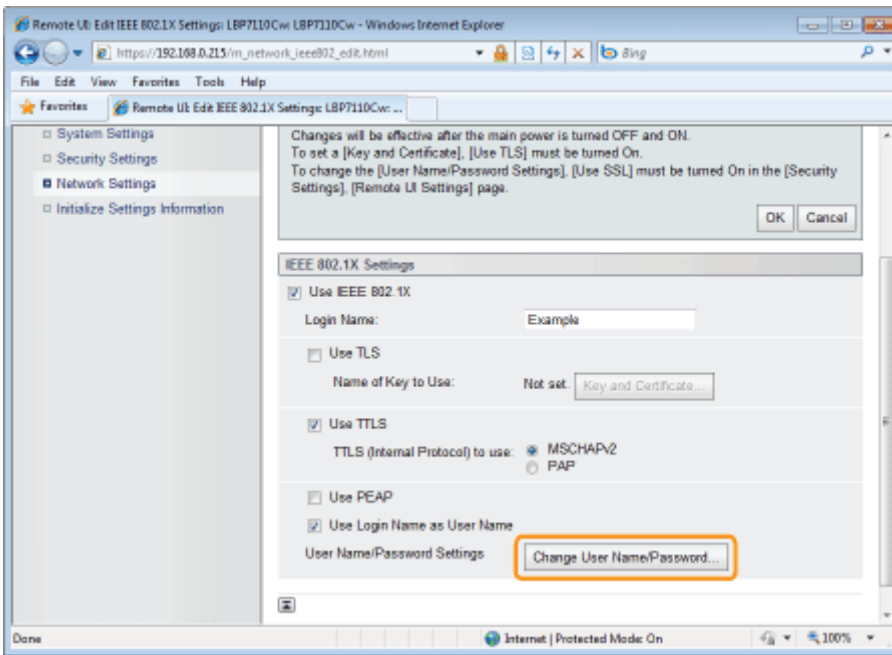

9

**Specify the user name and the password.**

- (1) Enter a user name and a password.
- (2) Click [OK].

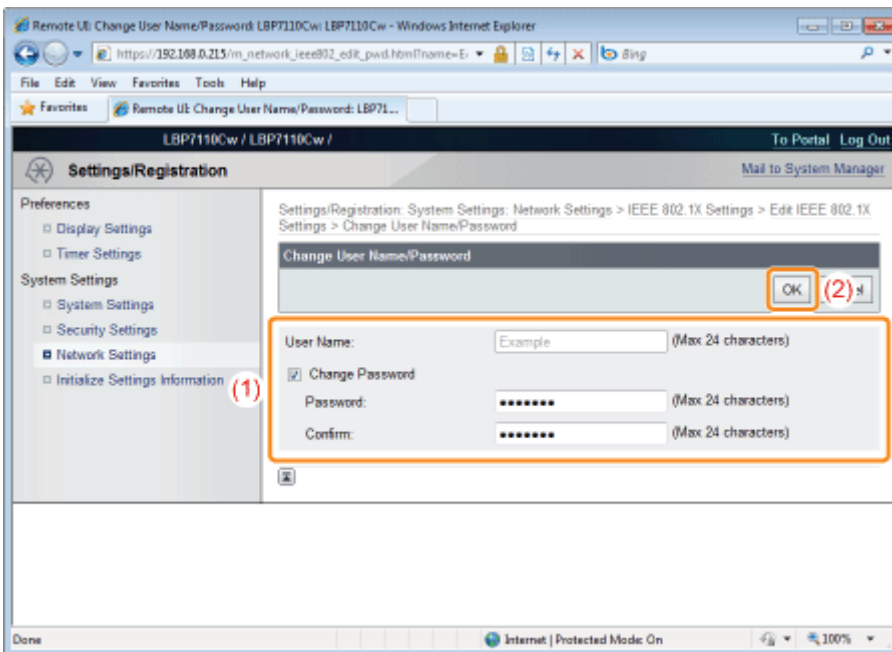

[User Name]	Enter a user name. You can enter up to 24 single-byte alphanumeric characters.
[Change Password]	Select the check box when changing the password.
[Password]	Enter a password. You can enter up to 24 single-byte alphanumeric characters.
[Confirm]	To confirm the [Password] you entered, enter it again.

## 10

**Click [OK].**

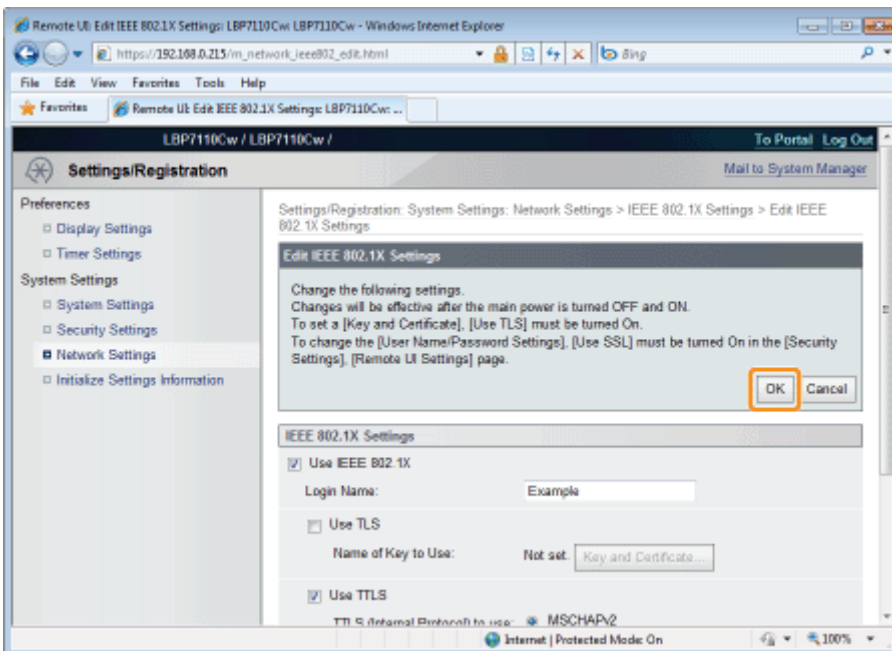

## 11

**Restart the printer.**

Turn the printer OFF, make sure that the Main Power indicator is off, wait for 10 seconds or longer, and then turn it ON again.

→ After the printer is restarted, the settings become effective.



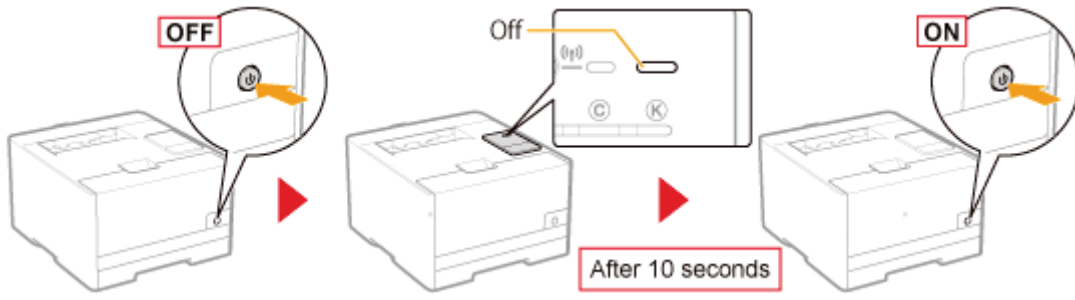

## Attention (IEEE 802.1X Authentication)

### IMPORTANT

#### Conditions for using IEEE 802.1X authentication

- In this printer, IEEE 802.1X authentication is available only in wired LAN environments.
- To use IEEE 802.1X authentication, you need an authentication server (RADIUS Server).

#### When using IEEE 802.1X authentication

Specify the time information for the printer.

† You can obtain the time information using either of the following methods.

- Notifying the printer of the time information using the NTP server (Specifying SNTP)
  - "Other Protocol Settings"
- Notifying the printer of the time set on the computer using the following procedure
  1. Display the Printer Status Window.
    - "Printer Status Window"
  2. Select [Preferences (Administrators)] from the [Options] menu.
  3. Select the [Notify the Printer of the Time] check box.

### NOTE

#### IEEE 802.1X authentication protocol

- This printer supports TLS, TTLS, and PEAP for IEEE 802.1X authentication.
- TLS implements cross certification between a certificate sent from an authentication server and a certificate specified for the printer.
- TTLS and PEAP implement cross certification between a certificate sent from an authentication server and a user name and password specified for the printer.

#### Setting IEEE 802.1X authentication

We recommend that the settings be performed by the network administrator.

# Troubleshooting

---



## Printer Unit Problems

---

- ❖ Printing Cannot Be Performed
- ❖ The Printer Pauses during Printing, and then Printing Repeatedly Starts and Stops
- ❖ You Cannot Turn the Printer ON
- ❖ All the Indicators on the Network Interface Are Off



## Driver Problems

---

- ❖ You Cannot Install the Printer Driver
- ❖ You Cannot Uninstall the Printer Driver
- ❖ The Printer Driver Settings Cannot Be Changed
- ❖ "Profiles" Cannot Be Selected or Edited



## Paper Jams

---

- ❖ Paper Jams



## Error Display

---

- ❖ Indicators on the Printer Are On/Blinking
- ❖ A Message Appears in the Printer Status Window



## Printout Problems

---

- ❖ Poor Printout Results



## If You Cannot Solve a Problem

---

## Printing Cannot Be Performed

The solutions for when printing cannot be performed vary depending on your environment. See the solutions according to your environment.

### If You Are Using the Printer by Direct Connection

#### If the printer is connected by USB



❖ "Printing Cannot Be Performed (USB Connection)"

#### If the printer is connected by wired LAN

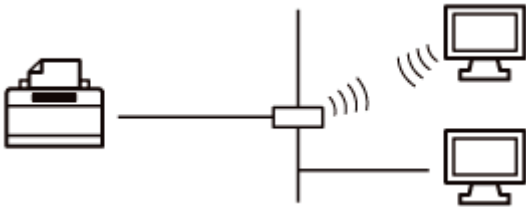

❖ "Printing Cannot Be Performed (Wired LAN Connection)"

#### If the printer is connected by wireless LAN (LBP7110Cw Only)

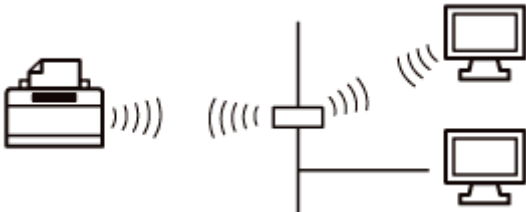

❖ "Printing Cannot Be Performed (Wireless LAN Connection) (LBP7110Cw Only)"

### If You Are Using the Printer via the Print Server

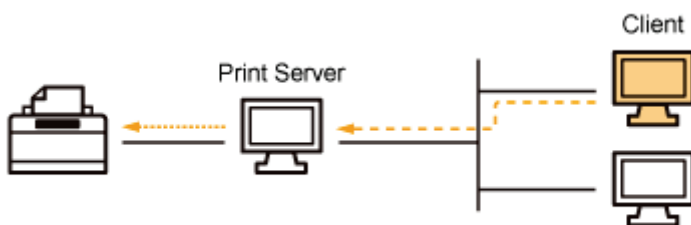

❖ "Printing Cannot Be Performed (via the Print Server)"

## Printing Cannot Be Performed (USB Connection)

If you cannot print when the printer is connected to the computer by a USB cable, check the problem following the questions below.



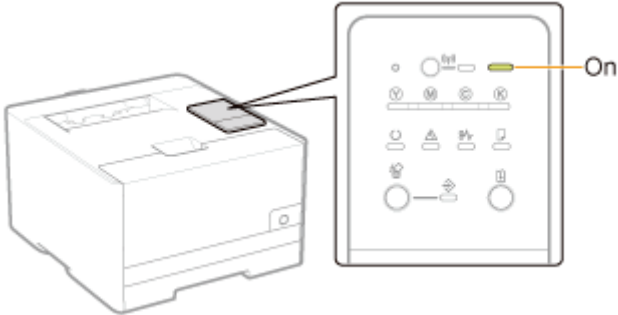



### <Question 1> Is the printer turned ON? (Is the Main Power indicator on?)

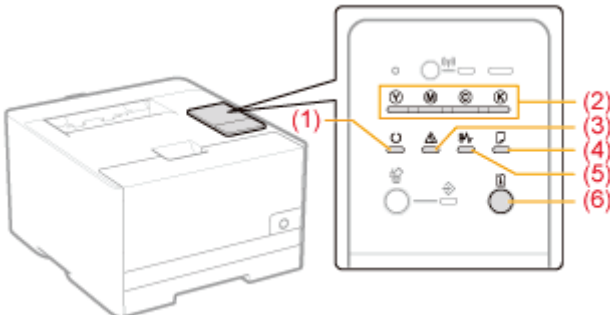

<b>ON</b>	To <Question 2>
<b>OFF</b>	Turn the printer ON.
<b>Cannot be turned ON</b>	❖ "You Cannot Turn the Printer ON"

### <Question 2> Check the indicators on the printer unit.



<b>(1) The  (Ready) indicator is on.</b>	To <Question 3>
<b>(1) The  (Ready) indicator is blinking.</b>	The printer is operating. Please wait a moment.
<b>(2) The Toner indicator is on or blinking.</b>	❖ "Indicators on the Printer Are On/Blinking"
<b>(3) The  (Alarm) indicator is on or blinking.</b>	
<b>(4) The  (Load Paper) indicator is blinking.</b>	
<b>(5) The  (Paper Jam) indicator is blinking.</b>	
<b>(6) The  (Go) indicator is blinking.</b>	

### <Question 3> Is the USB cable connected properly?

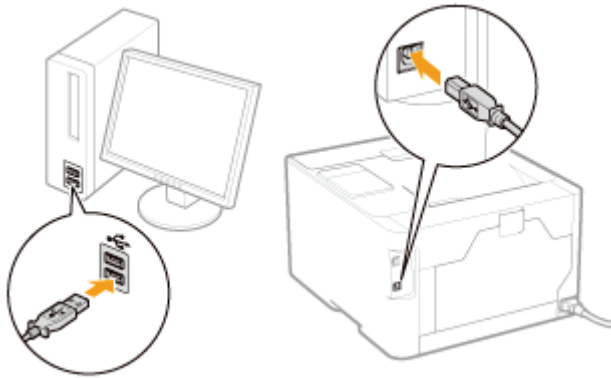

<b>Connected</b>	<p>Try the following point.</p> <ul style="list-style-type: none"> <li>• If you are using a hub, connect the printer to the computer directly.</li> <li>• If you are using a long USB cable, replace it with the short one.</li> <li>• If you have another USB cable, use it.</li> </ul> <p style="text-align: center;">▼</p> <p style="text-align: center;">If printing is not performed, proceed to &lt;Question 4&gt;.</p>
<b>Unconnected</b>	<p>Connect the cable properly.</p> <ul style="list-style-type: none"> <li>❖ <a href="#">"Connecting the Printer and Computer"</a></li> </ul>

### <Question 4> Can you print a test page in Windows?

❖ ["Basic Operations/Various Information for Windows"](#)



<b>Printable</b>	<p>There is no problem with the printer and driver. Check the printing preferences in the application.</p>
<b>Not printable</b>	<p>To &lt;Question 5&gt;</p>

### <Question 5> Is the port to be used selected correctly?

❖ ["Basic Operations/Various Information for Windows"](#)

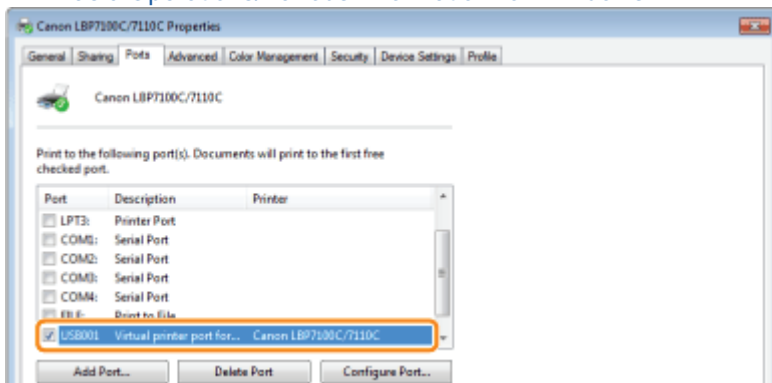

<b>Selected</b>	<p>To &lt;Question 6&gt;</p>
-----------------	------------------------------

<b>Not selected</b>	Select the correct port.
<b>The port to be used cannot be found.</b>	Install the printer driver again. <ul style="list-style-type: none"> <li>❖ "Uninstalling the Printer Driver"</li> <li>❖ "Installing the Printer Driver"</li> </ul>

**<Question 6> Is bi-directional communication enabled?**

❖ "Basic Operations/Various Information for Windows"

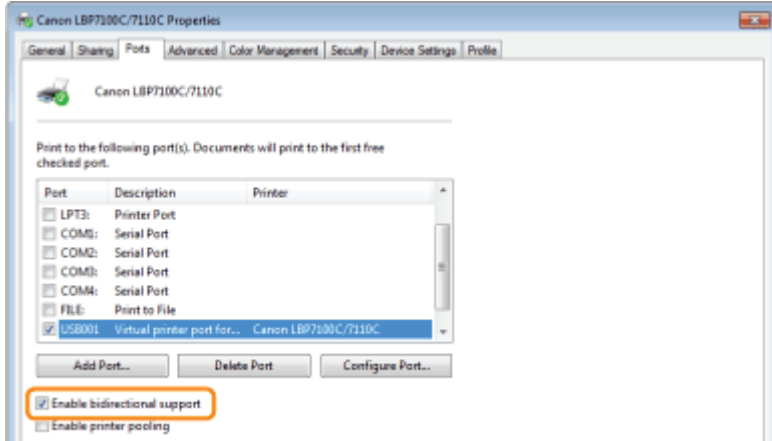

<b>Enabled</b>	To <Question 7>
<b>Not enabled</b>	Enable bi-directional communication and restart the computer and printer.

**<Question 7> Try the following points.**

- Make resident software invalid including security software.
- If any other devices are connected to your computer by USB connection, disconnect those unneeded.
- If drivers or software of any other devices (USB connection) is installed on your computer, uninstall those unneeded.
- Connect the USB cable to another USB port on your computer.
- Connect the printer to another computer with a USB cable.



If printing does not work, proceed to <Question 8>.

**<Question 8> Install the printer driver again.**

- ❖ "Uninstalling the Printer Driver"
- ❖ "Installing the Printer Driver"



If printing does not work, proceed to <Question 9>.

**<Question 9> Uninstall the USB class driver, and then install the printer driver again.**

- ❖ "Uninstalling the USB Class Driver"
- ❖ "Uninstalling the Printer Driver"
- ❖ "Installing the Printer Driver"



If printing does not work, contact your local authorized Canon dealer.

## Printing Cannot Be Performed (Wired LAN Connection)

If you cannot print when the printer is connected to the computer by wired LAN, check the problem following the questions below.



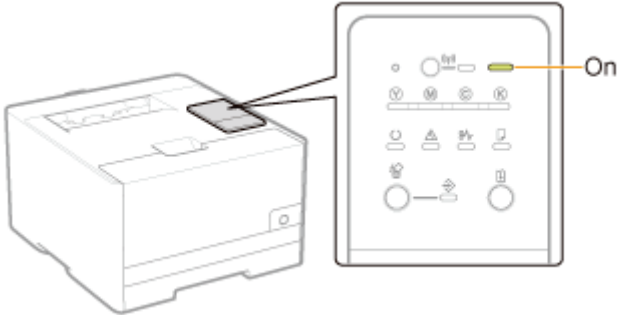



### <Question 1> Is the printer turned ON? (Is the Main Power indicator on?)

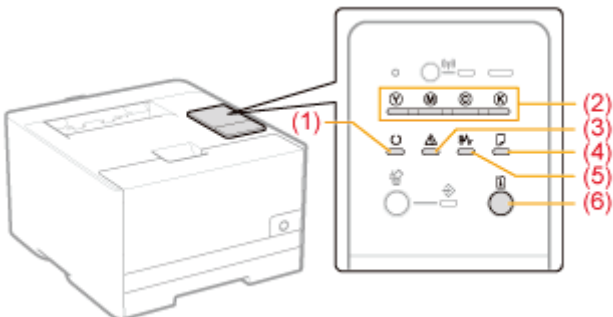

<b>ON</b>	To <Question 2>
<b>OFF</b>	Turn the printer ON.
<b>Cannot be turned ON</b>	❗ "You Cannot Turn the Printer ON"

### <Question 2> Check the indicators on the printer unit.



<b>(1) The  (Ready) indicator is on.</b>	To <Question 3>
<b>(1) The  (Ready) indicator is blinking.</b>	The printer is operating. Please wait a moment.
<b>(2) The Toner indicator is on or blinking.</b>	❗ "Indicators on the Printer Are On/Blinking"
<b>(3) The  (Alarm) indicator is on or blinking.</b>	
<b>(4) The  (Load Paper) indicator is blinking.</b>	
<b>(5) The  (Paper Jam) indicator is blinking.</b>	
<b>(6) The  (Go) indicator is blinking.</b>	

### <Question 3> Is the printer's (Wi-Fi) indicator on? (LBP7110Cw Only)



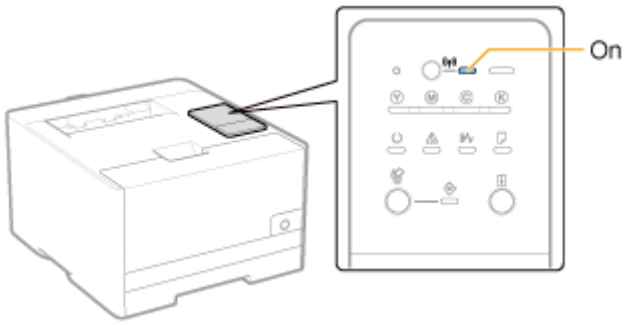

<b>On</b>	The printer is connected by wireless LAN. Change to a wired LAN connection. ➤ <a href="#">"Switching Between Wireless LAN and Wired LAN for the Connection (LBP7110Cw Only)"</a>
<b>Off</b>	To <Question 4>

**<Question 4> Can the computer connect to the Internet?**

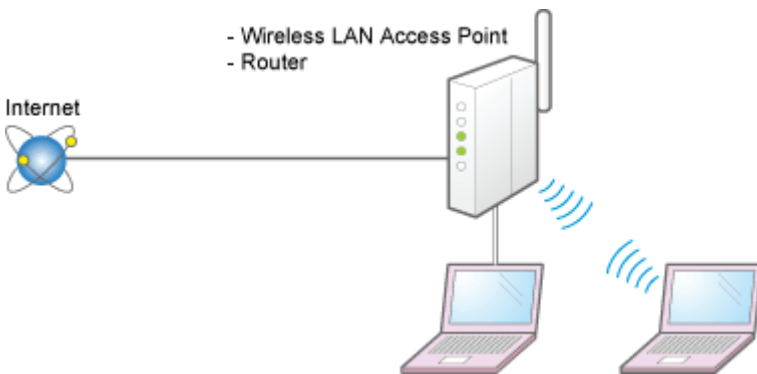

<b>Can connect</b>	To <Question 5>
<b>Cannot connect</b>	<ul style="list-style-type: none"> <li>• Properly connect the power cord or LAN cable of the router or other connected device.</li> <li>• Turn on the router or other connected device.</li> </ul> <p style="text-align: center;">▼</p> <p>If the computer still cannot connect to the Internet, restart all equipment, wait for a while, and then try connecting to the Internet again.</p> <p>† For details on the connection method or the procedure for restarting the equipment, see the instruction manual of each device or contact the manufacturer.</p>

**<Question 5> Is the LAN cable connected properly?**

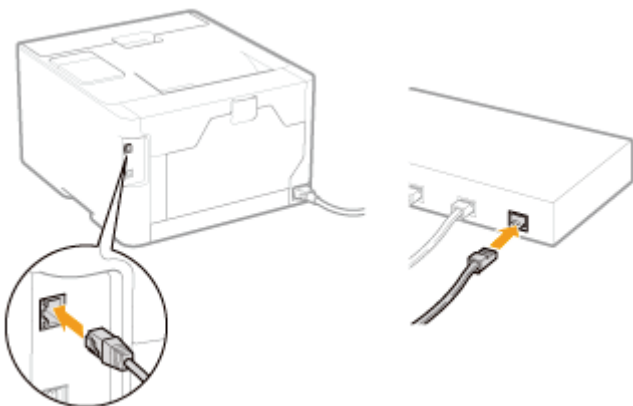

<b>Connected</b>	To <Question 6>
------------------	-----------------

<b>Unconnected</b>	Connect the cable properly. <a href="#">❏ "Connecting the Printer and Computer"</a>
--------------------	--

**<Question 6> Check the indicators on the network interface.**

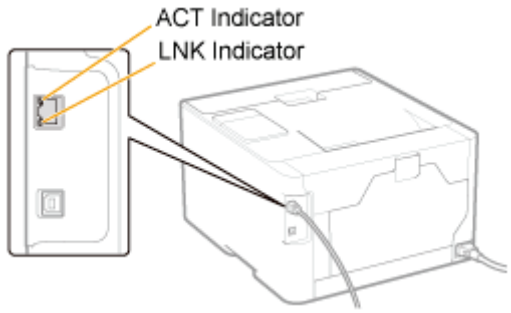

<b>The ACT indicator is on.</b>	To <Question 7>
<b>The LNK indicator is on.</b>	
<b>All the indicators are off.</b>	<a href="#">❏ "All the Indicators on the Network Interface Are Off"</a>

**<Question 7> Can you print a test page in Windows?**

[❏ "Basic Operations/Various Information for Windows"](#)



<b>Printable</b>	There is no problem with the printer and driver. Check the printing preferences in the application.
<b>Not printable</b>	To <Question 8>

**<Question 8> Is the IP address set properly?**

Check that the IP address is set properly using the PING command.

[❏ "Basic Operations/Various Information for Windows"](#)

<b>Set</b>	To <Question 9>
<b>Not set</b>	Set the IP address properly. <a href="#">❏ "Specifying the Connection Settings"</a>

**<Question 9> Is the port to be used selected correctly?**

[❏ "Basic Operations/Various Information for Windows"](#)

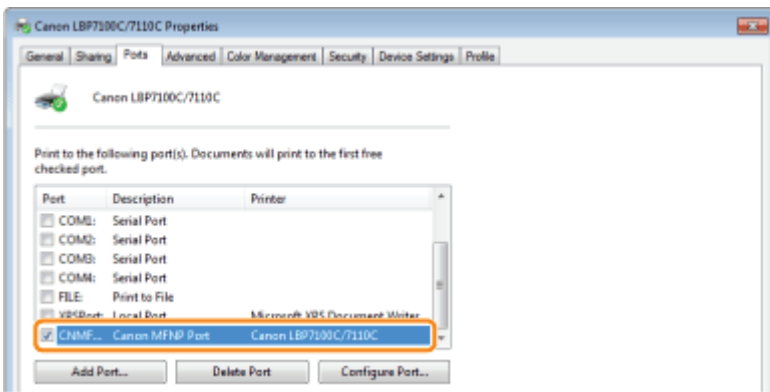

<b>Selected</b>	To <Question 10>
<b>Not selected</b>	Select the correct port.
<b>The port to be used cannot be found.</b>	Create a port. <a href="#">❖ "Configuring and Changing the Port"</a>
<b>The IP address was changed.</b>	<p><b>For MFNP Port</b></p> <p>To &lt;Question 10&gt;</p> <p>† The port does not have to be changed because a new IP address is detected automatically when the printer and computer are on the same subnet.</p> <p><b>For Standard TCP/IP Port</b></p> <p>Change the port.  <a href="#">❖ "Configuring and Changing the Port"</a></p>

**<Question 10> Check the following points.**

- The printer is specified as the default printer.
- The TCP/IP protocol is running.
- The users who can print are not restricted.  
[❖ "Restricting the Users Who Can Print and Specify Settings"](#)



If printing does not work, proceed to <Question 11>.

**<Question 11> Connect the printer and computer directly with the cross-type\* LAN cable.**

\* This is a LAN cable which is used to connect a printer and computer directly without a hub (LAN network).



If printing does not work or if you cannot prepare a cross-type LAN cable, proceed to <Question 12>.

**<Question 12> Install the printer driver again.**

- ❖ "Uninstalling the Printer Driver"
- ❖ "Installing the Printer Driver"



If printing does not work, proceed to <Question 13>.

**<Question 13> Can you print from another computer (network connection)?**



<b>Printable</b>	Make resident software invalid including security software.
<b>Not printable</b>	Contact your local authorized Canon dealer.

---

# Printing Cannot Be Performed (Wireless LAN Connection) (LBP7110Cw Only)

If you cannot print when the printer is connected to the computer by wireless LAN, check the problem following the questions below.



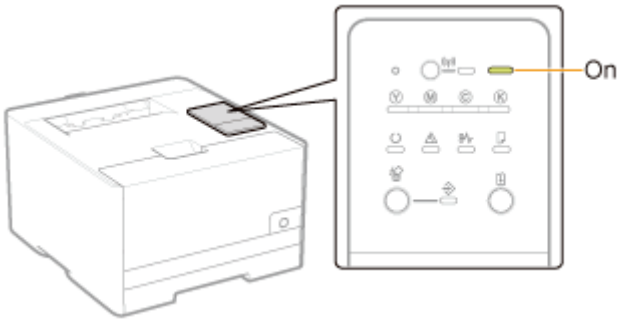



## <Question 1> Is the printer turned ON? (Is the Main Power indicator on?)

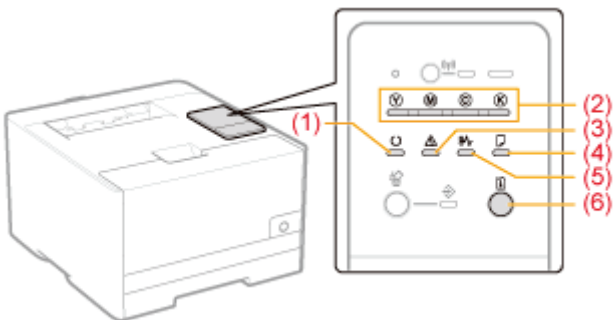

<b>ON</b>	To <Question 2>
<b>OFF</b>	Turn the printer ON.
<b>Cannot be turned ON</b>	❗ "You Cannot Turn the Printer ON"

## <Question 2> Check the indicators on the printer unit.



<b>(1) The  (Ready) indicator is on.</b>	To <Question 3>
<b>(1) The  (Ready) indicator is blinking.</b>	The printer is operating. Please wait a moment.
<b>(2) The Toner indicator is on or blinking.</b>	❗ "Indicators on the Printer Are On/Blinking"
<b>(3) The  (Alarm) indicator is on or blinking.</b>	
<b>(4) The  (Load Paper) indicator is blinking.</b>	
<b>(5) The  (Paper Jam) indicator is blinking.</b>	
<b>(6) The  (Go) indicator is blinking.</b>	

**<Question 3> Is the printer's (†) (Wi-Fi) indicator on?**

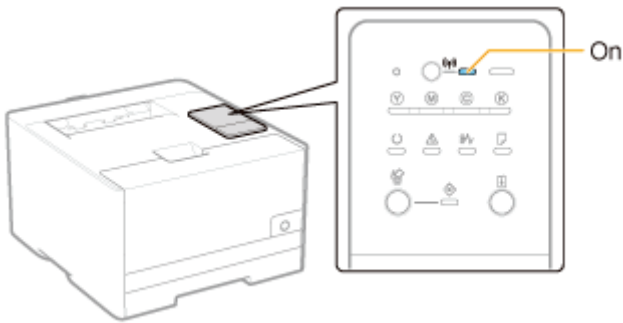

<b>On</b>	To <Question 4>
<b>Off</b>	The printer is not connected by wireless LAN. Change to a wireless LAN connection. ‡ "Switching Between Wireless LAN and Wired LAN for the Connection (LBP7110Cw Only)"

**<Question 4> Can the computer connect to the Internet?**

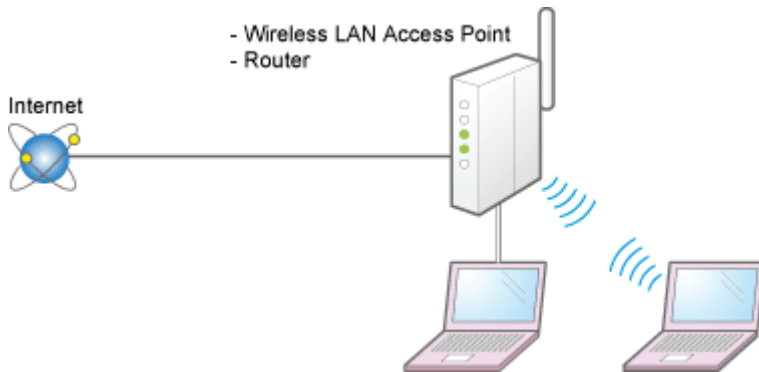

<b>Can connect</b>	To <Question 5>
<b>Cannot connect</b>	<ul style="list-style-type: none"> <li>• Complete the settings of the computer and wireless LAN access point.</li> <li>• Properly connect the power cord and LAN cable of the wireless LAN access point.</li> <li>• Turn on the wireless LAN access point.</li> </ul> <p style="text-align: center;">▼</p> <p>If the computer still cannot connect to the Internet, restart all equipment, wait for a while, and then try connecting to the Internet again.</p> <p>† For details on the connection method or the procedure for restarting the equipment, see the instruction manual of each device or contact the manufacturer.</p>

**<Question 5> Do the installation locations for the printer and wireless LAN access point meet the following conditions?**

- The distance between the printer and the wireless LAN access point is less than 50 m. (The distance may vary depending on the transmission speed and environmental conditions.)
- There is no wall or other obstruction between the printer and wireless LAN access point.
- The printer and wireless LAN access point are not located near a microwave oven or refrigerator.

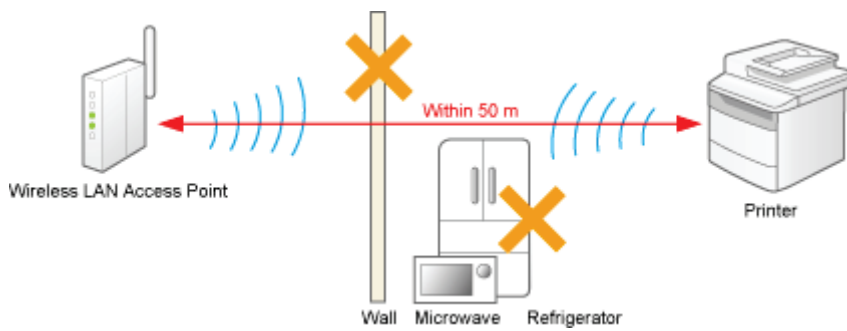

<b>Yes</b>	To <Question 6>
<b>No</b>	Relocate to a location that meets these conditions.

**<Question 6> Check the connection status (signal strength) of the wireless LAN.**

Check the connection status (signal strength) using [Wireless LAN Status] in "User Data List."

➤ "Printing the "User Data List""



- [Very Good] : Very good signal strength
- [Good] : Good signal strength
- [Normal] : Normal signal strength
- [Bad] : Poor signal strength
- [Very Bad] : Very poor signal strength

<b>Very good signal strength</b>	To <Question 7>
<b>Good signal strength</b>	
<b>Normal signal strength</b>	
<b>Poor signal strength</b>	Try the following points.
<b>Very poor signal strength</b>	<ul style="list-style-type: none"> <li>• <b>Change the channel of the wireless LAN access point</b> (If there are multiple wireless LAN access points, separate the channels by at least five channels.)</li> <li>• <b>Boost the wireless signal of the wireless LAN access point</b> (You may not be able to do this depending on your wireless LAN access point.)</li> </ul> <p>† For details on the change method, see the instruction manual of your wireless LAN access point or contact the manufacturer.</p>

**<Question 7> Does the SSID of the printer match that of the computer? (Only when the computer is connected by wireless LAN)**

† Check the SSID of the printer using [SSID Settings] in "User Data List."

➤ "Printing the "User Data List""



† See "Basic Operations/Various Information for Windows" and check the SSID of the computer.

<b>Yes</b>	To <Question 8>
<b>No</b>	<p>Specify the settings of the wireless LAN connection again.</p> <p>❖ "Specifying the Connection Settings"</p> <p>† Be careful of the following points when specifying the settings again.</p> <ul style="list-style-type: none"> <li>• Select [Easy Setup] and [My wireless LAN access point does not have a WPS button or I cannot find the button], and then change the settings.</li> <li>• Select a wireless LAN access point with the same SSID as that of the computer.</li> </ul>

### <Question 8> Can you print a test page in Windows?

❖ "Basic Operations/Various Information for Windows"



<b>Printable</b>	There is no problem with the printer and driver. Check the printing preferences in the application.
<b>Not printable</b>	To <Question 9>

### <Question 9> Is the IP address set properly?

Check that the IP address is set properly using the PING command.

❖ "Basic Operations/Various Information for Windows"

<b>Set</b>	To <Question 10>
<b>Not set</b>	<p>Set the IP address properly.</p> <p>❖ "Specifying the Connection Settings"</p>

### <Question 10> Is the port to be used selected correctly?

❖ "Basic Operations/Various Information for Windows"



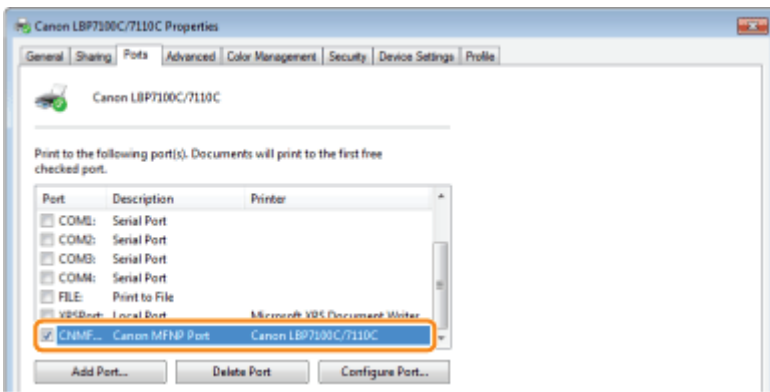

<b>Selected</b>	To <Question 11>
<b>Not selected</b>	Select the correct port.
<b>The port to be used cannot be found.</b>	Create a port. <a href="#">"Configuring and Changing the Port"</a>
<b>The IP address was changed.</b>	<p><b>For MFNP Port</b></p> <p>To &lt;Question 11&gt;</p> <p>† The port does not have to be changed because a new IP address is detected automatically when the printer and computer are on the same subnet.</p> <p><b>For Standard TCP/IP Port</b></p> <p>Change the port.  <a href="#">"Configuring and Changing the Port"</a></p>

**<Question 11> Check the following points.**

- The printer is specified as the default printer.
- The TCP/IP protocol is running.
- The users who can print are not restricted.  
["Restricting the Users Who Can Print and Specify Settings"](#)



If printing does not work, proceed to <Question 12>.

**<Question 12> Install the printer driver again.**

- ❖ "Uninstalling the Printer Driver"
- ❖ "Installing the Printer Driver"



If printing does not work, proceed to <Question 13>.

**<Question 13> Can you print from another computer (network connection)?**



<b>Printable</b>	Make resident software invalid including security software.
<b>Not printable</b>	Contact your local authorized Canon dealer.

## Printing Cannot Be Performed (via the Print Server)

If you cannot print when the printer is used via the print server, check the problem following the questions below.



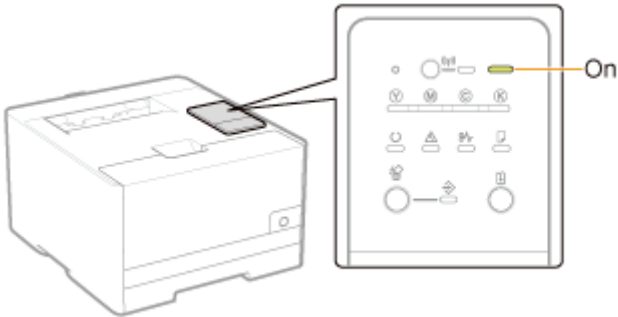



### <Question 1> Is the printer turned ON? (Is the Main Power indicator on?)

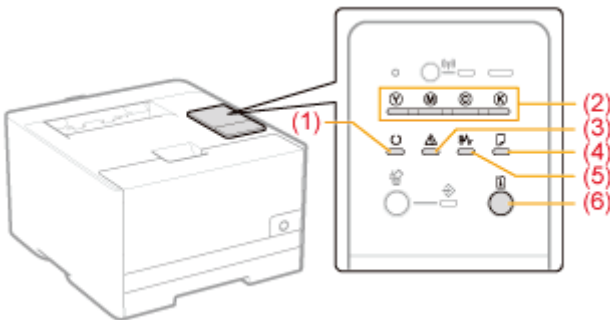

<b>ON</b>	To <Question 2>
<b>OFF</b>	Turn the printer ON.
<b>Cannot be turned ON</b>	❖ "You Cannot Turn the Printer ON"

### <Question 2> Check the indicators on the printer unit.



<b>(1) The  (Ready) indicator is on.</b>	To <Question 3>
<b>(1) The  (Ready) indicator is blinking.</b>	The printer is operating. Please wait a moment.
<b>(2) The Toner indicator is on or blinking.</b>	❖ "Indicators on the Printer Are On/Blinking"
<b>(3) The  (Alarm) indicator is on or blinking.</b>	
<b>(4) The  (Load Paper) indicator is blinking.</b>	
<b>(5) The  (Paper Jam) indicator is blinking.</b>	
<b>(6) The  (Go) indicator is blinking.</b>	

### <Question 3> Is the printer connected to the print server properly?



<b>Connected</b>	To <Question 4>
<b>Unconnected</b>	Connect the cable properly. ❖ <a href="#">"Connecting the Printer and Computer"</a>

**<Question 4> Can your computer be connected to the print server or the shared printer?**

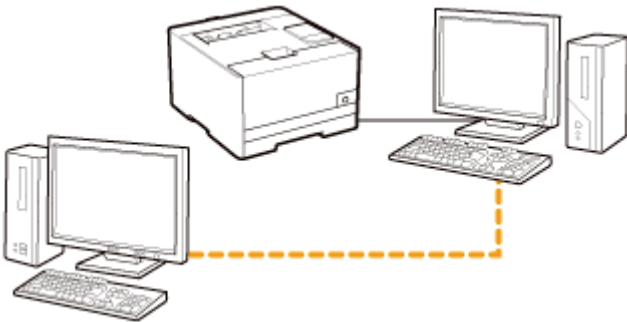

<b>Can be connected</b>	To <Question 5>
<b>Cannot be connected</b>	❖ <a href="#">"The Print Server for Connection Cannot Be Found"</a> ❖ <a href="#">"The Shared Printer Cannot Be Accessed"</a>

**<Question 5> Check the following points.**

- The print server is connected to the network properly.
- The additional driver (alternate driver) is updated properly.  
 ❖ ["Configuring the Print Server"](#)
- Printing can be performed from the print server.



If printing does not work, proceed to <Question 6>.

**<Question 6> Can you print a test page in Windows?**

- ❖ ["Basic Operations/Various Information for Windows"](#)



<b>Printable</b>	There is no problem with the printer and driver. Check the printing preferences in the application.
<b>Not printable</b>	To <Question 7>

**<Question 7> Is the printer on the print server displayed on the network?**

❏ "Basic Operations/Various Information for Windows"

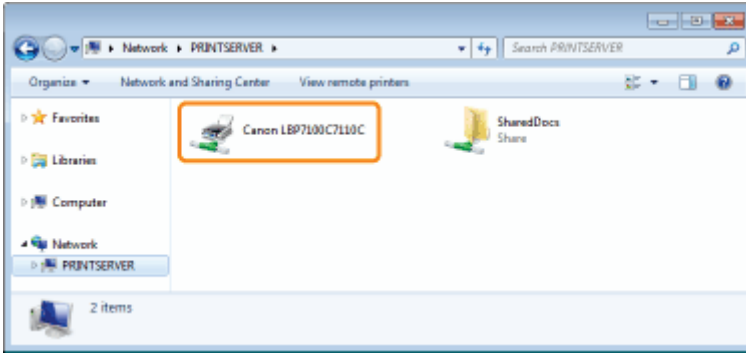

<b>Displayed</b>	To <Question 8>
<b>Not displayed</b>	Ask your network administrator about the problem.

**<Question 8> Install the printer driver again.**

❏ "Uninstalling the Printer Driver"

❏ "Installation on Clients"

† When installing the printer driver again, change the installation method.

- **If you performed the local installation (installing the printer driver with the CD-ROM)**  
→ Change the installation method to the download installation (installing the printer driver without the CD-ROM).
- **If you performed the download installation (installing the printer driver without the CD-ROM)**  
→ Change the installation method to the local installation (installing the printer driver with the CD-ROM).



If printing does not work, proceed to <Question 9>.

**<Question 9> Can another client print?**



<b>Printable</b>	Make resident software invalid including security software.
<b>Not printable</b>	Contact your local authorized Canon dealer.

## The Print Server for Connection Cannot Be Found

---

Perform one of the following solutions according to the cause.

### <Cause 1> The print server and client computer are not connected properly.

---

**Solution** Connect the print server and client computer properly.

### <Cause 2> The print server has not been started up.

---

**Solution** Start up the print server.

### <Cause 3> The printer is not specified as a shared printer.

---

**Solution** Specify the printer as a shared printer.  
➤ ["Configuring the Print Server"](#)

### <Cause 4> The user does not have permission to access the print server or printer.

---

**Solution** Ask your network administrator to change the user permissions.

### <Cause 5> [Network discovery] is not enabled. (Windows Vista, 7, and Server 2008)

---

**Solution** Perform the following procedure.

**Windows Vista**

1. From the [Start] menu, select [Control Panel].
2. Click [View network status and tasks].
3. Set [Network discovery] to [On].

**Windows 7 Windows Server 2008 R2**

1. From the [Start] menu, select [Control Panel].
2. Click [View network status and tasks].
3. Click [Change advanced sharing settings].
4. Specify [Turn on network discovery] in [Network discovery].

**Windows Server 2008**

1. From the [Start] menu, select [Control Panel].
2. Double-click [Network and Sharing Center].
3. Set [Network discovery] to [On].

---

## The Shared Printer Cannot Be Accessed

Perform one of the following solutions according to the cause.

### <Cause 1> The user of the computer to be used is not registered, or the password is not specified.

#### Solution

Register the user of the computer to be used or specify the password on the print server.  
For more details, ask your network administrator.

### <Cause 2> The path to the network is not correct.

#### Solution 1

Check printers in the print server.

❏ "Basic Operations/Various Information for Windows"

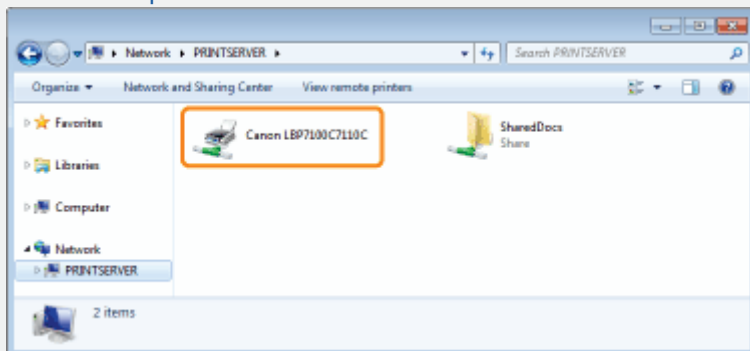

- **If the icon for this printer is not displayed**

Ask your network administrator about the problem.

- **If the icon for this printer is displayed**

You can install the printer driver by performing either of the following procedures and following the instructions on the screen.

- Double-clicking the icon for this printer
- Dragging and dropping the icon for this printer into the printer folder

#### Solution 2

If you want to specify the network path directly, check if the network path is specified correctly as "\\the print server name (the computer name of the print server)\the printer name."

## The Printer Pauses during Printing, and then Printing Repeatedly Starts and Stops

---

Perform the following procedure.

**<Cause> If the printer is used continuously for an extended period of time, the internal temperature of the printer increases, activating a safety mechanism and pausing printing temporarily.**

---

### **Solution**

Please wait a moment.

When the inside of the printer cools down, printing resumes.

If the internal temperature of the printer has not decreased sufficiently, the safety mechanism is reactivated and printing is paused temporarily. When the inside temperature cools down sufficiently, the printer resumes the normal printing speed.

- † The time until the safety mechanism activates or until the printer resumes the normal printing speed varies depending on the printer usage conditions.

## You Cannot Turn the Printer ON

---

Perform one of the following solutions according to the cause.

### <Cause 1> The power plug is unplugged from the AC power outlet.

---

**Solution** Plug the power plug into the AC power outlet.

### <Cause 2> The printer is plugged to an extension cord or multiple power strip.

---

**Solution** Plug the power plug directly into an AC power outlet.

### <Cause 3> The breakers have tripped.

---

**Solution** Reset the breakers on the switch board.

### <Cause 4> There is a break in the power cord.

---

**Solution** If the printer can be turned on after replacing the power cord with one that is of the same type, then purchase a new power cord and replace the broken one.

---



## All the Indicators on the Network Interface Are Off

Perform one of the following solutions according to the cause.

### <Cause 1> The LAN cable is not connected properly or broken.

- |                   |  |
|-------------------|--|
| <b>Solution 1</b> | Remove the LAN cable once, then connect it again.        |
| <b>Solution 2</b> | Replace the LAN cable with another one, then connect it. |

### <Cause 2> The cable is connected to the UP-LINK (cascade) port on the hub.

- |                   |  |
|-------------------|--|
| <b>Solution 1</b> | Connect the LAN cable to the port on the hub with an " X " mark. |
| <b>Solution 2</b> | If the hub has an UP-LINK (cascade) switch, switch to " X ".     |

### <Cause 3> A cross LAN cable is being used.

- |                   |   |
|-------------------|---|
| <b>Solution 1</b> | Replace the cable with a straight LAN cable.  |
| <b>Solution 2</b> | Connect the cross LAN cable to the UP-LINK (cascade) port on the hub. If the hub has an UP-LINK (cascade) switch, switch to the " = " side. |

### <Cause 4> Cannot communicate with the hub.

- |                   |  |
|-------------------|--|
| <b>Solution 1</b> | Make sure that the power of the hub is on.   |
| <b>Solution 2</b> | Specify the transmission speed and transfer mode of the printer to match those of the connected hub.<br>❖ <a href="#">"Specifying the Wired LAN Communication Mode and Transmission Speed"</a> |

### <Cause 5> The hardware of the printer is in an abnormal condition.

- |                 |  |
|-----------------|--|
| <b>Solution</b> | Contact your local authorized Canon dealer to request service. |
|-----------------|--|

### <Cause 6> If the printer is connected by wireless LAN (LBP7110Cw Only)

- |                 |   |
|-----------------|---|
| <b>Solution</b> | Change to a wired LAN connection.<br>❖ <a href="#">"Switching Between Wireless LAN and Wired LAN for the Connection (LBP7110Cw Only)"</a> |
|-----------------|---|

#### NOTE

#### **You cannot use a wired LAN and wireless LAN at the same time**

When using the printer with a wireless LAN connection, do not connect a LAN cable to the printer. This may result in malfunction.

# You Cannot Install the Printer Driver

## If a problem occurs during the installation

Select a problem during the installation from any of the following.

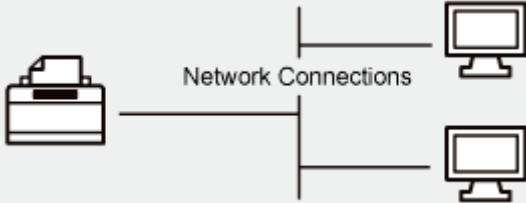
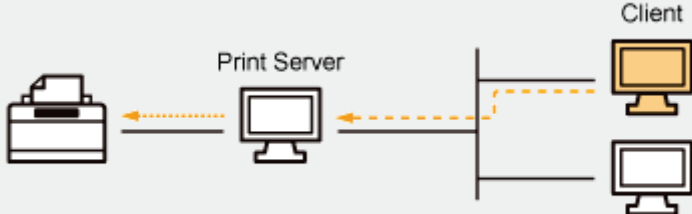
<p><b>USB connection</b></p> 	<ul style="list-style-type: none"> <li>❖ "The Printer Is Not Recognized Automatically"</li> </ul>
<p><b>Network connection</b></p> 	<ul style="list-style-type: none"> <li>❖ "The Printer Cannot Be Searched for"</li> </ul>
<p><b>Connection via the print server</b></p> 	<ul style="list-style-type: none"> <li>❖ "The Print Server for Connection Cannot Be Found"</li> <li>❖ "The Shared Printer Cannot Be Accessed"</li> </ul>

## If the printer driver is not installed properly

Perform the following procedure.

<p><b>Solution 1</b></p>	<p>Install the printer driver again.</p> <ul style="list-style-type: none"> <li>❖ "Uninstalling the Printer Driver"</li> <li>❖ "Installing the Printer Driver"</li> </ul>
<p><b>Solution 2 (Only when connecting with USB)</b></p>	<p>Uninstall the USB class driver, and then install the printer driver again.</p> <ul style="list-style-type: none"> <li>❖ "Uninstalling the USB Class Driver"</li> <li>❖ "Uninstalling the Printer Driver"</li> <li>❖ "Installing the Printer Driver"</li> </ul>

## The Printer Is Not Recognized Automatically

Perform one of the following solutions according to the cause.

### <Cause 1> The printer is not turned ON.

**Solution** Turn the printer ON.

### <Cause 2> The USB cable is not connected properly.

**Solution** Make sure that the printer and computer are properly connected with the USB cable.  
➤ ["Connecting the Printer and Computer"](#)

### <Cause 3> The USB cable was already connected and the printer was turned ON before the printer driver was installed.

**Solution**

Perform the following procedure.

1. Turn the printer OFF.
2. Disconnect the USB cable.
3. Connect the USB cable again.
4. While the following screen appears, turn the printer ON.

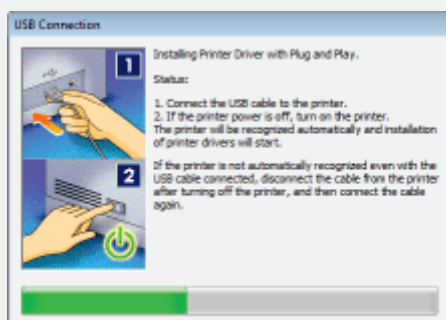

### <Cause 4> An inappropriate USB cable is being used.

**Solution**

Use a USB cable that is appropriate for the USB interface environment of the printer and has the following symbol.



- † The following is the USB interface environment of this printer.
- Hi-Speed USB
  - USB

### <Cause 5> The USB class driver is installed.

**Solution**

Uninstall the USB class driver.  
➤ ["Uninstalling the USB Class Driver"](#)

# The Printer Cannot Be Searched for

If the printer cannot be searched for (no devices are displayed in [Printer List]) at the time of installation, perform the following procedure.

## 1

**Make sure that the printer and computer are connected properly, and the printer is turned ON.**

➤ "Connecting the Printer and Computer"

## 2

**Click [Search Again], to search for the printer on the network again.**

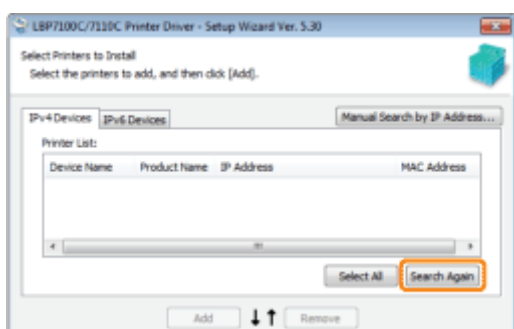

**? If the printer cannot be searched for (no devices are displayed) even by performing the above procedure**

### <Solution 1> (Only when [IPv4 Devices] is selected)

1. Click [Manual Search by IP Address].

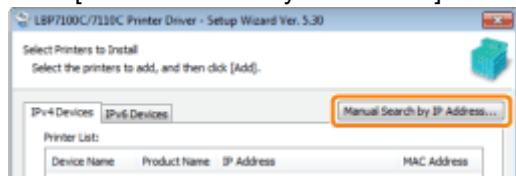

2. Enter the IP address of the printer to be installed.

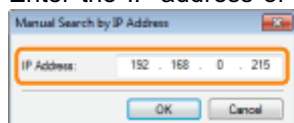

↑ If you are not sure about the IP address of the printer, see "[Checking the IP Address of the Printer.](#)"

3. Click [OK].

### <Solution 2>

1. Click [Back] to go back to the [Printer Installation] screen.
2. Select [Manually Set Port to Install].

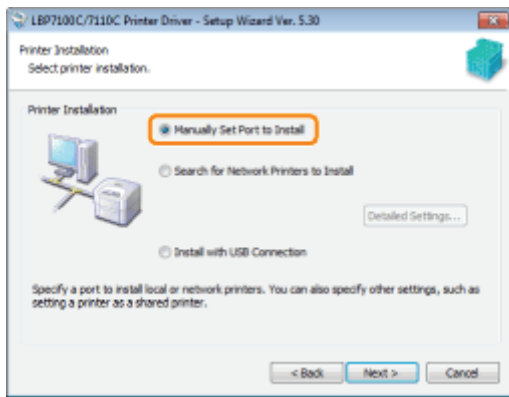

3. Click [Next].
4. Manually specify the port using [Port].
  - ❖ "[Printer Information] Screen"

## You Cannot Uninstall the Printer Driver

Perform the following procedure.

<b>Solution 1</b>	Start the uninstaller directly from the supplied CD-ROM, and then uninstall the printer driver. <ul style="list-style-type: none"><li>➤ "Starting the Uninstaller from the CD-ROM"</li><li>➤ "Uninstalling the Printer Driver"</li></ul>
<b>Solution 2</b> <b>(Only when connecting with USB)</b>	Uninstall the USB class driver. <ul style="list-style-type: none"><li>➤ "Uninstalling the USB Class Driver"</li></ul>

### NOTE

#### **If a user without administrative rights installed the printer driver**

You may not be able to uninstall the printer driver successfully depending on your operating system. In this case, uninstall the printer driver using the following procedure.

1. Open the printer folder.
  - "Basic Operations/Various Information for Windows"
2. Right-click the icon for this printer, then select [Delete] or [Remove device] from the pop-up menu.
3. Click [Yes].

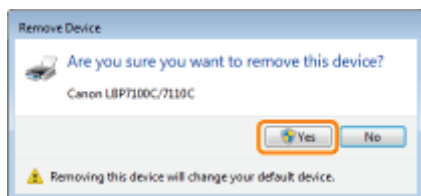

4. Uninstall the printer driver using the uninstaller.
  - "Uninstalling the Printer Driver"

## Starting the Uninstaller from the CD-ROM

### 1

Insert the supplied CD-ROM "User Software" into the CD-ROM drive of your computer.

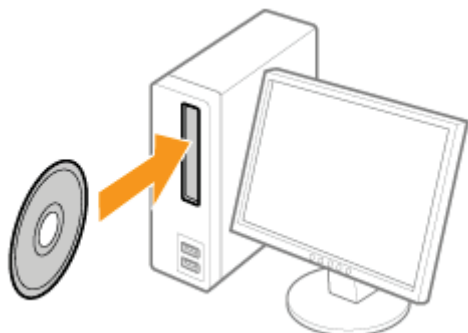

When the following screen appears, click [Exit].

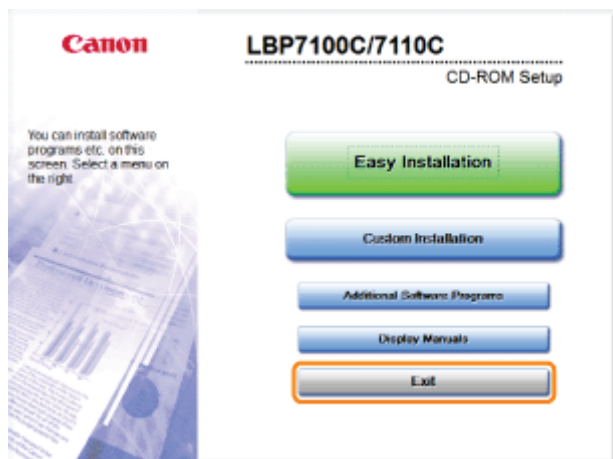

#### **?** If the [AutoPlay] dialog box appears

Select [Open folder to view files], and then proceed to Step 4.

### 2

Display [Computer] or [My Computer].

❖ "Basic Operations/Various Information for Windows"

### 3

Right-click the CD-ROM icon, then select [Open] from the pop-up menu.

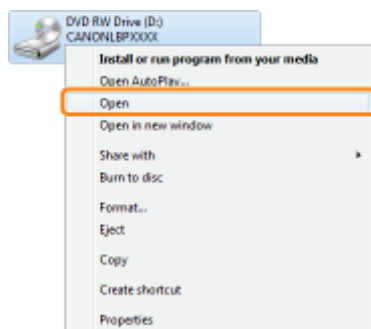

# 4

Open the folder in which the uninstaller is included.

## For a 32-bit operating system

Open the [English] - [32bit] - [MISC] folders.

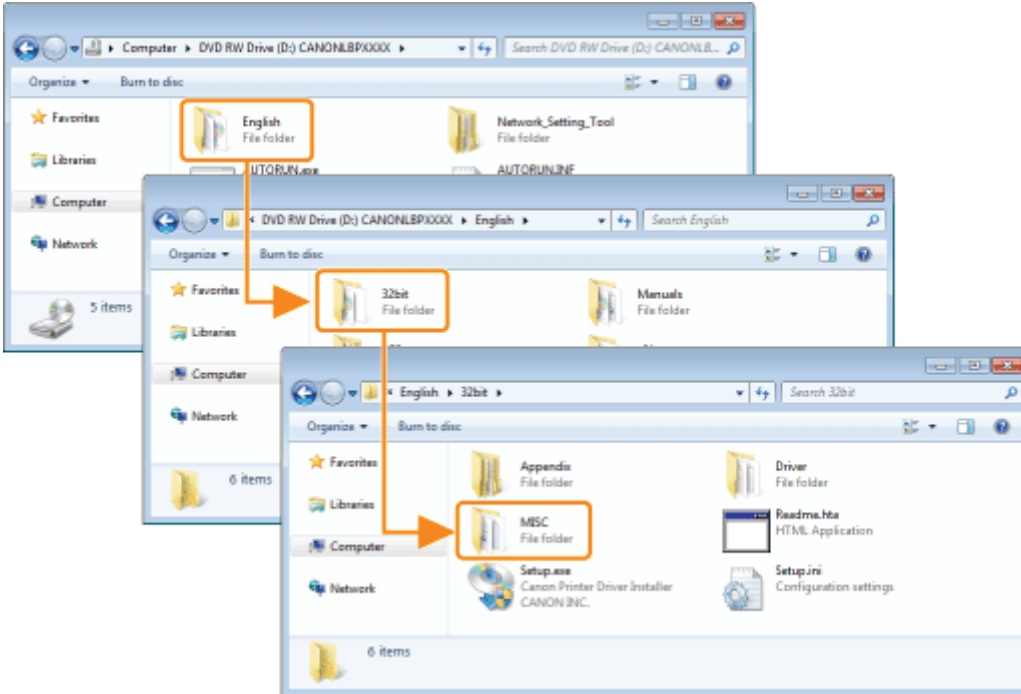

## For a 64-bit operating system

Open the [English] - [x64] - [MISC] folders.

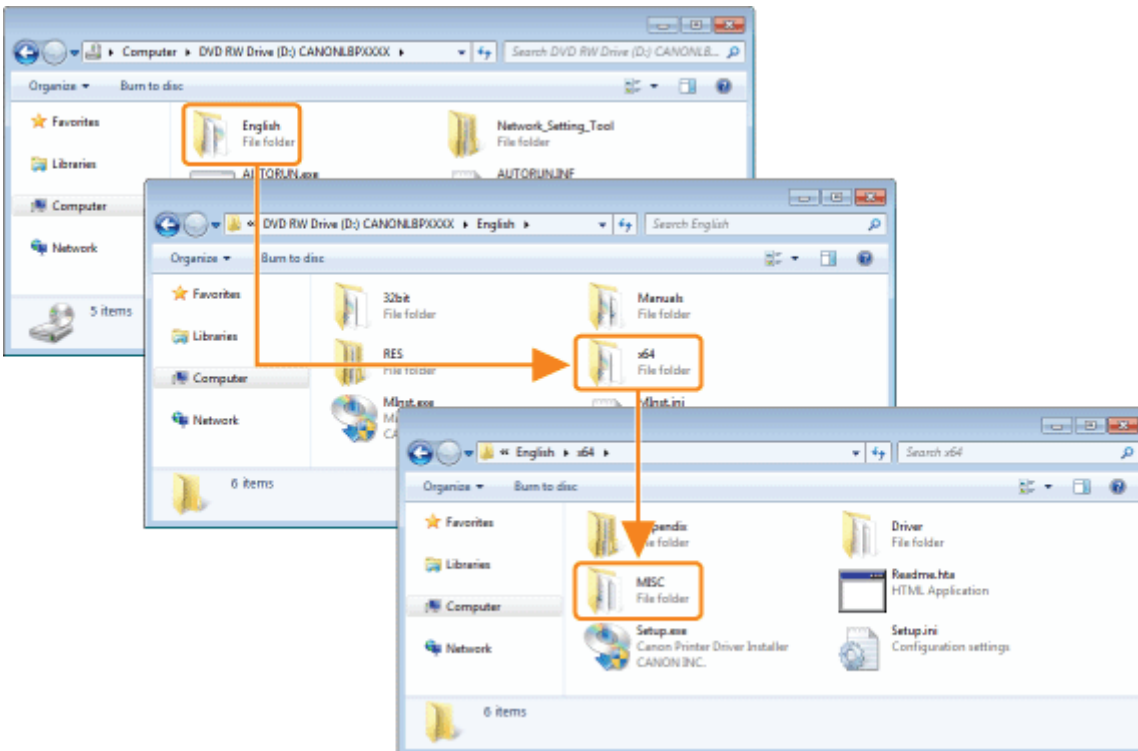

# 5

Double-click [UNINSTAL.exe].



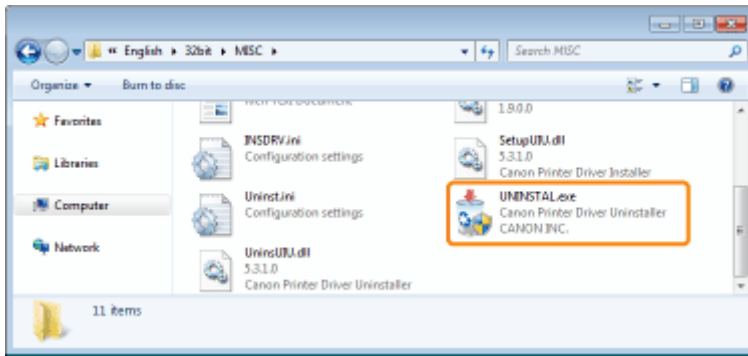

**? If the [User Account Control] dialog box appears**

Click [Yes] or [Continue].

 For details on the uninstallation, see "[Uninstalling the Printer Driver.](#)"

# Uninstalling the USB Class Driver

Uninstall the USB class driver under the following circumstances.

- If the printer driver installed using a USB connection cannot be uninstalled properly
- If you cannot install the printer driver properly even after reinstalling it

When uninstalling the USB class driver, be sure to perform the following procedure.

- † If the printer driver could not be installed properly, be sure to uninstall the printer driver before deleting the USB class driver.
  - ["Uninstalling the Printer Driver"](#)
- † If you delete the USB class driver, it is automatically installed again by USB connection.
- † Deleting the USB class driver is not supported for Macintosh.

## 1

### Check the following.

- The printer and computer are connected using a USB cable.
- The printer is turned ON.

## 2

### Display [Device Manager].

#### Windows XP

1. From the [Start] menu, select [Control Panel].
2. Click [Performance and Maintenance] → [System].
3. Click the [Hardware] tab → [Device Manager].

#### Windows Vista Windows 7 Windows Server 2008 R2

1. From the [Start] menu, select [Control Panel].
2. Click [Hardware and Sound] or [Hardware] → [Device Manager].

#### Windows Server 2003

1. From the [Start] menu, select [Control Panel] → [System].
2. Click the [Hardware] tab → [Device Manager].

#### Windows Server 2008

1. From the [Start] menu, select [Control Panel].
2. Double-click [Device Manager].

#### **?** If the [User Account Control] dialog box appears

Click [Yes] or [Continue].

## 3

### Double-click [Universal Serial Bus controllers].

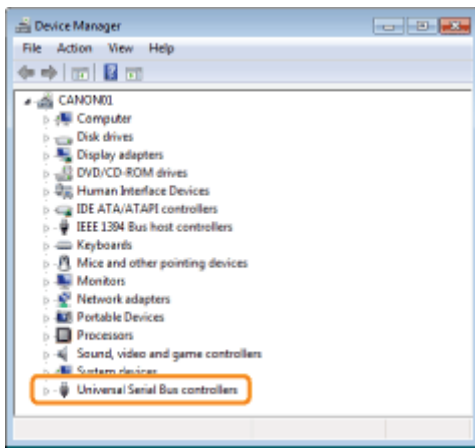

## 4

**Right-click [USB Printing Support], then select [Uninstall] from the pop-up menu.**

† Do not uninstall any drivers for other devices. If you uninstall them by mistake, Windows may not operate properly.

† If the USB class driver is not installed properly, [USB Printing Support] is not displayed. Then, click [  ] to close the [Device Manager] dialog box.

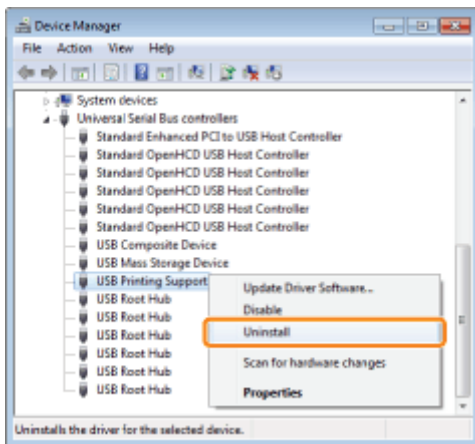

**? If the USB class driver is under [Other Devices]**

Select the USB class driver which is displayed as [Unknown device], and then uninstall it.

## 5

**Click [OK].**

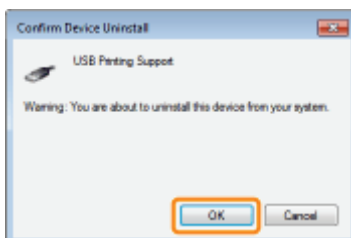

## 6

**Click [  ] to close the [Device Manager] dialog box.**

# 7

**Disconnect the USB cable from the computer, then restart Windows.**

---

# The Printer Driver Settings Cannot Be Changed

If [Spooling at Host] (whether the print data are processed in the computer) is set to [Disabled], you cannot change the driver settings because some options are unavailable.

To change the settings, set [Spooling at Host] to [Auto] or [Enabled] using the following procedure.

## 1

Open the printer folder.

➤ "Basic Operations/Various Information for Windows"

## 2

Right-click the icon for this printer, and then select [Printer properties] or [Properties] from the pop-up menu.

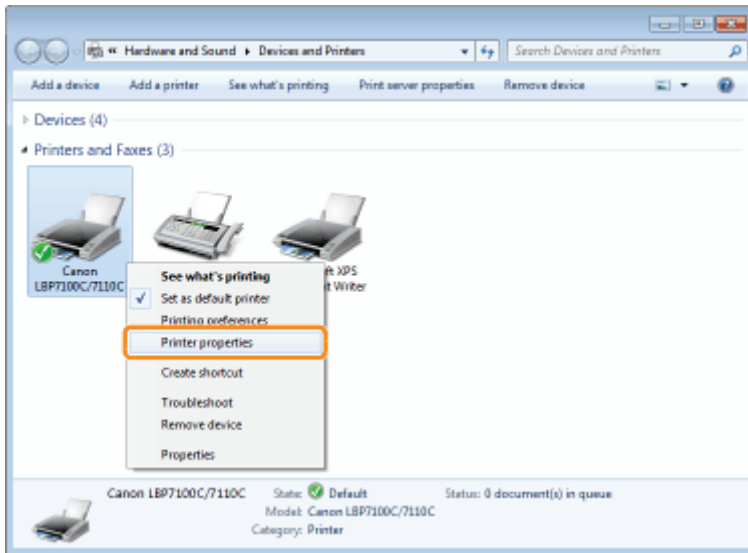

## 3

Change the setting for [Spooling at Host].

- (1) Display the [Device Settings] sheet.
- (2) Select [Auto] or [Enabled] for [Spooling at Host].

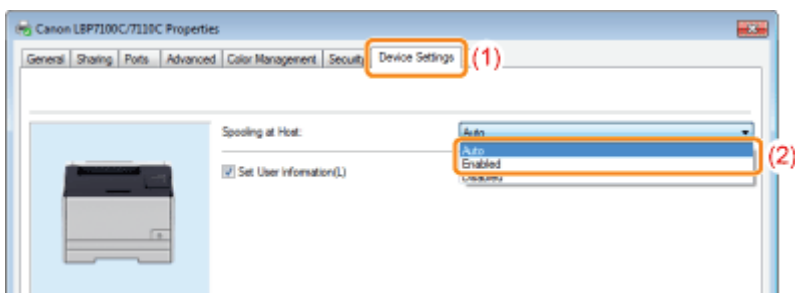

[Auto]	The printer selects automatically whether or not print data is processed on the host (computer). When processing can be performed only with the functions of the printer, processing is performed only on the printer to enable faster printing.
[Enabled]	All print data is processed by the host (computer).

**? If you cannot change the setting**

You need administrative rights to change the setting.

Contact your system administrator.

**4**

**Click [OK].**

## "Profiles" Cannot Be Selected or Edited

When the [Allow Profile Selection] and [Allow Setting Edition] check boxes are cleared, selecting and editing a "Profile" are restricted.

To select or edit a "Profile", select the check box using the following procedure.

### 1

**Open the printer folder.**

➤ "Basic Operations/Various Information for Windows"

### 2

**Right-click the icon for this printer, and then select [Printer properties] or [Properties] from the pop-up menu.**

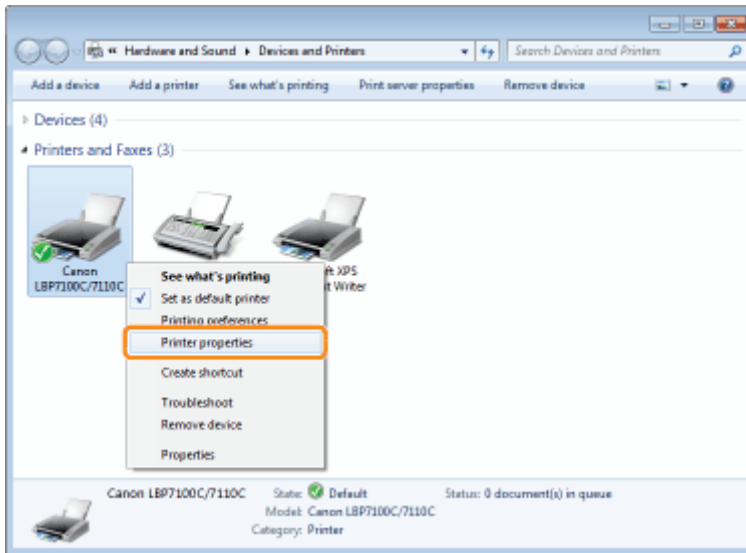

### 3

**Change the settings for [Define Document Property].**

- (1) Display the [Profile] sheet.
- (2) Select the [Allow Profile Selection] and [Allow Setting Edition] check boxes.

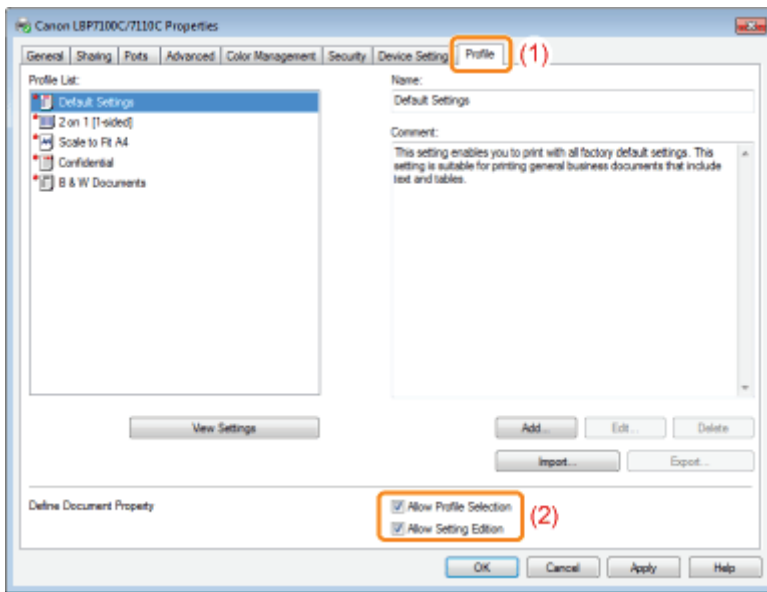

**? If you cannot change the setting**

You need administrator rights to change the setting.  
Contact your system administrator.

**4**

**Click [OK].**



# Paper Jams

Before removing jammed paper, see "Attention (Paper Jams)."

When a paper jam occurs, the  (Paper Jam) indicator (orange) blinks, and messages appear in the Printer Status Window.

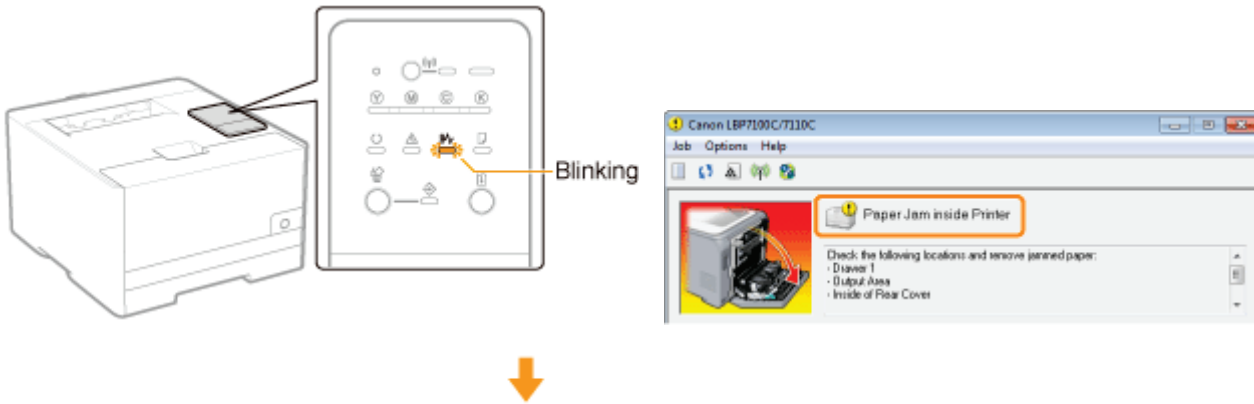

Remove paper jammed in each area in the order of the displayed areas in the message.

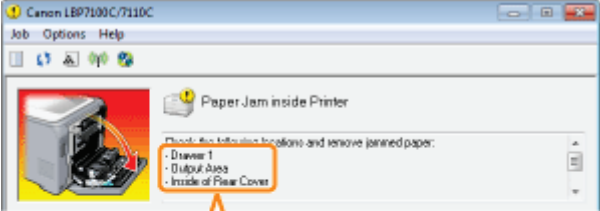
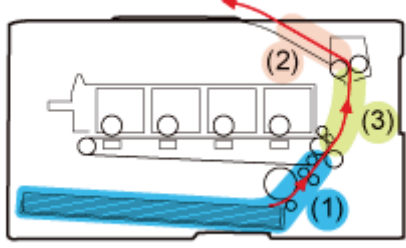
Message and Clearance Procedure	Paper Jam Area
 <ul style="list-style-type: none"> <li>- Drawer 1 → (1)</li> <li>- Output Area → (2)</li> <li>- Inside of Rear Cover → (3)</li> </ul> <ul style="list-style-type: none"> <li>❖ (1) "Clearing Paper Jams (Paper Drawer)"</li> <li>❖ (2) "Clearing Paper Jams (Output Area)"</li> <li>❖ (3) "Clearing Paper Jams (Inside the Rear Cover)"</li> </ul>	 <p>(Side View)</p>

**?** If the Printer Status Window is not displayed

- ❖ "Printer Status Window"

## Attention (Paper Jams)

See "Important Safety Instructions" also.

### IMPORTANT

#### **Leave the printer ON when removing the jammed paper.**

If the power is turned off, the data being printed will be deleted.

#### **Do not remove the jammed paper forcefully.**

Removing jammed paper with excess force may cause the paper to tear or damage the inside of the printer. Remove the paper by pulling it gently.

#### **If the paper is torn**

Remove all remaining pieces of paper.

#### **Do not touch the transfer roller.**

Print quality may deteriorate.

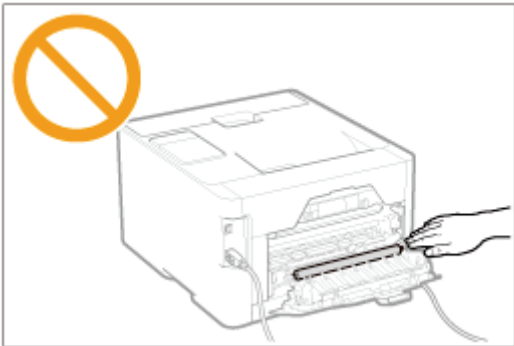

## Clearing Paper Jams (Paper Drawer)

**1**

**Pull out the paper drawer.**

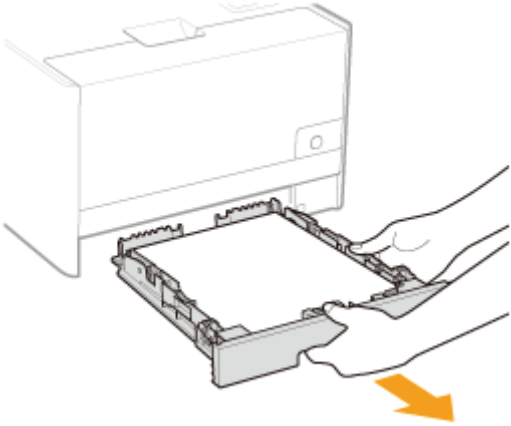

**2**

**Open the drawer top cover.**

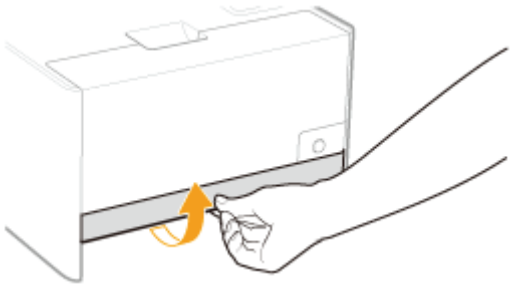

**3**

**Remove the paper by pulling it gently.**

If you cannot remove the paper easily, do not try to remove it forcefully but proceed to Step 4 and perform the clearing procedure for another area which is displayed in the message.

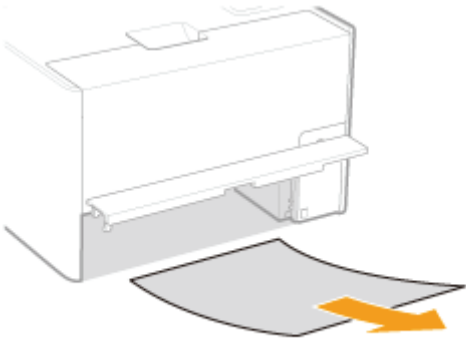

**4**

**Close the drawer top cover.**

# 5

## **Insert the paper drawer in the printer.**

 Next, proceed to the clearing procedure for another area which is displayed in the message.

- (1) "Clearing Paper Jams (Paper Drawer)"
- (2) "Clearing Paper Jams (Output Area)"
- (3) "Clearing Paper Jams (Inside the Rear Cover)"

## Clearing Paper Jams (Output Area)

### 1

**Remove the paper by pulling it gently.**

If you cannot remove the paper easily, do not try to remove it forcefully but perform a procedure for another area which is displayed in a message.

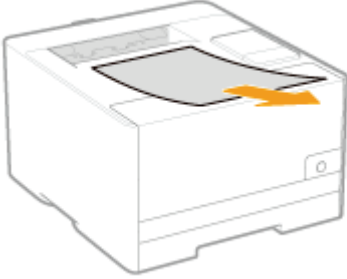

 Next, proceed to the procedure for clearing the paper jam which is occurred in another area displayed in the message.

- (1) "[Clearing Paper Jams \(Paper Drawer\)](#)"
- (2) "[Clearing Paper Jams \(Output Area\)](#)"
- (3) "[Clearing Paper Jams \(Inside the Rear Cover\)](#)"

## Clearing Paper Jams (Inside the Rear Cover)

**1**

**Open the rear cover.**

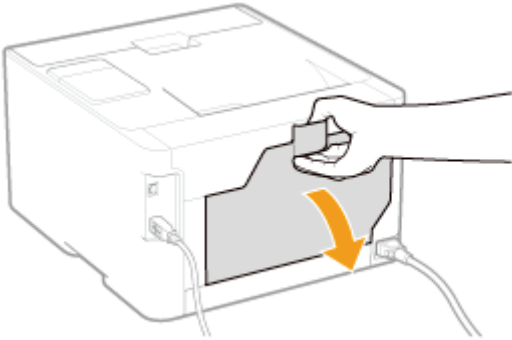

**2**

**Remove the jammed paper.**

- (1) Hold both sides of the paper and slowly pull them down.
- (2) Remove the paper by pulling it gently.

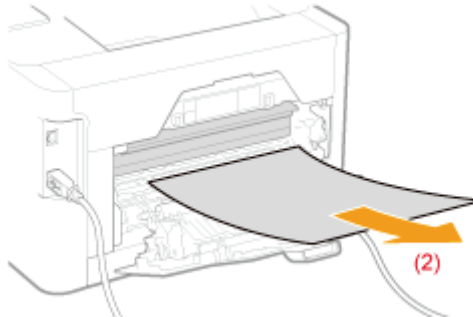
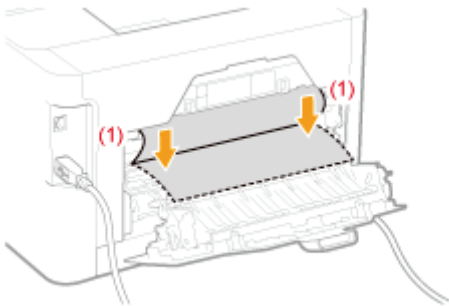

**3**

**Close the rear cover.**

→ The paper jam message disappears, and the printer is ready to print.







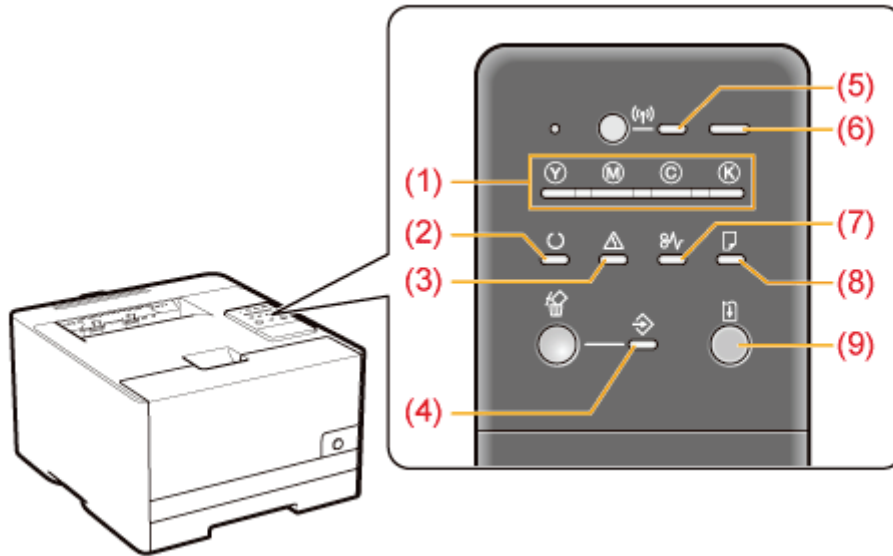



## Indicators on the Printer Are On/Blinking

The indicators on the printer display the printer status as follows.

Perform solutions according to the indicators are on/blinking.



Name	Status	Solution
<b>(1) Toner Indicator</b>	  (On or Blinking)  An error is occurring for the toner cartridges. (Such as when the toner cartridges have reached the end of their life)	Solve the problem following the message displayed in the Printer Status Window.* <sup>1</sup> ❖ "A Message Appears in the Printer Status Window"
<b>(2) Ready Indicator</b>	 (On)	The printer is ready to print.
	 (Blinking)	The printer is busy printing, preparing to print, or cleaning.
<b>(3) Alarm Indicator</b>	 (On)	A service error is occurring.
	 (Blinking)	An error is occurring.

<b>(4) Job Indicator</b>	 (On)	A job is being printed or is waiting to be printed.	—
	 (Blinking)	A job is being canceled.	
<b>(5) Wi-Fi Indicator (LBP7110Cw Only)</b>	 (On)	The printer is connected by wireless LAN.	—
	 (Blinking)	The wireless LAN is configured.	
<b>(6) Main Power Indicator</b>	 (On)	The printer is turned ON.	—
	 (Blinking)	The printer is being turned OFF.	
<b>(7) Paper Jam Indicator</b>	 (Blinking)	A paper jam is occurring.	Remove the paper jam. ➤ <a href="#">"Paper Jams"</a>
<b>(8) Load Paper Indicator</b>	 (Blinking)	Paper needs to be checked. (Such as when paper runs out and when paper cannot be fed properly)	Load the paper properly. ➤ <a href="#">"Loading Paper"</a>
<b>(9) Go Indicator</b>	 (Blinking)	An error occurred, but you can ignore the error and continue printing.	To skip the error and continue printing, press the [  ] (Go) key.* <sup>2</sup>

\*<sup>1</sup> For details on the procedure for displaying the Printer Status Window, see "[Printer Status Window](#)."

\*<sup>2</sup> Skipping the error and continuing printing (by pressing the [  ] (Go) key) may cause unexpected print results.



## A Message Appears in the Printer Status Window

Perform solutions according to the displayed message.

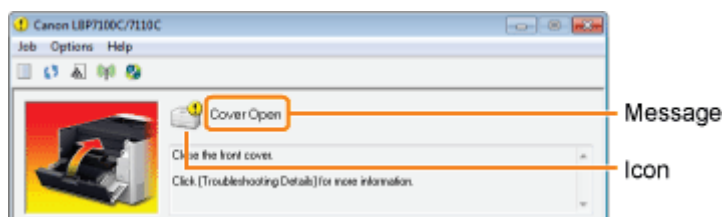

The message type varies depending on the icon.

### A service call is occurring.

- " Service Error"

### Communication cannot be performed with the printer.

- " Cannot Communicate with Printer"
- " Cannot Communicate with Server"
- " Communication Error"
- " Incompatible Printer"
- " Incorrect Port"
- " Network Communication Error"

### The printer problems need to be corrected.

- " Check the Printed Output"
- " Check the Toner Cartridges"
- " Cover Open"
- " Insufficient Printer Memory"
- " No Toner Cartridge"
- " Out of Paper"
- " Packing Material on Toner Cartridges"
- " Paper Jam inside Printer"
- " Printer Not Ready"
- " Replace Toner Cartridges"
- " Specified Paper Different from Set Paper"
- " Toner Cartridge Replacement Recommended"
- " Updating Firmware"
- " Wrong Color Toner Cartridges"

### Service Error

<Cause> The printer is in an abnormal condition.

**Solution** Perform the described solutions in "[When <Service Error> Is Displayed.](#)"

### Cannot Communicate with Printer

<Cause 1> Because the bi-directional communication function is not enabled, the computer cannot communicate with the printer.

**Solution** Enable bi-directional communication and restart the computer and printer.  
❖ "[Basic Operations/Various Information for Windows](#)"

<Cause 2> The computer cannot communicate with the printer redirected in the terminal connection environment.

**Solution**

The Firewall settings and so on may be the cause.  
Check the communication settings for the server, clients, and so on.

**Cannot Communicate with Server**

---

**<Cause> The client computer cannot communicate with the print server.**

**Solution**

Perform the described solutions in "[The Print Server for Connection Cannot Be Found.](#)"

**Communication Error**

---

**<Cause> The USB cable is not connected, or the printer is not turned ON.**

**Solution 1**

Connect the USB cable properly.  
 "[Connecting the Printer and Computer](#)"

**Solution 2**

Turn the printer ON.

**Incompatible Printer**

---

**<Cause> The connected printer cannot be used.**

**Solution**

Connect to the supported printer.

**Incorrect Port**



---

**<Cause> The printer is connected to a port which the printer does not support.**

**Solution**

Check the port.  
 "[Basic Operations/Various Information for Windows](#)"

† When there is no port to use, perform one of the following solutions according to your environment.

**When connecting by USB**  
 Install the printer driver again.  
 "[Uninstalling the Printer Driver](#)"  
 "[Installing the Printer Driver](#)"

**When connecting to a network**  
 Create a port.  
 "[Configuring and Changing the Port](#)"

**Network Communication Error**

---

**<Cause> The printer and computer are not connected, or the printer is not turned ON.**

**Solution 1**

Connect the printer and computer to the network properly.  
 "[Connecting the Printer and Computer](#)"

**Solution 2**

Turn the printer ON.

**Check the Printed Output**



---

**<Cause> You may not be able to obtain appropriate printout results.**

<b>Solution 1</b>	Clicking [  ] (Resolve Error) continues printing. However, the error message may appear again.
<b>Solution 2</b>	Cancel the print job, and then print again. ➤ <a href="#">"Canceling a Job"</a>

 **Check the Toner Cartridges**

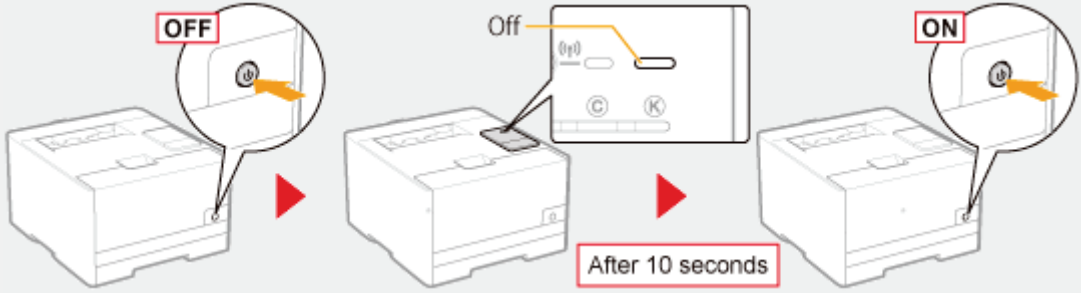
**<Cause 1> The toner cartridges of the indicated colors are not installed properly.**

<b>Solution 1</b>	Reinstall the toner cartridges while referring to " <a href="#">Replacing the Toner Cartridge.</a> "
<b>Solution 2</b>	Turn the printer OFF, make sure that the Main Power indicator is off, wait for 10 seconds or longer, and then turn it ON again. 

**<Cause 2> The toner cartridges of the indicated colors are damaged.**

<b>Solution</b>	Replace the toner cartridges with new ones. ➤ <a href="#">"Replacing the Toner Cartridge"</a>
-----------------	--

 **Cover Open**

**<Cause> The indicated cover is open.**

<b>Solution</b>	Close the cover firmly.
-----------------	-------------------------

 **Insufficient Printer Memory**

**<Cause> There are pages that include large amounts of data in the current job.**

<b>Solution</b>	The data cannot be printed by the printer. Click [  ] (Cancel Job) to cancel printing.
-----------------	---

 **No Toner Cartridge**

**<Cause> The toner cartridge is not installed.**

<b>Solution</b>	Install the toner cartridge while referring to " <a href="#">Replacing the Toner Cartridge.</a> "
-----------------	---

 **Out of Paper**

**<Cause> The paper to be printed is not loaded.**

**Solution**

Load the indicated paper in the paper drawer.  
 ➤ ["Loading Paper"](#)

 **Packing Material on Toner Cartridges**

---

**<Cause> The sealing tape is attached to the toner cartridge of the indicated color.**

**Solution**

Remove the sealing tape while referring to ["Removing the Packing Materials."](#)

 **Paper Jam inside Printer**

---

**<Cause> A paper jam is occurring.**

**Solution**

Do not forcefully remove the jammed paper. Remove the jammed paper according to the procedure in the e-Manual.  
 ➤ ["Paper Jams"](#)

 **Printer Not Ready**

---

**<Cause> The packing materials are left in the printer.**

**Solution**

Turn the printer OFF, remove all packing materials while referring to ["Removing the Packing Materials,"](#) and then turn ON again.

 **Replace Toner Cartridges**

---

**<Cause> The toner cartridges of the indicated colors have reached the end of their life.**

**Solution**

Replace the toner cartridges with new ones.  
 ➤ ["Replacing the Toner Cartridge"](#)  
 † You can continue printing as is by clicking [  ] (Resolve Error), however, this may result in damage to the printer.

 **Specified Paper Different from Set Paper**

---

**<Cause> Paper that is different from that of the paper setting of the job is loaded.**

**Solution 1**

Load the indicated paper in the paper drawer.  
 ➤ ["Loading Paper"](#)

**Solution 2**

If the indicated paper is loaded, register the paper setting of the paper drawer again.  
 ➤ ["Registering the Paper Size and Type"](#)  
 † If loading A5, Statement, or custom size paper in landscape orientation, select the [Feed A5 Horizontally], [Feed Statement Horizontally], or [Feed Custom Paper Horizontally] check box on the [Paper Source] sheet of the printer driver when printing.

**Solution 3**

Clicking [  ] (Resolve Error) allows the printer to print on the currently loaded paper.

### Toner Cartridge Replacement Recommended



---

**<Cause> Printing quality cannot be guaranteed due to the toner cartridges of the indicated colors reaching the end of their life and so on.**

**Solution**

It is recommended that you replace the toner cartridges with new ones.

➤ ["Replacing the Toner Cartridge"](#)

† You can continue printing as is by clicking [  ] (Resolve Error), however, print quality may deteriorate.



## **Updating Firmware**

---

**<Cause> The firmware is being updated.**

**Solution**

Please wait a moment.



## **Wrong Color Toner Cartridges**

---

**<Cause> Wrong color toner cartridges are installed at the loading position for the indicated colors.**

**Solution**

Install the toner cartridges to the appropriate positions for each color while referring to "[Replacing the Toner Cartridge.](#)"

---

## When <Service Error> Is Displayed



If <Service Error> is displayed in the Printer Status Window, perform the following procedure to cycle the power of the printer.

**1**

**Turn the printer OFF, make sure that the Main Power indicator is off, wait for 10 seconds or longer, and then turn it ON again.**

If the message does not reappear, the printer is ready.

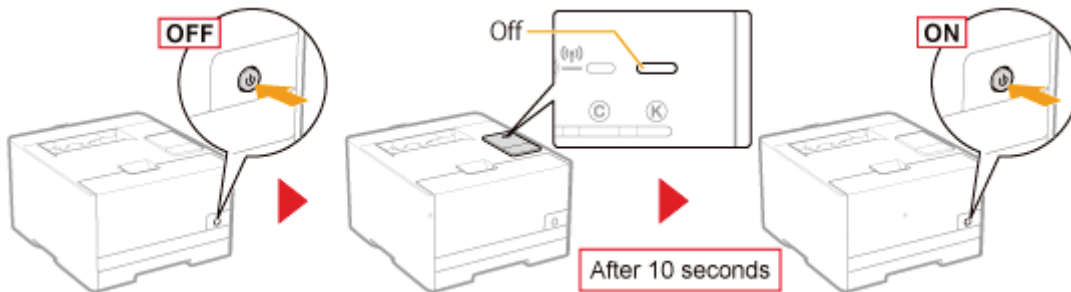

If the message reappears, you need to request service.  
Follow the procedure below, and then contact your local authorized Canon dealer to request service.

**2**

**Note down the error code displayed in the Printer Status Window.**

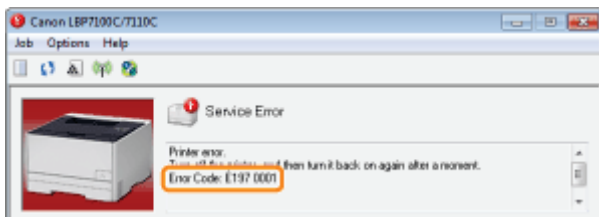

**3**

**Turn the printer OFF, then disconnect the cables or cords from the printer.**

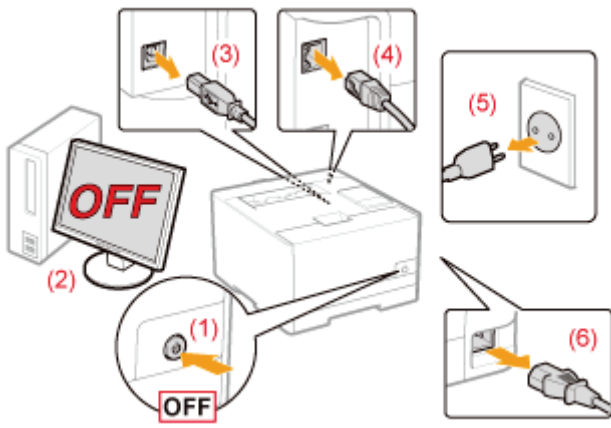

#### <How to disconnect the cable or cord>

USB cable*	(2) Turn the computer off. (3) Disconnect the cable from the printer.
LAN cable*	(4) Disconnect the cable from the printer.
Power cord	(5) Disconnect the power plug from the AC power outlet. (6) Disconnect the cable from the printer.

\* Whether the cable is connected or not varies depending on your environment.

## 4

### Contact your local authorized Canon dealer to request service.

When contacting your Canon dealer, please report also the error code which you noted down in Step 2.

† If you are not sure what the problem is, contact your local authorized Canon dealer.

## Poor Printout Results

---



### **Paper curls or creases.**

---

- ❖ Paper Curls
- ❖ Paper Creases



### **Streaks (lines) appear.**

---

- ❖ White Streaks (Lines) Appear
- ❖ Streaks (lines) Appear in Gradated Portions
- ❖ Thin Lateral Streaks (Lateral Lines) Appear



### **Unevenness or smudge marks appear.**

---

- ❖ Printing Is Uneven
- ❖ Printed Pages Have White Specks
- ❖ Colors Are Uneven or Not Printed Smoothly
- ❖ The Toner Does Not Fix onto the Paper Well
- ❖ The Printed Paper Has Smudge Marks
- ❖ Smudge Marks of Spattering Toner Appear around the Text or Patterns
- ❖ The Back of the Printed Paper Has Smudge Marks
- ❖ The Overall Print Result Is Dark
- ❖ Residual Images Appear on Non-printed Areas
- ❖ White Dust Is Attached to the Printed Transparencies



### **Printing is faint, is faded, has a problem with color, and so on.**

---

- ❖ The Overall Print Result Is Faint
- ❖ Printing Is Faded
- ❖ Colored Text Appears Blurred
- ❖ Data Is Not Printed in the Correct Color (Specified Color) Due to Color Mismatches
- ❖ Thin Lines or Fill Patterns Are Not Printed with the Specified Colors or Do Not Appear At All
- ❖ Shaded Patterns Are Not Printed in the Correct Color (Specified Color)
- ❖ Photographs and so on Are Printed in Different Colors from Those Displayed on the Monitor
- ❖ Fill Patterns and Borders Are Not Printed in the Correct Color (Specified Color) Even When the Same Color Is Specified for Them
- ❖ Square Areas That Cannot Be Seen on the Display Appear around Lines or Text and Are Printed in a Different Color from the Other Areas
- ❖ Adjusting the Color and so on for Printing





## **Printout is skewed, missing, or has unneeded space.**

---

- ❖ The Printing Position Is Skewed
- ❖ A Portion of the Page Is Not Printed (Printed Data Lies Outside Paper)
- ❖ Data Is Reduced and Printed
- ❖ The Next Page Is Printed from Halfway across the Previous Page



## **Others**

---

- ❖ Blank Paper Is Output (Nothing Is Printed on the Paper)
- ❖ The Overall Surface of the Paper Is Printed in a Particular Color
- ❖ The Flap of the Printed Envelope Sticks
- ❖ Multiple Sheets of Paper Are Fed at a Time
- ❖ Printed Bar Codes Cannot Be Scanned

### **NOTE**

#### **Contacting your local authorized Canon dealer**

If a problem that is not indicated in the e-Manual occurs, if none of the suggested measures solve the problem, or if you cannot determine the problem, contact your local authorized Canon dealer.

## Paper Curls



Perform one of the following solutions according to the cause.

### <Cause 1> Damp paper is used.

#### Solution

Replace the paper with new paper in an unopened package.  
➤ ["Precautions for Paper"](#)

### <Cause 2> Appropriate paper is not being used.

#### Solution

Replace the paper with that which can be used with this printer.  
➤ ["Usable Paper"](#)

### <Cause 3> 60 g/m<sup>2</sup> paper is being used.

#### Solution

Perform the following procedure in the printer driver.

1. Display the [Paper Source] sheet.
2. Set [Paper Type] to [Thin 2].

### <Cause 4> When 60 to 74 g/m<sup>2</sup> paper is printed, depending on the operating environment (especially in a high-humidity environment), the paper may curl as either of the following.

Side View

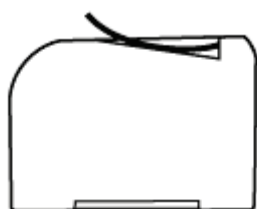

Front View

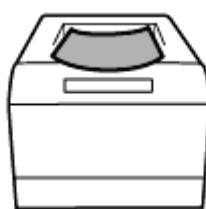

#### Solution 1

Perform the following procedure in the printer driver.

1. Display the [Paper Source] sheet.
2. Set [Paper Type] to [Thin 2].

† If you change the settings, the toner may not fix onto paper well, and the printing may come out faint.

Perform the following procedure in the Printer Status Window.

1. Display the Printer Status Window.

## Solution 2

### ➤ "Printer Status Window"

2. From the [Options] menu, select [Device Settings] → [Assisting Print Settings].
3. Select the [Perform Curl Correction for Output Paper] check box.

† [Perform Curl Correction for Output Paper] is enabled only when [Paper Type] in the [Paper Source] sheet in the printer driver is set to [Thin 1].

## Paper Creases



Perform one of the following solutions according to the cause.

### <Cause 1> The paper is not loaded properly.

#### Solution

Load the paper properly.  
➤ "Loading Paper"

### <Cause 2> Damp paper is used.

#### Solution

Replace the paper with new paper in an unopened package.  
➤ "Precautions for Paper"

### <Cause 3> Appropriate paper is not being used.

#### Solution

Replace the paper with that which can be used with this printer.  
➤ "Usable Paper"

### <Cause 4> There is a foreign object inside the printer.

#### Solution

Remove the foreign object inside the printer.

### <Cause 5> When 60 to 74 g/m<sup>2</sup> paper is printed, depending on the operating environment (especially in a high-humidity environment), the paper may be creased.

#### Solution 1

Perform the following procedure in the printer driver.

1. Display the [Paper Source] sheet.
2. Set [Paper Type] to [Thin 2].

† If you change the settings, the toner may not fix onto paper well, and the printing may come out faint.

#### Solution 2

Perform the following procedure in the Printer Status Window.

1. Display the Printer Status Window.  
➤ "Printer Status Window"
2. From the [Options] menu, select [Device Settings] → [Assisting Print Settings].
3. Select the [Perform Curl Correction for Output Paper] check box.

† [Perform Curl Correction for Output Paper] is enabled only when [Paper Type] in the [Paper Source] sheet in the printer driver is set to [Thin 1].

**<Cause 6> When printing envelopes, the envelopes may crease depending on the type of the envelopes or the operating environment (especially in a high-humidity environment).**

---

**Solution**

Perform the following procedure in the Printer Status Window.

1. Display the Printer Status Window.
  - ❖ "Printer Status Window"
2. From the [Options] menu, select [Device Settings] → [Assisting Print Settings].
3. Select the [Perform Envelope Wrinkle Reduction When Printing] check box.

## White Streaks (Lines) Appear

---

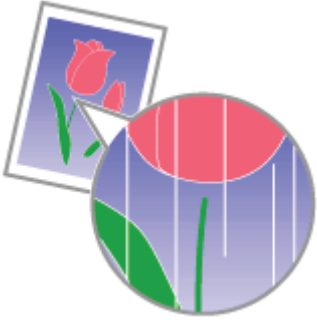

Perform the following procedure.

**<Cause> The drum in any of the toner cartridges has deteriorated.**

---

**Solution**

Replace the toner cartridges with new ones.  
➤ ["Replacing the Toner Cartridge"](#)

---

## Streaks (lines) Appear in Gradated Portions

---



Perform the following procedure.

**<Cause> [Gray Compensation] is applied to the gray color portions of the streaks (lines) in the diagram.**

---

### **Solution**

Perform the following procedure in the printer driver.

1. Display the [Quality] sheet.
2. Click [Advanced Settings].
3. Set [Gray Compensation] to [Never].

## Thin Lateral Streaks (Lateral Lines) Appear



Perform the following procedure.

**<Cause> After the printer has been idling for a long time or depending on the paper type, thin lateral streaks (lateral lines) may appear in halftone areas and white paper areas.**

### Solution 1

Perform the following procedure in the Printer Status Window.

1. Display the Printer Status Window.
  - ❖ ["Printer Status Window"](#)
2. From the [Options] menu, select [Device Settings] → [Assisting Print Settings].
3. Select the [Prevent Poor Quality after Long Idle] check box.

### Solution 2

Replace the toner cartridges with new ones.

❖ ["Replacing the Toner Cartridge"](#)

- † Use the printer with the [Prevent Poor Quality after Long Idle] check box selected in Solution 1.



## Printing Is Uneven

---



Perform one of the following solutions according to the cause.

### <Cause 1> Paper is too moist or too dry.

---

#### **Solution**

Replace the paper with new paper in an unopened package.  
❖ ["Precautions for Paper"](#)

### <Cause 2> The toner cartridges are almost out of toner.

---

#### **Solution**

Check the toner cartridges status and replace the toner cartridges of the colors are nearing the end of their life.  
❖ ["Checking the Consumables Status"](#)  
❖ ["Replacing the Toner Cartridge"](#)

### <Cause 3> The drum in any of the toner cartridges has deteriorated.

---

#### **Solution**

Replace the toner cartridges with new ones.  
❖ ["Replacing the Toner Cartridge"](#)

---

## Printed Pages Have White Specks

---

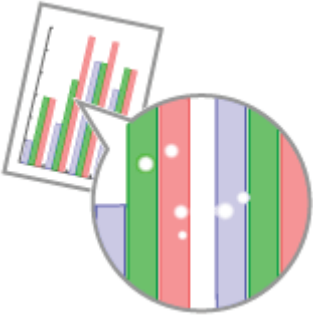

Perform one of the following solutions according to the cause.

### <Cause 1> Appropriate paper is not being used.

---

**Solution**

Replace the paper with that which can be used with this printer.  
➤ ["Usable Paper"](#)

### <Cause 2> Damp paper is used.

---

**Solution**

Replace the paper with new paper in an unopened package.  
➤ ["Precautions for Paper"](#)

### <Cause 3> The drum in any of the toner cartridges has deteriorated.

---

**Solution**

Replace the toner cartridges with new ones.  
➤ ["Replacing the Toner Cartridge"](#)

---

## Colors Are Uneven or Not Printed Smoothly

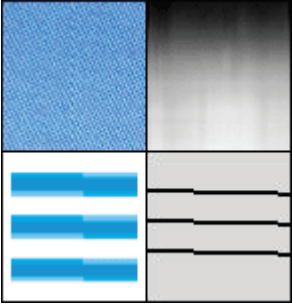

Perform the following procedure.

### <Cause> Large characters, wide lines, or diagrams with high color density were printed.

Perform the following procedure in the printer driver.

1. Display the [Finishing] sheet.
2. Click [Advanced Settings].
3. Select the appropriate mode for [Special Smoothing Mode].

Normally, select [Mode 1] for [Special Smoothing Mode].

If the following conditions occur when [Mode 1] is selected, select any setting between [Mode 2] and [Mode 6].

- **When the inside of dense graphics, large characters, or thick lines are not printed smoothly**



→ Select **[Mode 2]**.

† When [Mode 2] is selected, color unevenness may be found in light areas.

- **If the following problems occur at the same time**

– The inside of dense graphics, large characters, or thick lines are not printed smoothly.



– Outlines of light graphics, characters, and lines are not printed smoothly.



– Characters and lines against a filled background are not printed smoothly.



→ Select **[Mode 3]**.

### Solution

† When [Mode 3] is selected, color unevenness may be found in light areas and shaded patterns.

- **When outlines of light graphics, characters, and lines are not printed smoothly**



→ Select **[Mode 4]**.

† When [Mode 4] is selected, color unevenness may be found in light areas.

- **When strip-shaped unevenness appears on images (photographic images), graphics, gradations, and shaded patterns**



→ Select **[Mode 5]**.

† When [Mode 5] is selected, characters, lines, and areas around graphics may not be printed smoothly.

- **When the entire document is not printed smoothly**

→ Select **[Mode 6]**.

† When [Mode 6] is selected, color unevenness may be appear.

## The Toner Does Not Fix onto the Paper Well

---



Perform one of the following solutions according to the cause.

### <Cause 1> The setting for [Paper Type] is not specified properly.

---

#### **Solution**

Specify [Paper Type] properly.

† If you are using envelopes, specify [Envelope H].

➤ ["Basic Printing Procedure"](#)

### <Cause 2> Appropriate paper is not being used.

---

#### **Solution**

Replace the paper with that which can be used with this printer.

➤ ["Usable Paper"](#)

### <Cause 3> Depending on the paper type, toner fixation may deteriorate.

---

#### **Solution**

Perform the following procedure in the printer driver.

1. Display the [Quality] sheet.
2. Click [Advanced Settings].
3. Set [Gray Compensation] to [Always].

### <Cause 4> A problem is occurring inside the printer.

---

#### **Solution**

If <Service Error> is displayed in the Printer Status Window, perform the solution using the procedure in ["When <Service Error> Is Displayed."](#)

## The Printed Paper Has Smudge Marks

---

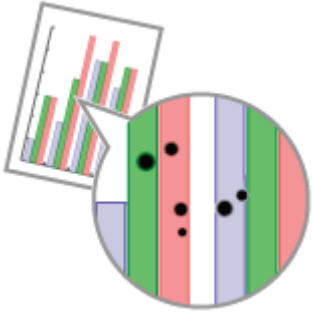

Perform the following procedure.

### <Cause> The fixing roller is dirty.

---

<b>Solution</b>	Clean the fixing roller. ➤ <a href="#">"Cleaning the Fixing Roller of the Printer"</a>
-----------------	---

---

## Smudge Marks of Spattering Toner Appear around the Text or Patterns

---



Perform the following procedure.

**<Cause> Appropriate paper is not being used.**

---

**Solution**

Replace the paper with that which can be used with this printer.  
➤ "Usable Paper"

---

## The Back of the Printed Paper Has Smudge Marks

---



Perform the following procedure.

**<Cause> The size of the print data was larger than that of the loaded paper.**

---

**Solution** Check if the size of the print data matches that of the loaded paper.

---



## The Overall Print Result Is Dark

---



Perform one of the following solutions according to the cause.

### <Cause 1> The setting for the toner density is not appropriate.

---

**Solution**

Adjust the toner density for printing to a lighter setting.  
➤ ["Adjusting the Toner Density"](#)

### <Cause 2> The printer is exposed to direct sunlight or strong light.

---

**Solution**

Move the printer.  
➤ ["Moving the Printer"](#)

---

## Residual Images Appear on Non-printed Areas



Perform one of the following solutions according to the cause.

### <Cause 1> Appropriate paper is not being used.

#### Solution

Replace the paper with that which can be used with this printer.  
➤ "Usable Paper"

### <Cause 2> When 60 to 74 g/m<sup>2</sup> paper is printed, depending on the operating environment (especially in a high-humidity environment), residual images may appear.

#### Solution 1

Perform the following procedure in the printer driver.

1. Display the [Paper Source] sheet.
2. Set [Paper Type] to [Thin 2].

† If you change the settings, the toner may not fix onto paper well, and the printing may come out faint.

#### Solution 2

Perform the following procedure in the Printer Status Window.

1. Display the Printer Status Window.  
➤ "Printer Status Window"
2. From the [Options] menu, select [Device Settings] → [Assisting Print Settings].
3. Select the [Perform Curl Correction for Output Paper] check box.

† [Perform Curl Correction for Output Paper] is enabled only when [Paper Type] in the [Paper Source] sheet in the printer driver is set to [Thin 1].

### <Cause 3> The drum in any of the toner cartridges has deteriorated.

#### Solution

Replace the toner cartridges with new ones.  
➤ "Replacing the Toner Cartridge"

## White Dust Is Attached to the Printed Transparencies

---

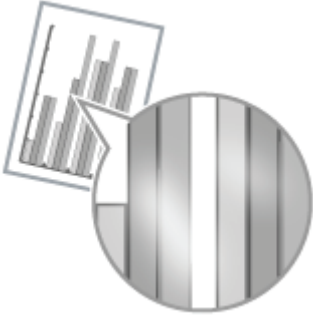

Perform the following procedure.

**<Cause> You print transparencies after printing paper other than transparency continuously.**

---

**Solution** Wipe and remove the chipped paper with a soft cloth.

---

## The Overall Print Result Is Faint



Perform one of the following solutions according to the cause.

### <Cause 1> The setting for the toner density is not appropriate.

#### **Solution**

Adjust the toner density for printing to a darker setting.  
➤ ["Adjusting the Toner Density"](#)

### <Cause 2> [Toner Save] is enabled.

#### **Solution**

Perform the following procedure in the printer driver.

1. Display the [Quality] sheet.
2. Click [Advanced Settings].
3. Set [Toner Save] to [Off].

## Printing Is Faded

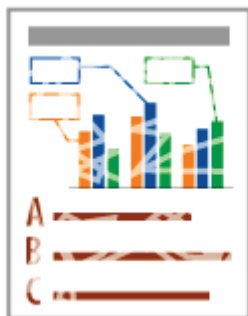

Perform one of the following solutions according to the cause.

### <Cause 1> The setting for [Paper Type] is not specified properly.

<b>Solution</b>	Specify [Paper Type] properly. ↑ If you are using envelopes, specify [Envelope H]. ➤ "Basic Printing Procedure"
-----------------	---

### <Cause 2> Appropriate paper is not being used.

<b>Solution</b>	Replace the paper with that which can be used with this printer. ➤ "Usable Paper"
-----------------	--

### <Cause 3> The toner cartridges have reached the end of their life.

<b>Solution</b>	Check the toner cartridges status and replace the toner cartridges of the colors have reached the end of their life. ➤ "Checking the Consumables Status" ➤ "Replacing the Toner Cartridge"
-----------------	--

### <Cause 4> When coarse paper is used, the toner does not fix onto paper well, and the print may come out faint.

<b>Solution</b>	Perform the following procedure in the Printer Status Window. 1. Display the Printer Status Window. ➤ "Printer Status Window" 2. From the [Options] menu, select [Device Settings] → [Paper Source Settings]. 3. Select the [Use Rough Paper] check box.
-----------------	--

### <Cause 5> Thin lines or text was printed.

<b>Solution</b>	Perform the following procedure in the printer driver. 1. Display the [Finishing] sheet. 2. Click [Advanced Settings]. 3. Set [Special Fine Line Processing] to [On].
-----------------	--

## Colored Text Appears Blurred

---



Perform one of the following solutions according to the cause.

### <Cause 1> A bold font is being used for the colored text.

---

#### **Solution**

Perform the following procedure in the printer driver.

1. Display the [Quality] sheet.
2. Select the [Manual Color Settings] check box.
3. Click [Color Settings].
4. Display the [Matching] sheet.
5. Set [Matching Method] to [Perceptual [Monitor Color Matched]].

### <Cause 2> Colored text appears blurred due to color mismatches.

---

#### **Solution**

Perform the described solutions in "[Data Is Not Printed in the Correct Color \(Specified Color\) Due to Color Mismatches.](#)"

# Data Is Not Printed in the Correct Color (Specified Color) Due to Color Mismatches



Perform one of the following solutions according to the cause.

## <Cause 1> The toner cartridges are not installed properly.

### Solution

Check the installation status of the toner cartridges.

- ["Replacing the Toner Cartridge"](#)

## <Cause 2> Appropriate paper is not being used.

### Solution

Replace the paper with that which can be used with this printer.

- ["Usable Paper"](#)

## <Cause 3> The toner cartridges are almost out of toner.

### Solution 1

Correct color mismatches.

- ["Correcting Color Mismatches \(Color Mismatch Correction\)"](#)

### Solution 2

Check the toner cartridges status and replace the toner cartridges of the colors are nearing the end of their life.

- ["Checking the Consumables Status"](#)
- ["Replacing the Toner Cartridge"](#)

## <Cause 4> The drum in any of the toner cartridges has deteriorated.

### Solution

Replace the toner cartridges with new ones.

- ["Replacing the Toner Cartridge"](#)

## <Cause 5> Printed before performing calibration or color mismatch correction immediately after the printer is turned ON and so on.

### Solution

Make sure that calibration or color mismatch correction is completed before sending data to the printer.

- † Specify whether calibration or color mismatch correction should be performed immediately after the printer is turned ON.
  - ["Auto Image Quality Adjustment Settings"](#)

## <About color mismatch>

Laser printers are manufactured with technology of high precision. A color mismatch may be slightly conspicuous

depending on the print image. Please note that this is due to the structure of laser printers and is not a printer malfunction.

---



## Thin Lines or Fill Patterns Are Not Printed with the Specified Colors or Do Not Appear At All



Perform one of the following solutions according to the cause.

### <Cause 1> Some of the colors cannot be reproduced because of the combination of colors or patterns.

#### **Solution 1**

Adjust the colors in the application and print again.  
See the instruction manual supplied with the application.

#### **Solution 2**

Change the patterns in the application and print again.  
See the instruction manual supplied with the application.

### <Cause 2> The colors may appear different depending on the halftone pattern.

#### **Solution 1**

Readjust to a darker color and print again.  
See the instruction manual supplied with the application.

#### **Solution 2**

Reload paper to change the feeding direction, then print again.

## Shaded Patterns Are Not Printed in the Correct Color (Specified Color)

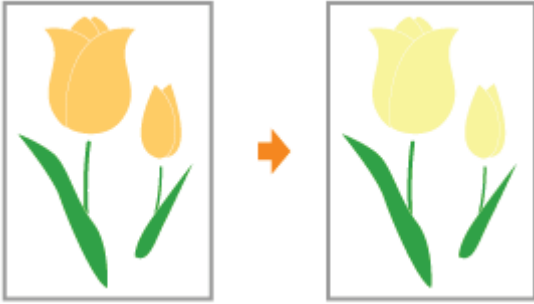

Perform the following procedure.

**<Cause> The shaded pattern of the print data and the dither pattern of the printer are interfering with one another.**

### **Solution 1**

Print again without specifying a shaded pattern in the application.  
See the instruction manual supplied with the application.

### **Solution 2**

Perform the following procedure in the printer driver.

1. Display the [Quality] sheet.
2. Click [Advanced Settings].
3. Change the [Halftones] setting.

## Photographs and so on Are Printed in Different Colors from Those Displayed on the Monitor



Perform the following procedure.

**<Cause> The methods for adjusting the color on the screen (RGB) and in the printer (YMC) are different. Therefore, the color on the screen may not be printed out exactly as it appears.**

### Solution 1

Perform the following procedure in the printer driver.

1. Display the [Quality] sheet.
2. Select the [Manual Color Settings] check box.
3. Click [Color Settings].
4. Display the [Matching] sheet.
5. Set [Matching Method] to [Perceptual [Monitor Color Matched]].

### Solution 2

Perform the following procedure in the printer driver.

1. Display the [Quality] sheet.
2. Select the [Manual Color Settings] check box.
3. Click [Color Settings].
4. Display the [Matching] sheet.
5. Select [Gamma Adjustment] in [Matching Mode].
6. Change the gamma value for [Gamma].

† The larger the value is, the darker in color the data is printed.

## Fill Patterns and Borders Are Not Printed in the Correct Color (Specified Color) Even When the Same Color Is Specified for Them



Perform the following procedure.

**<Cause> A special process may be applied depending on the line width of the border so that thin lines are printed clearly.**

### **Solution**

Perform the following procedure in the printer driver.

1. Display the [Quality] sheet.
2. Select the [Manual Color Settings] check box.
3. Click [Color Settings].
4. Display the [Matching] sheet.
5. Select [Gamma Adjustment] in [Matching Mode].
6. Change the gamma value for [Gamma].

† The larger the value is, the darker in color the data is printed.

## Square Areas That Cannot Be Seen on the Display Appear around Lines or Text and Are Printed in a Different Color from the Other Areas



Perform the following procedure.

**<Cause> A process that is different from the specified halftone process or color process may be applied depending on the operating system or application.**

### **Solution 1**

Perform the following procedure in the printer driver.

1. Display the [Quality] sheet.
2. Click [Advanced Settings].
3. Set [Gray Compensation] to [Always] or [Never].

### **Solution 2**

Perform the following procedure in the printer driver.

1. Display the [Quality] sheet.
2. Click [Advanced Settings].
3. Set [Halftones] to [Resolution], [High Resolution], or [Gradation].

## Adjusting the Color and so on for Printing

This printer allows you to print with performing the following adjustments and corrections.

### Adjusting the Toner Density

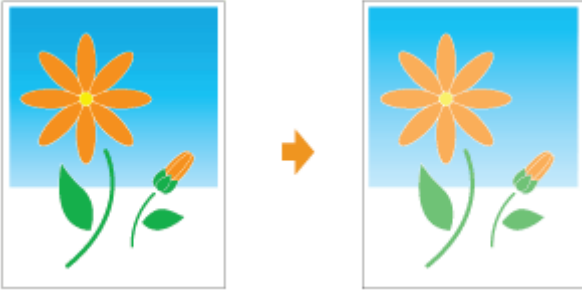

### Printing with Brightness and Contrast Adjusted



### Adjusting the Color



### Matching the Color with the Screen

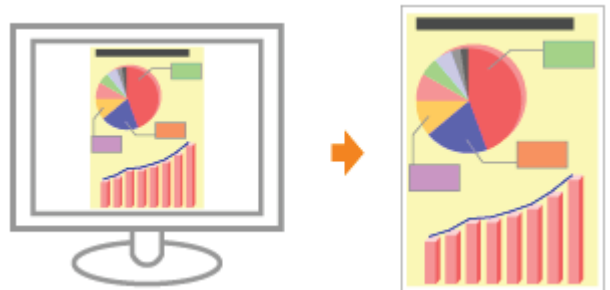

### Adjusting Colors and Correcting Color Mismatches (Calibration/Color Mismatch Correction)



## The Printing Position Is Skewed

---

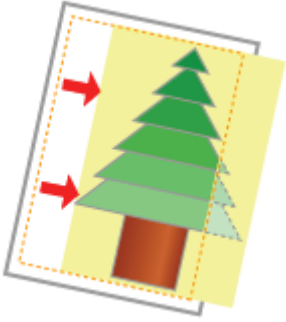

Perform one of the following solutions according to the cause.

### <Cause 1> [Gutter] is specified.

---

#### **Solution**

Perform the following procedure in the printer driver.

1. Display the [Finishing] sheet.
2. Click [Gutter].
3. Set [Gutter] to "0."

### <Cause 2> "Top Margin" and "Paper Position" in the application are not specified properly.

---

#### **Solution**

Specify the settings for "Top Margin" and "Paper Position" in the application properly.  
See the instruction manual supplied with the application.

---

## A Portion of the Page Is Not Printed (Printed Data Lies Outside Paper)



Perform one of the following solutions according to the cause.

### <Cause 1> The setting for the scaling factor is not appropriate.

<b>Solution 1</b>	<p>Perform the following procedure in the printer driver.</p> <ol style="list-style-type: none"><li>1. Display the [Page Setup] sheet.</li><li>2. Clear the [Manual Scaling] check box.</li></ol> <p>† If the [Manual Scaling] check box is cleared, the scale factor will be set according to [Page Size] and [Output Size] automatically.</p>
<b>Solution 2</b>	<p>Perform the following procedure in the printer driver.</p> <ol style="list-style-type: none"><li>1. Display the [Page Setup] sheet.</li><li>2. Select the [Manual Scaling] check box, then specify an appropriate scale factor according to the paper size to be used.</li></ol>

### <Cause 2> The position of the paper is incorrect.

<b>Solution</b>	<p>Load the paper properly.</p> <p>➤ "Loading Paper"</p>
-----------------	--

### <Cause 3> A document with no margins was printed.

<b>Solution 1</b>	<p>Data is printed with a margin of 5 mm (10 mm for envelopes). Provide a margin around the data.</p> <p>➤ "Printable Area"</p>
<b>Solution 2</b>	<p>Perform the following procedure in the printer driver.</p> <ol style="list-style-type: none"><li>1. Display the [Finishing] sheet.</li><li>2. Click [Advanced Settings].</li><li>3. Set [Expand Print Region and Print] to [On].</li></ol> <p>† Depending on the print data to be printed, the edge of paper may be missing partly during printing or may blot during color printing.</p>

### <Cause 4> The loaded paper is smaller than the paper drawer or the paper size setting for the job.



**Solution**

Load paper that matches the paper size setting, or change the paper size setting to match the paper.

- ❖ "Loading Paper"
- ❖ "Registering the Paper Size and Type"

**<Cause 5> When printing the following paper, the paper is loaded with an orientation (feed direction) that differs from that of the paper drawer or the paper setting for the job.**

---

- A5 paper
- Statement paper
- Custom size paper with a width and length (height) between 127.0 and 215.9 mm

**Solution**

Load paper with the orientation (feed direction) that matches the paper setting, or change the setting of the paper feed direction to match the paper.

- ❖ "Loading Paper"
- ❖ "Registering the Paper Size and Type"

## Data Is Reduced and Printed



Perform the following procedure.

### <Cause> The setting for the scaling factor is not appropriate.

<b>Solution 1</b>	<p>Perform the following procedure in the printer driver.</p> <ol style="list-style-type: none"><li>1. Display the [Page Setup] sheet.</li><li>2. Clear the [Manual Scaling] check box.</li></ol> <p>† If the [Manual Scaling] check box is cleared, the scale factor will be set according to [Page Size] and [Output Size] automatically.</p>
<b>Solution 2</b>	<p>Perform the following procedure in the printer driver.</p> <ol style="list-style-type: none"><li>1. Display the [Page Setup] sheet.</li><li>2. Select the [Manual Scaling] check box, then specify an appropriate scale factor according to the paper size to be used.</li></ol>

## The Next Page Is Printed from Halfway across the Previous Page

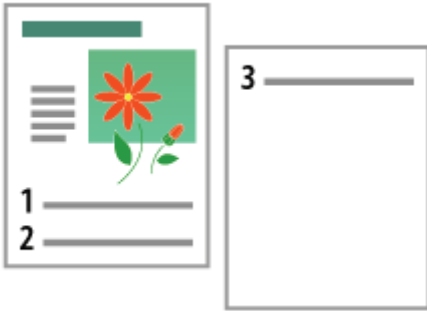

Perform the following procedure.

**<Cause> "Line Spacing" or "Lines/Page" in the application is not specified properly.**

### **Solution**

Specify the settings for "Line Spacing" or "Lines/Page" in the application so that the data fits in one page, and then print again.

See the instruction manual supplied with the application.

## Blank Paper Is Output (Nothing Is Printed on the Paper)

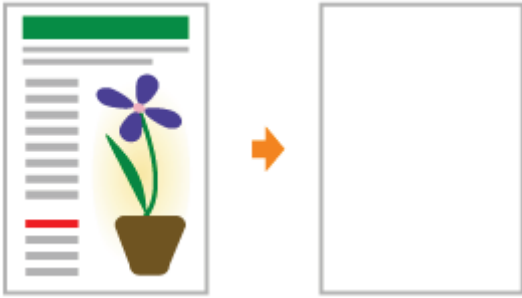

Perform one of the following solutions according to the cause.

### <Cause 1> The toner cartridges were installed with the sealing tape still attached.

#### **Solution**

Take the toner cartridges out of the printer, pull out the sealing tape, and reinstall the toner cartridges.  
➤ ["Replacing the Toner Cartridge"](#)

### <Cause 2> Multiple sheets of paper are fed at a time.

#### **Solution**

Fan the paper thoroughly, and then align the edges of the stack properly on a hard, flat surface.

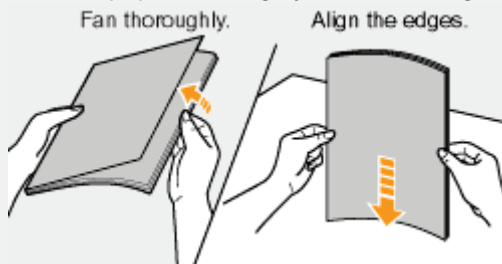

## The Overall Surface of the Paper Is Printed in a Particular Color

---

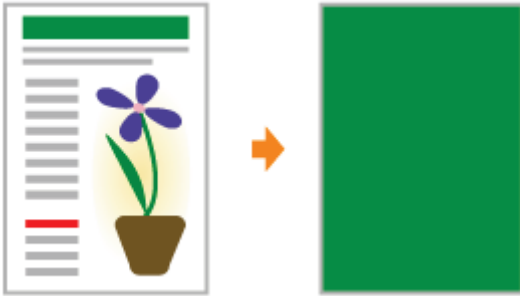

Perform one of the following solutions according to the cause.

### <Cause 1> The drum in any of the toner cartridges has deteriorated.

---

#### **Solution**

Replace the toner cartridges with new ones.  
➤ ["Replacing the Toner Cartridge"](#)

### <Cause 2> A problem is occurring inside the printer.

---

#### **Solution**

When <Service Error> is displayed in the Printer Status Window, perform the solution using the procedure in ["When <Service Error> Is Displayed."](#)

---

## The Flap of the Printed Envelope Sticks

---

Perform one of the following solutions according to the cause.

### <Cause 1> The envelope is inappropriate.

---

#### **Solution**

Replace the envelope with that which can be used with this printer.  
➤ "Usable Paper"

### <Cause 2> Depending on the type of the envelopes or the operating environment (especially in a high-humidity environment), the flaps may stick to the body of the envelopes.

---

#### **Solution**

Perform the following procedure in the Printer Status Window.

1. Display the Printer Status Window.  
➤ "Printer Status Window"
  2. From the [Options] menu, select [Device Settings] → [Paper Source Settings].
  3. Select the [Perform Envelope Cling Prevention When Printing] check box.
-

## Multiple Sheets of Paper Are Fed at a Time



Perform the following procedure.

**<Cause> You are using paper which tends to be fed at a time.**

**Solution**

Fan the paper thoroughly, and then align the edges of the stack properly on a hard, flat surface.

A diagram illustrating the solution in two steps. The first step, labeled 'Fan thoroughly.', shows a pair of hands holding a stack of paper and fanning it out. The second step, labeled 'Align the edges.', shows a pair of hands holding the fanned paper over a surface, with a vertical dashed arrow pointing downwards to indicate the alignment of the edges.

## Printed Bar Codes Cannot Be Scanned



Perform the following procedure.

### <Cause> Depending on the type or size of bar code, scanning may be difficult.

<b>Solution 1</b>	<p>Set [Black]* in [Toner Density] in the printer driver to a lighter setting ([-2] or [-1]).</p> <ul style="list-style-type: none"><li>▣ <a href="#">"Adjusting the Toner Density"</a></li></ul> <p>* Adjust the color used to print a bar code.</p> <p>† When printing with a lighter toner density, the print may come out faint.</p>
<b>Solution 2</b>	<p>Perform the following procedure in the printer driver.</p> <ol style="list-style-type: none"><li>1. Display the [Finishing] sheet.</li><li>2. Click [Advanced Settings].</li><li>3. Change the [Special Settings 1] setting.</li></ol> <p>† Improving effectiveness for bar code printing increases in the following order.</p> <p>[Off] → [Mode 1] → [Mode 2] → [Mode 3] → [Mode 4] → [Mode 5] (Effect: Low) (Effect: High)</p>



## If You Cannot Solve a Problem

If the problem cannot be solved by referring to the e-Manual, contact your local authorized Canon dealer or Canon help line (☞ "Office Locations").

### Please have the following information ready when contacting the Canon:

- Product name (LBP7100Cn/LBP7110Cw)
- Serial number (see the following illustrations to find the location of the serial number.)

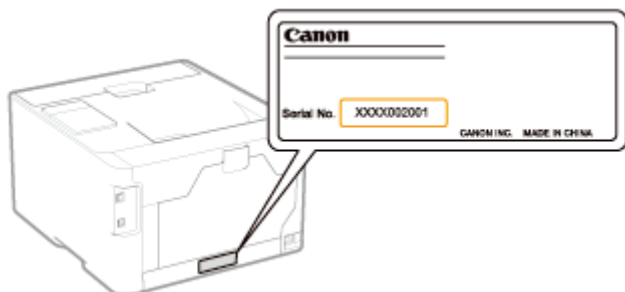

- Place of purchase
- Nature of the problem
- Steps you have taken to solve the problem and the results

### **WARNING**

#### **If the machine makes strange noises or emits smoke or an odd odor**

Turn OFF the power switch immediately, disconnect the power cord, and contact the Canon Customer Care Center. Do not attempt to disassemble or repair the machine yourself.

### **IMPORTANT**

#### **If you attempt to repair the machine by yourself**

It may void the limited warranty.

# Appendix

---

➤ **Points to Make Full Use of the Printer**

➤ **Basic Operations/Various Information for Windows**

➤ **For Windows 8/Server 2012 Users**

➤ **For Macintosh Users**

---

## Points to Make Full Use of the Printer

You can maximize the use of the printer by familiarizing with software tasks and functions supplied with the printer.

### Printer Driver

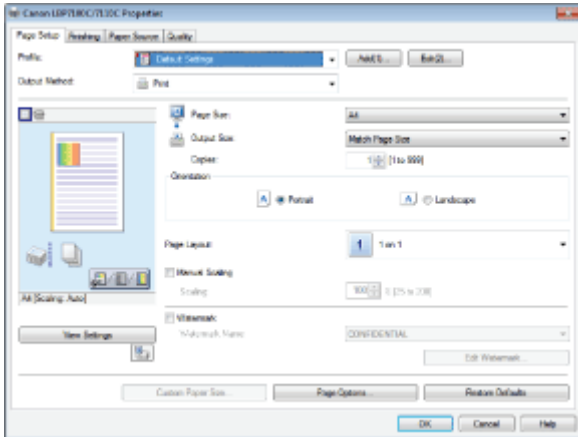

The printer driver is software allows you to control the printer with the printing instructions from the computer. The printer driver is equipped with a useful printing function and you can use it with freely combining the settings.

#### ➤ Displaying the Setting Screen

#### <Pick Up>

##### **Saving Paper**

##### **Using Functions for Internal Documents**

##### **Being Particular About the Image Quality or Colors**

##### ➤ **Layout Printing (N-page Print)**

##### ➤ **Adding a Watermark to a Document to Be Printed (Watermark Printing)**

##### ➤ **Adjusting the Image Quality or Colors**

### Printer Status Window

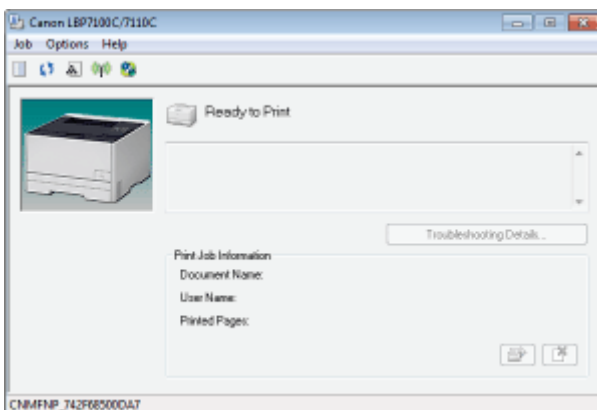

The Printer Status Window is software allows you to check the printer status, specify the settings for the printer unit, and so on. The Printer Status Window is convenient because it simply notifies the printer status such as paper jams, life of the toner cartridges, and paper-out conditions with messages, animations, and so on.

#### ➤ Printer Status Window

#### <Pick Up>

##### **Canceling a Job**

##### **Periodical Cleaning**

##### **Saving Power Consumption**

##### ➤ **Canceling a Job Being Printed or Waiting to Be Printed from the Computer**

##### ➤ **Cleaning the Printer**

##### ➤ **Energy-saving Mode**

## Network Utilities

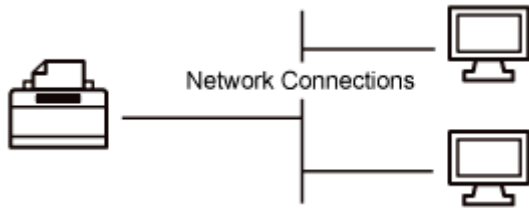

Useful utilities are available to perform the printer management and so on.

Because the items you can manage differ depending on the software, use the software according to your environment or the item you want to manage.

### ➤ Introduction of the Utilities

---

### ➤ Software That Can Be Used for Managing the Printer

---

## Basic Operations/Various Information for Windows

- ❖ Displaying [Computer] or [My Computer]
- ❖ Setting the IP Address Using the ARP/PING Command
- ❖ Displaying the CD-ROM Top Page
- ❖ Checking the IP Address Using the PING Command
- ❖ Checking the Processor Version of Windows Vista, 7, or Server 2008
- ❖ Printing a Test Page in Windows
- ❖ Checking the Bi-directional Communication
- ❖ Installing with Plug and Play
- ❖ Displaying the Printer Folder
- ❖ Checking Printers in the Print Server
- ❖ Checking the Port
- ❖ Values for Setting a Port
- ❖ Setting for [Device Type] when Setting a Port

### Displaying [Computer] or [My Computer]

**Windows XP** **Windows Server 2003**

From the [Start] menu, select [My Computer].

**Windows Vista** **Windows 7** **Windows Server 2008**

From the [Start] menu, select [Computer].

### Setting the IP Address Using the ARP/PING Command

#### 1

**Make sure that the printer and computer are connected properly, and the printer is turned ON.**

- ❖ "Connecting the Printer and Computer"

#### 2

**Turn the computer on, and then log on to Windows as a user with administrative rights.**

#### 3

**Run Command Prompt.**

From the [Start] menu, select [All Programs] → [Accessories] → [Command Prompt].

#### 4

**Enter "arp -s <IP address> <MAC address>", then press the [ENTER] key on your keyboard.**

<IP address>	Enter the IP address to assign to the printer. Specify the address with four numbers (from 0 to 255) separated with a period (.).
<MAC address>	Enter the MAC address of the printer. Separate the number every two digits with a hyphen (-).

- **Input Example:** "arp -s 192.168.0.215 00-1E-8F-05-70-31"

## NOTE

### Checking the MAC address

➤ "Checking the MAC Address of the Printer"

## 5

Enter "**ping <IP address> -l 479**", then press the **[ENTER]** key on your keyboard.

<IP address>

Enter the same IP address as the one entered in Step 4.

† Enter a lowercase "l" for "-l".

• **Input Example:** "ping 192.168.0.215 -l 479"

→ The IP address is set for the printer.

† The subnet mask is set automatically according to the IP address.

† The gateway address is set to [0.0.0.0].

## 6

Enter "**exit**", then press the **[ENTER]** key on your keyboard.

→ Command Prompt closes.

## Displaying the CD-ROM Top Page

If the CD-ROM top page does not appear even after inserting the CD-ROM, perform the following procedure.

† The CD-ROM drive name is indicated as "D:" in this manual. The CD-ROM drive name may differ depending on the computer you are using.

### Windows XP Windows Server 2003

1. From the [Start] menu, select [Run].
2. Enter "D:\English\MInst.exe."

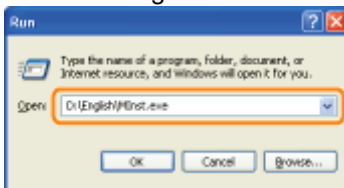

3. Click [OK].

### Windows Vista Windows 7 Windows Server 2008

1. Enter "D:\English\MInst.exe" in [Search programs and files] or [Start Search] under the [Start] menu.

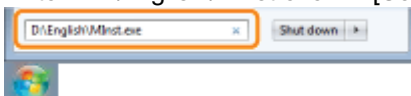

2. Press the [ENTER] key on the keyboard.

## Checking the IP Address Using the PING Command

# 1

## Run Command Prompt.

From the [Start] menu, select [All Programs] → [Accessories] → [Command Prompt].

# 2

## Enter "ping <the IP address of the printer>", then press the [ENTER] key on your keyboard.

- **Input Example:** "ping 192.168.0.215"

- † Correctly enter the IP address which is set for the printer. If the wrong IP address is entered, you cannot obtain an appropriate check result.
- † If you are not sure about the IP address of the printer, see "[Checking the IP Address of the Printer.](#)"

# 3

## Check the displayed result.

- **When "Packets: Sent = 4, Received = 4, Lost = 0 (0% loss)," is displayed**  
The IP address is set properly.
- **When "Packets: Sent = 4, Received = 0, Lost = 4 (100% loss)," is displayed**  
Ask your network administrator about the problem.

# 4

## Enter "exit", and then press [ENTER] on the keyboard to exit Command Prompt.

### NOTE

#### Checking and configuring the subnet

Enter "ipconfig" as a command in Command Prompt.

The network setting information of the computer appears. Confirm that the computer and printer are on the same subnet.

#### <Example>

Setting in a computer

- Subnet mask: "255.255.255.0"   ▶ The IP address of the printer needs to be "192.168.0.xxx". (xxx indicates an arbitrary number.)
- IP Address: "192.168.0.10"

## Checking the Processor Version of Windows Vista, 7, or Server 2008

If you are not sure whether you are using 32-bit Windows Vista/7/Server 2008 or 64-bit Windows Vista/7/Server 2008, you can check that using the following procedure.

# 1

## From the [Start] menu, select [Control Panel].

# 2

## Display [System].

**Windows Vista** **Windows 7** **Windows Server 2008 R2**

Click [System and Security] or [System and Maintenance] → [System].

**Windows Server 2008**

Double-click [System].

### 3

#### Check the processor version.

##### For a 32-bit operating system

[32-bit Operating System] is displayed.

##### For a 64-bit operating system

[64-bit Operating System] is displayed.

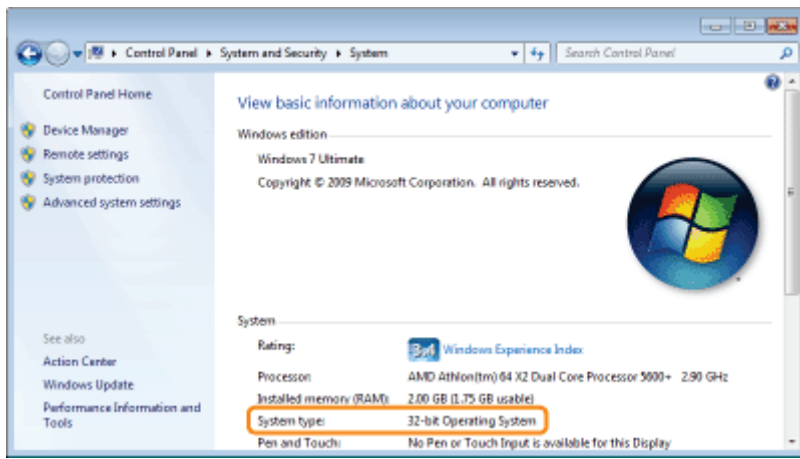

## Printing a Test Page in Windows

You can check the operations of the printer driver by printing a test page in Windows.

### 1

#### Load A4 paper in the paper drawer.

❖ "Loading Paper"

### 2

#### Open the printer folder.

❖ "Displaying the Printer Folder"

### 3

#### Right-click the icon for this printer, and then select [Printer properties] or [Properties] from the pop-up menu.



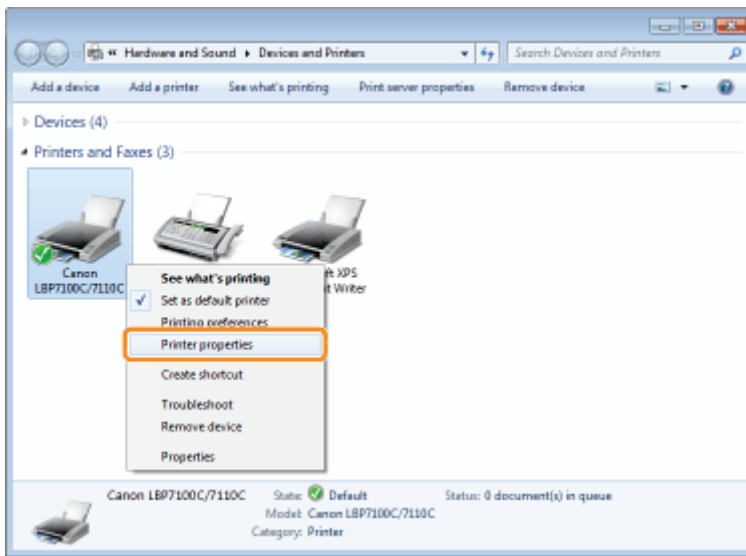

## 4

### Print a test page.

- (1) Display the [General] sheet.
- (2) Click [Print Test Page] to print a test page.

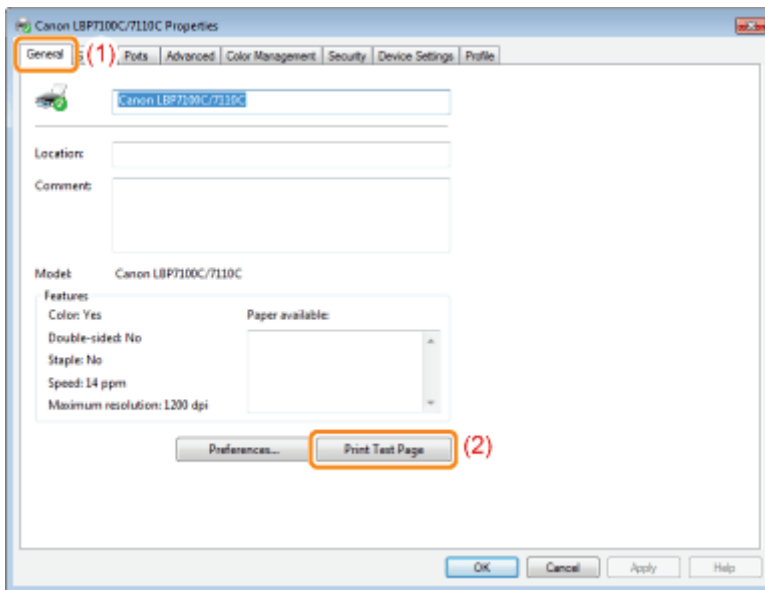

## Checking the Bi-directional Communication

### 1

#### Open the printer folder.

- "Displaying the Printer Folder"

### 2

#### Right-click the icon for this printer, and then select [Printer properties] or [Properties] from the pop-up menu.

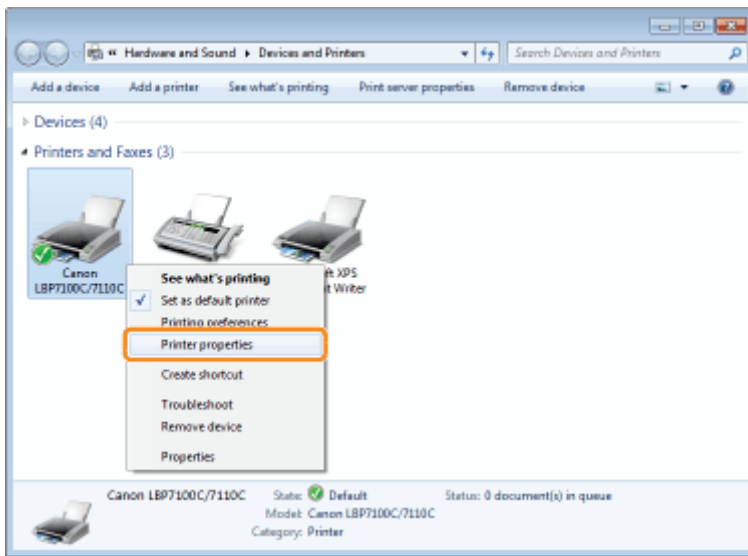

### 3

#### Check the bi-directional communication.

- (1) Display the [Ports] sheet.
- (2) Check the [Enable bidirectional support] check box is selected.

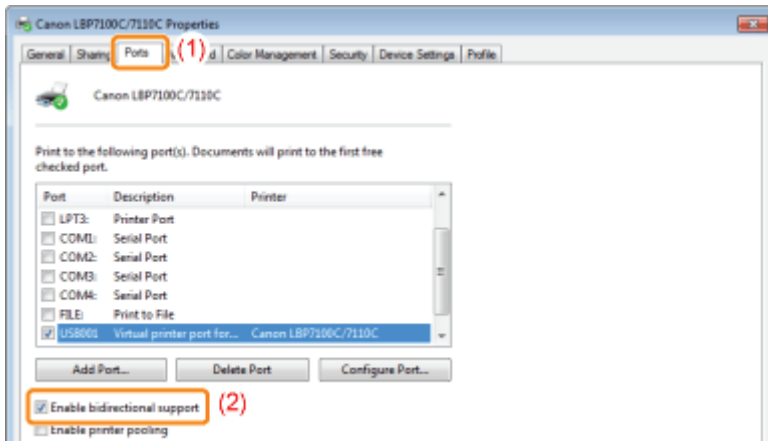

#### IMPORTANT

**Do not clear the [Enable bidirectional support] check box.**

If the check box is cleared, you cannot perform printing.

### Installing with Plug and Play

- † If you are using Windows 7 or Server 2008 R2, install the printer driver in "Easy Installation."  
(You may not be able to install the printer driver properly due to the Windows restriction even after detecting the printer with Plug and Play.)

### 1

#### Connect the USB cable.

- "Connecting the Printer and Computer"

## 2

**Turn the printer ON.**

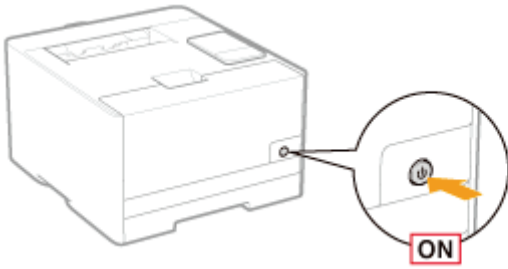

## 3

**Turn the computer on, and then log on to Windows as a user with administrative rights.**

→ The automatic setup screen of Plug and Play appears.

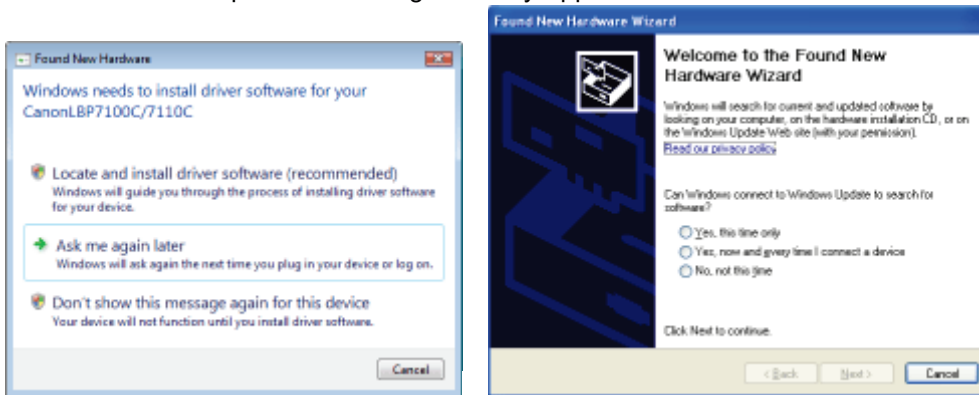

### **? If the printer driver is installed automatically**

If you installed the printer driver for this printer previously, the driver is installed automatically.

If you want to update the printer driver (or want to install it manually), install the printer driver after uninstalling it once.

➤ ["Uninstalling the Printer Driver"](#)

### **? If the following screen appears**

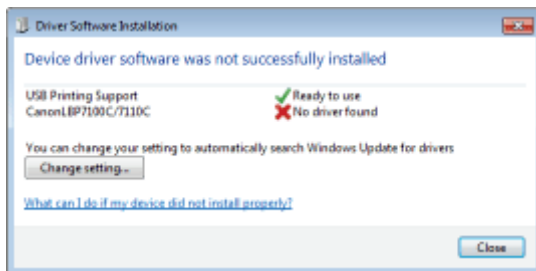

You may not be able to install the printer driver properly due to the Windows restriction even after detecting the printer with Plug and Play.

Click [Close], and then reinstall the printer driver in ["Easy Installation."](#)

## 4

**Follow the on-screen instructions to install the printer driver.**

### **NOTE**

**When selecting the folder in which the printer driver is included.**

Select one of the following folders.

- **For a 32-bit operating system**

Select the folders in the supplied CD-ROM: [English] - [32bit] - [Driver].

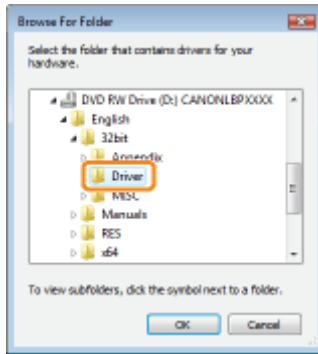

- **For a 64-bit operating system**

Select the folders in the supplied CD-ROM: [English] - [x64] - [Driver].

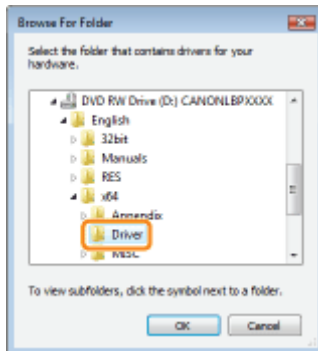

† If you are not sure whether you are using 32-bit Windows Vista/Server 2008 or 64-bit Windows Vista/Server 2008, see "[Checking the Processor Version of Windows Vista, 7, or Server 2008.](#)"

### If the screen for selecting the printer driver appears

Even if which printer driver is selected, there is no problem with the installation because the same printer driver is installed.

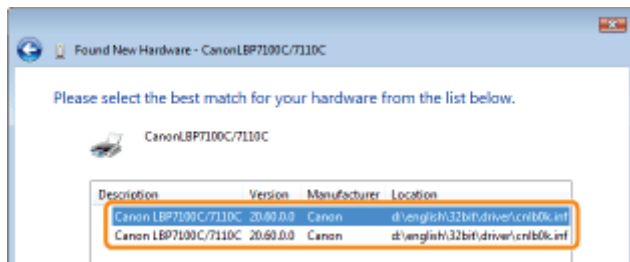

When the installation is complete, an icon for this printer will be created.  
➤ "After Installation"

## Displaying the Printer Folder

### Windows XP Professional Windows Server 2003

From the [Start] menu, select [Printers and Faxes].

### Windows XP Home Edition

From the [Start] menu, select [Control Panel], and then click [Printers and Other Hardware] → [Printers and Faxes].

### Windows Vista

From the [Start] menu, select [Control Panel], and then click [Printer].

### Windows 7 Windows Server 2008 R2

From the [Start] menu, select [Devices and Printers].

From the [Start] menu, select [Control Panel], and then double-click [Printers].

## Checking Printers in the Print Server

### 1

**Display [Windows Explorer].**

From the [Start] menu, select [All Programs] → [Accessories] → [Windows Explorer].

### 2

**Check printers in the print server.**

- (1) Select the print server from [Network] or [My Network Places].
- (2) Check the icon for this printer is displayed.

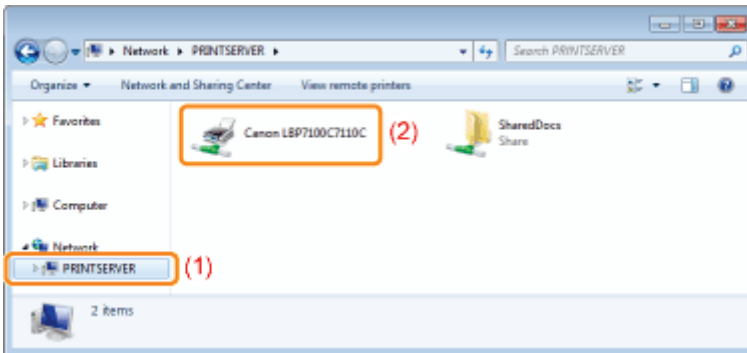

## Checking the Port

### 1

**Open the printer folder.**

➤ "Displaying the Printer Folder"

### 2

**Right-click the icon for this printer, and then select [Printer properties] or [Properties] from the pop-up menu.**

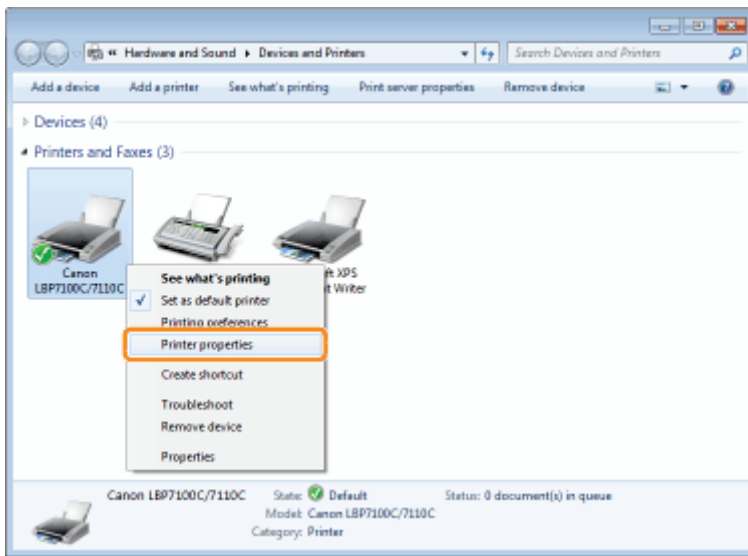

### 3

#### Check a port.

- (1) Display the [Ports] sheet.
- (2) Check the port that is being used.

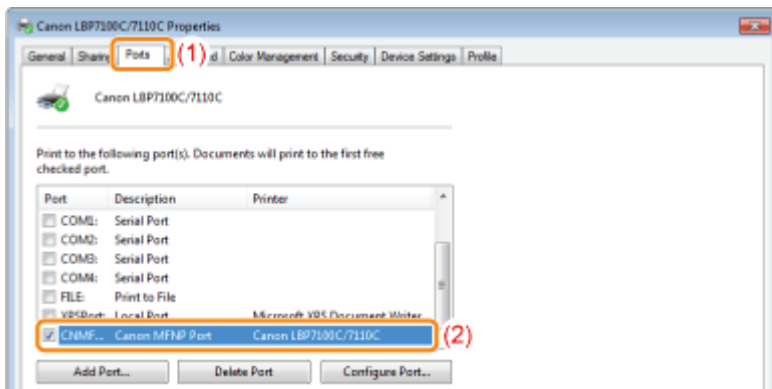

#### Values for Setting a Port

Depending on the method for setting the IP address of the printer, the value to be entered in [Printer Name or IP Address] on the following screen displayed in the process of port setting varies.

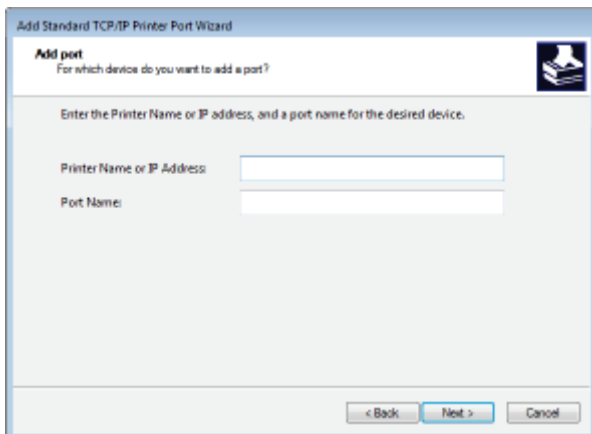

#### If you want to set the IP address to be assigned to the printer manually (If you know the IP address to use)

- Enter the IP address in [Printer Name or IP Address].
  - ❏ "Checking the IP Address of the Printer"

- If you want to set the IP address using the DNS server, specify the DNS settings for the printer. Then, enter the printer name (the DNS name registered on the DNS server) within up to 78 characters in [Printer Name or IP Address]. For example, enter the printer name as "AAA.BBB.com" if you specified the host name as "AAA" and the domain name as "BBB.com". However, enter "AAA.CCC.com" if you can obtain the domain name (CCC.com) simultaneously when you obtain the IP address from DHCP and so on.

### If you want to set the IP address to be assigned to the printer using DHCP and so on

- Specify the settings such as the DHCP settings so that the same IP address is always assigned to the printer when you start the printer. For more details, see "If you want to set the IP address to be assigned to the printer manually" above.
- If a different IP address is assigned to the printer each time the printer starts, specify the DNS settings for the printer first. Then, enter the printer name (the DNS name registered on the DNS server) within up to 78 characters in [Printer Name or IP Address]. For example, enter the printer name as "AAA.BBB.com" if you specified the host name as "AAA" and the domain name as "BBB.com". However, enter "AAA.CCC.com" if you can obtain the domain name (CCC.com) simultaneously when you obtain the IP address from DHCP and so on.

#### NOTE

#### About the DNS settings

See "[Configuring the Protocol Settings.](#)"

### Setting for [Device Type] when Setting a Port

If the printer cannot be detected when setting a port, set [Device Type] as follows.

- (1) Select [Standard], and then select [Canon Network Printing Device with P9100].
- (2) Click [Next].

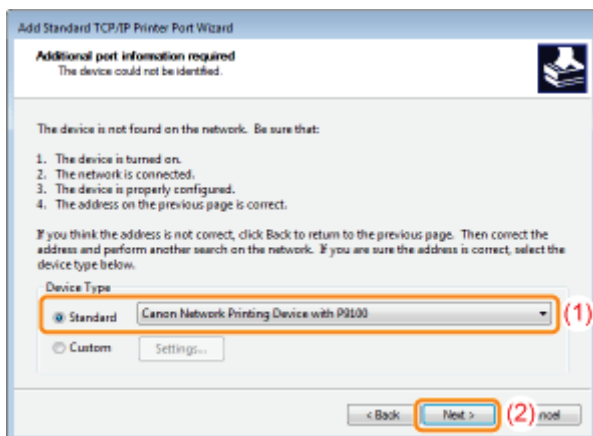

## For Windows 8/Server 2012 Users

---

This printer supports Windows 8/Server 2012 operating system. For operation and description on Windows 8/Server 2012, refer to Windows Vista/7 sections. This section describes notes on using this printer with Windows 8/Server 2012. Read this section carefully before using the printer.

### Precautions

Use the desktop mode when performing the followings.

- Installing/Uninstalling the printer driver
- Displaying the Printer Status Window
- Setting the printer driver \*

\* Please note that the setting specified on the desktop may not be reflected to all Windows Store applications.

---



## For Macintosh Users

In the e-Manual, methods to operate in the Windows environment are explained as examples. To view how to use printer drivers or utilities for Macintosh, see the "Printer Driver Guide for Macintosh."

### Displaying the "Printer Driver Guide for Macintosh"

Double-click [index.html] in the [SFP] - [Documents] - [uk\_eng] - [GUIDE] folder in the supplied CD-ROM.



### Content of the e-Manual about Features that Are Unavailable on the Macintosh

Among the features explained in the e-Manual, the followings are unavailable on the Macintosh.

Contents Not Available for Macintosh	Reference in the e-Manual
Installing and uninstalling the e-Manual	<ul style="list-style-type: none"><li>➤ "Installing the e-Manual"</li><li>➤ "Uninstalling the e-Manual"</li></ul>
Printer Status Window <sup>*1</sup>	<ul style="list-style-type: none"><li>➤ "Printer Status Window"</li></ul>
Parts of the print setting items <sup>*2</sup>	<ul style="list-style-type: none"><li>➤ "Useful Printing Functions"</li></ul>
Changing the default values for printing preferences	<ul style="list-style-type: none"><li>➤ "Changing the Default Values for Printing Preferences"</li></ul>
Notifying the printer of the time	<ul style="list-style-type: none"><li>➤ "Configuring the Protocol Settings"</li></ul>
Operating in the print server environment	<ul style="list-style-type: none"><li>➤ "If You Use the Printer in the Print Server Environment"</li></ul>
Deleting the USB class driver	<ul style="list-style-type: none"><li>➤ "Uninstalling the USB Class Driver"</li></ul>

<sup>\*1</sup> If you are using Macintosh, use the Statusmonitor. (For details on the Statusmonitor, see the "Printer Driver Guide for Macintosh.")

<sup>\*2</sup> For items that you can specify in the printer driver for Macintosh, see the "Printer Driver Guide for Macintosh" or Help.

## Office Locations

---

### **CANON INC.**

30-2, Shimomaruko 3-chome, Ohta-ku, Tokyo 146-8501, Japan

### **CANON MARKETING JAPAN INC.**

16-6, Konan 2-chome, Minato-ku, Tokyo 108-8011, Japan

### **CANON U.S.A., INC.**

One Canon Park, Melville, NY 11747, U.S.A.

### **CANON EUROPA N.V.**

Bovenkerkerweg 59, 1185 XB Amstelveen, The Netherlands

### **CANON CHINA CO. LTD.**

15F Jinbao Building No.89, Jinbao Street, Dongcheng District, Beijing 100005, PRC

### **CANON SINGAPORE PTE LTD**

1 HarbourFront Avenue, #04-01 Keppel Bay Tower, Singapore 098632

### **CANON AUSTRALIA PTY LTD**

1 Thomas Holt Drive, North Ryde, Sydney NSW 2113, Australia

### **CANON GLOBAL WORLDWIDE SITES**

<http://www.canon.com/>

---