

Register your product and get support at
www.philips.com/welcome

55PFL5705D
46PFL5705D
40PFL5705D



EN User Manual

FR Manuel d'Utilisation

ES Manual del Usuario

EN: For further assistance, call the customer support service in your country.

- To obtain assistance in the U.S.A., Canada, Puerto Rico, or the U.S. Virgin Islands, contact Philips Customer Care Center at **1-866-309-0841**
- To obtain assistance in Mexico, contact Philips Customer Care Center at **01 800 504 62 00**

Enter below the model and serial numbers located on the back and right side of the TV cabinet.

FR: Pour obtenir de l'aide supplémentaire, communiquez avec le centre de service à la clientèle de votre pays.

- Pour obtenir de l'aide aux États-Unis, au Canada, à Puerto Rico ou aux Îles Vierges américaines, communiquez avec le centre de service à la clientèle Philips au : **1-866-309-0841**
- Pour obtenir l'aide au Mexique, entrez en contact avec le centre de soin de client de Philips à **01 800 504 62 00**

Entrer ci dessous le modèle et le numéro de série situés derrière à droite sur le dos du téléviseur.

ES: Para obtener más información, llame al servicio de soporte al cliente de su país.

- Para obtener asistencia en los Estados Unidos, en Canadá, Puerto Rico o en las Islas Vírgenes de los Estados Unidos, comuníquese con Centro de atención al cliente de Philips al **1-866-309-0841**
- Solo para México CENTRO DE ATENCIÓN A CLIENTES LADA. **01 800 504 62 00** Solo Para México.

Escriba a continuación el modelo y número de serie que están localizados en lado derecho y parte posterior de el gabinete de el televisor.



PHILIPS WIRELESS MEDIACONNECT KEY CODE

MODEL NUMBER

SERIAL NUMBER

PHILIPS

Contents

1 Notice	4	7 Install channels	32
		Selecting your menu language	32
2 Important	5	Autoprogram	32
Product information	5	Weak channel installation	32
Screen care	5	Installation mode	32
Environmental care	5	Uninstall channels	32
Regulatory notices	5	Return your settings to default values	32
3 Your TV	6	8 Update your TV software	33
Side controls and indicators	6	Checking your current software version	33
Remote control	6	Preparing for the software update by USB	33
		Updating software	33
4 Get started	8	9 Connect devices	35
Supplied accessories	8	Connection overview	35
Mounting stand onto TV for 40" and 46"	8	Selecting your connection quality	36
Positioning the TV	8	Connecting your devices	37
Adjusting the swivel angle	8	Add devices	39
Installing the remote control batteries	8	Remove devices	39
Connecting the antenna or cable	9		
Managing cables	10	10 Troubleshooting	40
Connecting the AC power cord	10	Downloading an electronic copy	40
Switching on and initial setup	11	Contact us	40
5 Use your TV	12	11 Specifications	41
Switching on your TV and putting it in standby mode	12		
Switching channels	12	12 Network service disclaimer	41
Adjusting volume	13		
Watching channels from a set-top box	13	13 Warranty	42
Watching connected devices	13		
Watching a Blu-ray disc	13	14 Index	43
6 Use more of your TV	14		
Access TV menus	14		
Philips Wireless MediaConnect	15		
Netflix operations	15		
Enjoying internet radio with vTuner	16		
Using Twitter	18		
Changing picture and sound settings	20		
Create and use lists of favorite channels	22		
Setting the clock	23		
Closed caption	23		
Sleeptimer	24		
Child and rating locks	24		
Use the demo mode	27		
Use Philips EasyLink	27		
EasyLink	27		
Set your location to home	28		
Network	28		
View photos and play music on a USB storage device	30		

**Return your Product Registration Card or register online at
www.philips.com/welcome today to get the very most from your purchase.**

Registering your model with PHILIPS makes you eligible for all of the valuable benefits listed below, so don't miss out. Complete and return your Product Registration Card at once, or register online at www.philips.com/welcome to ensure:

<p>*Proof of Purchase</p> <p>Returning the enclosed card guarantees that your date of purchase will be on file, so no additional paperwork will be required from you to obtain warranty service.</p>	<p>*Product Safety Notification</p> <p>By registering your product, you'll receive notification - directly from the manufacturer - in the rare case of a product recall or safety defect.</p>	<p>*Additional Benefits</p> <p>Registering your product guarantees that you'll receive all of the privileges to which you're entitled, including special money-saving offers.</p>
---	--	--

PHILIPS

Congratulations on your purchase, and welcome to the "family!"

Dear PHILIPS product owner:

Thank you for your confidence in PHILIPS. You've selected one of the best-built, best-backed products available today. We'll do everything in our power to keep you happy with your purchase for many years to come.

As a member of the PHILIPS "family," you're entitled to protection by one of the most comprehensive warranties and outstanding service networks in the industry. What's more, your purchase guarantees you'll receive all the information and special offers for which you qualify, plus easy access to accessories from our convenient home shopping network.

Most importantly, you can count on our uncompromising commitment to your total satisfaction.

All of this is our way of saying welcome - and thanks for investing in a PHILIPS product.

P.S. To get the most from your PHILIPS purchase, be sure to complete and return your Product Registration Card at once, or register online at:

www.philips.com/welcome

Know these **safety** symbols



⚡ This "bolt of lightning" indicates un-insulated material within your unit may cause an electrical shock. For the safety of everyone in your household, please do not remove product covering.

⚠ The "exclamation point" calls attention to features for which you should read the enclosed literature closely to prevent operating and maintenance problems.

WARNING: To reduce the risk of fire or electric shock, this apparatus should not be exposed to rain or moisture and objects filled with liquids, such as vases, should not be placed on this apparatus.

CAUTION: To prevent electric shock, match wide blade of plug to wide slot, fully insert.

ATTENTION: Pour éviter les choc électriques, introduire la lame la plus large de la fiche dans la borne correspondante de la prise et pousser jusqu'au fond.

For Customer Use

Enter below the model and serial numbers located on the back and right side of the TV cabinet. Retain this information for future reference.

Model No. _____
Serial No. _____

1 Notice

2010 © Koninklijke Philips Electronics N.V. All rights reserved.

Specifications are subject to change without notice. Trademarks are the property of Koninklijke Philips Electronics N.V. or their respective owners. Philips reserves the right to change products at any time without being obliged to adjust earlier supplies accordingly.

The material in this manual is believed adequate for the intended use of the system. If the product, or its individual modules or procedures, are used for purposes other than those specified herein, confirmation of their validity and suitability must be obtained. Philips warrants that the material itself does not infringe any United States patents. No further warranty is expressed or implied.

Philips cannot be held responsible neither for any errors in the content of this document nor for any problems as a result of the content in this document. Errors reported to Philips will be adapted and published on the Philips support website as soon as possible.

Pixel characteristics

This LCD product has a high number of color pixels. Although it has effective pixels of 99.999% or more, black dots or bright points of light (red, green or blue) may appear constantly on the screen. This is a structural property of the display (within common industry standards) and is not a malfunction.

Warranty

No components are user serviceable. Do not open or remove covers to the inside of the product. Repairs may only be done by Philips Service Centers and official repair shops. Failure to do so shall void any warranty, stated or implied.

Any operation expressly prohibited in this manual, any adjustments, or assembly procedures not recommended or authorized in this manual shall void the warranty.

Federal Communications Commission Notice

This equipment has been tested and found to comply with the limits for a Class B digital device, pursuant to part 15 of the FCC Rules. These limits are designed to provide reasonable protection against harmful interference in a residential installation. This equipment generates, uses, and can radiate radio frequency energy and, if not installed and used in accordance with the instructions, may cause harmful interference to radio communications. However, there is no guarantee that interference will not occur in a particular installation. If this equipment does cause harmful interference to radio or television reception, which can be determined by turning the equipment off and on, the user is encouraged to try to correct the interference by one or more of the following measures:

- Reorient or relocate the receiving antenna.
- Increase the separation between the equipment and the receiver.
- Connect the equipment into an outlet on a circuit different from that to which the receiver is connected.
- Consult the dealer or an experienced radio or television technician for help.

Declaration of Conformity

Trade Name: PHILIPS
Responsible Party: P&F USA, Inc.
Model: 55PFL5705D, 46PFL5705D, 40PFL5705D
Address: PO Box 430 Daleville, IN 47334-0430 U.S.A.
Telephone Number: 1-866-309-0841

Modifications

The FCC requires the user to be notified that any changes or modifications made to this device that are not expressly approved by Philips Consumer Electronics may void the user's authority to operate the equipment.

Cables

Connections to this device must be made with shielded cables with metallic RFI/EMI connector hoods to maintain compliance with FCC Rules and Regulations.

Canadian notice

Standard Television Receiving Apparatus, Canada BETS-7/NTMR-7. This Class B digital apparatus meets all requirements of the Canadian Interference-Causing Equipment Regulations.

FCC Caution: Any changes or modifications not expressly approved by the party responsible for compliance could void the user's authority to operate this equipment.

This transmitter must not be co-located or operating in conjunction with any other antenna or transmitter.

Country Code Statement

For product available in the USA market, only channel 1~11 can be operated. Selection of other channels is not possible.

To maintain compliance with FCC RF exposure requirements, use only belt-clips, holsters or similar accessories that do not contain metallic components in its assembly. The use of accessories that do not satisfy these requirements may not comply with FCC RF exposure requirements, and should be avoided.

FCC Radiation Exposure Statement

This equipment is compliance with SAR for general population/uncontrolled exposure limits in ANSI/IEEE C95.1-1999 and had been tested in accordance with the measurement methods and procedures specified in OET Bulletin 65 Supplement C. This equipment should be installed and operated with minimum distance 2.5cm between the radiator & your body.

Copyright

All other registered and unregistered trademarks are the property of their respective owners.



ENERGY STAR® is a joint program of the U.S. Environmental Protection Agency and the U.S. Department of Energy helping us all save money and protect the environment through energy efficient products and practices.

Consumer Notice:

This TV has been set to maximize energy efficiency while delivering the best possible picture using the factory installed home mode settings. Changing or enabling other features in this TV (e.g. brightened backlighting) will possibly increase energy consumption beyond the original ENERGY STAR® qualified limits.



SRS TruSurround HD™ creates an immersive, feature-rich surround sound experience from two speakers, complete with rich bass, high frequency detail and clear dialog.

SRS® is a trademark of SRS Labs, Inc. TruSurround HD technology is incorporated under license from SRS Labs, Inc.



Manufactured under license from Dolby Laboratories. Dolby and the double-D symbol are trademarks of Dolby Laboratories.



Netflix and the Netflix logo are trademarks or registered trademarks of Netflix, Inc.



Twitter is a trademark of Twitter, Inc.



vTuner is a trademark of Nothing Else Matters Software, Ltd.



VESA, FDMI and the VESA Mounting Compliant logo are trademarks of the Video Electronics Standards Association.



© Kensington and Micro Saver are registered US trademarks of ACCO World corporation with issued registrations and pending applications in other countries throughout the world.

IMPORTANT SAFETY INSTRUCTIONS

Read before operating equipment

1. Read these instructions.
2. Keep these instructions.
3. Heed all warnings.
4. Follow all instructions.
5. Do not use this apparatus near water.
6. Clean only with a dry cloth.
7. Do not block any of the ventilation openings. Install in accordance with the manufacturer's instructions.
8. Do not install near any heat sources such as radiators, heat registers, stoves, or other apparatus (including amplifiers) that produce heat.
9. Do not defeat the safety purpose of the polarized or grounding-type plug. A polarized plug has two blades with one wider than the other. A grounding type plug has two blades and third grounding prong. The wide blade or third prong are provided for your safety. When the provided plug does not fit into your outlet, consult an electrician for replacement of the obsolete outlet.
10. Protect the power cord from being walked on or pinched particularly at plugs, convenience receptacles, and the point where they exit from the apparatus.
11. Only use attachments/accessories specified by the manufacturer.
12.  Use only with a cart, stand, tripod, bracket, or table specified by the manufacturer, or sold with the apparatus. When a cart is used, use caution when moving the cart/apparatus combination to avoid injury from tip-over.
13. Unplug this apparatus during lightning storms or when unused for long periods of time.
14. Refer all servicing to qualified service personnel. Servicing is required when the apparatus has been damaged in any way, such as power-supply cord or plug is damaged, liquid has been spilled or objects have fallen into apparatus, the apparatus has been exposed to rain or moisture, does not operate normally, or has been dropped.
15. This product may contain lead or mercury. Disposal of these materials may be regulated due to environmental considerations. For disposal or recycling information, please contact your local authorities or the Electronic Industries Alliance: www.eiae.org.
16. **Damage Requiring Service** - The appliance should be serviced by qualified service personnel when:
 - A. The power supply cord or the plug has been damaged; or
 - B. Objects have fallen, or liquid has been spilled into the appliance; or
 - C. The appliance has been exposed to rain; or
 - D. The appliance does not appear to operate normally or exhibits a marked change in performance; or
 - E. The appliance has been dropped, or the enclosure damaged.
17. **Tilt/Stability** - All televisions must comply with recommended international global safety standards for tilt and stability properties of its cabinets design.
 - Do not compromise these design standards by applying excessive pull force to the front, or top, of the cabinet which could ultimately overturn the product.
 - Also, do not endanger yourself, or children, by placing electronic equipment/toys on the top of the cabinet. Such items could unsuspectingly fall from the top of the set and cause product damage and/or personal injury.
18. **Wall or Ceiling Mounting** - The appliance should be mounted to a wall or ceiling only as recommended by the manufacturer.
19. **Power Lines** - An outdoor antenna should be located away from power lines.
20. **Outdoor Antenna Grounding** - If an outside antenna is connected to the receiver, be sure the antenna system is grounded so as to provide some protection against voltage surges and built up static charges. Section 810 of the National Electric Code, ANSI/NFPA No. 70-1984, provides information with respect to proper grounding of the mats and supporting structure grounding of the lead-in wire to an antenna-discharge unit, size of grounding connectors, location of antenna-discharge unit, connection to grounding electrodes and requirements for the grounding electrode. See Figure below.
21. **Objects and Liquid Entry** - Care should be taken so that objects do not fall and liquids are not spilled into the enclosure through openings.
 - a) Warning: To reduce the risk of fire or electric shock, this apparatus should not be exposed to rain or moisture and objects filled with liquids, such as vases should not be placed on this apparatus.
22. **Battery Usage CAUTION** - To prevent battery leakage that may result in bodily injury, property damage, or damage to the unit:
 - Install all batteries correctly, with + and - alignment as marked on the unit.
 - Do not mix batteries (old and new or carbon and alkaline, etc.)
 - Remove batteries when the unit is not used for a long time.

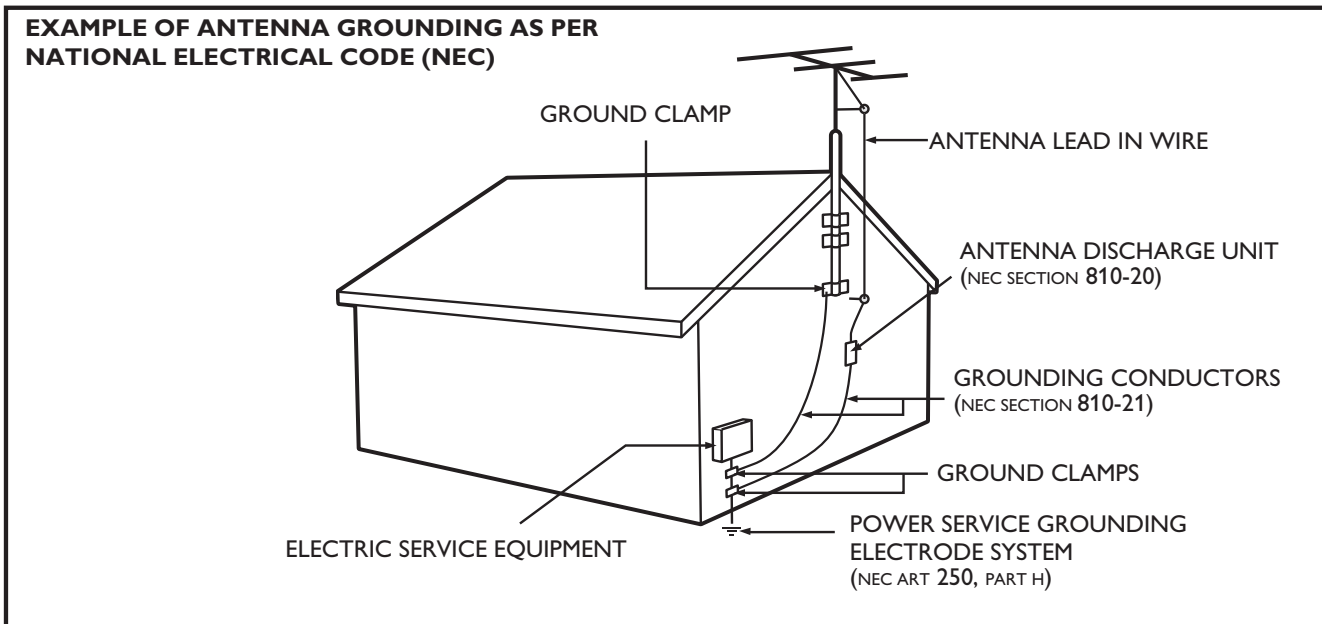

Note to the CATV system installer: this reminder is provided to call the CATV system installer's attention to Article 820-40 of the NEC that provides guidelines for proper grounding and, in particular, specifies that the cable ground shall be connected to the grounding system of the building, as close to the point of cable entry as practical.

Portions of this software are copyright © The FreeType Project (www.freetype.org).

The American Academy of Pediatrics discourages television viewing for children younger than two years of age.

2 Important

Registering your model with Philips makes you eligible for all of the valuable benefits listed below, so don't miss out.

Complete and return your Product Registration Card at once, or register online at www.philips.com/welcome to ensure:

- **Proof of Purchase**
Returning the enclosed card guarantees that your date of purchase is on file, so no additional paperwork is required from you to obtain warranty service.
- **Product Safety Notification**
By registering your product you receive notification - directly from the manufacturer - in the rare case of a product recall or safety defect.
- **Additional Benefits of Product Ownership**
Registering your product guarantees that you receive all of the privileges to which you're entitled, including special money-saving offers.

For further assistance

For further assistance, call the customer support service in your country.

- To obtain assistance in the U.S.A., Canada, Puerto Rico, or the U.S. Virgin Islands, contact Philips Customer Care Center at **1-866-309-0841**

Product information

This TV consumes minimal energy in standby mode to minimize environmental impact. The active power consumption is given on the type plate at the back of the TV. The model and serial numbers of your TV can be found on the back and right side of the TV as well as on the packaging.

Screen care

- Avoid stationary images as much as possible. Stationary images are images that remain on-screen for extended periods of time. Examples include: on-screen menus, black bars and time displays. If you must use stationary images, reduce screen contrast and brightness to avoid screen damage.
- Unplug the TV before cleaning.
- Clean the TV screen and frame with a soft cloth. Never use substances such as alcohol, chemicals or household cleaners on the TV screen.
- Risk of damage to the TV screen! Never touch, push, rub or strike the screen with any object.
- To avoid deformations and color fading, wipe off water drops as soon as possible.

Environmental care

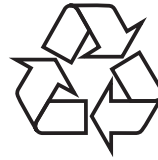

The packaging of this product is intended to be recycled. Contact your local authorities for information about how to recycle the packaging.

End of life directives



Like all LCD products, this set contains a lamp with mercury; please dispose of according to all local, state and federal laws.

Philips pays a lot of attention to produce environment-friendly products in green focal areas. Your new TV contains materials which can be recycled and reused. At the end of its life, specialized companies can dismantle the discarded TV to concentrate the reusable materials and to minimize the amount of materials to be disposed of. Please ensure you dispose of your old TV according to local regulations.

Disposal of used batteries

The batteries supplied do not contain the heavy metals mercury and cadmium. Nevertheless, in many areas batteries may not be disposed of with your household waste. Please ensure you dispose of batteries according to local regulations.

Regulatory notices

Warning

To reduce the risk of fire or electric shock, this apparatus should not be exposed to rain or moisture. Objects filled with liquids, such as vases, should not be placed on this apparatus.

Caution

To prevent electric shock, match the wide blade of the plug to the wide slot, fully inserted.

Do not place the unit on the furniture that is capable of being tilted by a child and an adult leaning, pulling, standing or climbing on it. A falling unit can cause serious injury or even death.

This apparatus should not be placed in a built-in installation such as a bookcase or rack unless proper ventilation is provided.

Make sure to leave a space of 4 inches (10cm) or more around this apparatus.

3 Your TV

Congratulations on your purchase, and welcome to Philips! To fully benefit from the support that Philips offers, register your product at www.philips.com/welcome

Side controls and indicators

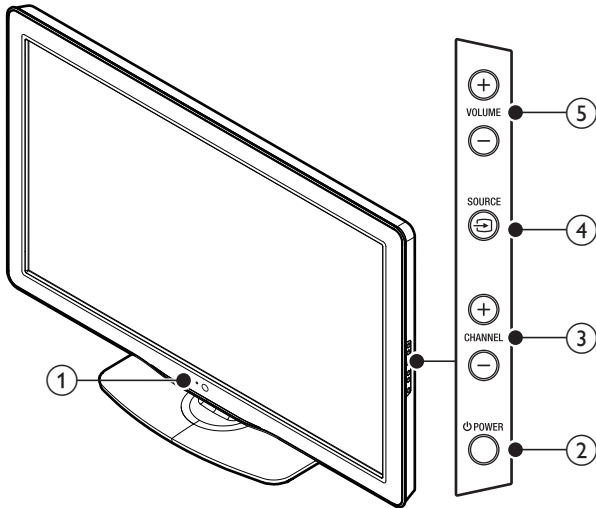

- ① Standby indicator / Remote control sensor
- ② **⏻ POWER**
Switches the TV on or puts it in standby mode. The TV is not powered off completely unless it is physically unplugged.
- ③ **CHANNEL +/-**
Switches to the next or previous channel.
- ④ **SOURCE** 
Selects connected devices.
- ⑤ **VOLUME +/-**
Increases or decreases volume.

Remote control

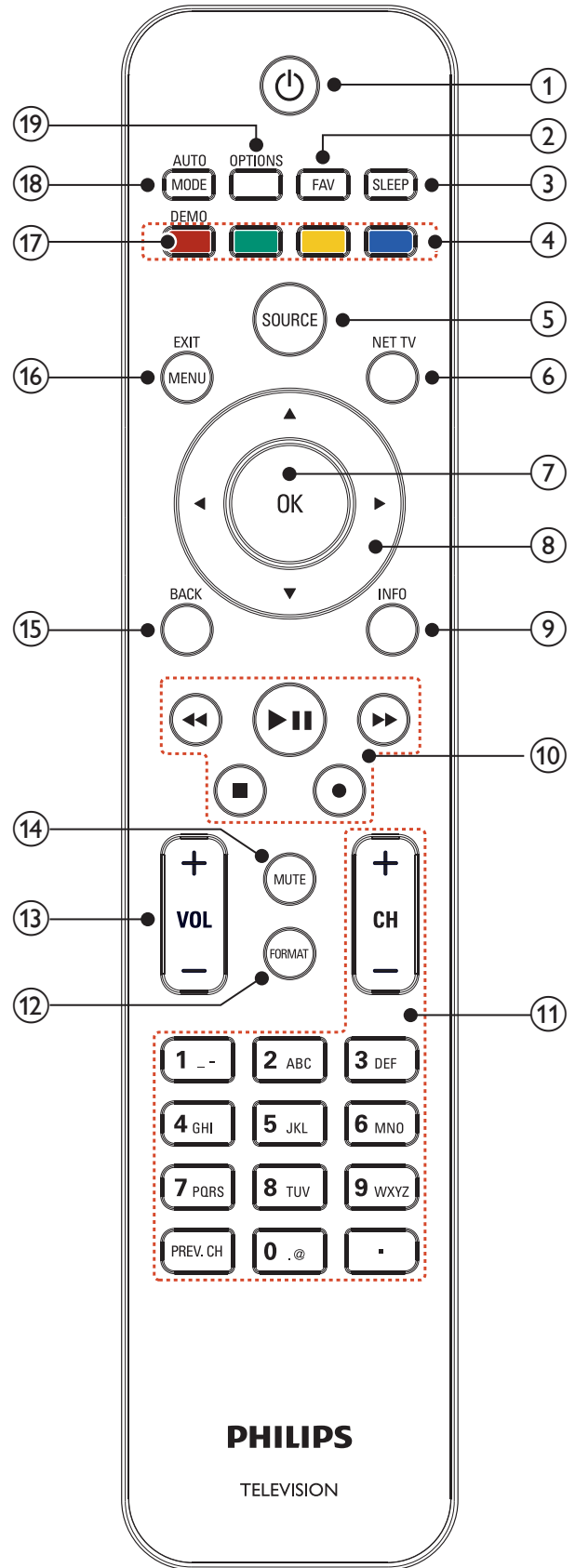

- ① **⏻ (standby-On)**
Switches the TV on or puts it in standby mode. The TV is not powered off completely unless it is physically unplugged.
- ② **FAV**
Displays a list of all channels marked as favorite.
(Includes subchannels)
- ③ **SLEEP**
Sets a delay after which the TV switches to standby.
- ④ **Color buttons (red/green/yellow/blue)**
Selects tasks or options.
- ⑤ **SOURCE**
Selects connected devices.
- ⑥ **NET TV**
Displays the Net TV menu.
- ⑦ **OK**
Activates a selection or accesses the menu.
- ⑧ **▲▼◀▶ (navigation buttons)**
Navigates through the menus.
- ⑨ **INFO**
Displays information about the TV channel or accessory device.
The quality and accuracy of the information depends on the broadcaster. You might see a difference in broadcast time if the broadcast is from a different time zone.
- ⑩ **EasyLink buttons**
 - ◀◀ (backward)
Searches backward.
 - ▶▶ (forward)
Searches forward.
 - ▶|| (play/pause)
Starts, pauses or resumes playback.
 - (record)
Starts or stops video recording.
 - (stop)
Stops playback.
- ⑪ **CH +/-**
Switches to the next or previous channel.
Number buttons
Select a channel, page, setting or input characters.
 - (Dot)
Press the dot (•) for digital channels.
 - PREV. CH**
Returns to the previously viewed channel.
- ⑫ **FORMAT**
Selects a picture format. (See 'Changing picture format' on page 21.)
- ⑬ **VOL +/-**
Increases or decreases volume.
- ⑭ **MUTE**
Mutes or unmutes audio.
- ⑮ **BACK**
Returns to a previous screen.
- ⑯ **MENU/EXIT**
Toggles the home menu on or off.
- ⑰ **DEMO**
Displays the demonstration menu.
- ⑱ **AUTO MODE**
Cycles through preset picture and sound settings.
(See 'Using auto mode' on page 22.)
- ⑲ **OPTIONS**
Displays a list of menu items applicable to the highlighted object or screen.

4 Get started

Supplied accessories

- Remote Control
- 2 x AAA, 1.5V Batteries
- M5 x 20 double sems screw x 4 (available for 40" and 46" only)
- AC Power cord
- Cable management tie
- USB wireless LAN adapter (PH2010A)
- User Manual
- Quick Start Guide
- Box-inserts

Note

Wireless LAN Adapter for Philips models: 55PFL5705D, 46PFL5705D, 40PFL5705D

- This wireless device can only be used with a limited number of Philips products. For more details go to: www.philips.com/welcome and enter your model number.
- Do not use the supplied USB wireless LAN adapter with devices other than this unit and a limited number of Philips products.
- The supplied USB wireless LAN adapter is guaranteed by manufacturer.

Mounting stand onto TV for 40" and 46"

Applicable to TVs without mounted stands.

1

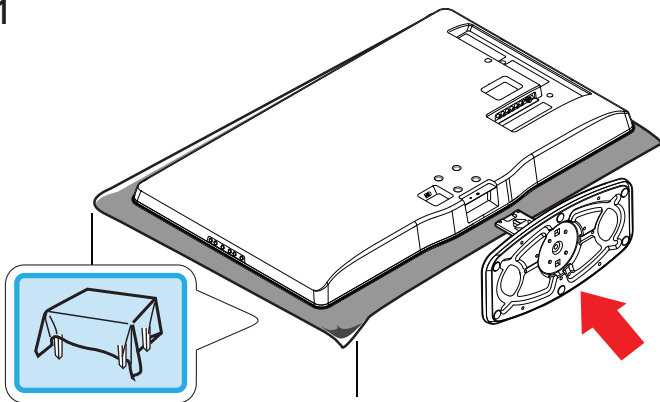

2

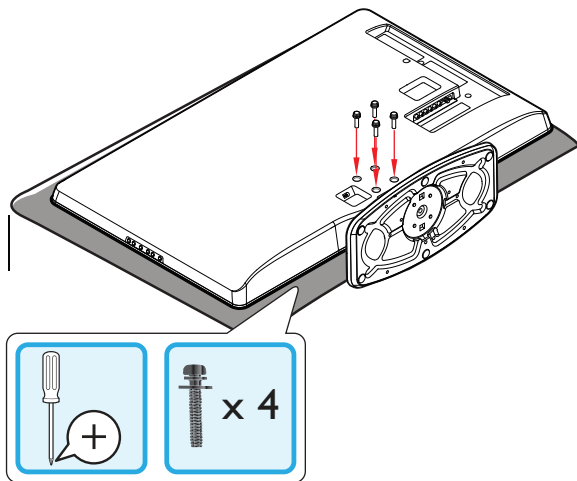

Note

- To wall mount the TV, refer to the addendum.
- If you lose the stand mounting screws, please purchase 4 Phillips head screws (M5x20) at your local store.

Positioning the TV

Warning

- Do not insert the AC power cord into the power socket outlet before all the connections are made.
- Large screen TVs are heavy, 2 people are required to carry and handle a large screen TV.
- Before you move the TV, disconnect attached cables to prevent damage to connectors.

In addition to reading and understanding safety instructions, consider the following before positioning your TV:

- Ensure that you always have easy access to the AC power cord or plug to disconnect the TV from the power.
- If the TV is mounted on a swivel base, ensure that no strain is placed on the AC power cord when the TV is swiveled. Strain on the AC power cord can loosen connections.
- The ideal viewing distance for watching TV is three times its screen size.
- Position the TV where light does not fall on the screen.
- Connect your devices before you position the TV.

Using a Kensington lock

There is a Kensington security slot on the back of the TV. Prevent theft by looping a Kensington lock between the slot and a permanent object, such as a heavy table.

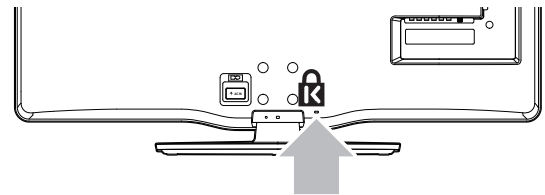

Adjusting the swivel angle

You can adjust the viewing angle of your TV.

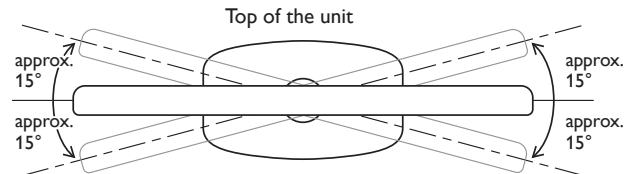

Caution

- While adjusting the swivel angle of your TV, hold the base firmly to prevent the TV from tipping over and falling down.

Installing the remote control batteries

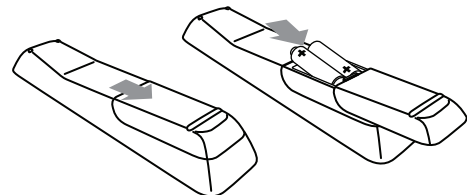

- 1 Slide the battery cover off the back of the remote control.
- 2 Insert the 2 supplied batteries (AAA, 1.5V). Be sure the + and - ends of the batteries line up with the markings inside the case.
- 3 Slide the cover back into position.

Note

- Remove the batteries if not using the remote control for an extended period of time.

Connecting the antenna or cable

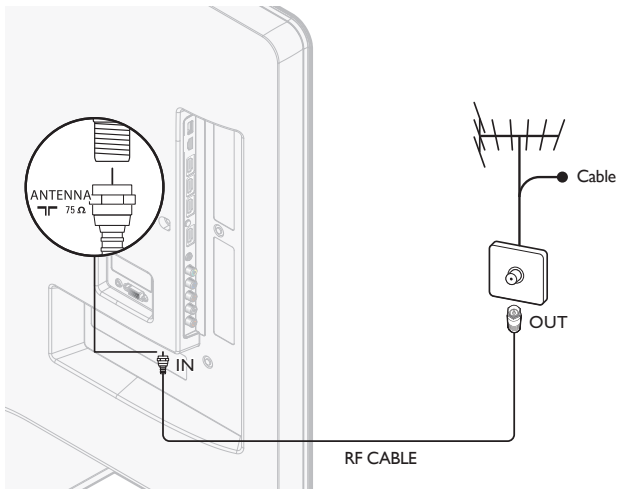

If you connect to an antenna

Any DTV programs that are broadcast in your area can be received for free through an antenna connection.

Contact your local content provider or your local electronics retailer if you are unsure about what HDTV programs are available in your area. Broadcasters are transitioning from analog to digital TV. This means that a given broadcaster can have channels available either in analog or in digital, or both analog and digital at the same time.

The TV produces stereo sound only if a stereo signal is broadcast.

If you connect to a cable

When your TV is connected to the cable socket, you might receive free digital and high definition programs (depending on your cable provider). The channel number for digital and high definition channels includes a dot ".". For example, 11.1, 46.30, 108.201. Contact your cable provider for more information.

If you connect to a DBS (Direct Broadcast Satellite)

There are two main DBS systems: DirecTV and DishNetwork. These systems require a separate, proprietary set-top box to decode signals and send them to the TV. The set-top box contains a digital TV tuner for receiving off-air digital broadcasts.

Contact your local DBS provider for more information about the connections and the TV channels.

If you connect to a set-top box

A cable box or satellite set-top box can be connected to the TV through the following connections:

- ANT
- A/V (Composite Video and Audio)
- YPbPr (Component Video Input)
- HDMI

For information about how to connect a set-top box, see the Quick Start Guide provided.

If you connect a set-top box through RF IN/OUT

If the TV is connected to a cable box or satellite set-top box via a coaxial connection, set the TV to channel 3 or 4, or to the channel specified by the service provider.

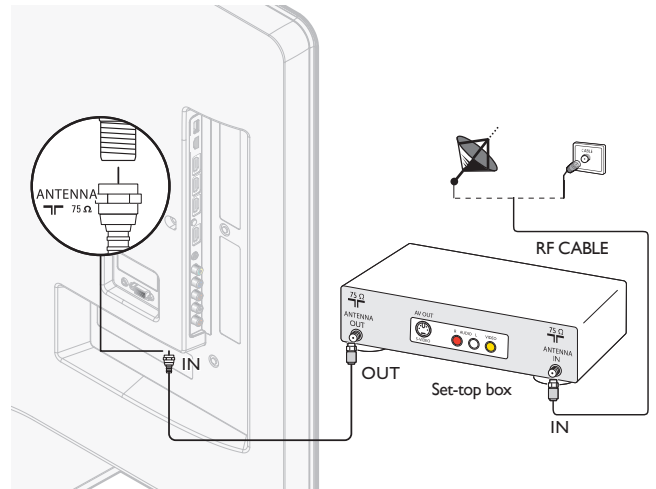

If you connect a set-top box through HDMI

If the TV is connected to a cable box or satellite set-top box via HDMI, make sure you select the correct HDMI source by using **SOURCE** on this unit's remote control.

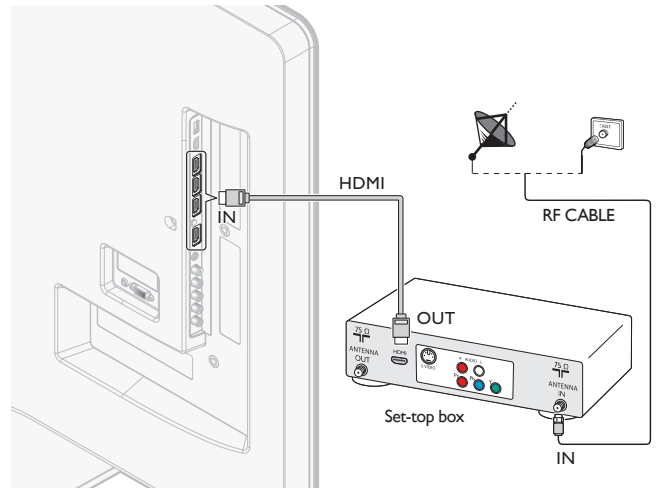

If you connect a set-top box through component video input

If the TV is connected to a cable box or satellite set-top box via component video input, make sure you select the correct component video source by using **SOURCE** on this unit's remote control.

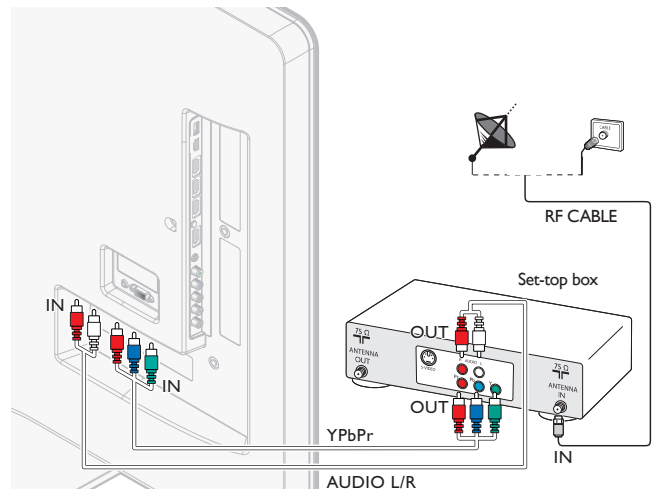

Managing cables

Route your antenna cable and all other cables through the cable management tie at the back of the TV. The holder helps keep your cables tidy and easily manageable.

- 1 Attach the cable management tie as illustrated below.

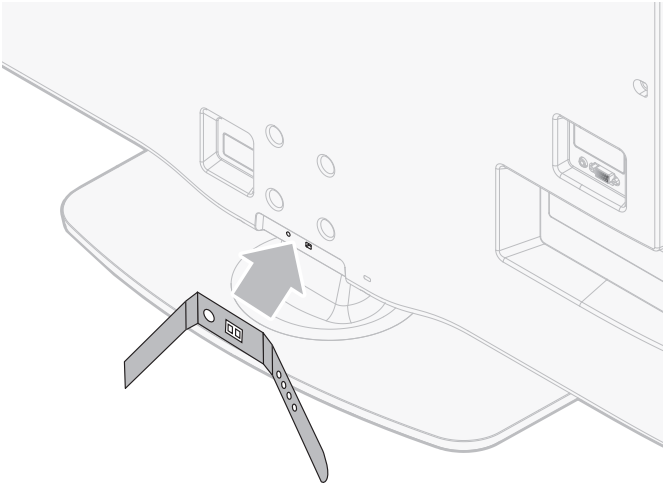

- 2 Pass cables through the cable management tie to avoid tangles.

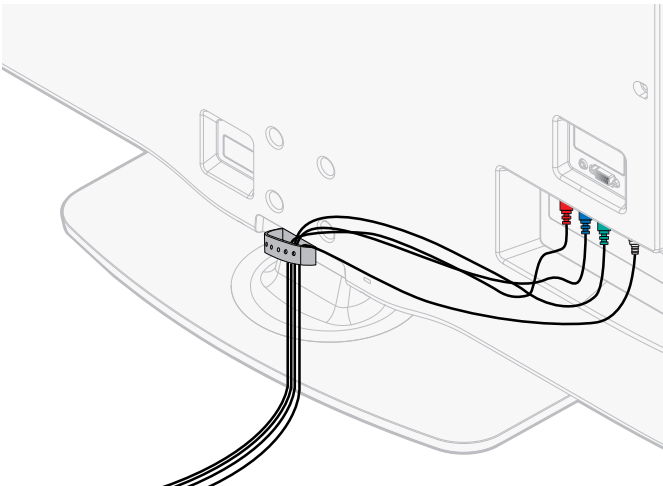

Connecting the AC power cord

Warning

- Verify that your power voltage corresponds with the voltage printed at the back of the TV. Do not insert the AC power cord if the voltage is different.

- 1 Locate the power connector at the back of the TV. The location of the power connector varies according to TV model.
- 2 Insert the AC power cord fully into the power connector.
- 3 Connect the AC power cord plug to the power outlet. Ensure that the cord is tightly secured at both ends.

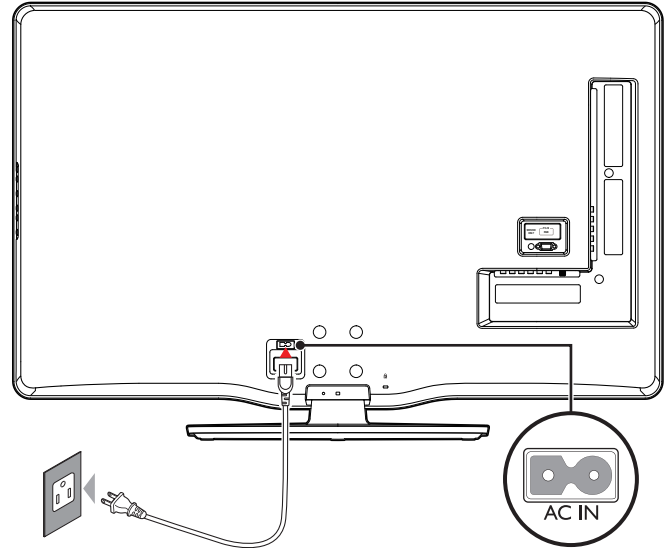

Disconnect the TV from the power outlet

Caution

- Pull the AC power cord by the plug; do not pull on the AC power cord.

- 1 Unplug the AC power cord from the power outlet.
- 2 Unplug the AC power cord from the power connector at the back of the TV.

Switching on and initial setup

Before you switch on the TV, check that the AC power cord is properly connected. Press **POWER** at the right side of the TV, or press **(standby-On)** on the remote control. The TV normally takes 25-30 seconds to start up and the following screen appears the first time you turn on the TV.

After you read a welcome screen, follow the on-screen instructions to select your language and complete your TV setup. Installation takes approximately 20 minutes.

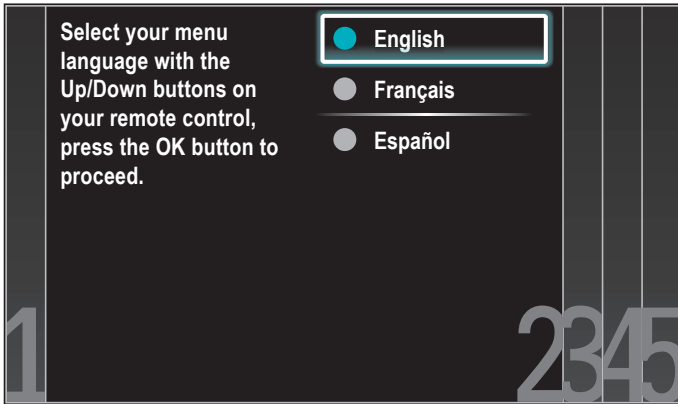

Press **▲/▼** to select the desired mode for energy saving, then press **OK**.

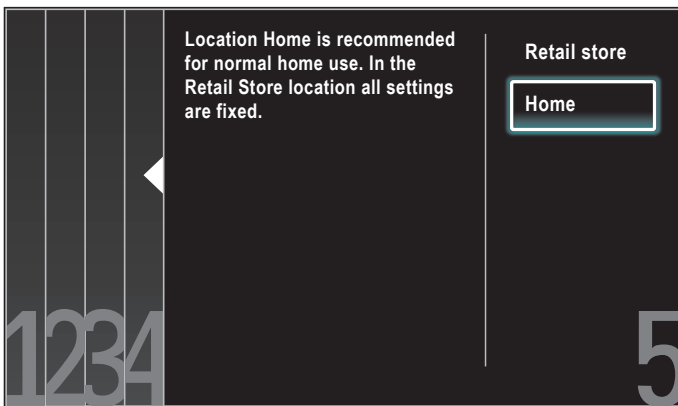

Select **[Retail store]** if you want backlight to be brighter.

Select **[Home]** to reduce power consumption.

You must set **[Home]**. Otherwise, personalized picture and sound settings will not be memorized after the unit goes to standby mode.

- Select **[Retail store]**, the unit will be set up with predefined setting for retail displays. In this setting, the power consumption may possibly exceed the limited requirement of the ENERGY STAR® qualification.
- Select **[Home]**, the unit will be set to maximize energy efficiency. Picture and sound settings can be adjusted and saved as per your personal preferences.

Press **◀/▶** to select **[Start]**, then press **OK** to begin **[Settings assistant]**.

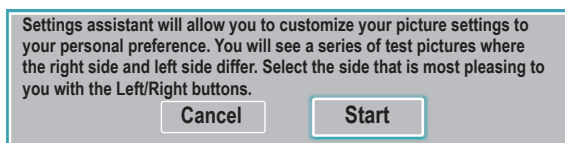

Select **[Picture A]** or **[Picture B]** by pressing **◀/▶** that is the most pleasing to you, then press **OK**. You see 5 different pictures to be completed.



Press **◀/▶** to select **[Store]**, then press **OK**.



Press **OK** to finish **[Settings assistant]**.

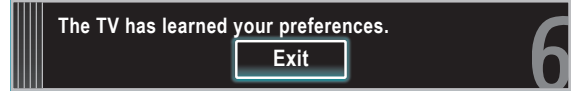

Press **◀/▶** to select **[Finish]**, then press **OK**.

Finish the Setup.

Note

- If you are not receiving a signal from your cable service, contact the CATV provider.
- If you press **POWER** during autoprogram, an installation will be canceled except the language selection.
- The initial autoprogram function can be executed for either **[Antenna]** or **[Cable]** only once. When you change the connection (Antenna/Cable), set autoprogram again. (Refer to page 32.)

5 Use your TV

This section helps you perform basic TV operations.

Switching on your TV and putting it in standby mode

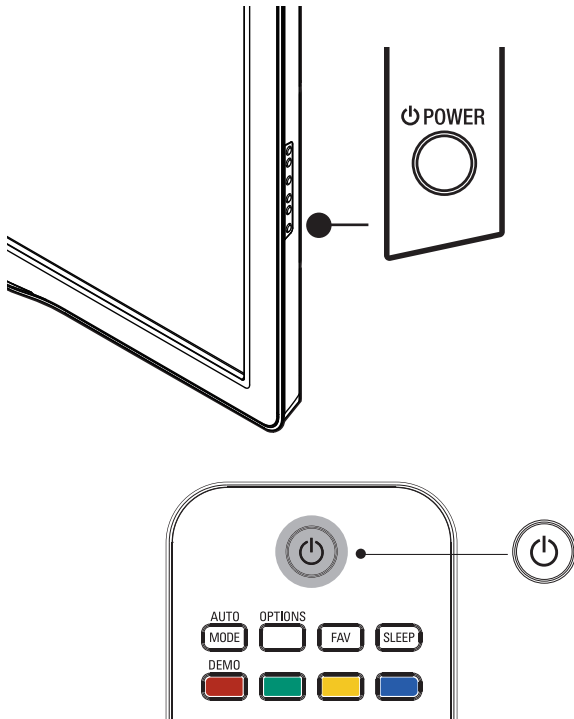

To switch on

- Press **POWER** at the side of the TV or press **(standby-On)** on the remote control.

To switch to standby

- Press **POWER** at the side of the TV or press **(standby-On)** on the remote control again.

Note

- Energy consumption contributes to air and water pollution. When the AC power cord is plugged in, your TV consumes energy. Your TV has very low standby power consumption.

Switching channels

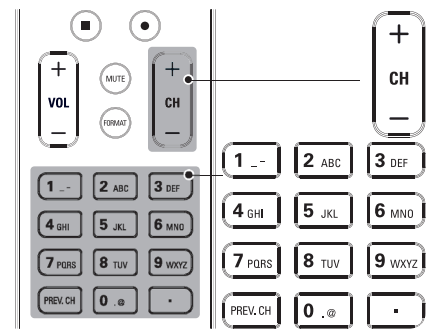
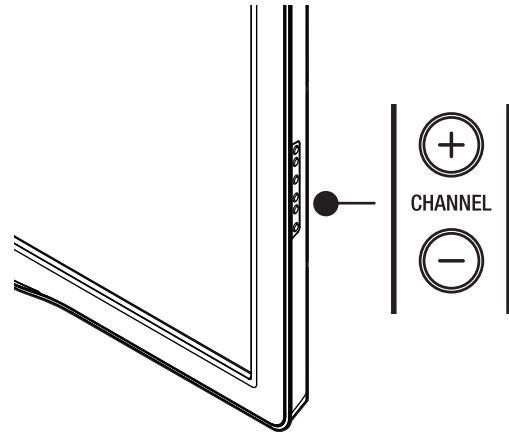

Press **CHANNEL +/-** on the side of the TV.

- Press **CH +/-** or enter a number on the remote control. For digital channels, press a number (1 to 999) followed by a dot “•” and then the corresponding sub channel number (1 to 999). e.g. 108.30.
- Press **PREV. CH** to return to the previously viewed channel.

Adjusting volume

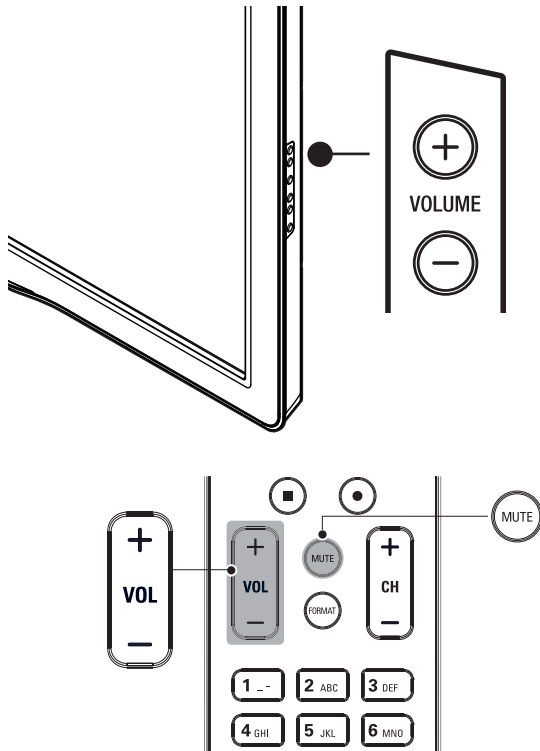

To increase or decrease volume

- Press **VOL +/-** on the remote control or press **VOLUME +/-** on the side of the TV.

To mute or unmute sound

- Press **MUTE** on the remote control to mute the sound.
- Press **MUTE** again or **VOL +/-** to recover the original sound.

Watching channels from a set-top box

To watch channels from a set-top box

- 1 Switch on the set-top box.
 - ↳ The picture from your set-top box might appear automatically on the TV screen.
- 2 Use the remote control of your set-top box to select channels.

If the picture does not appear

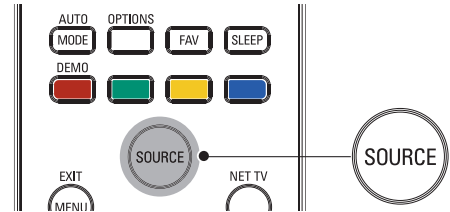

- 1 Press **SOURCE** repeatedly to select the set-top box and wait a few seconds for the picture to appear.
- 2 Use the remote control of your set-top box to select channels.

Watching connected devices

To watch connected devices

- 1 Switch on the connected device.
 - ↳ The picture from your connected device might appear automatically on the TV screen.
- 2 Use the remote control of the device to select channels.

If the picture does not appear

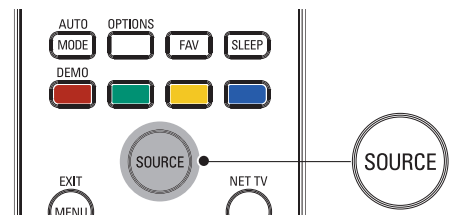

- 1 Press **SOURCE** repeatedly to select the connected device and wait a few seconds for the picture to appear.
- 2 Use the remote control of the device to select channels.

Watching a Blu-ray disc

To watch a Blu-ray Disc

- 1 Insert a Blu-ray Disc into your player.
- 2 Press **▶ (play)** on the remote control of the Blu-ray Disc player.
 - ↳ The Blu-ray Disc might automatically play on the TV.

If the picture does not appear

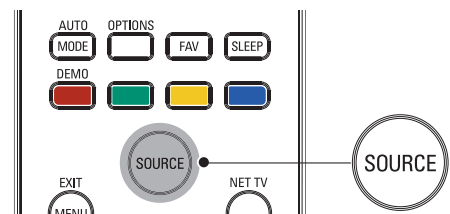

- 1 Press **SOURCE** repeatedly to select the Blu-ray Disc player and wait a few seconds for the picture to appear.
- 2 Use the remote control of the Blu-ray Disc player to play the disc.

6 Use more of your TV

Access TV menus

Menus help you to install channels, change picture and sound settings then access other features.

Access the home menu

The home menu gives you easy access to connected devices, picture and sound settings as well as other useful features.

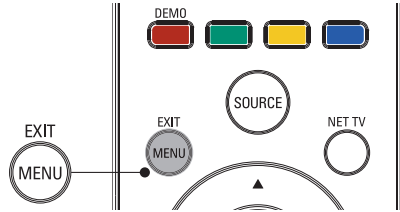

- 1 Press **MENU** on the remote control.

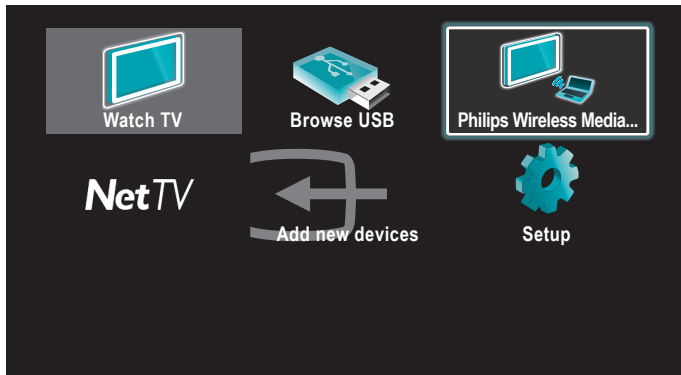

- 2 Use **▲/▼/◀/▶** to select and navigate through one of the following menus.
 - **[Watch TV]** Switches back to the antenna source if another source is selected.
 - **[Browse USB]** Accesses USB menus.
 - **[Philips Wireless MediaConnect]** Accesses Philips Wireless MediaConnect.
 - **[Net TV]** Access **[NETFLIX]**, **[vTuner]** or **[Twitter]**.
 - **[Add new devices]** Adds new devices to the home menu.
 - **[Setup]** Accesses menus that allow you to change picture, sound and other TV settings.
- 3 Press **OK** to confirm your choice.
- 4 Press **MENU** to exit.



Tip

- After selecting **[Add new devices]**, follow the on-screen instructions to select the correct device and connector.

Lock or unlock your device from the home menu

This section describes how to lock or unlock specified device.

- 1 Press **MENU** on the remote control.
- 2 Use **▲/▼/◀/▶** to select a device to lock or unlock.
- 3 Press **OPTIONS** on the remote control.
- 4 Use **▲/▼** to select **[Device lock]** or **[Device unlock]**, then press **OK**.
 - If device lock is unlocked, **[Device lock]** will be displayed.
 - If device lock is locked, **[Device unlock]** will be displayed.
 - When device lock is locked,  will be displayed at the top right of the device icons.
- 5 Enter your PIN. (See 'Setting your PIN' on page 24.)
 - Once you have set PIN, PIN input menu does not appear after the unit is turned on.

Enable or disable RC key forwarding from the home menu

This section describes how to enable or disable RC key forwarding for a particular device.

- 1 Press **MENU** on the remote control.
- 2 Use **▲/▼/◀/▶** to select a device to enable or disable RC key forwarding.
- 3 Press **OPTIONS** on the remote control.
- 4 Use **▲/▼** to select **[Enable RC key forwarding]** or **[Disable RC key forwarding]**, then press **OK**.
 - If RC key forwarding is set to off, **[Enable RC key forwarding]** will be displayed. If RC key forwarding is set to on, **[Disable RC key forwarding]** will be displayed.
 - When you set RC key forwarding on,  will be displayed at the top left of the device icons.

Note

- This function is available only when your devices are connected to this unit through HDMI cables and assigned to an HDMI port (HDMI1 to HDMI4) with **[Add new devices]** in the home menu.

Philips Wireless MediaConnect

You can enjoy your TV as a PC monitor wirelessly using your home network. Make sure you download the Philips Wireless MediaConnect software and install it on your PC before you perform the steps below.

Install Philips Wireless MediaConnect

- 1 Start your internet browser on your PC and open the Philips Wireless MediaConnect download page at www.philips.com/wifimediconnect. On the website, you can check the necessary PC system requirements.
- 2 Enter the 12 digit code printed on the cover of the User Manual or back of your TV.
- 3 Click the 'Download now' button to download the free Philips Wireless MediaConnect software.
- 4 Once downloaded, start the file "Philips Wireless MediaConnect_setup.exe". Follow the instructions on the screen to complete software installation.

Using Philips Wireless MediaConnect

- 1 Launch Philips Wireless MediaConnect on your PC first.
- 2 Press **MENU** on the remote control.
- 3 Use **▲/▼/◀/▶** to select **[Philips Wireless MediaConnect]**.
 - The start up screen for Philips Wireless MediaConnect will be displayed and the unit searches for an available PC that is running Philips Wireless MediaConnect software.

Once connected, the Philips Wireless MediaConnect software will encode and stream the screen of your PC as a video along with audio.

Depending on your computer and network configuration, there will be a delay between your PC screen and the TV but the audio-video will always be in sync.

Philips Wireless MediaConnect Help

To read the Philips Wireless MediaConnect Help, right click the program icon in the notification tray of the PC and select Help.

Specifics

You can project high definition (HD) or standard definition (SD) video, depending on the processing power of your PC. For smooth playback of HD video, please use a hardware accelerated video player on your computer. A hardware accelerated video player uses the graphics adapter of your PC to render HD video rather than the processor. This frees up the processor for Philips Wireless MediaConnect video encoding. The content protection on most DVD or Blu-ray Disc movies might restrict watching the movie on TV when the disc is playing on a PC. The TV shows PC media files with a small delay. Philips Wireless MediaConnect is only available for PC.

PC requirements

Windows XP, Windows Vista, Windows 7 (PC only)

Minimum PC requirements

- Intel Core 2 Duo 1.8GHz
- 512MB RAM
- 200MB free hard disk space
- IEEE 802.11g
- Internet connection

Recommended PC requirements

- Intel Core 2 Duo 2.1GHz
- 1GB RAM
- 200MB free hard disk space
- IEEE 802.11n
- Internet connection

Netflix operations

With this unit, you can watch movies and TV episodes streamed instantly from Netflix via the internet. In order to use this feature, you must visit the following website on your PC and become a Netflix member: www.netflix.com/Philips

Before activating the connection to Netflix

After creating a Netflix account at www.netflix.com/Philips, follow the following procedure before activating the connection to Netflix.

- 1 Connect this unit to the internet.
(See 'Connecting the TV to the internet using an Ethernet cable' or 'Connecting the TV to the internet using a USB wireless LAN adapter' on page 38.)
- 2 Set up the necessary network connection settings.
(See 'Network' on page 28.)

Activating the connection to Netflix

In order to watch movies and TV episodes streamed instantly from Netflix via the internet, you must activate the connection between this unit and your Netflix account.

- 1 Press **NET TV** on the remote control and then use **▲/▼/◀/▶** to select **[NETFLIX]**.
 - Netflix welcome screen will appear.
 - For the first time only, **[Network service disclaimer]** screen will appear. After confirming the content, use **◀/▶** to select **[Agree]**, then press **OK**.
- 2 Use **▲/▼** to select **[yes - activate instant streaming from Netflix]**, then press **OK**.
 - Activation screen with the activation code will appear.



- 3 On your PC, visit www.netflix.com/activate and log into your account.
 - The entry screen of activation code will appear on your PC screen.
- 4 Enter the activation code which is displayed on the TV screen.
 - The Instant Queue will appear. The connection to Netflix is successfully made.
 - To browse the Instant Queue and watch movies, skip to step 2 in 'Watching streaming movies' on page 16.

Note

- Netflix is available only in the United States.
- You cannot create a Netflix account on this unit.
- If newer version of software is required, software update screen may appear after selecting **[NETFLIX]** in step 2.
(For software update, see 'Update your TV software' on page 33.)
- You can deactivate the connection to Netflix by setting the **[Deactivation]** to **[Yes]**.
(See 'Netflix connection' on page 30.)
- The screen image of Netflix may change after updating the firmware.
- For questions regarding the Netflix service, visit www.netflix.com/Help
- When you contact the Netflix customer service, you may be asked for the ESN number, which is a serial number to identify this unit by Netflix. You can check the ESN number on the **[ESN]** screen. (See 'Netflix connection' on page 30.)

Watching streaming movies

After you set up the connection to Netflix, you can browse the Instant Queue and watch movies on your TV.

- 1 Press **NET TV** on the remote control and then use **▲/▼/◀/▶** to select **[NETFLIX]**.
 - The Instant Queue will appear.
- 2 Use **◀/▶** to select the desired movie or TV episode, then press **▶▶** to start playback.

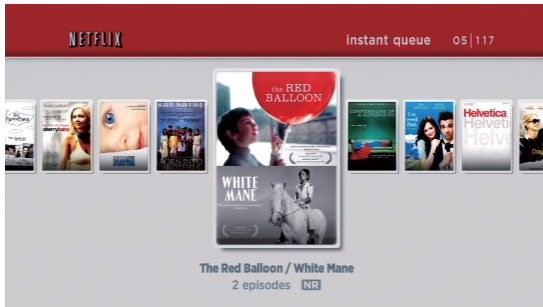

- After loading, playback of the selected movie or TV episode will start.
 - To stop the playback, press **■**.
 - To go back to the Instant Queue, press **Color buttons (red)**.
- 3 Press **MENU** to exit.



Tip

About the Instant Queue

- Instant Queue is the list of movies and TV episodes you add on the Netflix website. (www.netflix.com) You can manage the movies and TV episodes in your Instant Queue from the Netflix website on your PC.
- You cannot add movies or TV episodes to your Instant Queue on this unit.
- You can remove movies or TV episodes from the Instant Queue on this unit.

Note

- The picture quality differs depending on the speed of your internet connection at the time of loading.

Enjoying internet radio with vTuner

With this unit, you can enjoy internet radio with vTuner via the internet. In order to listen to internet radio, you must connect this unit to the internet.

For the network connection, see 'Connecting the TV to the internet using an Ethernet cable' or 'Connecting the TV to the internet using a USB wireless LAN adapter' on page 38.

For the network setup, see 'Network' on page 28.

Internet radio playback

After you set up the network connection, follow the following procedure to listen to internet radio.

- 1 Press **NET TV** on the remote control and then use **▲/▼/◀/▶** to select **[vTuner]**.
 - Category list will appear.
 - For the first time only, **[Network service disclaimer]** screen will appear. After confirming the content, use **◀/▶** to select **[Agree]**, then press **OK**.
- 2 In the category list, use **▲/▼** to select the desired category, then press **OK**.

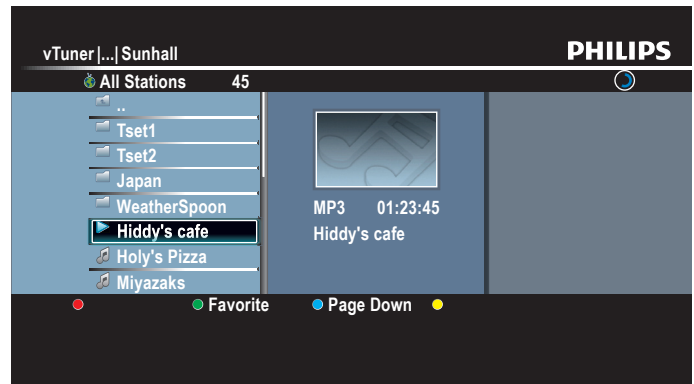

- Station/folder list of selected category will appear.
- For **[Location]** and **[Genre]**, use **▲/▼** to select the desired location or genre after selecting the category, then press **OK**.

[Recently Played]

List of stations which are recently played

[Favorites]

List of your favorite radio stations

[My Added Stations]

List of stations which are added on vTuner website (This category will appear only after you add stations on vTuner website.)

[Location]

List of stations categorized by location

[Genre]

List of stations categorized by genre

[New Stations]

List of new stations

[Most Popular Stations]

List of popular station

[Get access code]

Displays the access code, which will be required when creating a vTuner account on your PC

[Reset]

Removes all stations/folders in **[Recently Played]**, **[Favorites]** and **[My Added Stations]**

- 3 In the station/folder list, use **▲/▼** to select the desired station, then press **OK**.
 - After loading, playback of the selected station will start.
 - If you select a folder; use **▲/▼** to select the desired station in the next hierarchy, then press **OK**.
 - To stop playback, press **■**.
 - To go back to the previous or next hierarchy, press **◀/▶**.

e.g.) Location

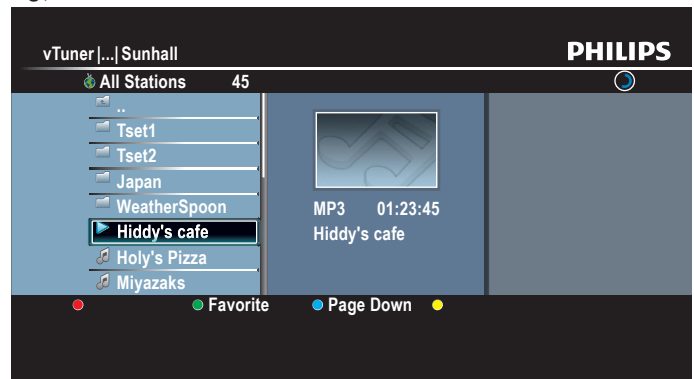

- 4 Press **MENU** to exit.

Note

- This unit cannot play back stations with audio format other than MP3 and WMA.
- For some stations, playback is not available even if the audio format is displayed as MP3 or WMA.
- Internet radio service may not be fully available with narrowband internet connection. (e.g. 56k modem) When listening to internet radio, use broadband internet connection. (For details, contact your internet service provider.)
- Depending on the bit rate of a station or the network environment, it may take a while to complete loading the station or playback may not be available.
- The streaming audio may be interrupted during playback, when the vTuner server is busy.
- Some stations cannot be displayed in the list, depending on the network environment.
- If the loading time of a station exceeds 3 minutes, the loading will be canceled.
- The order of station/folder in the list depends on the information from vTuner server and may change without notice.

Note

- You can also add your favorite stations to **[Favorites]** on your PC. To add your favorite stations on your PC, visit <http://go2service.vtuner.com/ph/> and create a vTuner account with the access code, which you can check from the category list. (See 'Internet radio playback' on page 16.)
- You can change folder names or order of lists in your vTuner page on the internet.
- **[My_Favorite]** folder will appear after you add a station to **[Favorites]** on this unit. (Your favorite station will also be added to **[My_Favorite]** folder.)

Guide to the playback screen

e.g.) Location

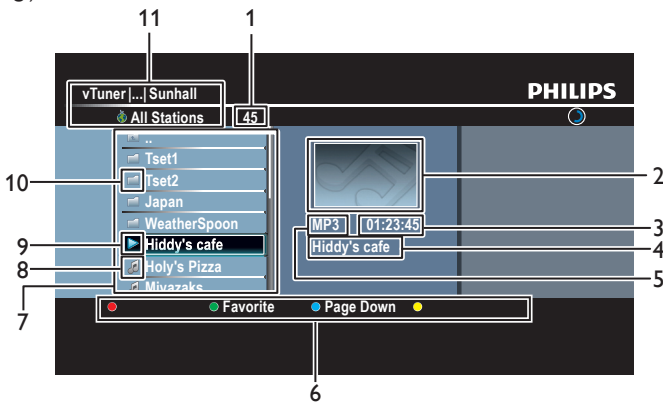

- 1 Number of stations / folders in the current hierarchy
- 2 Image
- 3 Elapsed playing time of the current station
- 4 Current station / folder name
- 5 Audio format of the current station
- 6 Color buttons (red / green / yellow / blue) guide
- 7 Station / folder list
- 8 Station icon
- 9 Playback status
- 10 Folder icon
- 11 Directory

Add to favorite list

You can add your favorite stations to **[Favorites]** in the category list. To add your favorite stations, follow the following procedure.

- 1 Follow steps **1** to **3** in 'Internet radio playback' on page 16.
- 2 Use **▲/▼** to select the station you want to add to **[Favorites]**, then press **Color buttons (green)**.
 - The selected station is added to **[Favorites]** folder.
 - Confirmation message will appear.
 - If you select a folder, use **▲/▼** to select the desired station in the next hierarchy, then press **Color buttons (green)**.
- 3 Press **OK**.

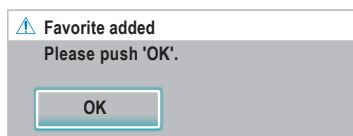

- 4 Press **MENU** to exit.

Remove from favorite list

- 1 Follow steps **1** to **2** in 'Internet radio playback' on page 16.
- 2 Use **▲/▼** to select **[Favorites]**, then press **OK**.
- 3 Use **▲/▼** to select the station you want to remove from **[Favorites]**, then press **Color buttons (green)**.
 - Confirmation message will appear.
- 4 Use **◀/▶** to select **[Yes]**, then press **OK**.
 - The selected station is removed from **[Favorites]** folder.

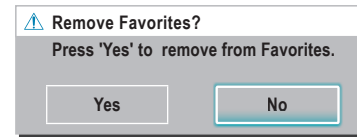

- 5 Press **MENU** to exit.

Add stations on the vTuner website

On the vTuner website, you can add stations which are not in the vTuner station list. To add stations, you must visit <http://go2service.vtuner.com/ph/> and create a vTuner account with the access code for this unit.

- 1 Follow steps **1** to **2** in 'Internet radio playback' on page 16.
- 2 Use **▲/▼** to select **[Get access code]**, then press **OK**.
 - The access code for this unit will be displayed. Please take a note of the access code. (This access code will be required when creating a vTuner account.)
- 3 On your PC, visit <http://go2service.vtuner.com/ph/> and create your vTuner account.
 - Follow the instructions given on the PC screen.
- 4 Add stations by following the instructions given on the PC screen.
 - The stations will be added to **[My Added Stations]**.

Reset the station list

You can remove all stations / folders in **[Recently Played]**, **[Favorites]** and **[My Added Stations]**.

- 1 Follow steps **1** to **2** in 'Internet radio playback' on page 16.
- 2 Use **▲/▼** to select **[Reset]**, then press **OK**.
- 3 Use **▲/▼** to select **[Yes]**, then press **OK**.
 - All stations / folders in **[Recently Played]**, **[Favorites]** and **[My Added Stations]** are removed.
- 4 Press **MENU** to exit.

Using Twitter

You can view your Twitter feeds and more using the Twitter application on this unit.

- For more details about Twitter, please visit www.twitter.com

Before Logging in to Twitter

Follow the procedure below before logging in to Twitter:

- 1 Connect this unit to the internet.
(See 'Connecting the TV to the internet using an Ethernet cable' or 'Connecting the TV to the internet using a USB wireless LAN adapter' on page 38.)
- 2 Set up the necessary network connection settings.
(See 'Network' on page 28.)

Logging in to Twitter

After you set up the network connection, you must log in with your Twitter account.

Make sure the unit is not in Netflix, vTuner or Browse USB mode.

- 1 Press **NET TV** on the remote control and then use **▲/▼/◀/▶** to select **[Twitter]**.
 - Login screen will appear.
 - For the first time only, **[Network service disclaimer]** screen will appear. After confirming the content, use **◀/▶** to select **[Agree]**, then press **OK**.
- 2 Use **▲/▼** to select **[Username]**, then press **OK**.
 - Software keyboard will appear.

Keys on the keyboard	Action
Characters	Select each one of characters from the list.
Clear	Delete the last character in the entry field.
All clear	Delete all characters in the entry field.
a/A/@	Switch case and symbols.
Cancel	Cancel the input.
OK	Determine the input Username and/or Password.

- 3 Use **▲/▼/◀/▶** to input your **[Username]** and **[Password]** into the entry fields. Select **[OK]** after you have filled in all the necessary items in the entry field, then press **OK**.
 - Password can be skipped next time onwards once you have selected **[Remember me]** when registering the user name.
 - Software keyboard will disappear.
- 4 Use **▲/▼/◀/▶** to select **[Start]**, then press **OK**.
 - The unit will now establish a connection with the Twitter server and perform authentication.
- 5 When the unit is logged in successfully, Twitter **[Home]** menu will appear at the left and the timeline will appear at the bottom of the TV screen.

Note

- User name and password are case-sensitive.
- User name will not accept your e-mail account. Use only your user name registered on the Twitter server.
- If you select **[Start]** with no user name, the unit logs in as 'Public'. In this case you can display 'Public timeline' and 'Trends' only.
- For questions regarding Twitter, please visit www.twitter.com

Guide to Twitter menu screen

Twitter Home Screen

Twitter Home Screen consolidates browsing of tweets and some functional menus for Twitter:

To call up the screen, press **NET TV** on the remote control and then use **▲/▼/◀/▶** to select **[Twitter]**.

Single View



- 1 Menu : List of functional menus.
- 2 Viewing channel : Displays currently watching channel.
- 3 Timeline : Displays currently tweeting on Twitter.
- 4 Operation guide : Displays Color buttons (red/green/yellow/blue) guide.

Full View

Single view switches to Full view when you select timeline then press **OK**.

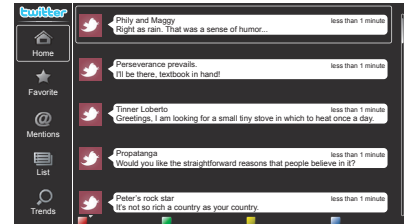

Viewing tweets on the TV

After logging in to Twitter, your TV will download the latest 20 tweets to display.

- 1 Press **NET TV** on the remote control and then use **▲/▼/◀/▶** to select **[Twitter]**.
- 2 Use **▲/▼/◀/▶** to select the desired user name, then press **OK**.
 - If you have not stored the password, **[CUT]** will appear beside the user name.
- 3 When the unit is logged in successfully, Twitter **[Home]** menu will appear at the left and the timeline will appear at the bottom of the TV screen.

Note

- 4 user names (accounts) can be stored in this unit.

Viewing Favorites on Twitter

Your TV displays the logged in user's favorites on Twitter.

- 1 Follow steps **1** to **2** in 'Viewing tweets on the TV' on page 18.
- 2 Use ▲/▼ to select **[Favorite]**, then press **OK**.
 - If you have no favorites, **[TV was not able to acquire the Tweet.]** will appear.

Displaying Mentions on Twitter

Your TV displays replies for the logged in user.

- 1 Follow steps **1** to **2** in 'Viewing tweets on the TV' on page 18.
- 2 Use ▲/▼ to select **[Mentions]**, then press **OK**.
 - If you have no replies, **[TV was not able to acquire the Tweet.]** will appear.

Viewing Lists on Twitter

The list shows timeline categories such as friends, family, colleagues, or sports teams created by yourself on your account.

- 1 Follow steps **1** to **2** in 'Viewing tweets on the TV' on page 18.
- 2 Use ▲/▼ to select **[List]**, then press **OK**.
 - If you have no lists, **[Cannot get the list information.]** will appear.
- 3 When you press **Color buttons (yellow)** in 1 or 5 list view, the timeline will be separated at top and bottom. The upside displays 3 timelines and the downside display 2 timelines.

2 List View

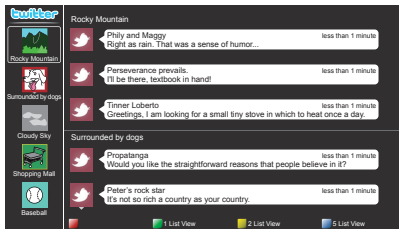

- 4 When you press **Color buttons (blue)** in 1 or 2 list view, the timeline will increase 5 lines.

5 List View



Viewing Trends on Twitter

Trends show topics trending in your area.

- 1 Follow steps **1** to **2** in 'Viewing tweets on the TV' on page 18.
- 2 Use ▲/▼ to select **[Trends]**, then press **OK**.
 - Press **Color buttons (green)** to switch between the **[Area]** and **[Trends]**.
 - If you display **[Area]**, the topside will be displayed some countries, and the downside will be displayed some cities.

Changing picture and sound settings

You must set **[Home]** in **[Location]**. (Refer to page 28.)
Otherwise, personalized picture and sound settings will not be memorized after the unit goes to standby mode.

Changing picture settings

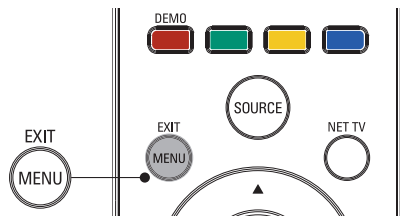

- 1 Press **MENU** on the remote control.
- 2 Use **▲/▼/◀/▶** to select **[Setup] > [Picture]**.

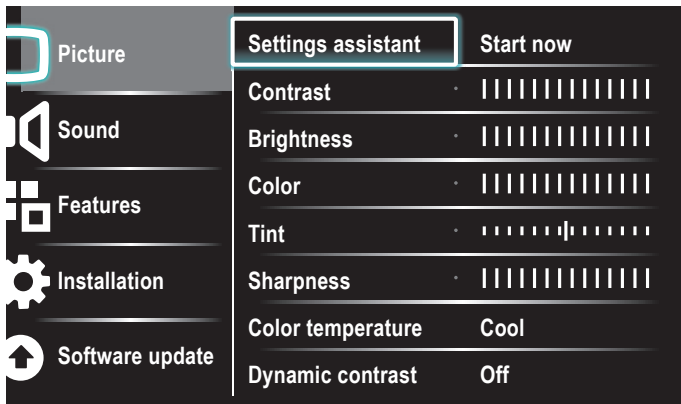

- 3 Use **▲/▼/◀/▶** to select one of the picture settings, and press **OK** to enter the setting.
- 4 Adjust the picture quality.
The following picture settings can be configured. Depending on the format of the picture source, some picture settings are not available.

Setting items	Description	
Settings assistant	Use [Settings assistant] to guide you through the best picture and sound settings.	
Contrast	Adjusts the intensity of bright areas, keeping dark areas unchanged.	
Brightness	Adjusts the intensity and details of dark areas.	
Color	Adjusts color intensity.	
Tint	Adjusts the color balance in an image.	
Sharpness	Adjusts the level of sharpness in image details.	
Color temperature	Cool	More blue tones.
	Normal	Standard tones.
	Warm	More orange tones.
Dynamic contrast	Off	Sets Dynamic contrast to off.
	On	Automatically enhances contrast in an image.
Digital Natural Motion	Off	Sets Digital Natural Motion to off.
	Minimum	Makes an image smoother.
	Maximum	Makes an image smoothest.
Noise reduction	Off	Sets Noise reduction to off.
	On	Reduces noise in an image.
MPEG artifact reduction	Off	Sets MPEG artifact reduction to off.
	On	Reduces a blockiness and a blurriness and judder by digital filter.

Setting items	Description	
Color enhancement	Off	Sets Color enhancement to off.
	On	Makes colors more vivid bright colors.
Active control	Off	Sets Active control to off.
	On with Light Sensor	Adjusts backlight for the best picture quality by dynamically adjusting the backlight intensity in accordance with lighting condition in the room.
	On without Light Sensor	Adjusts backlight for best picture quality based on the incoming video signal.
Picture format	Automatic	Refer to 'Summary of picture formats' on page 21.
	Super zoom	
	4:3	
	Movie expand 14:9	
	Movie expand 16:9	
	Wide screen	
Mode selection	PC	Turns off image enhancement features which makes the TV to act purely as a monitor.
	HDTV	Enables image enhancement features to improve picture quality.
Auto adjustment	The horizontal/vertical position, clock and phase of the PC screen are automatically adjusted.	
Clock	Setting to stabilize the PC screen.	
Phase	Setting to improve the clarity of the PC screen.	
Horizontal shift	Adjusts the horizontal position of the picture for PC screen.	
Vertical shift	Adjusts the vertical position of the picture for PC screen.	

- 5 Press **MENU** to exit.

Note

- **[Mode selection]** will not be displayed when incoming signals are other than 720x480p 60Hz, 1280x720p 60Hz and 1920x1080p 24/30/60Hz.

Changing picture format

- 1 Press **FORMAT** on the remote control.

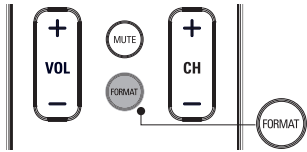

- 2 Use **▲/▼** to select a picture format and press **OK** to confirm your choice.

Summary of picture formats

Display modes can be selected when the broadcasting station is sending 16:9 or 4:3 video signal. And 3 types of display modes can be selected for PC input signal.

For 16:9 (480i, 480p, 720p) video signal

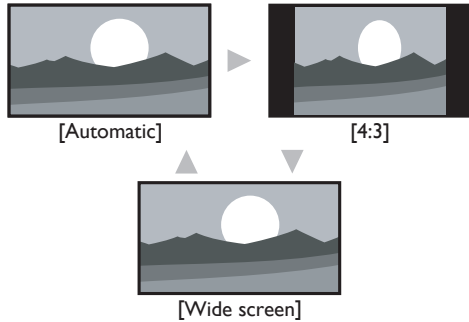

Automatic

Other than DTV and HDMI connected devices, enlarges the picture to best fit the screen. DTV and HDMI connected devices display the picture at its original size. The subtitles may remain visible.

4:3

Display a 16:9 picture at a 4:3 size; the picture is shortened horizontally. Sidebars appear on both edges of the screen.

Wide screen

Display a 16:9 picture that is stretched horizontally and vertically.

For 16:9 (1080i, 1080p) video signal

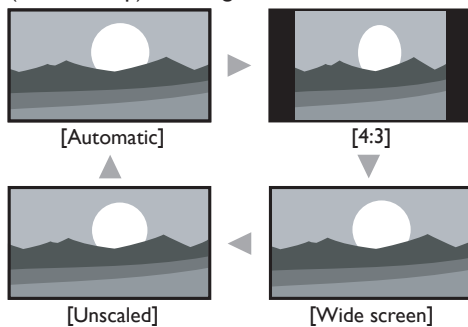

Automatic

Other than DTV and HDMI connected devices, enlarges the picture to best fit the screen. DTV and HDMI connected devices display the picture at its original size. The subtitles may remain visible.

4:3

Display a 16:9 picture at a 4:3 size; the picture is shortened horizontally. Sidebars appear on both edges of the screen.

Wide screen

Display a 16:9 picture that is stretched horizontally and vertically.

Unscaled

Display a 16:9 picture at its original size.

For 4:3 video signal

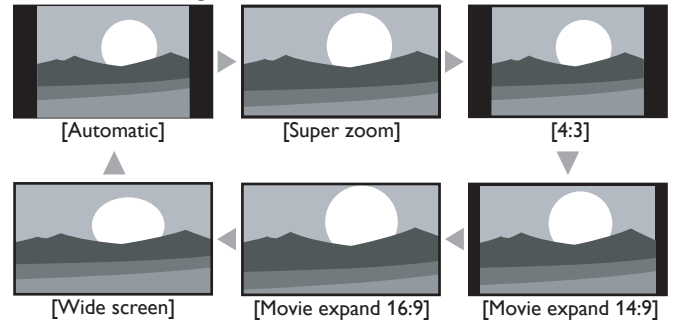

Automatic

Other than DTV and HDMI connected devices, enlarges the picture to best fit the screen. DTV and HDMI connected devices display the picture at its original size. The subtitles may remain visible.

Super zoom

Display a 4:3 picture at a 16:9 size; the picture is stretched horizontally and vertically and its left and right edges are enlarged. This crops out the top and bottom of the picture.

4:3

Display a 4:3 picture at its original size. Sidebars appear on both edges of the screen.

Movie expand 14:9

Display a 4:3 picture at a 14:9 size; the picture is stretched horizontally and vertically. This crops out the top and bottom of the picture. Sidebars appear on both edges of the screen.

Movie expand 16:9

Display a 4:3 picture at a 16:9 size; the picture is stretched horizontally and vertically. This crops out the top and bottom of the picture.

Wide screen

Display a picture that is stretched out of proportion to fill the screen.

For PC input signal

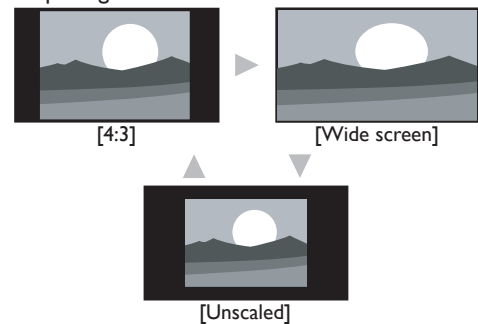

4:3

Display a proportionately stretched picture. Sidebars appear on both edges of the screen.

Wide screen

Display a picture that is stretched out of proportion to fill the screen.

Unscaled

Display a picture in its original size.

Note

- Even if you select either **[Automatic]** or **[Wide screen]** in 16:9 video signal, sidebars appear when the broadcasting station is transmitting up-converted 4:3 analog video signal to be visible by digital broadcasting.

Using your TV as a PC monitor

Use a VGA connector to connect a PC to your TV. For sound, add an audio cable with a stereo mini jack.

! Caution

- Before you connect your PC, set the PC monitor refresh rate to 60Hz.

Supported screen resolutions

The following screen resolutions are supported in PC mode:

Resolution	Refresh rate
640×480	60Hz
800×600	60Hz
1024×768	60Hz
1280×768	60Hz
1360×768	60Hz
1440×900	60Hz
1280×1024	60Hz
1400×1050	60Hz
1680×1050	60Hz
1920×1080	60Hz

Changing sound settings

- 1 Press **MENU** on the remote control and then use **▲/▼/◀/▶** to select **[Setup] > [Sound]**.

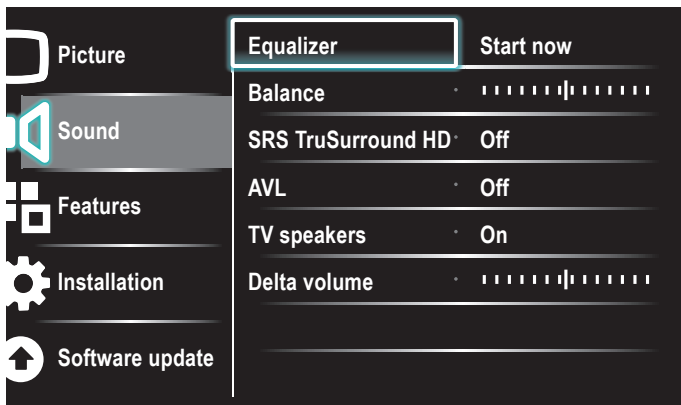

- 2 Use **▲/▼/◀/▶** to highlight a sound setting and then press **OK** to select the setting.
- 3 Adjust the following items.

The following sound settings can be configured. Depending on the sound source, some sound settings are not available.

Setting items	Description	
Equalizer	Adjust tone quality for each frequency.	
Balance	Adjusts the balance of the right and left speakers to best suit your listening position.	
Digital audio language	Available for digital channels only, when multiple languages are broadcast. Lists available audio languages.	
Alternate audio	Main	Available for analog channels only when a main and second audio program (SAP) is broadcast. Select the main audio program.
	SAP	Available for analog channels only when a main and second audio program (SAP) is broadcast. Select the second audio program.
Mono/Stereo	Mono	Outputs mono-audio.
	Stereo	Outputs stereo-audio.

Setting items	Description		
SRS TruSurround HD	Off On	Sets SRS TruSurround HD to off. Selects available modes for surround sound.	
AVL (Auto Volume Leveling)	Off	Sets AVL to off.	
	On	Reduces sudden changes in volume, for example, during commercials or when switching channels.	
TV speakers	Off	The sound will not be output from the unit's speakers.	
	On	The sound will be output from the unit's speakers.	
	Speakers EasyLink	You can control audio output from your connected EasyLink Compliant Devices with VOL +/- by using this unit's remote control.	
Delta volume	If a channel or input device is:	Too Loud	Navigate to that channel or input device and set a negative delta volume level as per your personal preferences.
		Too Soft	Navigate to that channel or input device and set a positive delta volume level as per your personal preferences.

- 4 Press **MENU** to exit.

≡ Note

- **[Master EasyLink]** must be activated in the **[Preferences]** menu to make the **[TV Speakers]** menu available when you select **[On]** or **[Speakers EasyLink]**.

Using auto mode

- 1 Press **AUTO MODE** to set your TV to a predefined picture and sound setting.
- 2 Use **▲/▼** to select one of the following settings:
 - **[Personal]**: The customized settings you defined by using the **[Picture]** menu.
 - **[Sports]**: Vivid picture settings and clear sound for high action.
 - **[Standard]**: For normal TV viewing.
 - **[Movie]**: Brilliant picture settings for a cinematic experience.
 - **[Game]**: Optimized for PCs, games consoles and playstations.
 - **[Internet Video]**: Optimized for low bitrate internet video.
 - **[Power Saver]**: Eco TV settings for lower power consumption.

Create and use lists of favorite channels

You can create lists of your preferred TV channels and radio stations so that you can find those channels easily.

Select a list of favorite channels

- 1 Press **FAV** on the remote control.

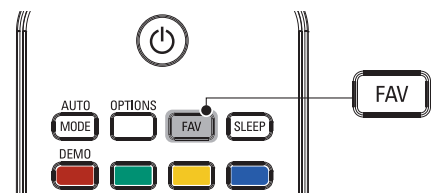

↳ Your lists of favorite channels are displayed.

- 2 Use **▲/▼** to highlight a list, and then press **OK** to select the list.

Create or edit a list of favorite channels

- 1 Press **FAV** on the remote control to display your lists of favorite channels.
- 2 Use **▲/▼** to highlight a list, and then press **OK** to select the list.
- 3 Press **OPTIONS** to enter edit mode.
↳ A list of channels is shown.
- 4 Use **▲/▼** to highlight a channel.
- 5 Press **OK** to select or deselect the highlighted channel.
↳ The channel is added to or removed from the list of favorite channels.
- 6 Press **MENU** to exit.

Switch to one of the channels on a list

- 1 Press **OK** on the remote control to display the last list that you selected.
- 2 Use **▲/▼** to highlight a channel.
- 3 Press **OK** to select the channel.
↳ The TV switches to that channel.



Tip

- Press **CH +/-** to select channels in a list or press the numeric keys to select channels that are not in a list.

Setting the clock

You can set the time on your TV.

Setting the time automatically

Some digital channels transmit the time. For these channels, you can set the time automatically and choose which channel to read the time from.

- 1 Press **MENU** on the remote control and then use **▲/▼/◀/▶** to select **[Setup] > [Installation] > [Clock] > [Auto clock mode]**.
- 2 Select **[Automatic]** and then press **OK** to confirm your choice.
- 3 Select the channel from which the TV reads the time.
 - Use **▲/▼** and then press **OK** to enter the menu for **[Auto clock channel]**.
 - Use **▲/▼** to highlight a channel.
 - Press **OK** to confirm your choice.
- 4 (Optional) Select the time zone.
 - Use **▲/▼** and then press **OK** to enter the menu for **[Time zone]**.
 - Use **▲/▼** to highlight the time zone.
 - Press **OK** to confirm your choice.
- 5 (Optional) Set daylight saving.
 - Use **▲/▼** and then press **OK** to enter the menu for **[Daylight saving]**.
 - Use **▲/▼** to highlight **[Automatic]** or **[Off]**.
 - Press **OK** to confirm your choice.
- 6 Press **MENU** to exit.

Setting the time manually

- 1 Press **MENU** on the remote control and then use **▲/▼/◀/▶** to select **[Setup] > [Installation] > [Clock] > [Auto clock mode]**.
- 2 Select **[Manual]**, and then press **OK** to confirm your choice.
- 3 Use **▲/▼** to select **[Time]** and then press **OK** to set the time. Use the format HH:MM. Select **[AM]/[PM]** for morning or afternoon.
- 4 Press **BACK** to confirm your choice.
- 5 Use **▲/▼** and then press **OK** to enter the menu for **[Day]**.
- 6 Use **▲/▼** to select the day.
- 7 Press **OK** to confirm your choice.
- 8 Press **MENU** to exit.

Closed caption

Closed captioning is an assistive technology that allows persons with hearing disabilities to access television programming. Closed captioning displays the audio portion of programming as text superimposed over the video.



Note

- Closed captioning service may not be controlled by this unit's menu options if you are watching television through an external cable or satellite set top box. In which case you will need to use the menu options on the external set top box to control Closed Captioning.
- The captions do not always use correct spelling and grammar. Not all TV programs and product commercials include closed caption information. Refer to your area TV program listings for the TV channels and times of closed caption shows. The captioned programs are usually noted in the TV listings with service marks such as **[CC]**.

Display captions

- 1 Press **MENU** on the remote control and then use **▲/▼/◀/▶** to select **[Setup] > [Features] > [Caption settings] > [Closed captions]**.
- 2 Press **▲/▼** to select **[On]**, **[Off]** or **[On during mute]**, and press **OK** to confirm your choice.
- 3 Press **MENU** to exit.

DTV

Selecting DTV caption services

- 1 Select a caption service for digital channels:
 - Press **MENU** on the remote control and then use **▲/▼/◀/▶** to select **[Setup] > [Features] > [Caption settings] > [Digital caption service]**.
 - Use **▲/▼** to select one of the listed caption services, and then press **OK** to confirm your choice.

CS-1 to CS-6

Select one of these before changing any other item in **[Caption settings]** menu. Choose **[CS-1]** under normal circumstances.

- 2 Press **MENU** to exit.

Selecting how captions are displayed

You can choose the size, font, color, background and other characteristics of the caption text.

- 1 Press **MENU** on the remote control and then use **▲/▼/◀/▶** to select **[Setup] > [Features] > [Caption settings] > [Digital caption options]**.
- 2 Use **▲/▼** to highlight an option for digital captions, and press **OK** to select the option.
- 3 Use **▲/▼** to highlight a setting for the option, and press **OK** to confirm your choice.
- 4 Press **MENU** to exit.

Difficulties viewing closed captions on DTV programming

If you have difficulties viewing closed captions on DTV programming, including HDTV, received from your subscription television provider, you should:

- consult any consumer information and manuals/guides on closed captions for DTV programming provided by your subscription television provider;
- ensure that the captioning function on your set-top box, if applicable, is turned on; and,
- ensure that the captioning function on your DTV is turned on.

If you are still unable to view closed captions on DTV programming, you should contact your subscription television provider for assistance.

TV

Selecting caption services

- 1 Select a caption service for analog channels:
 - Press **MENU** on the remote control and then use **▲/▼/◀/▶** to select **[Setup]** > **[Features]** > **[Caption settings]** > **[Caption service]**.
 - Use **▲/▼** to select one of the listed caption services, and press **OK** to confirm your choice.
- 2 Press **MENU** to exit.

Note

- Not all caption services are used by a TV channel during the transmission of a closed caption program.

Summary of caption services

Service	Description
CC-1 and T-1;	are the primary caption and text services. The captioning or text is displayed in the same language as the program's dialogue (up to 4 lines of script on the TV screen, where it does not obstruct relevant parts of the picture).
CC-3 and T-3;	serve as the preferred data channels. The captioning or text is often a secondary language.
CC-2, CC-4, T-2 and T-4;	are rarely available and broadcasters use them only in special conditions, such as when [CC-1] and [CC-3] or [T-1] and [T-3] are not available. <ul style="list-style-type: none">• There are 3 display modes according to programs: Paint-on mode: Displays input characters on the TV screen immediately. Pop-on mode: Once characters are stored in memory, they are displayed all at once. Roll-up mode: Displays the characters continuously by scrolling (max. 4 lines).

Sleeptimer

You can always put your TV in standby mode earlier or reset the sleeptimer during the countdown.

- 1 Press **SLEEP** to set the sleeptimer. (Also, you can set the sleeptimer in **[Features]** menu.)
- 2 Use **SLEEP** or **◀/▶** repeatedly to change the amount of time (in increments of 30 minutes up to 180 minutes).

- Each press of **SLEEP** or **▶** will increase the time by 5 minutes.
- Each press of **◀** will decrease the time by 5 minutes.
- After setup, the sleep timer display can be called up for checking by pressing **SLEEP**.



Tip

To Cancel the Sleep Timer

- Press **SLEEP** or **◀/▶** repeatedly until "0" is displayed on the TV screen.

Child and rating locks

You can prevent your children from watching certain programs or certain channels by locking the TV controls and by using ratings.

Setting your PIN

- 1 Press **MENU** on the remote control and then use **▲/▼/◀/▶** to select **[Setup]** > **[Features]** > **[Child lock]**.
- 2 Enter a 4-digit PIN on the **Number buttons**, of the remote control.
 - If you have not set up your PIN, enter **[0], [0], [0], [0]**.

Changing your PIN

- 1 Press **MENU** on the remote control and then use **▲/▼/◀/▶** to select **[Setup]** > **[Features]** > **[Change PIN]**.
- 2 Enter a 4-digit PIN on the **Number buttons** of the remote control.
 - If you have a PIN, enter your current PIN.
 - If you do not have a PIN, enter **[0], [0], [0], [0]**.
 - If you have forgotten your PIN, enter **[0], [7], [1], [1]**.
- 3 Enter your new PIN.
- 4 Enter your PIN again to confirm.
- 5 Press **MENU** to exit.

Lock the TV

This section describes how to lock all channels on the TV. At the specified time, screen is blanked out and the audio is muted.

- 1 Ensure that the clock is set with the current time. (See 'Setting the clock' on page 23.)
- 2 Press **MENU** on the remote control and then use **▲/▼/◀/▶** to select **[Setup]** > **[Features]** > **[Child lock]**.
- 3 Enter your PIN. (See 'Setting your PIN' on page 24.)
- 4 Use **▲/▼** to select **[Lock after]**, then press **OK**.
- 5 Press **OK** to select **[Timer]**.
- 6 Use **▲/▼** to select **[On]** and activate the **[Lock after]** feature. Select **[Off]** to deactivate the feature.
- 7 Press **OK** to confirm your choice.
- 8 Use **▲/▼** to select **[Time]** and then press **OK** to set the time. Use the format HH:MM, and select **[AM]** / **[PM]** for morning or afternoon.
- 9 Press **BACK** to confirm the time.
- 10 Press **MENU** to exit.
- 11 Turn the TV off and on again.

Locking a channel or input source

This section describes how to lock input sources or specified channels. The channels can be selected but the screen is blanked out and the audio is muted.

- 1 Press **MENU** on the remote control and then use **▲/▼/◀/▶** to select **[Setup] > [Features] > [Child lock]**.
- 2 Enter your PIN. (See 'Setting your PIN' on page 24.)
- 3 Use **▲/▼** to select **[Channel Lock]**, then press **OK**.

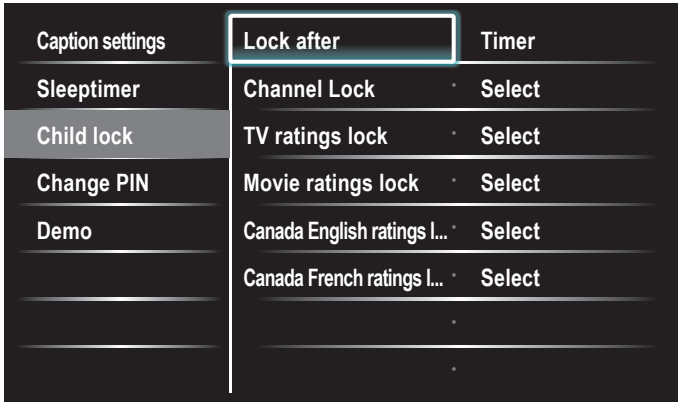

- 4 Use **▲/▼** and then press **OK** repeatedly to switch between locked and not locked. Each rating has a box-graphic in front of it to indicate whether it is locked:
 - A box with **x** indicates that the channel or input source is locked.
 - An empty box indicates that the channel or input source is not locked.
- 5 Press **MENU** to exit.

Using the TV ratings lock

Your TV is equipped with a V-chip that allows you to control access to individual programs based on their age rating and content rating. The program content advisory data are sent by the broadcaster or by the program provider.

If you receive channels through a set-top box or cable box connected by HDMI, you cannot use the TV ratings lock. Your set-top box or cable box must be connected through RF or AV connectors.

- 1 Press **MENU** on the remote control and then use **▲/▼/◀/▶** to select **[Setup] > [Features] > [Child lock]**.
- 2 Enter your PIN. (See 'Setting your PIN' on page 24.)
- 3 Use **▲/▼** to select **[TV ratings lock]**, then press **OK**.
- 4 Use **▲/▼/◀/▶** and then press **OK** repeatedly to switch between locked and not locked.

Each rating has a box-graphic in front of it to indicate whether it is locked:

 - A box with **x** indicates that all items in the content ratings list are locked.
 - An empty box indicates that no items in the content ratings list are locked.
 - A box with **/** indicates that some items in the content ratings are already locked and some items remain not locked.

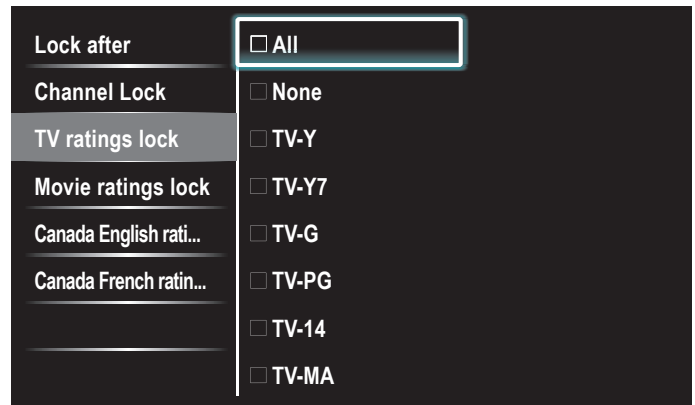

- When you select **[All]**, all items in the ratings list are locked.
- When you select **[None]**, programs with no rating and programs with a rating of none are locked.
- When you lock a rating, all ratings in the younger age categories are automatically locked.

- 5 Press **MENU** to exit.

Summary of TV ratings

Age rating	Content rating
All	None
None	None
TV-Y : Appropriate for children of all ages with themes and elements suitable for children aged 2-6.	None
TV-Y7 : Programs designed for children age 7 and older.	[Fantasy Violence]
TV-G : Programs suitable for all ages. These programs contain little or no violence, no strong language and little or no sexual dialog or situations.	None
TV-PG : Programs contain elements that some parents may find unsuitable for younger children and which may need parental guidance. The program may contain moderate violence, sexual dialog and/or situations and some strong language.	[Dialog] [Language] [Sex] [Violence]
TV-14 : Programs contain elements that may not be suitable for children under 14 years of age. These programs include one or more of the following: intense violence, intense sexual situations, suggestive dialog and strong language.	[Dialog] [Language] [Sex] [Violence]
TV-MA : Programs are designed to be viewed by adults and may be unsuitable for children under the age of 17. These programs may contain graphical violence, explicit sexual activity and/or crude or indecent language.	[Language] [Sex] [Violence]

Note

- The V-Chip can block non rated programs as per "CEA-608-E sec. L.3". If the option to block **[None]**, **[NR]**, **[E]** or **[E]** programs is used in **[TV ratings lock]**, **[Movie ratings lock]**, **[Canada English ratings lock]** or **[Canada French ratings lock]** accordingly "unusual results may occur; and the unit may not receive emergency bulletins or other types of programming":
Emergency Bulletins (Such as EAS messages, weather warnings and others) · Locally originated programming · News · Political · Public Service Announcements · Religious · Sports · Weather.

Using the movie ratings lock

You can control viewing of movies based on their MPAA (Motion Picture Association of America) rating.

- 1 Press **MENU** on the remote control and then use **▲/▼/◀/▶** to select **[Setup] > [Features] > [Child lock]**.
- 2 Enter your PIN. (See 'Setting your PIN' on page 24.)
- 3 Select one of the menus for movie ratings lock.
 - In the USA, select **[Movie ratings lock]**.
 - In Canada, select **[Canada English ratings lock]** or **[Canada French ratings lock]**.

The following screen shows the ratings in **[Movie ratings lock]**.

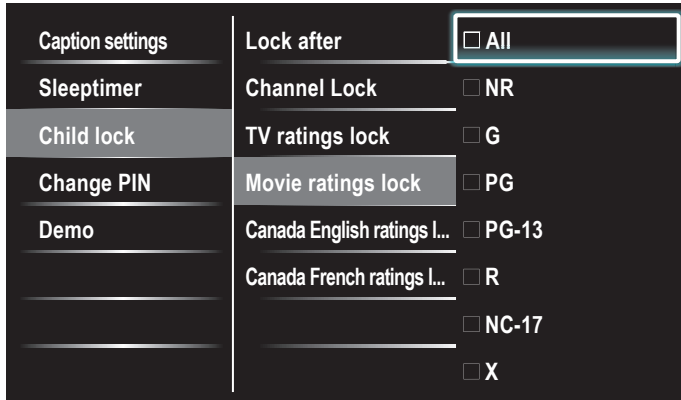

- 4 Use **▲/▼** and then press **OK** repeatedly to switch between locked and not locked. Each rating has a box-graphic in front of it to indicate whether it is locked:
 - A box with **x** indicates that all items in the rating are locked.
 - An empty box indicates that no items in the rating are not locked.
 - When you select **[All]**, all items in the ratings list are locked.
- 5 Press **MENU** to exit.

Summary of Movie ratings lock

Rating	Description
All	All items in the ratings list are locked.
NR	Not rated.
G	Movies with a mild content, suitable for all ages.
PG	Movies for which parental guidance is recommended. They may contain a few racy or violent scenes or maybe some bad language.
PG-13	Movies for which parental guidance may be recommended if under age 13.
R	Restricted. The movies usually contain offensive sex or bad language and may be unsuitable for children under the age of 17. Parental guidance or permission needed.
NC-17	Even with parental permission, forbidden under age 17. More offensive sex, violence or bad language.
X	Movies which generally focus on sex, violence and/or bad language. Also known as pornography.

Summary of Canada English ratings lock

Rating	Description
All	All items in the ratings list are locked.
E	Exempt program.
C	Programming suitable for children under the age of 8 years. No profanity or sexual content of any level allowed. Minimal comedic violence.
C8+	Suitable for children ages 8 and over. Low intensity violence and fantasy horror allowed.
G	Movies with a mild content, suitable for all ages.
PG	Movies for which parental guidance is recommended. They may contain a few racy or violent scenes or maybe some bad language.
14+	Programming intended for children ages 14 and over. May contain intense scenes of violence, strong profanity, and depictions of sexual activity within the context of a story.
18+	Programming intended for viewers ages 18 and over. May contain strong violence, language, and sexual activity.

Summary of Canada French ratings lock

Rating	Description
All	All items in the ratings list are locked.
E	Exempt program.
G	Appropriate for all ages with little or no violence and little to no sexual content.
8ans+	Appropriate for children 8 and up which may contain little violence, some foul language and/or little to no sexual content.
13ans+	Appropriate for children 13 and up, with moderate violence, language, and some sexual situations. Persons under 13 should be accompanied by an adult.
16ans+	Appropriate for children 16 and up, with strong violence, strong language, and strong sexual content.
18ans+	Only to be viewed by adults and contains extreme violence and graphic sexual content/pornography.

Note

- The V-Chip can block non rated programs as per "CEA-608-E sec. L.3". If the option to block **[None]**, **[NR]**, **[E]** or **[E]** programs is used in **[TV ratings lock]**, **[Movie ratings lock]**, **[Canada English ratings lock]** or **[Canada French ratings lock]** accordingly "unusual results may occur; and the unit may not receive emergency bulletins or other types of programming":
Emergency Bulletins (Such as EAS messages, weather warnings and others) · Locally originated programming · News · Political · Public Service Announcements · Religious · Sports · Weather.

Use the region ratings lock

You can control access to digital programs based on downloaded region ratings. Before you download a ratings table, ensure that regional ratings are broadcast.

- 1 Press **MENU** on the remote control and then use **▲/▼/◀/▶** to select **[Setup] > [Features] > [Child lock]**.
- 2 Enter your PIN. (See 'Setting your PIN' on page 24.)
- 3 Use **▲/▼** to select **[Region ratings lock]**, then press **OK**.
- 4 Use **▲/▼** and then press **OK** repeatedly to switch between locked and not locked. Each rating has a box-graphic in front of it to indicate whether it is locked:
 - A box with **x** indicates that the rating locked.
 - An empty box indicates that the rating is not locked.
- 5 Press **MENU** to exit.

Use the demo mode

You can use demonstrations to better understand the features of your TV.

- 1 Press **MENU** on the remote control and then use **▲/▼/◀/▶** to select **[Setup] > [Features] > [Demo]**. Also, you can enter the demo mode when you press **DEMO**.
- 2 Use **▲/▼** to highlight a demo, and press **OK** to start the demo.
- 3 Follow the on-screen instructions to enjoy the demo.
- 4 Press **MENU** to exit.

Use Philips EasyLink

Your TV supports Philips EasyLink, which enables one-touch play and one-touch standby between EasyLink-compliant devices. Compliant devices must be connected via an HDMI connector.

One-touch play

When you connect your TV to devices that support one-touch play, you can control your TV and the devices with one remote control. For example, when you press **▶ (play)** on your DVD remote control, your TV automatically switches to the correct channel to show the DVD content.

One-touch standby

When you connect your TV to devices that support standby, you can use your TV remote control to put your TV and all connected HDMI devices in standby mode. You can perform one-touch standby using the remote control from any of the connected HDMI devices.

System audio control

When you connect your TV to HDMI CEC compliant devices, your TV can switch automatically to play audio from the connected device. To use one-touch audio, you must map the audio input from the connected device to your TV. You can use the remote control from the connected device to adjust the volume.

Remote control (RC) key forwarding

RC key forwarding allows you to control EasyLink-compliant devices using your TV remote control.

Activate Master EasyLink

- 1 Press **MENU** on the remote control and then use **▲/▼/◀/▶** to select **[Setup] > [Installation] > [Preferences] > [EasyLink] > [Master EasyLink]**.
- 2 Use **▲/▼** to select **[On]**.

Note

- Select **[Off]** to disable this function.
- Philips does not guarantee 100% interoperability with all HDMI CEC devices.
- The EasyLink-compliant device must be switched on and selected as the source.

[Master EasyLink] must be activated in the **[Preferences]** menu to make the **[TV Speakers]** menu available in the **[Sound]** menu.

EasyLink

This function allows you to operate the linked functions between our brand devices with EasyLink capabilities and this unit connected via a HDMI cable.

- 1 Press **MENU** on the remote control and then use **▲/▼/◀/▶** to select **[Setup] > [Installation] > [Preferences] > [EasyLink]**.

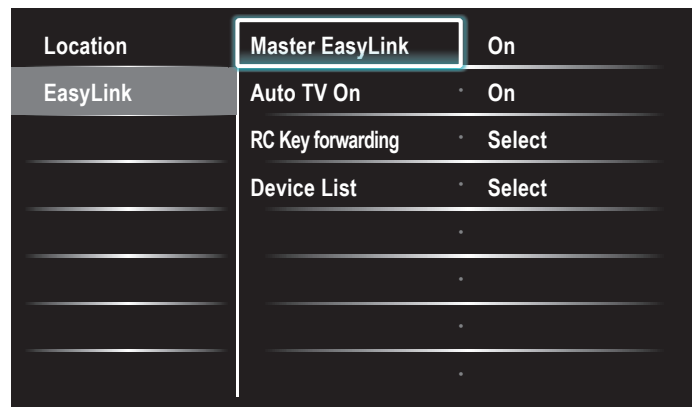

- 2 Use **▲/▼** to highlight the desired setting and then press **OK** to select the setting.
- 3 Adjust the following items.

[Master EasyLink]

Set the EasyLink **[On]** or **[Off]**.

The following additional settings will disappear when you set to **[Off]**.

Use **▲/▼** to select the desired option, then press **OK**.

Off	Disable all EasyLink.
On	Select if you have connected an external device that is compatible with the EasyLink function.

[Auto TV On]

Use **▲/▼** to select the desired option, then press **OK**.

Off	This unit remains in standby mode even if you turn on your connected EasyLink device.
On	This unit turns on automatically when you turn on your connected EasyLink device.

[RC Key forwarding]

Use **▲/▼** to select the desired option, then press **OK**.

HDMI1 to HDMI4	Select enable or disable RC key forwarding if this unit connected through HDMI1 to HDMI4 to your EasyLink devices.
----------------	--

[Device List]

This function lets you see the product name of connected devices.

Use **▲/▼** to select the desired HDMI device listed on the TV screen, then press **OK**.

- 4 Press **MENU** to exit.

Set your location to home

You can set the location of your TV to **[Home]** or **[Retail store]**. Choosing **[Home]** gives you full flexibility to change predefined settings for picture and sound.

- 1 Press **MENU** on the remote control and then use **▲/▼/◀/▶** to select **[Setup]** > **[Installation]** > **[Preferences]** > **[Location]**.
- 2 Select **[Home]** and then press **OK** to confirm your choice.
- 3 Press **MENU** to exit.

Note

- You must set **[Home]**. Otherwise, personalized picture and sound settings will not be memorized after the unit goes to standby mode.

Network

Set up network connection settings in order to use Netflix, vTuner internet radio, Twitter or network update function.

Network selection

Before you proceed to **[Connection test]** or other settings in **[Network]** section, set this selection to suit your preference.

- 1 Press **MENU** on the remote control and then use **▲/▼/◀/▶** to select **[Setup]** > **[Installation]** > **[Network]** > **[Network selection]**.
- 2 Use **▲/▼** to select a setting and then press **OK**.

Setting items	Description
Wired	Select to use an Ethernet cable to connect to the internet by wired connection.
Wireless	Select to use a USB wireless LAN adapter to connect to the internet by wireless connection.

- 3 Press **MENU** to exit.

Connection test

Perform the following steps to test your internet connection after you have connected an Ethernet cable or entered network settings such as IP address, DNS settings, etc. manually.

- 1 Press **MENU** on the remote control and then use **▲/▼/◀/▶** to select **[Setup]** > **[Installation]** > **[Network]** > **[Connection test]**. Connection test will start automatically and the test result will appear right after the connection test finishes.
 - **[Testing...]**: The test is in progress.
 - **[Pass]**: Connection test is successfully completed.
 - **[Fail]**: Connection test failed. Check the connection settings.Press **OK** to go to the list of network status confirmation screen.
- 2 Press **MENU** to exit.

Note

- If the connection test passes, you are ready to use Netflix, vTuner internet radio, Twitter or network update function using the internet without making any additional settings.
- If the connection test fails, check if the Ethernet cable is connected to this TV properly or if you have entered all the required details for the wireless LAN connection properly.

Wireless network

This menu is displayed only when you set **[Wireless]** in **[Network selection]**. In order to use a wireless network, you must set up a connection to the Wireless LAN Access Point (AP) (e.g. wireless router).

Wireless network setting (Auto)

Search for wireless networks automatically and select the wireless network name (SSID) from the list.

- 1 Press **MENU** on the remote control and then use **▲/▼/◀/▶** to select **[Setup]** > **[Installation]** > **[Network]** > **[Wireless network]** > **[Wireless network setting]** > **[Auto]**.
 - This unit will start searching for wireless networks automatically.
- 2 The list of wireless networks will be displayed. Use **▲/▼** to select the appropriate wireless network name (SSID), then press **OK**.
- 3 Use **▲/▼** to select the authentication setting of the selected wireless network.
 - For a wireless network with authentication setting, select the authentication setting, according to the security type of the wireless network.
 - For a wireless network without authentication setting, select **[None]**.

[None]

Set the authentication setting to **[None]**.

[WEP]

Set the authentication setting to **[WEP]**.

[WPA-PSK (TKIP)]

Set the authentication setting to **[WPA-PSK (TKIP)]**.

[WPA-PSK (AES)]

Set the authentication setting to **[WPA-PSK (AES)]**.

[WPA2-PSK (TKIP)]

Set the authentication setting to **[WPA2-PSK (TKIP)]**.

[WPA2-PSK (AES)]

Set the authentication setting to **[WPA2-PSK (AES)]**.

- If you select **[WEP]**, **[WPA-PSK (TKIP)]**, **[WPA-PSK (AES)]**, **[WPA2-PSK (TKIP)]** or **[WPA2-PSK (AES)]**, WEP/WPA Key entry screen will appear. Enter the WEP/WPA key of the selected wireless network using **▲/▼/◀/▶**, then press **OK**.
 - [Clear]** : Clear the entered number or word.
 - [All clear]** : Clear all the entered numbers or words.
 - [a/A/@]** : Switch between abc, ABC and @!?
 - [Cancel]** : Shows the cancellation display.
 - [OK]** : Set the entered number or word.
- Confirmation message will appear. Select **[Yes]** to complete the settings.

- 4 Press **MENU** to exit.

Note

- For a wireless network with authentication setting, key icon appears to the right hand of the wireless network name (SSID).
- Signal icon shows the strength of the signal.
- WEP/WPA key appears as asterisks on the confirmation screen.
- The supplied USB wireless LAN adapter supports following specifications.
 - Wireless standards : IEEE 802.11 b/g/n
 - Frequency spectrum : 2.4GHz
 - Security protocol : WEP/WPA/WPA2

Wireless network setting (Manually enter your SSID)

Set up the connection to the Wireless LAN Access Point (AP) (e.g. wireless router) manually by entering the wireless network name (SSID).

- Press **MENU** on the remote control and then use **▲/▼/◀/▶** to select **[Setup] > [Installation] > [Network] > [Wireless network] > [Wireless network setting] > [Manually enter your SSID]**.
 - Wireless LAN Access Point (AP) (e.g. wireless router) Name (SSID) entry screen will appear.
Enter the wireless network name (SSID) using **▲/▼/◀/▶**, then press **OK**.
 - [Clear]** : Clear the entered number or word.
 - [All clear]** : Clear all the entered numbers or words.
 - [a/A/@]** : Switch between abc, ABC and @!?
 - [Cancel]** : Shows the cancellation display.
 - [OK]** : Set the entered number or word.
- Follow steps **3** to **4** in 'Wireless network setting(Auto)' on page 28.

Wireless network status

This menu displays only when you set **[Wireless]** in **[Network selection]**. You can check the status of Wireless network status.

- Press **MENU** on the remote control and then use **▲/▼/◀/▶** to select **[Setup] > [Installation] > [Network] > [Wireless network] > [Wireless network status]**.
 - Wireless network status list will be displayed.
- Press **MENU** to exit.

IP configuration

In following cases, select **[IP configuration]** to set each setting as necessary.

- When connection test failed with the setting of **[Connection test]**.
- When instructed by your internet service provider to make specific settings in accordance with your network environment.

- Press **MENU** on the remote control and then use **▲/▼/◀/▶** to select **[Setup] > [Installation] > [Network] > [IP configuration]**.
- Use **▲/▼** to select a setting and then press **OK**.

Setting items		Description
IP setting mode	Auto	Sets the IP setting automatically.
	Manual	Sets the IP setting manually.
IP address* ^{1,3}		A set of numbers which are assigned to devices participating in a computer network.
Subnet mask* ^{1,3}		A mask which is used to determine what subnet an IP address belongs to.
Default gateway* ^{1,3}		IP address of the network device (such as router) which provides internet access.
DNS setting mode	Auto	Sets the DNS setting automatically.
	Manual	Sets the DNS setting manually.
Primary DNS* ^{2,3}		A server which handles the name and IP address over the internet.
Secondary DNS* ^{2,3}		A server which handles the name and IP address over the internet.
MAC address		An address which recognizes the devices connecting to the network. It is also called Hardware Address.

*¹ Items can be selected only when **[IP setting mode]** is set to **[Manual]**.

*² Items can be selected only when **[DNS setting mode]** is set to **[Manual]**.

*³ Use **▲/▼** or **the Number buttons** to input numbers. When you press **▲/▼** to input numbers then press **OK** or input the triple digits by using **the Number buttons**, the cursor moves to the next entry field. When you press **▲/▼** to input numbers then press **OK** or input the triple digits by using **the Number buttons** at the rightmost entry field, numbers will be stored and go back to the previous menu.

- Press **MENU** to exit.

Note

- The range of input numbers is between 0 and 255.
- If you enter a number larger than 255, the number will automatically be 255.
- The manually entered number will be saved even if you change the setting to **[Auto]**.
- When you enter a wrong number, press **Color buttons (red)** to cancel. (the number will be back to **[0]**.)
- If you want to enter 1 or 2 digit number in one cell, press **OK** to move on to the next cell.
- If the entered IP address or the default gateway or primary DNS number is same as the default setting, IP address setting will be set to **[Auto]**. (The manually entered number will be saved).
- When IP address setting is set to **[Manual]**, the setting of DNS setting will automatically be **[Manual]** and when IP address setting is set to **[Auto]**, you can set either **[Auto]** or **[Manual]** for DNS setting.

Proxy configuration

- Press **MENU** on the remote control and then use **▲/▼/◀/▶** to select **[Setup] > [Installation] > [Network] > [Proxy configuration]**.
- Use **▲/▼** to select a setting and then press **OK**.
 - For default settings, select **[Do Not Use]**.
 - If you need to change the proxy setting as instructed by your internet service provider to set the designated proxy address and port, select **[Use]**.

Setting items		Description
Proxy setting	Do not Use	Not use the proxy server.
	Use	Uses the proxy server.
Proxy address*		Selects the number or word by using ▲/▼/◀/▶ , then press OK . [Clear] : Clear the entered number or word. [All clear] : Clear all the entered numbers or words. [a/A/@] : Switch between abc, ABC and @!? [Cancel] : Shows the cancellation display. [OK] : Set the entered number or word.
Proxy port*		Use ▲/▼ or the Number buttons to input numbers.

* Items can be selected only when **[Proxy port]** is set to **[Use]**.

- Press **MENU** to exit.

Note

- The range of input numbers for the port number is between 0 and 65535. (If you enter a number larger than 65535, it will be regarded as 65535.)
- For proxy port, the selected ports may be blocked and not be able to use depending on your network environment.
- If the proxy address is entered with blank only, proxy server setting will be set to **[Do Not Use]**.

Setting status

You can check the status of network settings.

- 1 Press **MENU** on the remote control and then use **▲/▼/◀/▶** to select **[Setup] > [Installation] > [Network] > [Setting status]**.
 - Network setting list will be displayed.
 - MAC address of this unit will be displayed in the list.
- 2 Press **MENU** to exit.

Disclaimer

Displays the network service disclaimer.

- 1 Press **MENU** on the remote control and then use **▲/▼/◀/▶** to select **[Setup] > [Installation] > [Network] > [Disclaimer]**.
- 2 Press **MENU** to exit.

Netflix connection

Displays the cancellation setting of Netflix or ESN information.

- 1 Press **MENU** on the remote control and then use **▲/▼/◀/▶** to select **[Setup] > [Installation] > [Network] > [Netflix]**.

Setting items	Description	
Deactivation	Yes	Deactivate the connection to Netflix.
	No	Activate the connection to Netflix.
ESN	Displays the ESN (Electronic Serial Number) to get any services from Netflix.	

- 2 Press **MENU** to exit.

View photos and play music on a USB storage device

! Caution

- This unit accepts USB flash memory only. Other storage devices such as external HDD by USB bus power will not work.
- Philips is not responsible if the USB storage device is not supported nor is it responsible for damage or loss of data from the device.

Your TV is fitted with a USB connection that enables you to view photos or listen to music stored on a USB storage device.

Supported formats	Not-supported formats
MP3	File name exceeding 256 characters
JPEG	Progressive JPEG files
FAT/DOS-formatted memory devices	File names containing a dot character

It is recommended that files to be played back in this unit are recorded under the following specifications:

<MP3>

- Sampling frequency : 32 kHz or 44.1 kHz or 48 kHz
- Constant bit rate : 32 kbps - 320 kbps

<JPEG>

- Upper limit : 16 Mpixel

≡ Note

- A maximum of 1,023 folders or files can be recognized.
- Philips can not be held responsible if your USB storage device is not supported, nor will Philips accept any liability for damage or loss of stored data.
- The USB storage device is not supplied with the TV.

Connect a USB storage device

- 1 Turn on the TV.
- 2 Connect the USB storage device to the USB port on the side of your TV.
- 3 Use **▲/▼/◀/▶** to select **[Browse USB]**.
 - Press **OPTIONS** to display the optional menu, then press **OK** to switch between **[List]** and **[Thumbnails]**.

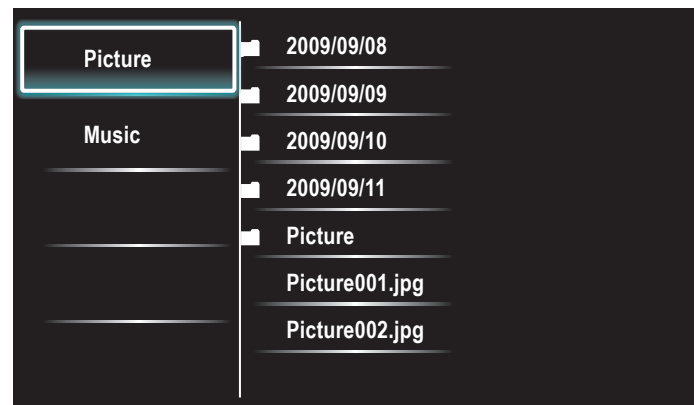

Disconnect a USB storage device

! Caution

- To avoid damaging the USB storage device always exit the on-screen menu and wait 5 seconds before you remove the USB storage device.

- 1 Press **MENU** to exit the on-screen menu.
- 2 Wait 5 seconds then remove the USB storage device.

View your picture on a USB storage device

- 1 In the USB content browser, use ▲/▼ to select **[Picture]**.
- 2 Press ▲/▼ to select a file or a folder on the USB storage device.

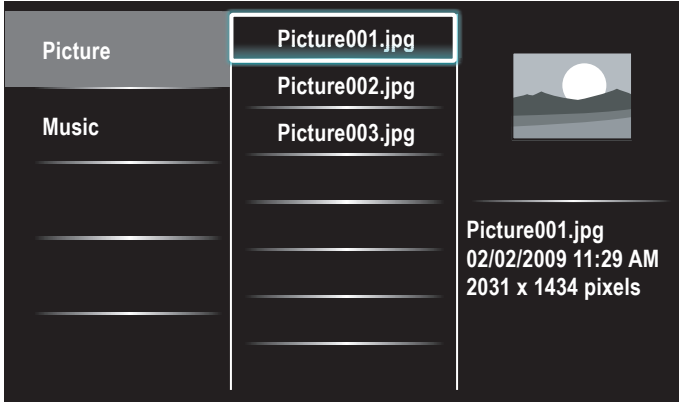

- 3 Press **OK** or **▶||** to start a slideshow of the files.
 - Press **OK** or **▶||** to pause the slide show.
↳ The **||** icon appears.
 - Press **◀◀** or **▶▶** to move between images.
 - Press **BACK** or **■** to stop the slide show.
 - Press **OPTIONS** to display the optional menu, then use ▲/▼ to select the desired item.

Setting items		Description
Slide time *1	Short	Switches to the next image in 5 seconds.
	Medium	Switches to the next image in 10 seconds.
	Long	Switches to the next image in 15 seconds.
Transitions *1	None	No effect when switching images.
	Dissolve	Overlaps a next image on a current image.
	Wipe right	Pushes a current image out from left.
	Wipe left	Pushes a current image out from right.
	Wipe up	Pushes a current image out from bottom.
	Wipe down	Pushes a current image out from top.
	Box in	A next image comes into the center from out.
	Box out	A next image goes to the out from center.
Rotate *2	0	Displays an image at its original direction.
	90	Rotates an image clockwise by 90 degrees.
	180	Rotates an image clockwise 180 degrees.
	270	Rotates an image clockwise 270 degrees.
Zoom *2	1x	Displays an image at its original size.
	2x	Magnifies a current image as twice.
	4x	Magnifies a current image as fourfold.

*1 You can set **[Slide time]** and **[Transitions]** when images are in Slide show.

*2 You can set **[Rotate]** and **[Zoom]** when Slide show is in pause mode.

Listen to music on a USB storage device

- 1 In the USB content browser, use ▲/▼ to select **[Music]**.
- 2 Press ▲/▼ to select a file or a folder on the USB storage device.

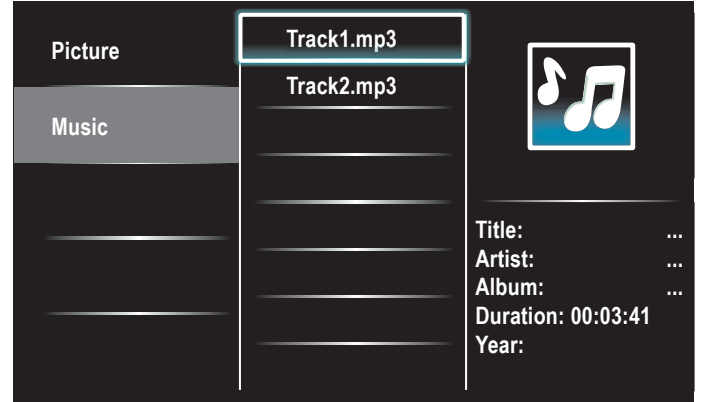

- 3 Press **OK** or **▶||** to play the selected files.
 - Press **OK** or **▶||** to pause, press **OK** or **▶||** again to resume.
 - Press **▶▶** to skip up the next file.
 - Press **◀◀** to skip down the previous file.
 - Press **■** to stop playback.
 - Press **OPTIONS** to display the optional menu, then use ▲/▼ to select the desired item.

Setting items		Description
Repeat	Off	Sets repeat playback to off.
	On	Sets repeat playback for all MP3 files in the current folder.
Shuffle	Off	Sets shuffle playback to off.
	On	Sets shuffle playback for all MP3 files in the current folder.
TV speakers	Off	The sound will not be output from the unit's speakers.
	On	The sound will be output from the unit's speakers.
	Speakers EasyLink	You can control audio output from your connected EasyLink Compliant Devices with VOL +/- by using this unit's remote control.

Note

- **[Master EasyLink]** must be activated in the **[Preferences]** menu to make the **[TV Speakers]** menu available when you select **[On]** or **[Speakers EasyLink]**.

7 Install channels

The first time you set up your TV, you are prompted to select a menu language and to install TV and digital radio channels (if available). This chapter provides instructions on how to reinstall and fine-tune channels.

Selecting your menu language

- 1 Press **MENU** on the remote control and then use **▲/▼/◀/▶** to select **[Setup] > [Installation] > [Language]**.

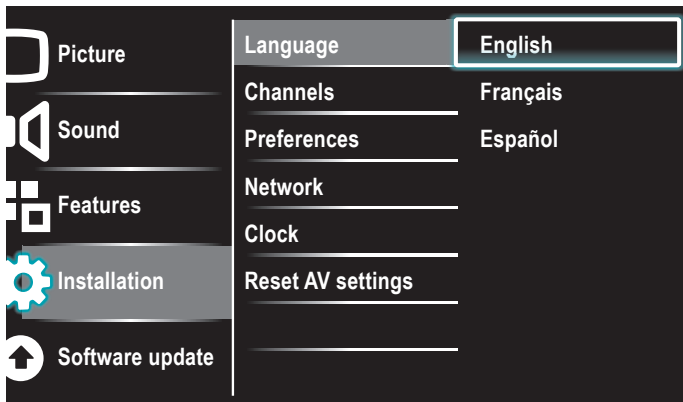

- 2 Select a language and then press **OK** to confirm your choice.
- 3 Press **MENU** to exit.

Autoprogram

If you switch wires (e.g., between antenna and CATV) or if you move the unit to a different area after the initial setting, you will need to perform autoprogram.

- 1 Press **MENU** on the remote control and then use **▲/▼/◀/▶** to select **[Setup] > [Installation] > [Channels] > [Autoprogram] > [Start now]**.

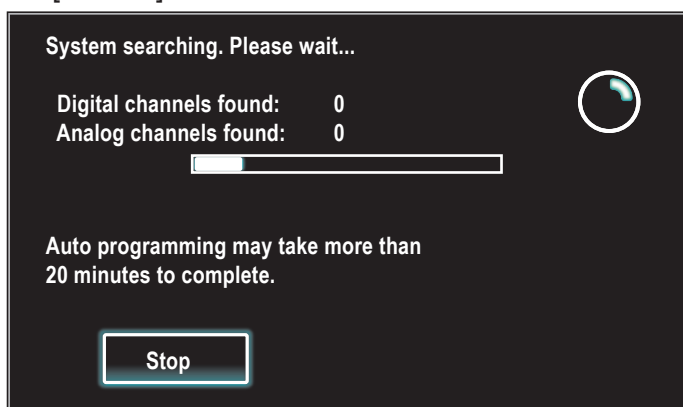

- 2 Press **OK** to start the installation.

If you run **[Autoprogram]** when you have locked channels, a message appears asking to enter your PIN. Enter your PIN in order to complete the installation.

If you have forgotten your PIN, reset it as described in 'Changing your PIN' on page 24.

- When autoprogramming is complete, the lowest memorized channel will be displayed.

- 3 Follow the on-screen instructions to complete the installation.

Weak channel installation

This function lets you add the channels that were not added by the autoprogram due to the receivable condition at the initial setup.

- 1 Press **MENU** on the remote control and then use **▲/▼/◀/▶** to select **[Setup] > [Installation] > [Channels] > [Weak channel installation]**.
- 2 Use **◀/▶** to select channel input box, then use **▲/▼** to select a channel you want to memorize.
- 3 Use **◀/▶** to select **[Search]**, then press **OK**.
- 4 Display will be changed to **[Store]** from **[Search]** when the channel is found, then press **OK**.
- 5 Press **MENU** to exit.

Note

- In most cases, digital channels are not broadcast on the RF channel on which they appear on your TV. To add digital channels you need to know the RF channel on which the digital channel is being broadcast. E.g. If there is a digital channel 9.1 which is being broadcast on RF channel 25, you need to enter 25 while performing a weak channel installation. To find out the RF channel on which a particular digital channel is being broadcast, please contact your local service provider. Installing digital channels using **[Weak channel installation]** might not work for direct cable connections and if the digital signal is too weak for the TV to process.

Installation mode

- 1 Press **MENU** on the remote control and then use **▲/▼/◀/▶** to select **[Setup] > [Installation] > [Channels] > [Installation mode]**.
- 2 Use **▲/▼** to select, then press **OK**.
- 3 Press **MENU** to exit.

Uninstall channels

Those channels can still be selected with the **Number buttons**.

- 1 Press **MENU** on the remote control and then use **▲/▼/◀/▶** to select **[Setup] > [Installation] > [Uninstall channels]**.
- 2 Use **▲/▼** to select the channel you want to remove, then press **OK**.
 - You will not be able to select the channel again using **CH +/-**.
 - To reactivate a removed channel, use **▲/▼** and then press **OK**.
- 3 Press **MENU** to exit.

Return your settings to default values

When you return picture and sound settings to their default values the channel installation settings are not affected.

- 1 Press **MENU** on the remote control and then use **▲/▼/◀/▶** to select **[Setup] > [Installation] > [Reset AV settings] > [Start now]**.
- 2 Press **OK** to reset the picture and sound settings.
- 3 Press **MENU** to exit.

8 Update your TV software

Philips continuously tries to improve its products and we strongly recommend that you update the TV software when updates are available. New software can be downloaded from our website at www.philips.com using the model number of your TV (e.g. 55PFL5705D) to find information.

Checking your current software version

- 1 Press **MENU** on the remote control and then use **▲/▼/◀/▶** to select **[Setup] > [Software update] > [Current software info] > [Select]**.
↳ The version and a description of the current software is displayed.

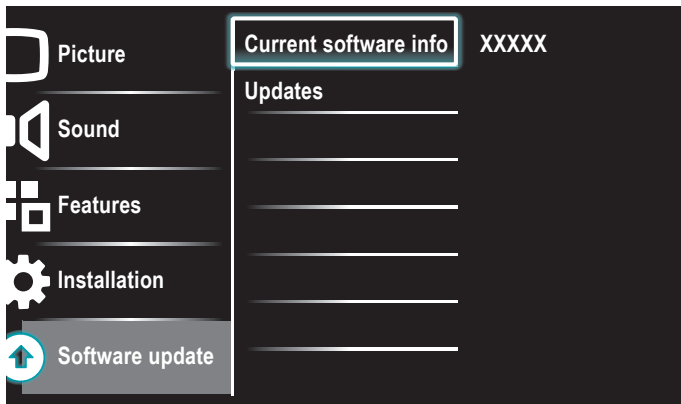

- 2 Press **MENU** to exit.

Preparing for the software update by USB

You require the following equipment:

- A PC with web browsing capability.
- An archive utility that supports the ZIP-format (e.g. WinZip for Windows or Stuffit for Mac OS).
- An empty clean formatted USB stick.

Note

- Only FAT/DOS-formatted portable memory is supported.
- New software can be downloaded from www.philips.com
- Use only software updates that can be found on the Philips web site.

Warning

- When the software update is running, don't press any buttons.
- Do not remove the USB storage device during the software update.
- If an error occurs during the update, retry the procedure or contact your dealer.

Downloading the software

- 1 On your PC, open a web browser and go to www.philips.com
- 2 Find information and software related to your TV and download the latest software update file to your PC.
- 3 Decompress the ZIP-file.
- 4 Copy the update file to the root directory of the USB storage device.

Updating software

USB update

You can update the software by using USB storage device.

- 1 If the TV is on, press **⏻ POWER** at the side of the TV.
- 2 Connect your USB storage device with the update file to the USB port on the side of your TV.

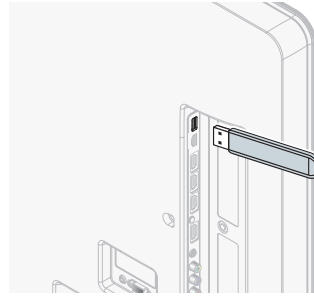

- 3 Switch on the TV.
- 4 Press **MENU** on the remote control and then use **▲/▼/◀/▶** to select **[Setup] > [Software update] > [Updates] > [USB]**.
- 5 Use **▲/▼** to select the desired Update file.
- 6 Use **▲/▼** to select **[Yes]**, then press **OK**.
- 7 Read the on-screen instructions and confirm that you want to continue with the installation.



- 8 When the software update is complete, remove the USB storage device.
- 9 Unplug the AC power cord for a few seconds from AC outlet and plug it again.
- 10 Switch on the TV.
↳ The TV starts up with the new software.

 - The following messages are displayed without starting software update when it doesn't fulfill the update conditions.

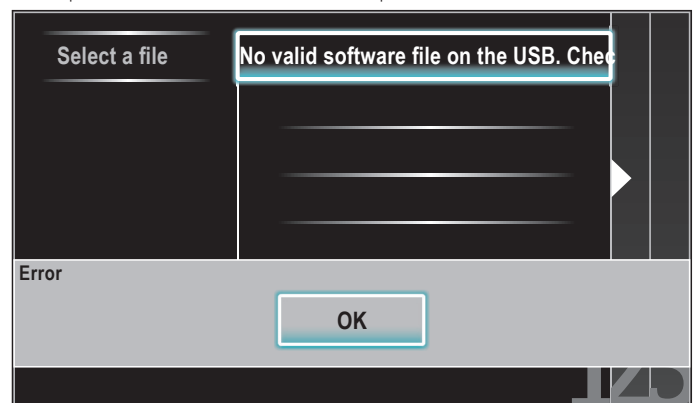

Network update

You can update the software by connecting the unit to the internet.

- 1 Follow steps 1 to 2 in 'Connection test' on page 28.
- 2 Press **MENU** on the remote control and then use **▲/▼/◀/▶** to select **[Setup] > [Software Update] > [Updates] > [Network]**.
- 3 Use **◀/▶** to select **[Yes]**, then press **OK**.
 - This unit will then start checking for the latest firmware version.
- 4 Confirmation message will appear. Use **◀/▶** to select **[Yes]**, then press **OK**.
 - The unit will start downloading the latest firmware version.
 - The unit will start updating the firmware version.
 - It may take a while to complete the updating.
- 5 When the software update is complete, press **POWER**  at the side of the TV to make sure the unit goes to standby mode.
- 6 Switch on the TV.
 - ↳ The TV starts up with the new software.

Note

- In order to update software via the internet, you must connect the unit to the internet and set up necessary settings.
- For the network connection, refer to 'Connecting the TV to the internet using an Ethernet cable' or 'Connecting the TV to the internet using a USB wireless LAN adapter' on page 38.
- For the network setup, refer to 'Network' on page 28.
- Please do not unplug the AC power cord or Ethernet cable while executing the 'Network update'.
- All settings will remain the same even if you update the software version.
- The version of Netflix will also be updated if newer version of Netflix is available when updating the firmware.

9 Connect devices

This section describes how to connect various devices with different connectors and supplements examples provided in the Quick Start Guide.

Connection overview

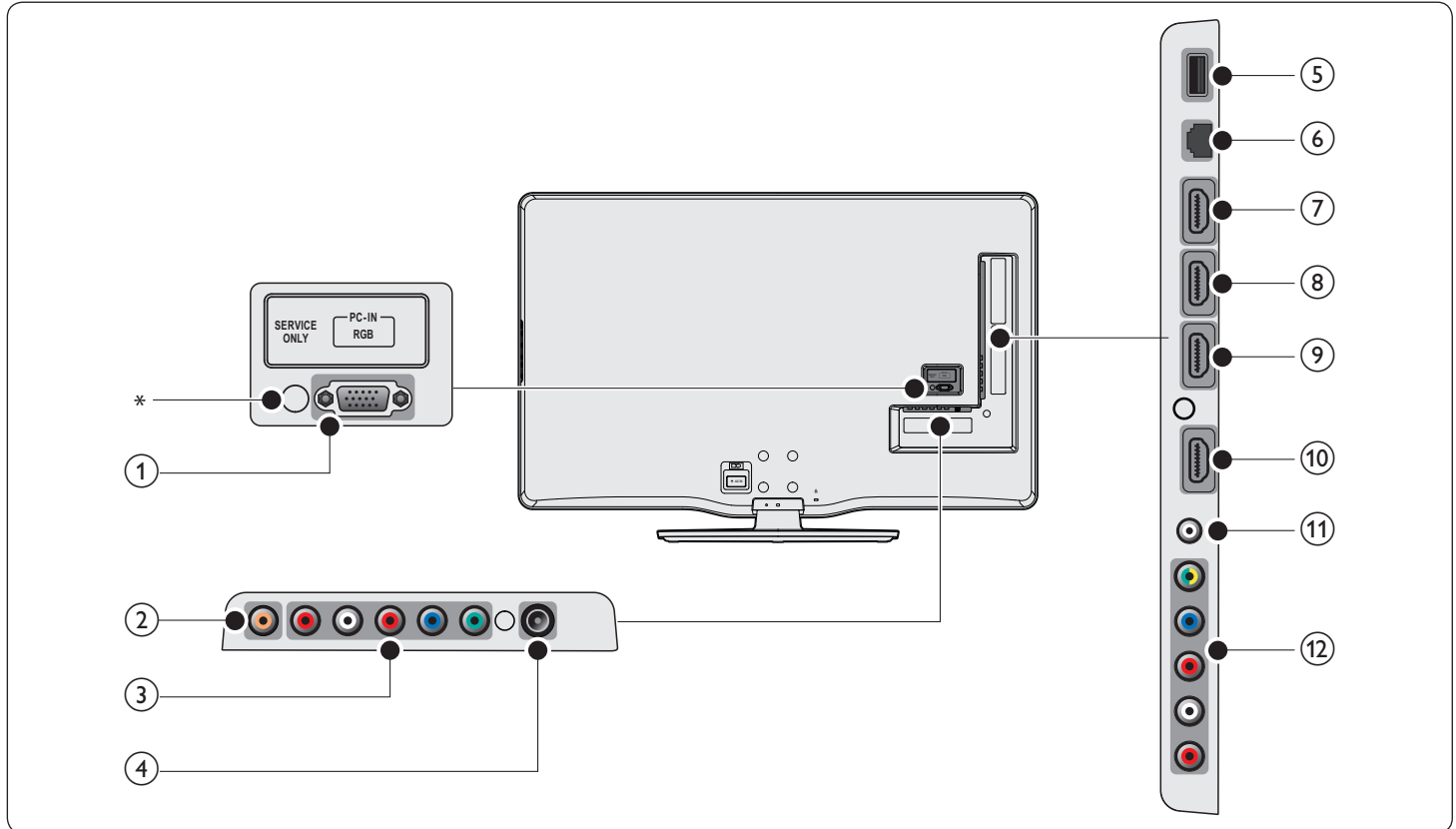

- ① **PC input jack**
VGA cable connection for PC.
- ② **Digital audio output jack**
Digital audio output to home theaters and other digital audio systems.
- ③ **Component 1 video and audio input jack**
Video input from analog devices such as DVD, receiver, game console, etc. This connector is used with audio input.
- ④ **Antenna input jack**
Signal input from an antenna, cable or satellite.
- ⑤ **USB terminal**
Data input from USB storage devices or to connect the supplied USB wireless LAN adapter. Do not connect any other device to this terminal such as; digital camera, keyboard, mouse, etc.
- ⑥ **Ethernet port**
For internet connection using an Ethernet cable with a RJ-45 connector.
- ⑦ **HDMI 4 input jack**
Fourth HDMI in connector.
Digital audio and video input from high definition digital devices such as Blu-ray players.
- ⑧ **HDMI 3 input jack**
Third HDMI in connector.
- ⑨ **HDMI 2 input jack**
Second HDMI in connector.
- ⑩ **HDMI 1 input jack**
First HDMI in connector.
- ⑪ **Audio input jack for HDMI 1 and PC**
- ⑫ **Component 2 video/composite video and audio input jack**
Video input from analog devices such as DVD, receiver, game console, etc. This connector is used with audio input.

***service only**
For use by service personnel only.

! Caution
• Disconnect the AC power cord before connecting devices.

≡ Note
• Do not use an extension cord and USB Hub to connect devices to this unit. Always insert the USB flash memory or the supplied USB wireless LAN adapter in to this unit directly.
• Different types of connectors may be used to connect a device to your TV, depending on availability and your needs.

Selecting your connection quality

HDMI - Highest quality

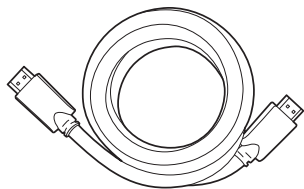

Supports high-definition signals and gives highest picture and sound quality. Video and audio signals are combined in one cable. You must use HDMI for full high-definition video and to enable Philips EasyLink.

Note

- Philips HDMI supports HDCP (High-bandwidth Digital Contents Protection). HDCP is a form of Digital Rights Management that protects high definition content in DVD or Blu-ray Discs.

Component (Y Pb Pr) - High quality

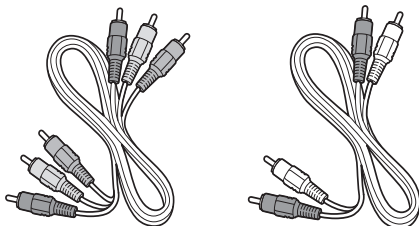

Component video cable (red/green/blue) and audio L/R cable (red/white)

Supports high-definition signals but gives lower picture quality than HDMI. Component cables combine a red/green/blue video cable with a red/white audio L/R cable. Match the cable colors when you connect to the TV.

Composite - Basic quality

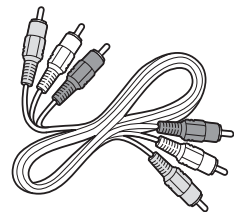

Composite video/audio cable (yellow/red/white)

For analog connections. Composite cables usually combine a yellow video cable with a red/white audio L/R cable. Note that this unit's composite video input jack is shared with a green one which is one of component 2 video input jack, you must use it when you connect your device via composite video cable (yellow jack goes to green jack). Other than composite video cable, match the audio cable colors when you connect to the TV.

Connecting your devices

This section describes how to connect a selection of devices with different connectors. Different types of connectors can be used to connect a device to your TV. The following sections describe examples only, other configurations are possible.

Connecting a set-top box, Blu-ray Disc player and HD game console via HDMI

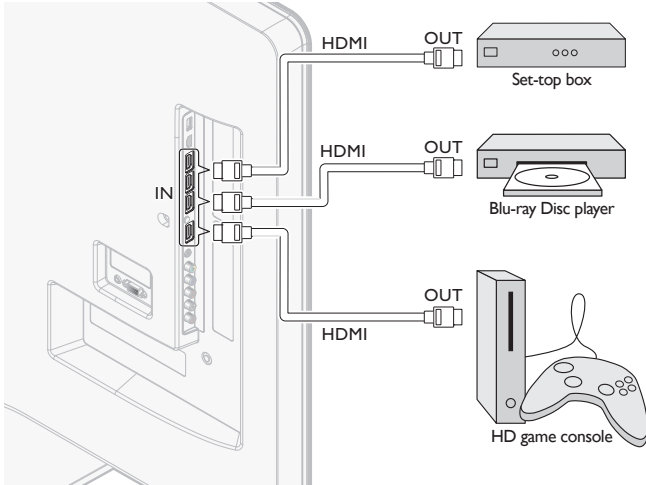

Connecting a set-top box, DVD player/recorder via component video connectors (YPbPr) and analog audio

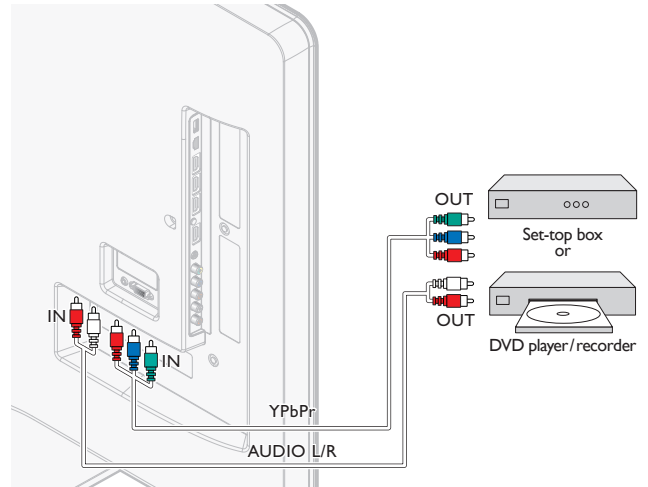

Note

- When you connect cables, match the cable colors to the connectors on the TV.

Connecting a set-top box, DVD recorder via composite connectors and analog audio

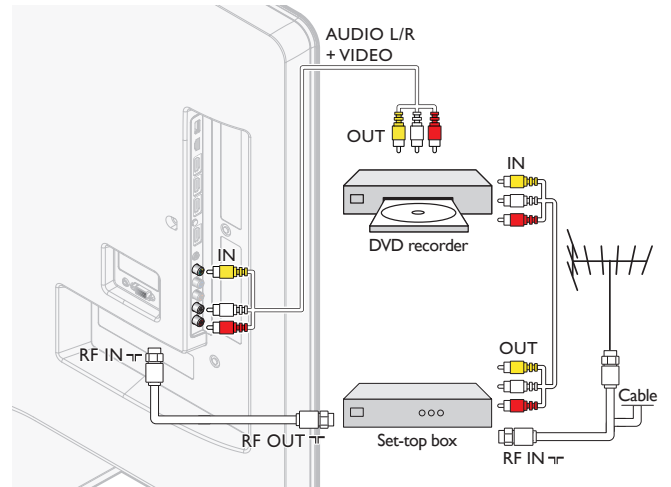

Do not place your recorder too close to the screen because some recorders can be susceptible to signals.

Note

- Only the left loudspeaker reproduces sound for mono equipment. Use a mono to stereo adapter (not supplied) for sound reproduction via all internal loudspeakers.
- When you connect cables, match the cable colors to the connectors on the TV.

Connecting a DVD player/recorder via HDMI-DVI and analog audio

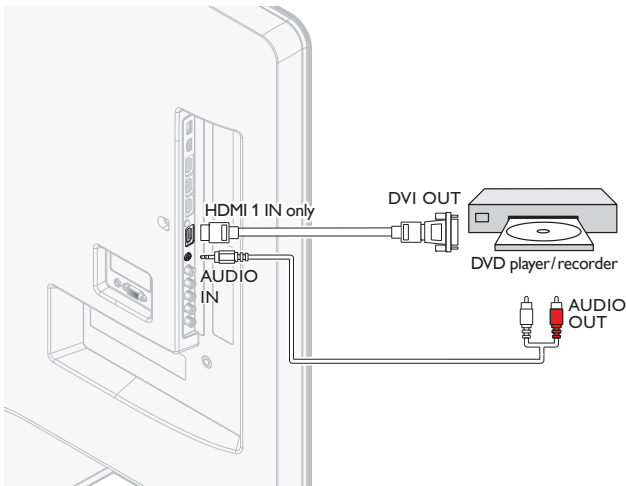

Connecting a set-top box via a composite connector and analog audio

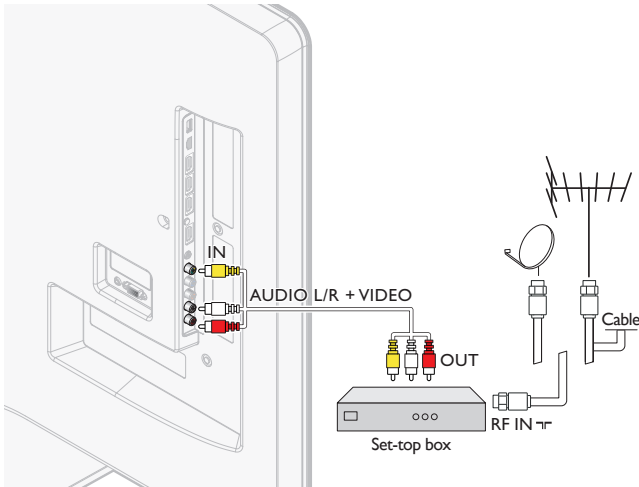

Note

- Only the left loudspeaker reproduces sound for mono equipment. Use a mono to stereo adapter (not supplied) for sound reproduction via all internal loudspeakers.
- When you connect cables, match the cable colors to the connectors on the TV.

Connecting the TV to the internet using an Ethernet cable

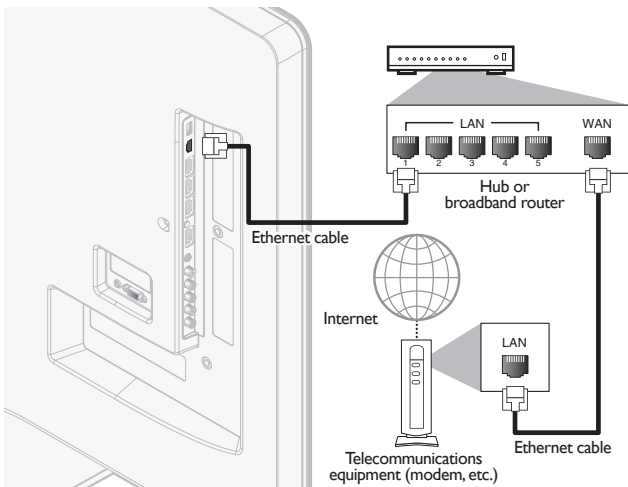

Note

- Please purchase shielded Ethernet cables at your local store and use them when you connect to network equipment.
- After connecting an Ethernet cable, set up necessary network settings. (For the network setup, refer to 'Network' on page 28.)
- Do not insert any cable other than an Ethernet cable to the Ethernet port to avoid damaging the unit.
- If your telecommunications equipment (modem, etc.) does not have broadband router functions, connect a broadband router.
- If your telecommunications equipment (modem, etc.) has broadband router functions but there is no vacant port, use a hub.
- For a broadband router, use a router which supports 10BASE-T/100BASE-TX.
- Do not connect your PC directly to the Ethernet port of this unit.

Connecting the TV to the internet using a USB wireless LAN adapter

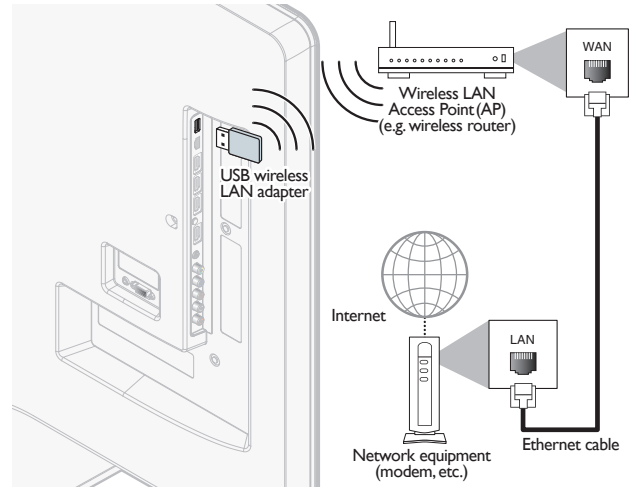

Note

- After connecting a USB wireless LAN adapter, set up necessary network settings. (For the network setup, refer to 'Network' on page 28.)
- This unit is compatible with the supplied USB wireless LAN Adapter only. (Commercially available USB wireless LAN adapters are not supported.)
- Do not insert the supplied USB wireless LAN adapter when the unit is turned on. Please insert the USB wireless LAN adapter when the unit is in the standby mode or turned off.
- Use a Wireless LAN Access Point (AP) (e.g. wireless router) which supports IEEE 802.11 b/g/n. (n is recommended for stable operation of the wireless network.)
- This unit does not support Ad-hoc mode.
- Other radio devices or obstacles may cause interference to the wireless network connection.
- Do not use an extension cord and USB Hub to connect devices to this unit. Always insert the USB flash memory or the supplied USB wireless LAN adapter in to this unit directly.

Connecting a digital home theater amplifier using a digital audio coaxial cable

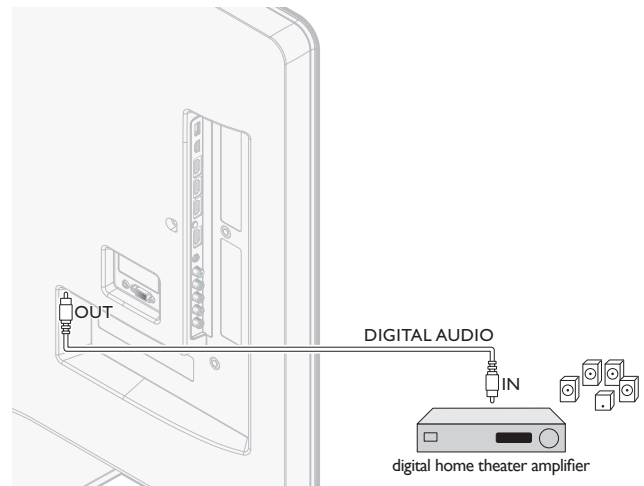

Note

- Due to Copyright restrictions, the broadcaster may choose to mute PCM audio over Digital Audio Output for certain channels, shows or segments during the broadcast.

Connecting a PC

If you connect a PC with a VGA connector at the back.

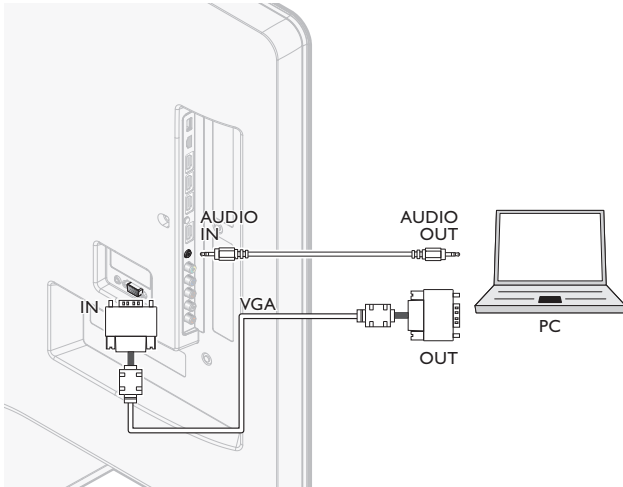

If you connect a PC with a HDMI-DVI connector:

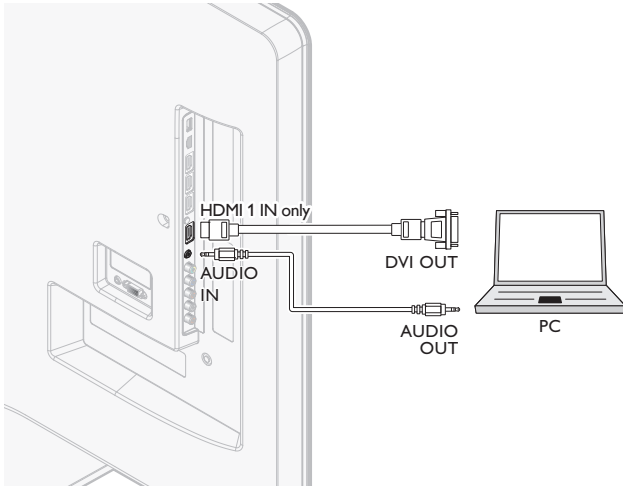

If you connect a PC with an HDMI connector:

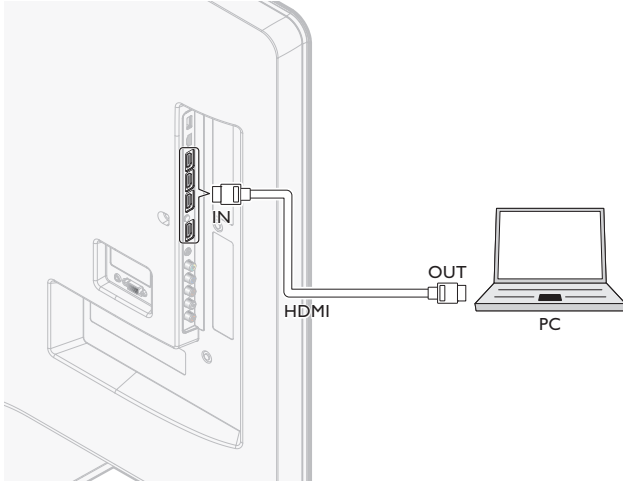

Add devices

After connecting devices, assign the device attached to each connector. This allows you to easily identify devices connected to your TV.

- 1 Press **MENU** on the remote control and then use **▲/▼/◀/▶** to select **[Add new devices]**.
- 2 Use **◀/▶** to select **[Start]**, then press **OK**.
- 3 Use **▲/▼** to select a device and press **OK**.
- 4 Use **▲/▼** to select the connector your device is connected to and press **OK**.
- 5 If there is video and audio output, press **OK**.

Repeat the procedure until all devices are correctly assigned to connectors.

Remove devices

If a device is no longer connected to the TV, remove it from the home menu.

- 1 Press **MENU** on the remote control.
- 2 Use **▲/▼/◀/▶** to select a device to remove.
- 3 Press **OPTIONS**.
- 4 Use **▲/▼** to select **[Remove device]**, then press **OK**.
- 5 Use **◀/▶** to select **[OK]**, then press **OK**.

10 Troubleshooting

Problem	Possible cause and solution
No power or indicator light.	The TV is not connected to the power. Press POWER at the side of the TV or on the remote control. Ensure that the AC power cord is connected tightly to the TV power connector and to the power socket outlet. Remove the AC power cord from the power socket outlet, wait 60 seconds and reconnect the AC power cord. Connect the TV to a different power socket outlet.
No picture or sound is detected from the device using HDMI 1-4 input jack.	HDCP authentication fail. Ensure that your HDMI cable is certified. Press SOURCE on the remote control to switch to another source and then switch back to the HDMI source. Reset the accessory device and the TV. Turn on the TV. Select the HDMI channel. Turn on the accessory device. While the TV and the accessory device are powered on, unplug either end of the HDMI cable and then reinsert the cable.
No sound is detected from the PC using PC input jack.	An audio cable is not connected. Connect an audio cable to the PC/HDMI 1 AUDIO IN on the TV. Press SOURCE on the remote control, and select the PC source.
No picture or sound is detected from the PC using HDMI 1 input jack.	An incorrect HDMI input jack is connected or an audio cable is not connected. Connect a HDMI-DVI cable to the HDMI 1 input jack on the TV. Connect an audio cable to the PC/HDMI 1 AUDIO IN on the TV. Press SOURCE on the remote control, and select the HDMI 1 source.
TV does not respond to the remote control.	Batteries are installed incorrectly, or low battery power. Ensure that you are using the TV remote control. Ensure that the batteries are inserted correctly and do not need to be replaced. Remove the AC power cord from the power socket outlet, wait 60 seconds and reconnect the AC power cord.
The picture is distorted, stretched out, or has black bars on the side or top.	Broadcast video format. Press FORMAT on the remote control to select the best picture format. For some accessory devices, the picture format must be set in the accessory device.
The picture is mostly red and green, or the picture misses red when connected to an accessory device via component cables.	Insecure/incorrect connection. Ensure all the connections are made according to the color code. Push the component cables all the way into the YPbPr sockets on the TV.
No picture or sound.	No picture or sound - ensure you have selected the correct channel. Incomplete channel installation. If the TV receives channels via an AV connection, set the TV to the correct source input. If the TV is connected directly to the wall via a coaxial connection, perform the autoprogram again.
No sound on the TV loudspeaker.	Volume level is set to zero - increase the volume. Sound is muted - press MUTE on the remote control. Audio cable is not connected - for AV connection, ensure that the Audio L/R cable is connected as described in Connecting your devices. (See 'Connecting your devices' on page 37.) If you use a component cable, ensure that you have not crossed the red audio cable with the red video cable. Audio output setting for the accessory device is incorrect. For HDMI connections, some accessory devices have an HDMI audio output setting that must be turned on for HDMI to HDMI connections. Check if [Sound] > [TV Speakers] > [Off] is set to [On] . No sound will be output when [TV Speakers] is set to [Off] .
Bad picture quality with a coaxial connection.	Standard definition channels are not as clear as high definition channels - connect the devices via component or HDMI cables.
Cannot control your TV and connected devices with one remote control.	Confirm that the connected devices are EasyLink compliant and are connected to your TV via an HDMI cable. Not all brands of devices such as Blu-ray Disc players use the same system as Philips EasyLink. Other brands might not work with Philips EasyLink.
Cannot use Netflix feature.	Netflix is available only in the United States. Check if the network connection is properly made. Visit www.netflix.com/Philips on your PC and become a Netflix member.
Cannot add movies or TV episodes to the Instant Queue.	Visit www.netflix.com on your PC.
The picture quality of streaming movie (Netflix) is poor.	Check the speed of your internet connection. You need speeds of at least 8 Mbps to this player for high quality uninterrupted playback.
Streaming movie (Netflix) often stops or starts buffering during playback.	Contact your internet service provider to troubleshoot your internet connection for speed and line quality. Consistent line quality and speed are very important for internet video playback.

Even though the speed of the internet connection improves during playback, the picture quality of Netflix streaming movie does not improve.	The picture quality does not change during playback. The picture quality differs depending on the speed of internet connection at the time of loading.
The audio of internet radio station interrupted.	vTuner server, station or the internet connection is busy. The bit rate of the station is high.
Cannot connect to the network.	Check if the Ethernet cable connection is properly made. Turn on the modem or broadband router. Check the network settings. Check if the broadband router and/or modem is correctly connected.
Cannot connect to the network while my PC is connected to the network.	Check the content of your internet service contract to see if your internet Service Provider prevents multiple terminals connecting at the same time.
Cannot play back internet radio.	Check if the network connection is properly made. Check the firewall setting of the modem or router. For some stations, playback is not available on this unit.
The quality of the internet radio audio is poor or noise occurs during playback of internet station.	The bit rate of the station is low.
Cannot use the wireless connection.	Check if the USB wireless LAN adapter is connected to the USB terminal. Use the supplied USB wireless LAN adapter. Commercially available USB wireless LAN adapters are not supported. Check if the Wireless LAN Access Point (AP) (e.g. wireless router) is oriented properly or not placed too close between them. Once you have activated the wireless connection please wait 30 seconds for the connection to be established after turning on the unit, before trying to access network features such as Netflix or vTuner.
Cannot get into the PC's screen after [Philips Wireless MediaConnect] is selected.	The start up screen (PHILIPS logo with spinning circle) keep displaying until the unit found the PC that is running Philips Wireless MediaConnect. Make sure if the network connection is connected properly. Check if your PC runs Philips Wireless MediaConnect. Make sure your TV and PC are connected on the same network.

Downloading an electronic copy

To obtain an electronic copy of this manual:

- 1 Point your browser to www.philips.com/support
- 2 Choose your country of location.
- 3 Enter the model number or a keyword in the "Find your product" field. Alternatively, you can browse the catalog.
- 4 Click the description or model.
- 5 Under Product support, click "User manuals".

Contact us

If you cannot resolve your problem, refer to the FAQ for this TV at www.philips.com/support

If the problem remains unresolved, contact the Customer Support Center in your country.



Warning

- Do not attempt to repair the TV yourself. This may cause severe injury, irreparable damage to your TV or void your warranty.



Note

- Please have available your TV model and serial number before contacting us. These numbers are available on the back and side of your TV, as well as on the packaging.

11 Specifications

Note

- Specifications are subject to change without prior notice.

Picture enhancement

Type:	1080p 120Hz
Aspect ratio:	16:9
Viewing angles:	178° (V) by 178° (H)
Built-in digital tuner:	ATSC/QAM

Sound enhancement

Mono/Stereo:	Mono, Stereo, SRS
Power output (RMS watts):	20 W
Equalizer:	5 band

Ease of use

Video modes:	Automatic, 4:3, Movie Expand 14:9, Movie Expand 16:9, Super Zoom, Wide Screen, Unscaled
PC input:	via VGA, HDMI
Photo slide show:	Yes (jpeg files only)
MP3 playback:	Yes (mp3 files only)

Connections

Component video input with audio L/R:	2 Supporting video signals: 480i/p, 720p, 1080i 60Hz, 1080p 24/30/60Hz
Composite (shared terminal with Y of components) video input with audio L/R:	1
HDMI:	4 Supporting video signals: 480i/p, 720p, 1080i 60Hz, 1080p 24/30/60Hz PC input: up to 1920x1080 60Hz
3.5mm stereo miniplug shared use for HDMI 1 and PC input:	1
PC input:	1 up to 1920x1080 60Hz
Digital audio output:	1 Supporting Dolby Digital and PCM
USB:	1 Supporting wireless standards: IEEE 802.11 b/g/n (2.4GHz)
Ethernet port:	1

Power

Power requirements:	120V~ AC +/- 10%, 60Hz +/- 0.5%
---------------------	---------------------------------

12 Network service disclaimer

Content and services made available through this product are transmitted by third parties by means of networks and transmission facilities over which Company has no control and third party services may be terminated or interrupted at any time, and Company makes no representation or warranty that any content or service will remain available for any period of time. Without limiting the generality of this disclaimer, Company expressly disclaims any responsibility for any interruption or suspension of any content or service made available through this product. Company is not responsible for customer service related to the content and services. Any question or request for service relating to the content or services should be made directly to the respective content and service providers.

THIRD PARTY CONTENT AND SERVICES MADE AVAILABLE THROUGH THIS PRODUCT ARE PROVIDED "AS IS." COMPANY DOES NOT WARRANT CONTENT OR SERVICES SO PROVIDED, FOR ANY PURPOSE WHATSOEVER. COMPANY EXPRESSLY DISCLAIMS ANY WARRANTIES, EXPRESS OR IMPLIED INCLUDING WITHOUT LIMITATION, WARRANTIES OF MERCHANTABILITY OR FITNESS FOR A PARTICULAR PURPOSE, ACCURACY, VALIDITY, TIMELINESS, LEGALITY, SUITABILITY, OR QUALITY OF ANY CONTENT OR SERVICE MADE AVAILABLE THROUGH THIS PRODUCT.

IN NO EVENT SHALL COMPANY BE LIABLE FOR ANY DAMAGES, WHETHER ARISING IN CONTRACT OR TORT, INCLUDING WITHOUT LIMITATION, ANY DIRECT, INDIRECT, INCIDENTAL, SPECIAL OR CONSEQUENTIAL DAMAGES, LOST PROFITS, ATTORNEY FEES, EXPENSES, OR ANY OTHER DAMAGES ARISING OUT OF, OR IN CONNECTION WITH, ANY CONTENT (OR ANY INFORMATION CONTAINED THEREIN) OR SERVICE PROVIDED TO THE USER OR ANY THIRD PARTY, EVEN IF ADVISED OF THE POSSIBILITY OF SUCH DAMAGES.

All content and services accessible through this product belong to third parties and are protected by copyright, patent, trademark and/or other intellectual property rights. Such content and services are provided solely for the User's personal noncommercial use. User may not use any content or services in a manner that has not been authorized by the content owner or service provider. Without limiting the foregoing, unless expressly authorized by the applicable content owner or service provider, you may not modify, copy, republish, upload, post, transmit, translate, sell, create derivative works, exploit, or distribute in any manner or medium any content or services made available through this product.

13 Warranty

LIMITED WARRANTY ONE (1) YEAR

WARRANTY COVERAGE:

This warranty obligation is limited to the terms as set forth below.

WHO IS COVERED:

This product warranty is issued to the original purchaser or the person receiving the product as a gift against defects in materials and workmanship as based on the date of original purchase ("Warranty Period") from an Authorized Dealer. The original sales receipt showing the product name and the purchase date from an authorized retailer is considered such proof.

WHAT IS COVERED:

This warranty covers new products if a defect in material or workmanship occurs and a valid claim is received within the Warranty Period. At its option, the company will either (1) repair the product at no charge, using new or refurbished replacement parts, or (2) exchange the product with a product that is new or which has been manufactured from new, or serviceable used parts and is at least functionally equivalent or most comparable to the original product in current inventory, or (3) refund the original purchase price of the product. Replacement products or parts provided under this warranty are covered against defects in materials and workmanship from the date of the replacement or repair for ninety (90) days or for the remaining portion of the original product's warranty, whichever provides longer coverage for you. When a product or part is exchanged, any replacement item becomes your property and the replaced item becomes company property. When a refund is given, your product becomes company property. Note: Any product sold and identified as refurbished or renewed carries a ninety (90) day limited warranty.

Replacement product can only be sent if all warranty requirements are met. Failure to follow all requirements can result in delay.

WHAT IS NOT COVERED - EXCLUSIONS AND LIMITATIONS:

This Limited Warranty applies only to new company manufactured products that can be identified by the trademark, trade name, or logo affixed to it. This Limited Warranty does not apply to any hardware product or any software, even if packaged or sold with the product, as manufacturers, suppliers, or publishers may provide a separate warranty for their own products packaged with the bundled product.

The company is not liable for any damage to or loss of any programs, data, or other information stored on any media contained within the product, or other additional product or part not covered by this warranty. Recovery or reinstallation of programs, data or other information is not covered under this Limited Warranty.

This warranty does not apply (a) to damage caused by accident, abuse, misuse, neglect, misapplication, or non-supplied product, (b) to damage caused by service performed by anyone other than company approved Authorized Service Location, (c) to a product

or a part that has been modified without written company permission, or (d) if any serial number has been removed or defaced, or (e) product, accessories or consumables sold "AS IS" without warranty of any kind by including refurbished product sold "AS IS" by some retailers.

This Limited Warranty does not cover:

- Shipping charges to return defective product.
- Labor charges for installation or setup of the product, adjustment of customer controls on the product, and installation or repair of antenna/signal source systems outside of the product.
- Product repair and/or part replacement because of improper installation or maintenance, connections to improper voltage supply, power line surge, lightning damage, retained images or screen markings resulting from viewing fixed stationary content for extended periods, product cosmetic appearance items due to normal wear and tear, unauthorized repair or other cause not within the control of the company.
- Damage or claims for products not being available for use, or for lost data or lost software.
- Damage from mishandled shipments or transit accidents when returning product.
- A product that requires modification or adaptation to enable it to operate in any country other than the country for which it was designed, manufactured, approved and/or authorized, or repair of products damaged by these modifications.
- A product used for commercial or institutional purposes (including but not limited to rental purposes).
- Product lost in shipment and no signature verification receipt can be provided.
- Failure to operate per Owner's Manual.

TO OBTAIN ASSISTANCE...

Contact the Customer Care Center at:
1-866-309-0841

REPAIR OR REPLACEMENT AS PROVIDED UNDER THIS WARRANTY IS THE EXCLUSIVE REMEDY FOR THE CONSUMER, WITH THE ISSUING COMPANY NOT LIABLE FOR ANY INCIDENTAL OR CONSEQUENTIAL DAMAGES FOR BREACH OF ANY EXPRESS OR IMPLIED WARRANTY ON THIS PRODUCT. EXCEPT TO THE EXTENT PROHIBITED BY APPLICABLE LAW, ANY IMPLIED WARRANTY OF MERCHANTABILITY OR FITNESS FOR A PARTICULAR PURPOSE ON THIS PRODUCT IS LIMITED IN DURATION TO THE DURATION OF THIS WARRANTY.

Some states do not allow the exclusions or limitation of incidental or consequential damages, or allow limitations on how long an implied warranty lasts, so the above limitations or exclusions may not apply to you.

This warranty gives you specific legal rights. You may have other rights which vary from state/province to state/province.

P&F USA, Inc. PO Box 430 Daleville, IN 47334-0430

061708

14 Index

A

Antenna, connect	9
Audio	22
Audio setting	22
Auto mode	22
Auto TV on	27
Auto volume leveling	22

C

Cables	
component	36
composite	36
connection quality	36
HDMI	36
manage cables	10
YPbPr	36
Channels	
install	32
lock	25
Child lock	
channel lock	25
PIN	24
ratings lock	24, 25, 26
Clock	23
Closed caption	23, 24
Connections	9, 35, 37
Controls	6
Customer support service	5

D

Device List	27
Device lock	14

E

EasyLink	27
ENERGY STAR®	4, 11
Environmental care	5
Equalizer	22

F

FAV	22, 23
-----	--------

H

Home mode	11, 28
-----------	--------

I

Initial setup	11
---------------	----

L

Location (retail store or home)	11, 28
---------------------------------	--------

M

Master EasyLink	27
Mounting stand onto TV	8

N

Netflix	15
Network	28

P

PC	20
Philips Wireless MediaConnect	15
Picture format	21
Picture settings	20

R

Ratings	24, 25, 26
Remote control	
insert batteries	8
overview	6, 7
Retail store mode	11, 28
RC key forwarding	14, 27

S

Settings assistant	11, 20
Signal quality	36
Sleeptimer	24
Software	
update	33
version	33
Speakers EasyLink	22, 31
Specifications	41
Standby	6, 12

T

Troubleshooting	40
TV	
as PC monitor	21, 22, 39
connections	9, 35, 37
controls	6
menu	14
position	8
remote control	6, 7, 8
screen care	5
software	33
switch channels	12
switch on	11, 12
TV Speakers	22
Twitter	18

U

USB	30, 31
-----	--------

V

Volume	
adjust	13
auto volume leveling	22
mute	13
vTuner	16

W

Warranty	42
Wireless LAN	28, 38

Y

YPbPr	36
-------	----

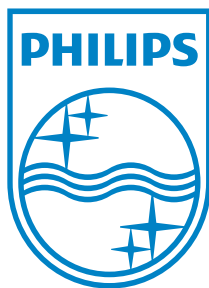

P&F USA, Inc.
PO Box 430 Daleville, IN 47334-0430

P&F Mexicana, S.A. de C.V.
Av. La Palma No. 6, Col. San Fernando La Herradura,
Huixquilucan Edo. de México C.P. 52787

TELEVISOR A COLOR DE CRISTAL LIQUIDO (LCD)

MODELO	LCD	IMAGEN VISIBLE	ENERGIA
55PFL5705D/F7	55"(139,70cm)	138,78cm	120V ~ 60Hz 305W
46PFL5705D/F7	46"(116,84cm)	116,81cm	120V ~ 60Hz 262W
40PFL5705D/F7	40"(101,60cm)	101,60cm	120V ~ 60Hz 205W

Comercializado por : P&F MEXICANA, S.A. DE C.V.

IMPORTADOR : SOJITZ MEXICANA, S.A. DE C.V.
Av. Paseo de las Palmas No. 239-302
Col. Lomas de Chapultepec, C.P. 11000
México, D.F. Tel. 52 (55) 5202 - 7222

EXPORTADOR : FUNAI ELECTRIC CO. LTD.

ENSAMBLADO EN : MEXICO

GARANTIA INCLUIDA EN EL INSTRUCTIVO DE USO



**LEA CUIDADOSAMENTE ESTE INSTRUCTIVO
ANTES DE USAR SU APARATO.**