

# Always here to help you

Register your product and get support at  
[www.philips.com/welcome](http://www.philips.com/welcome)

Question?  
Contact  
Philips



**Sonicare  
FlexCare  
Platinum**

**PHILIPS**

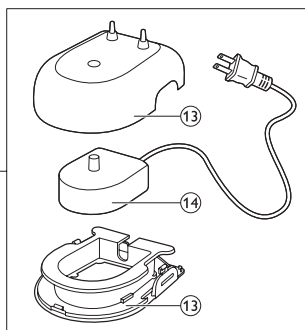
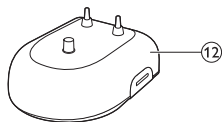
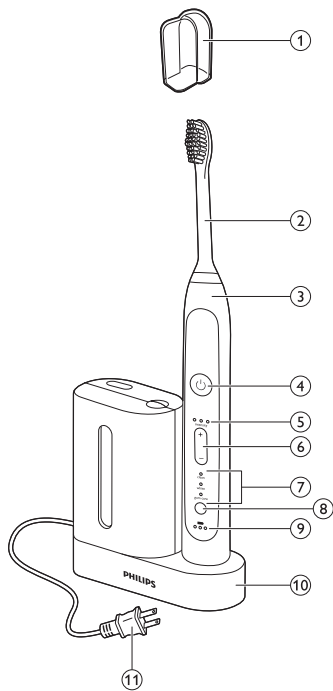

**Sonicare FlexCare Platinum**

---

**ENGLISH 4**

## Introduction

Congratulations on your purchase and welcome to Philips! To fully benefit from the support that Philips offers, register your product at [www.philips.com/welcome](http://www.philips.com/welcome).

# IMPORTANT SAFEGUARDS

## READ ALL INSTRUCTIONS BEFORE USE

When using electrical products, especially when children are present, basic safety precautions should always be followed, including the following:

## **DANGERS**

To reduce the risk of electrocution:

- 1 Do not place or store the charger or sanitizer where it can fall or be pulled into a tub or sink, or where it will sit or drop into water or other liquid.
- 2 Do not reach for a charger or sanitizer that has fallen into water. Unplug immediately.
- 3 Never use a charger with a damaged cord or plug.

## **WARNINGS**

To reduce the risk of burns, electrocution, fire or physical injury:

- 1 Do Not use attachments other than those recommended by the manufacturer.
- 2 Do Not plug the charger into an outlet with a voltage other than specified on the bottom of the charger. This product is designed to operate within a range of 100 to 240 volts. Voltage converters DO NOT warrant voltage compatibility.

- 3 Do not insert objects into the air openings of the sanitizer or block these air openings by placing it on a soft surface or in a position or location where objects will block these openings (examples of objects: magazine, tissue paper, hair, and the like).
- 4 Never force the plug into an outlet; if the plug does not easily fit into the outlet, discontinue use.
- 5 Discontinue use if the product appears damaged in any way (brush head, handle, charger, sanitizer).
- 6 The mains cord cannot be replaced. If the mains cord is damaged, discard the charger and/or sanitizer.
- 7 Keep cord away from heated surfaces.
- 8 Do not use the charger or sanitizer outdoors or operate the sanitizer where aerosol (spray) products are being used or where oxygen is being administered.
- 9 Never use the toothbrush while sleepy or drowsy.
- 10 This product contains no user-serviceable parts. Refer to 'Warranty and Service' if the appliance no longer works properly or needs repair.
- 11 Use this appliance only for its intended use as described in this document or as recommended by your dental professional.
- 12 This appliance is not intended for use by persons (including children) with reduced physical, sensory or mental capabilities, or lack of experience and knowledge, unless they have been given supervision or instruction concerning use of the appliance by a person responsible for their safety.
- 13 Children should be supervised to ensure that they do not play with the appliance.
- 14 Sonicare is a personal care device for household use and is not intended for use on multiple patients in a dental office or institution.

- 15 Discontinue use of the sanitizer if the UV light bulb remains on when the door is open. UV light can be harmful to the human eye and skin. Keep the sanitizer out of the reach of children at all times.
- 16 Do not operate the UV sanitizer without the protective screen in place to avoid contact with hot bulb.
- 17 If the sanitizer is used for 3 consecutive UV clean cycles (i.e., 3 times in a row) a minimum of 30 minutes 'OffTime' is required before you start another UV clean cycle.

---

### **MEDICAL WARNINGS**

- 1 Consult your dental professional before you use this product if you have had oral or gum surgery in the previous 2 months.
- 2 Contact your dental professional if excessive bleeding occurs after using this product or bleeding continues to occur after 1 week of use.
- 3 Discontinue use of this product and contact a physician/dentist if discomfort or pain is experienced.
- 4 This product complies with the safety standards for electromagnetic devices. If you have a pacemaker or other implanted device, contact your physician or the device manufacturer prior to use.
- 5 Consult your physician if you have other medical concerns.

---

### **Electromagnetic fields (EMF)**

This Philips product has been tested and is compliant with safety standards for electromagnetic devices. If handled properly and according to the instructions in this user manual, the product is safe to use.

# SAVE THESE

# INSTRUCTIONS

## Your Sonicare (Fig. 1)

- 1 Hygienic travel cap
- 2 Brush head with unique identifier
- 3 Handle
- 4 Power on/off button
- 5 Intensity level
- 6 Intensity level button (+ and -)
- 7 Brushing modes
- 8 Mode button
- 9 Battery level indicator
- 10 UV sanitizer and base with integrated charger and cord wrap (select models)
  - Not shown: UV light bulb
  - Not shown: Sanitizer drip tray
  - Not shown: Protective screen for UV light bulb
- 11 Power cord with plug
- 12 Deluxe charger (select models)
- 13 Charger cover with brush head holders and base with cord wrap
- 14 Travel charger
  - Not shown: Travel case

**Note:** *The contents of the box may vary based on the model purchased.*

## Getting started

### Attaching the brush head

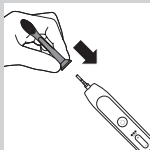

- 1 Align the brush head so the bristles face the front of the handle.
- 2 Firmly press the brush head down on the metal shaft until it stops.

*Note: Sonicare Platinum brush heads come with easily identifiable icons to identify your brush head.*

### Charging your Sonicare

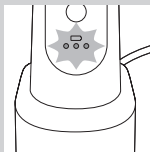

- 1 Put the plug of the charger or sanitizer in a live electrical outlet.
- 2 Place the handle on the charger.
  - ▶ The flashing light of the battery level indicator shows that the toothbrush is charging.

*Note: It takes at least 24 hours to fully charge the battery.*

## Using your Sonicare

### Brushing instructions

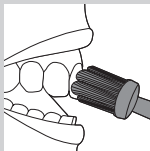

- 1 Wet the bristles and apply a small amount of toothpaste.
- 2 Place the toothbrush bristles against the teeth at a slight angle towards the gumline.
- 3 Press the power on/off button to switch on the Sonicare.



- 4 Apply light pressure to maximize Sonicare's effectiveness and let the Sonicare toothbrush do the brushing for you. Do not scrub.
- 5 Gently move the brush head slowly across the teeth in a small back and forth motion so the longer bristles reach between your teeth. Continue this motion throughout your brushing cycle.

*Note: To make sure you brush evenly throughout the mouth, divide your mouth into 4 sections using the Quadpacer feature (see chapter 'Features').*



- 6 Begin brushing in section 1 (outside top teeth) and brush for 30 seconds before moving to section 2 (inside top teeth). Continue brushing in section 3 (outside bottom teeth) and brush for 30 seconds before moving to section 4 (inside bottom teeth).

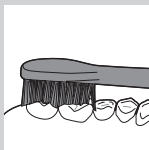

*Note: After you have completed the brushing cycle, you can spend additional time brushing the chewing surfaces of your teeth and areas where staining occurs. You may also brush your tongue, with the toothbrush turned on or off, as you prefer.*

Your Sonicare is safe to use on:

- Braces (brush heads may wear out more quickly when used on braces)
- Dental restorations (fillings, crowns, veneers, implants)

### Brushing modes

- 1 **Clean:** The ultimate in plaque removal (default mode).
- 2 **White:** 2 minutes to remove surface stains and 30 seconds to brighten and polish your front teeth.

- 3 **Gum care:** Combines Clean mode with an additional minute to gently stimulate and massage gums to improve gum health. Your Sonicare comes with the Clean mode activated.

*Note: When the toothbrush is switched on, you cannot toggle between modes.*

- 1** Prior to turning on the Sonicare, press the mode button to toggle between modes.
- ▶ The selected brushing mode illuminates.
- ▶ Once a brushing mode has been selected, it remains active until another brushing mode is selected.

*Note: When the Sonicare is used in clinical studies, the default 2-minute Clean mode must be selected. The handle has to be fully charged and the Easy-start feature must be deactivated.*

---

### Intensity levels per mode

- **Low:** 1 LED indicator light
- **Medium:** 2 LED indicator lights
- **High:** 3 LED indicator lights

*Note: to adjust the Intensity setting to the next higher or lower level, you can press the + button to increase intensity or the - button to decrease intensity at any time during the brushing cycle.*

---

### Pressure Sensor

A change in vibration (and a slight change in sound) alerts you when you apply too much pressure while brushing. See chapter 'Features'.

## Battery status (when handle is not on charger)

---

- 1 yellow LED indicates a low charge.
- 3 green LEDs indicate a full charge.

*Note: If you hear a long beep and the yellow LED of the battery level indicator flashes, your Sonicare will turn off until placed on the charger, where it will start to recharge.*

*Note: To keep the battery fully charged at all times, you may keep your Sonicare on the charger when not in use.*

## Features

### Pressure Sensor

---

This Sonicare model comes with the Pressure Sensor feature activated. The Pressure Sensor works in all 3 modes and at all 3 intensity levels. To deactivate or reactivate the Pressure Sensor feature:

- 1** Place the handle with a brush head attached on the plugged-in charger or sanitizer.
- 2** Press and hold the power button and the mode button for 2 seconds.
  - ▶ You hear 1 beep to indicate the Pressure Sensor has been deactivated.
  - ▶ You hear 2 beeps to indicate the Pressure Sensor has been activated.



## Quadpacer

- The Quadpacer is an interval timer that has a short beep and pause to remind you to brush the 4 sections of your mouth. Depending on the brushing mode you have selected, the Quadpacer beeps at different intervals during the brushing cycle. The Quadpacer works in all 3 modes and at all 3 intensity levels.

The Quadpacer feature on this model has been activated. To deactivate or reactivate the Quadpacer feature:

- 1** Place the handle with a brush head attached on the plugged-in charger or sanitizer.
- 2** Press and hold the mode button for 2 seconds.
  - ▶ You hear 1 beep to indicate the Quadpacer has been deactivated.
  - ▶ You hear 2 beeps to indicate the Quadpacer has been activated.

## Smartimer

The Smartimer indicates that your brushing cycle is complete when it automatically turns off the toothbrush at the end of the brushing cycle.

Dental professionals recommend brushing at least 2 minutes twice a day.

## Easy-start

The Easy-start feature gently increases power over the first 14 brushings to ease into the Sonicare experience. The Easy-start feature only works in the Clean mode and at the High intensity level.

This Sonicare model comes with the Easy-start feature deactivated. To activate or deactivate the Easy-start feature:

- 1** Attach your brush head to the handle.
- 2** Place the handle on the plugged-in charger or sanitizer.
- 3** Activate or deactivate Easy-start:
  - ▶ To activate Easy-start: Press and hold the power on/off button for 2 seconds. You hear 2 beeps to indicate that the Easy-start feature has been activated.
  - ▶ To deactivate Easy-start: Press and hold the power on/off button for 2 seconds. You hear 1 beep to indicate that the Easy-start feature has been deactivated.

*Note: Each of the first 14 brushings must be at least 1 minute in length to properly move through the Easy-start ramp-up cycle.*

*Note: Using the Easy-start feature beyond the initial ramp-up period is not recommended and reduces Sonicare's effectiveness in removing plaque.*

### **Cord wrap on charger (select models)**

If your model includes the charger cover and base, the travel charger is pre-installed inside the cover.

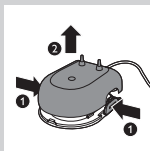

- 1** To separate the charger cover from the charger base, press the two gray snap bars on the charger base and pull the white charger cover upwards.

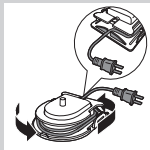

- 2** Wrap excess power cord around the gray charger base as shown in the picture. Be sure to wrap the cord on the inside of the two snap levers. Guide the power cord through the small groove in the rear of the charger base.

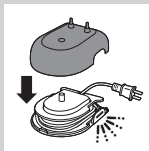

- 3** To reattach the charger cover, press it down over the charger base until it snaps into place.

*Tip: For extra convenience during travel, you can remove the travel charger and use it without the charger cover and charger base.*

### Sanitizing (select models)

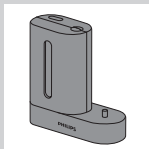

- With the UV sanitizer you can clean your brush head after every use.

#### **Unplug the sanitizer, discontinue use and call Consumer Care if:**

- The UV light bulb remains on when the door is open.
- The window is broken or missing from the sanitizer.
- The sanitizer gives off smoke or a burning smell while it is operating.

*Note: UV light can be harmful to the human eye and skin. This device should be kept out of reach of children at all times.*

- 1** After brushing, rinse the brush head and shake off excess water.

Do not place the travel cap on the brush head during sanitization.

- 2** Place your finger in the door recess on top of the sanitizer and pull open the door.

- 3** Place the brush head on one of the 2 pegs in the sanitizer with the bristles facing the light bulb.

*Note: Only clean Sonicare snap-on brush heads in the sanitizer.*

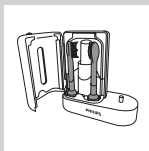

*Note: Do not clean Sonicare for Kids brush heads in the sanitizer.*

- 4** Make sure the sanitizer is plugged into a live outlet of appropriate voltage.
- 5** Close the door and press the green power on/off button once to select the UV clean cycle.

*Note: You can only turn on the sanitizer if the door is properly closed.*

*Note: The sanitizer stops if you open the door during the sanitizing cycle.*

*Note: The sanitizer cycle runs for 10 minutes and then automatically shuts off.*

- ▶ The sanitizer is in operation when the light glows through the window.

## Cleaning

Do not clean the brush head, handle, travel charger, charger cover and the UV sanitizer in the dishwasher.

### Toothbrush handle

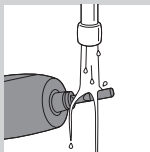

- 1** Remove the brush head and rinse the metal shaft area with warm water.

Do not push on the rubber seal on the metal shaft with sharp objects, as this may cause damage.

- 2** Use a damp cloth to wipe the entire surface of the handle.

## Brush head

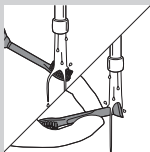

- 1** Rinse the brush head and bristles after each use.
- 2** Remove the brush head from the handle and rinse the brush head connection at least once a week with warm water.

## Deluxe charger (select models)

- 1** Unplug the charger and remove the charger cover.
- 2** Use a damp cloth to wipe the surface of the charger and charger cover.

## UV sanitizer (select models)

Do not immerse the sanitizer in water or rinse it under the faucet.

Do not clean the sanitizer when the UV light bulb is hot.

For optimal effectiveness, it is recommended to clean your sanitizer weekly.

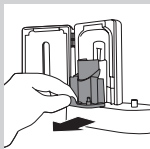

- 1** Unplug the sanitizer.
- 2** Pull the drip tray straight out. Rinse the drip tray and wipe it clean with a damp cloth.
- 3** Clean all interior surfaces with a damp cloth.

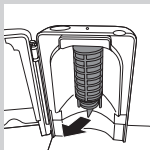

- 4** Remove the protective screen in front of the UV light bulb.

To remove the screen, grasp the edges next to the snaps, gently squeeze and pull out the protective screen.

- 5** Remove the UV light bulb.

To remove the light bulb, grasp it and pull it out of the metal clasp.



**6** Clean the protective screen and the UV light bulb with a damp cloth.

**7** Reinsert the UV light bulb.

To reinsert the light bulb, align the bottom of the light bulb with the metal clasp and push the bulb into the clasp.

**8** Reinsert the protective screen.

To reinsert the screen, align the pegs on the screen with the slots on the reflective surface near the UV light bulb. Push the screen straight into the slots on the sanitizer.

## Storage

- If you are not going to use the product for an extended period of time, unplug it from the electrical outlet, clean it and store it in a cool and dry place away from direct sunlight. You can use the cord wrap to store the power cord in an organized manner.

## Replacement

Internet information: [www.sonicare.com](http://www.sonicare.com) (North America) or [www.philips.com](http://www.philips.com) (outside North America).

## Brush head

Replace Sonicare brush heads every 3 months to achieve optimal results.

Only use genuine Philips Sonicare replacement brush heads.

## UV light bulb

Replacement UV bulbs are available through your Sonicare Consumer Care Center in North America by calling 1-800-682-7664. Outside North America, contact your local Philips Consumer Care Center.

## Environment



- The rechargeable battery inside your Sonicare cannot be replaced, but is easy to remove for recycling. At the end of product life and prior to disposal, please remove the rechargeable battery from the handle by following the instructions below. If you have trouble removing the battery, you can also take the appliance to a Philips service center. The staff of this center will remove the battery for you and will dispose of it in an environmentally safe way.



- Do not throw away the appliance or the UV light bulb (bulb contains mercury) with the normal household waste at the end of its life, but hand it in at an official collection point for recycling. By doing this, you help to preserve the environment.
- If you have any recycling questions, contact your local waste management office.

## Removing the rechargeable battery

### Please note that this process is not reversible.

To remove the rechargeable battery, you need a flat-head (standard) screwdriver. Observe basic safety precautions when you follow the procedure outlined below. Be sure to protect your eyes, hands, fingers, and the surface on which you work.

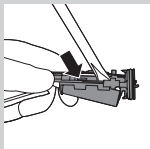
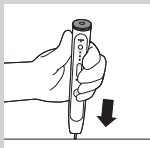
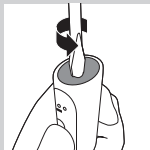

- 1** To deplete the rechargeable battery of any charge, remove the handle from the charger, turn on the Sonicare and let it run until it stops. Repeat this step until you can no longer switch on the Sonicare.
- 2** Insert a flathead (standard) screwdriver into the slot located at the bottom of the handle. Turn the screwdriver counterclockwise to release the bottom cap.
- 3** Place the handle on a solid surface with the buttons facing up and lightly tap the housing one inch from the bottom edge with a hammer.
- 4** Hold the handle upside down and push down on the shaft to release the internal components of the handle.
- 5** Insert the screwdriver under the circuit board, next to the battery connections, and twist to break the connections. Remove the circuit board and pry the battery from the plastic carrier.

The rechargeable battery can now be recycled and the rest of the product discarded appropriately.

## Warranty and service

- Philips warrants its products for two years after the date of purchase. Defects due to faulty materials and workmanship will be repaired or replaced at Philips expense provided that convincing proof of purchase in the qualifying period is provided. Use of unauthorized replacement parts will void this warranty.



[www.philips.com/support](http://www.philips.com/support)

- Contact our Consumer Care Center at 1-800-682-7664 (North America), outside North America contact your local Philips Consumer Care Center. Internet information: [www.sonicare.com](http://www.sonicare.com) (North America) or [www.philips.com](http://www.philips.com) (outside North America).

---

## WARRANTY EXCLUSIONS

What is not covered under warranty:

- Brush heads
- Damage caused by use of unauthorized replacement parts.
- Damage caused by misuse, abuse, neglect, alterations or unauthorized repair.
- Normal wear and tear, including chips, scratches, abrasions, discoloration or fading.
- UV light bulb

---

## IMPLIED WARRANTIES

ANY IMPLIED WARRANTIES, INCLUDING IMPLIED WARRANTIES OF MERCHANTABILITY AND FITNESS FOR A PARTICULAR PURPOSE, SHALL BE LIMITED TO THE DURATION OF THE EXPRESS WARRANTIES SET FORTH ABOVE. IN SOME STATES LIMITATIONS ON DURATION OF IMPLIED WARRANTIES DO NOT APPLY.

**LIMITATION OF REMEDIES**

---

IN NO EVENT SHALL PHILIPS OR ANY OF ITS AFFILIATED OR SUBSIDIARY COMPANIES BE LIABLE FOR ANY SPECIAL, INCIDENTAL OR CONSEQUENTIAL DAMAGES BASED UPON BREACH OF WARRANTY, BREACH OF CONTRACT, NEGLIGENCE, TORT, OR ANY OTHER LEGAL THEORY. SUCH DAMAGES INCLUDE, WITHOUT LIMITATION, LOSS OF SAVINGS OR REVENUE; LOSS OF PROFIT; LOSS OF USE; THE CLAIMS OF THIRD PARTIES INCLUDING, WITHOUT LIMITATION, DENTISTS AND DENTAL HYGIENISTS; AND COST OF ANY SUBSTITUTE EQUIPMENT OR SERVICES. SOME STATES DO NOT ALLOW THE EXCLUSION OR LIMITATION OF INCIDENTAL OR CONSEQUENTIAL DAMAGES.







©2013 Koninklijke Philips Electronics NV (KPENV).  
All rights reserved. PHILIPS and the Philips shield are  
registered trademarks of KPENV.

InterCare, Easy-start, Quadpacer, Sonicare and the Sonicare logo  
are trademarks of Philips Oral Healthcare, Inc. and/or KPENV.

Protected by U.S. and international patents.  
Other patents pending. Reg. U.S. Pat. & Tm. Off.



100% recycled paper  
100% papier recyclé

4235.020.6211.1