

Always there to help you

Register your product and get support at
www.philips.com/welcome

HTB5510D
HTB5540D
HTB5570D



Quick start guide

PHILIPS



- EN** Before using your product, read all accompanying safety information
- MS** Sebelum menggunakan produk anda, baca semua maklumat keselamatan yang disertakan
- TH** ก่อนใช้งานผลิตภัณฑ์ของคุณ โปรดอ่านข้อมูลด้านความปลอดภัยด้วยที่มีให้โดยละเอียด
- ZH-CN** 使用产品前，请阅读所有随附的安全信息
- ZH-TW** 使用您的產品前，請先閱讀所有附隨的安全資訊



HTB5510D

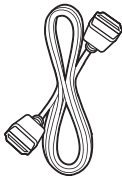
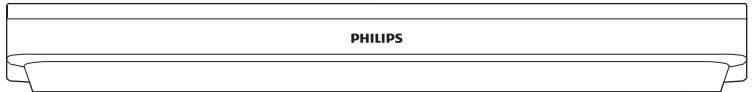
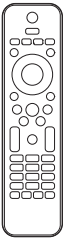

HDMI

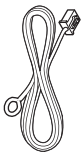
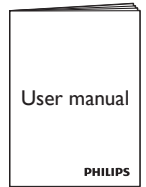
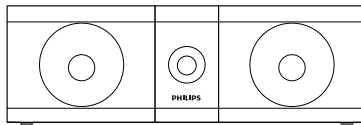

FM Antenna

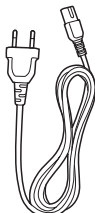

Power Cord

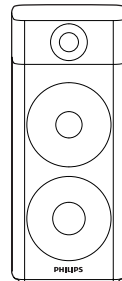
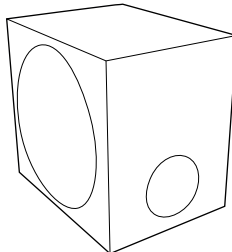

2x

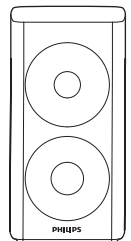

2x

HTB5540D

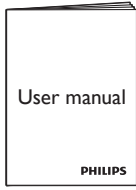

User manual

PHILIPS

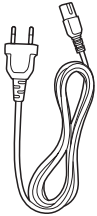
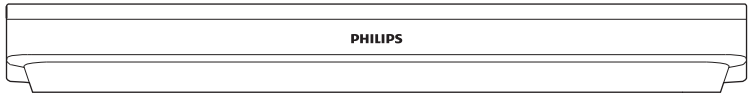

Power Cord

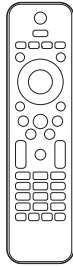

HDMI

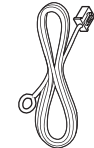
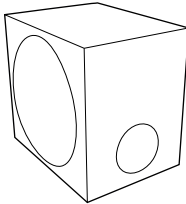
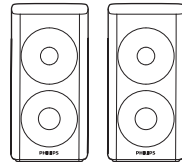
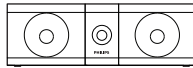

FM Antenna

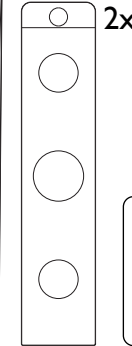

8x



2x

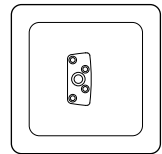

2x

HTB5570D

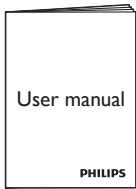

User manual

PHILIPS



HDMI



FM Antenna

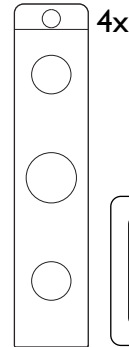

16x



4x

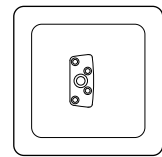

4x

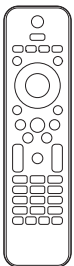

Power Cord

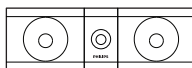
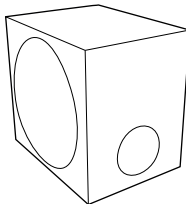

1

- EN** Stand mount the speakers
Applied to HTB5540D and HTB5570D only
- MS** Dirikan dirian pembesar suara
Hanya digunakan pada HTB5540D dan HTB5570D sahaja
- TH** วางลำโพงบนขาตั้ง
เคवल HTB5540D और HTB5570D पर लागू

ZH-CN 桌架和扬声器
仅适用于 HTB5540D 和 HTB5570D

ZH-TW 將喇叭安裝到立架上
僅適用於 HTB5540D 和 HTB5570D

1

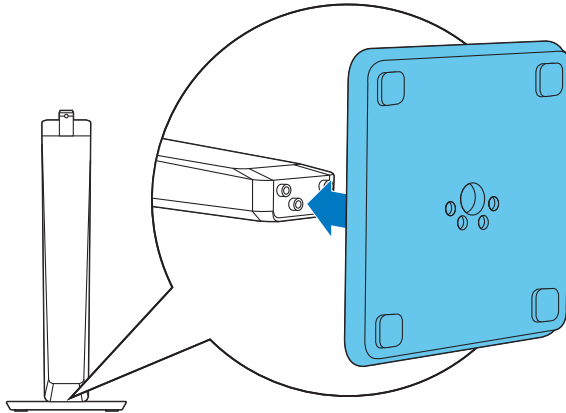

2

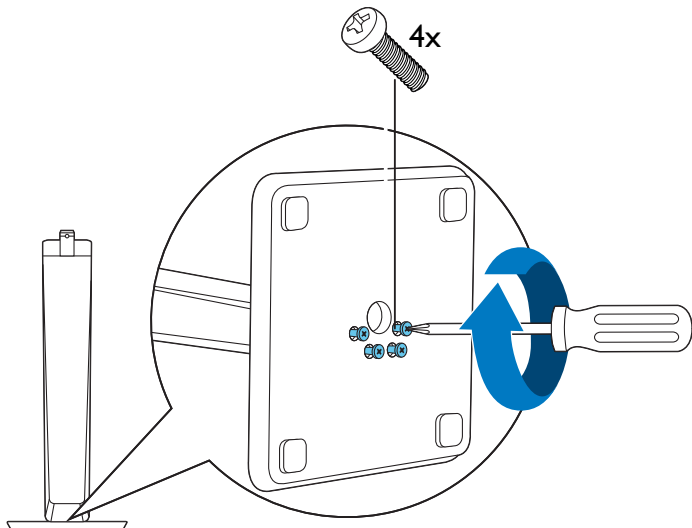

3

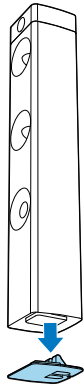

4

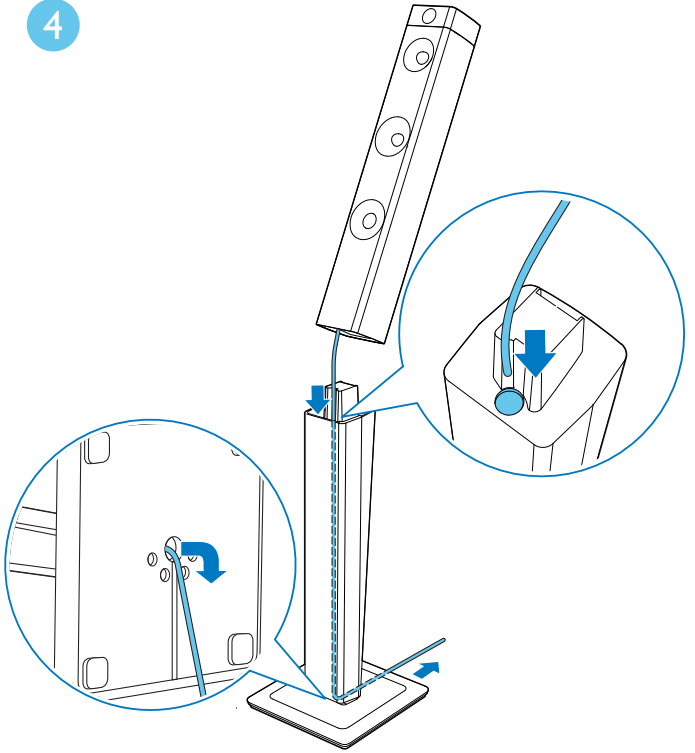

5

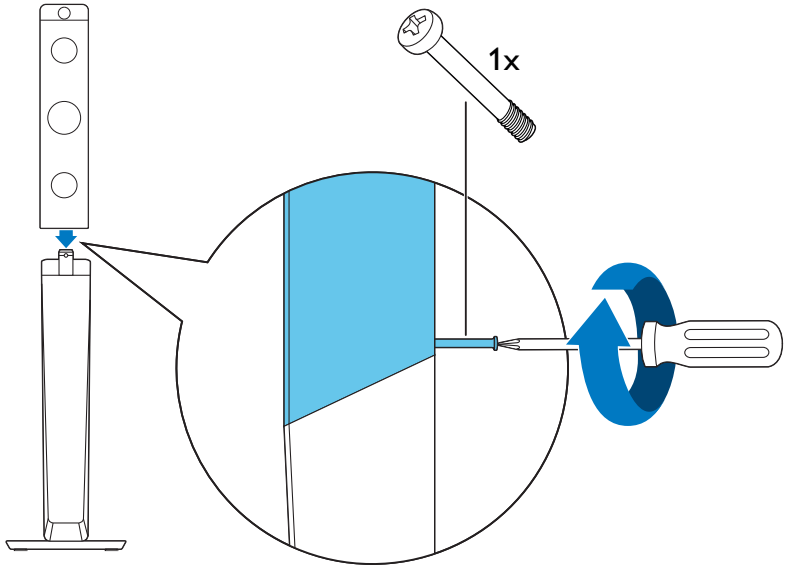

2

- EN** Connect and position the home theater
- MS** Sambungkan dan posisikan sistem teater rumah
- TH** เชื่อมต่อและวางตำแหน่งโอมเซียร์
- ZH-CN** 连接和放置家庭影院
- ZH-TW** 連線並將家庭劇院定位擺好

HTB5510D

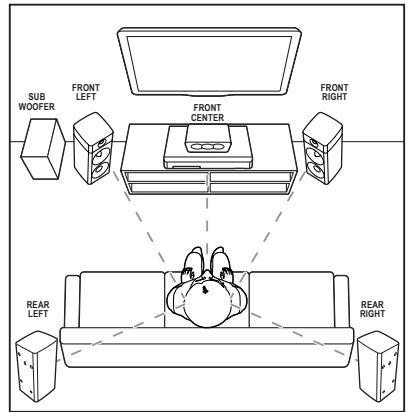
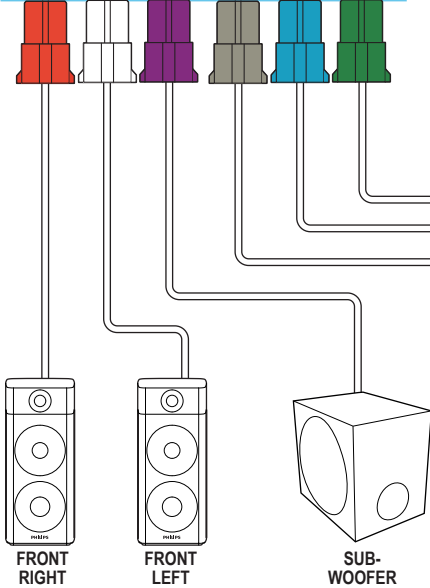
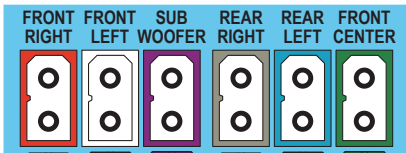
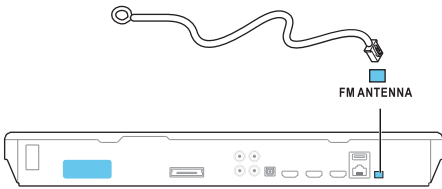

HTB5540D



FM ANTENNA

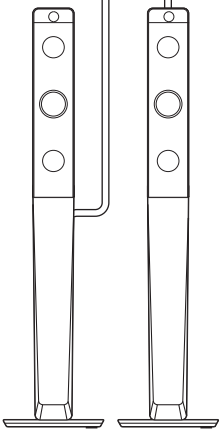
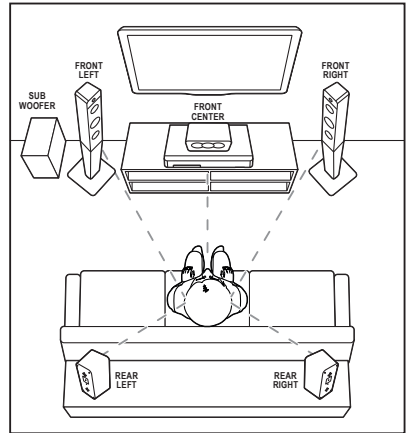
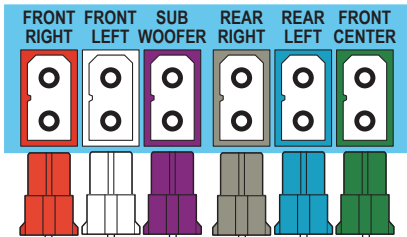

FRONT RIGHT
FRONT LEFT

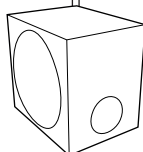

SUB-WOOFER

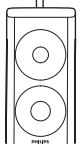

REAR RIGHT

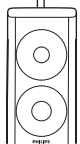

REAR LEFT

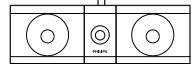

FRONT CENTER

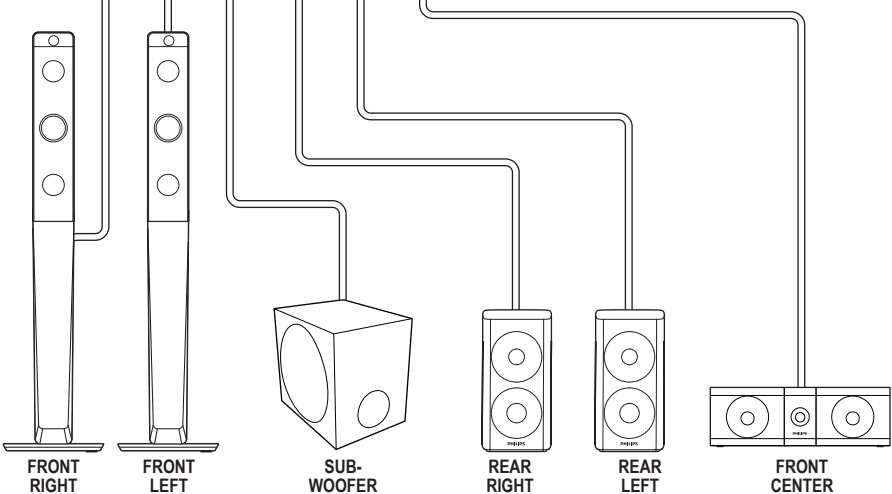

HTB5570D

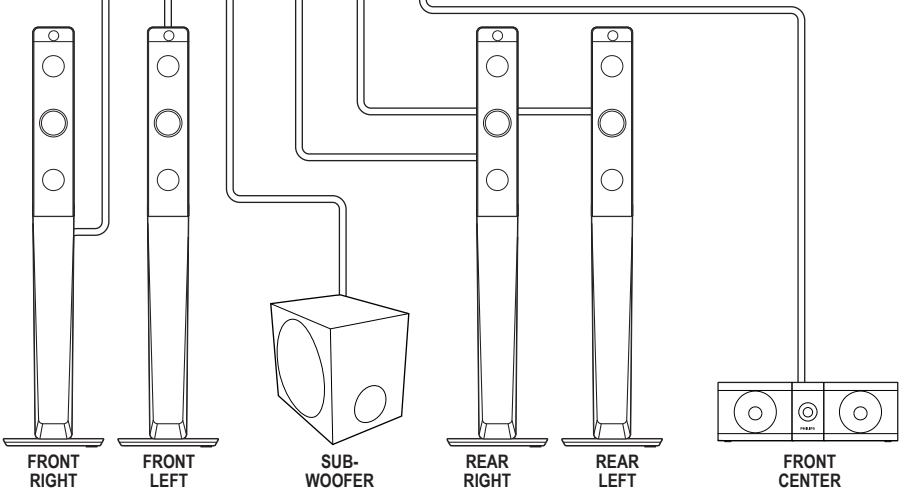
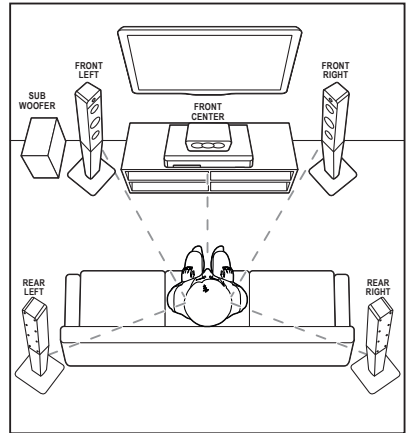
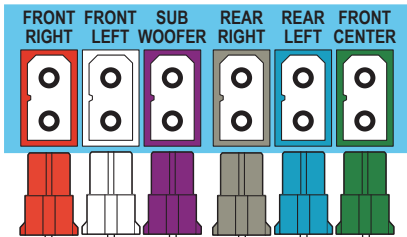

3

- EN** Connect to TV in one of these ways
- MS** Sambung kepada TV dalam salah satu cara berikut
- TH** เชื่อมต่อทีวีด้วยวิธีใดวิธีหนึ่งดังนี้
- ZH-CN** 通过这些方式连接至电视
- ZH-TW** 用這些方式之一連線到電視

HDMI ARC



HDMI + OPTICAL

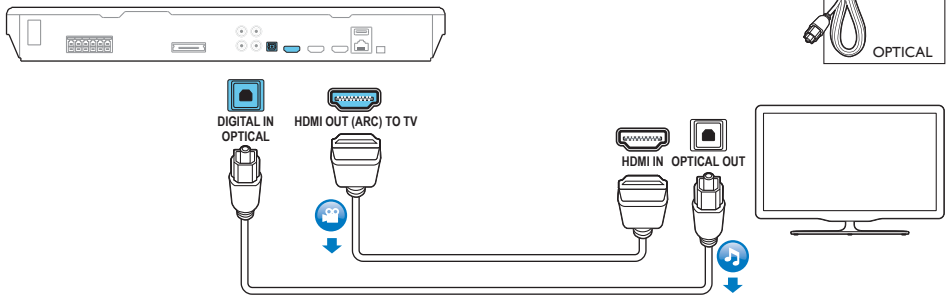

HDMI + COAXIAL

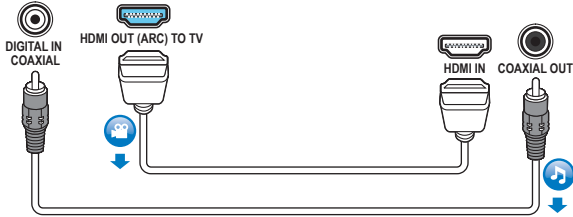

HDMI + AUDIO L/R

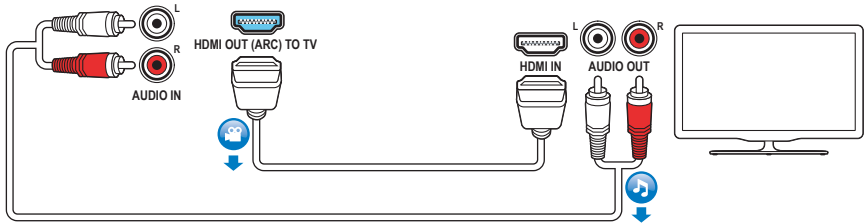

4

- EN** Connect with other HDMI devices
- MS** Sambungkan dengan peranti HDMI yang lain
- TH** การเชื่อมต่ออุปกรณ์ดีวีดีจอผ่าน HDMI
- ZH-CN** 连接其它 HDMI 设备
- ZH-TW** 連接其他 HDMI 裝置

HDMI IN

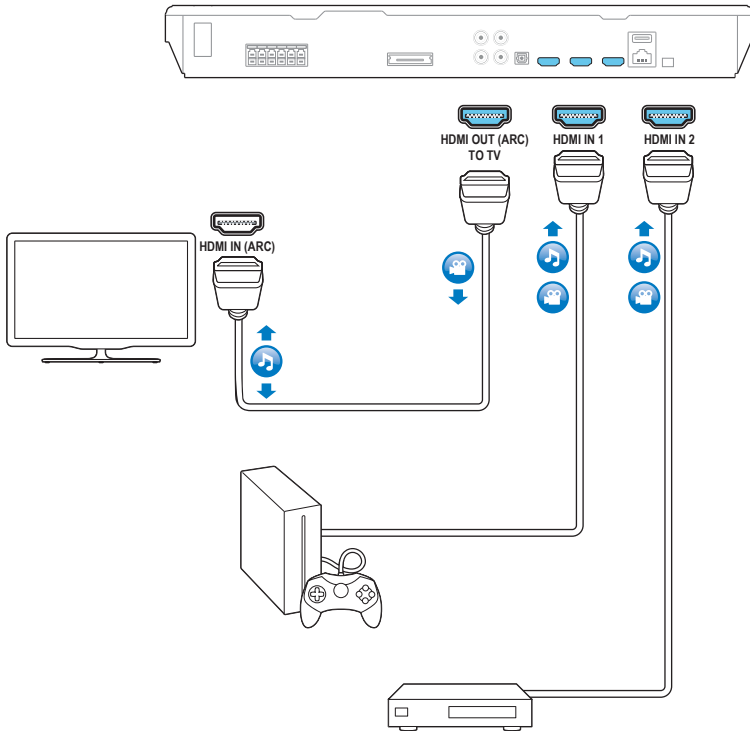

5

EN Switch on the home theater

MS Hidupkan teater rumah

TH เปิดโฮมเธียเตอร์

ZH-CN 打开家庭影院

ZH-TW 開啟家庭劇院

1

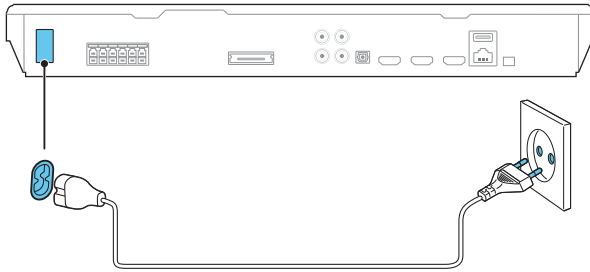

2

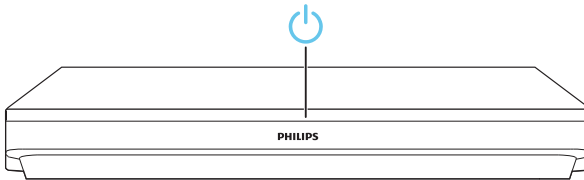

3

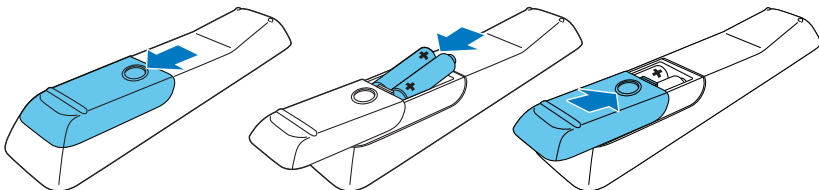

6

- EN** Complete the first time setup
- MS** Lengkapkan persediaan kali pertama
- TH** ตั้งค่าครั้งแรกให้เสร็จสมบูรณ์
- ZH-CN** 完成首次设置
- ZH-TW** 完成首次設定

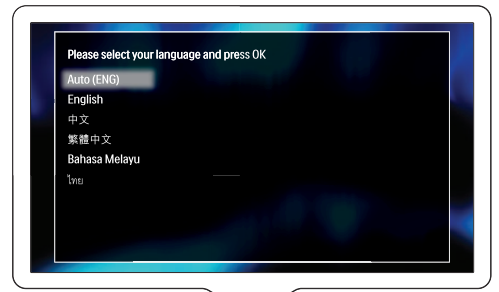
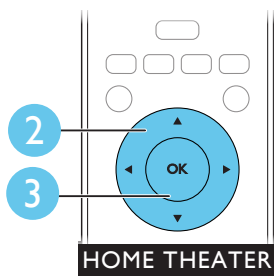
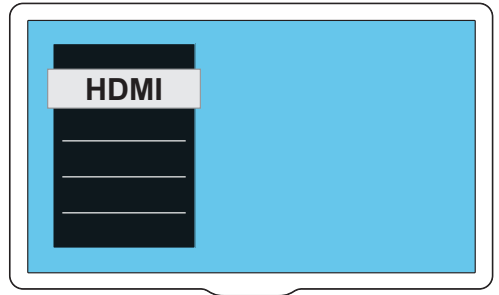
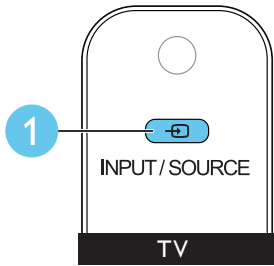

7

EN Use your home theater

MS Gunakan teater rumah anda

TH ใช้โฮมเธียเตอร์ของคุณ

ZH-CN 使用家庭影院

ZH-TW 使用您的家庭劇院

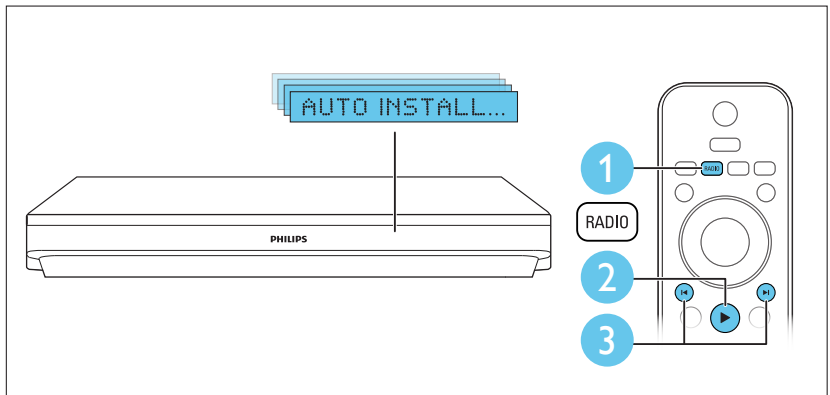
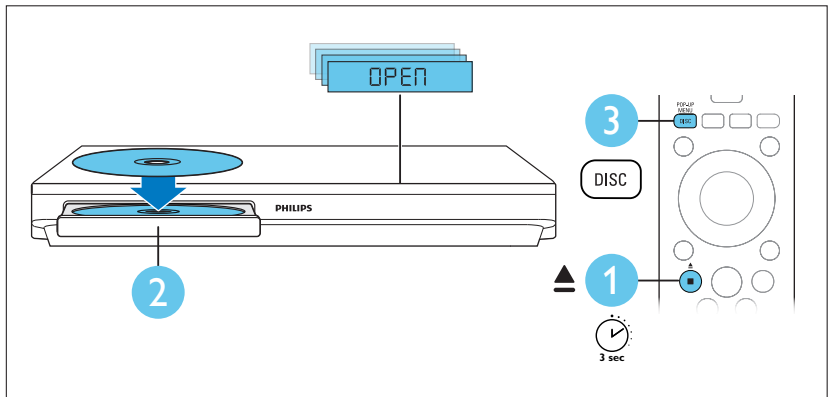

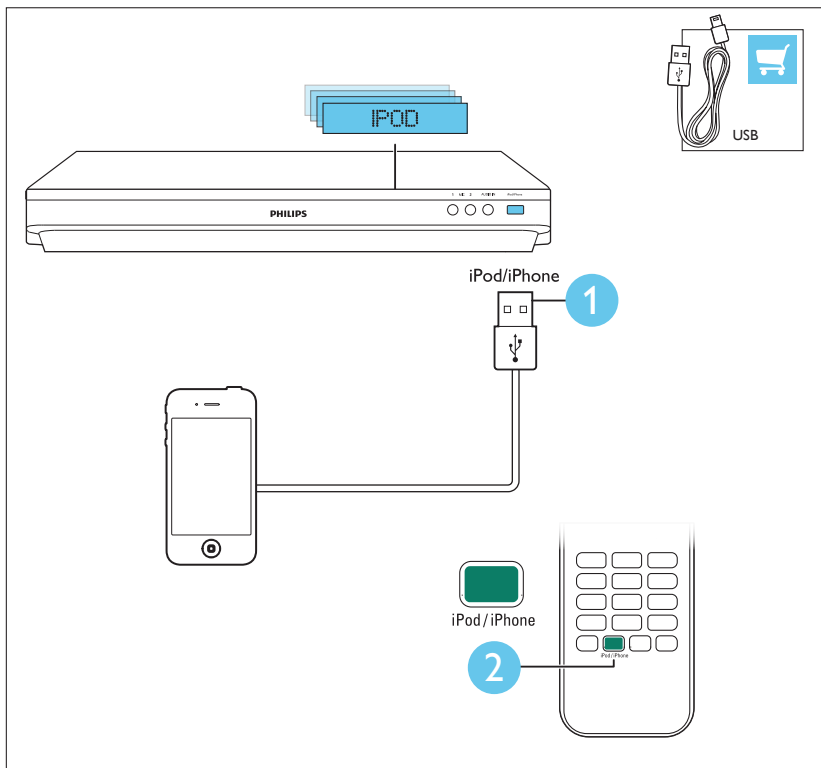
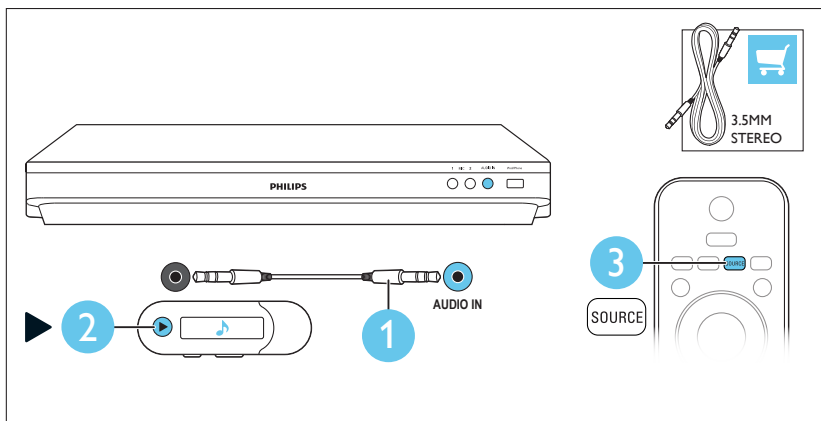

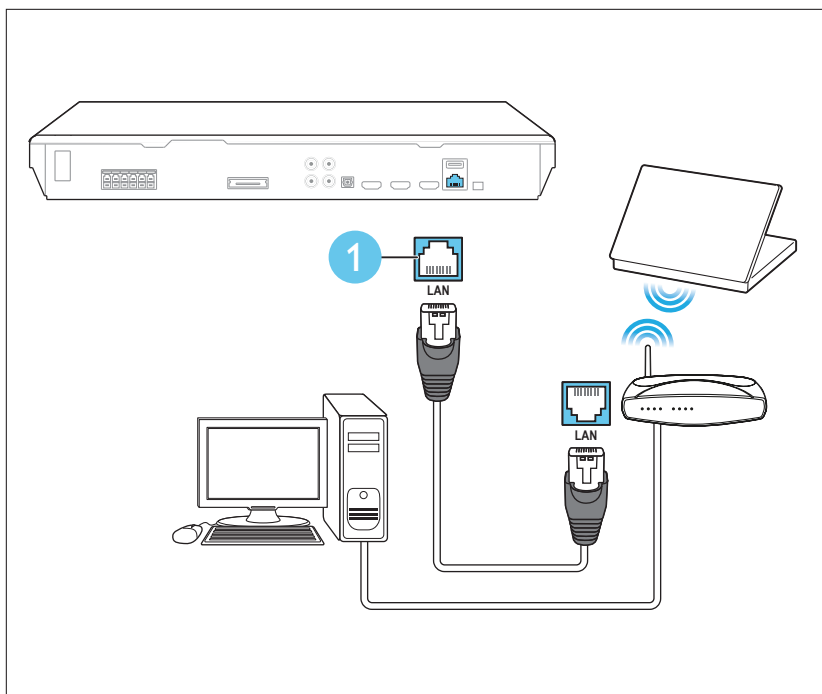
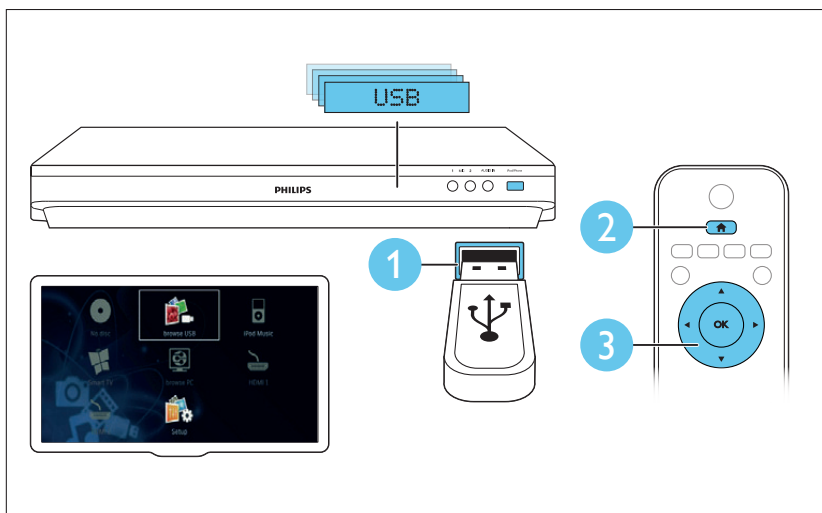



Specifications are subject to change without notice
© 2013 Koninklijke Philips Electronics N.V.
All rights reserved.

HTB5510D/5540D/5570D_98_QSG_V1.0

