

# Always there to help you

Register your product and get support at  
[www.philips.com/welcome](http://www.philips.com/welcome)

HTB5510D  
HTB5540D  
HTB5570D



# Quick start guide

**PHILIPS**



**EN** Before using your product, read all accompanying safety information

**ES** Antes de usar el producto, consulte la información de seguridad que se encuentra adjunta.

\* **ES** Adaptador suministrado como accesorio. No debe ser utilizado en las redes eléctricas en Argentina, su uso está destinado sólo para los demás países de América Latina.



## HTB5510D

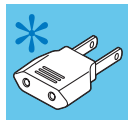
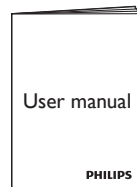
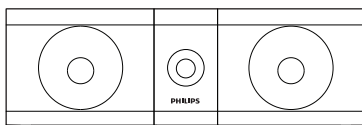
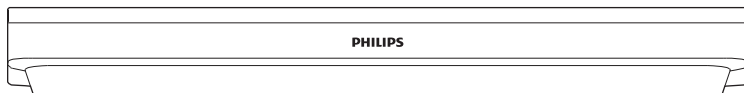
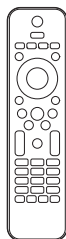

HDMI

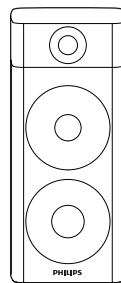
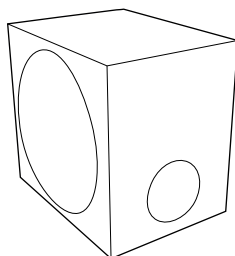

2x

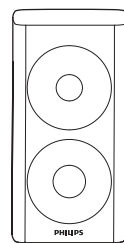

2x

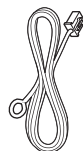

FM Antenna

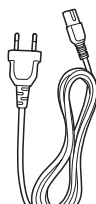

Power Cord

## HTB5540D

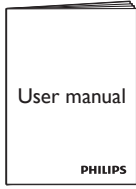

User manual

PHILIPS

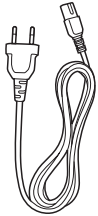
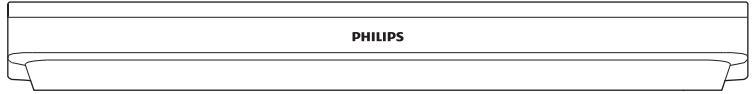

Power Cord

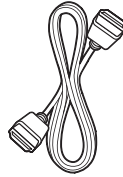
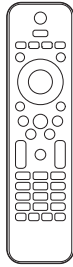

HDMI



FM Antenna

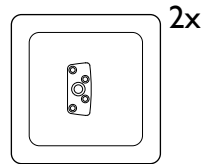
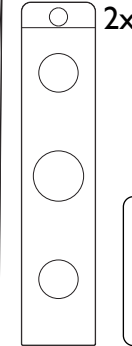
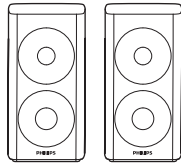
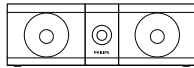
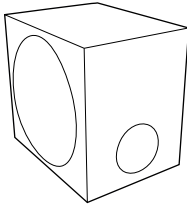

## HTB5570D

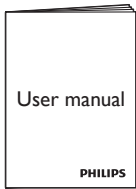

User manual

PHILIPS

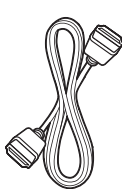
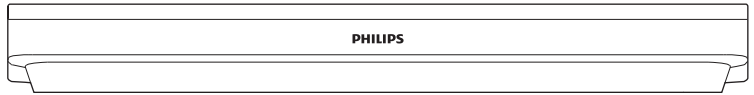

HDMI

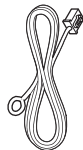

FM Antenna

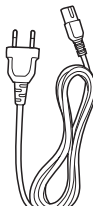
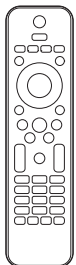

Power Cord

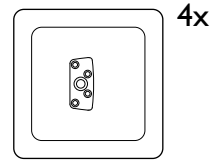
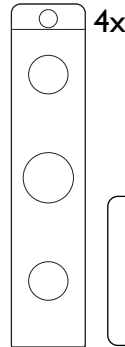
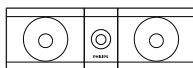
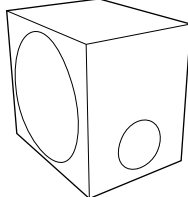

# 1

- EN** Stand mount the speakers  
Applied to HTB5540D and HTB5570D only
- ES** Montaje de los altavoces con base o soporte  
Solo aplica a los modelos HTB5540D y HTB5570D

1

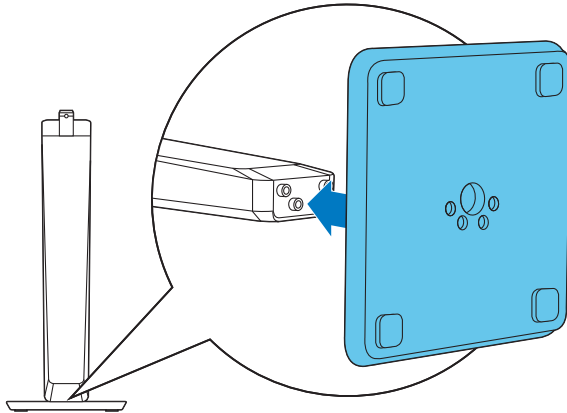

2

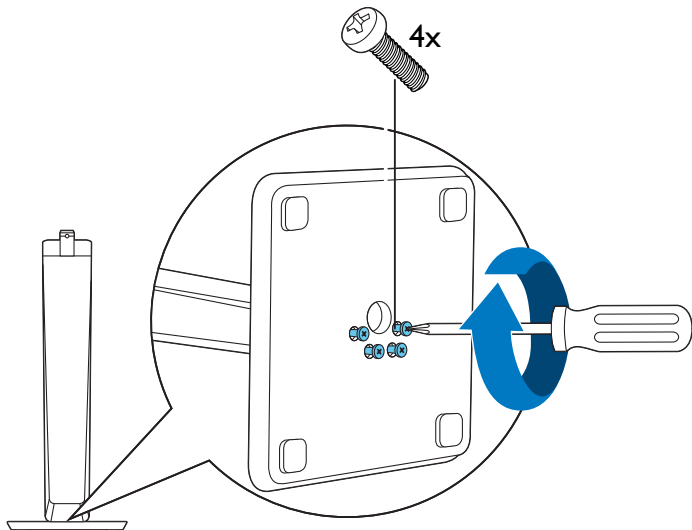

3

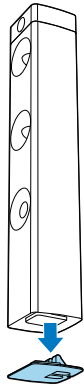

4

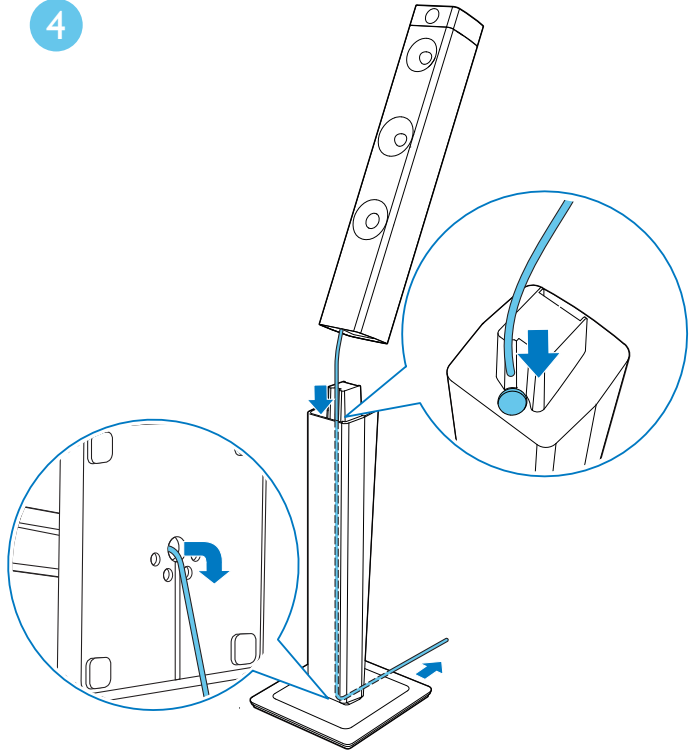

5

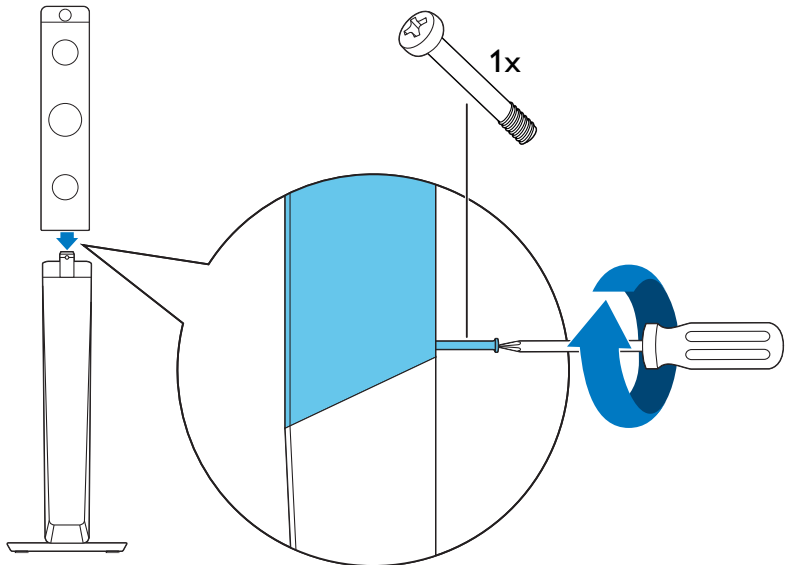

# 2

EN Connect the home theater  
ES Conexión del Home Theater

## HTB5510D

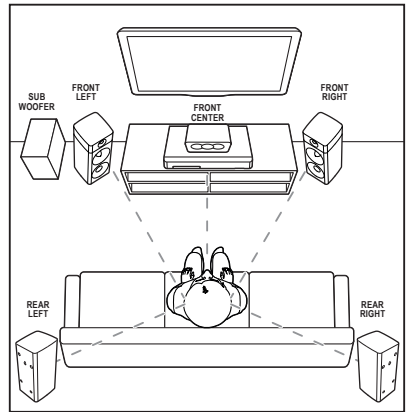
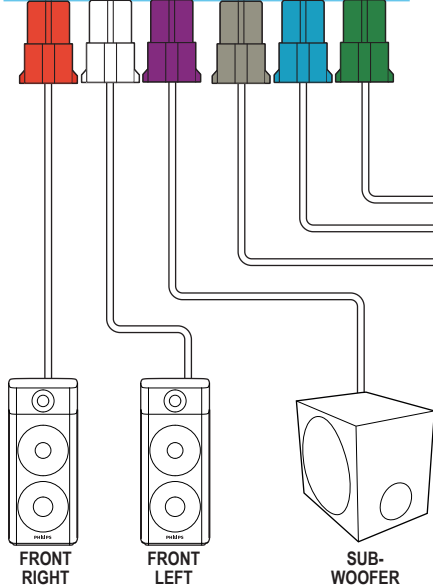
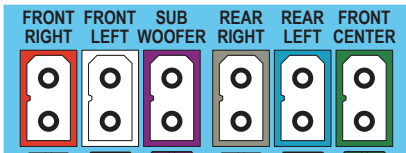
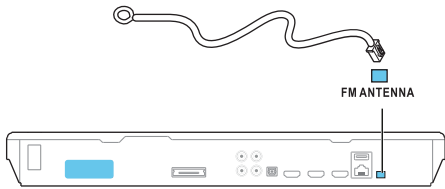

# HTB5540D

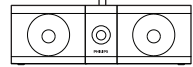
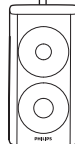
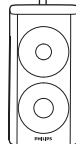
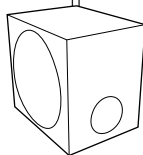
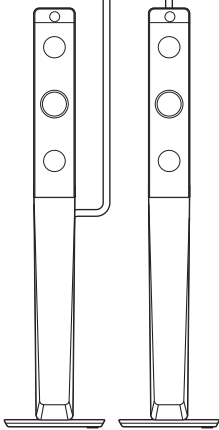
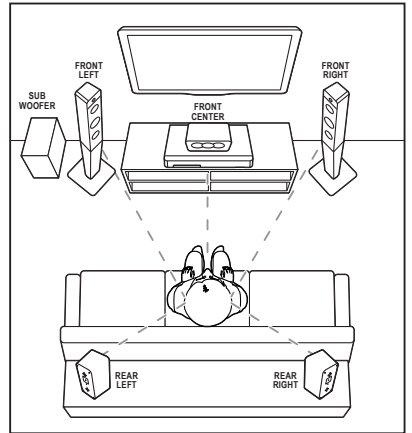
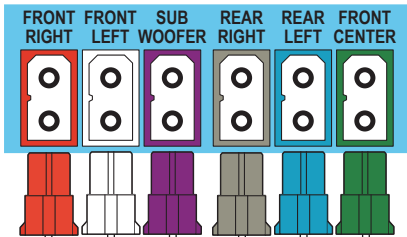

FRONT RIGHT

FRONT LEFT

SUB-WOOFER

REAR RIGHT

REAR LEFT

FRONT CENTER

# HTB5570D

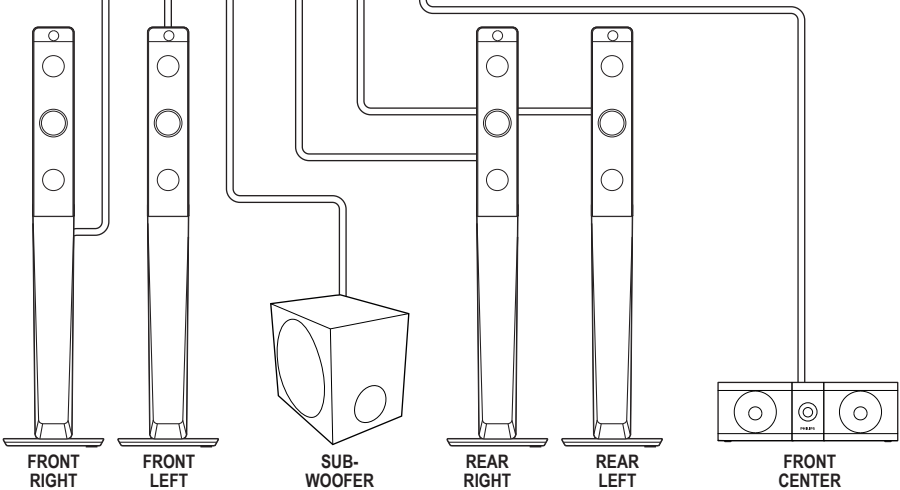
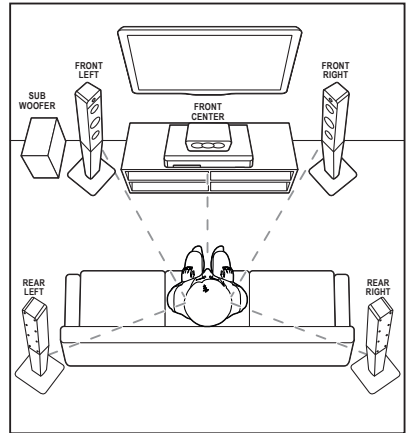
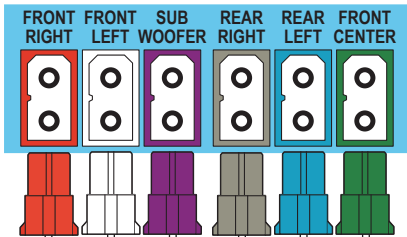



# 3

- EN Connect to TV in one of these ways
- ES Conecte al TV de alguna de las siguientes maneras

## HDMI ARC



## HDMI + OPTICAL

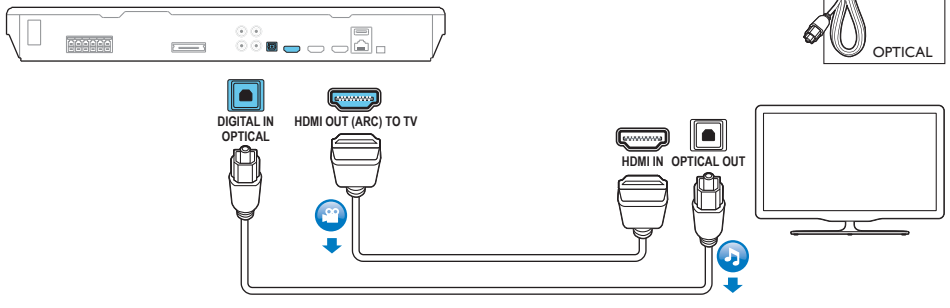

## HDMI + COAXIAL

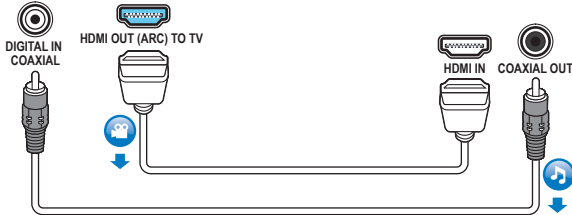

## HDMI + AUDIO L/R

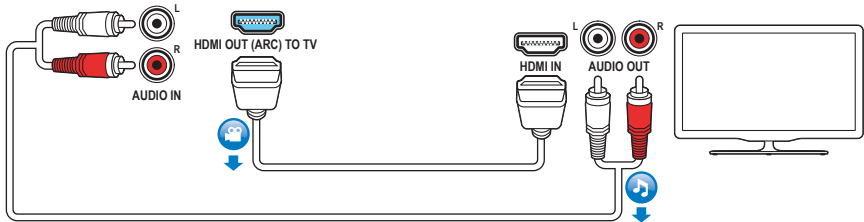

# 4

**EN** Connect with other HDMI devices

**ES** Conecte con otros dispositivos HDMI

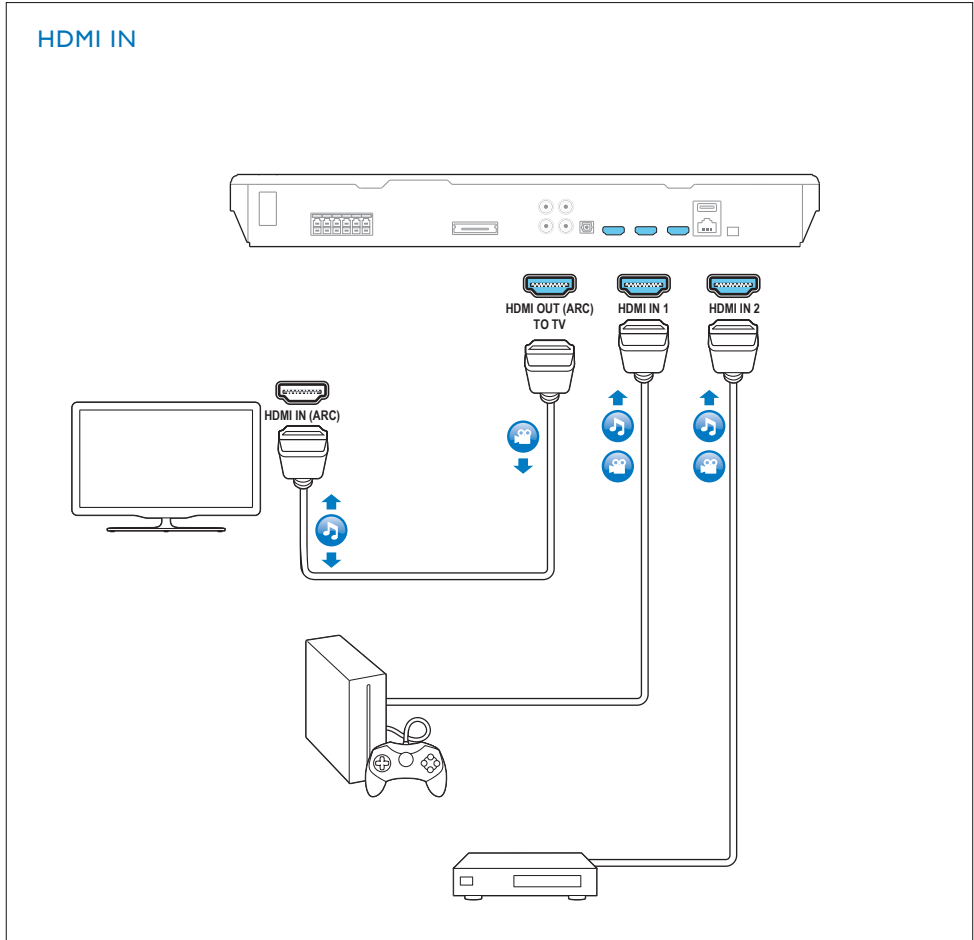

# 5

- EN Switch on the home theater
- ES Encendido del Home Theater

1

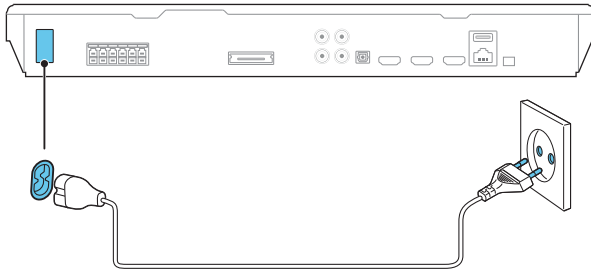

2

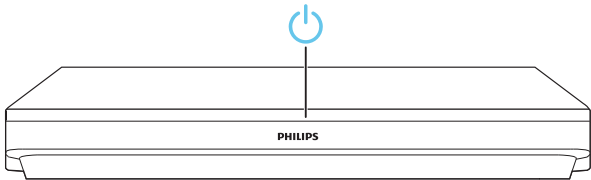

3

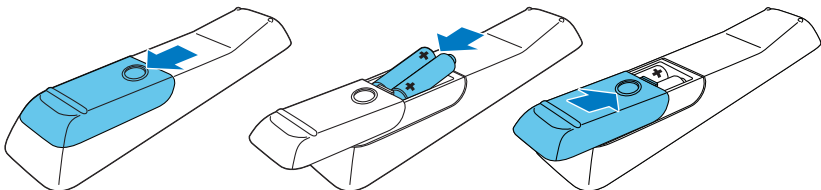

# 6

**EN** Complete the first time setup  
**ES** Proceso de configuración inicial

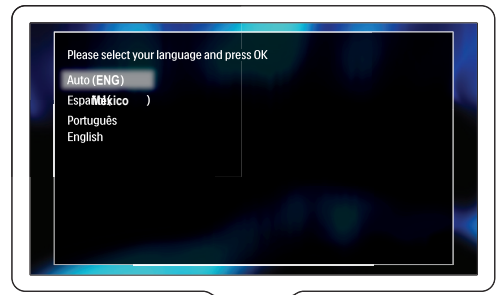
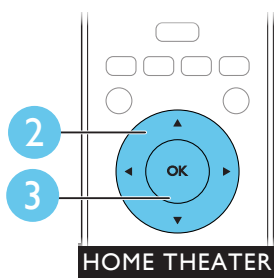
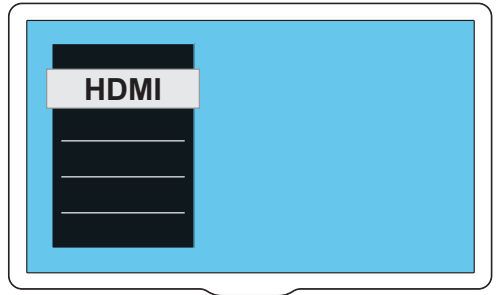
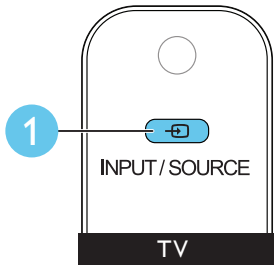

# 7

**EN** Use your home theater  
**ES** Uso del sistema de Home Theater

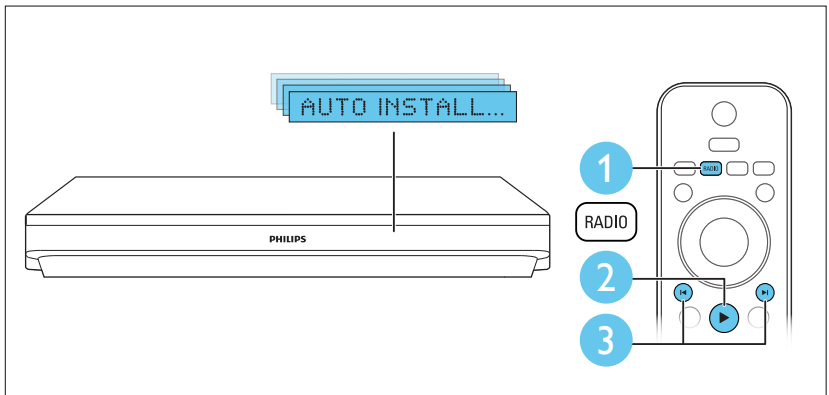
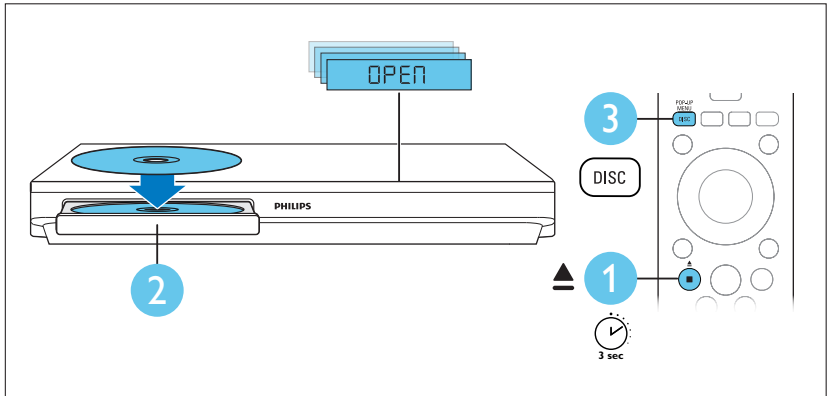

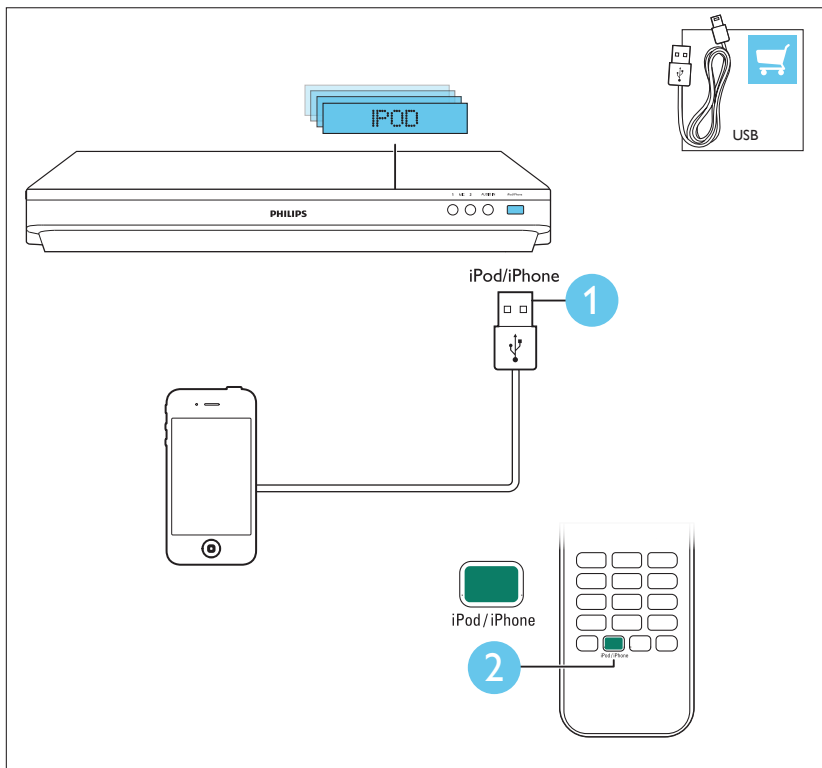
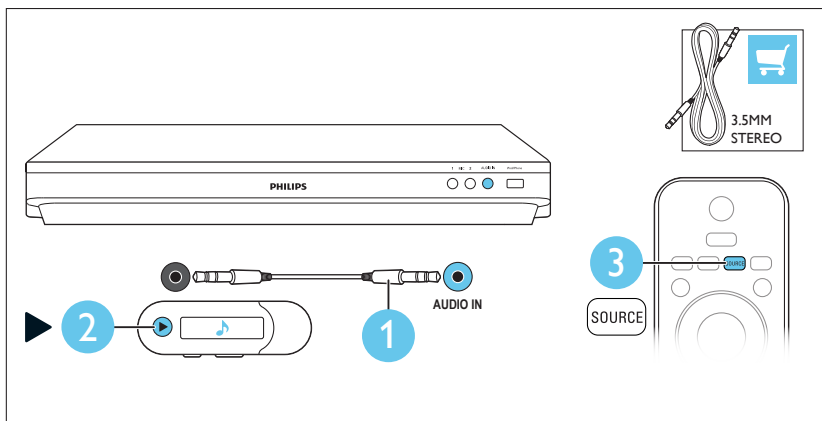

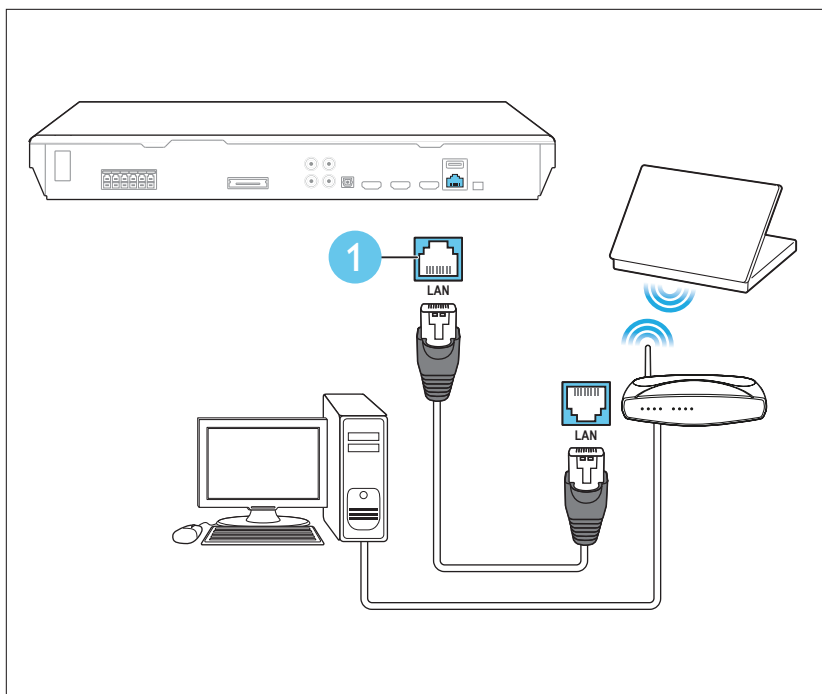
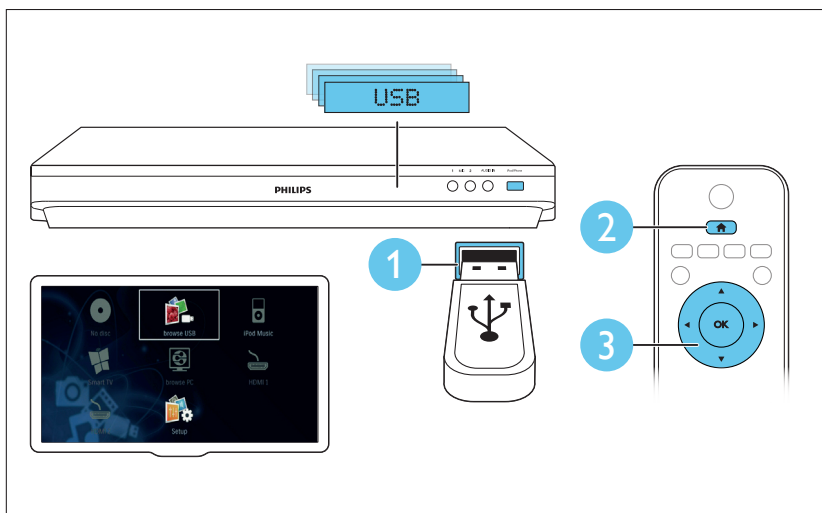





Specifications are subject to change without notice  
© 2013 Koninklijke Philips Electronics N.V.  
All rights reserved.

HTB5510D/5540D/5570D\_55\_QSG\_V1.0

