

Always there to help you

Register your product and get support at
www.philips.com/welcome

HTB5510D
HTB5540D
HTB5570D



Quick start guide

PHILIPS



EN Before using your product, read all accompanying safety information

HI अपने उत्पाद का उपयोग करने के पहले, साथ वाली सभी सुरक्षा जानकारी को पढ़ें



HTB5510D

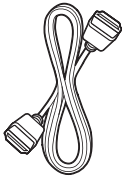
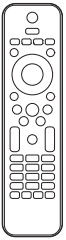

HDMI

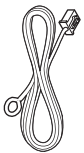
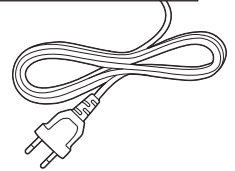
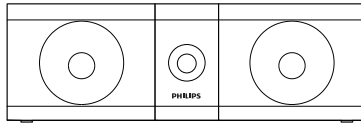
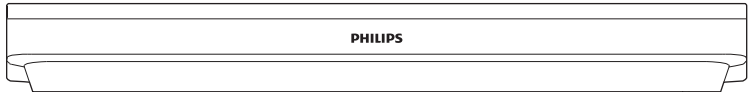

FM Antenna

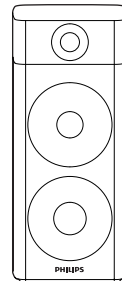
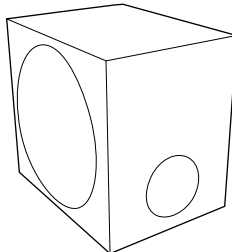
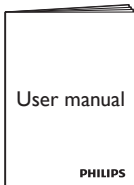

2x

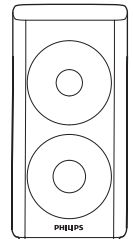

2x

HTB5540D

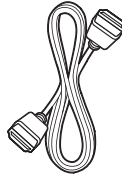
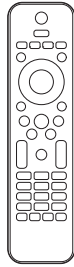
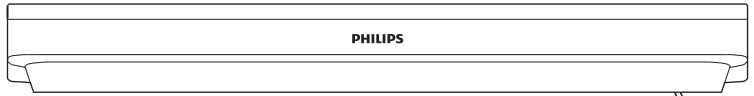
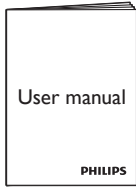

HDMI

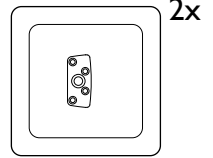
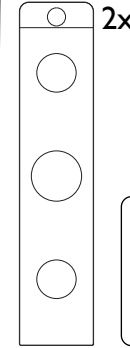
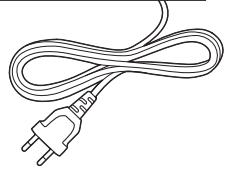

FM Antenna

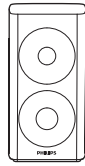
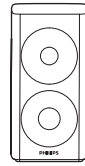
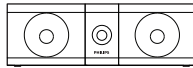
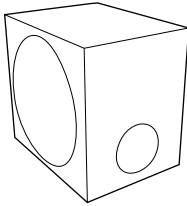

HTB5570D

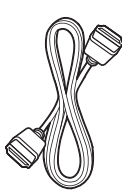
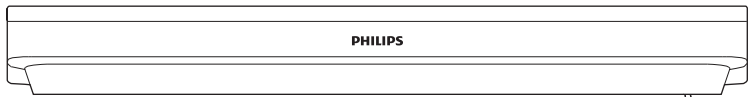
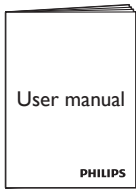

HDMI



FM Antenna

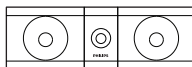
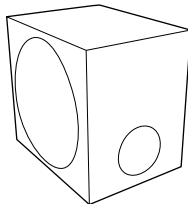
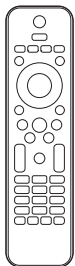
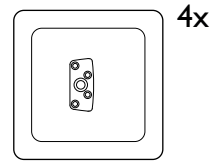
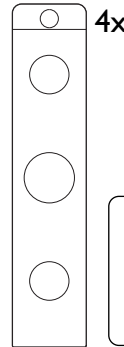
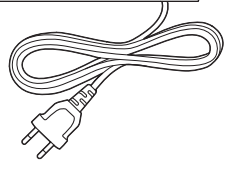

1

EN Stand mount the speakers
Applied to HTB5540D and HTB5570D only

HI स्पीकर्स को स्टैंड पर रखें
केवल HTB5540D और HTB5570D पर लागू

1

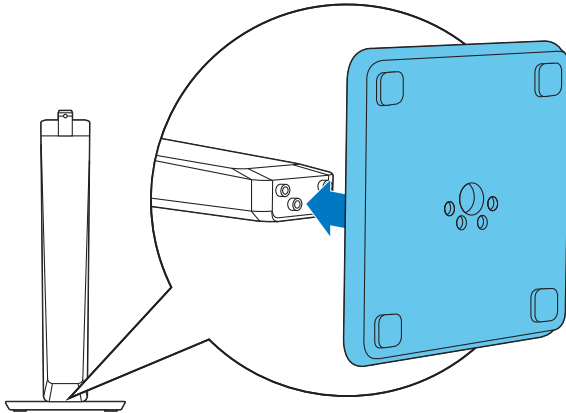

2

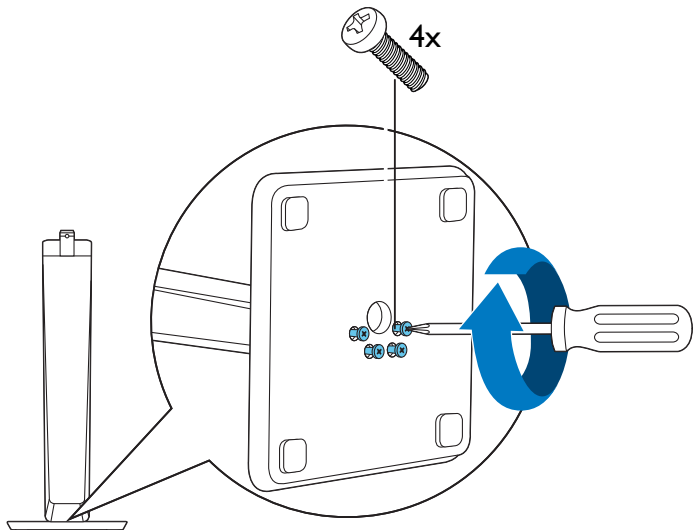

3

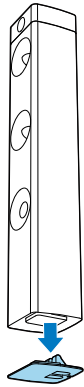

4

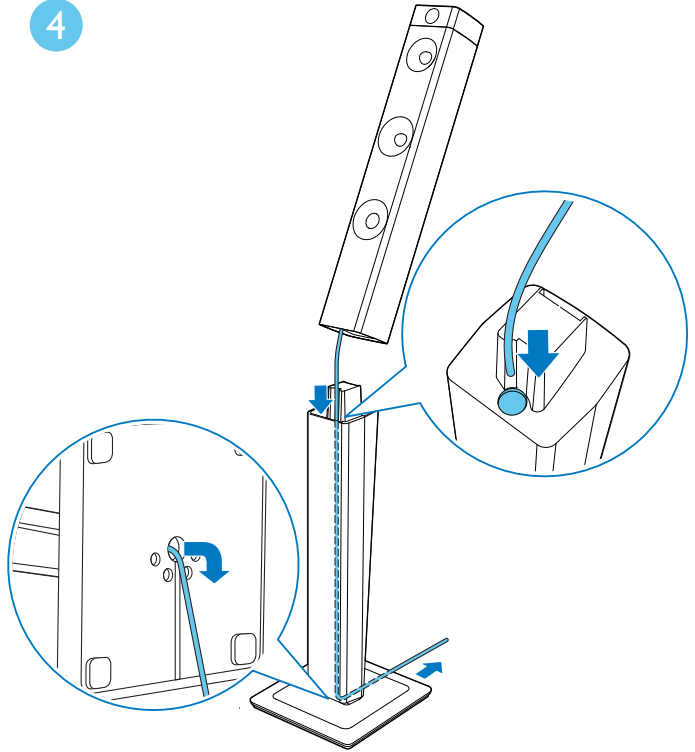

5

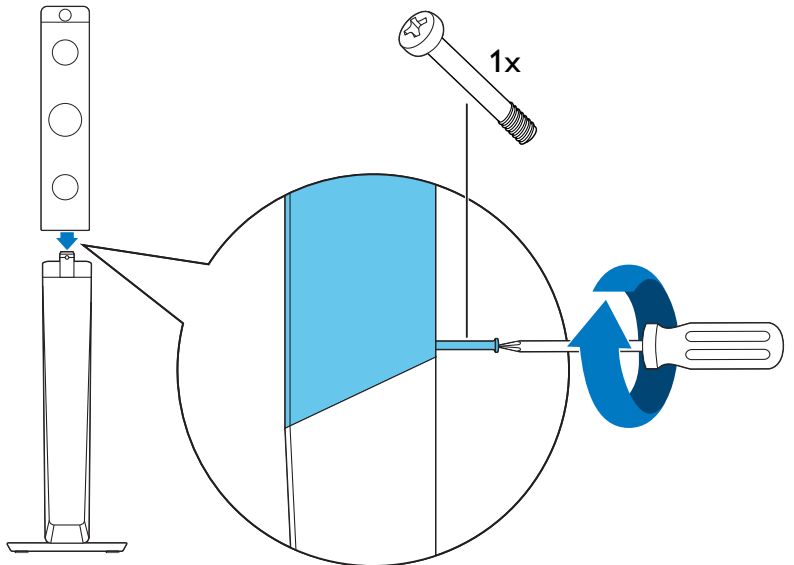

2

EN Connect and position the home theater

HI होम थिएटर को कनेक्ट और स्रि करे

HTB5510D

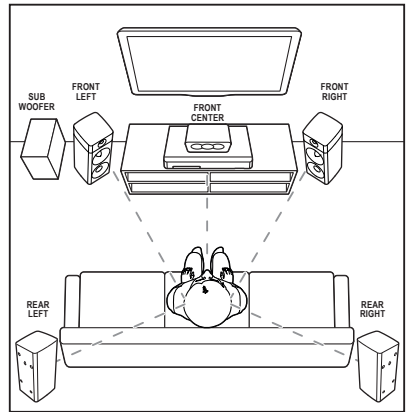
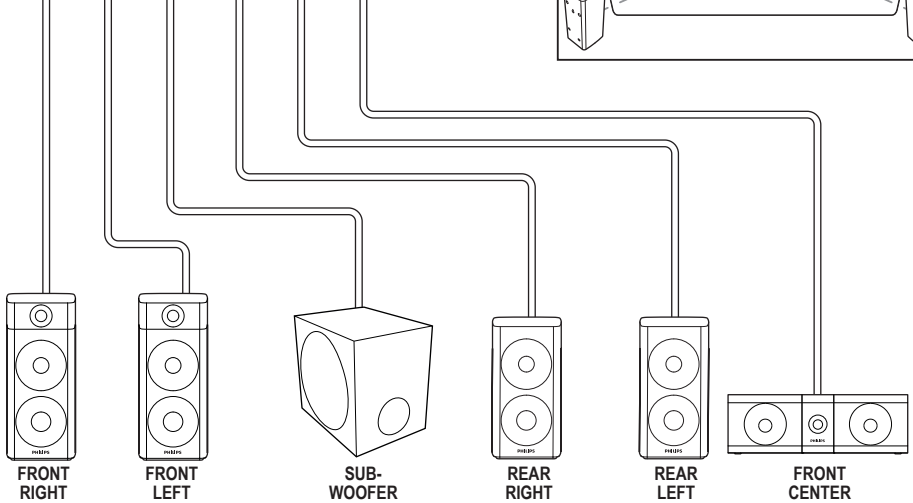
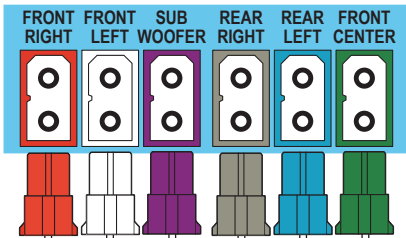
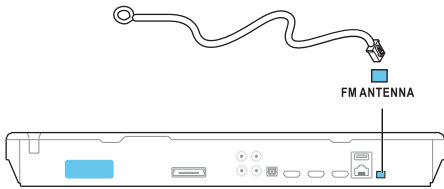

HTB5540D

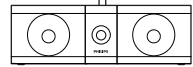
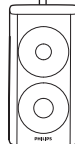
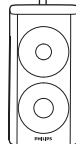
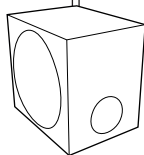
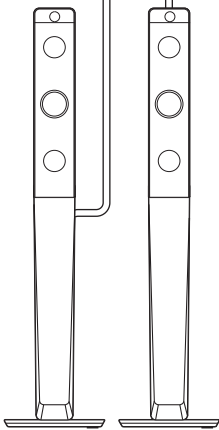
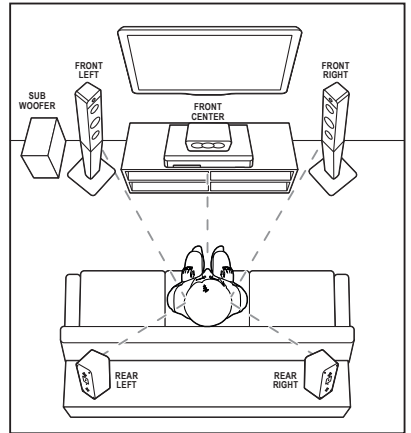
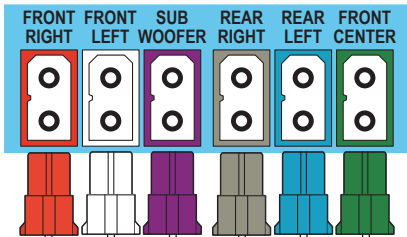

FRONT RIGHT

FRONT LEFT

SUB-WOOFER

REAR RIGHT

REAR LEFT

FRONT CENTER

HTB5570D

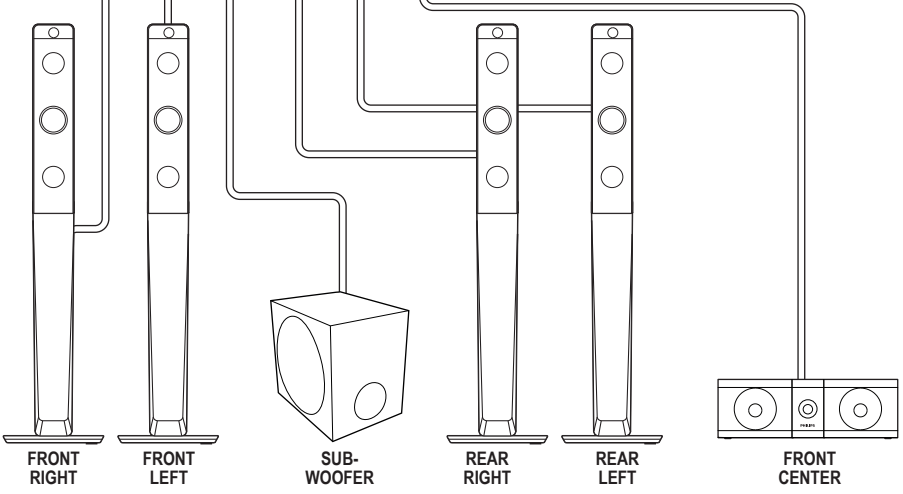
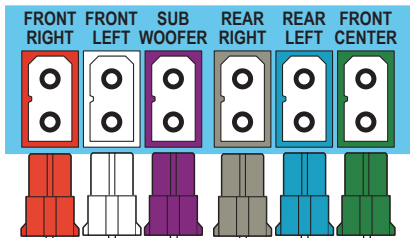
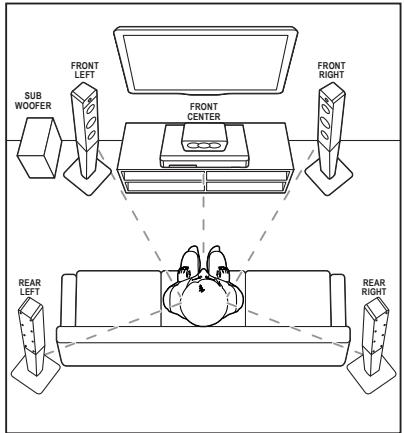
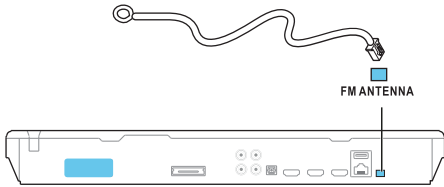

3

EN Connect to TV in one of these ways

HI इन तरीकों में से एक के द्वारा TV से कनेक्ट करें

HDMI ARC



HDMI + OPTICAL

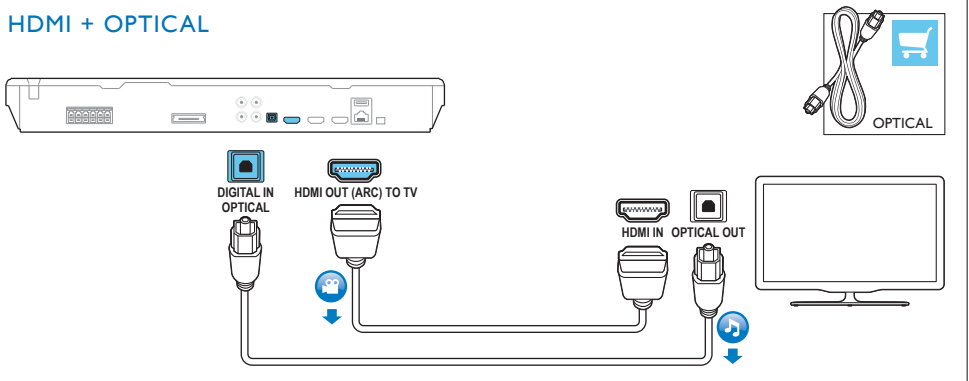

HDMI + COAXIAL

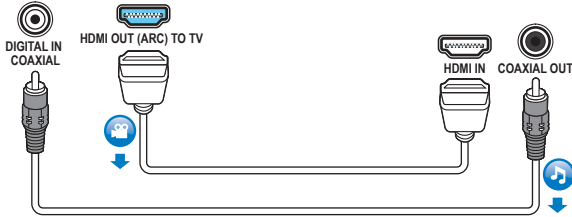

HDMI + AUDIO L/R

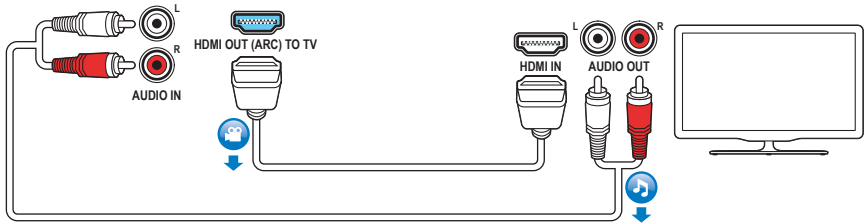

4

EN Connect with other HDMI devices

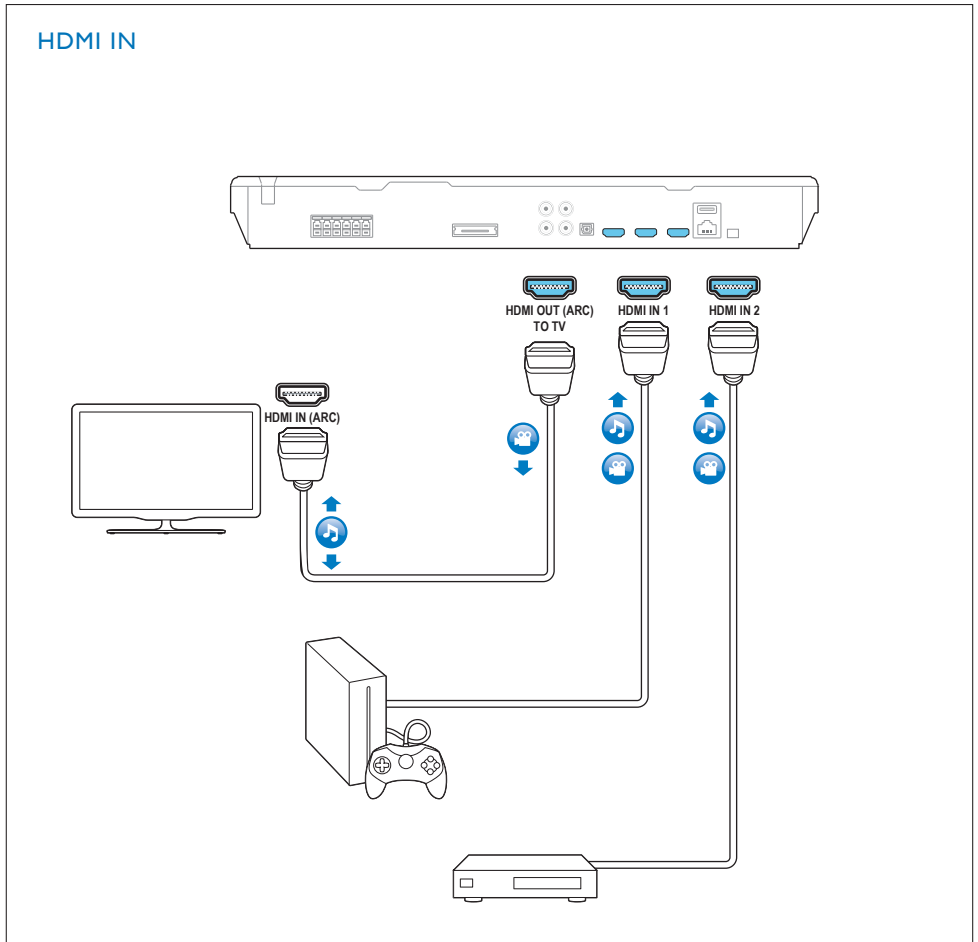

5

EN Switch on the home theater

HI होम थिएटर को स्विचि ऑन करें

1

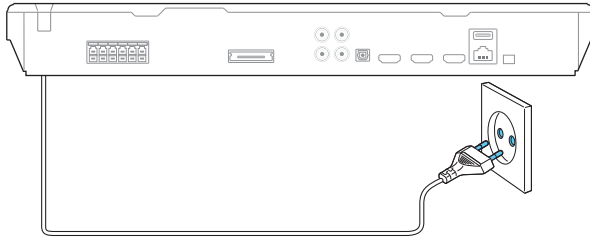

2

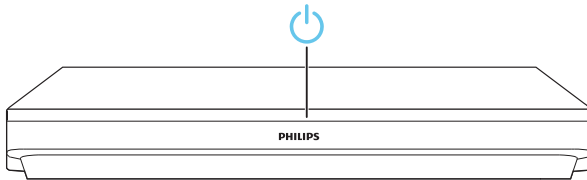

3

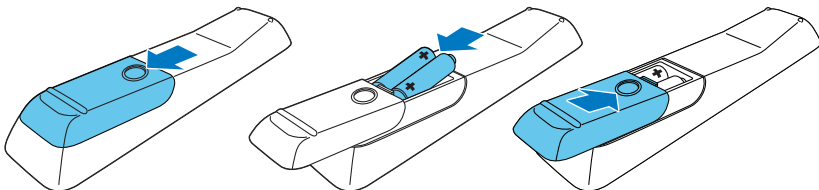

6

EN Complete the first time setup

HI पहली बार के सेटअप को पूरा करें

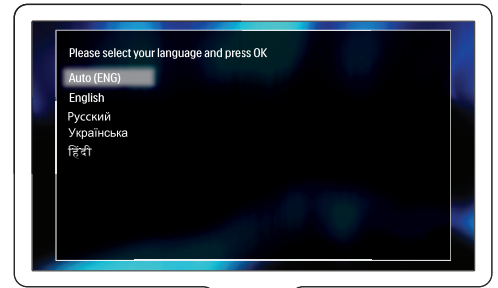
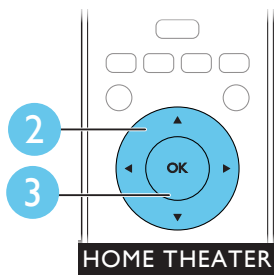
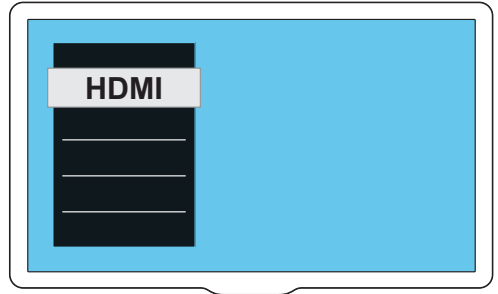
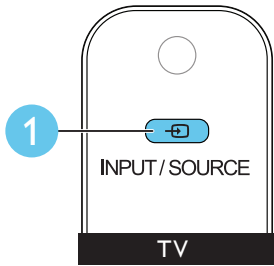

7

EN Use your home theater

HI अपने होम थिएटर का उपयोग करें

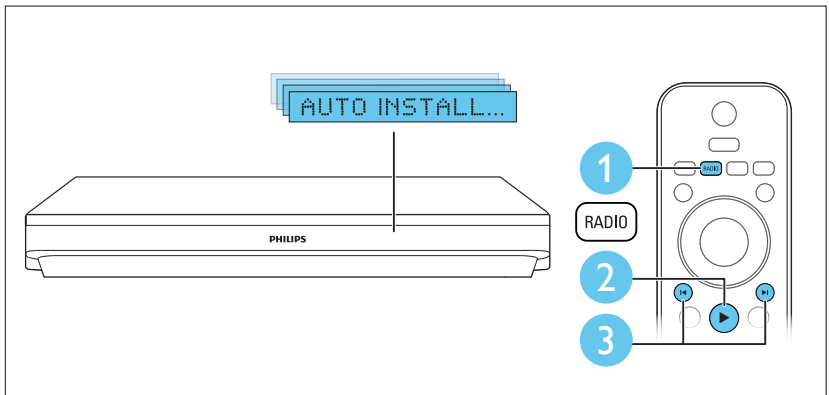
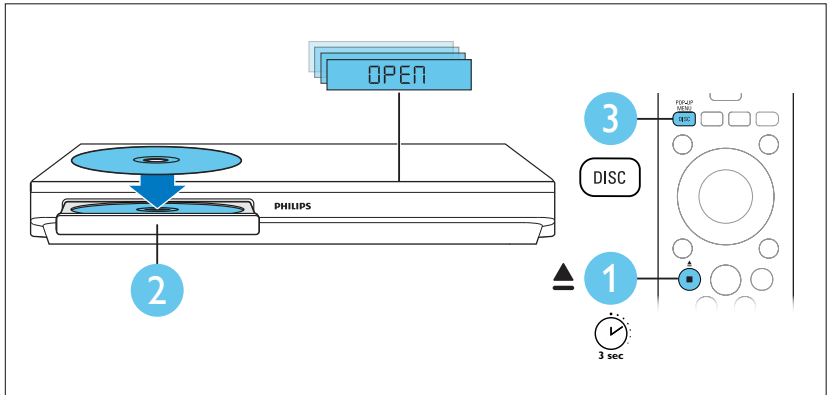

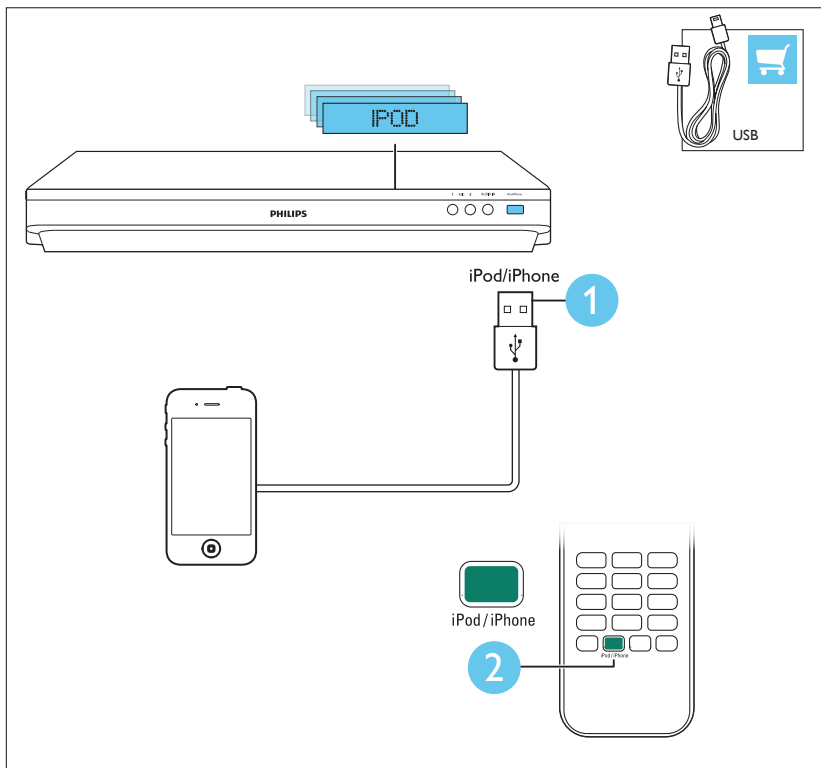
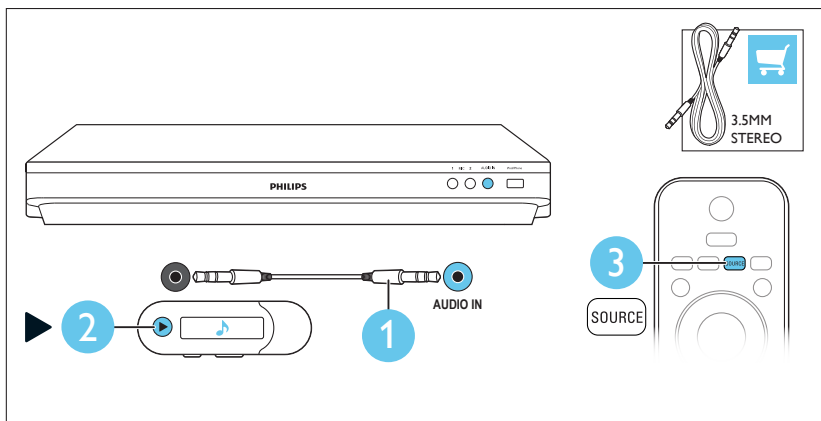

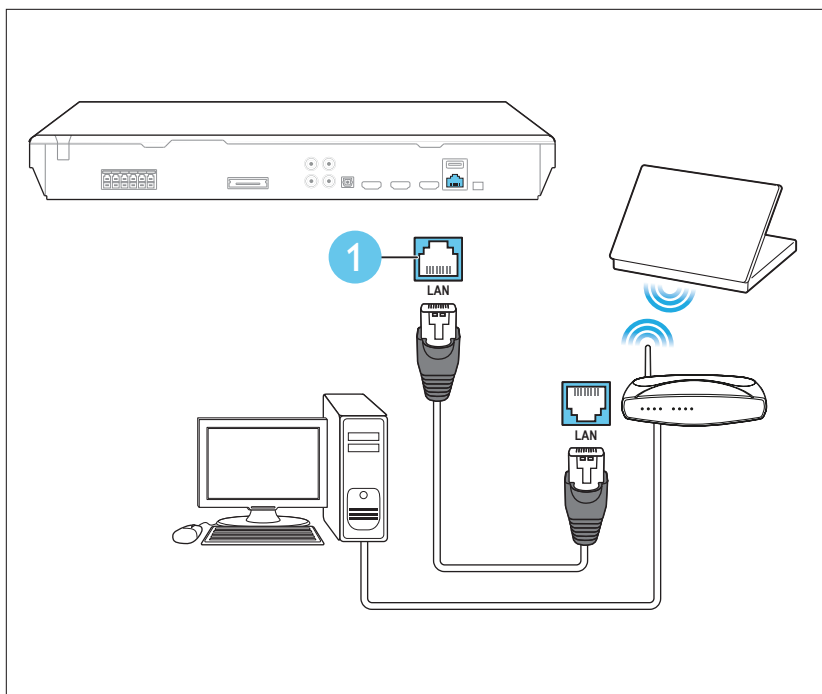
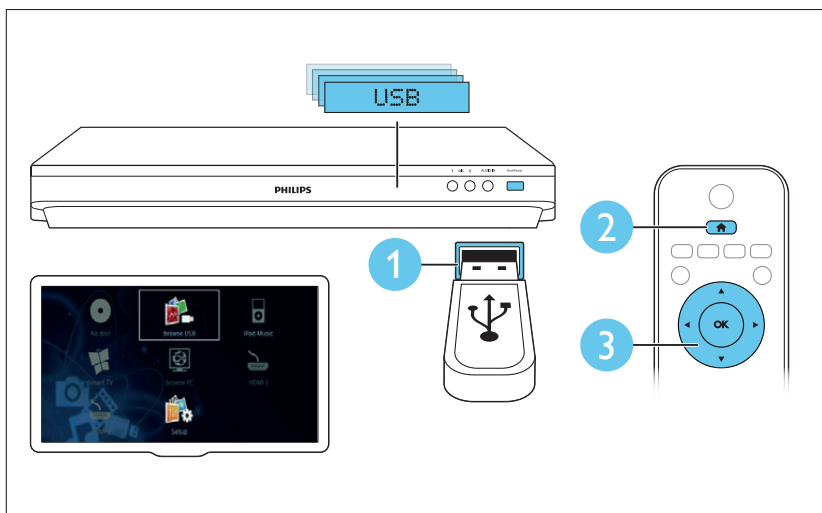



Specifications are subject to change without notice
© 2013 Koninklijke Philips Electronics N.V.
All rights reserved.

HTB5510D/5540D/5570D_94_QSG_V1.0

