

Register your product and get support at
www.philips.com/welcome

8000 series Smart LED TV

60PFL8708



User manual

PHILIPS

Contents

- 1 Tour 3**
 - 1.1 Smart TV 3
 - 1.2 App gallery 3
 - 1.3 Rental videos 3
 - 1.4 Online TV 3
 - 1.5 Social networks 3
 - 1.6 Skype 4
 - 1.7 Smartphones and tablets 4
 - 1.8 Pause TV and recordings 4
 - 1.9 Gaming 4
 - 1.10 EasyLink 5
- 2 Setting up 6**
 - 2.1 TV stand and wall mounting 6
 - 2.2 Tips on placement 6
 - 2.3 Power cable 6
 - 2.4 Antenna 6
 - 2.5 Satellite dish 7
 - 2.6 Network 7
 - 2.7 Connect devices 9
 - 2.8 Setup menu 18
 - 2.9 Safety and care 19
- 3 TV 21**
 - 3.1 Switch on 21
 - 3.2 Remote control 21
 - 3.3 TV channels 25
 - 3.4 TV guide 33
 - 3.5 Switch to devices 34
 - 3.6 Subtitles and languages 35
 - 3.7 Timers and clock 36
 - 3.8 Picture settings 36
 - 3.9 Sound settings 40
 - 3.10 Ambilight settings 42
 - 3.11 Universal access 43
- 4 Satellite channels 45**
 - 4.1 Watching satellite channels 45
 - 4.2 Satellite channel list 45
 - 4.3 Favourite satellite channels 45
 - 4.4 Lock satellite channels 46
 - 4.5 Satellite installation 47
- 5 3D 52**
 - 5.1 What you need 52
 - 5.2 Your passive 3D glasses 52
 - 5.3 Watch 3D 52
 - 5.4 Optimal 3D viewing 52
 - 5.5 Health warning 53
- 6 Smart TV 54**
 - 6.1 Home menu 54
 - 6.2 Smart TV Apps 54
 - 6.3 Videos, photos or music 56
 - 6.4 Multi room 59
 - 6.5 Pause TV 60
 - 6.6 Recording 61
 - 6.7 MyRemote App 62
- 7 Skype 67**
 - 7.1 What is Skype? 67
 - 7.2 Start Skype 67
 - 7.3 Contacts 68
 - 7.4 Calling on Skype 69
 - 7.5 Skype Credit 70
 - 7.6 Skype settings 70
 - 7.7 Sign out 71
 - 7.8 Terms of Use 71
- 8 Games 72**
 - 8.1 Play a game 72
 - 8.2 Two-player games 72
- 9 TV Specifications 73**
 - 9.1 Environmental 73
 - 9.2 Power 73
 - 9.3 Reception 74
 - 9.4 Display 74
 - 9.5 Sound 74
 - 9.6 Multimedia 74
 - 9.7 Connectivity 75
 - 9.8 Dimensions and weights 75
- 10 TV Software 76**
 - 10.1 Software version 76
 - 10.2 Software update 76
 - 10.3 Open source software 76
 - 10.4 Open source license 76
- 11 Support 77**
 - 11.1 Register 77
 - 11.2 Using help and search 77
 - 11.3 Online help 77
 - 11.4 Consumer Care 77
- 12 Copyrights and licences 78**
 - 12.1 HDMI 78
 - 12.2 Dolby 78
 - 12.3 DTS 2.0 + Digital Out™ 78
 - 12.4 Skype 78
 - 12.5 DLNA Certified® 78
 - 12.6 DivX Certified® 78
 - 12.7 Microsoft 78
 - 12.8 Wi-Fi Alliance 78
 - 12.9 MHEG software 79
 - 12.10 Other trademarks 79
- Index 80**

Tour

1.1

Smart TV

Connect this **Philips Smart LED TV** to the Internet and discover a new world of television. You can make a wired connection to your router or you can link up wirelessly with Wi-Fi.

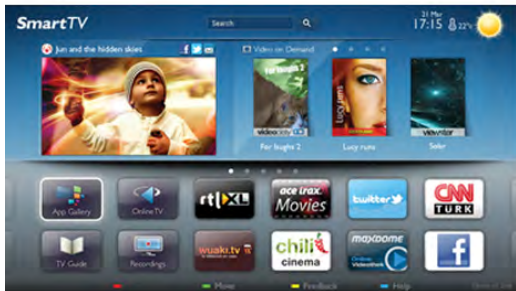

With the TV connected to your home network, a smartphone can show a photo on TV, you can play videos stored on your computer or control the TV with your tablet.

With your TV connected to the Internet, you can watch a rental video from an online video store, read the online TV guide or record your favourite TV show on a USB Hard Drive. The Smart TV Apps add to the fun with all sorts of entertainment and convenient services.

In **Help**, press **List** and look up **Smart TV** for more information.

1.2

App gallery

Open the **App gallery** in Smart TV to browse the Apps, the collection of tailored websites for TV.



Find the App for YouTube videos, a national newspaper, an online photo album, Facebook, Twitter, etc. There are Apps to rent a video from an online video store and Apps for watching programmes you missed. If the App gallery does not hold what you are looking for, try the World Wide Web and surf the Internet on TV.

In **Help**, press **List** and look up **App gallery** for more information.

1.3

Rental videos

To watch a **rental video**, you don't need to leave your home. Simply rent the latest movie from your regional online video store.

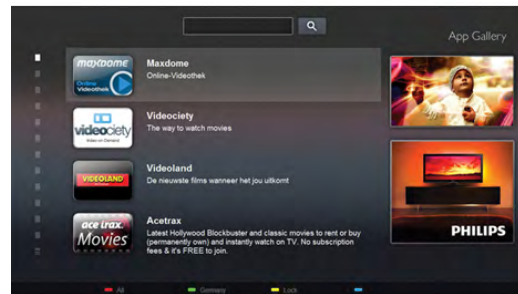

Start Smart TV and add the video store App to the Smart TV start page.

Open the video store App, create your personal account, select the movie and press play.

No fuss with downloading, you can watch the movie immediately*.

In **Help**, press **List** and look up **Rental videos** for more information.

* Depending on the video streaming service of the selected video store.

1.4

Online TV

With the **Online TV** Apps of Smart TV (streaming TV), you can watch a TV programme you just missed or watch a programme when it suits you best.

Look for the broadcaster logo in the App gallery.

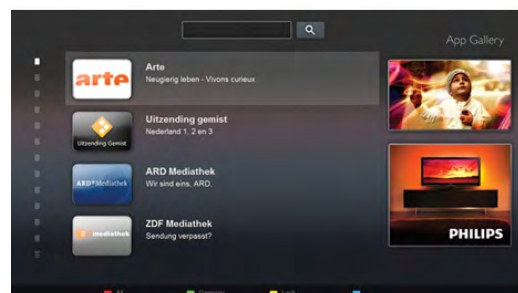

In **Help**, press **List** and look up **Online TV** for more information.

1.5

Social networks

No need to get up to check your friend's messages on your computer. Open Smart TV, select your **social network** page and send a message back from your couch.



Smart TV supports the popular social networks Facebook and Twitter.

In **Help**, press **■ List** and look up **App gallery** for more information.

1.6

Skype

With **Skype™** you can make video calls on your TV for free.



You can call and see your friends from anywhere in the world. To make a video call, you need a camera with a built-in microphone and a good connection to the Internet. Some Philips TVs have a camera and microphone built in.

In **Help**, press **■ List** and look up **Skype** for more information.

1.7

Smartphones and tablets

To use your smartphone or tablet as a TV remote control or as your media controller, download the **Philips MyRemote** app from your smartphone or tablet app store.



Operate your TV from your smartphone or tablet, switch channels or change the volume. With the MyRemote app, you can use your phone or tablet to send photos, music or videos from your computer to your TV. And with MyRemote app on a tablet, you can call up the TV guide, read about the programmes and switch the TV to a channel with a simple tap of your finger. The MyRemote app is available for iOS and Android.

In **Help**, press **■ List** and look up **MyRemote app** for more information.

1.8

Pause TV and recordings

If you connect a USB Hard Drive, you can **pause and record a broadcast** from a digital TV channel.



Pause your TV and answer that urgent phone call or simply take a break during a sports match, while the TV stores the broadcast on the USB Hard Drive. You can start watching again later.

With a USB Hard Drive connected, you can also record digital broadcasts. You can record while you are watching a program or schedule a recording of an upcoming programme.

In **Help**, press **■ List** and look up **Pause TV** or **Recording** for more information.

1.9

Gaming

If you select your **game console** in the Home menu, the TV switches to the settings ideal for gaming automatically.

If you play a multi-player game with split screens, you can set the TV to show each screen as a full screen simultaneously. Each player can focus on his own game to play.



Player 1



Player 2

The TV uses 3D technology to show both screens. To play a two-player game with two different full screen pictures, you need a pair of 3D glasses for each player.

In **Help**, press **Red List** and look up **Game console** or **Two-player games** for more information.

1.10

EasyLink

With **EasyLink** you can operate a connected device, like a Blu-ray Disc player, with the remote control of the TV. EasyLink uses HDMI CEC to communicate with the connected devices.



In **Help**, press **Red List** and look up **EasyLink** for more information.

Setting up

TV stand and wall mounting

TV Stand

You can find the mounting instructions of the TV stand in the Quick Start Guide that came with the TV. In case you lost this guide, you can download it from www.philips.com.

Use the product type number of the TV to look for the Quick Start Guide to download.

Wall mounting

Your TV is also prepared for a VESA-compliant wall mount bracket (sold separately).

Use the following VESA code when purchasing the wall mount

...

VESA MIS-F 200x200,M8

To fix the bracket securely, use a screw length as shown in the drawing.

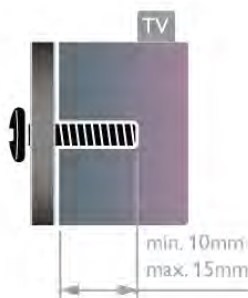

Caution

Wall mounting the TV requires special skills and should only be performed by qualified personnel. The TV wall mounting should meet safety standards according to the TV's weight. Also read the safety precautions before positioning the TV. TP Vision Netherlands B.V. bears no responsibility for improper mounting or any mounting that results in accident or injury.

Tips on placement

- Position the TV where light does not shine directly on the screen.
- Dim lighting conditions in the room for best Ambilight effect.
- Position the TV up to 15 cm away from the wall.
- The ideal distance to watch TV from is three times its diagonal screen size. When seated, your eyes should be level with the centre of the screen.



Power cable

Insert the power cable into the **POWER** socket of the TV. Make sure the power cable is securely inserted into the TV. Make sure that the power plug in the wall socket is accessible at all times.

When disconnecting the power cable, always pull the plug, never the cable.

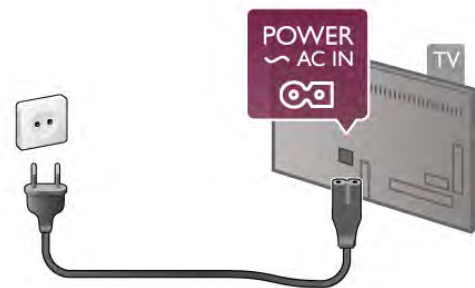

Although this TV has a very low standby power consumption, unplug the power cable to save energy if you do not use the TV for a long period of time.

In **Help**, press **List** and look up **Standby** for more information on switching the TV on and off.

Antenna

Locate the antenna connection at the back of the TV. Insert the antenna cable securely into the **Antenna** socket.

You can connect your own antenna or connect to an antenna signal from an antenna distribution system (common in certain regions). Use an IEC Coax 75 Ohm RF antenna connector.

Use this antenna connection for DVB-T and DVB-C input signals.

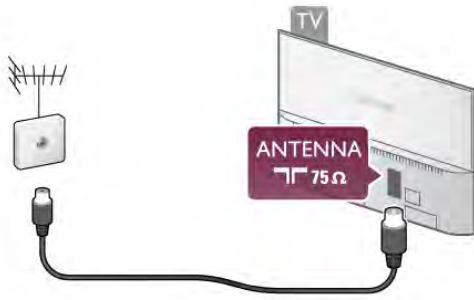

2.5

Satellite dish

Locate the F-type satellite connection at the back of the TV. Attach the cable from your satellite dish - or Unicable splitter - to this connection.

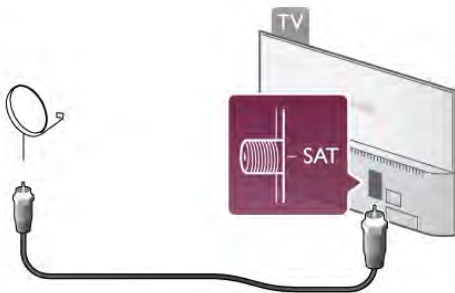

2.6

Network

Wireless connection

What you need

To connect the TV wirelessly to the Internet, you need a **wireless router**. Use a high-speed (broadband) connection to the Internet.



File sharing

The TV can find and open files on other devices in your wireless network, like your computer or NAS device. You can use a computer with a Microsoft Windows XP, Vista or Windows 7, Mac OSX or Linux-based operating system.

Media server software

With media server software on your computer, you can open your photos, music and videos stored on your computer on your TV screen.

Use a recent version of media server software like Windows Media Player 11, Twonky™ or similar*.

Install the software on your computer and set it up to share your media files with the TV. Read the manual of the media server software for more information.

To open your files on the TV, the media server software must be running on your computer.

* In **Help**, press **List** and look up **Media server software, supported** for an overview of supported media server software.

Make the connection

Follow steps **1** to **5**.

Step 1 - Make sure that the router of your wireless network is switched on.

Step 2 - Press **Home** and select **Setup** and press **OK**.

Step 3 - Select **Connect to network** and press **OK**.

Step 4 - Select **Wireless** and press **OK**.

Step 5 - Select **Scan** to scan for your wireless network. If you have a router with WPS (Wi-Fi Protected Setup), you can select **WPS**. Select your choice and press **OK**.

- Scan

Select **Scan** to scan for your wireless network (your wireless router). The TV might find several wireless networks in your proximity.

- WPS

If your router has WPS, you can directly connect to the router without scanning. Go to the router, press the **WPS** button and return to the TV within 2 minutes. Then press **Connect** to make the connection.

If you have devices in your wireless network that use the WEP security encryption system, you cannot use WPS.

If you must use the **WPS pin code** to connect, select **Scan** instead of WPS.

Step 6 - In the list of networks found, select your wireless network and press **OK**.

If your network is not in the list because the network name is hidden (you switched off the SSID broadcast of the router), select **Manual entry** to enter the network name yourself.

Step 7 - Depending on the type of router, you can now enter your encryption key (WEP, WPA or WPA2). If you entered the encryption key for this network before, you can select **Next** to make the connection immediately.

If your router supports WPS or WPS pin, you can select **WPS**, **WPS pin** or **Standard**. Select your choice and press **OK**.

- Standard

Select **Standard** to enter the encryption key (password, passphrase or security key) manually. You can use the keyboard on the RC to enter the encryption key. Once you have entered the key, press **Connect**.

- WPS pin

To make a secured WPS connection with a PIN code, select **WPS pin** and press **OK**. Write down the 8-digit PIN code shown and enter it in the router software on your PC. Return to the TV and press **Connect**. Consult the router manual on where to enter the PIN code in the router software.

Step 8 - A message will be shown when the connection is successful.

Network configuration

If the connection fails, you can check the DHCP setting of the router. DHCP should be set to **On**.

Alternatively, if you are an advanced user and want to install your network with static IP addressing, set the TV to Static IP. To set the TV to Static IP, press **Home** and select **Setup** and press **OK**. Select **Network settings > Network configuration > Static IP**. With Static IP selected in the menu, you can set the IP address and other necessary settings in **Static IP configuration** in the same menu.

Network problems

Wireless network not found or distorted

- Microwave ovens, DECT phones or other Wi-Fi 802.11b/g/n devices in your proximity might disturb the wireless network.
- Make sure that the firewalls in your network allow access to the TV's wireless connection.
- If the wireless network does not work properly in your home, try the wired network installation.

Internet does not work

- If the connection to the router is OK, check the router connection to the Internet.

The PC and Internet connection are slow

- Look in your wireless router's user manual for information on indoor range, transfer rate and other factors of signal quality.
- Use a high-speed (broadband) Internet connection for your router.

Wired connection

What you need

You need a network **router** to connect the TV to the Internet. Use a router with a high-speed (broadband) connection to the Internet.

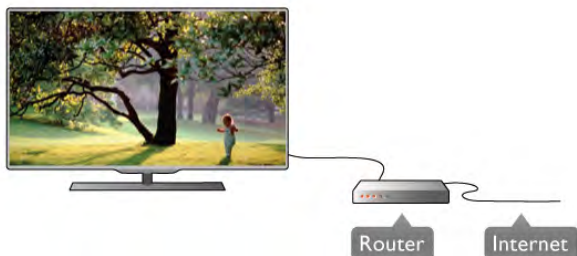

Installation

Follow steps **1** to **5**.

- 1** - Connect the router to the TV with a network cable (Ethernet cable**).
- 2** - Make sure that the router is switched on.

3 - Press **Home** and select **Setup** and press **OK**.

4 - Select **Connect to network** and press **OK**.

5 - Select **Wired** and press **OK**.

The TV constantly searches for the network connection. A message will be shown when the connection is successful.

Network configuration

If the connection fails, you can check the DHCP setting of the router. DHCP should be set to **On**.

Alternatively, if you are an advanced user and want to install your network with static IP addressing, set the TV to Static IP. To set the TV to Static IP, press **Home** and select **Setup** and press **OK**.

Select **Network settings > Network configuration > Static IP**. With Static IP selected in the menu, you can set the IP address and other necessary settings in **Static IP configuration** in the same menu.

File sharing

The TV can find and open files on other devices in your network, like your computer. You can use a computer with a Microsoft Windows XP, Vista or Windows 7, Mac OSX or Linux operating system.

Media server software

With media server software on your computer, you can open your photos, music and videos stored on your computer on your TV screen.

Use a recent version of media server software like Windows Media Player 11, Twonky™ or similar*.

Install the software on your computer and set it up to share your media files with the TV. Read the manual of the media server software for more information.

To open your files on TV, the media server software must be running on your computer.

* In **Help**, press **List** and look up **Media server software, supported** for an overview of supported media server software.

**To fulfill EMC regulations, use a shielded FTP Cat. 5E Ethernet cable.

Network settings

To open the Network settings, press **Home** and select **Setup** and press **OK**.

Select **Network settings** and press **OK**.

View network settings

All current network settings are shown here. The IP and MAC address, signal strength, speed, encryption method, etc.

Network type

Sets the network to **Wired** or **Wireless**.

Network configuration

Sets the network configuration to **DHCP & Auto IP** or **Static IP**.

Static IP configuration

If Static IP is set, you can set all necessary static IP settings here.

Digital Media Renderer - DMR

To receive multimedia files from smartphones or tablets, set the DMR to **On**.

Wi-Fi Miracast

For more information on Wi-Fi Miracast, press **List** and look up **Wi-Fi Miracast™**.

Wi-Fi Miracast connections

For more information on Wi-Fi Miracast, press **List** and look up **Wi-Fi Miracast™**.

Wi-Fi smart screen

For more information on Wi-Fi smart screen, press **List** and look up **MyRemote App, WiFi smart screen**.

TV network name

If you have more than one TV in your network, you can rename the TVs here.

Clear Internet memory

With Clear Internet memory you clear all Internet files stored on your TV. You clear your Philips Smart TV registration and parental rating setting, your video store app logins, all Smart TV app favourites, Internet bookmarks and history. Interactive MHEG applications can also save so-called 'cookies', on your TV. These files will also be cleared.

2.7

Connect devices

Tips on connections

Connectivity guide

Always connect a device to the TV with the **highest quality connection available**. Also, use good quality cables to ensure a good transfer of picture and sound.

If you need help to connect several devices to the TV, you can visit the **Philips TV connectivity guide**. The guide offers information on how to connect and which cables to use.

Go to www.connectivityguide.philips.com

Antenna

If you have a Set-top box (a digital receiver) or Recorder, connect the antenna cables to run the **antenna signal** through the Set-top box and/or Recorder first before it enters the TV. In this way, the antenna and the Set-top box can send possible additional channels to the Recorder to record.

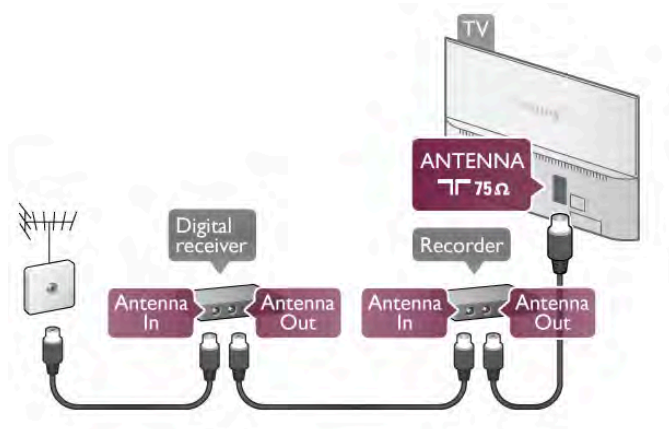

HDMI

HDMI CEC

An **HDMI** connection has the best picture and sound quality. One HDMI cable combines video and audio signals. Use an HDMI cable for High Definition (HD) TV signals. For best signal quality transfer, use a **High speed HDMI** cable and do not use an HDMI cable longer than 5 m.



EasyLink HDMI CEC

If your devices are connected with HDMI and have EasyLink, you can operate them with the TV remote control. EasyLink HDMI CEC must be switched on on the TV and the connected device.

In **Help**, press **List** and look up **EasyLink HDMI CEC** for more information on using EasyLink.

DVI to HDMI

Use a DVI to HDMI adapter if your device only has a DVI connection. Use one of the HDMI connections and add an Audio L/R cable (mini-jack 3.5 mm) to Audio In VGA/DVI for sound, on the back of the TV.

Copy protection

DVI and HDMI cables support HDCP (High-bandwidth Digital Content Protection). HDCP is a copy protection signal that prevents copying content from a DVD disc or Blu-ray Disc. Also referred to as DRM (Digital Rights Management).

HDMI ARC

All of the HDMI connections on the TV have **HDMI ARC** (Audio Return Channel).

If the device, typically a Home Theatre System (HTS), also has the HDMI ARC connection, connect it to any of the HDMI connections on this TV. With the HDMI ARC connection, you do not need to connect the extra audio cable that sends the sound of the TV picture to the HTS. The HDMI ARC connection combines both signals.

You can use any HDMI connection on this TV to connect the HTS but ARC is only available for 1 device/connection at a time.

In case you prefer to switch off ARC on the HDMI connections, press **Home** and select **Settings** and press **OK**. Select **TV settings** > **Sound** > **Advanced** > **HDMI ARC**.

Y Pb Pr

Component Video YPbPr is a high quality connection. The YPbPr connection can be used for High Definition (HD) TV signals. Next to the Y, Pb and Pr signals add the Audio Left and Right signals for sound.

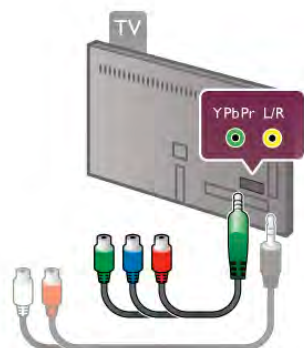

Use the supplied YPbPr adapter cable to connect your device. Match the YPbPr (green, blue, red) connector colours with the cable plugs when you connect.

Use an Audio L/R cinch to mini-jack (3.5mm) adapter cable (not supplied) if your device also has sound.

SCART

SCART is a good quality connection. The SCART connection can be used for CVBS and RGB video signals but cannot be used for High Definition (HD) TV signals. The SCART connection combines video and audio signals.

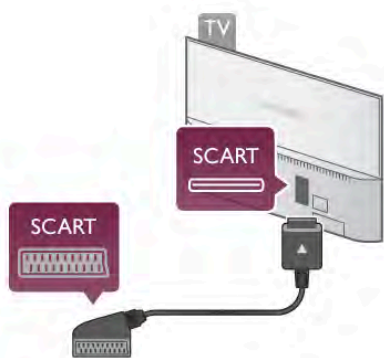

Use the supplied SCART adapter cable to connect your device.

Audio Out - Optical

Audio Out - Optical is a high quality sound connection. This optical connection can carry 5.1 audio channels. If your audio device, typically a Home Theatre System (HTS), has no HDMI ARC connection, you can connect this sound cable to an Audio In - Optical connection on the HTS. This Audio cable will send the sound of the TV to the HTS.



You can set the type of the audio out signal to fit the audio capabilities of your Home Theatre System.

In **Help**, press **Red** **List** and look up **Audio Out settings** for more information.

If the sound does not match the video on screen, you can adjust the audio to video synchronization.

In **Help**, press **Red** **List** and look up **Audio to video sync** for more information.

EasyLink HDMI CEC

EasyLink

With **EasyLink** you can operate a connected device with the TV remote control. EasyLink uses HDMI CEC* to communicate with the connected devices. Devices must support HDMI CEC and must be connected with an HDMI connection.

* *Consumer Electronics Control*



EasyLink setup

The TV comes with EasyLink switched on. Make sure that all HDMI CEC settings are properly set up on the connected EasyLink devices. EasyLink might not work with devices from other brands.

HDMI CEC on other brands

The HDMI CEC functionality has different names on different brands. Some examples are: Anynet, Aquos Link, Bravia Theatre Sync, Kuro Link, Simplink and Viera Link. Not all brands are fully compatible with EasyLink.

Example HDMI CEC branding names are property of their respective owners.

Operate devices

To operate a device connected to HDMI and set up with EasyLink, select the device -or its activity- in the list of TV connections. Press **SOURCE**, select a device connected to an HDMI connection and press **OK**.



Once the device is selected, the TV remote control can control the device. However the **HOME** and **OPTIONS** keys and some other typical TV keys, like **Ambilight**, are not forwarded to the device.

If the key you need is not on the TV remote control, you can select the key in the Options menu. Press **OPTIONS** and select **Controls** in the menu bar. Select the device key you need on screen and press **OK**.

Some very specific device keys might not be available in the Controls menu.

EasyLink settings

The TV comes with all EasyLink settings switched on. You can switch off any EasyLink setting independently.

EasyLink

To switch off EasyLink completely, press **HOME** and select **Setup** and press **OK**.

Select **TV settings > General settings > EasyLink > EasyLink**. Select **Off** and press **OK**.

EasyLink Remote Control

If you want devices to communicate but you don't want to operate them with the TV remote control, you can switch off EasyLink remote control separately.

In the EasyLink settings menu, select **EasyLink Remote Control** and select **Off**.

Pixel Plus link

Some devices, a DVD or Blu-ray Disc player, might have their own picture quality processing. To avoid bad picture quality caused by interference with the TV processing, the picture processing of these devices should be disabled. The TV comes with Pixel Plus link switched on and disables the picture quality processing of recent Philips devices connected to the TV.

To switch off Pixel Plus link, in the EasyLink settings menu, select **Pixel Plus link** and select **Off**.

Auto subtitle shift

If you play a DVD or Blu-ray Disc on a Philips disc player that supports subtitles, the TV can move the subtitles upwards. Subtitles will be visible whatever Picture format you select. The TV comes with Auto subtitle shift switched on.

To switch off Auto subtitle shift, in the EasyLink settings menu, select **Auto subtitle shift** and select **Off**.

Common Interface CAM

CI+

This TV is ready for the CI+ Conditional Access.

With CI+ you can watch premium HD programmes, like movies and sports, offered by digital TV broadcasters in your region. These programmes are scrambled by the TV broadcaster and descrambled with a prepaid CI+ module. Digital TV broadcasters provide this CI+ module (Conditional Access Module - CAM) when you subscribe to their premium programmes. These programmes have a high level of copy protection.

Contact a digital TV broadcaster for more information on terms & conditions.

In **Help**, press **List** and look up **Common Interface CAM** for more information on connecting a CAM.



CAM

Insert a CAM module

Switch off the TV before inserting a CAM. Look on the CAM for the correct method of insertion. Incorrect insertion can damage the CAM and the TV.

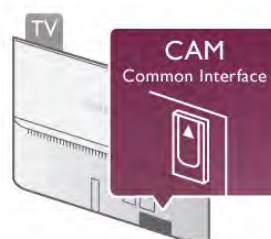

Use the Common Interface slot on the TV to insert the CAM card*. Gently insert the CAM as far as it will go and leave it in the slot permanently. It may take a few minutes before the CAM is activated. Removing the CAM will deactivate the broadcast service on TV.

* The Common Interface slot accepts a PC card (PCMCIA) in which you insert a smart card. Both cards should be supplied by the TV broadcaster.

If a CAM is inserted and subscription fees have been paid, (connection methods can differ), you can watch the TV broadcast. The inserted CAM is exclusively for your TV.

CAM settings

To set passwords or PIN codes for the CAM TV broadcast, press **HOME** and select **Setup** and press **OK**.

Select **Channel settings > Common Interface**.

Select the CAM TV broadcaster and press **OK**.

Set-top box STB

Use 2 antenna cables to connect the antenna to the Set-top box (a digital receiver) and the TV.

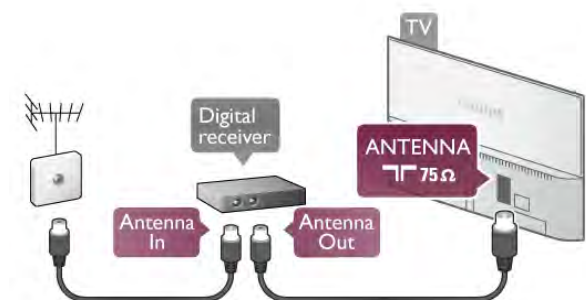

Next to the antenna connections, add an HDMI cable to connect the Set-top box to the TV. Alternatively, you can use a SCART cable if the Set-top box has no HDMI connection.

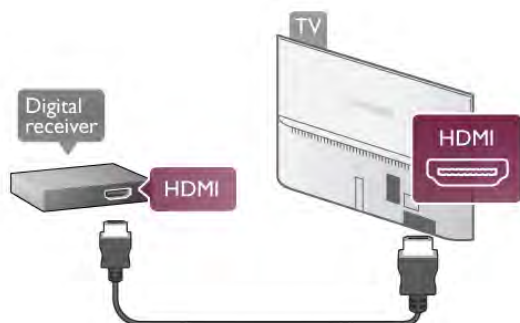

Switch off timer

Switch off this automatic timer, if you only use the remote control of the Set-top box. Do this to prevent the TV from switching off automatically after a 4 hour period without a key press on the remote control of the TV.

To switch off the Switch off timer, press **Home** and select **Setup** and press **OK**. Select **TV settings** > **General settings** > **Switch off timer** and set the slider bar to **0**.

Satellite receiver

Connect the dish antenna cable to the Satellite receiver.

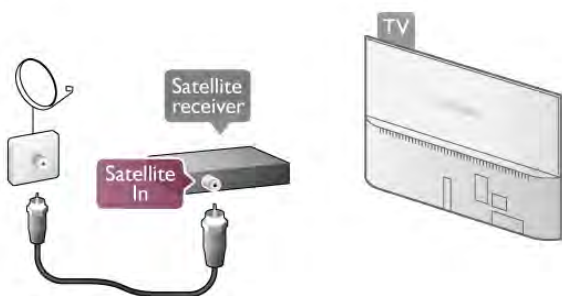

Next to the antenna connection, add an HDMI cable to connect the device to the TV. Alternatively, you can use a SCART cable if the device has no HDMI connection.

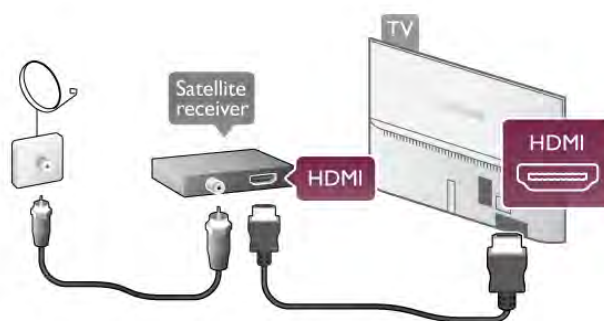

Switch off timer

Deactivate the Switch off timer, if you only use the remote control of the Satellite receiver. Do this to prevent the TV from switching off automatically after a 4 hour period without a key press on the remote control of the TV.

To deactivate, press **Home** and select **Setup** and press **OK**. Select **TV settings** > **General settings** > **Switch off timer** and set the slider bar to **0**.

Home Theatre System (HTS)

Connect

Use an HDMI cable to connect a Home Theatre System (HTS) to the TV. You can connect a Philips Soundbar or an HTS with a built-in disc player.

Alternatively, you can use a SCART cable if the device has no HDMI connection.

HDMI ARC

If your Home Theatre System has an HDMI ARC connection, you can use any HDMI connection on the TV to connect. All HDMI connections on the TV can offer the Audio Return Channel (ARC) signal. But once you connected the Home Theatre System, the TV can only send the ARC signal to this HDMI connection.

With HDMI ARC, you do not need to connect the extra audio cable. The HDMI ARC connection combines both signals.

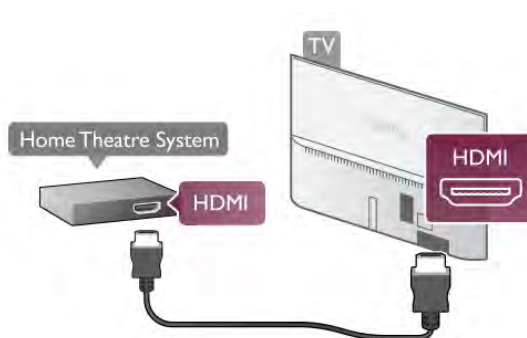

If the Home Theatre System has no HDMI ARC connection, add an optical audio cable to send the sound of the TV picture to the Home Theatre System.

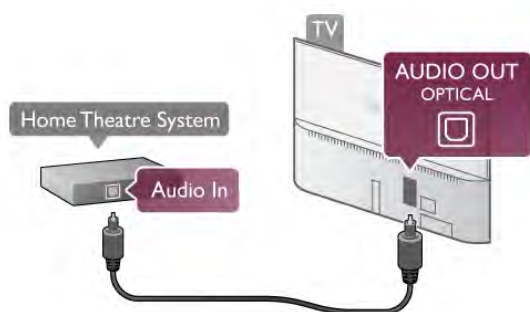

Audio to video synchronisation (sync)

If the sound does not match the video on screen, you can set a delay on most DVD Home Theatre Systems to match the sound and video. A mismatch can be visible in scenes with people talking - when they finish sentences before their lips stop moving or just the opposite.

In **Help**, press **■** **List** and look up **Audio to video sync** for more information.

Audio Out settings

Audio Out delay

With a Home Theatre System (HTS) connected to the TV, the picture on TV and the sound from the HTS should be synchronised. A mismatch can be visible in scenes with people talking - when they finish sentences before their lips stop moving or just the opposite.

Automatic audio to video sync

With recent Philips Home Theatre Systems, the audio to video sync is automatically synchronised and always correct.

Audio sync delay

For some Home Theatre Systems you might need to adjust the audio sync delay to synchronise the audio to video. On the HTS, increase the delay value until there is a match between picture and sound. A delay value of 180ms may be required. Read the user manual of the HTS. With a delay value set up on the HTS, you need to switch off Audio Out delay on the TV.

To switch off the Audio Out delay . . .

- 1 - Press **■** and select **⚙ Setup** and press **OK**.
- 2 - Select **TV settings > Sound > Advanced > Audio Out delay**.
- 3 - Select **Off** and press **OK**.
- 4 - Press **➔**, repeatedly if necessary, to close the menu.

Audio Out offset

If you cannot set a delay on the Home Theatre System, you can set the TV to sync the sound. You can set an offset that compensates the time necessary for the Home Theatre System to process the sound of the TV picture. You can set the value in steps of 5ms. Maximum setting is -60ms. The Audio Out delay setting should be switched on.

To synchronise the sound on the TV . . .

- 1 - Press **■** and select **⚙ Setup** and press **OK**.
- 2 - Select **TV settings > Sound > Advanced > Audio Out offset**.
- 3 - Use the slider bar to set the sound offset and press **OK**.
- 4 - Press **➔**, repeatedly if necessary, to close the menu.

Audio Out format

If you have a Home Theatre System (HTS) with multichannel sound processing capabilities like Dolby Digital, DTS® or similar, set the Audio out format to Multichannel. With Multichannel, the TV can send the compressed multichannel sound signal from a TV channel or connected player to the Home Theatre System. If you have a Home Theatre System without multichannel sound processing, select Stereo.

To set the Audio Out format . . .

- 1 - Press **■** and select **⚙ Setup** and press **OK**.
- 2 - Select **TV settings > Sound > Advanced > Audio Out format**.
- 3 - Select **Multichannel** or **Stereo**.
- 4 - Press **➔**, repeatedly if necessary, to close the menu.

Audio Out leveling

Use the Audio Out leveling setting to level the volume (loudness) of the TV and the Home Theatre System when you switch over from one to another. Volume differences can be caused by differences in sound processing.

To level the difference in volume . . .

- 1 - Press **■** and select **⚙ Setup** and press **OK**.
- 2 - Select **TV settings > Sound > Advanced > Audio Out leveling**.
- 3 - If the volume difference is large, select **More**. If the volume difference is small, select **Less**.
- 4 - Press **➔**, repeatedly if necessary, to close the menu.

Audio Out leveling affects both the Audio Out - Optical and HDMI-ARC sound signals.

Troubleshooting

Sound with loud noise

If you watch a video from a plugged in USB flash drive or connected computer, the sound from your Home Theatre System might be distorted. This noise is there when the audio or video file has DTS sound but the Home Theatre System has no DTS sound processing. You can fix this by setting the **Audio Out format** of the TV to **Stereo**. Go to **Home > Setup > TV settings > Sound > Advanced > Audio Out format**

No sound

If you cannot hear the sound from the TV on your Home Theatre System, check the following . . .

- Check if you connected the HDMI cable to a HDMI ARC connection on the Home Theatre System. All HDMI connections on the TV are HDMI ARC connections.
- Check if the **HDMI ARC** setting on the TV is switched **On**. Go to **Home > Setup > TV settings > Sound > Advanced > HDMI ARC**

Blu-ray Disc Player

Use a **High speed HDMI** cable to connect the Blu-ray Disc player to the TV.

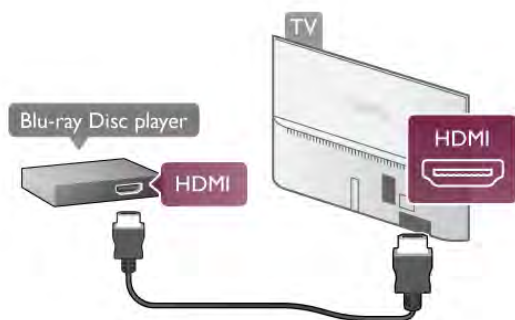

If the Blu-ray Disc player has EasyLink HDMI CEC, you can operate the player with the TV remote control. In **Help**, press **List** and look up **EasyLink HDMI CEC** for more information.

DVD Player

Use an HDMI cable to connect the DVD player to the TV. Alternatively, you can use a SCART cable if the device has no HDMI connection.

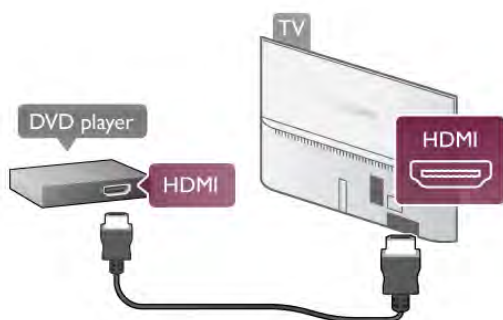

If the DVD player is connected with HDMI and has EasyLink HDMI CEC, you can operate the player with the TV remote control. In **Help**, press **List** and look up **EasyLink HDMI CEC** for more information.

Game console

HDMI

You can connect a game console to the TV. You can use an HDMI, YPbPr or SCART connection.

For best quality, use an **High speed HDMI** cable to connect the game console to the TV.

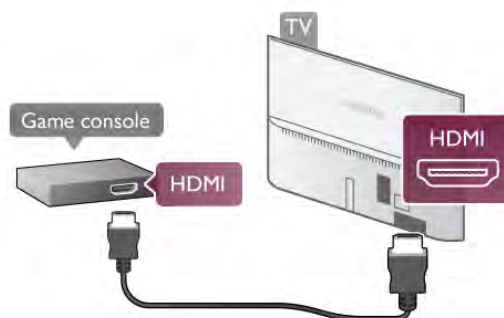

If the game console is connected with HDMI and has EasyLink HDMI CEC, you can operate the game console with the TV remote control.

Audio Video LR / Scart

You can connect a game console to the TV. If your game console only has Video (CVBS) and Audio L/R output, use a Video Audio L/R to SCART adapter to connect to the SCART connection.

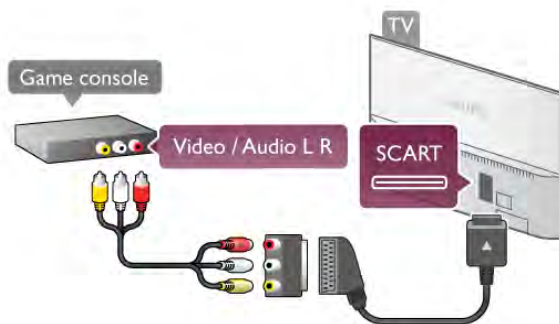

USB Hard Drive

What you need

If you connect a USB Hard Drive, you can pause or record a TV broadcast. The TV broadcast must be a digital broadcast (DVB broadcast or similar).

To pause

To pause a broadcast, you need a USB 2.0 compatible Hard Drive with a minimum of 32GB Hard Drive space.

To record

To pause or record a broadcast, you need a Hard Drive with a minimum of 250GB Hard Drive space.

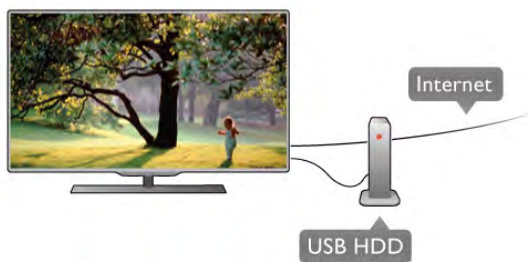

TV guide

Before you decide to buy a USB Hard Drive to record, you can check if you can record digital TV channels in your country. Press **Guide** on the remote control. If there is a Record button on the TV guide page, you can record programmes from digital TV channels.

In **Help**, press **Red List** and look up **USB Hard Drive, Installation** to install a USB Hard Drive on this TV.

Installation

Before you can pause or record a broadcast, you must connect and format a USB Hard Drive. If you want to record a broadcast with TV guide data from the Internet, you need to have the Internet connection installed on your TV before you install the USB Hard Drive.

1 - Connect the USB Hard Drive to one of the **USB** connections on the TV. Do not connect another USB device to the other USB ports when formatting.



2 - Switch on the USB Hard Drive and the TV.

3 - When the TV is tuned to a digital TV channel, press **II** (Pause). Trying to pause will start the formatting. Formatting removes all files from the connected USB Hard Drive.

Follow the instructions on screen.

When the USB Hard Drive is formatted, leave it connected permanently.

Warning

The USB Hard Drive is formatted exclusively for this TV, you cannot use the stored recordings on another TV or PC. Do not copy or change recording files on the USB Hard Drive with any PC application. This will corrupt your recordings. When you format another USB Hard Drive, the content on the former will be lost. A USB Hard Drive installed on your TV will need reformatting for use with a computer.

In **Help**, press **Red List** and look up **Pause TV** or **Recording** to pause or record TV channels.

USB keyboard or mouse

USB keyboard

Connect a USB keyboard (USB-HID type) to enter text on your TV.

You can connect a keyboard and a mouse to the TV. Use one of the **USB** connections of the TV to connect.



Install the keyboard

To install the USB keyboard, switch on the TV and connect the USB keyboard to one of the **USB** connections on the TV. When the TV detects the keyboard for the first time, you can select your keyboard lay-out and test your selection.

If you select a Cyrillic or Greek keyboard lay-out first, you can select a secondary Latin keyboard lay-out.

To change the keyboard lay-out setting later on, press **Home** and select **Setup** and press **OK**.

Select **TV settings > General settings > USB mouse and keyboard > Keyboard settings** and press **OK**.

Keys for channel renaming

- Enter **↵** = OK
- Backspace **←** = delete character before cursor
- Arrow keys = navigate within a text field
- To switch between keyboard lay-outs, if a secondary lay-out is set, press the **Alt + Shift** keys simultaneously.

Keys for Smart TV Apps and Internet pages

- **Tab** and **Shift Tab** = Next and Previous
- **Home** = scroll to the top of the page
- **End** = scroll to the bottom of the page
- **Page Up** = jump one page up
- **Page Down** = jump one page down
- **+** = zoom in one step
- **-** = zoom out one step
- ***** = fit to width

In **Help**, press **Red List** and look up **USB mouse**, to connect a USB mouse.

USB mouse

Connect

You can connect a USB mouse (USB-HID type) to navigate pages on the Internet.

On an Internet page, you can select and click on links more easily.



Connect the mouse

Switch the TV on and connect the USB mouse to one of the **USB** connections on the TV. You can also connect the USB mouse to a connected USB keyboard.

Mouse clicks

- **Left click** = OK
- **Right click** = Back ↩

You can use the scroll wheel to scroll pages up and down.

In **Help**, press **■ List** and look up **USB keyboard**, to connect a USB keyboard.

Speed

You can adjust the speed of the mouse, the speed of the mouse moving on screen.

To adjust the speed . . .

- 1 - Press **⬆ Home**, select **⚙ Setup** and press **OK**.
- 2 - Select **TV settings** and press **OK**.
- 3 - Select **General settings > Pointer and mouse speed** and press **OK**.
- 4 - Press the arrows **▲ (Up)** or **▼ (Down)** to increase or lower the speed.
- 5 - Press the arrow **▶ (Right)** to test the speed you set.
- 6 - Press the arrow **◀ (Left)** to return to the setting. You can adjust the setting again.
- 7 - Press **OK** to store and close the setting.
- 8 - Press **↩**, repeatedly if necessary, to close the menu.

USB flash drive

You can view photos or play your music and videos from a connected USB flash drive.

Insert a USB flash drive in one of the **USB** connections on the TV while the TV is switched on.



The TV detects the flash drive and opens a list showing its content.

If the contents list does not appear automatically, press **➔ SOURCE**, select **USB** and press **OK**.

To stop watching the USB flash drive content, press **Ⓜ TV** or select another activity.

To disconnect the USB flash drive, you can pull out the flash drive anytime.

In **Help**, press **■ List** and look up **Videos, photos and music**, to watch or listen to content from a USB flash drive.

Photo camera

To view photos stored on your digital photo camera, you can connect the camera directly to the TV.

Use one of the **USB** connections on the TV to connect. Switch on the camera after you made the connection.



If the contents list does not appear automatically, press **➔ SOURCE**, select **USB** and press **OK**.

Your camera might need to be set to transfer its content with PTP (Picture Transfer Protocol). Read the user manual of the digital photo camera.

In **Help**, press **■ List** and look up **Videos, photos and music** for more information on viewing photos.

Camcorder

You can use an HDMI, YPbPr or SCART connection to connect your camcorder. If your camcorder only has Video (CVBS) and Audio L/R output, use a Video Audio L/R to SCART adapter to connect to the SCART connection.

For best quality, use an HDMI cable to connect the camcorder to the TV.



Or use a SCART adapter to connect the camcorder to the TV.



Computer

You can connect your computer to the TV and use the TV as a PC monitor.

With HDMI

Use an HDMI cable to connect the computer to the TV.

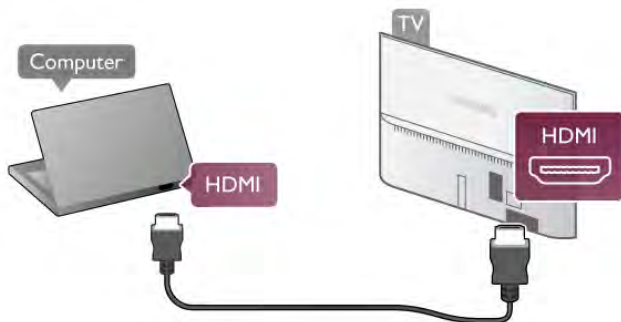

With DVI to HDMI

Alternatively, you can use a DVI to HDMI adapter to connect the PC to **HDMI** and an audio L/R cable to **AUDIO IN L/R** on the back of the TV.

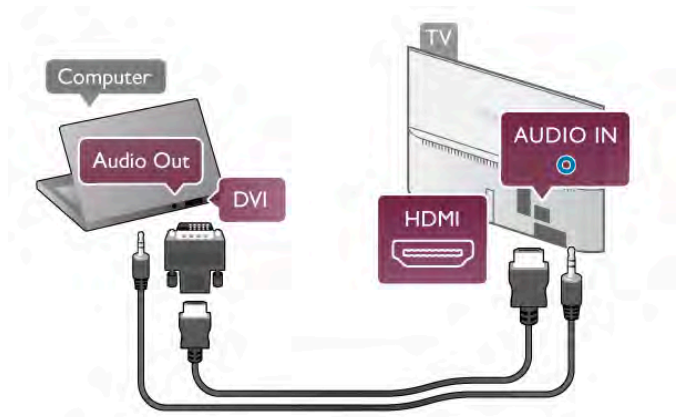

Ideal monitor setting

If your computer is added as a **Computer** type of device in the Source menu (list of connections), the TV is set to the ideal **Computer** setting automatically.

If you use your computer to watch movies or use it to play games, you might want to set the TV back to the ideal TV watching or gaming setting.

To set the TV to the ideal setting manually . . .

- 1 - Press **Home**, select **Setup** and press **OK**.
- 2 - Select **TV settings** > **Picture** > **Game or computer** and press **OK**.
- 3 - Select **Game** (for gaming) or select **Off** (for watching a movie) and press **OK**.
- 4 - Press **Back**, repeatedly if necessary, to close the menu. Remember to set the Game or computer setting back to **Computer** when you stop playing the game.

Picture format - Unscaled

Additionally, you can also set the Picture format to Unscaled - an expert pixel for pixel display mode (black bars may appear).

- 1 - Press **Options** and select **Options** in the menu bar.
- 2 - Select **Picture format** > **Unscaled** and press **OK**.

In **Help**, press **List** and look up **Display resolutions**, for an overview of the supported PC resolutions.

Headphones

You can connect a set of headphones to the **Headphones** connection on the TV. The connection is a mini-jack 3.5mm. You can adjust the volume of the headphones separately.

To adjust the volume . . .

- 1 - Press **Options** and select **Picture and sound** in the menu bar.
- 2 - Press **Down** and select **Headphones volume** and press **OK**.
- 3 - Press **Up** (up) or **Down** (down) to adjust the volume.
- 4 - Press **Back**, repeatedly if necessary, to close the menu.



2.8

Setup menu

Quick picture settings

With Quick picture settings you can set your basic picture preferences in a few easy steps. The settings you made are stored under the Picture style - **Personal**. You can return to your picture preference if some settings were changed. You can set a preferred picture setting for every TV activity or connected device individually.

To return to your preferred picture setting, while watching a TV channel, press **⏏** **OPTIONS**, select **🔊** **Picture and sound** in the menu bar, select **Picture style** and select **Personal**.

To set a Quick picture setting . . .

- 1 - Press **🏠**, select an activity or a connected device (or its connection) and press **OK**.
- 2 - Press **🏠** again, select **⚙️** **Setup** and press **OK**.
- 3 - Select **Quick picture settings** and press **OK**. Go through the steps and finish. The activity or connection has your personal preferences.

In **Help**, press **📄** **List** and look up **Picture style**, for more information.

TV settings

In the **TV settings** menu you can set all **Picture**, **3D**, **Sound** and **Ambilight** settings. The item **General settings** in the menu holds a collection of settings like **Menu language**, **Sleep timer**, **Switch off timer**, **Universal access** and more.

In **Help**, press **📄** **List** and look up the topic or setting you need.

Search for channels

In **Help**, press **📄** **List** and look up **Channel, update** or **Channels, reinstall**, for more information.

Channel settings

Languages

In **Help**, press **📄** **List** and look up **Audio language** or **Subtitles** for more information.

Universal access

In **Help**, press **📄** **List** and look up **Universal access** for more information on setting up the TV for visually and hearing impaired users.

Channel installation

In **Help**, press **📄** **List** and look up **Automatic channel update** or **Channel update message**. Also look up **Manual installation** for installing analogue channels or **DVB** to switch the antenna connection.

Child lock

In **Help**, press **📄** **List** and look up **Child lock** for more information.

Search for satellite

In **Help**, press **📄** **List** and look up **Satellite, installation** for more information.

Satellite settings

Languages

In **Help**, press **📄** **List** and look up **Audio language** or **Subtitles** for more information.

Channel installation

In **Help**, press **📄** **List** and look up **Satellite, automatic channel update** or **Satellite, channel update message** or **Satellite, automatic update options** for more information.

Child lock

In **Help**, press **📄** **List** and look up **Satellite, channel lock** for more information.

Connect to network

In **Help**, press **📄** **List** and look up **Network, wireless** or **Network, wired**, for more information.

Network settings

In **Help**, press **📄** **List** and look up **Network, settings**, for more information.

Update software

In **Help**, press **■ List** and look up **Software, Internet update** or **Software, USB update**, for more information.

Software settings

In **Help**, press **■ List** and look up **Software, current version**, for more information.

Watch demos

With **Watch demos** in the **Setup** menu, you can watch some demonstration videos of some of the picture quality features of your TV.

Active control

The TV monitors the incoming picture quality, the level of motion in the picture, brighter or darker scenes and the light conditions in your room. With these values, the TV adjusts the picture for best performance.

2.9

Safety and care

Safety

Read me

Read and understand all safety instructions before you use the TV. If damage is caused by failure to follow instructions, the warranty does not apply.

Risk of electric shock or fire!

- Never expose the TV to rain or water. Never place liquid containers, such as vases, near the TV. If liquids are spilt on or into the TV, disconnect the TV from the power outlet immediately. Contact Consumer Care to have the TV checked before use.
- Never expose the TV, remote control or batteries to excessive heat. Never place them near burning candles, naked flames or other heat sources, including direct sunlight.
- Never insert objects into the ventilation slots or other openings on the TV.
- Never place heavy objects on the power cord.
- Avoid force coming onto power plugs. Loose power plugs can cause arcing or fire. Ensure that no strain is exerted on the power cord when you swivel the TV screen.

- To disconnect the TV from the mains power, the power plug of the TV must be disconnected. When disconnecting the power, always pull the power plug, never the cord. Ensure that you have full access to the power plug, power cord and outlet socket at all times.
-

Risk of injury or damage to the TV!

- Two people are required to lift and carry a TV that weighs more than 25 kg or 55 lbs.
- If you mount the TV on a stand, only use the supplied stand. Secure the stand to the TV tightly. Place the TV on a flat, level surface that can support the weight of the TV and the stand.
- When wall mounted, ensure that the wall mount can safely bear the weight of the TV set. TP Vision Netherlands B.V. bears no responsibility for improper wall mounting that results in accident, injury or damage.
- Parts of this product are made of glass. Handle with care to avoid injury or damage.

Risk of damage to the TV!

Before you connect the TV to the power outlet, ensure that the power voltage matches the value printed on the back of the TV. Never connect the TV to the power outlet if the voltage is different.

Risk of injury to children!

Follow these precautions to prevent the TV from toppling over and causing injury to children:

- Never place the TV on a surface covered by a cloth or other material that can be pulled away.
- Ensure that no part of the TV hangs over the edge of the mounting surface.
- Never place the TV on tall furniture, such as a bookcase, without anchoring both the furniture and TV to the wall or a suitable support.
- Teach children about the dangers of climbing on furniture to reach the TV.

Risk of swallowing batteries!

The remote control may contain coin-type batteries which can easily be swallowed by small children. Keep these batteries out of reach of children at all times.

Risk of overheating!

Never install the TV in a confined space. Always leave a space of at least 10 cm or 4 inches around the TV for ventilation. Ensure curtains or other objects never cover the ventilation slots on the TV.

Lightning storms

Disconnect the TV from the power outlet and antenna before lightning storms. During lightning storms, never touch any part of the TV, power cord or antenna cable.

Risk of hearing damage!

Avoid using earphones or headphones at high volumes or for prolonged periods of time.

Low temperatures

If the TV is transported in temperatures below 5°C or 41°F, unpack the TV and wait until the TV temperature reaches room temperature before connecting the TV to the power outlet.

Lightning storms

Disconnect the TV from the power outlet and antenna before lightning storms. During lightning storms, never touch any part of the TV, power cord or antenna cable.

Risk of hearing damage!

Avoid using earphones or headphones at high volumes or for prolonged periods of time.

Low temperatures

If the TV is transported in temperatures below 5°C or 41°F, unpack the TV and wait until the TV temperature reaches room temperature before connecting the TV to the power outlet.

Screen care

- Never touch, push, rub or strike the screen with any object.
 - Unplug the TV before cleaning.
 - Clean the TV and frame with a soft damp cloth and wipe gently. Avoid touching the Ambilight LEDs on the backside of the TV. Never use substances such as alcohol, chemicals or household cleaners on the TV.
 - To avoid deformations and colour fading, wipe off water drops as quickly as possible.
 - Avoid stationary images as much as possible. Stationary images are images that remain onscreen for extended periods of time. Stationary images include onscreen menus, black bars, time displays, etc. If you must use stationary images, reduce screen contrast and brightness to avoid screen damage.
-

Temperature and humidity

In rare occasions, depending on temperature and humidity, minor condensation can occur on the inside of the TV glass front (on some models). To prevent this, do not expose the TV to direct sunlight, heat or extreme humidity. If condensation occurs, it will disappear spontaneously while the TV is playing for a few hours. The condensation moisture will not harm the TV or cause malfunction.

TV

Switch on

Switch on and off

Make sure you plugged in the mains power on the back of the TV before you switch on the TV.

If the indicator light is off, press the small key  on the right side of the back of the TV to put the TV in standby - the indicator will light up.

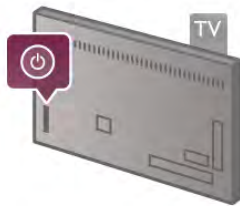

With the TV in standby, press  on the remote control to switch the TV on. Alternatively, you can use the **CH+**, **CH-** and **Home** key to switch the TV on.



Quick start

To switch on the TV faster than usual, you can set the TV in **Quick start** mode.

In **Help**, press  **List** and look up **Quick start** for more information.

Switch to standby

To switch the TV to standby, press  on the remote control.

Switch off

To switch the TV off, press the small key  on the right of the TV on the back. There is no indicator light. The TV is still connected to the mains power but consumes a minimum of energy. To switch off the TV completely, disconnect the power plug.

When disconnecting the power plug, always pull the power plug, never the cord. Ensure that you have full access to the power plug, power cord and outlet socket at all times.



Quick start

With Quick start, the TV can start up faster than usual. When you switch the TV on from standby the TV picture already appears after a few seconds, if Quick start is activated.

The TV can remember your daily habit of watching TV. Some time before you usually switch on the TV, Quick start will activate automatically, allowing you to switch on quickly. Alternatively, you can select up to 3 fixed time frames a day during which the TV is ready to switch on quickly.

When you switch the TV back to standby, Quick start remains active until the set time frame ends.

Activate

To set the Quick start activation, press  and select  **Setup** and press **OK** to open the Setup menu. Select **TV settings** > **General settings** > **Quick start** > **Activation**. You can select Automatic or Manual.

- Automatic

Select **Automatic** to activate Quick start automatically. The TV remembers your watching habit and activates Quick start during these time frames. With Automatic, the TV can set up to 4 time frames of 1 hour.

- Manual

Select **Manual** to activate Quick start during 3 fixed time frames a day. As an example, you can set a time frame in the morning, one at noon and one in the evening. For each time frame, you can set the time span yourself.

If Quick start is set to Manual, you can also select a **Standby delay**. With Standby delay, you can set the TV to keep Quick start active for some time after you switched the TV to standby. You can set the delay to up to 1 hour in steps of 15 minutes.

Specifics

The TV clock has to work properly to activate Quick start. Quick start activation cannot be longer than a 4 hour time frame.

Quick start increases the energy consumption during standby.

Remote control

Top

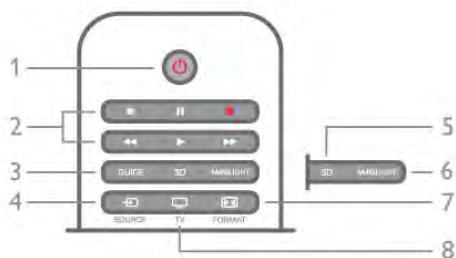

1 - Standby

To switch the TV on or back to standby.

2 - Playback and record keys

- Play , to playback
- Pause , to pause playback
- Stop , to stop playback
- Rewind , to rewind
- Fast Forward , to wind fast forward
- Record , to record now

3 - GUIDE

To open or close the TV guide.

4 - SOURCE

To open or close the list of connections.

5 - 3D

To open or close the 3D menu.

6 - AMBILIGHT

To switch Ambilight on or off and to switch Ambilight on in standby.

7 - FORMAT

To open or close the Format menu.

8 - TV

To switch back to watching channels.

Middle



1 - Home

To open or close the home menu.

2 - LIST

To open or close the channel list or your list of photos, music or videos.

3 - EXIT

To quit an interactive TV application, like Hbb TV.

4 - Back

To switch back to the previous channel you selected. To close a menu without changing a setting. To go back to the previous Smart TV Internet page.

5 - SMART TV

To open the Smart TV start page.

6 - INFO

To open or close Info.

7 - OK key

To confirm a selection.

8 - Arrow keys

To navigate up, down, left or right.

8 - OPTIONS

To open or close the Options menu.

Bottom

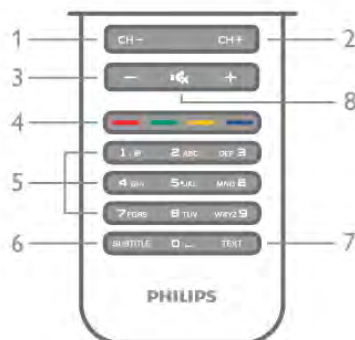

1 - CH-, Channel - / Previous page

To switch to the previous channel in the channel list, the previous page in Text or the previous chapter on a disc.

2 - CH+, Channel + / Next page

To switch to the next channel in the channel list, the next page in Text or the next chapter on a disc.

3 - Volume - and +

To adjust the volume level.

4 - Colour keys

Direct selection of options. Blue key information on what is selected and direct link to Help.

5 - Number keys and text keypad

To select a TV channel directly or to enter text.

6 - SUBTITLE

To switch subtitles on, off or on during mute.

7 - TEXT

To open or close Text.

8 - Mute

To mute the sound or to restore it.

Keyboard

Overview

Qwerty and Azerty

Overview of a Qwerty / Azerty keyboard.*

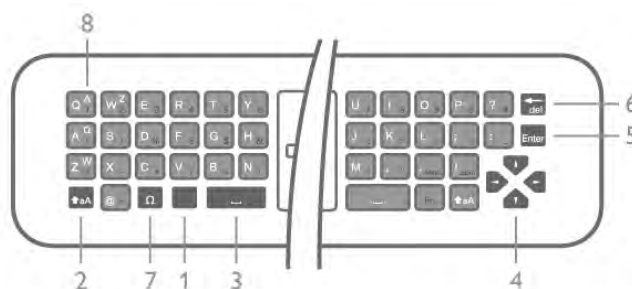

1 - Fn key - To type a number or punctuation character.

2 - Shift - To type uppercase letters.

3 - Spacebar

4 - Arrows for navigation.

- 5 - **Enter** - To confirm the text you entered.
- 6 - **Backspace** - Deletes the character in front of the text cursor.
- 7 - **Ω Special character** - To open the onscreen keyboard to select accented letters or symbols.
- 8 - **Azerty letter** - Letters available if the keyboard layout is set to Azerty in the Setup menu.

* Your remote control has a Qwerty / Azerty or a Qwerty / Cyrillic keyboard, depending on your region.

Qwerty and Cyrillic

Overview of a Qwerty / Cyrillic keyboard.*

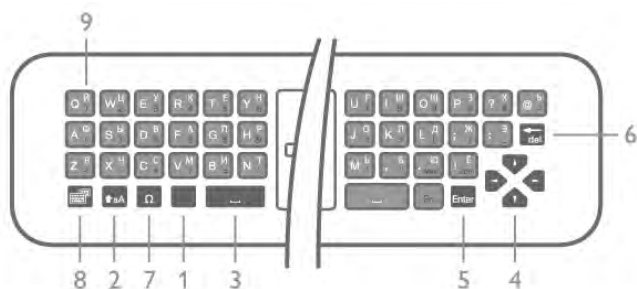

- 1 - **Fn key** - To type a number or punctuation character.
- 2 - **↑aA Shift** - To type uppercase letters.
- 3 - **␣ Spacebar**
- 4 - **Arrows** for navigation.
- 5 - **Enter** - To confirm the text you entered.
- 6 - **Backspace** - Deletes the character in front of the text cursor.
- 7 - **Ω Special character** - To open the onscreen keyboard to select accented letters or symbols.
- 8 - **Ⓢ Cyrillic keyboard switch** - To switch to the Cyrillic keyboard or back to Qwerty.
- 9 - **Cyrillic letter** - Letters available if the keyboard is switched to Cyrillic.

* Your remote control has a Qwerty / Azerty or a Qwerty / Cyrillic keyboard, depending on your region.

Writing text

With the keyboard on the back of the remote control, you can write text in any text field on screen. Turn the keyboard facing upwards to activate the keyboard keys. Hold the remote control with two hands and type with both thumbs.

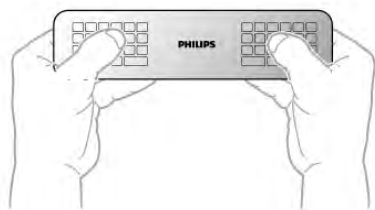

Enter text

To enter text in a text field on screen, select the text field and start typing. Press **Enter** to confirm the text.

Uppercase and lowercase

To type an uppercase letter, press the **↑aA** (Shift) key just before you type the letter.

To type several uppercase letters consecutively, press and hold the **↑aA** key while typing. To type uppercase constantly, press the **↑aA** key for 2 seconds to switch the keyboard in uppercase mode.

To switch out of uppercase mode, press the **↑aA** key again. If no keys are pressed for 20 seconds, the uppercase mode switches off automatically. Also, if you press another modifier key, like **Fn** or **Ω**, you switch out of uppercase mode.

Numbers and punctuation characters

To type a number or punctuation character, press the **Fn** key just before you type the number or punctuation character you need. You can switch the Fn mode on or off as you do for the uppercase mode.

Internet

You can use the **Fn** key to enter **www.** or **.com**.

Accented letters and symbols

Accented letters and symbols are not available on the remote control keyboard. To type such a character, you can open the onscreen keyboard.

To open the onscreen keyboard, press **Ω**. In the onscreen keyboard, you can navigate to the character you need. Switch the keyboard layout with the colour keys. Press **OK** to enter a character. The onscreen keyboard disappears when you press a character on the remote control keyboard.

Alternatively, you can enter special characters with the remote control SMS/text keypad on the front of the remote control.

Qwerty, Azerty and Cyrillic keyboard

The standard layout of the remote control keyboard is Qwerty.

Azerty keyboard

Depending on your region, the remote control keyboard can be set to Azerty. The Azerty characters are shown at the top right of the relevant keys.

To set the keyboard layout to Azerty, . . .

- 1 - Press **⏠** and select **⚙️ Setup** and press **OK** to open the Setup menu.
- 2 - Select **TV settings > General settings > Remote control keyboard**.
- 3 - Select **QWERTY** or **AZERTY**.

Cyrillic keyboard

Depending on your region, the remote control keyboard can be switched to Cyrillic characters.

The Cyrillic characters are shown at the top right of the keyboard keys.

To write Cyrillic characters, press **Ⓢ** on the remote control. Press **Ⓢ** again to switch back to Qwerty.

Pointer

About pointer

Instead of navigating the screen with the arrow keys, you can use the pointer. You can move the pointer - a blue arrow - over the TV screen by moving the remote control. Just like you move the cursor on a computer screen with a mouse.

You can use the pointer to navigate **Smart TV Apps*** and **Internet pages** on TV. Some Smart TV Apps might not support the use of the pointer. When the pointer is not available, you can use the arrow keys to navigate the screen. You can adjust the speed of the pointer or if you never want to use the pointer, you can switch it off.

*Gradually more Smart TV Apps will become available for use with the pointer.

Using the pointer

When you open the Smart TV start page, the pointer is shown in the middle of the TV screen.

Put your thumb on the **OK** key - do not press it - and move the remote control from the wrist, no need to move your arm. You can let go of the OK key and leave the pointer where it is. You can move the remote control and pick up the pointer again when you put your thumb back on the OK key.

When you press an arrow key to navigate, the pointer disappears. To recall the pointer, put your thumb on the OK key and briefly jiggle the remote control.



When you hover the pointer over a link . . .

- 1 - The pointer lights up.
- 2 - Press **OK** to open the link.

When you hover the pointer over a text field . . .
Press **OK** to enter text.

Speed

You can adjust the speed of the pointer, the speed at which the pointer moves on screen.

To adjust the speed . . .

- 1 - Press **Home**, select **Setup** and press **OK**.

- 2 - Select **TV settings** and press **OK**.

- 3 - Select **General settings** > **Pointer and mouse speed** and press **OK**.

- 4 - Press the arrows **▲** (Up) or **▼** (Down) to increase or lower the speed.

- 5 - Press the arrow **▶** (Right) to test the speed you set.

- 6 - Press the arrow **◀** (Left) to return to the setting. You can adjust the setting again.

- 7 - Press **OK** to store and close the setting.
-

Switch off

If you want to navigate the Smart TV and Internet pages with the arrow keys only, you can switch off the pointer.

To switch off the pointer . . .

- 1 - Press **Home**, select **Setup** and press **OK**.

- 2 - Select **TV settings** and press **OK**.

- 3 - Select **General settings** > **Remote control pointer** and select **Off**.

- 4 - Press **Back**, repeatedly if necessary, to close the menu.
-

IR Sensor

The remote control of the TV uses RF (radio frequency) to send its commands to the TV. With RF, you do not need to point the remote control at the TV.

However, the TV can also receive commands from a remote control that uses IR (infrared) to send commands. If you use such a remote control, always make sure you point the remote control at the infrared sensor on the front of the TV.



Pairing

This remote control uses radio frequency (RF) to send its commands to the TV. Contrary to remote controls using infrared signals, with this remote control you can send commands without pointing at the TV.

With no need to point the remote control, using the keyboard on the back or sending commands from another room - changing the volume or switching channels - is easy. Additionally, the TV can notify you when the battery power of the remote control is low.

Pairing the remote control

For the remote control to communicate with the TV, both TV and remote control should be paired with each other. Once paired, you cannot use the remote control to control another TV.



When you started the initial TV installation, the TV invited you to press the **OK** key, and by doing so, the pairing was done. When you switch off the TV, the pairing is stored. You can pair up to 5 remote controls with this TV.

Pairing again

You can pair another remote control with this TV.

The method to pair a remote control is different for a remote control already paired with another TV compared with a remote control that is not paired yet.



- **The remote control is paired with another TV**

To pair, hold the Remote control close to the Philips logo (about 10cm) and press the  Red and  Blue key at the same time. A message will appear if pairing is successful.

- **The remote control is not paired yet**

To pair, hold the Remote control close to the Philips logo (about 10cm) and press **OK**. A message will appear if pairing is successful.

For retail

To pair a new - not yet paired - TV with a remote control which is already paired with another TV, hold the Remote control close to the Philips logo (about 10cm) and press the  Red and  Blue key at the same time. A message will appear if pairing is successful.

Batteries

The TV will notify you when the battery power of the remote control is low.

To replace the batteries, open the battery compartment on the keyboard side of the remote control.

- 1 - Use a toothpick or other small, blunt object and press the small, square shaped release button to open the lid.
- 2 - Press the small lever next to the blue clip to release the clip.
- 3 - Replace the old batteries with 2 type AAA-LR03-1.5V alkaline batteries. Make sure the + and the - ends of the batteries line up correctly.
- 4 - Press the blue clip down until it clicks.
- 5 - Reposition the battery cover and press it until it clicks.

Put the remote control down for about 15 seconds to calibrate the pointer.

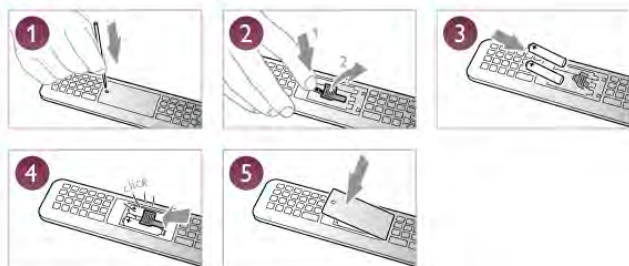

Remove the batteries if you are not using the remote control for a long time.

Dispose of batteries according to the end of use directives. In **Help**, press  **List** and look up **End of use** for more information.

Cleaning

Your remote control is treated with a scratch-resistant coating.

To clean the remote control, use a soft damp cloth. Never use substances such as alcohol, chemicals or household cleaners on the remote control.

3.3

TV channels

Watching TV channels

Switch channels

To watch TV channels, press  **TV**. The TV tunes to the TV channel you last watched.

Alternatively, press  to open the Home menu and select **Watch TV** and press **OK**.



Switch channels

To switch channels, press **CH+** or **CH-**. If you know the channel number, type in the number with the number keys. Press **OK** after you entered the number to switch channel. To switch back to the previously tuned channel, press .

To switch to a channel from a channel list

While watching a TV channel, press  **LIST** to open the channel lists.

Select a list in the row of tabs.



In a channel list, navigate to a TV channel or radio station. With the highlight on its icon, press **OK** to switch to the TV channel or listen to the radio station.

The channel list can have several pages with channels. To view the next or previous page, press **CH-** or **CH+**.

To close the channel lists without switching channel, press  **LIST** again.

Radio channels

If digital broadcasting is available, digital radio stations are installed during installation. Switch to a radio channel just like you switch to a TV channel. A Cable (DVB-C) channel installation usually places radio stations from channel number 1001 onwards.

Options on channels

While watching a channel, depending on the type of channel (analogue or digital) you are watching or depending on the TV settings you made, some options are available.

Open the options

While watching a channel, press **≡** **OPTIONS** and select the **≡** **Options** tab in the menu bar.



Universal access

With Universal access switched on, you can set some options for hearing impaired and visually impaired people.

In **Help**, press **■** **List** and look up **Universal access** for more information.

Video selection

Digital TV channels can offer multi video signals (multi-feed broadcasts), different camera viewpoints or angles of the same event or different programmes on one TV channel. The TV shows a message if any such TV channels are available.

Subtitles

Switch **Subtitles on** or **Subtitles off** with this option. Select **On during mute** to show subtitles only when the sound is muted with **🔇**.

Subtitle language

For digital broadcast, you can select an available subtitle language temporarily if none of your preferred languages are available.

In **Help**, press **■** **List** and look up **Subtitles** for more information.

Audio languages

For digital broadcast, you can select an available audio language temporarily if none of your preferred languages are available.

In **Help**, press **■** **List** and look up **Audio languages** for more information.

Dual I-II

If an audio signal contains two audio languages but one language - or both - has no language indication, this option is available.

Common interface

If prepaid premium content is available from a CAM, you can set the provider settings with this option.

HbbTV on this channel

You can block the HbbTV pages from a channel that offers HbbTV.

In **Help**, press **■** **List** and look up **HbbTV** for more information.

Status

Select **Status** to view technical information on the channel (if it is analogue or digital) or a connected device you are watching.

Channel lists

The channel lists

In the channel lists, you can find all installed TV and radio channels.

Next to the channel list **All**, which holds all installed channels, you can set up a list of **Favourites**, view the installed **Radio** stations separately or discover the newly added channels in **New**.

To switch to a channel from a channel list

While watching a TV channel, press **≡** **LIST** to open the channel lists.

Select one of the channel lists.



In a channel list, navigate to a channel or radio station. With the highlight on its icon, press **OK** to switch to the channel or listen to the radio station.

The channel list can have several pages with channels. To view the next or previous page, press **CH-** or **CH+**.

To close the channel lists without switching channel, press **≡** **LIST** again.

Mark as favourite

In the channel list **All**, you can set any channel as a favourite channel.

Navigate to the channel in the list and press **■** **Mark as favourite**. The channel is added to the Favourite channel list.

Channel list options

According to the channel list on screen, press **≡** **OPTIONS** to select the following options:

- Digital / Analogue
- Free / Scrambled
- Lock or Unlock



Channel logos

In some countries, the TV can show the channel logos. If you do not want these logos to appear, you can switch them off. To switch off **Channel logos** . . .

- 1 - Press **Home**, select **Setup** and press **OK**.
- 2 - Select **TV settings** > **General settings** > **Channel logos** and press **OK**.
- 3 - Select **Off** and press **OK**.
- 4 - Press **Back**, repeatedly if necessary, to close the menu.

Rename channels

You can rename channels in the channel list.

- 1 - Select the channel you want to rename in one of the channel lists - **All**, **Favourites**, **Radio** or **New**.
- 2 - Press **Red** **Rename**. You can enter text with the remote control keyboard or open the on-screen keyboard.

With the remote control keyboard

To delete a character, position the cursor behind the character and press **# del**.

To enter a character, press the character on the keyboard. When you are ready, press **Enter** to select **Done**. Press **Enter** again to finish renaming.

For more information on using the keyboard, press **Red** **LIST** and look up **Remote control, keyboard**.

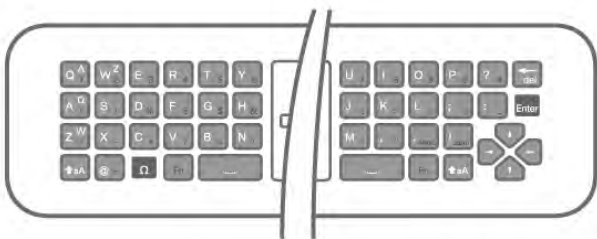

With the on-screen keyboard.

To open the on-screen keyboard, place the cursor in the name text field and press **OK**.

To delete the character in front of the cursor, press **Blue** **Backspace**.

To enter a character, select the character with the arrow keys and press **OK**.

To select uppercase letters, press **Green**.

To select numbers or special characters, press **Yellow**.

When you are ready, press **Back** to close the on-screen keyboard.

To finish renaming, select **Done** and press **OK**.

Reorder channels

You can reorder -reposition- channels in the Favourite channel list.

In **Help**, press **Red** **List** and look up **Favourite channels** for more information.

Favourite channels

You can create a favourite channel list that only holds the channels you want to watch. With the Favourite channel list selected, you will only see your favourite channels when you switch through channels.

Create your Favourite channel list

- 1 - While watching a TV channel, press **Menu** **LIST** to open the channel lists.
- 2 - Select **Favourites**.
- 3 - If the list is empty, the TV asks you to start adding channels right now. Press **OK**.
- 4 - Use the arrow keys to select a channel and press **OK** to make that channel a favourite channel. The order in which channels appear in the favourite list depends on the sequence in which you add them.
- 5 - Press **Red** **Done** to finish selecting favourite channels.

Add or remove favourites

To add or remove favourite channels from the Favourite channel list, open the list and press **Options**, select **Add / remove favourites** and press **OK**.

Use the arrow keys to select a channel and press **OK** to add or remove it from the favourites list.

Reorder

You can reorder -reposition- channels in the Favourite channels list.

- 1 - In the channel list **Favourites**, highlight the channel you want to reposition.
- 2 - Press **Green** **Move**.
- 3 - With the arrow keys, reposition the channel where you want it. Alternatively, you can enter the new position directly with the number keys.
- 4 - Press **OK** to confirm the position. Or, to cancel the repositioning, press **Red** **Cancel**.
You can highlight another channel and do the same.

Add or remove favourites in other channel lists

You can mark channels and radio stations as favourites from the **All**, **Radio** and **New** channel list.

In these lists, highlight a channel you want to add to the favourite list and press **Yellow** **Mark as favourite**. The channel is marked with a star **★** and added to the Favourite channel list. To unmark a favourite channel, highlight the channel in any channel list and press **Yellow** **Unmark as favourite**. The channel is removed from the Favourite channels list.



Child lock

To prevent children from watching a channel or a programme, you can lock channels or lock age rated programmes.

Lock a channel

You can lock a channel to prevent children from watching it. To watch a locked channel you need to enter the Child lock code. To lock a channel, while watching a TV channel, press **≡ LIST** to open the **Channel lists**. In any list, select the channel you want to lock, press **≡ OPTIONS** and select **Lock channel**. In a channel list, a locked channel is marked with a lock **🔒**. To unlock a channel, select the locked channel in the channel list and select the **Unlock channel** option. You will need to enter the Child lock code.

You cannot lock programmes from connected devices.

Parental rating

Some digital broadcasters have rated their programmes. When the rating is equal or higher than the rating you have set for your child's age, the programme will be locked. To watch a locked programme you must enter the child lock code. The parental age rating is set for all channels.

Set an age rating

Press **🏠** and select **⚙️ Setup** and press **OK**. Select **Channel settings > Child lock > Parental rating**. To select an age rating, you must first enter your 4-digit child lock code. If no child lock code is set, you can set the code now. When the code is entered, you can select the age rating. When the rating of a programme is equal or higher than the rating you have set for your child's age, the programme will be locked. The TV will ask for the code to unlock the programme. For some operators, the TV only locks programmes with a higher rating.

Set or change the code

To set the code or to change the current Child lock code, press **🏠**, select **⚙️ Setup** and press **OK**. Select **Channel settings > Child lock > Change code**. Enter the current code and then enter the new code twice. The new code is set.

Forgotten your code?

If you have forgotten your code to unlock, call Consumer Care in your country. Find the telephone number on the documentation that came with the TV or go to www.philips.com/support.

Channel installation

Update channels

Automatic update

If you receive digital channels, you can set the TV to automatically update the list with new channels. Alternatively, you can start a channel update yourself.

Automatic channel update

Once a day, at 6 AM, the TV updates the channels and stores new channels. New channels are stored in the All channels list but also in the New channels list. Empty channels are removed.

If new channels are found or if channels are updated or removed, a message is shown at TV start up. The TV must be in standby to automatically update channels.

To switch off the message at start up, press **🏠**, select **⚙️ Setup** and press **OK**.

Select **Channel settings** and press **OK**.

Select **Channel installation > Channel update message > Off**.

To switch off the Automatic channel update, press **🏠**, select **⚙️ Setup** and press **OK**.

Select **Channel settings** and press **OK**. Select **Channel installation > Automatic channel update > Off**.

Start an update

To start an update yourself, press **🏠**, select **⚙️ Setup** and press **OK**.

Select **Search for channels** and press **OK**.

Select **Update channels** and follow the instructions on screen.

The update may take a few minutes.

In certain countries, the Automatic channel update is done while watching TV or any moment when the TV is in standby.

New channels

New channels added with the automatic channel update are easy to find in the channel list **New**. The same new channels are also stored in the **All** or **Radio** channel list.

New channels are kept in the channel list New as long as you don't mark them as a favourite or tune to them.

In **Help**, press **📺 List** and look up **Favourite channels** for marking channels as favourites.

Reinstall channels

You can search for and reinstall channels and leave all other TV settings untouched. Alternatively, you can do a full new TV installation.

If a child lock code is set, you will need to enter this code before you can reinstall channels.

Reinstall channels

To reinstall the channels only . . .

1 - Press **🏠**, select **⚙️ Setup** and press **OK**.

2 - Select **Search for channels > Reinstall channels** and press **OK**.

3 - Select **Antenna (DVB-T)** or **Cable (DVB-C)**. The channel search may take a few minutes. Follow the instructions on screen.

Full installation

To redo a full TV installation . . .

1 - Press **🏠**, select **⚙️ Setup** and press **OK**.

2 - Select **TV settings** > **General settings** > **Reinstall TV** and press **OK**. The installation may take a few minutes. Follow the instructions on screen.

Factory settings

Factory settings sets the TV back to the original TV settings for picture, sound and Ambilight.

To switch back to the original Factory settings . . .

- 1 - Press **Home**, select **Setup** and press **OK**.
- 2 - Select **TV settings** > **General settings** > **Factory settings** and press **OK**.
- 3 - Press **OK** to confirm.
- 4 - Press **Back**, repeatedly if necessary, to close the menu.

Channel list copy

Introduction

Channel list copy is intended for dealers and expert users. In some countries, Channel list copy is only available for copying satellite channels.

With **Channel list copy**, you can copy the channels installed on one TV onto another Philips TV of the same range. With Channel list copy, you avoid the time-consuming channel search by uploading a predefined channel list on a TV. Use a USB flash drive of minimum 1 GB.

Conditions

- Both TVs are from the same year range.
- Both TVs have the same hardware type. Check the hardware type on the TV type plate on the back of the TV. Typically noted as Q . . . LA
- Both TVs have compatible software versions.

Current version

You can check the current version of the TV software with **Current software info** in **Setup** > **Software settings**.

Copy channel list

Copy a channel list

- 1 - Switch on the TV which has its channels installed. Plug in a USB memory device.
- 2 - Press **Home**, select **Setup** and press **OK**.
- 3 - Select **TV settings** > **General settings** > **Channel list copy** > **Copy to USB** and press **OK**. To copy the channel list from this TV, you might be asked to enter the Child lock code you entered during the installation.
- 4 - When copying is done, unplug the USB memory device.

Now you can upload the copied channel list onto another Philips TV.

Upload channel list

Upload a copied channel list

Depending on whether your TV is already installed or not, you must use a different way to upload a channel list.

To a TV that is not yet installed

1 - Plug in the power plug to start the installation and select language and country. You can skip Search for channels. Finish the installation.

2 - Plug in the USB memory device that holds the channel list of the other TV.

3 - To start the channel list upload, press **Home**, select **Setup** and press **OK**.

4 - Select **TV settings** > **General settings** > **Channel list copy** > **Copy to TV** and press **OK**. You might be asked to enter the Child lock code of this TV.

5 - The TV notifies you if the channel list is copied to the TV successfully. Unplug the USB memory device.

To an already installed TV

1 - Verify the country setting of the TV. (To verify this setting, press **Home**, select **Setup** and press **OK**. Select **Search for channels** > **Reinstall channels** and press **OK**. Press **Back** and later **Cancel** to leave the Search for channels.)

If the country is correct continue with step 2.

If the country is not correct, you need to start a reinstallation.

To start the reinstallation, press **Home**, select **Setup** and press **OK**. Select **TV settings** > **General settings** > **Reinstall TV** > **OK**. Select the correct country and skip the Search for channels. Finish the installation. When done, continue with step 2.

2 - Plug in the USB memory device that holds the channel list of the other TV.

3 - To start the channel list upload, press **Home**, select **Setup** and press **OK**.

4 - Select **TV settings** > **General settings** > **Channel list copy** > **Copy to TV** and press **OK**. You might be asked to enter the Child lock code of this TV.

5 - The TV notifies you if the channel list is copied to the TV successfully. Unplug the USB memory device.

DVB-T or DVB-C

DVB-T or DVB-C reception

If both DVB-T and DVB-C reception is available in your country and if this TV is ready to receive DVB-T and DVB-C for your country, you have selected one or the other during the channel installation.

If you want to change the DVB setting to start a new channel installation, press **Home**, select **Setup** and press **OK**.

Select **Channel settings** and press **OK**. Select **Channel installation** > **Antenna connection** > **Antenna (DVB-T)** or **Cable (DVB-C)** and press **OK**. Select the DVB setting you want.

DVB-C channel installation

For ease of use, all DVB-C settings are set to automatic.

If your DVB-C provider gave you specific DVB-C values, the network ID or network frequency, enter these values when the TV asks for them during installation.

It might be necessary to adjust the scanning (full or quick scan) or enter a specific symbol rate in the **Settings** menu while installing. To set a **Symbol rate**, first set the Symbol rate to **Manual**.

Channel number conflicts

In some countries, different TV channels (broadcasters) might have the same channel number. While installing, the TV shows the list with channel number conflicts. You need to select which TV channel you want to install on a channel number with multiple TV channels.

DVB-T + DVB-C

If you can use a DVB-T antenna input but also a DVB-C input, you can set up your TV for both DVB-T and DVB-C. Install one system followed by the other with the necessary settings. Once each system is installed, you need to switch the antenna input signal on the **Antenna** connection on the back of the TV and set the TV in the appropriate system to view the installed channels on TV.
To select the DVB-T or DVB-C setting, see above.

DVB settings

Symbol rate mode

If your cable provider did not give you a specific **symbol rate** value to install the TV channels, leave the **Symbol rate mode** setting on **Automatic**.
If you received a specific symbol rate value, select **Manual**. However, the value you received could be in the predefined list of symbol rates already. Select **Predefined symbol rates** to check if your value is available automatically.

Predefined symbol rates

With the **Symbol rate mode** set to **Automatic**, the TV will use 1 of the predefined symbol rates as used by most cable providers in your country.

Symbol rate 1

With the **Symbol rate mode** set to **Manual**, you can enter the symbol rate value you received from your cable provider. To enter the value, use the number keys.

Symbol rate 2

With the **Symbol rate mode** set to **Manual**, you can enter a second symbol rate value you received from your cable provider. To enter the value, use the number keys.

Network frequency mode

If you intent to use the fast **Quick scan** method in **Frequency scan** to search for channels, select **Automatic**. The TV will use 1 of the predefined network frequencies (or HC - homing channel) as used by most cable providers in your country. If you received a specific network frequency value to search for channels, select **Manual**.

Network frequency

With the **Network frequency mode** set to **Manual**, you can enter here the network frequency value received from your cable provider. To enter the value, use the number keys.

Frequency scan

Select the method of searching for channels. You can select the faster **Quick scan** method and use the predefined settings used by most cable providers in your country. If this results in having no channels installed or if some channels are missing, you can select the extended **Full scan** method. This method will take more time to search for and install channels.

Frequency step size

The TV searches for channels in steps of **8MHz**. If this results in having no channels installed or if some channels are missing, you can search in smaller steps of **1MHz**. Using the 1MHz steps will take more time to search for and install channels.

Digital channels

If you know your cable provider is not offering digital channels, you can skip searching for digital channels. Select **Off**.

Analogue channels

If you know your cable provider is not offering analogue channels, you can skip searching for analogue channels. Select **Off**.

Free / Scrambled



If you have a subscription and a CAM - Conditional Access Module for pay TV services, select **Free + scrambled**. If you did not subscribe to pay TV channels or services, you can select **Free channels** only.

In **Help**, press  **List** and look up **CAM - Conditional Access Module** for more information.

Reception quality

If you receive digital channels, you can check the quality and signal strength of a channel.

If you have your own antenna, you can reposition the antenna to try and improve the reception. To check the reception quality of a digital channel, switch to the channel.

Press , select  **Setup** and press **OK**. Select **Channel settings** and press **OK**. Select **Channel installation > Digital : reception test** and press **OK**.

The digital frequency is shown for this channel. If the reception is poor, you can reposition your antenna. To check the signal quality of this frequency again, select **Search** and press **OK**. To enter a specific digital frequency yourself, use the remote control digit keys. Alternatively, select the frequency, position the arrows on a number with ◀ and ▶ and change the number with ▲ and ▼. To check the frequency, select **Search** and press **OK**.

If you use DVB-C to receive channels, the options **Symbol rate mode** and **Predefined symbol rates** are available. For Symbol rate mode, select **Automatic**, unless your cable provider gave you a specific symbol rate value. To enter the symbol rate value, use the number keys.

Manual installation

Analogue TV channels can be manually installed, channel by channel.

To install analogue channels manually, press **Home**, select **Setup** and press **OK**.

Select **Channel settings** and press **OK**.

Select **Channel installation** > **Analogue : manual installation** and press **OK**.

1 - System

To set up the TV system, select **System** and press **OK**.

Select your country or the part of the world where you are now.

2 - Find channel

To find a channel, select **Find channel** and press **OK**. Select **Search** and press **OK**. You can also enter a frequency yourself. If the reception is poor, press **Search** again. If you want to store the channel, select **Done** and press **OK**.

3 - Fine tune

To fine tune a channel, select **Fine tune** and press **OK**. You can fine tune the channel with ▲ or ▼.

If you want to store the channel found, select **Done** and press **OK**.

4 - Store

You can store the channel on the current channel number or as a new channel number.

Select **Store current channel** or **Store as new channel**.

You can redo these steps until you found all available analogue TV channels.

Picture format

If black bars appear on top and bottom or on both sides of the picture, you can adjust the picture format to a format that fills the screen.

While watching a TV channel, press **FORMAT** to open the **Picture format** menu.

Select a format from the list and press **OK**.

Picture formats

The following formats are available according to the picture on screen:

- **Auto fill**

Automatically enlarges the picture to fill the screen. Picture distortion is minimal, subtitles remain visible. Not suitable for PC input. Some extreme picture formats can still show black bars.

- **Auto zoom**

Automatically zooms in the picture to fill the screen as much as possible without distortion. Black bars may be visible. Not suitable for PC input.

- **Super zoom**

Removes the black bars on the side of 4:3 broadcasts. The picture is adjusted to fit the screen.

- **Movie expand 16:9**

Scales the picture to a 16:9 format.

- **Wide screen**

Stretches the picture to a 16:9 format.

- **Unscaled**

Expert mode for HD or PC input. Pixel for pixel display. Black bars may appear with pictures from a computer.

Text

Text pages

Open Text

To open Text while you are watching TV channels, press **TEXT**.

To close Text, press **TEXT** again.



Select a Text page

To select a page ...

- Enter the page number with the number keys.
- Press ◀ or ▶
- Press ▲ or ▼.
- Press a colour key to select a colour-coded subject at the bottom of the screen.

Text sub-pages

A Text page number can hold several subpages. The subpage numbers are shown on a bar next to the main page number.

To select a subpage, press ◀ or ▶.

T.O.P. Text pages

Some broadcasters offer T.O.P. Text.

To open T.O.P. Text pages within Text, press **OPTIONS** and select **T.O.P. overview**.

Favourite pages

The TV makes a list of the last 10 Text pages you opened. You can easily reopen them again in the Favourite Text pages column.

1 - In Text, select the star in the top left corner of the screen to show the column of favourite pages.

2 - Press ▼ or ▲ to select a page number and press **OK** to open the page.

You can clear the list with the option **Clear favourite pages**.

Search Text

You can select a word and scan Text for all occurrences of this word.

Open a Text page and press **OK**.

Select a word or number with the arrow keys.

Now press **OK** again to jump immediately to the next occurrence of this word or number.

Press **OK** again to jump to the subsequent occurrence.

To stop the search, press ▲ until nothing is selected.

Text from a connected device

Some connected devices that receive TV channels can also offer Text.

To open Text from a connected device, press **Home**, select the device and press **OK**.

While watching a channel on the device, press **OPTION**, select Show device keys and select the **Text** key and press **OK**.

Press **Back** to hide the device keys.

To close Text, press **Back** again.

Digital Text (UK only)

Some digital TV broadcasters offer dedicated Digital Text or interactive TV on their digital TV channels. This includes normal Text using the number, colour and arrow keys to select and navigate.

To close Digital Text, press **Back**.

Text options

In Text, press **OPTION** to select the following:

- Freeze page
- Dual screen
- T.O.P. overview
- Enlarge
- Reveal
- Cycle subpages
- Hide favourite pages
- Clear favourite pages
- Language

Freeze page

To stop the automatic rotation of subpages, press **OPTION** and select **Freeze page**.

Dual screen / Full screen

To show the TV channel and Text alongside each other, press **OPTION** and select **Dual screen**.

Select **Full screen** to switch back to full screen view.

T.O.P. overview

To open T.O.P. Text, press **OPTION** and select **T.O.P. overview**.

Enlarge

To enlarge the Text page for more comfortable reading, press **OPTION** and select **Enlarge**. To scroll down the page, press ▼ or ▲.

Reveal

To unhide hidden information on a page, press **OPTION** and select **Reveal**.

Cycle subpages

To cycle subpages when these are available, press **OPTION** and select **Cycle subpages**.

Language

To switch the group of characters that Text uses to display text correctly, press **OPTION** and select **Language**.

Text setup

Text language

Some digital TV broadcasters have several Text languages available.

To set your primary and secondary Text language, press **Home**, select **Setup** and press **OK**.

Select **Channel settings** and select **Primary** or **Secondary Text** and select your preferred Text languages.

Text 2.5

If available, Text 2.5 offers more colours and better graphics.

Text 2.5 is activated as a standard factory setting.

To switch it off, press **Home**, select **Setup** and press **OK**.

Select **TV settings** > **Preferences** > **Text 2.5**.

Interactive TV

What is iTV?

With interactive TV, some digital broadcasters combine their normal TV programme with information or entertainment pages. On some pages, you can respond to a programme or vote, do online shopping or pay for a video-on-demand programme.

HbbTV, MHEG, . . .

Broadcasters use various interactive TV systems : HbbTV (Hybrid Broadcast Broadband TV) or iTV (Interactive TV - MHEG). Interactive TV is sometimes referred to as Digital Text or Red button. But each system is distinct.

Visit the broadcasters Internet website for more information.

What you need

Interactive TV is only available on digital TV channels. To enjoy the full benefits of Interactive TV, you need a high-speed (broadband) Internet connection to the TV.

HbbTV

If a TV channel offers HbbTV pages, you must first switch on HbbTV in the TV settings to view the pages.

1 - Press **Home** again, select **Setup** and press **OK**.

2 - Select **TV settings** and select **General settings** > **HbbTV** and press **OK**.

3 - Select **On** and press **OK**.

4 - Press **↵**, repeatedly if necessary, to close the menu.

If you want to avoid access to HbbTV pages on a specific channel, you can block the HbbTV pages for this channel only.

1 - Tune to the channel of which you want to block the HbbTV pages.

2 - Press **≡** **OPTIONS** and select **HbbTV on this channel** and press **OK**.

3 - Select **Off** and press **OK**.



The first time you open the TV guide, the TV scans all TV channels for programme information. This may take several minutes. TV guide data is stored in the TV.

iTV pages

Open iTV pages

Most channels that offer HbbTV or iTV invite you to press the **■** (red) key or **OK** key to open their interactive programme.

Navigate iTV pages

You can use the arrow and colour keys, the number keys and the **↵** key to navigate the iTV pages. You can use the **▶** (Play), **⏸** (Pause) and **■** (Stop) keys to watch videos within iTV pages.

Digital Text (UK only)

To open Digital Text, press **TEXT**. To close, press **↵**.

Close iTV pages

Most iTV pages inform you which key to use to close. To force an iTV page to close, switch to the next TV channel and switch back.

3.4

TV guide

What you need

With the TV guide you can view a list of the current and scheduled TV programmes of your channels. Depending on where the TV guide information (data) is coming from, analogue and digital channels or only digital channels are shown. Not all channels offer TV guide information.

The TV can collect TV guide information for the channels that are installed on the TV (e.g the channels you watch with Watch TV). The TV cannot collect the TV guide information for channels viewed from a digital receiver.

Using the TV Guide

Open the TV guide

Open TV guide

To open the TV guide, press **GUIDE**. Press **GUIDE** again to close.

Switch to a programme

Switch to a programme

From the TV guide, you can switch to a current programme. To select a programme, use the arrow keys to highlight the programme name.

Navigate to the right to view programmes scheduled later that day.

To switch to the programme (channel), select the programme and press **OK**.

View programme details

To call up the details of the selected programme, press **i** **INFO**.

Change day

Change day

The TV guide can show scheduled programmes for the upcoming days (maximum up to 8 days).

If the TV guide information comes from the broadcaster, you can press **CH+** to view the schedule of one of the next days. Press **CH-** to go back to the previous day.

Alternatively, you can press **≡** **OPTIONS** and select **Change day**.

Select **Previous day**, **Today** or **Next day** and press **OK**, to select the day of the schedule.

If the TV guide information comes from the Internet, press **■** **Select day**.

Set a reminder

Set a reminder

You can set reminders that alert you of the start of a programme with a message on screen.

To set a reminder, select the programme in the schedule and press the colour key of **Set reminder**. The programme is marked with a clock **🕒**.

To cancel the reminder, press the colour key of **Clear reminder**.

To view a list of all reminders you have set, press the colour key of **Scheduled reminders**.

Search by genre

Search by genre

If the information is available, you can look up scheduled programmes by genre like movies, sports, etc.

To search for programmes by genre, press **III** **OPTIONS** and select **Search by genre**.

Select a genre and press **OK**. A list with the found programmes appears.

Recordings

From the TV guide, you can instantly record or schedule a recording of a TV programme. To store the recordings, connect a USB Hard Drive to the TV.

For more information on Recording, press **■** **List** and look up **Recording**.

Receiving TV guide info

The TV guide receives information (data) from broadcasters or from the Internet. In some regions and for some channels, TV guide information might not be available. The TV can collect TV guide information for the channels that are installed on the TV (e.g. the channels you watch with Watch TV). The TV cannot collect the TV guide information from channels viewed from a digital receiver or decoder.

The TV comes with the information set to **From the broadcaster**.

If TV guide information comes from the Internet, the TV guide can also list analogue channels next to the digital channels. In the TV guide menu, you can view the current channel you are watching in a small screen.

Set the TV guide information

If the TV is connected to the Internet, you can set the TV to receive the TV guide information from the broadcaster.

To set the TV guide information, press **▲**, select **⚙️ Setup** and press **OK**.

Select **TV settings > General settings > TV guide**.

Select **From the broadcaster** or **From the Internet**.

Missing recordings

When some recordings seem to have disappeared from the list of recordings, the TV guide info (data) might have changed. Recordings made with the setting **From the broadcaster** become invisible in the list if you switch the setting to **From the Internet** or vice versa. The TV might have switched to **From the Internet** automatically.

To make the recordings available in the list of recordings, switch to the setting that was selected when the recordings were made.

3.5

Switch to devices

Source list

In the list of connections - the Source menu - you can find the devices connected to the TV.

From this Source menu, you can switch to a device.

Source menu

To open the Source menu, press **➔** **SOURCE**.

To switch to a connected device, select the device with the arrows **◀** (left) or **▶** (right) and press **OK**.

For some devices (HDMI-CEC devices), you can select an activity directly in the list underneath the device icon.

Select the device and select an activity and press **OK**.

To close the Source menu without switching to a device, press **➔** again.



Automatic detection

When you connect a new device to the TV, the device is detected automatically and put in the Source menu. The device is shown as an icon (the device type) and has a name. If the device type does not correspond with the device, e.g. the TV says it is a player but it is not, you can change the type.

To change the type of the device, press **■** **Device type** and select a type that fits the device and press **OK**.

If the name does not fit the device or you want to give the device a name of your own, press **■** **Rename**. Use the remote control keypad to enter a new name.

An appropriate device type helps you in using the device. The device type determines picture and sound styles, resolution values, specific settings or the position within the Source menu.

When you connect a new device to the TV, the icon of the device jumps to the front of the Source menu.

If the TV does not detect the device automatically, select the connection you used to connect the device and adjust the Device type and name.

Original name and icon

To restore the device icon to its original name and type icon, press **III** **OPTIONS**, select the **Options** tab in the menu bar and select **Original name and icon** and press **OK**.

Scan connections

To rescan all TV connections and update the Source menu, press **III** **OPTIONS**, select the **Options** tab in the menu bar, select **Scan connections** and press **OK**.

From standby

With the TV in standby, you can switch on a connected device with your TV remote control.

Play

To switch on both disc player and TV from standby and start playing the disc or programme immediately, press **▶** (play) on the TV remote control.

The device should be connected with an HDMI cable and both TV and device must have HDMI CEC switched on.



Home Theatre System

You can switch on your Home Theatre System to listen to an audio disc or a radio channel and leave the TV in standby. To only switch on the HTS, with the TV in standby, press  **SOURCE** on the TV remote control.



EasyLink

With **EasyLink** you can operate a connected device with the TV remote control. EasyLink uses HDMI CEC to communicate with the connected devices. Devices must support HDMI CEC and must be connected with an HDMI connection.

In **Help**, press  **List** and look up **EasyLink** for more information.

3.6

Subtitles and languages

Subtitles

Switch subtitles on

To open the Subtitle menu, press **SUBTITLE**.

You can switch subtitles **On** or **Off**.

To show subtitles when the broadcasted programme is not in your language - the language you set for the TV, select **Automatic**. Also, this setting will show subtitles when you mute the sound with .

For analogue channels, subtitles must be made available in **Text**.



Subtitles for analogue channels

For analogue channels, you need to make subtitles available for each channel manually.

- 1 - Switch to a channel and press **Text** to open Text.
- 2 - Enter the page number for subtitles, usually 888.
- 3 - Press **Text** again to close Text.

If you select **On** in the Subtitle menu when watching this analogue channel, subtitles will be shown if available.



To know if a channel is analogue or digital, switch to the channel and open **Status** in the **Options** menu.

Subtitles for digital channels

There is no need to set subtitles in Text for digital channels. Digital channels can offer several subtitle languages for a programme. You can set a preferred primary and secondary subtitle language. If subtitles in one of these languages are available, the TV will show them.

If none of the preferred subtitle languages are available, you can select another subtitle language which is available.

To set the primary and secondary subtitle language . . .

- 1 - Press , select **Setup** and press **OK**.
- 2 - Select **Channel settings** and select **Languages > Primary subtitles** or **Secondary subtitles** and press **OK**.
- 3 - Select a language and press **OK**.
- 4 - Press , repeatedly if necessary, to close the menu.



To select a subtitle language when none of your preferred languages are available . . .

- 1 - Press  **OPTIONS**
- 2 - Select **Subtitle language** and select a language you want temporarily and press **OK**.

Audio language

Digital TV channels can broadcast audio with several spoken languages for a programme. You can set a preferred primary and secondary audio language. If audio in one of these languages is available, the TV will switch to this audio. If none of the preferred audio languages is available, you can select another audio language which is available.

To set the primary and secondary audio language . . .

- 1 - Press , select **Setup** and press **OK**.
- 2 - Select **Channel settings** and select **Languages > Primary audio** or **Secondary audio** and press **OK**.
- 3 - Select a language and press **OK**.
- 4 - Press , repeatedly if necessary, to close the menu.

To select an audio language when none of your preferred audio language is available . . .

- 1 - Press  **OPTIONS**
- 2 - Select **Audio language** and select an audio language you want temporarily and press **OK**.



Original language

If the digital channel holds the original language of a programme or movie, you can set the TV to automatically switch to that audio language. Set Original language to On to watch a dubbed movie in its original language (if the original language is available).

To set **Original language** . . .

- 1 - Press **HOME**, select **Setup** and press **OK**.
- 2 - Select **Channel settings** and select **Languages > Original language** and press **OK**.
- 3 - Select **On** or **Off** and press **OK**.
- 4 - Press **EXIT**, repeatedly if necessary, to close the menu.

Audio languages for the hearing and visually impaired

Some digital TV channels broadcast special audio and subtitles adapted for people who are hearing or visually impaired. In **Help**, press **LIST** and look up **Universal access** for more information.

Menu language

To change the language of the TV menus and messages . . .

- 1 - Press **HOME**, select **Setup** and press **OK**.
- 2 - Select **TV settings > General settings > Menu language** and press **OK**.
- 3 - Select the language you want and press **OK**.
- 4 - Press **EXIT**, repeatedly if necessary, to close the menu.

3.7

Timers and clock

Sleeptimer

With the sleep timer, you can set the TV to switch to standby automatically after a preset time.

To set the sleep timer, press **HOME**, select **Setup** and press **OK**.

Select **TV settings > General settings > Sleep timer**. With the slider bar you can set the time to up to 180 minutes in increments of 5 minutes. If set to 0 minutes, the sleep timer is switched off.

You can always switch off your TV earlier or reset the time during the countdown.

Clock

To know what time it is, press **GUIDE** to find the time in the TV guide.

In some countries, digital broadcasts do not send UTC - Coordinated Universal Time information. The daylight saving change might be ignored and the TV might show an incorrect time.

To correct the TV clock, press **HOME**, select **Setup** and press **OK**.

Select **TV settings > General settings > Clock** and select **Country dependent**.

Select **Daylight saving** and select the appropriate setting.

To set the time and date manually, select **Manual**. Then select **Time** or **Date**.

When you record programmes with **Smart TV, Recording**, we recommend not to change the time and date manually.

Switch off timer

If you do not press a key on the remote control during a 4 hour period, or if the TV receives no input signal and receives no remote control commands for 10 minutes, the TV switches off automatically to save energy.

If you use the TV as a monitor or use a digital receiver to watch TV (a Set-top box - STB) and you do not use the remote control of the TV, you should deactivate the automatic switch off.

To deactivate, press **HOME**, select **Setup** and press **OK**. Select **TV settings > General settings > Switch off timer** and set the slider bar to **0**.

In **Help**, press **LIST** and look up **Saving energy** for more information on environmentally friendly TV settings.

3.8

Picture settings

Picture style

For easy picture adjustment, you can select a preset setting with **Picture style**.

- 1 - While watching a TV channel, press **OPTIONS** to open the Options menu
- 2 - Select **Picture and sound** in the menu bar and select **Picture style**.
- 3 - Select a style and press **OK**.

Additionally, you can adjust a specific setting of a chosen Picture style, like Brightness or Contrast. The TV remembers the adjustments you made.

Adjust a Picture style

To adjust a Picture style . . .

- 1 - Select the style and press **OK**.
- 2 - Press **Home**, select **Setup** and press **OK**.
- 3 - Select **TV settings**, navigate to the individual setting and adjust it.
- 4 - Press **Back** to close the menu to store your setting.

To return to the original Picture style values . . .

- 1 - Press **Home**, select **Setup** and press **OK**.
- 2 - Select **TV settings** > **Picture** > **Picture style** and select the style you want to reset.
- 3 - Press **Reset**. The style is reset.

In **Help**, press **List** and look up **Picture** for adjusting separate picture settings.

The available Picture styles are . . .

- **Personal** - Your preferences made in Quick picture settings
- **Vivid** - Ideal for daylight viewing
- **Natural** - Natural picture settings
- **Movie** - Ideal for watching movies
- **Energy saving** - Energy-efficient settings
- **Standard** - Factory standard settings
- **Photo** - Ideal for viewing photos

Vivid

If the Picture style is switched back to **Vivid** every time you switch on the TV, the TV location is set to **Shop**. A setting meant for in-store promotion.

To set the TV for Home use . . .

- 1 - Press **Home**, select **Setup** and press **OK**.
- 2 - Select **TV settings** > **General settings** > **Location** and press **OK**.
- 3 - Select **Home** and press **OK**.
- 4 - Press **Back**, repeatedly if necessary, to close the menu.

Picture menu

Backlight contrast

With **Backlight contrast**, you can adjust the contrast of the picture. If you are watching 3D pictures, this setting is switched to **3D backlight contrast**.

To adjust the contrast . . .

- 1 - Press **Home**, select **Setup** and press **OK**.
- 2 - Select **TV settings** > **Picture** > **Backlight contrast**.
- 3 - Press **Right** and adjust the value with **Up** (up) or **Down** (down).
- 4 - Press **Back**, repeatedly if necessary, to close the menu.

Colour

With **Colour**, you can adjust the colour saturation of the picture.

To adjust the colour . . .

- 1 - Press **Home**, select **Setup** and press **OK**.
- 2 - Select **TV settings** > **Picture** > **Colour**.

- 3 - Press **Right** and adjust the value with **Up** (up) or **Down** (down).

- 4 - Press **Back**, repeatedly if necessary, to close the menu.

Sharpness

With **Sharpness**, you can adjust the level of sharpness in fine detail of the picture.

To adjust the sharpness . . .

- 1 - Press **Home**, select **Setup** and press **OK**.
- 2 - Select **TV settings** > **Picture** > **Sharpness**.
- 3 - Press **Right** and adjust the value with **Up** (up) or **Down** (down).
- 4 - Press **Back**, repeatedly if necessary, to close the menu.

Noise reduction

With **Noise reduction**, you can filter out and reduce the level of image noise.

To adjust the noise reduction . . .

- 1 - Press **Home**, select **Setup** and press **OK**.
- 2 - Select **TV settings** > **Picture** > **Noise reduction**.
- 3 - Press **Right** and select **Maximum**, **Medium**, **Minimum** or **Off**.
- 4 - Press **Back**, repeatedly if necessary, to close the menu.

MPEG artefact reduction

With **MPEG artefact reduction**, you can smoothen the digital transitions in the picture. MPEG artefacts are mostly visible as small blocks or jagged edges in images.

To reduce the MPEG artefacts . . .

- 1 - Press **Home**, select **Setup** and press **OK**.
- 2 - Select **TV settings** > **Picture** > **MPEG artefact reduction**.
- 3 - Press **Right** and select **Maximum**, **Medium**, **Minimum** or **Off**.
- 4 - Press **Back**, repeatedly if necessary, to close the menu.

Perfect Pixel HD

Perfect Natural Motion

With **Perfect Natural Motion**, you can reduce the motion judder, visible in movies on TV. Perfect Natural Motion makes any movement smooth and fluent.

To adjust the motion judder . . .

- 1 - Press **Home**, select **Setup** and press **OK**.
- 2 - Select **TV settings** > **Picture** > **Perfect Pixel HD** > **Perfect Natural Motion**.
- 3 - Press **Right** and select **Maximum**, **Medium**, **Minimum** or **Off**.
- 4 - Press **Back**, repeatedly if necessary, to close the menu.

Clear LCD

With **Clear LCD**, you switch on a superior motion sharpness, better black level, high contrast with a flicker-free, quiet image and a larger viewing angle.

To switch on or off . . .

- 1 - Press **Home**, select **Setup** and press **OK**.
 - 2 - Select **TV settings > Picture > Perfect Pixel HD > Clear LCD**.
 - 3 - Press **Right** and select **On** or **Off**.
 - 4 - Press **Back**, repeatedly if necessary, to close the menu.
-

Super resolution

With **Super resolution**, you switch on a superior sharpness in line edges and contours.

To switch on or off . . .

- 1 - Press **Home**, select **Setup** and press **OK**.
 - 2 - Select **TV settings > Picture > Perfect Pixel HD > Super resolution**.
 - 3 - Press **Right** and select **On** or **Off**.
 - 4 - Press **Back**, repeatedly if necessary, to close the menu.
-

Perfect contrast

With **Perfect contrast**, you can set the level at which the TV automatically enhances the details in the dark, middle and light areas of the picture.

To adjust the level . . .

- 1 - Press **Home**, select **Setup** and press **OK**.
 - 2 - Select **TV settings > Picture > Perfect Pixel HD > Perfect contrast**.
 - 3 - Press **Right** and select **Maximum, Medium, Minimum** or **Off**.
 - 4 - Press **Back**, repeatedly if necessary, to close the menu.
-

Dynamic backlight

With **Dynamic backlight**, you can set the level at which power consumption can be reduced by dimming the intensity of the screen. Choose for the best power consumption or for the picture with the best intensity.

To adjust the level . . .

- 1 - Press **Home**, select **Setup** and press **OK**.
 - 2 - Select **TV settings > Picture > Perfect Pixel HD > Dynamic backlight**.
 - 3 - Press **Right** and select **Best picture, Best power, Standard** or **Off**.
 - 4 - Press **Back**, repeatedly if necessary, to close the menu.
-

Colour enhancement

With **Colour enhancement**, you can enhance the colour intensity and the details in bright colours.

To adjust the level . . .

- 1 - Press **Home**, select **Setup** and press **OK**.

- 2 - Select **TV settings > Picture > Perfect Pixel HD > Colour enhancement**.

- 3 - Press **Right** and select **Maximum, Medium, Minimum** or **Off**.

- 4 - Press **Back**, repeatedly if necessary, to close the menu.
-

Advanced settings

Light sensor

The **Light sensor** adjusts the picture and Ambilight settings automatically to the lighting conditions of the room. You can switch Light sensor on or off.

To switch on or off . . .

- 1 - Press **Home**, select **Setup** and press **OK**.
 - 2 - Select **TV settings > Picture > Advanced > Light sensor**.
 - 3 - Press **Right** and select **On** or **Off**.
 - 4 - Press **Back**, repeatedly if necessary, to close the menu.
-

Gamma

With **Gamma**, you can set a non-linear setting for picture luminance and contrast. Gamma is a setting intended for expert users.

To adjust the level . . .

- 1 - Press **Home**, select **Setup** and press **OK**.
 - 2 - Select **TV settings > Picture > Advanced > Gamma**.
 - 3 - Press **Right** and adjust the value with **Up** (up) or **Down** (down).
 - 4 - Press **Back**, repeatedly if necessary, to close the menu.
-

Colour temperature

With **Colour temperature**, you can set the picture to a preset colour temperature or select **Custom** to set a temperature setting yourself with **Custom colour temperature**. Colour temperature and Custom colour temperature are settings intended for expert users.

To select a preset . . .

- 1 - Press **Home**, select **Setup** and press **OK**.
 - 2 - Select **TV settings > Picture > Advanced > Colour temperature**.
 - 3 - Press **Right** and select **Normal, Warm** or **Cool**. Select **Custom** if you want to set a colour temperature yourself.
 - 4 - Press **Back**, repeatedly if necessary, to close the menu.
-

Custom colour temperature

With **Custom colour temperature**, you can set a colour temperature yourself. To set a Custom colour temperature, first select **Custom** in the **Colour temperature** setting to make the Custom colour temperature menu available. Custom colour temperature is a setting intended for expert users.

To set a custom colour temperature . . .

- 1 - Press **Home**, select **Setup** and press **OK**.
- 2 - Select **TV settings > Picture > Advanced > Custom colour temperature**.

- 3 - Press **▶** (right).
 - 4 - Select a setting with the arrow keys. (WP is white point and BL is black level.)
 - 5 - Press **OK** to confirm a setting. You can also select one of the presets in this menu.
 - 6 - Press **↵**, repeatedly if necessary, to close the menu.
-

Video contrast

With **Video contrast**, you can decrease the range of the video contrast. If you are watching 3D pictures, this setting is switched to **3D video contrast**. Video contrast and 3D video contrast are settings intended for expert users.

To adjust the level . . .

- 1 - Press **⬆️**, select **⚙️ Setup** and press **OK**.
 - 2 - Select **TV settings > Picture > Advanced > Video contrast**.
 - 3 - Press **▶** (right) and adjust the value with **▲** (up) or **▼** (down).
 - 4 - Press **↵**, repeatedly if necessary, to close the menu.
-

Brightness

With **Brightness**, you can set the level of brightness of the picture signal. Brightness is a setting intended for expert users. We recommend non-expert users to adjust the brightness with the **Backlight contrast** setting.

To adjust the level . . .

- 1 - Press **⬆️**, select **⚙️ Setup** and press **OK**.
 - 2 - Select **TV settings > Picture > Advanced > Brightness**.
 - 3 - Press **▶** (right) and adjust the value with **▲** (up) or **▼** (down).
 - 4 - Press **↵**, repeatedly if necessary, to close the menu.
-

HDMI black level detection

With **HDMI black level detection**, you can set the black level of an incoming HDMI signal automatically. For a manual setting, HDMI black level detection must be switched off. HDMI black level detection is a setting intended for expert users. The setting is only available in the Picture menu when an HDMI source is selected.

To switch on or off . . .

- 1 - Press **⬆️**, select **⚙️ Setup** and press **OK**.
 - 2 - Select **TV settings > Picture > Advanced > HDMI black level detection**.
 - 3 - Press **▶** (right) and select **On** or **Off**.
 - 4 - Press **↵**, repeatedly if necessary, to close the menu.
-

Colour control

With **Colour control**, an ISF expert can calibrate the colour reproduction of the TV. Colour control is an ISF expert setting.

RGB only mode

With **RGB only mode**, an ISF expert can switch the screen to RGB colours only.

Game or computer

You can switch the TV to the ideal picture setting for gaming or for using the TV as a computer monitor. There is a different setting for **Game** or **Computer**. If a device has a correct type set in the Source menu - Game console or Computer - the TV switches automatically to the ideal setting when you switch to the device. If you switch the setting manually, do not forget to switch it off when you switch to watching TV or another connected device.

To switch the setting manually . . .

- 1 - Press **⬆️**, select **⚙️ Setup** and press **OK**.
 - 2 - Select **TV settings > Picture > Game or computer**.
 - 3 - Select **Game, Computer** or **Off**. The setting **Off** returns to the picture settings for watching TV.
 - 4 - Press **↵**, repeatedly if necessary, to close the menu.
-

Format and edges

Picture format

For more information on Picture format, press **▢ LIST** and look up **Picture format**.

Screen edges

With **Screen edges**, you can slightly enlarge the picture to hide distorted edges.

To adjust the edges . . .

- 1 - Press **⬆️**, select **⚙️ Setup** and press **OK**.
 - 2 - Select **TV settings > Picture > Format and edges > Screen edges**.
 - 3 - Press **▶** (right) and adjust the value with **▲** (up) or **▼** (down).
 - 4 - Press **↵**, repeatedly if necessary, to close the menu.
-

Picture shift

With **Picture shift**, you can shift the picture slightly up or down the screen. If subtitles are only half visible, you can shift the picture up to make them completely visible.

To shift the picture . . .

- 1 - Press **⬆️**, select **⚙️ Setup** and press **OK**.
 - 2 - Select **TV settings > Picture > Format and edges > Picture shift**.
 - 3 - Press **▶** (right) and adjust the value with **▲** (up) or **▼** (down).
 - 4 - Press **↵**, repeatedly if necessary, to close the menu.
-

Location

If the TV is located in a shop, you can set the TV to display an in store promotion banner. The **Picture style** is set to **Vivid** automatically. The automatic **Switch off timer** is switched off.

To set the TV to Shop location . . .

- 1 - Press **Home**, select **Setup** and press **OK**.
- 2 - Select **TV settings** > **General settings** > **Location** and press **OK**.
- 3 - Select **Shop** and press **OK**.
- 4 - Press **Back**, repeatedly if necessary, to close the menu.

ISF Calibration

Get the most out of your HD TV display with ISF® Calibration. You can ask an ISF calibration expert to come to your home and set the TV to the most optimal picture setting. Additionally the expert can set an ISF Calibration for Ambilight. Ask your dealer for an ISF Calibration of your TV.



The ISF Calibration expert stores and locks the ISF settings as 2 picture styles. Once the ISF Calibration is done, press **Options**, select **Picture style** and press **OK**. Select **ISF Day** to watch TV during bright light conditions or select **ISF Night** for dark light conditions.

An ISF Calibration can be done on every activity in the Home menu, like Watch TV or a connected Blu-ray Disc player.

Calibration benefits are . . .

- better picture clarity and sharpness
- better detail in bright and dark parts
- deeper and darker blacks
- better colour purity and quality
- reduced energy consumption

Expert picture settings

When ISF Day or ISF Night is selected while an ISF Calibration is not yet performed on the TV, some expert picture settings are available. Press **Home**, select **Setup** and press **OK**. Select **TV settings** > **Picture** > **ISF expert settings** and press **OK**.

Reset picture style settings

To reset a picture style to its original values, select the picture style you want to reset in the **OPTIONS** menu. Then Press **Home**, select **Setup** and press **OK**. Select **TV settings** > **Picture**, select **Reset**, press **OK** and confirm.

3.9

Sound settings

Sound style

For easy sound adjustment, you can select a preset setting with **Sound style**.

While watching a TV channel, press **Options** to open the Options menu and select **Sound style**. Select a Sound style and press **OK**.

Sound styles

With Sound styles, you can switch easily to ideal settings for speech (News) or watching movies.

Additionally, you can adjust a specific setting of a chosen Sound style, like Bass or Treble. The TV remembers the adjustments you made.

Adjust a Sound style

To adjust a Sound style . . .

- 1 - Select the style and press **OK**.
- 2 - Press **Home**, select **Setup** and press **OK**.
- 3 - Select **TV settings**, navigate to the individual setting and adjust it.
- 4 - Press **Back** to close the menu to store your setting.

To return to the original Sound style values . . .

- 1 - Press **Home**, select **Setup** and press **OK**.
- 2 - Select **TV settings** > **Sound** > **Sound style** and select the style you want to reset.
- 3 - Press **Reset**. The style is reset.

In **Help**, press **List** and look up **Sound** for adjusting separate sound settings.

The different Sound styles are . . .

- **Personal** - Your personal choices made in Personalise picture and sound
- **Original** - Factory standard
- **News** - Ideal for speech
- **Movie** - Ideal for watching movies
- **Game** - Ideal for gaming
- **Music** - Ideal for listening to music

Sound settings

Bass

With **Bass**, you can adjust the level of low tones in the sound.

To adjust the level . . .

- 1 - Press **Home**, select **Setup** and press **OK**.
- 2 - Select **TV settings** > **Sound** > **Bass**.
- 3 - Press **Right** and adjust the value with **Up** (up) or **Down** (down).
- 4 - Press **Back**, repeatedly if necessary, to close the menu.

Treble

With **Treble**, you can adjust the level of high tones in the sound.

To adjust the level . . .

- 1 - Press **Home**, select **Setup** and press **OK**.
- 2 - Select **TV settings** > **Sound** > **Treble**.
- 3 - Press **Right** and adjust the value with **Up** (up) or **Down** (down).
- 4 - Press **Back**, repeatedly if necessary, to close the menu.

Surround mode

With **Surround mode**, you can set the sound effect of the TV speakers. If you select **Incredible surround** for 2D viewing, the TV will switch to **Incredible surround 3D** automatically when you start watching 3D. If you do not want the TV to switch automatically, select **Off** in **Auto incredible surround 3D**.

To set the surround mode . . .

- 1 - Press **Home**, select **Setup** and press **OK**.
 - 2 - Select **TV settings > Sound > Surround mode**.
 - 3 - Press **Right** and select **Stereo**, **Incredible surround** or **Incredible surround 3D**.
 - 4 - Press **Back**, repeatedly if necessary, to close the menu.
-

Auto incredible surround 3D

With **Auto incredible surround 3D**, you can block the TV to automatically switch to Incredible surround 3D when the TV is switched to 3D viewing.

To switch on or off . . .

- 1 - Press **Home**, select **Setup** and press **OK**.
 - 2 - Select **TV settings > Sound > Auto incredible surround 3D**.
 - 3 - Press **Right** and select **On** or **Off**.
 - 4 - Press **Back**, repeatedly if necessary, to close the menu.
-

Headphones volume

With **Headphones volume**, you can set the volume of a connected headphones separately.

To adjust the volume . . .

- 1 - Press **Options** and select **Picture and sound** in the menu bar.
 - 2 - Press **Down** and select **Headphones volume** and press **OK**.
 - 3 - Press **Up** or **Down** to adjust the volume.
 - 4 - Press **Back**, repeatedly if necessary, to close the menu.
-

Mono/Stereo

With **Mono/Stereo**, you can switch the sound to mono or stereo. This setting is only available when you watch an analogue channel. You might want to switch the sound to mono if a digital stereo signal that comes with the analogue signal, is of bad quality.

To switch the sound to mono or stereo . . .

- 1 - Press **Home**, select **Setup** and press **OK**.
- 2 - Select **Channel settings > Mono/Stereo**.
- 3 - Press **Right** and select **Mono** or **Stereo**.
- 4 - Press **Back**, repeatedly if necessary, to close the menu.

If the TV has a built-in satellite tuner and you are watching an analogue channel from a satellite, select **Satellite settings** in the **Setup** menu.

Advanced sound settings

Auto volume leveling

With **Auto volume leveling**, you can set the TV to automatically level out sudden volume differences. Typically at the beginning of adverts or when you are switching channels.

To switch on or off . . .

- 1 - Press **Home**, select **Setup** and press **OK**.
 - 2 - Select **TV settings > Sound > Advanced > Auto volume leveling**.
 - 3 - Press **Right** and select **On** or **Off**.
 - 4 - Press **Back**, repeatedly if necessary, to close the menu.
-

TV speakers

You can send the TV sound to a connected audio device - a Home Theatre System or audio amplifier. With **TV speakers**, you select where you want to hear the TV sound and how you want to control it.

If you select **Off**, you permanently switch off the TV speakers. If you select **On**, the TV speakers are always on.

With an audio device connected with HDMI CEC, you can use one of the EasyLink settings.

If you select **EasyLink**, the TV sends the TV sound to the audio device. The TV will switch off the TV speakers when the device is playing the sound.

If you select **EasyLink autostart**, the TV will switch on the audio device, send the TV sound to the device and switch off the TV speakers.

With EasyLink or EasyLink autostart selected, you can still switch to TV speakers or device speakers in the Picture and sound menu.

To set the TV speakers . . .

- 1 - Press **Home**, select **Setup** and press **OK**.
- 2 - Select **TV settings > Sound > Advanced > TV speakers**.
- 3 - Press **Right** and select **On**, **Off**, **EasyLink** or **EasyLink autostart**.
- 4 - Press **Back**, repeatedly if necessary, to close the menu.

To switch speakers in the Picture and sound menu . . .

- 1 - While watching TV, press **Options** and select **Picture and sound**.
 - 2 - Select **Speakers** and select **TV** or **Amplifier** (audio device).
 - 3 - Press **Back**, repeatedly if necessary, to close the menu.
-

Clear sound

With Clear sound, you improve the sound for speech. Ideal for news programmes. You can switch the speech improvement on or off.

To switch on or off . . .

- 1 - Press **Home**, select **Setup** and press **OK**.
- 2 - Select **TV settings > Sound > Advanced > Clear sound**.
- 3 - Press **Right** and select **On** or **Off**.
- 4 - Press **Back**, repeatedly if necessary, to close the menu.

Audio Out format

With Audio Out format you can set the audio out signal of the TV to fit the sound processing capabilities of your Home Theatre System.

For more information, press **■ LIST** and look up **Audio Out format**.

Audio Out leveling

With Audio Out leveling you can level the sound volume of the Home Theatre System with the volume of the TV when you switch over from one to another.

For more information, press **■ LIST** and look up **Audio Out leveling**.

HDMI ARC

If you do not need an Audio Return Channel (ARC) on any of the HDMI connections, you can switch the ARC signal off.

For more information, press **■ LIST** and look up **HDMI ARC**.

Audio Out delay

If you set an Audio sync delay on your Home Theatre System, to synchronise the sound with the picture, you must switch off Audio Out delay on the TV.

For more information, press **■ LIST** and look up **Audio Out delay**.

Audio Out offset

If you cannot set a delay on the Home Theatre System, you can set a delay on the TV with Audio Out offset.

For more information, press **■ LIST** and look up **Audio Out offset**.

TV placement

As part of the first installation, this setting is set to either **On a TV stand** or **Wall mounted**.

If you have changed the placement of the TV since then, adjust this setting accordingly for best sound reproduction.

- 1 - Press **■**, select **⚙ Setup** and press **OK**.
 - 2 - Select **TV settings > General settings > TV placement** and press **OK**.
 - 3 - Select **On a TV stand** or **Wall mounted** and press **OK**.
 - 4 - Press **➔**, repeatedly if necessary, to close the menu.
-

Ambilight on or off

Press **AMBILIGHT** on the remote control to open the Ambilight mode menu. You can switch Ambilight **On** or **Off**. Alternatively, you can select the Ambilight mode you prefer, **Dynamic** or **Static**.



Ambilight brightness

With **Brightness**, you can set the level of brightness of the Ambilight.

To adjust the level . . .

- 1 - Press **■**, select **⚙ Setup** and press **OK**.
 - 2 - Select **TV settings > Ambilight > Brightness**.
 - 3 - Press **▶** (right) and adjust the value with **▲** (up) or **▼** (down).
 - 4 - Press **➔**, repeatedly if necessary, to close the menu.
-

Ambilight mode

Ambilight can have a dynamic or a static mode. With **Dynamic**, the TV follows the colours of the image on screen. You can adjust the speed at which Ambilight responds.

With **Static**, Ambilight has a constant static colour. You can create an Ambilight static colour yourself. First, select the Ambilight mode you prefer.

To select an Ambilight mode . . .

- 1 - Press **■**, select **⚙ Setup** and press **OK**.
 - 2 - Select **TV settings > Ambilight > Mode**.
 - 3 - Select **Dynamic**, **Static** or **Off**.
 - 4 - Press **➔**, repeatedly if necessary, to close the menu.
-

Dynamic speed

With **Dynamic**, you can set the speed at which Ambilight responds to the images on screen. Adjust the speed between **Relaxed** or **Dynamic**. The Ambilight mode must be set to **Dynamic** before you can adjust Dynamic speed.

To adjust the speed . . .

- 1 - Press **■**, select **⚙ Setup** and press **OK**.
- 2 - Select **TV settings > Ambilight > Dynamic**.
- 3 - Press **▶** (right) and adjust the value with **▲** (up) or **▼** (down).
- 4 - Press **➔**, repeatedly if necessary, to close the menu.

Static colour

With **Static**, you can set the static Ambilight colour. You can create a colour yourself or select one of the two white light presets. The Ambilight mode must be set to Static before you can create a static colour.

To create a colour yourself . . .

- 1 - Press **Home**, select **Setup** and press **OK**.
- 2 - Select **TV settings > Ambilight > Static** and press **OK**.
- 3 - Select **Palette** to adjust the colour. Select **Saturation** to adjust the intensity of the colour. Use the arrows to select and adjust. Press **OK** to confirm.
- 4 - If you prefer to select one of the preset colours, select **Warm white** or **Cool white** and press **OK**.
- 5 - Select **Close** and press **OK**.
- 6 - Press **Back**, repeatedly if necessary, to close the menu.

ISF warm white

With **ISF warm white**, you can ask an ISF expert to calibrate a static Ambilight colour next to the ISF picture calibration. ISF warm white must be selected in the Ambilight mode menu.

To select the ISF warm white mode . . .

- 1 - Press **Home**, select **Setup** and press **OK**.
- 2 - Select **TV settings > Ambilight > Mode**.
- 3 - Select **ISF warm white**.
- 4 - Press **Back**, repeatedly if necessary, to close the menu.

The expert can now set the static colour in the ISF warm white setting in Advanced.

Advanced Ambilight settings

Wall colour

With **Wall colour**, you can neutralise the influence of a coloured wall on the Ambilight colours. Select the colour of the wall behind the TV and the TV will adapt the Ambilight colours to appear as they are intended.

To select the colour of the wall . . .

- 1 - Press **Home**, select **Setup** and press **OK**.
- 2 - Select **TV settings > Ambilight > Advanced > Wall colour**.
- 3 - Select the colour sample that matches the colour of the wall behind the TV and press **OK**.
- 4 - Press **Back**, repeatedly if necessary, to close the menu.

TV switch off

With **TV switch off**, you can set Ambilight to switch off immediately or slowly fade out when you switch off the TV. The slow fade out gives you some time to switch on the normal lighting.

To select the TV switch off . . .

- 1 - Press **Home**, select **Setup** and press **OK**.
- 2 - Select **TV settings > Ambilight > Advanced > TV switch off**.
- 3 - Select **Fade out to off** or **Immediate switch off**.
- 4 - Press **Back**, repeatedly if necessary, to close the menu.

Lounge light mood

When the TV is on standby, you can switch Ambilight on and create a Lounge light effect in your room. The Lounge light effect is not available when Quick start is activated.

To switch Ambilight on while the TV is on standby, press **AMBILIGHT**.



To change the Lounge light colour scheme, press **AMBILIGHT** again.

To switch off Lounge light, press and hold **AMBILIGHT** for a few seconds.

You can also set up the colour scheme in the TV settings menu.

With the TV switched on, press **Home**, select **Setup** and press **OK**. Select **TV settings > Ambilight > Advanced > Lounge light mood**. Select the colour scheme with which Lounge light will start up.

3.11

Universal access

Switch on

With Universal access switched on, the TV is set for use for hearing and visually impaired people.

Switch on

If you did not switch on Universal access during the installation, you can still switch it on in Setup.

To switch on Universal access, press **Home**, select **Setup** and press **OK**.

Select **TV settings > General settings > Universal access**. Select **On** and press **OK**.

With Universal access switched on in Setup, the Universal access option is added in the Options menu.

Hearing impaired

Some digital TV channels broadcast special audio and subtitles adapted for hearing impaired people. With Hearing impaired switched on, the TV automatically switches to the adapted audio and subtitles, if available. Before you can switch on Hearing impaired, you have to switch on **Universal access**.

Switch on

To switch on Hearing impaired, press **⏏** **OPTIONS**, select **Universal access** and press **OK**.

Select **Hearing impaired**, select **On** and press **OK**.

To check whether a hearing impaired audio language is available, press **⏏** **OPTIONS**, select **Audio language** and look for an audio language marked with a .

If Universal access does not appear in the Options menu, switch on **Universal access** in Setup.

In **Help**, press  **List** and look up **Universal access** for more information.

Visually impaired

Switch on

Digital TV channels can broadcast special audio commentary describing what is happening on screen. To be able to set the visually impaired audio and effects, you have to switch on Audio description first. Also, before you can switch on Audio description, you have to switch on **Universal access**.

Audio description

With **Audio description**, a narrator's commentary is added to the normal audio.

To switch on the commentary (if available) . . .

1 - With **Universal access** switched on, press **⏏** **OPTIONS** and select the **Options** tab in the menu bar.

2 - Select **Audio description** and press **OK**.

3 - Select **On** and press **OK**.

You can check if an audio commentary is available.

In the Options menu, select **Audio language** and look for an audio language marked with a .

Speakers / Headphones

You can select where you want to hear the audio commentary. On the TV speakers only, on the headphones only or on both.

To set **Speakers / Headphones** . . .

1 - Press , select  **Setup** and press **OK**.

2 - Select **Channel settings** > **Languages** > **Audio description** > **Speakers / Headphones** and press **OK**.

3 - Select **Speakers**, **Headphones** or **Speakers + headphones** and press **OK**.

4 - Press , repeatedly if necessary, to close the menu.

Mixed volume

You can mix the volume of the normal audio with the audio commentary.

To mix the volume . . .

1 - Press **⏏** **OPTIONS** and select the **Options** tab in the menu bar.

2 - Select **Mixed volume** and press **OK**.

3 - Use the arrows up and down to set the slider bar.

4 - Press **OK** to confirm.

Audio effect

Some audio commentary can hold extra audio effects, like stereo or fading sound.

To switch on **Audio effects** (if available) . . .

1 - Press , select  **Setup** and press **OK**.

2 - Select **Channel settings** > **Languages** > **Audio description** > **Audio effects** and press **OK**.

3 - Select **On** or **Off** and press **OK**.

4 - Press , repeatedly if necessary, to close the menu.

Speech

The audio commentary can also hold subtitles for the words which are spoken.

To switch on these subtitles (if available) . . .

1 - Press , select  **Setup** and press **OK**.

2 - Select **Channel settings** > **Languages** > **Audio description** > **Speech** and press **OK**.

3 - Select **Descriptive** (audio) or **Subtitles** and press **OK**.

4 - Press , repeatedly if necessary, to close the menu.

Key beep

Key beep gives an audio feedback each time you press a key on the remote control. The volume of the beep is fixed.

Switch on

To switch on Key beep, press **⏏** **OPTIONS**, select **Universal access** and press **OK**.

Select **Key beep** and select **On**.

If Universal access does not appear in the Options menu, switch on Universal access in Setup.

In **Help**, press  **List** and look up **Universal access** for more information.

Satellite channels

4.1

Watching satellite channels

To watch satellite channels, press **▲**, select **Satellite** and press **OK**. The TV tunes to the satellite channel you last watched.

Change channel

To change channels, press **CH+** or **CH-**. The TV will tune to the next channel in the selected channel list. If you know the channel number, you can use the number keys on the remote control. To change back to the previously tuned channel, press **↶**.

You can also tune to a channel directly from the Satellite channel list.

4.2

Satellite channel list

About the channel list

When the satellite installation is completed, all satellite channels are put in the channel list. You can view the list of all channels or filter the list down to show the favourite channels only or the radio stations only. Or, after a channel update, you can find the newly added channels in the list of new channels. From any list, you can directly tune to a channel. The list you select in the channel list, determines the channels you tune to with the **CH+** and **CH-** keys.

You can only reorder channels in the list of favourite channels.

Select a channel list

The list you select in the channel list, determines the channels you tune to with the **CH+** and **CH-** keys.

To select a channel list . . .

- 1 - Press **▲**, select **Satellite** and press **OK**.
- 2 - Press **≡ LIST** to open the channel list. The list appears with the current channel selected.
- 3 - Navigate up to select **All** or a list filter **Favourites**, **Radio**, **TV** or **New**.

The lists Radio or New are only shown when radio stations are available or new channels were found with a channel update.

Tune from the channel list

To tune to a channel from the channel list . . .

1 - In the channel list, select **TV** or **Satellite** in the menu bar to select the TV or Satellite channel list.

2 - Select a list - **All**, **Favourites**, **Radio** or **New**.

3 - Select a channel in any of the lists and press **OK**. The TV will tune to the selected channel.

Channel list options

To view the channel list options on the current channel . . .

1 - With the All channels list on screen, select a channel and press **≡ OPTIONS**.

2 - Select the option you want and press **OK**.

Available options for satellite channels . . .

• Satellite

Filter the channel list to only show the channels of a specific satellite or show the channels of all satellites.

• Free/Scrambled

Filter the channel list to only show the free-to-air channels, only the scrambled channels or both. Scrambled channels are marked with a key **≡**.

• Lock

You can lock a channel. First select a channel in the list, press **≡ OPTIONS** and select **Lock**. You will have to enter the 4-digit child lock code. A locked channel is marked with a lock **🔒**.

• Unlock

To unlock a locked channel. Select a locked channel in the list, press **≡ OPTIONS** and select **Unlock**. You will have to enter the 4-digit child lock code.

Channel list copy

Channel list copy is intended for dealers and expert users. With Channel list copy, you can copy the channels installed on one TV onto another Philips TV of the same range. Channel list copy will copy both terrestrial and satellite channels. For more information on Channel list copy, press **≡ LIST** and look up **Channel list copy**.

4.3

Favourite satellite channels

Favourite channels

You can mark channels as favourite channels. Your favourite satellite channels are collected in the **Favourites** list of the satellite channel list.

Watching favourite channels



Set up a favourite channel list to easily switch between the channels you want to watch. Only in this list, you can reorder channels according to your preference.

To only switch between your favourite channels with **CH+** and **CH-**, select the Favourites list in the channel list and close the channel list again.

There are two favourite lists, one for TV channels and one for satellite channels.

Set up your favourites list

To compose a list of your favourite channels . . .

- 1 - While watching a channel, press **≡ LIST** to open the channel list.
- 2 - In the menu bar, select  for TV or  for satellite channels.
- 3 - Select the **Favourites** list.
- 4 - The TV will ask you to start adding channels immediately. Press **OK**. To avoid a lot of reordering later, select the channels in the order you want them in the list.
- 5 - To add a channel to the Favourites list, select the channel and press **OK**. You can then select another channel to add as a favourite.
- 6 - To finish, press **■ Done**.

Add or remove favourite channels

Once you composed your favourites list, you can add or remove channels one by one. Or you can use the Add/remove favourites menu to easily add or remove several channels in one go.

Add or remove one channel

With the **All**, **Radio** or **New** channel list on screen, select a channel and press **■** to mark or unmark as favourite. The channel is added or removed from the Favourites list.

Add or remove several channels

To open the Add/remove favourites menu . . .

- 1 - With the Favourites list on screen, select a channel.
- 2 - Press **≡ OPTIONS** and select **Add/remove favourites** and press **OK**. In this list with all channels, select a channel and press **OK** to mark or unmark this channel as a favourite channel. You do not need to use the colour keys. Select a next channel to mark or unmark.
- 3 - To finish, press **■ Done**. The channels are added or removed from the Favourites list.

Reorder favourite channels

You can only reorder channels in the Favourites list.

To reorder channels . . .

- 1 - In the Favourites list, select the channel you want to move in the list.
- 2 - Press **■ Move**.
- 3 - With the arrow keys, position the channel where you want it. Alternatively, you can enter the new position directly with the number keys.
- 4 - Press **OK** to confirm the position or press **■ Cancel**. You can now select another channel to move.

4.4

Lock satellite channels

Lock a channel

To prevent children from watching a channel, you can lock a channel. To watch a locked channel, you must enter the 4-digit Child lock code.

To lock a channel . . .

- 1 - While watching a channel, press **≡ LIST** to open the channel list.
- 2 - In any channel list, select the channel you want to lock, press **≡ OPTIONS** and select **Lock channel**. In the channel list, a locked channel is marked with a lock **🔒**.

To unlock a channel, select a locked channel in the channel list and select the **Unlock channel** option. You will need to enter the Child lock code. You cannot lock a programme from a connected device - e.g. a connected digital receiver.

Use an age rating

To prevent children from watching a programme not suitable for their age, you can use an age rating.

Some digital broadcasters have age rated their programmes. When the age rating of a programme is equal to or higher than the age you have set as age rating for your child, the programme will be locked. For some operators, the TV locks programmes with a higher rating only.

To watch a locked programme, you have to enter the 4-digit Child lock code. The age rating is set for all channels.

To set an age . . .

- 1 - Press **🏠**, select **⚙ Setup** and press **OK**.
- 2 - Select **Satellite settings** > **Child lock** > **Parental rating** and press **OK**.
- 3 - Enter a 4-digit Child lock code. If you did not set a code yet, select **Set code** and press **OK**. Enter a 4-digit Child lock code and confirm. Now you can set an age rating.
- 4 - Set an age for your child and press **OK**.
- 5 - Press **➡**, repeatedly if necessary, to close the menu.

To switch off the parental age rating, select **None** as age setting.

Child lock code

You can set or change the Child lock code.

To set or change the code . . .

- 1 - Press **🏠**, select **⚙ Setup** and press **OK**.
- 2 - Select **Satellite settings** > **Child lock** > **Set code** or **Change code** and press **OK**.
- 3 - If a code is set already, enter the current Child lock code and then enter the new code twice. The new code is set.

Forgotten your Child lock code?

If you forgot your code, you can override the current code and enter a new code.

- 1 - Press **⬆**, select **⚙ Setup** and press **OK**.
- 2 - Select **Satellite settings > Child lock > Change code** and press **OK**.
- 3 - Enter the overriding code **8888**.
- 4 - Now enter a new Child lock code and enter it again to confirm.

4.5

Satellite installation

About satellite installation

This TV has a built-in satellite DVB-S/DVB-S2 receiver. Connect the cable from your satellite dish directly to the TV. Use a coaxial cable fit for connecting a satellite antenna dish. Make sure your satellite dish is perfectly aligned before you start the installation.

Up to 4 satellites

You can install up to 4 satellites (4 LNBs) on this TV. Select the exact number of satellites you wish to install at the start of the installation. This will speed up the installation.

Unicable

You can use a Unicable system to connect the antenna dish to the TV. Select if you are installing satellites for a Unicable system, for 1 or for 2 satellites at the start of the installation.

MDU - Multi-Dwelling-Unit

The satellite receiver of this TV supports MDU on the Astra satellites and for Digturk on the Eutelsat satellite. MDU on Türksat is not supported.

Install satellites

You can install your satellites during the initial TV setup. The satellite installation follows the TV channel installation. If you only watch satellite channels, you can skip the TV channel installation.

You can always start a new satellite installation from the Setup menu.

To install satellite channels . . .

- 1 - Press **⬆**, select **⚙ Setup** and press **OK**.
- 2 - Select **Search for satellite** and press **OK**.
- 3 - Select **Install satellites** and press **OK**.
- 4 - The TV shows the current installation setting. If the current setting corresponds with the satellite installation you want, you can start searching for satellites. Select **Search** and press **OK**. Go to step 5. If the current setting is not the setting you want, select **Settings** and press **OK**. Go to step 4b.
- 4b - In the Settings menu, select the exact number of satellites you want to install. Or, if you use a Unicable setup, select **Unicable for 1 satellite** or **Unicable for 2 satellites** according the number of satellites you want to install for Unicable. Select the setting you want and press **OK**.

4c - If the exact number of satellites is set or you completed the Unicable settings, select **Search** and press **OK**.

5 - The TV will search for satellites available on the alignment of your antenna dish. This may take a few minutes. If a satellite is found, its name and reception strength are shown on screen.

6 - If a channel package is available for any of the satellites found, you can select the package you want.

7 - To install the channels of the satellites found, select **Install** and press **OK**. The TV shows the number of channels and radio stations found.

8 - To store the satellite settings, all satellite channels and satellite radio stations, select **Finish** and press **OK**.

Channel packages

About channel packages

Satellites can offer channel packages that bundle free channels (free-to-air) and offer a sorting that suits a country. Some satellites offer subscription packages - a collection of channels you pay for.

If you choose a subscription package, the TV might ask you to select a Quick or Full installation. Select **Quick** to install the channels of the package only or select **Full** to install the package and all other available channels too. We recommend a Quick installation for subscription packages. If you have additional satellites that are not part of your subscription package, we recommend a Full installation. All installed channels are put in the channels list All.

Update channel package

With **Update channel package**, you can bring back satellite channels that were in the satellite channel list before but are now missing. The missing channels were repositioned on the transponder by the satellite operator. The TV must be updated with the latest version of the channel package.

To download the latest version of the channel package . . .

- 1 - Go to the Philips support website **www.philips.com/support** and enter the type number of your TV.
- 2 - Click on **Software and drivers** and look for the file : **PredefinedSortingList**
- 3 - Download the file on your computer and copy the file on the root directory of a USB flash drive, not in a folder (if necessary, unzip the file first).
- 4 - Plug the USB flash drive into the TV and press **⬆**, select **⚙ Setup** and press **OK**.
- 5 - Select **Satellite settings > Channel installation > Update channel package** and press **OK**.
- 6 - The TV will copy the file and ask you to start a channel update immediately. Select **Yes** and press **OK**. This may take a few minutes. If you want to postpone the channel update, you can do it later with **Setup > Search for satellite > Update channels**.
- 7 - After the channel update is done, the missing channels should be back on their former position in the satellite channel list.

Unicable setup

The Unicable system

You can use a Unicable system to connect the antenna dish to the TV.

A Unicable system uses one cable to connect the satellite dish to all satellite receivers in its system. Unicable is typically used in apartment buildings. If you use a Unicable system, the TV will ask you to assign a user band number and corresponding frequency during the installation. You can install 1 or 2 satellites with Unicable on this TV.

If you notice some missing channels after a Unicable installation, another installation might have been done at the same moment on the Unicable system. Do the installation again to install the missing channels.

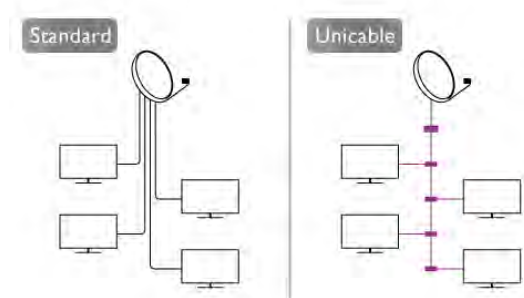

User band number

In a Unicable system, each connected satellite receiver must be numbered (e.g. 0, 1, 2 or 3 etc.). You can find the available user bands and their number on the Unicable switchbox. User band is sometimes shortened as UB. There are Unicable switchboxes that offer 4 or 8 user bands. If you select Unicable in the settings, the TV will ask you to assign the unique user band number for its built-in satellite receiver. A satellite receiver cannot have the same user band number as another satellite receiver in the Unicable system.

User band frequency

Next to the unique user band number, the built-in satellite receiver needs the frequency of the selected user band number. These frequencies are mostly shown next to the user band number on a Unicable switchbox.

Add a satellite

You can add an additional satellite to your current satellite installation. The installed satellites and their channels stay untouched. However, some satellite operators do not allow adding a satellite.

The additional satellite should be seen as an extra, it is not your main satellite subscription or not the main satellite of which you use its channel package. Typically, you would add a 4th satellite when you have 3 satellites already installed. If you have 4 satellites installed, you might consider removing one first to be able to add a new satellite.

Settings

If you currently have only 1 or 2 satellites installed, the current installation settings might not allow adding an extra satellite. If you need to change the installation settings, you must redo the complete satellite installation. You cannot use **Add satellite** if a change of settings is needed.

To add a satellite . . .

- 1 - Press **Home**, select **Setup** and press **OK**.
- 2 - Select **Search for satellite** and press **OK**.
- 3 - Select **Add satellite** and press **OK**. The current satellites are shown.
- 4 - Select **Add** and press **OK**. The TV will search for new satellites.
- 5 - If the TV has found one or more satellites, select **Install** and press **OK**. The TV installs the channels of the found satellites.
- 6 - To store the channels and radio stations, select **Finish** and press **OK**.

Remove a satellite

You can remove one or more satellites from your current satellite installation. You remove the satellite and its channels. However, some satellite operators do not allow removing a satellite.

To remove satellites . . .

- 1 - Press **Home**, select **Setup** and press **OK**.
- 2 - Select **Search for satellite** and press **OK**.
- 3 - Select **Remove satellite** and press **OK**. The current satellites are shown.
- 4 - Use the arrows keys to select the satellite you want to remove.
- 5 - Press **OK** to mark a satellite to remove. Press **OK** again to unmark.
- 6 - Select **Remove**, press **OK** and confirm. The satellites are removed.
- 7 - Select **Exit** and press **OK** to close Remove satellite.

Reorder and rename channels

You can reorder and rename satellite channels.

Reorder

You can only reorder channels in the Favourites list. For more information on Reordering satellite channels, press **LIST** and look up **Satellite, reorder channels**.

Rename channels

You can rename channels in the channel list.

- 1 - Select the channel you want to rename in one of the channel lists - **All**, **Favourites**, **Radio** or **New**.

2 - Press **RENAME**. You can enter text with the remote control keyboard or open the on-screen keyboard.

With the remote control keyboard

To delete a character, position the cursor behind the character and press **# del**.

To enter a character, press the character on the keyboard.

When you are ready, press **Enter** to select **Done**. Press **Enter** again to finish renaming.

For more information on using the keyboard, press **LIST** and look up **Remote control, keyboard**.

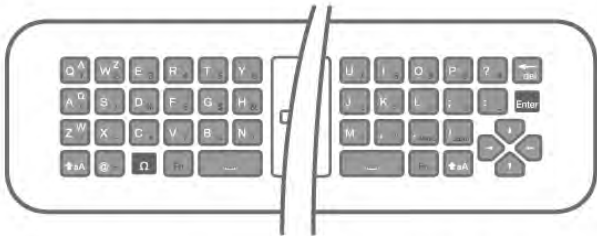

With the on-screen keyboard.

To open the on-screen keyboard, place the cursor in the name text field and press **OK**.

To delete the character in front of the cursor, press **Backspace**.

To enter a character, select the character with the arrow keys and press **OK**.

To select uppercase letters, press **Shift**.

To select numbers or special characters, press **Shift**.

When you are ready, press **Close** to close the on-screen keyboard.

To finish renaming, select **Done** and press **OK**.

Update satellite channels

Once a day, at 4 AM, the TV automatically updates the satellite channels. A channel update looks for new channels and adds them to the channel list. No longer available channels are removed and if a provider reorders its channel package, the channel list of the TV will be updated. The TV must be on standby to automatically update the satellite channels. Alternatively, you can do a channel update yourself at any moment.

New channels, found with the channel update, are marked with the letter **N** and collected in the channel list **New**. New channels are also added in the All channel list. New channels stay in the channel list New as long as you do not tune to them or mark them as a favourite.

Switch off the automatic channel update

You can completely switch off the TV at night to avoid a channel update. Alternatively, you can switch off the automatic update in the setup menu.

- 1 - Press **Home**, select **Setup** and press **OK**.
- 2 - Select **Satellite settings** > **Channel installation** > **Automatic channel update** and select **Off**.

Switch off the update for a specific satellite

- 1 - Press **Home**, select **Setup** and press **OK**.
- 2 - Select **Satellite settings** > **Channel installation** > **Automatic update option**.

3 - With the arrow keys, select the satellite you do not wish to update. Press **OK** to unmark the satellite.

4 - Select **Done** and press **OK** to close the menu. The TV will not update the channels from satellite you marked.

Start an update yourself

- 1 - Press **Home**, select **Setup** and press **OK**.
- 2 - Select **Search for satellite** and press **OK**.
- 3 - Select **Update channels** and press **OK**.
- 4 - If you want to check which satellites are set for updating, select **Settings** and press **OK**.
- 5 - With the arrow keys, mark or unmark the satellites for updating. Select **Done** and press **OK**.
- 6 - Select **Update** and press **OK**. The update may take a few minutes.
- 7 - Select **Finish** and press **OK**.

Extras

Channel installation extras

In the next chapters, you can find more information on . . .

- Programme language and subtitle language preferences
- Universal access settings for the hearing and visually impaired
- Manual installation - satellite transponder installation

Preferred languages and subtitles

Satellite channels can hold different audio languages, subtitle languages or Text languages. You can set the TV to automatically switch to the language, subtitle language or Text language you prefer, if this language is available on the channel or Text pages.

To set the your preferred language . . .

- 1 - Press **Home**, select **Setup** and press **OK**.
- 2 - Select **Satellite settings** and press **OK**.
- 3 - Select **Languages** and press **OK**. Select the setting you want.
- 4 - Press **Close**, repeatedly if necessary, to close the menu.

Hearing impaired

Some digital TV channels broadcast special audio and subtitles adapted for hearing impaired people. With Hearing impaired switched on, the TV automatically switches to the adapted audio and subtitles, if available. Before you can switch on Hearing impaired, you have to switch on **Universal access**.

Switch on

To switch on Hearing impaired, press **OPTIONS**, select **Universal access** and press **OK**. Select **Hearing impaired**, select **On** and press **OK**.

To check whether a hearing impaired audio language is available, press **OPTIONS**, select **Audio language** and look for an audio language marked with a **SI**.

If Universal access does not appear in the Options menu, switch on **Universal access** in Setup.
In **Help**, press **■ List** and look up **Universal access** for more information.

Audio description

Switch on

Digital TV channels can broadcast special audio commentary describing what is happening on screen. To be able to set the Audio description audio and effects, you have to switch on Audio description first. Also, before you can switch on Audio description, you have to switch on **Universal access**.

Audio description

With **Audio description**, a narrator's commentary is added to the normal audio.

To switch on the commentary (if available) . . .

- 1 - With **Universal access** switched on, press **≡ OPTIONS** and select the **Options** tab in the menu bar.
- 2 - Select **Audio description** and press **OK**.
- 3 - Select **On** and press **OK**.

You can check if an audio commentary is available.

In the Options menu, select **Audio language** and look for an audio language marked with a .

Speakers / Headphones

You can select where you want to hear the audio commentary. On the TV speakers only, on the headphones only or on both.

To set **Speakers / Headphones** . . .

- 1 - Press **⬆**, select **⚙ Setup** and press **OK**.
 - 2 - Select **Satellite settings > Languages > Audio description > Speakers / Headphones** and press **OK**.
 - 3 - Select **Speakers, Headphones** or **Speakers + headphones** and press **OK**.
 - 4 - Press **➡**, repeatedly if necessary, to close the menu.
-

Mixed volume

You can mix the volume of the normal audio with the audio commentary.

To mix the volume . . .

- 1 - Press **≡ OPTIONS** and select the **Options** tab in the menu bar.
 - 2 - Select **Universal access > Mixed volume** and press **OK**.
 - 3 - Use the arrows up and down to set the slider bar.
 - 4 - Press **OK** to confirm.
-

Audio effect

Some audio commentary can hold extra audio effects, like stereo or fading sound.

To switch on **Audio effects** (if available) . . .

- 1 - Press **⬆**, select **⚙ Setup** and press **OK**.
 - 2 - Select **Satellite settings > Languages > Audio description > Audio effects** and press **OK**.
 - 3 - Select **On** or **Off** and press **OK**.
 - 4 - Press **➡**, repeatedly if necessary, to close the menu.
-

Speech

The audio commentary can also hold subtitles for the words which are spoken.

To switch on these subtitles (if available) . . .

- 1 - Press **⬆**, select **⚙ Setup** and press **OK**.
 - 2 - Select **Satellite settings > Languages > Audio description > Speech** and press **OK**.
 - 3 - Select **Descriptive** (audio) or **Subtitles** and press **OK**.
 - 4 - Press **➡**, repeatedly if necessary, to close the menu.
-

Manual installation

Manual installation is intended for expert users.

You can use Manual installation to quickly add new channels from a satellite transponder. You need to know the frequency and polarization of the transponder. The TV will install all channels of that transponder. If the transponder was installed before, all its channels - the former and the new ones - are moved to the end of the channel list All.

You cannot use Manual installation if you need to change the number of satellites. If this is needed, you have to do a complete installation with Install satellites.

To install a transponder . . .

- 1 - Press **⬆**, select **⚙ Setup** and press **OK**.
 - 2 - Select **Satellite settings** and press **OK**.
 - 3 - Select **Channel installation** and press **OK**.
 - 4 - Select **Manual installation** and press **OK**.
 - 5 - If you have more than 1 satellite installed, select the satellite/LNB for which you want to add channels.
 - 6 - Set the **Polarization** you need. If you set the **Symbol rate mode** to **Manual**, you can enter the symbol rate in **Symbol rate** manually. Enter the **Frequency** and start searching for the transponder.
 - 7 - If a transponder is found, select **Store** and press **OK** to store the new transponder on the selected LNB.
 - 8 - Select **Exit** to leave the manual installation.
-

Troubleshooting

The TV cannot find the satellites I want or the TV installs the same satellite twice

- Make sure that the correct number of satellites is set in Settings at the start of the installation. You can set the TV to search for One, Two or 3/4 satellites.

A dual head LNB cannot find a second satellite

- If the TV finds one satellite but cannot find a second one, turn the dish a few degrees. Align the dish to get the strongest signal on the first satellite. Check the signal strength indicator of the first satellite on screen. With the first satellite set at the strongest signal, select **Search again** to find the second satellite.
- Make sure the settings are set to **Two satellites**.

Changing the installation settings did not solve my problem

- All settings, satellites and channels are only stored at the end of the installation when you finish.

All satellite channels are gone.

- If you use a Unicable system, make sure you assigned a unique user band number to the satellite receiver in the Unicable settings. It might be that another satellite receiver is using the same user band number.

Some satellite channels seem to have disappeared from the channel list.

If some channels seem to be gone or displaced, the broadcaster might have changed the transponder location of these channels. To restore the channel positions in the channel list, you can try an update of the channel package.

I cannot remove a satellite

- Subscription packages do not allow removing a satellite. To remove the satellite, you have to do a complete installation again and select another package.

Sometimes the reception is poor

- Check if the satellite dish is solidly mounted. Strong winds can move the dish.
- Snow and rain can degrade the reception.

3D

What you need

This is an Easy 3D TV.



To watch 3D you need to :

- tune to a TV channel that broadcasts programmes in 3D
- rent a movie in 3D from an online video store with Smart TV
- watch a movie in 3D from a 3D Blu-ray Disc, a USB device or computer

For an extra pair of glasses order the Philips Passive 3D glasses PTA417 or PTA426 (sold separately). Other 3D glasses might not be supported.

Your passive 3D glasses

Using the glasses

When a 3D programme is shown on screen, simply put on the 3D glasses to watch the programme in 3D.

Recommended viewing height

For best picture quality, when watching passive 3D, your eyes should be level with the centre of the screen.

Care of the 3D glasses

- Use a clean soft cloth (microfiber or cotton flannel) to clean the lenses to avoid scratching them.
- Do not use cleaning chemicals containing alcohol, solvent, surfactant, or wax, benzene, thinner, mosquito repellent or lubricant. Using these chemicals can cause discoloration or cracks.
- Do not expose the 3D glasses to direct sunlight, heat, fire or water. This may result in a product malfunction or fire.
- Do not drop, bend or apply force to the lenses of the 3D glasses.

Watch 3D

3D switching

The first time a 3D signal is detected, you can set your preference on how to start 3D in the future.

To switch to 3D automatically, select **Automatic**.

To show a notification first, select **Notify**.

To never switch to 3D, select **No 3D**.

You can still change this preference in the **Setup** menu > **TV settings** > **3D** > **Switch to 3D**.



Start 3D

When the TV switches to 3D or when a notification is shown that 3D is available, put on your 3D glasses.

If the TV cannot detect the 3D signal (the 3D signal tag is missing), the 3D programme is shown as a double image on screen. To switch to 3D, press **3D** and select **Side by side** or **Top / bottom** according to the double image positions.

Stop 3D

To stop watching 3D, press **[[[OPTIONS**, select **3D depth** and select **Off**.

3D is switched to 2D when you switch to another channel or connected device.

2D to 3D conversion

You can convert any 2D programme to watch it in 3D.

To convert a 2D programme to 3D, press **3D**, select **2D to 3D conversion** and confirm with **OK**.

To stop the 2D to 3D conversion, press **3D** and select **2D** and press **OK** or switch to another activity in the Home menu. The conversion will not stop if you switch between TV channels.

You can change the depth of 3D for a weaker or stronger 3D effect in the 2D to 3D conversion.

To change the 3D depth, press **[[[OPTIONS** and select **3D depth**. Select **Off** (no 3D), **Less** (less 3D depth), **Normal** (optimal 3D quality) or **More** (more 3D depth).

Optimal 3D viewing

For an optimal 3D viewing experience, we recommend that you:

- sit at least 3 times the height of the TV screen away from the TV, but no further than 6 meters away.
- avoid fluorescent lighting (such as TL lighting or certain energy saving light bulbs which operate on a low frequency) and direct sunlight as they may interfere with the 3D experience.

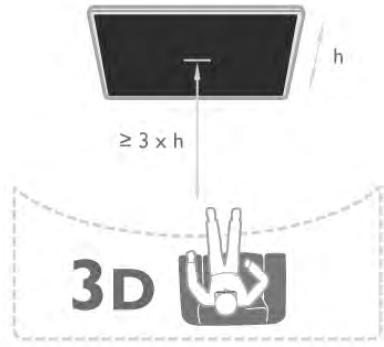

5.5

Health warning

- Watching 3D is not recommended for children under the age of six.
- If you or your family have a history of epilepsy or photosensitive seizures, consult a medical professional before exposing yourself to flashing light sources, rapid image sequences or 3D viewing.
- **If you experience any discomfort, stop watching 3D and do not immediately engage in any potentially hazardous activity (for example driving a car) until your symptoms have disappeared. If symptoms persist, do not resume watching 3D without consulting a medical professional first.**
- To avoid discomfort such as dizziness, headache or disorientation, we recommend not watching 3D for extended periods of time.
- Do not use the 3D glasses for any purpose other than watching 3D TV.
- If you normally wear corrective glasses or use contact lenses, wear the 3D glasses together with these glasses or lenses.
- Keep the glasses away from small children to avoid the swallowing of small parts or batteries.
- Parents should monitor their children during 3D viewing and ensure they do not experience any discomfort as mentioned above. Watching 3D is not recommended for children under 6 years of age as their visual system is not fully developed yet.
- Avoid the use of the 3D glasses in case of eye infection or other diseases transmitted by contact (e.g. conjunctivitis, head lice, etc.). Only start using the 3D glasses again when the infection has disappeared completely.

Smart TV

6.1

Home menu

From the Home menu, you can start any activity you can do with the TV.

Open the Home menu to start watching TV or start watching a disc on your Home Theatre System. Also in the Home menu, you can open Smart TV to surf the Internet, start Skype or open Help if you need information on using the TV.

Open the Home menu

To open the Home menu, press .

Select an activity using the arrow keys and press **OK** to start the activity.

To close the Home menu without changing the current activity, press .



- TV

Select **TV** and press **OK** to watch TV channels.

- Satellite

Select **Satellite** and press **OK** to watch satellite channels (only for TVs with a built-in satellite tuner).

- Smart TV

Select **Smart TV** and press **OK** to open the Smart TV start page.

- Source

Select **Source** and select a connected device in the list underneath the icon. Press **OK** to switch to the selected device.

- TV guide

Select **TV guide** and press **OK** to open a list of the current and scheduled TV programmes of your channels.

- Recordings

Select **Recordings** and press **OK** to open the list of your recordings.

- Skype

Select **Skype** to make video calls for free.

- Setup

Select **Setup** to install channels or adjust all TV settings.

- Help

Select **Help** and press **OK** to open the on screen Help. You can look up a topic in an alphabetical list.

Smart TV Apps

What you need

To enjoy Smart TV Apps you must connect the TV to a router with a high-speed (broadband) connection to the Internet. You can use a home network connected to the Internet. You do not need a computer.

In **Help**, press  **List** and look up **Network** for more information.

Tip

To enter text or to navigate an Internet page more easily, you can consider to connect a USB keyboard and a USB mouse to the TV.

In **Help**, press  **List** and look up **USB keyboard** or **USB mouse** for more information.

Configure

The first time you open Smart TV, you need to configure your connection. Read and agree to the terms and conditions to continue. To leave Smart TV, press .

Register

Register with Club Philips.

Select **Register** and press **OK**.

Enter your email address, select **Continue** and press **OK**.

Confirm the email address.

Parental control

To lock Adult 18+ rated apps, switch on Smart TV parental control by selecting **Enable** and then press **OK**.



Enter an unlock PIN code of your choice.

Confirm your PIN code. Adult 18+ rated apps are now locked.

To open a locked app, select the app and press **OK**. The TV will ask you to enter your 4-digit code.

Reconfigure

To reconfigure your connection with Smart TV, clear the Internet memory on the TV.

To clear the Internet memory, press  and select  **Setup** and press **OK**.

Select **Network settings** > **Clear Internet memory** and press **OK**.

Smart TV start page

The Smart TV start page is your link to the Internet. You can rent movies online, read newspapers, watch videos and listen to music, also shop online, open your social network page (Facebook, Twitter, . . .) or watch TV programmes when it suits you with Online TV. To do this, you open Apps - Internet sites which are tailored for TV. With your TV connected to the Internet, you can open Smart TV.

Open Smart TV

To open the Smart TV start page, press **Smart TV**. Alternatively, you can press **Home**, select **Smart TV** and press **OK**.



The TV connects to the Internet and opens the Smart TV start page. This may take a few seconds.



- 1 - Now on your TV
- 2 - Your Apps
- 3 - App gallery
- 4 - Internet
- 5 - Recommended Apps
- 6 - Search
- 7 - Colour keys for control

Your Apps

You start Apps from the Smart TV start page. If the start page does not hold any Apps yet, you can add Apps from the App gallery.

The list of your Apps can be several pages long. Use the arrow keys to go to the next or previous page. Alternatively, press **CH+** (Next page) or **CH-** (Previous page).

App gallery

In the App gallery you find all available Apps.

Internet

The **Internet** App opens the World Wide Web on your TV. On your TV, you can view any Internet website but most of them are not tailored for a TV screen.

- Some plug-ins (e.g. to view pages or videos) are not available on your TV.
- Internet pages are shown one page at a time and full screen.

Recommended Apps

In this window, Philips presents a range of recommended Apps for your country, Apps for Online TV or a selection of rental movies from Video stores. You can select and open them from the Recommended Apps window.

Search

With Search, you can search the App gallery for relevant Apps.

Enter a keyword in the text field, select **Q** and press **OK** to start searching. You can enter names, titles, genres and description keywords to search.

Alternatively, you can leave the text field empty and search for the most popular searches/keywords for a range of categories. In the list of found keywords, select a keyword and press **OK** to search for items with that keyword.

In the list of Apps on the Smart TV start page you can . . .

Remove an App

To remove an App from the Smart TV start page, select the App icon and press **Remove**.

Move an App

To reposition an App in the list, select the App icon, press **Move** and use the arrow keys to reposition the App. Press **OK** to confirm the position.

Lock an App

To lock an App, select the App icon and press **Lock**. When you lock an App, you must enter the 4 digit PIN code you set for Parental control when you configured Smart TV. In the list, a locked App is marked with a lock **🔒**.

To unlock an App, select the App icon and press **Unlock**. You must enter the 4 digit PIN code to unlock.

Feedback on an App

Select the App and press **Feedback** to select a 'like' or 'don't like' button and send a suggestion or remark to us. You can also report an App malfunction.

Close Smart TV

To close the Smart TV start page, press **Home** and select another activity.

TP Vision Netherlands B.V. bears no responsibility regarding the content and the quality of the content provided by the content service providers.

Using Apps

To start an App, you must add it to your list of Apps in the Smart TV start page first.

You can add Apps to your list from the App gallery.

App gallery

In the App gallery you find all available Apps. The App gallery shows Apps in lists per country.

To open the App gallery, select the App gallery icon on the Smart TV start page and press **OK**.

In the App gallery, use the arrow keys to select items in the page.

To view the Apps ordered by category, press **All Apps**, select a category and press **OK**.

To view the Apps from another country, press **Country**, select a country and press **OK**.

To lock an App, select the App icon and press **Lock**. When you lock an App, you must enter the 4 digit PIN code you set for Parental control when you configured Smart TV. In the list, a locked App is marked with a lock **🔒**.

To unlock an App, select the App icon and press **Unlock**. You must enter the 4 digit PIN code to unlock.

To return to the Smart TV start page, press **≡ LIST** or **↶**.

Add an App to your list

In the App gallery, select the App icon and press **OK**.
Select **Add** and press **OK**.

Alternatively, select **Add and move** to add it and immediately position the App where you want it in your list.

Start an App

To start an App, press **⬆️** and select **Smart TV**.
On the start page, select an App icon and press **OK**.
In an App, press **↶** to go back 1 step or page.

Reload an App page

If an App page did not load properly, press **≡ OPTIONS** and select **Reload** to reload the page.

Zoom

You can zoom in on an App page.
To zoom a page, press **≡ OPTIONS** and select **Zoom page**.
Use the slider bar to set the zoom level.
Return to normal view by resetting the slider bar.

View security info

You can check the security level of an App page.
On an App page, press **≡ OPTIONS** and select **Security info**. If a lock **🔒** is shown next to the loading animation on the bottom of the screen while loading a page, the transfer is secured.

Close an App

To close an App and return to the Smart TV start page, press **Smart TV**.

Rental video Apps

With the video store Apps in Smart TV, you can rent your favourite movie from an online rental video store. You can pay securely with your credit card.

Rent a movie

- 1 - Open a Video store App in your list of Apps or select a recommended video on the Smart TV start page.
- 2 - Select a movie.
- 3 - Make the online payment.
- 4 - Download the video.
- 5 - Start watching. You can use the **▶** (Play) and **⏸** (Pause) keys.

Most Video stores ask you to create a log in account.

Streaming video

With this TV, you can watch rental movies sent as a streaming video format. You can almost instantly watch the movie. When the rental video store uses video streaming, you might need a USB Hard Drive to store some video buffer. You can pause or restart a rental movie sent with streaming video.
If you have a USB Hard Drive connected, you can also download rental movies from video stores that offer movie downloading only. You can pause or restart a downloaded rental movie.

Consult the video store regarding the rental duration of rental movies.

Internet traffic

Streaming or downloading many videos may exceed your monthly Internet traffic limit.

Online TV

With the Online TV App on the Smart TV start page*, you can watch TV programmes you missed or watch programmes whenever it suits you best.

Open Online TV

To open the Online TV App, press **⬆️** and select **Smart TV**.
On the start page, select the **📺 Online TV** icon and press **OK**.

Select a programme on the page and press **OK** to start watching.

You can use the **▶** (Play) and **⏸** (Pause) keys.

List per broadcaster

To view the Online TV programmes ordered by broadcaster, press **📺 All broadcasters**.
Select a broadcaster and press **OK**.

* If available in your region.

6.3

Videos, photos or music

With USB or Network computer

What you need

You can view your photos or play your music and videos from a connected USB flash drive or USB Hard Drive. If you have a computer in your home network, you can view and play your files from your computer on the TV.

From a USB device

With the TV switched on, plug in a USB flash drive or USB Hard Drive to one of the USB connections. The TV detects the device and lists your files.
If the list does not appear automatically, press **SOURCE**, select **Browse USB** and press **OK**.



Warning

If you try to pause or record a programme with a USB Hard Drive connected, the TV will ask you to format the USB Hard Drive. This formatting will delete all current files on the USB Hard Drive.





From a computer

If the TV and the computer are in the same network, the TV can browse and play files stored on your computer. On your computer, you need to install media server software like Twonky™ to share your files with the TV. The TV shows your files and folders as they are organised on your computer. To browse the files on your computer, press **SOURCE**, select **Browse network** and press **OK**.



Menu bar and sorting

With a USB device connected, the TV sorts the files by type. Navigate to the menu bar and select the type of file you are looking for. If you browse files from a computer, you can only browse the files and folders as they are organized on the computer.



The menu bar

Navigate to the menu bar and select the type of file you want to watch or play. Select  **Photos**,  **Music** or  **Videos**. Alternatively, you can open the  **Folders** view and browse your folders to look for a file.

Sorting

To browse your photos by date, month, year or alphabetically by name, press  **Sort**. To browse your music by album, artist, genre or alphabetically by name, press  **Sort**. Videos are sorted alphabetically.

View photos

To view photos, select  **Photos** in the menu bar, select a photo thumbnail and press **OK**. If there are several photos in the same folder, select a photo and press  **Slide show** to start a slide show of all photos in this folder. To jump to the next or previous photo, press **CH+** or **CH-**. To stop the slide show or close the photo, press  **LIST** or  (Stop).

You can play music with a slide show. Start the slide show after you started the music.
1 - Select a song or a folder with songs and press **OK**.
2 - Press  **LIST** and select  **Photos**.
3 - Select a photo or a folder with photos and press  **Slide show**.

Info

To view info on a photo (size, creation date, file path, etc.), select a photo and press  **INFO**. Press again to hide the info.

Options

Press  **OPTIONS**.
- **Shuffle**
Shows your photos randomly.
- **Repeat**

Plays the slide show continuously.

- Slide show speed

Sets the speed of the slide show.

- Slide show transition

Sets the style of the photo transitions.

To close **Browse USB** or **Browse network**, press  and select another activity.



Play music



To play music, select  **Music** in the menu bar, select a song and press **OK**.

If there are more songs in the same folder, press  **Play all** to play all songs in this folder.

To jump to the next or previous song, press **CH+** or **CH-**.

To pause the music, press **OK**. Press **OK** again to continue.

To make a 10-second jump in a song or 10-second jump back, press  or .

To rewind or fast forward, press  or . Press the keys several times to speed up - 2x, 4x, 8x, 16x, 32x.

To stop the music playback, press  (Stop).

If you press  **LIST** or , the music keeps on playing.

Info

To view song info (title, artist, duration, etc.), select the song and press  **INFO**. Press again to hide the info.

Options

Press  **OPTIONS**.

- Shuffle



Plays your music randomly.

- Repeat

Plays the song once or continuously.

Screen off

If you only listen to music, you can switch off the TV screen to save energy.

To switch off the screen, press  **OPTIONS**, select  **Eco settings** in the menu bar, select **Screen off** and press **OK**. To switch the screen back on, press any key on the remote control.

To close **Browse USB** or **Browse network**, press  and select another activity.

Play videos



To play a video, select  **Videos** in the menu bar, select a video and press **OK**.

If there are more videos in the same folder, press  **Play all** to play all videos in this folder.

To jump to the next or previous video, press **CH+** or **CH-**.

To pause the video, press **OK**. Press **OK** again to continue.

To make a 10-second jump forward or backward in a video, press  or .

To rewind or go fast forward, press  or . Press the keys several times to speed up - 2x, 4x, 8x, 16x, 32x.

To stop the video playback, press  (Stop).

Info

To view info on a video (playhead position, duration, title, date, etc.), select the video and press **i** **INFO**. Press again to hide the info.

Options

Press **III** **OPTIONS**.

- Subtitles

If available, you can switch subtitles **On**, **Off** or **On during mute**.

- Shuffle

Plays your videos randomly.

- Repeat

Plays a video once or continuously.

- DivX® VOD

Opens the DivX registration.

To close **Browse USB** or **Browse network**, press **HOME** and select another activity.

DivX® VOD

This TV is DivX Certified® and plays high-quality DivX Video-On-Demand videos.

To play DivX VOD videos from a video store or from your computer, you must activate DivX VOD on the TV first. The DivX VOD activation of your TV is free of charge.

Register

If the TV is not yet activated when you start the playback of a rental DivX video, the TV will show you the DivX registration code to activate this TV.

To register follow these steps.

- 1 - When the TV shows the 8 or 10-digit registration code, write down the code and go to <http://vod.divx.com> on your computer
- 2 - Download and install the DivX player software on your computer.
- 3 - Start the DivX player software and create a DivX Account (VOD > Create a DivX Account . . .)
- 4 - In the DivX player, register the TV with the registration code of the TV (VOD > Register a DivX Certified Device . . .)
- 5 - Download and save the registration video when asked.
- 6 - Transfer the registration video to the TV. You can use a USB flash drive or your network connection.
- 7 - Play the registration video on your TV. This completes the registration and activates DivX on your TV.

Consult the DivX website for detailed support.

Deregister

You can deregister the TV and deactivate DivX VOD playback. To deregister, press **SOURCE**, select **Browse USB** and press **OK**.

Press **III** **OPTIONS**, select **DivX® VOD** and press **OK**.

DivX®, DivX Certified® and associated logos are trademarks of Rovi Corporation or its subsidiaries and are used under license.

ABOUT DIVX VIDEO: DivX® is a digital video format created by DivX, LLC, a subsidiary of Rovi Corporation.

This is an official DivX Certified® device that plays DivX video. Visit divx.com for more information and software tools to convert your files into DivX videos.

ABOUT DIVX VIDEO-ON-DEMAND: This DivX Certified® device must be registered in order to play purchased DivX Video-on-Demand (VOD) movies. To obtain your registration code, locate the DivX VOD section in your device setup menu. Go to vod.divx.com for more information on how to complete your registration.

With Wi-Fi Miracast

What is Wi-Fi Miracast?

Your TV is a **Wi-Fi Certified Miracast™** device. With Miracast™, you can watch and share the screen of your smartphone, tablet or computer on your TV screen wirelessly. You can stream videos (audio and video), share photos or anything else that's on screen of the device. No need to connect the device to your home network. Both the TV and the device must be Wi-Fi Certified Miracast™ devices and have Miracast switched on.



For more information on Wi-Fi Certified Miracast™ go to www.wi-fi.org

Wi-Fi®, the **Wi-Fi CERTIFIED** logo, the **Wi-Fi** logo are registered trademarks of the Wi-Fi Alliance. **Wi-Fi CERTIFIED Miracast™**, **Miracast™** are trademarks of the Wi-Fi Alliance.

Switch on Miracast

The TV comes with Miracast switched **On** and is ready to show the screen of a device with Miracast.

Switch off Miracast

If you do not want the TV to receive requests for screen sharing from other devices, you can switch off Miracast on the TV.

- 1 - Press **HOME**, select **Setup** and press **OK**.
- 2 - Select **Network settings** > **Wi-Fi Miracast** > **Off** and press **OK**.
- 3 - Press **BACK**, repeatedly if necessary, to close the menu.

Share a screen on TV

To share the screen of your smartphone, tablet or computer on the TV . . .

- 1 - Switch on the TV.

2 - On the device, open an application such as Wi-Fi Miracast, Wi-Fi Direct™, Intel®Wireless Display* or similar and start scanning for other Miracast devices.

3 - In the list of found devices, select the TV and connect.

4 - On the TV, agree to the request to connect to the TV. You might be asked to enter a PIN code from the device on the TV - enter the numbers with the digit keys on the remote control. Alternatively, you might be asked by the TV to enter a PIN code on the device. If you connect, the TV will show the screen of the device.

5 - On the device, select the videos, photos or files you want to watch on TV.

* Miracast is supported by WiDi 3.5 onwards.

Stop sharing a screen

From the device

With the application you use to start Miracast, you can disconnect and stop watching the screen of the device on TV. The TV will switch back to the last selected programme.

From the TV

To stop watching the screen of the device on TV, you can . . .

- press **TV** to watch a TV broadcast
- press **↑** to start another activity on TV
- press **↔ SOURCE** to open the Source menu and select a connected device.

Block a device

The first time you receive a request to connect from a device, you can block the device. This request, and all requests in the future, from this device, will be ignored.

To block a device, select **Block . . .** in the request window and press **OK**.

Unblock all devices

All previously connected and blocked devices are stored in the Wi-Fi Miracast list of connections. If you clear this list, all blocked devices will be unblocked.

To unblock all blocked devices . . .

- 1 - Press **↑**, select **⚙ Setup** and press **OK**.
- 2 - Select **Network settings > Wi-Fi Miracast connections** and press **OK**.
- 3 - Select **Clear all** and press **OK** to clear the list.
- 4 - Press **➔**, repeatedly if necessary, to close the menu.

Blocking a previously connected device

If you want to block a device that you previously connected, you need to clear the Wi-Fi Miracast connections list first. If you clear this list, you will have to confirm or block the connection for every device again.

Screen delay

The normal delay when sharing a screen with Miracast is about 1 second. The delay might be longer if you are using older devices/computers with less processing power.

Specifics

- Miracast on this TV is subject to the HDCP protocol and cannot display copy-protected premium content sent by a device.
- The maximum video resolution supported is 720p.

6.4

Multi room

What is Multi room ?



With **Multi room** you can wirelessly send -stream- digital TV channels from another Philips TV to this TV. You can stream any digital TV channel from the other TV, also channels from a subscription smart card. If you can watch the digital channel on the other TV, you can watch it on this one. If you don't have an antenna connection in the room where this TV is, you can use Multi room to watch the digital channels the other TV has to offer.

If the type number of both TVs, end with an eight e.g. (the screen size) **PFLxxx8**, you can switch on the other TV if it's in standby with this TV. Also, recordings made with the other TV and stored on its connected HDD can be watched on this TV.

Streaming a TV channel with Multi room will reduce the resolution from HD to SD.

You cannot stream radio channels (audio only).

What you need

To stream and watch TV channels from another Philips TV, the other TV needs to serve as a TV channel source. Both TVs must be connected to your wireless home network. In Help, read the chapter **Network** in **Setting up** to connect this TV to your home network.

If the other Philips TV has a model number that ends with a seven, e.g. (the screen size) **PFLxxx7** and it has the latest software, you're all set.

On the other TV, read the Help chapter on **Software update** to update its TV software.

Switch on from standby

If the type number of both TVs, end with an eight e.g. (the screen size) **PFLxxx8**, you can switch on the other TV from standby with this TV. Make sure you switch on the setting **Switch on with Wi-Fi** on the other TV.

To switch on **Switch on with Wi-Fi**, press **Home**, select **Settings** **Setup** and press **OK**. Select **Network settings** > **Switch on with Wi-Fi** and select **On** and press **OK**.

If all conditions on both TVs are met, you can use Multi room.

Using Multi room

First time use

When you start Multi room for the first time, switch on both TVs.

Once this TV made a connection with the other TV, the other one will appear automatically in the Browse network menu even when it's in standby.

Stream a TV channel

With Multi room, you can watch the current TV channel or open the channel list of the other TV. If you select a channel from the list, the other TV will also switch to the channel you selected. If the other TV has a built-in satellite tuner with installed channels or a connected Hard Disc Drive (HDD) with recordings*, you can also watch these on this TV. You cannot switch channels while the other TV is recording, in Pause TV mode or using Skype.

To stream and watch a TV channel from the other TV . . .

- 1 - Make sure the other TV is in standby* or switched on.
- 2 - On this TV, press **Source**, select **Browse network** and press **OK**.
- 3 - If the TV is not yet connected to your home network, the network installation will start automatically. If the TV is already connected, go to step 4.
- 4 - In the **Browse network** menu, select the name of the other TV and press **OK**. If you have several TVs in your home, you might want to change the name of the other TV. You can do that on the TV itself.
- 5 - Select what you want to watch from the other TV . . .
 - to watch the current channel of the other TV, select **Current channel** and press **OK**.
 - to open the channel list of the other TV, select **Watch TV** and press **Right**.
 - to open the satellite channel list of the other TV, select **Watch satellite** and press **Right**.
 - to open the list of recordings* on the other TV, select **Watch recordings** and press **Right**.
 - you can switch channels with **CH+** and **CH-**. You cannot switch channels when the other TV is recording, in Pause TV mode or using Skype.

* To switch on the other TV from standby or to watch its recordings from a connected HDD, both TVs must have a type number that ends with an eight, e.g. (screen size) **PFLxxx8**.

TV name

To change the TV name, press **Home** > **Setup** > **Network settings** > **TV network name**.

6.5

Pause TV

You can pause a TV broadcast and resume watching it later. Only digital TV channels can be paused. You must connect a USB Hard Drive to buffer the broadcast. You can pause a broadcast for a maximum time span of 90 minutes. In **Help**, press **List** and look up **USB Hard Drive, installation** for more information.

Pause or resume a broadcast

To pause a broadcast, press **Pause** (Pause). A progress bar appears briefly on screen.

To call up the progress bar, press **Pause** (Pause) again.

To resume watching, press **Play** (Play). The icon on screen indicates you are watching a paused broadcast.



Back to the actual TV broadcast

To switch back to the actual TV broadcast, press **Stop** (Stop).



The moment you switch to a digital channel, the USB Hard Drive starts buffering the broadcast. When you switch to another digital channel, the broadcast of the new channel is buffered and the broadcast of the former channel is cleared. When you switch to a connected device (a Blu-ray Disc player or digital receiver) the USB Hard Drive stops buffering and the broadcast is cleared. Also when you switch the TV to standby the broadcast is cleared. Whilst recording a programme on the USB Hard Drive, you cannot pause a broadcast.

Instant replay

Whilst watching a broadcast from a digital TV channel, you can easily instant replay the broadcast.

To replay the last 10 seconds of a broadcast, press **Pause** (Pause) and press **Left** (Left).

You can press **Left** repeatedly until you reach the start of the broadcast buffer or the maximum time span.

Progress bar

With the progress bar on screen, press **Rewind** (Rewind) or press **Forward** (Forward) to select from where you want to start viewing the paused broadcast. Press these keys repeatedly to change speed.

Specifics

• The Audio Description audio (commentary) for the visually impaired is not available for playback in Pause TV or Recording.

- You can buffer the digital (DVB) subtitles of a channel. You cannot buffer subtitles that come from Text services. To check if digital (DVB) subtitles are available, tune to the TV channel and press **⏏** **OPTIONS**, select **≡ Options** in the menu bar and select **Subtitle language** to open the list of Subtitles. You can only buffer a subtitle language preceded with a **DVB** icon.

6.6

Recording

Record a programme

What you need

To record a TV programme you need . . .

- a connected USB Hard Drive formatted on this TV
- digital TV channels installed on this TV (the channels you watch with Watch TV)
- to receive channel information for the built-in TV guide (from the broadcaster or from the Internet)

In **Help**, press **■** **List** and look up **USB Hard Drive, installation** to install a USB Hard Drive.

Record now

To record the programme you are watching, press **●** (Record) on the remote control.



If you receive TV guide information from the Internet, you can adjust the end time of the recording in the pop-up window before you confirm the recording.

If you receive TV guide information from the broadcaster, the recording starts immediately. You can adjust the end time of the recording in the list of recordings.

To stop recording, press **■** (Stop).

Schedule a recording

You can schedule a recording of an upcoming programme for today or a few days from today (maximum of 8 days away).

1 - To schedule a recording, press **Guide**.

On the TV guide page, select the channel and programme you wish to record.

You can enter the channel number to jump to the channel in the list.

Press **▶** (Right) or **◀** (Left) to scroll through the programmes of a channel.

To change the date of the list, press **⏏** **OPTIONS** and select **Select day**. In the list, select the day you want and press **OK**. If the TV guide comes from the Internet, you can select the date at the top of the page and press **OK**.

2 - With the programme highlighted, press **■** **Record** or press **⏏** **OPTIONS** and select **Record**. The TV adds some time buffer at the end of the program. You can add some extra buffer if needed.

3 - Select **Schedule** and press **OK**. The programme is scheduled for recording. A warning will show automatically when overlapping recordings are scheduled.

If you plan to record a programme in your absence, remember to leave the TV switched to standby and the USB Hard Drive switched on.

List of recordings

To view the list of recordings and scheduled recordings, press **⏏**, select **Ⓛ** **Recordings** and press **OK**.

In this list, you can select a recording to watch, remove recorded programmes, adjust the end time of an ongoing recording or check the free disc space. Also in this list, if the TV guide comes from the Internet, you can schedule a recording for which you set the beginning and end time yourself, as a timed recording not linked to a programme. To set a timed recording, select **Schedule recording** at the top of the page and press **OK**. Set the channel, date and time span. To confirm the recording, select **Schedule** and press **OK**.

Remove a scheduled recording

To remove a scheduled recording, select the upcoming recording in the list and press **OK**. Alternatively, you can select the scheduled recording and press **⏏** **OPTIONS** and select **Cancel recording**.

Specifics

- While recording a programme, you can watch a previously recorded programme.
- While recording, you cannot switch TV channels.
- While recording, you cannot pause the TV broadcast.
- To Record, broadcasters need a reliable clock setting. If you reset the TV clock manually, recordings may fail.
- The Audio Description audio (commentary) for the visually impaired cannot be recorded.
- You can record the digital (DVB) subtitles of channel. You cannot record subtitles that come from Text services. To check if digital (DVB) subtitles are available, tune to the TV channel and press **⏏** **OPTIONS**, select **≡ Options** in the menu bar and select **Subtitle language** to open the list of Subtitles. You can only record a subtitle language preceded with a **DVB** icon.

Watch a recording

To watch a recording, press **⏏**, select **Ⓛ** **Recordings** and press **OK**.

In the list, select the recording and press ► (Play) to start the playback.

You can use the ►► (Forward), ◀◀ (Rewind), || (Pause) or ■ (Stop) keys on the remote control.



Expired recording

Broadcasters can limit the number of days a recording can be viewed. A recording in the list can show the number of days before it expires.

Failed recording

When a scheduled recording was prevented by the broadcaster or when the broadcast was interrupted, a recording is marked as **Failed**.

Delete a recording

To delete a made recording, select the recording in the list, press **⏏** **OPTIONS** and select **Delete recording**.

In **Help**, press **■** **List** and look up **Record a program** for more information.



It's free

You can download the MyRemote App for free. If you want to add the functions Wi-Fi smart screen, a small cost may apply.

Languages

The following languages are available in the MyRemote App : English, German, French, Italian, Spanish, Portuguese, Dutch and Russian.

If the language set on your mobile device is not one of these languages, the MyRemote App language is switched to English.

The MyRemote App is continually being developed. Future versions will have new functions and will be gradually available. Regularly check the MyRemote App updates on the App stores.

Apple, iPhone and iPad are trademarks of Apple Inc., registered in the U.S. and other countries.

Android is a trademark of Google Inc.

Google Play is a trademark of Google Inc.

6.7

MyRemote App

About MyRemote App

What this App can do

The **MyRemote App** and this TV, offer . . .

- **Control** - use your smartphone or tablet as a TV remote control
- **SimplyShare** - share photos, music and videos from your smartphone or tablet
- **TV guide** - consult the TV schedule and switch the TV to the channel you want
- **MyRemote recording** - schedule a recording in the TV guide with your smartphone or tablet
- **Wi-Fi smart screen** - watch a TV channel on your smartphone or tablet

The MyRemote App v4.x is available for iPhone, iPad and Android™. The MyRemote App functions may vary according to version and operating system of the mobile device.

Using the App on other Philips TVs

MyRemote App with other TVs

You can use the MyRemote App on Philips TV models built from 2009 onwards.

If your TV is a 2009 model, you need to update the TV software and activate **JointSpace**. If you have a 2010 model, you only need to activate JointSpace on the TV. TV models from 2011 and onwards are ready to use the MyRemote App. To know in what year your TV was built, check the TV type number (E.g. xxPFLxxx4). If the last number is a '4' your TV is a 2009 model. If the last number is a '5' your TV is a 2010 model. A '6' for 2011, a '7' for 2012 and an '8' for 2013.

Home network



Home network

Your TV, smartphone, tablet and computer, must be linked up with your home network to enjoy the MyRemote App.

To connect the TV to your home network . . .

- 1 - Connect your network router to the Internet, if it was not connected yet (a broadband Internet connection).
- 2 - Connect the TV to your network router. You can do this wireless or wired.

In **Help**, press  **List** and look up **Network, wireless** or **Network, wired** for more information.

Media server software

Media server software

If you want to view your photos or play your music and videos from your computer on the TV, you have to install media server software on your computer. Setup this media server software to share your files on your home network.



In **Help**, press  **List** and look up **Media servers, supported** for the list of media server software that is compatible with the TV.

Digital Media Renderer - DMR

Digital Media Renderer - DMR

If your media files do not play on your TV, make sure that the **Digital Media Renderer** is switched on. As a factory setting, DMR is switched on.

To check if DMR is switched On . . .



- 1 - Press  and select  **Setup** and press **OK**.
- 2 - Select **Network settings** and press **OK**.
- 3 - Select **Digital Media Renderer - DMR** and press **OK**.
- 4 - Select **On** and press **OK**.
- 5 - Press , repeatedly if necessary, to close the menu.

TV network name

TV network name

If you have more than one TV in your home network, you can rename the TV in Network settings.

To rename your TV . . .



- 1 - Press  and select  **Setup** and press **OK**.
- 2 - Select **Network settings** and press **OK**.
- 3 - Select **TV network name** and press **OK** to show the current name. You can use the keyboard on the remote control to change the TV network name.
- 4 - Select **Done** and press **OK** when ready.

- 5 - Press , repeatedly if necessary, to close the menu.

Switch on with Wi-Fi - WoWLAN

You can switch this TV on from your smartphone or tablet if the TV is in standby. The setting **Switch on with Wi-Fi (WoWLAN)** must be set to **On**.

To switch this setting on . . .

- 1 - Press  and select  **Setup** and press **OK**.
- 2 - Select **Network settings** > **Switch on with Wi-Fi (WoWLAN)**.
- 3 - Select **On** and press **OK**.
- 4 - Press , repeatedly if necessary, to close the menu.

App download

To download the MyRemote App on your smartphone or tablet, you can use the QR codes on this page. Select the operating system (or device type) you need and use your QR code reader to go to the download page directly.

Apple iPhone

To download the app on your iPhone, go to the Apple App Store and look for the **Philips MyRemote App**.



Apple iPad

To download the app on your iPad, go to the Apple App Store and look for the **Philips MyRemote HD App**.



Google play

To download the app on your Android device, go to Google play and look for the **Philips MyRemote App**.



App menu

From the MyRemote **App menu**, you can start the different MyRemote App functions. Simply tap a function to open it. To go back to the App menu, tap the App menu button at the top of the page.

Tool tips

To know what the particular buttons of the App do, tap the  icon. The tool tips appear on top of the available buttons. To close the Tool tips, tap anywhere on the touchscreen.

Select device

In the MyRemote App menu, you can select the device - e.g. this TV - with which you want to use all the App functions. Tap the button **Select device** at the top right corner of the App menu.

You can check the compatibility of MyRemote with your other Philips products at the online support page of your product at www.philips.com/support. Also ensure your Philips product has been updated with the latest software.

App functions

SimplyShare

With **SimplyShare**, you can send media files like photos, music or videos from a device in your home network to another device in your network.*



To open SimplyShare in the MyRemote app, tap the **SimplyShare** button in the MyRemote App menu.

Select a device to send media from

- 1 - Tap the white bar at the top to open the list of available devices in your network.
- 2 - Tap a device in the list.

Select a device to play the media

- 1 - Tap the white bar at the bottom to open the list of available devices in your network.
- 2 - Tap a device in the list.

Select a media file

Some devices that send files offer them by type of media. If so, you can select the type of media you are looking for - **Music**, **Videos** or **Photos**.

- 1 - Tap the type of media you are looking for.
- 2 - In the list, tap the song, video or photo to play it on the device you selected.

Compatible media formats

A wide range of media formats can be played on your TV.

In **Help**, press  **List** and look up **Playback formats** for the list of compatible file formats for your TV.

* You can check the compatibility of MyRemote with your specific Philips product at the online support page of your product at www.philips.com/support. Also ensure your Philips product has been upgraded with the latest software.

TV guide

What you need

To view the TV guide of the TV on your smartphone or tablet

- there must be a TV guide with channel and programme information on the TV
- the TV guide information has to come from the Internet
- the TV guide of the TV must be linked up with the smartphone or tablet

For more information on the TV guide, press  **List** and look up **TV guide**.

MyRemote recording

To schedule a recording in the TV guide from your smartphone or tablet . . .



- connect and format a USB Hard Drive on your TV
- make sure the setting MyRemote recording is switched on
- before you use the MyRemote recording function, you must switch the TV in standby and back on again

For more information on connecting a USB Hard Drive, press  **List** and look up **USB Hard Drive**.

Setting up

To open the TV guide on your smartphone or tablet, the TV guide must be linked to your mobile device.

Also, first check if the TV guide on your TV is updated from the Internet.

- 1 - Press  and select  **Setup** and press **OK**.
- 2 - Select **TV settings** > **General settings** > **TV guide**.
- 3 - Select **From the Internet** and press **OK**.
- 4 - Press , repeatedly if necessary, to close the menu.

Link up with the TV



To link up your smartphone or tablet with the TV guide of the TV . . .

- 1 - Press **GUIDE** on the remote control to open the TV guide on TV.

- 2 - Press the  (yellow) key to open the list of detected mobile devices.
- 3 - Select **Link a mobile device** and press **OK** to view the code to link up.
- 4 - On the mobile device, start the MyRemote App and tap the **Setup** button on the home menu.
- 5 - Tap the **TV guide** item.
- 6 - Enter the code to link up.

The MyRemote recording setting

Make sure this setting is switched on to schedule a recording.

- 1 - Press  and select  **Setup** and press **OK**.
- 2 - Select **Network settings** > **MyRemote recording**.
- 3 - Select **On** and press **OK**.
- 4 - Press , repeatedly if necessary, to close the menu.

Using the TV guide

With the TV guide function, you can call up the TV guide of your TV on your smartphone or tablet. You can consult the TV schedule and read programme info. You can tap the programme title to switch the TV to the selected channel directly.

If you have a USB Hard Drive installed on your TV, you can schedule recordings on the TV from your smartphone or tablet.



Program

To open the TV guide, tap the TV guide button on the MyRemote App menu. The first time you tap the TV guide button, you will be asked to link up the tablet and TV, if you did not link up yet.

Schedule a recording

With the MyRemote App you can schedule a recording in the TV guide of the TV.

For more information on Recording, press  **List** and look up **Recording**.

Control

With the **Control** function on the MyRemote App menu, you turn your smartphone or tablet into a full remote control for your TV.



Control

Tap the **Control** button to select the TV (or Philips Blu-ray Disc player or Home Theatre System) to control. Tap the device icon to show its remote control.

Wi-Fi smart screen

What you need

With the **Wi-Fi smart screen** function, you can watch a digital TV channel from your TV on your smartphone or tablet. If you use an Android operating system, you can only view free-to-air TV channels.



Wi-Fi smart screen

What you need

To watch TV on your smartphone or tablet . . .

- you must have digital TV channels installed on your TV (the channels you watch with Watch TV)
- the TV must be switched on
- your home network must be a secured network. Secure your network with **WEP**, **WPA**, **WPA2** or set it up using **WPS**.
- you must have the setting **Wi-Fi smart screen** switched on. Press  (home) > **Setup** > **Network settings** > **Wi-Fi smart screen**.

Buy Wi-Fi smart screen

How to buy

Tap **Wi-Fi smart screen** in the **App menu** to open the function. If you did not purchase this function yet, you will be asked to buy it online. After the purchase, **Wi-Fi smart screen** opens automatically and you can start watching TV.

Parental rating

Some digital broadcasters have rated their programmes. When the rating is equal or higher than the rating you have set for your child's age, the programme will be locked. You will need a **PIN code** to unlock and watch the programme.

To switch on **Parental rating**, tap the **Setup** button on the App menu. Switch on **Parental rating**, set your PIN code and set an age. The parental rating in the MyRemote App is set for watching TV on your smartphone or tablet, not the TV.

If you have forgotten your PIN code, you need to reinstall the MyRemote App from the App store. On the purchase page for Wi-Fi smart screen, you can restore your purchase without cost.

Watch a TV channel

To watch a TV channel with the Wi-Fi smart screen function, tap **Wi-Fi smart screen** in the **App menu**. Wi-Fi smart screen will show the TV channel currently on TV. If the TV is switched to a connected device, you need to switch the TV back to **Watch TV** or to **Watch Satellite** (if a built-in satellite tuner is available).

Switch TV channels

To switch TV channels, swipe the touchscreen of your smartphone or tablet. Swipe to the right to watch the previous channel or swipe to the left to watch the next channel. The sequence of channels follows the TV channel list. You can also use the **Channel bar** to look for and switch to TV channels.

Pause TV and Recording

If you pause the TV broadcast on TV or start recording a broadcast with the TV (on a connected USB Hard Drive), the Wi-Fi smart screen function will stop.

Sound

The sound that comes with the TV channel is mono sound.

Subtitles

Subtitles on Wi-Fi smart screen are not supported.

Channel bar

To switch to a channel further up or down the TV channel list, you can call up the **Channel bar**.

To call up the **Channel bar**, tap the middle of your touchscreen once. The Channel bar appears at the bottom of the screen, together with the **Tool bar** at the top. You can swipe the Channel bar and look for a TV channel.

To switch to a TV channel, tap the channel icon once.

To close the Channel bar and Tool bar, tap the middle of the screen again.

Tool bar

In the Wi-Fi smart screen tool bar, you can select the picture format, select the TV or Satellite channel list (if available on TV), open the tool tips or switch the TV on standby.

To call up the **Tool bar**, tap the middle of your touchscreen once. The Tool bar appears at the top of the screen, together with the Channel bar.

To close the Tool bar and Channel bar, tap the middle of the screen again.

App menu button

To go back to the MyRemote App menu, tap the **App menu** button.

Scale

To scale the picture to just fit or completely fill the screen, tap the **Scale** button to toggle between fill or fit.

TV or Satellite

If you have a built-in satellite tuner in your TV, you can select the channel list of **Watch TV** or **Watch satellite**. The button shows which channel list is currently selected.

To change the current channel list, tap the button and tap **TV** or **Satellite** to select the channel list you want. If you do not have a built-in satellite tuner, there is no selection button.

Skype

What is Skype?

With **Skype™** you can make video calls on your TV for free. You can call and see your friends from anywhere in the world. Talk to your friends while watching them on the big screen of your TV.



To make a video call on Skype, you need the separately sold **Philips PTA317** TV camera with a built-in microphone and a good connection to the Internet.

The TV needs to be connected to the Internet before you can set up Skype. You can connect your TV either wireless or wired.

In **Help**, press **List** and look up **Network, wireless** to connect the TV to your home network and the Internet.

Skype account

To use Skype, you need to create a Skype account for yourself or for your family. You can create a new account for Skype on your TV or on your computer.

Skype Credit or Skype Subscriptions

With Skype, for a little cost, you can also call phones or mobile phones. Using your computer you can buy Skype Credit or take a Skype subscription at www.skype.com

Start Skype

Install the camera

Connect the TV camera cable to one of the USB connections on the TV.

Bend the small clamp as shown in the illustration below and position the camera on the top of the TV.

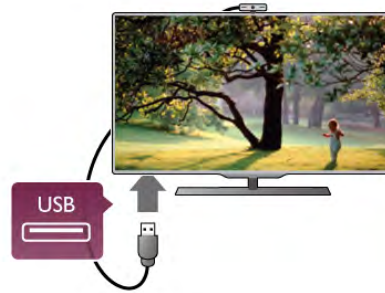

Point the camera to the position you usually sit at. In the Skype settings, you can test the camera, check its viewpoint or set the zoom level.

You can position the camera anywhere you want but it is recommended to put it away from the speakers of the TV.

If the TV camera is not connected, Skype will not start.

Sign in - New account

With the TV connected to the Internet and the TV camera mounted or built-in, you can start Skype on your TV.

To open the Skype sign-in page, press **Home** to open the Home menu, select **Skype** and press **OK**.

Enter your **Skype Name** and **Password**, select **Sign in** and press **OK**. The Skype menu opens on screen.

Forgotten your Skype name or password?

Start Skype on your computer to get a temporary password from Skype.

Create a new account

If you do not have a Skype Name and Password yet, you can create a new account on the sign-in page on TV.

1 - On the sign-in page, select **New account** and press **OK**.

2 - Create your new account.

- Full name

Enter your full name.

- Skype name

Enter a name as your Skype name. Your Skype Name will be shown in the list of contacts of other Skype users. A Skype Name must begin with a letter, upper or lowercase. It must have 6 to 32 characters and can contain numbers. A Skype Name cannot contain a space.

- Password

Enter your password. Your password must have 6 to 20 characters and must at least contain one letter or one number. It cannot contain special characters like a trademark, bullet or euro sign. A Skype password cannot contain a space.

- Email

Enter your email address.

3 - Read and accept the Skype **Terms of Use**.

4 - If your new account was accepted, you are signed in.

You can edit or complete your **Skype profile** on your computer. Start Skype on your computer, sign in with your Skype Name and Password and open your Skype profile. You can change your profile picture, add a mood message or set the privacy settings.

No emergency calls



No emergency calls - Skype is not a replacement for your telephone and cannot be used for emergency calling.

7.3

Contacts

Contacts page

On the  **Contacts** page you can find your list of Skype contacts. The contacts are shown with their Skype Name. On this page, you can add, block or delete contacts. You can view contact details or view the history of calls you had with this contact.

Contact info

To view the details of a contact, select a contact and press  **INFO**.

Contact history

To view the calls you had with a contact, press  **Contact history**.

When you sign in with another Skype account on this TV, the history of all contacts of your account is cleared.

Online status

To know if a contact is online, check the online status icon next to the Skype Name of your contact. Like all users, your online status is also shown in their contacts page. But also like other users, you can change your online status.

1 - On the Contacts page, press  **OPTIONS** and select

Online status.

2 - In the list, select a status and press **OK**.

Each time you switch the TV on, your status is switched back to **Online**.



- **Online**

This is your usual setting when you sign into Skype. Your contacts can see that you are online and can contact you.



- **Away**

Your contacts can see that you are signed in but not necessarily watching TV. Your contacts can still try to call you.



- **Do not disturb**

Your contacts can see that you are online but you do not wish to be disturbed. They can call you and you will be alerted with sound.



- **Invisible**

You will appear to be offline to all of your contacts, but you can still use Skype as usual. You can use Skype without being disturbed by incoming calls.



- **Offline**

Automatically shown when you are not signed in to Skype. You can also set your status to offline yourself.

Phone or mobile numbers

You can also add a phone number of a landline phone or mobile phone to your list of contacts. Such a contact will be marked with this icon.



Add a contact

If you know the Skype Name or email of a friend, you can easily add them to your list of contacts. If you do not know their Skype Name or email, you can also try to look for them by name.

1 - In the menu bar select the  **Contacts** page. You can press  **LIST** or  to jump to the menu bar.

2 - Press  **Add contact**.

3 - In the text field, enter a Skype name, email address or name. Use the key pad on the remote control to enter the text.

4 - Select **Search** and press **OK**.

5 - Skype will find users that match your search. To know if you selected the person you are looking for, press  **INFO** for the contact details.

6 - If this is the person you are looking for, select **Add** and press **OK**.





The newly added contact has to accept your request to add his or her name to your list of contacts. Until the contact accepts your request, the new contact appears offline.

Accepting a Contact request

Other Skype users can invite you to be on their contact list. You will be notified of their request, which you can accept or decline.

Block a contact

You can block any Skype user from finding you online. A blocked contact will be unable to contact you with Skype. A blocked contact will not be notified, you will always appear to be offline in the contact list of the blocked contact.

On the  **Contacts** page, select a contact and press  **Block contact**.

You can always unblock a contact. To unblock, select the contact in the list and press  **Unblock contact**.



In the list of contacts a blocked contact has this icon.

To view a list of blocked contacts, press  **OPTIONS** and select **Blocked contacts**.

To unblock someone in the list, select the name and press **OK**.

7.4



Calling on Skype

Video and voice call

Make a Video call

With Video call you can call and see your friends on your TV screen, for free.





Make a Video call

On the  **Contacts** page, select the person you want to call and then select the  **Video call** button and press **OK**.

If your contact has a camera connected and accepts the call, you can see the person on your TV, full screen. When your TV camera is switched on, the blue indicator LED lights up. You can check what your contact can see, in the small screen on your TV.

To mute your microphone while you are making the call, press  **Mute**.

To switch off your camera, press  **Camera off**.

To zoom and frame the camera, press  **Zoom**. Now, you can press  **Zoom out** or press  **Zoom in**. You can use the arrows to frame the camera. When the zoom and framing is fine for you, press  **Set zoom**.

To end a call, select the **End call** button and press **OK**.

Make a Voice call

You can make a Skype call without video, with the camera switched off.

To make a call without video, select the contact, then select the  **Voice call** button and press **OK**.

To mute your microphone while you are calling, press  **Mute**.

To end the voice call, select the **End call** button and press **OK**.



On a voice call, you can still switch to a Video call. To switch to Video call, press  **Camera on**.

A contact can add you to a voice call with more than one participant. You cannot add an extra participant yourself.

Calling phones and mobiles

With Skype you can also call landline phones and mobile phones. To call phones you need to buy Skype Credit on Skype on your computer. You can buy Skype Credit or subscribe to a Skype subscription.

Call a phone

1 - Select  **Call phones** in the menu bar. You can press  **LIST** to jump to the menu bar.

2 - Enter the telephone number with the remote control keys or select the numbers on the dial pad on screen.

To enter a + (plus), press  **+**.

To enter a * (asterisk), press  *****.

To enter a # (hash), press  **#**.

To delete one digit, press  **Backspace**.

3 - When you entered the complete number, select the **Call** button and press **OK** to start calling.

To mute your microphone while you are calling, press  **Mute**.

To end a phone call, select the **End call** button and press **OK**.

List of recently called phones

If you have called some phones with Skype earlier, you can select a phone number in the list at the left of the page.

To clear the selected phone number, press  **Clear number**.

To add this phone number to your list of contacts, press  **Add to contacts**.

To clear all phone numbers, press  **Clear all**.



No emergency calls - Skype is not a replacement for your telephone and cannot be used for emergency calling.

Receiving a call

When you are signed in to Skype and watching TV, you are notified of an incoming call with a message on screen. The notification says who is calling and you can accept or decline the call.

To accept the call, select the **Answer** button in the notification and press **OK**.

To decline, select the **Decline** button and press **OK**.

Also, new contact requests will be shown immediately.

Skype during rental movies and Pause TV

While you are watching a rental movie from a broadcaster or video store, or using Pause TV, accepting a Skype call will interrupt the movie or paused programme.

To resume watching the rental movie, you need to go back to the video store or broadcast service. Some video stores and services do not allow you to restart the movie. The Pause TV programme storage is lost.

Skype during recording

While recording a programme on a connected USB Hard Drive, the TV will notify you if there was an incoming call and from who it was. The TV prevents accepting a Skype call during recording. You can easily answer the call from the  **Recent** page, after the recording is done.

Contact notifications

Next to normal calls, you can be notified when your contacts come online or go offline. You can switch off these contact notifications on the  **Settings** page.

Recent calls

On the  **Recent** page, you can view your recent Skype events.

The most recent Skype event is shown first. It shows which contact, the type of event - video call or Phone call and when it occurred.

As on the Contacts page, you can make a Video call, Voice call or Phone call to a selected contact.

History

For how long your Skype events are kept in this history list depends on the amount of contacts you have and how intensively you use Skype.



Also, if you sign in with another Skype account on this TV, the recent history will be cleared.

Voicemail



If someone calls you on Skype and you cannot take the call, he or she can leave a spoken message on your Skype voicemail.

To leave a message on a contacts voicemail, you need to set up Skype voicemail on your computer.

If you did not setup voicemail for yourself but the contact who called has setup voicemail, he or she can leave a voicemail for you.

On the  **Voicemail** page, you can play voicemail messages that were left for you. If a number is shown next to the voicemail icon in the menu bar, you have a new voicemail message -  1.

Play a voicemail

To play a voicemail, select the voicemail icon  in the menu bar, select the new voicemail in the list and press **OK**. You can listen to the new voicemail as many times you want. However, when you leave the  **Voicemail** page, all played voicemails are removed from the list.

As on the Contacts page, you can make a Video call, Voice call or Phone call to a selected contact.

7.5

Skype Credit

On Skype, you can buy **Skype Credit** or take a **Skype subscription**. With Skype Credit or a Skype subscription available, you can call landline phones and mobile phones with your TV.

Buy Skype Credit

To buy Skype Credit or take a Skype subscription, sign in to Skype on your computer.

The Skype Credit you buy will be available when you sign in to Skype on your TV.

The amount of credit or the subscription information is shown on each page where you can make a phone call.

Skype Credit low

You will be notified if your credit is too low to make a phone call.

7.6

Skype settings

Automatic sign-in

You can set Skype to automatically sign in when you switch on the TV. You do not need to enter your Skype Name or password.

Navigate to the menu bar and select  **Settings** to open the Settings page.

Select **Automatic sign-in** and press **OK** to check or uncheck.

Contact notifications

You can receive or block the online status notifications of your contacts while you watch TV.

Navigate to the menu bar and select  **Settings** to open the Settings page.

Select **Contact notifications** and press **OK** to check or uncheck.

Online status

You can change your own online status.

Navigate to the menu bar and select **⚙ Settings** to open the Settings page.
Select **Online status** and then select the online status you want your contacts to see when you are online and press **OK**.

Ringtone volume

You can adjust the Skype ringtone volume.

Navigate to the menu bar and select **⚙ Settings** to open the Settings page.
Select **Ringtone volume** and then adjust the volume with the arrows up and down.

Test camera

You can test if your Skype camera and microphone work. Also you can zoom and frame the picture of your camera to exactly what you want your contacts to see.

Navigate to the menu bar and select **⚙ Settings** to open the Settings page.
Select **Test camera**. The picture of the camera should appear and when you talk, the microphone volume should indicate your voice.

Zoom and frame the picture

- 1 - Press **⏏ Zoom**.
- 2 - Press **⏏ Zoom out** or **⏏ Zoom in**.
- 3 - With the picture zoomed in, you can shift the camera frame up, down, left or right to exactly frame the picture. Use the arrows on the remote control to shift.
- 4 - Press **⏏ Set zoom** when done.

The volume of the microphone is adjusted automatically.

Change password

You can change your current Skype password and enter a new password.

- 1 - Navigate to the menu bar and select **⚙ Settings** to open the Settings page.
- 2 - Select **Change password**.
- 3 - Select the **Current password** text field to enter your password.
- 4 - Select the **New password** text field and enter a new password.
- 5 - Select the **Repeat new password** text field and enter the new password again.
- 6 - Press **OK** to send the new password for confirmation.

7.7

Sign out

Navigate to the menu bar and select **⚙ Settings** to open the Settings page.
Select **Sign out** to quit Skype on your TV.

7.8

Terms of Use

Read the Terms of Use of Skype at www.skype.com/go/tou

Also read the Privacy Statement at www.skype.com/privacy

Games

8.1

Play a game

With a game console connected to the TV, you can play games on TV.

Start a game

Switch on the game console and press **⬆**, select the icon you have set for your game console (e.g. Game or Player) and press **OK** to view the game.

Ideal game setting

For some games, where speed and precision is needed, set the TV to the ideal **Game** setting before you start playing. If your game console is added as a **Game** type of device in the Source menu (list of connections), the TV is set to the ideal **Game** setting automatically. If the type of your game console is set as **Player** and used as a disc player most of the time, leave the device type set to **Player**.

To set the TV to the ideal setting manually . . .

- 1 - Press **⬆**, select **⚙ Setup** and press **OK**.
- 2 - Select **TV settings > Picture > Game or computer** and press **OK**.
- 3 - Select **Game** and press **OK**.
- 4 - Press **➡**, repeatedly if necessary, to close the menu. Remember to set the Game or computer setting back to **Off** when you stop playing the game.

In **Help**, press **■ List** and look up **Game console, connect** to connect a game console to the TV.

8.2

Two-player games

What is a two-player game

If you play a multi-player game with split screens, you can set the TV to show each screen as a full screen. Each player sees only his part of the game, full screen. The TV uses 3D technology to show both screens. To view the two different full screen pictures, you need a pair of 3D glasses for each player.



What you need

To play a two-player game with this TV, you need a two-player kit with 2 passive 3D glasses - Philips PTA436 (sold separately).

Also, the game console must be connected with HDMI.

Play a two-player game

To start a two-player game . . .

- 1 - Press **Source**, select the game console and press **OK**.
- 2 - On the game console, start the game and select the multi or two-player mode. Select the mode for split screen viewing.
- 3 - On the TV, press **OPTIONS**, select **Picture and sound**, select **Two-player game** and press **OK***.
- 4 - Select the format in which the split screen game is shown on screen, **Side by side** or **Top / bottom** and press **OK**. The TV shows the 2 screens as full screens.

To watch the 2 different screens, each player puts on one of the glasses - player 1 or player 2.

In and out of split screen view

In two-player split screen view, you can switch back and forth from split screen to combined view, to be able to read the game menu or game scores.

To switch views back and forth, press **OK** on the remote control of the TV.

Stop Two-player game

To stop the two-player split screen view, press **⬆** and select another activity.

* If Two-player gaming is unavailable in the menu, press **3D** on the remote control and select **2D** and press **OK**.

TV Specifications

Environmental

Saving energy

Energy saving bundles the TV settings that help the environment.

While you are watching TV channels, press  to open **Eco settings**. Active settings are marked with a . Press  again to close.

Energy saving

This Smart picture setting sets the picture, together with Ambilight, in the most ideal energy conscious setting. To switch on, select **Energy saving** in Eco settings and press **OK**. To switch off Energy saving, select another Smart picture setting.

Screen off

If you only listen to music, you can switch off the TV screen to save energy. Select **Screen off** and press **OK**. To switch the screen back on, press any key on the remote control.

Light sensor

To save energy, the built-in ambient light sensor lowers the brightness of the TV screen when the surrounding light darkens. The built-in light sensor automatically adjusts the picture, together with Ambilight, to the lighting conditions of the room. To switch on, select **Light sensor** and press **OK**. To switch off, press **OK** again.

Switch off timer

If you do not press a key on the remote control during a 4 hour period, or if the TV receives no signal for 10 minutes, the TV switches off automatically to save energy. Select **Switch off timer**.

If you use the TV as a monitor or use a digital receiver to watch TV (a Set-top box - STB) and you do not use the remote control of the TV, deactivate the automatic switch off.

In addition to these eco settings, your TV also has environmentally friendly adjustments with regard to power consumption.

Low standby power

The class-leading and highly advanced power circuitry brings down the power consumption of the TV to an extremely low level, without losing out on the constant Standby functionality.

Power management

The advanced power management of this TV ensures the most efficient use of energy. You can check how your personal TV settings, the level of brightness in current onscreen pictures, and the surrounding light conditions determine the relative power consumption.

To check the relative power consumption, press  > **Setup** > **Watch demos** > **Active control** and press **OK**. Select a setting to check the corresponding values.

European energy label

The **European Energy Label** informs you on the energy efficiency class of this product. The greener the energy efficiency class of this product is, the lower the energy it consumes.

On the label, you can find the energy efficiency class, the average power consumption of this product in use and the average energy consumption for 1 year. You can also find the power consumption values for this product on the Philips website for your country at www.philips.com/TV

End of use

Disposal of your old product and batteries

Your product is designed and manufactured with high quality materials and components, which can be recycled and reused.



When this crossed-out wheeled bin symbol is attached to a product it means that the product is covered by the European Directive 2002/96/EC.



Please inform yourself about the local separate collection system for electrical and electronic products.

Please act according to your local rules and do not dispose of your old products with your normal household waste. Correct disposal of your old product helps to prevent potential negative consequences for the environment and human health.

Your product contains batteries covered by the European Directive 2006/66/EC, which cannot be disposed with normal household waste.



Please find out for yourself about the local rules on separate collection of batteries because correct disposal will help to prevent negative consequences for the environment and human health.

Power

Product specifications are subject to change without notice. For more specification details of this product, see www.philips.com/support

Power

- Mains power : AC 220-240V +/-10%
- Ambient temperature : 5°C to 35°C
- Standby power consumption : < 0.1W
- Power saving features : Light sensor, Eco mode, Picture mute (for radio), Auto switch-off timer, Eco settings menu.

The power rating stated on the product typeplate is the power consumption for this product during normal household use (IEC 62087 Ed.2). The maximum power rating, stated between brackets, is used for electrical safety (IEC 60065 Ed. 7.2).

Reception

- Aerial input : 75 ohm coaxial (IEC75)
- Tuner bands : Hyperband, S-Channel, UHF, VHF
- DVB : DVB-T (terrestrial, antenna) COFDM 2K/8K, DVB-T2 : only for TV types '... T/12', DVB-C (cable) QAM
- Analogue video playback : NTSC, SECAM, PAL
- Digital video playback : MPEG2 SD/HD (ISO/IEC 13818-2), MPEG4 SD/HD (ISO/IEC 14496-10)
- Digital audio playback (ISO/IEC 13818-3)
- See selected countries on the TV type plate
- Satellite aerial input : 75 ohm F-type
- Input frequency range : 950 to 2150MHz
- Input level range : 25 to 65 dBm
- DVB-S/S2 QPSK, symbol rate 2 to 45M symbols, SCPC and MCPC
- Supported satellites : Astra 19.2°E, Astra 23.5°E, Astra 28.2°E, Hotbird 13.0°E, Türksat 42.0°E, Eutelsat 7°W, Thor 1°W
- Astra HD+ support
- LNB : DiSEqC 1.0, 1 to 4 LNBS supported, Polarity selection 14/18V, Band selection 22kHz, Tone burst mode, LNB current 300mA max
- See selected countries on the TV type plate

Display

Type

- Diagonal screen size : 60PFL8708 : 152 cm / 60 inch
- Display resolution : 1920x1080p
- 3D : Easy 3D, Two-player Full Screen gaming, Premium 3D Depth, Premium 2D to 3D conversion

Input resolutions

Video formats

Resolution — Refresh rate

- 480i - 60 Hz
- 480p - 60 Hz
- 576i - 50 Hz
- 576p - 50 Hz
- 720p - 50 Hz, 60 Hz
- 1080i - 50 Hz, 60 Hz
- 1080p - 24 Hz, 25 Hz, 30 Hz
- 1080p - 50 Hz, 60 Hz

Computer formats

Resolutions (amongst others)

- 640 × 480p - 60 Hz
- 800 × 600p - 60 Hz
- 1024 × 768p - 60 Hz
- 1280 × 768p - 60 Hz
- 1360 × 765p - 60 Hz
- 1360 × 768p - 60 Hz
- 1280 × 1024p - 60 Hz
- 1920 × 1080p - 60 Hz

Sound

HD Stereo 3D wOOx

- Output power (RMS) : 30W @30%THD
- Sound enhancement : Auto Volume Leveller, Dynamic Bass Enhancement, Clear Sound, Incredible surround, Incredible Surround 3D

Multimedia

Connections

- USB 2.0
- Ethernet LAN RJ-45
- Wi-Fi 802.11b/g/n (built-in)

Supported USB file systems

- FAT 16, FAT 32, NTFS

Playback formats

- Containers : 3GP, AVCHD, AVI, DivX®, MPEG-PS, MPEG-TS, MPEG-4, Matroska (MKV), Quicktime (MOV, M4V, M4A), Windows Media (ASF/WMV/WMA)
- Video Codecs : DivX®, MPEG-1, MPEG-2, MPEG-4 Part 2, MPEG-4 Part 10 AVC (H264), VC-1, WMV9
- Audio Codecs : AAC, HE-AAC (v1/v2), AMR-NB, Dolby Digital, Dolby Digital Plus, DTS 2.0 + Digital Out™, MPEG-1/2/2.5 Layer I/II/III (includes MP3), WMA (v2 to v9.2), WMA Pro (v9/v10)
- Subtitles :
 - Formats : SAMI, SubRip (SRT), SubViewer (SUB), MicroDVD (TXT), mplayer2 (TXT), TMPlayer (TXT), DivX® subtitles

- Character encodings : UTF-8, Central Europe and Eastern Europe (Windows-1250), Cyrillic (Windows-1251), Greek (Windows-1253), Turkish (Windows-1254), Western Europe (Windows-1252)
- Image Codecs : JPEG
- Limitations :
 - Maximum supported total bit rate for a media file is 30Mbps.
 - Maximum supported video bit rate for a media file is 20Mbps.
 - MPEG-4 AVC (H.264) is supported up to High Profile @ L4.1.
 - VC-1 is supported up to Advanced Profile @ L3.

Wi-Fi Certified Miracast™

This TV supports WiDi 4.x devices.

DivX®

In **Help**, press  **List** and look up **DivX® VOD** for more information.

Supported media server software (DMS)

- PC - Microsoft Windows XP, Vista or Windows 7
 - You can use any DLNA certified® media server software.
 - Microsoft - Windows Media Player
- Mac OS X
 - You can use any DLNA certified® media server software.
- Mobile devices
 - Philips MyRemote - iOS, Android
 - Interoperability and performance may vary, depending on the capabilities of the mobile device and the software used.

ESD regulations

This apparatus meets performance criteria A for ESD. In case the apparatus does not recover in file sharing mode due to electrostatic discharge, user interference is required.

9.7

Connectivity

- SCART (adapter included): Audio L/R, CVBS in, RGB
- YPbPr : Y Pb Pr (adapter included), Audio L/R (stereo mini-jack 3.5mm)
- Audio In (DVI to HDMI) (stereo mini-jack 3.5mm)
- 4x HDMI in with ARC (3D)
- Audio Out L/R — display synchronised (optical, Toslink)
- Network LAN — (RJ45)
- 3x USB 2.0
- Common interface slot (CI+/CAM)
- Headphones (stereo mini-jack 3.5mm)

9.8

Dimensions and weights

60PFL8708

Width 1342 mm - Height 776 mm - Depth 60 mm - Weight ±25 kg

. . . with TV stand - Height 860 mm - Depth 236 mm - Weight ±28 kg

UMv 3104 327 0088.3 - 130814

TV Software

Software version

To view the current TV software version, press **⬆**, select **⚙️ Setup** and press **OK**.

Select **Software settings** and press **OK**.

Select **Current software info** and see **Version:**

Software update

Software update from Internet

If the TV is connected to the Internet, you may receive a message from TP Vision to update the TV software. You need a high-speed (broadband) Internet connection.

If you receive this message, we recommend you carry out the update. Select **Update**. Follow the instructions on screen.

You can also look for new updates yourself.

To look for an update, press **⬆**, select **⚙️ Setup** and press **OK**.

Select **Update software** and press **OK**. Follow the instructions on screen.

When the update is complete, the TV switches off and back on again automatically. Wait for the TV to switch itself back on. Do not use the Power switch **⏻** on the TV.

Software update from USB

It might be necessary to update the TV software. You need a computer with an high-speed Internet connection and a USB memory device to upload the software on the TV. Use a USB memory device with 256MB free space. Make sure that write protection is switched off.

1 - Start the update on TV

To start the software update, press **⬆**, select **⚙️ Setup** and press **OK**.

Select **Update software > USB** and press **OK**.

2 - Identify the TV

Insert the USB memory into one of the USB connections of the TV, select **Start** and press **OK**. An identification file is written on the USB memory device.

3 - Download the TV software

Insert the USB memory into your computer. On the USB memory device, locate the file **update.htm** and double click it. Click on **Send ID**. If new software is available, download the .zip file. After the download, unzip the file and copy the file **autorun.upg** onto the USB memory device. Do not place this file in a folder.

4 - Update the TV software

Insert the USB memory into the TV again. The update starts automatically. The TV switches itself off for 10 seconds and then back on again. Please wait.

Do not . . .

- use the remote control
- remove the USB memory device from the TV

If a power cut occurs during the update, never remove the USB memory device from the TV. When the power returns, the update will continue.

At the end of the update, the message **Operation successful** appears on screen. Remove the USB memory device and press **⏻** on the remote control.

Do not . . .

- press **⏻** twice
- use the **⏻** switch on the TV

The TV switches itself off (for 10 seconds) and then back on again. Please wait.

The TV software has been updated. You can use the TV again.

To prevent an accidental update of the TV software, delete the **autorun.upg** file from the USB memory device.

Open source software

This television contains open source software. TP Vision Netherlands B.V. hereby offers to deliver, upon request, a copy of the complete corresponding source code for the copyrighted open source software packages used in this product for which such offer is requested by the respective licences.

This offer is valid up to three years after product purchase to anyone in receipt of this information. To obtain the source code, please write in English to . . .

Intellectual Property Dept.

TP Vision Netherlands B.V.

P.O. Box 80077

5600 KA Eindhoven

The Netherlands

Open source license

Support

11.1

Register

Register your TV and enjoy a range of benefits including full support (including downloads), privileged access to information about new products, exclusive offers and discounts, the chance to win prizes and even participate in special surveys about new releases.

Go to www.philips.com/welcome

11.2

Using help and search

This TV offers help on screen.

You can find the information you are looking for in the list of topics or read the Help as a book with chapters.

Open Help



Press  to open the Home menu.

Select  **Help** and press **OK**.

To view an alphabetical list of topics, select the  **List** tab in the menu bar.

To read the Help as a book, select  **Book** in the menu bar.

Before you execute the Help instructions, close Help.

To close Help, press  or .

On most settings and options in menus, you can press  (blue key) to read some information on the selected setting or option.

If information on the setting or option is available, you can press  (blue key) again to open the relevant page in Help.

For some activities, like Text, the colour keys have specific functions and cannot open Help.

TV Help on your tablet, smartphone or computer

You can download the TV Help in PDF format to read on your smartphone, tablet or computer.

To carry out extended sequences of instructions more easily, you can print out the relevant Help page from your computer.

To download the Help (user manual) go to www.philips.com/support

11.3

Online help

To solve any Philips TV related problem, you can consult our online support. You can select your language and enter your product model number.

Go to www.philips.com/support.

On the support site you can find your country's telephone number to contact us as well as answers to frequently asked questions (FAQs). In some countries, you can chat with one of our collaborators and ask your question directly or send a question by email.

You can download new TV software or the manual to read on your computer.

11.4

Consumer Care

For support, you can call the Consumer Care hotline in your country. Find the telephone number in the printed documentation that came with the TV.

Or consult our website www.philips.com/support.

TV model number and serial number

You might be asked to provide the TV product model number and serial number. Find these numbers on the packaging label or on the type label on the back or bottom of the TV.

Copyrights and licences

HDMI



HDMI®

The terms HDMI and HDMI High-Definition Multimedia Interface, and the HDMI Logo are trademarks or registered trademarks of HDMI Licensing LLC in the United States and other countries.

Dolby



Dolby®

Manufactured under license from Dolby Laboratories. Dolby and the double-D symbol are trademarks of Dolby Laboratories.

DTS 2.0 + Digital Out™



DTS 2.0 + Digital Out™

Manufactured under license under U.S. Patent Nos: 5,956,674; 5,974,380; 6,487,535 and other U.S. and worldwide patents issued and pending. DTS, the Symbol, and DTS and the Symbol together are registered trademarks and DTS 2.0+Digital Out is a trademark of DTS, Inc. Product includes software. © DTS, Inc. All Rights Reserved.

Skype



Skype™ is a trademark of Skype™ Limited or its related companies.

DLNA Certified®



© 2013 Digital Living Network Alliance. All rights reserved.
© 2013 DLNA. All rights reserved.

DivX Certified®



ABOUT DIVX VIDEO: DivX® is a digital video format created by DivX, LLC, a subsidiary of Rovi Corporation. This is an official DivX Certified® device that plays DivX video. Visit divx.com for more information and software tools to convert your files into DivX videos.

ABOUT DIVX VIDEO-ON-DEMAND: This DivX Certified® device must be registered in order to play purchased DivX Video-on-Demand (VOD) movies.

To obtain your registration code, locate the DivX VOD section in your device setup menu. Go to vod.divx.com for more information on how to complete your registration.

Microsoft

Windows Media

Windows Media is either a registered trademark or trademark of Microsoft Corporation in the United States and/or other countries.

Microsoft PlayReady

Content owners use Microsoft PlayReady™ content access technology to protect their intellectual property, including copyrighted content.

This device uses PlayReady technology to access PlayReady-protected content and/or WMDRM-protected content. If the device fails to properly enforce restrictions on content usage, content owners may require Microsoft to revoke the device's ability to consume PlayReady-protected content. Revocation should not affect unprotected content or content protected by other content access technologies. Content owners may require you to upgrade PlayReady to access their content. If you decline an upgrade, you will not be able to access content that requires the upgrade.

12.8

Wi-Fi Alliance



Wi-Fi®, the Wi-Fi CERTIFIED logo, the Wi-Fi logo are registered trademarks of the Wi-Fi Alliance. **Wi-Fi CERTIFIED**, **Miracast™**, **Miracast™** are trademarks of the Wi-Fi Alliance.

12.9

MHEG software

The copyright in MHEG software ("the Software") comprised in this television ("this product") and included to enable you to use interactive television features is owned by S&T CLIENT SYSTEMS LIMITED ("the Owner"). You are permitted to use the Software only in conjunction with this product.

12.10

Other trademarks

All other registered and unregistered trademarks are the property of their respective owners.

Index

3

- 3D glasses, type 52
- 3D glasses, use 52
- 3D, 2D to 3D 52
- 3D, cleaning glasses 52
- 3D, health warning 53
- 3D, optimal viewing 52

A

- Active control 19
- Ambilight, brightness 42
- Ambilight, dynamic speed 42
- Ambilight, ISF 43
- Ambilight, mode 42
- Ambilight, on or off 42
- Ambilight, static colour 43
- Ambilight, TV placement 6
- Ambilight, TV switch off 43
- Ambilight, wall colour 43
- Amplifier 41
- Antenna connection 6
- Antenna connection, tips 9
- App, feedback 55
- App, gallery 55
- App, lock 55
- App, recommended 55
- App, search 55
- Audio commentary 44
- Audio effect 44
- Audio language 35
- Audio Out - Optical 10
- Audio to video sync 13
- Auto incredible surround 3D 41
- Auto subtitle shift 11
- Auto volume leveling 41
- Automatic channel update 28

B

- Backlight contrast 37
- Bass 40
- Black bars 31
- Brightness 39

C

- CAM - Conditional Acces Module 11
- CAM, install 11
- Channel list copy 29
- Channel list copy, copy 29
- Channel list copy, upload 29
- Channel list, New 28
- Channel lists 26
- Channel lock 28
- Channel package, update 47
- Channel packages 47
- Channel update message 28
- Channel, favourite 27
- Channel, logos 27
- Channel, rename 27
- Channel, reorder 27
- Channel, switch 25
- Channels, reinstall 28

- Channels, update 28
- Child lock code 28
- CI+ 11
- Clear LCD 38
- Clock 36
- Colour 37
- Colour enhancement 38
- Colour temperature 38
- Common Interface slot 11
- Connections, list 34
- Connectivity guide 9
- Custom colour temperature 38

D

- Device icon 34
- Digital Text 32
- DivX® VOD 58
- DMR - Digital Media Renderer 9
- DVB 29
- DVB, settings 30
- DVI, connect 9
- Dynamic backlight 38

E

- EasyLink 10
- EasyLink, connections 9
- EasyLink, settings 11
- Eco settings 73
- End of use 73
- ESD 75
- European Energy Label 73

F

- Factory settings 29
- Frequency scan 30
- Frequency step size 30

G

- Game console, connect A/V LR 14
- Game console, connect HDMI 14
- Game or computer 39
- Game or computer, computer 17
- Game or computer, game 72
- Game, play 72
- Game, start two-player 72
- Game, two-player 72
- Gamma 38

H

- HbbTV 32
- HDCP, copy protection 9
- HDMI ARC 10
- HDMI connection, tips 9
- Headphones volume 41
- Headphones, connect 17
- Hearing impaired 44, 49
- Help, on a tablet 77
- Help, usage 77
- Home menu 54
- Home Theatre System, multichannel 13
- Home Theatre System, volume leveling 13

I

- Infrared sensor 24
- Interactive TV 32
- Internet App 55
- Internet memory, clear 9

ISF® Calibration 40

K

Key beep 44
Keyboard, connect 15

L

Language, menus 36
Light sensor 73
Lounge light 43

M

Manual installation 31
Media server software 8
Media servers, supported 75
MHEG 32
Miracast, block/unblock 59
Miracast, share a screen 58
Miracast, stop sharing 59
Miracast™ 58
Mixed volume 44
Mono/Stereo 41
Mouse, connect 16
Mouse, speed 16
MPEG artefact reduction 37
Multi room, how 60
Multi room, setup 60
Multi room, what 59
Music files, playback 57
MyRemote App, Control 65
MyRemote App, download 63
MyRemote App, JointSpace 62
MyRemote App, menu 64
MyRemote App, network 63
MyRemote App, recording 64
MyRemote App, SimplyShare 64
MyRemote App, TV guide 64
MyRemote App, Wi-Fi smart screen 65

N

Network frequency 30
Network frequency mode 30
Network router 7
Network, DHCP 8
Network, password 7
Network, settings 8
Network, Static IP 8
Network, wired 8
Network, wireless 7
Noise reduction 37

O

On and off 21
Online support 77
Online TV 56
Open source software 76
Options, on a channel 26
Original language 36

P

Parental rating 28
Perfect contrast 38
Perfect Natural Motion 37
Photo camera, connect 16
Photos, slideshow 57
Picture shift 39
Picture style 36

Pixel Plus link 11
Playback formats 74
Pointer, about 24
Pointer, speed 24
Pointer, switch off 24
Pointer, use 24
Power consumption 73
Power inlet 6
Predefined symbol rates 30
Programme list 33

Q

Quick picture settings 18
Quick start 21

R

Radio channel 26
Reception quality 30
Recording, list of recordings 61
Recording, record now 61
Recording, schedule a recording 61
Recording, what you need 61
Recordings, list 62
Recordings, TV guide data 34
Reinstall TV 28
Reminder, programme 33
Remote control, accents and symbols 23
Remote control, Azerty 23
Remote control, batteries 25
Remote control, Cyrillic 23
Remote control, keyboard 23
Remote control, Keys 22
Remote control, pairing 24
Remote control, pointer 24
Remote control, Uppercase 23
Rental movies 56

S

Safety instructions 19
Satellite, add 48
Satellite, age rating 46
Satellite, channel list 45
Satellite, channel update 49
Satellite, channels 45
Satellite, connection 7
Satellite, favourite channels 45
Satellite, installation 47
Satellite, lock channels 46
Satellite, Multi-Dwelling-Unit 47
Satellite, remove 48
Satellite, rename channels 48
Satellite, reorder channels 46
Satellite, Unicable 48
Saving energy 73
SCART connection, tips 10
Screen care 20
Screen edges 39
Screen off, switch 57
Sharpness 37
Shop location 39
Skype 67
Skype, automatic sign-in 70
Skype, block contact 69
Skype, calling phones 69
Skype, camera test 71
Skype, change password 71
Skype, contacts 68

- Skype, Credit 70
- Skype, event 70
- Skype, history 70
- Skype, mute 69
- Skype, new account 67
- Skype, notifications 70
- Skype, online status 68
- Skype, receive calls 69
- Skype, ringtone 71
- Skype, sign in 67
- Skype, sign out 71
- Skype, video call 69
- Skype, voice call 69
- Skype, voicemail 70
- Sleep timer 36
- Smart TV, PIN code 54
- Smart TV, register 54
- Smart TV, start page 54
- Software, current version 76
- Software, Internet update 76
- Software, USB update 76
- Sound style 40
- Source menu 34
- Speakers/Headphones 44
- Speech 44
- Standby 21
- Standby delay 21
- Status 26
- Streaming video 56
- Subtitles 35
- Subtitles, pause TV 61
- Subtitles, recording 61
- Super resolution 38
- Surround sound 41
- Switch off timer 73
- Symbol rate 30
- Symbol rate mode 30
- Synchronise audio and video 13

T

- Television on Demand 56
- Text 31
- Text, dual screen 32
- Text, freeze 32
- Text, options 32
- Text, setup 32
- Text, T.O.P. overview 32
- Treble 40
- TV clock 36
- TV guide 33
- TV guide, information 34
- TV network name 9
- TV placement 42
- TV speakers 41

U

- Universal access 43
- USB flash drive, connect 16
- USB Hard Drive, info 14
- USB Hard Drive, installation 15
- USB keyboard 15
- USB mouse 15

V

- Video contrast 39
- Video files, playback 57
- Video selection 26

- Video store 56
- Viewing distance 6

W

- Wall mounting, VESA 6
- Watch TV 25
- Wi-Fi smart screen, channel bar 66
- Wi-Fi smart screen, tool bar 66
- Wi-Fi smart screen, watch TV 65
- WoWLAN 63
- WPS - Wi-Fi Protected Setup 7
- WPS, PIN code 8
- WWW. 55

Y

- YPbPr connection, tips 10



Contact information

Argentina

0800 444 7749
Buenos Aires 0810 444 7782

België / Belgique

070 700 035 (0,15€/min.)

Bosna i Hercegovina

033 941 251 (Lokalni poziv)

Brazil

0800 701 0245
Sao Paulo 2938 0245

България

02 4916 273 (Национален номер)

Česká republika

228880895 (Místní tarif)

Danmark

3525 8314

Deutschland

0180 501 04 69 (0,14€/Min.)

Ελλάδα

2111983028 (Εθνική κλήση)

España

902 88 10 83 (0,10€ + 0,08€/min.)

Estonia

6683061 (Kohalikud kõned)

France

01 57 32 40 50 (local)

Hrvatska

01 777 66 01 (Lokalni poziv)

Italia

0245 28 70 14 (chiamata nazionale)

Ireland

0818 210 140 (national call)

Northern Ireland

0844 338 04 88 (5p/min BT landline)

Қазақстан

8 10 800 2000 00 04 (free)

Latvia

6616 3263 (Vietējais tarifs)

Lithuania

8 5 214 0293 (Vietinaiš tarifais)

Luxembourg / Luxemburg

2487 1100 (Nationale Ruf / appel national)

Magyarország

06 1 700 8151 (Belföldi hívás)

Nederland

0900 202 08 71 (0,10€/min.)

Norge

22 97 19 14

Österreich

0820 40 11 33 (0,145€/Min.)

Polska

22 397 15 04 (Połączenie lokalne)

Portugal

707 78 02 25 (0,12€/min. - Móvel
0,30€/min.)

România

031 6300042 (Tarif local)

Россия

8-800-22 00004 (бесплатно)

Suisse / Schweiz / Svizzera

0848 000 291 (0,081 CHF/Min.)

Србија

011 321 6840 (Lokalni poziv)

Slovakia

2 332 154 93 (Vnútroštátny hovor)

Slovenija

1 888 83 12 (Lokalni klic)

Suomi

09 88 62 50 40

Sverige

08 5792 9096 (lokalsamtal)

ประเทศไทย (Thailand)

02 652 7650

Türkiye

444 8 445

United Kingdom

0844 338 04 88 (5p/min BT landline)

Україна

0-800-500-480 (безкоштовно)

www.philips.com/support

Non-contractual images / Images non contractuelles / Außervertragliche Bilder



Specifications are subject to change without notice.

Philips and the Philips' shield emblem are registered trademarks of Koninklijke Philips N.V. and are used under license from Koninklijke Philips N.V.

All registered and unregistered trademarks are property of their respective owners.

2013 © TP Vision Netherlands B.V. All rights reserved.

www.philips.com