



CN8600

1-Local / Remote Share Access
Single Port KVM over IP Switch
User Manual

EMC Information

FEDERAL COMMUNICATIONS COMMISSION INTERFERENCE STATEMENT

This equipment has been tested and found to comply with the limits for a Class A digital device, pursuant to Part 15 of the FCC Rules. These limits are designed to provide reasonable protection against harmful interference when the equipment is operated in a commercial environment. This equipment generates, uses, and can radiate radio frequency energy and, if not installed and used in accordance with the instruction manual, may cause harmful interference to radio communications. Operation of this equipment in a residential area is likely to cause harmful interference in which case the user will be required to correct the interference at his own expense.

The device complies with Part 15 of the FCC Rules. Operation is subject to the following two conditions: (1) this device may not cause harmful interference, and (2) this device must accept any interference received, including interference that may cause undesired operation.

FCC Caution

Any changes or modifications not expressly approved by the party responsible for compliance could void the user's authority to operate this equipment.

Warning

Operation of this equipment in a residential environment could cause radio interference.

Achtung

Der Gebrauch dieses Geräts in Wohnumgebung kann Funkstörungen verursachen.



KCC Statement:

유선 제품용 / A 급 기기 (업무용 방송 통신 기기)
이 기기는 업무용 (A 급) 전자파적합기기로서 판매자 또는 사용자는 이
점을 주의하시기 바라며, 가정 외의 지역에서 사용하는 것을 목적으로
합니다.

Industry Canada Statement

This Class A digital apparatus complies with Canadian ICES-003.

CAN ICES-003 (A) / NMB-003 (A)

RoHS

This product is RoHS compliant.

About this Manual

This manual is provided to help you get the most out of your CN8600. It covers all aspects of the device, including installation, configuration, and operation.

The model covered in this user manual is:

Model	Product Name
CN8600	1-Local/Remote Share Access Single Port DVI KVM over IP Switch

An overview of the information found in the manual is provided below.

Chapter 1, Introduction, introduces you to the CN8600, its purpose, features and benefits, with its front and back panel components described.

Chapter 2, Hardware Setup, describes and illustrates how to set up your CN8600.

Chapter 3, Browser Login, describes how to log into the CN8600 with a browser, and the various functions contained.

Chapter 4, Configuration, explains the administrative procedures that are employed to configure the CN8600's working environment.

Chapter 5, The Client Viewer, explains how to access the CN8600 remotely using the Windows Client Viewer, along with the various functions available.

Chapter 6, AP Operation, describes how to operate the CN8600 using Windows and Java Client application programs, rather than with the browser method.

Chapter 7, The JavaClient Viewer, describes how to access the CN8600 remotely using Java Client Viewer, along with the various functions available.

Chapter 8, Local Console, describes the CN8600's local console, its functionalities and LUC port access.

Chapter 9, The Log File, shows how to use the log file utility to view the events that take place on the CN8600.

Chapter 10, The Log Server, explains how to install and configure the Log Server.

Appendix, provides specifications and other technical information regarding the CN8600.

Conventions

This manual uses the following conventions:

- | | |
|-----------------------------------------------------------------------------------|------------------------------------------------------------------------------------------------------------------------------------------------------------------------------------------------------------|
| Monospaced | Indicates text that you should key in. |
| [] | Indicates keys you should press. For example, [Enter] means to press the Enter key. If keys need to be chorded, they appear together in the same bracket with a plus sign between them: [Ctrl+Alt]. |
| 1. | Numbered lists represent procedures with sequential steps. |
| ◆ | Bullet lists provide information, but do not involve sequential steps. |
| > | Indicates selecting consecutive options (such as on a menu or dialog box). For example, Start > Run means to open the <i>Start</i> menu, and then select <i>Run</i> . |
|  | Indicates critical information. |

Package Contents

The CN8600's standard package consists of:

- ◆ 1 CN8600 DVI KVM over IP Switch
- ◆ 1 custom KVM cable set
- ◆ 1 USB 2.0 virtual media cable
- ◆ 1 power adapter
- ◆ 1 mounting kit
- ◆ 1 user instructions*

* Features may have been added to the CN8600 since this manual was published. Please visit our website to download the most up-to-date version.

Check to make sure that all the components are present and in working condition. If you encounter a problem, contact your dealer.

Read this manual thoroughly and follow the installation and operation procedures carefully to prevent any damage to the unit and/or any of the devices connected to it.

Product Information

For information about all ATEN products and how they can help you connect without limits, visit ATEN on the Web or contact an ATEN Authorized Reseller. Visit ATEN on the Web for a list of locations and telephone numbers:

International	http://www.aten.com
North America	http://www.aten-usa.com

User Information

Online Registration

Be sure to register your product at our online support center:

International	http://eservice.aten.com
---------------	-----------------------------------------------------------------

Telephone Support

For telephone support, call this number:

International	886-2-8692-6959
China	86-400-810-0-810
Japan	81-3-5615-5811
Korea	82-2-467-6789
North America	1-888-999-ATEN ext 4988 1-949-428-1111

User Notice

All information, documentation, and specifications contained in this manual are subject to change without prior notification by the manufacturer. The manufacturer makes no representations or warranties, either expressed or implied, with respect to the contents hereof and specifically disclaims any warranties as to merchantability or fitness for any particular purpose. Any of the manufacturer's software described in this manual is sold or licensed *as is*. Should the programs prove defective following their purchase, the buyer (and not the manufacturer, its distributor, or its dealer), assumes the entire cost of all necessary servicing, repair and any incidental or consequential damages resulting from any defect in the software.

The manufacturer of this system is not responsible for any radio and/or TV interference caused by unauthorized modifications to this device. It is the responsibility of the user to correct such interference.

The manufacturer is not responsible for any damage incurred in the operation of this system if the correct operational voltage setting was not selected prior to operation. PLEASE VERIFY THAT THE VOLTAGE SETTING IS CORRECT BEFORE USE.

Contents

EMC Information	ii
About this Manual	iii
Conventions	iv
Package Contents	iv
Product Information	v
User Information	v
Online Registration	v
Telephone Support	v
User Notice	vi
Contents	vii
1. Introduction	
Overview	1
Features and Benefits	3
System Requirements	5
Remote User Computers	5
Servers	5
Cables	5
Video	6
Operating Systems	6
Browsers	7
Components	8
Front View	8
Rear View	9
2. Hardware Setup	
Stacking and Rack Mounting	11
Stacking	11
Rack / Wall Mounting	12
Installation	13
3. Browser Login	
Logging In	15
Main Screen	17
4. Configuration	
Introduction	19
Basic Setting	20
User Management	20
Role	20
Permissions	21
Sessions	22
Maintenance	23

Upgrade Main Firmware	23
Update Display Info	24
Advanced Setting	28
Device Information	28
General	28
Network	29
IP Installer	30
Service Ports	30
IPv4 Settings	31
Network Transfer Rate	32
DDNS	32
ANMS	33
Event Destination	33
SNMP Server	35
Syslog Server	35
RADIUS Settings	36
The Permission Attribute Value (for RADIUS and LDAP)	38
Permission String Characters	39
CC Management Settings	39
Security	39
Login Failures	39
Filter	40
Encryption	43
Private Certificate	45
Certificate Signing Request	46
Console Management	48
OOBC	48
Date/Time	52
Preferences	56
User Preferences	56
Settings	56
Password	57
Logs	57
Remote Console	58
Download	59
About	59
View and Logout	59

5. The Client Viewer

Starting Up	61
Navigation	62
The WinClient Control Panel	62
Control Panel Functions	64
Macros	66
Hotkeys	66
User Macros	68

System Macros	72
The Message Board	78
The Button Bar	78
Message Display Panel	79
Compose Panel	79
User List Panel	79
Virtual Media	80
Virtual Media Icons	80
Virtual Media Redirection	80
Zoom	83
The On-Screen Keyboard	84
Mouse Pointer Type	85
Mouse DynaSync Mode	85
Automatic Mouse Synchronization (DynaSync)	86
Manual Mouse Synchronization	86
Control Panel Configuration	87
Admin Utility (GUI)	89

6. AP Operation

Introduction	91
The Windows Client AP	91
Installation	91
Starting Up	91
The Windows Client Connection Screen	92
Logging In	93
The Administrator Utility	94
The Java Client AP	95
Starting Up	95
The Java Client Connection Screen	95
Logging In	96

7. The JavaClient Viewer

Introduction	97
Navigation	98
The JavaClient Control Panel	99
Control Panel Functions	100
Macros	100
Hotkeys	100
System Macros	101
Video Settings	102
Message Board	103
Virtual Media	105
Zoom	105
The On-Screen Keyboard	106
Mouse Pointer Type	106
Mouse DynaSync Mode	107

Control Panel Configuration	107
-----------------------------------	-----

8. Local Console

Console Lock Switch	109
Local Console	109
Message Tag	109
Laptop USB Console	110
Laptop USB Console Main Page	112

9. The Log File

The Log File Screen	113
---------------------------	-----

10. The Log Server

Installation	115
Starting Up	115
The Menu Bar	116
Configure	117
Events	118
Search	118
Maintenance	119
Options	119
Help	120
The Log Server Main Screen	120
Overview	120
The List Panel	121
The Tick Panel	121

Appendix

Safety Instructions	123
General	123
Rack Mounting	125
Technical Support	126
International	126
North America	126
IP Address Determination	127
Local IP Setup	127
IP Installer	129
Browser	130
AP Windows Client	131
IPv6	132
Link Local IPv6 Address	132
IPv6 Stateless Autoconfiguration	133
Port Forwarding	134
Keyboard Emulation	135
Serial Port Pin Assignment	136

Trusted Certificates	137
Overview	137
Installing the Certificate	138
Certificate Trusted	139
Self-Signed Private Certificates	141
Examples	141
Importing the Files	141
Troubleshooting	142
General Operation	142
Windows	144
Java	145
Sun Systems	146
Mac Systems	147
The Log Server	147
Additional Mouse Synchronization Procedures	148
Windows:	148
Sun / Linux	149
Virtual Media Support	150
WinClient ActiveX Viewer / WinClient AP	150
Java Applet Viewer / Java Client AP	150
Administrator Login Failure	151
Specifications	152
Limited Warranty	153

This Page Intentionally Left Blank

Chapter 1

Introduction

Overview

The CN8600 is a cost-efficient over-IP device that provides secure KVM (keyboard, video and mouse) server management over an IP network. It allows operators to monitor and access their computers at BIOS-level from remote locations using a web GUI, a browser-based client, or a Windows- or Java based application. It also allows the IP address to be easily configured from the local console.

The CN8600 supports redundant Network Internet Card (NIC) to ensure connectivity. It can be connected to a network using standard Ethernet cables, and uses a custom KVM cable to connect to and manage a local KVM switch or server. It is compatible with ATEN DVI KVM switches and LCD consoles, such as the CS1768 and CL6700.

Because the CN8600 uses TCP/IP for its communications protocol, the server or KVM switch to which it is connected can be accessed from any computer on the Internet — whether it is located down the hall, down the street, or halfway around the world.

Operators at remote locations can access the CN8600 via its IP address. Once a connection has been established and authorization granted, the remote computer can exchange keyboard, video and mouse signals with the server (or servers on a KVM switch installation), as if an administrator were physically present and working on the equipment directly.

A mini USB port in the rear panel serves as a virtual media USB port, as well as a laptop USB console (LUC) port. No additional monitor, keyboard or mouse is required on the local site during routine maintenance — simply use a laptop that utilizes the LUC feature to access a computer on-site for easy management.

The CN8600's virtual media function allows users to perform diagnostic testing, file transfer, and OS/application patches from a remote console. There is no need to physically load a CD directly to the server to perform data-related tasks — empowering convenient and efficient troubleshooting and abnormal response at the BIOS level from anywhere.

The CN8600 functions as a virtual remote desktop. A client software, for viewing remote consoles, allows access to and control of the connected servers. Once an operator successfully connects and logs in, his screen displays what is running on the remote unit attached to the CN8600 for real-time control and management.

The Log Server records all events that take place on the set CN8600 units for the administrator to analyze.

The CN8600's firmware can be upgraded over the Internet. You can stay up-to-date with the latest functionality improvements by downloading firmware upgrade files from our website as they become available, and then use the utility to quickly and conveniently perform the upgrade.

ATEN capitalizes on providing affordable and durable over-IP server management solutions and ensures that each piece of equipment is worth the investment with their dependability and operational efficiency.

Features and Benefits

The features and benefits provided by CN8600 are described in the following table:

Features	Benefits
Advanced Security	<ul style="list-style-type: none"> ◆ Advanced security features including password protection – whereby a valid username and password must be given before the client software can run – and advanced encryption technologies, such as secure TLS 1.2 and RSA 2048-bit certificates. ◆ Flexible encryption design allowing users to choose any combination of 56-bit DES, 168-bit 3DES, 256-bit AES, 128-bit RC4, or Random for independent keyboard/mouse/video and virtual media data encryption. ◆ Support for IP/MAC filter ◆ Supports strong password protection ◆ Private CA
External Authentication Support	In addition to its own security protection, the CN8600 allows you to set up login authentication and authorization management from external sources such as RADIUS, LDAP, LDAPS, and MS Active Directory.
Multi-Users / Multi-Logins	The CN8600 supports up to 64 user accounts, and allows up to 32 concurrent user logins per bus access.
Port Share Mode	The CN8600 allows multiple users to gain access to a server simultaneously.
Serial Interface	<ul style="list-style-type: none"> ◆ Serial console management – serial terminal access. Access the server connected to CN8600 via a built-in serial viewer, or via third party software (such as PuTTY) for Telnet and SSH sessions. ◆ Out of Band Support – via dial up modem support. Able to access the CN8600 through its RS-232 port using a dial-up connection.
Message Board	A message board – similar to an Internet chat program – allows users to communicate with each other, and provides mechanisms for a user to take exclusive control of the KVM functions.
Event Logging	Record the events that take place on the CN8600 and write them to the log server. Administrators and users can search for events containing specific words or strings and retrieve them according to date and order of significance.
Upgradeable Firmware over the Internet	No need to add yet another cable to your installation – stay up-to-date with the latest functionality improvements and updates via network.

Features	Benefits
Redundant LAN using one IP/MAC address	Supports Network Interface Card (NIC) with backup function. Once the primary network connection fails, the CN8600 switches to another network connection automatically. This ensures connectivity and uptime.
Mouse DynaSync	No need to re-sync your mouse – Mouse DynaSync provides automatic locked-in syncing of the remote and local mouse pointers – eliminating the need to constantly re-sync the two movements. Your local console mouse movement becomes the remote unit's mouse movement.
Superior Video	With its enhanced FPS throughput for crisp responsive video display, the CN8600 offers resolutions of up to 1920 x 1200 @ 60 Hz; vibrant 30-bit color depth and gray level control for rich remote session display.
Full-Screen or Sizable Remote Desktop Window	Get a full screen even if your monitor's resolution is lower than the remote computer's resolution. In full-screen mode, the remote desktop display scales to the user's monitor display size. Supports up to 1920 x 1200 @ 60 Hz; 24-bit color depth and gray level control for remote sessions.
DDNS	Allows the mapping of a dynamic IP address assigned by a DHCP server to a host name.
End Session	Administrators can terminate running sessions, especially when during maintenance, to prevent unexpected device operations.
Multi-Keyboard Language Support / On-Screen Keyboard	The CN8600 supports multiple keyboard language input – such as English, French, German, Italian, Spanish, Japanese, Korean, and Traditional Chinese. There is no need to have a separate keyboard for each language – you can input key data in any of these languages with the CN8600's convenient on-screen keyboard.
Virtual Media	USB 1.1 and 2.0 devices (Floppy drives, CD-ROMs, Flash drives, etc.), folders, and image files on a user's local system, appear and act as if they were installed on the remote server, for ease and convenience when performing software installation and system updates across the entire installation.
Console Access Right Management	The CN8600 prioritizes the local console operation. When the CN8600 is powered on, the Console Lock Switch prevents remote users from operating the device. Local/Remote Share Mode – conveniently grants shared or exclusive console privilege.
External Control Port	Using an external control port, the CN8600 sends a signal to trigger an alarm (light) or accepts a signal to lock the console.
Integration with CC2000 and CCVSR	The CN8600 can be easily integrated with the CC2000 Centralized Management Software and CCVSR Video Session Recording Software.
ATEN PadClient Support	A mobile app for iPad to remotely and securely access computers connected to the CN8600.

System Requirements

Remote User Computers

Remote user computers (also referred to as client computers) are the ones that users log into the switch with from remote locations over a network. The following equipment must be installed on these computers:

- ◆ The computers used to access the switch must have at least a Pentium III 1+ GHz processor, with their screen resolution set to 1024 x 768. It is recommended that your PC has Pentium IV 2+ GHz with 1+ Gb of RAM.
- ◆ Browsers must support TLS 1.2 encryption.
- ◆ A network transfer speed of at least 128 kbps is required.
- ◆ For the *Log Server*, you must have the Microsoft Jet OLEDB, 4.0 or later, driver installed.

Servers

Servers are the computers connected to the switch via KVM cables. The following equipment must be installed on these servers:

- ◆ For USB KVM cable connections: a Type A-USB port and USB host controller
- ◆ For virtual media connection, an extra Type-A USB and USB host controller.

Cables

- ◆ A custom USB KVM cable set to link the CN8600 to a server or KVM switch is provided within the package.
- ◆ Custom KVM cable sets are available in various lengths, as shown in the table below:

Cable Type	Length	CS Part Number
USB	1.8 m	2L-7D02U / 2L-7D02UI
	3.0 m	2L-7D03U / 2L-7D03UI
	5.0 m	2L-7D05U

To purchase additional cable sets, contact your dealer.

- ◆ A USB 2.0 virtual media cable for use with the laptop USB console function (see *Local Console*, page 109) or virtual media function (see *Virtual Media*, page 80) is provided with this package.

- ◆ Cat 5e/6 or higher Ethernet cable (not provided with this package) should be used to connect the CN8600 to the LAN, WAN, or Internet.

Video

Only the following **non-interlaced** video signals are supported:

Resolution	Refresh Rates
640 x 480	60, 72, 75
720 x 400	70
800 x 600	56, 60, 72, 75, 85
1024 x 768	60, 70, 75, 85
1152 x 864	60, 70, 75, 85
1280 x 720	60
1280 x 1024	60, 70, 75, 85
1600 x 1200	60
1680 x 1050	60
1920 x 1200	60

Operating Systems

- ◆ Supported operating systems for remote user computers that logging into the CN8600 include Windows 2000 or later, and other systems capable of running Sun's Java Runtime Environment (JRE) 6, Update 3, or later (Linux, Mac, Sun, etc.).
- ◆ Supported operating systems for servers that connect to the CN8600 are shown in the table below:

OS		Version
Windows		2000 or later
Linux	RedHat	7.1 or later
	Fedora	Core 5 or later
	SuSE	9.0 or later
	Mandriva (Mandrake)	9.0 or later
UNIX	AIX	4.3 or later
	FreeBSD	3.51 or later
	Sun	Solaris 8 or later

OS		Version
Novell	Netware	5.0 or later
Mac		OS 9 or later
DOS		6.2 or later

Browsers

Supported browsers for users that log into the CN8600 include the following:

Browser		Version
Internet Explorer		6 or later
Chrome		8.0 or later
Firefox	Windows	3.5 or later
	Linux	3.0 or later
Safari	Windows	4.0 or later
	Mac	3.1 or later
Opera		10,0 or later
Netscape		9.0 or later

* See *Mac Systems*, page 147, for further information regarding Safari.

Components

Front View

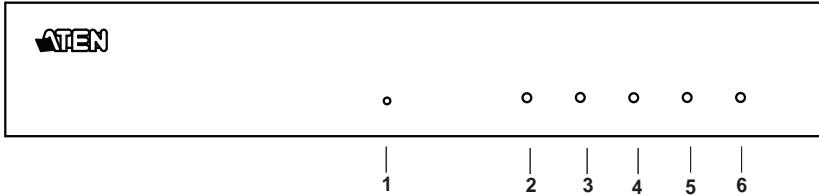

No.	Component	Description
1	reset button	Press the reset button for more than three (3) seconds to revert to factory settings.
2	LAN 2 10/100/1000 LED	Lights ORANGE to indicate that the CN8600 is transmitting at 10 Mbps on this port. Lights ORANGE + GREEN to indicate that the CN8600 is transmitting at 100 Mbps on this port. Lights GREEN to indicate that the CN8600 is transmitting at 1000 Mbps on this port.
3	remote login LED	Lights are off when there is no active remote connection. Flashes GREEN at steady intervals to indicate that a Client program has logged into the CN8600 from the remote console.
4	LAN 1 10/100/1000 LED	Lights ORANGE to indicate that the CN8600 is transmitting at 10 Mbps on this port. Lights ORANGE + GREEN to indicate that the CN8600 is transmitting at 100 Mbps on this port. Lights GREEN to indicate that the CN8600 is transmitting at 1000 Mbps on this port.
5	console lock LED	Lights steady GREEN to indicate that another access mode is operating, depending on the active configuration.
6	power LED	Lights GREEN when the CN8600 is powered up.

Rear View

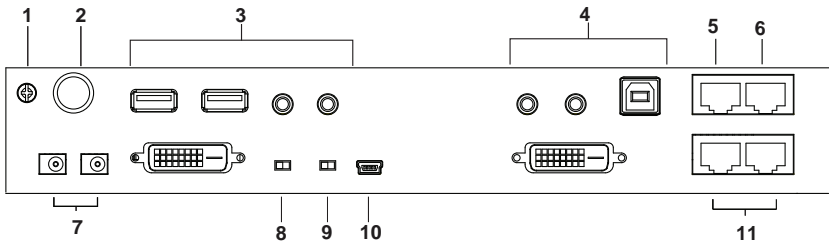

No.	Component	Description
1	grounding terminal	The wire used to ground the unit connects here.
2	control port	Reserved.
3	local console port	Connect the cable for the local console (USB keyboard, DVI monitor, USB mouse, microphone and speakers) to this port. Each connector is color coded and marked with an appropriate icon.
4	PC/KVM port	Use the KVM cable provided with this package that links the CN8600 to your PC / Server for this port. Connect the DVI video display, keyboard/mouse, microphone and speakers to the server or KVM switch that you are installing. Each connector is color coded and marked with an appropriate icon.
5	PON port	Use a Cat 5 cable to connect this port directly to the PON port of an ATEN PDU. A RJ45-to-Serial adapter (SA0142) is required if the PON port is a DB-9 type port.
6	serial port	Use a Cat 5 cable to connect this port to another network device, such as a modem. Refer to <i>Serial Port Pin Assignment</i> on page 136 for the pin definition.
7	power jacks	Plug the power adapter provided with this package into an AC power source, then plug the power adapter cable into any power jack. Plug another power adapter into an AC power source, then plug the power cable into the other CN8600 power jack. Note: Dual power operation is optional – the second power source is for back-up; a second power adapter requires a separate purchase.
8	console lock switch	Use this switch to lock the console so that remote access is disabled (view only) and only the local console can operate the CN8600. When set to unlock, the CN8600 grants access depending on the configuration stored.

9	virtual media / laptop USB console (LUC) switch	Use this switch to select whether to activate the virtual media function or the laptop USB console function. For virtual media function, see <i>Virtual Media</i> , page 80, for details.
10	virtual media / laptop USB console (LUC) port	When the switch is set to virtual media, connect the PC/server USB port to this port. See <i>Virtual Media</i> , page 80. When the switch is set to LUC, connect the laptop's USB to this port. See <i>Local Console</i> , page 109.
11	LAN ports	Connect a Cat 5e/6 network cable to these ports for uplink connection.

Chapter 2

Hardware Setup



1. Important safety information regarding the placement of this device is provided on page 123. Please review it before proceeding.
2. Make sure that the power to any device that you connect to the installation has been turned off. You must unplug the power cords of any computers that have the Keyboard Power On function.
3. Any installation that does not follow the instructions in this guide may be hazardous.
4. The power source for this product is intended to be supplied by a power adapter only, not a DC mains.

Stacking and Rack Mounting

Stacking

The CN8600 can be placed on any appropriate leveled surface that can safely support its weight plus the weight of its attached cables. To place or stack the CN8600, remove the backing material from the bottom of the rubber feet that came with this package and stick them onto the switch's bottom panel at its 4 corners, as shown in the diagram, below

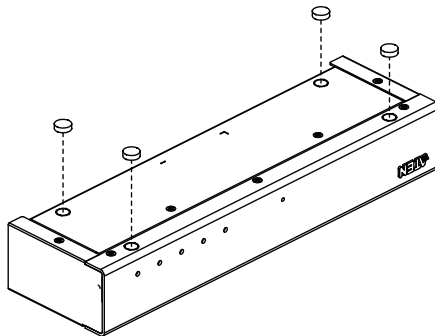

Note: To ensure adequate ventilation, allow at least 5.1 cm on each side, and 12.7cm at the back for power cord and cable clearance.

Rack / Wall Mounting

The CN8600 can be installed on most standard 19" (1U) racks or mounted onto a wall. To rack mount the unit or attach the unit to a wall, do the following:

1. Use the screws supplied with your rack mount kit to attach the mounting brackets to each side of the device:

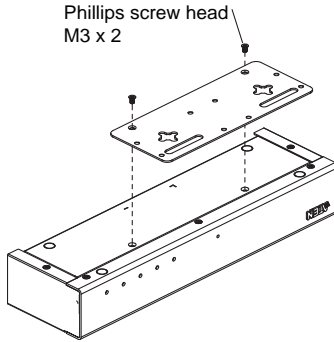

2. If rack mounting, position the device onto the rack and align the holes in the mounting brackets with that of the rack. If wall mounting, position the unit to a desired position on the wall.
3. Screw the mounting brackets to the rack or wall.

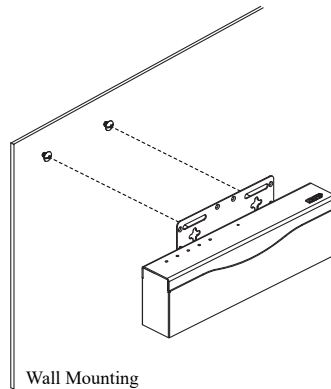
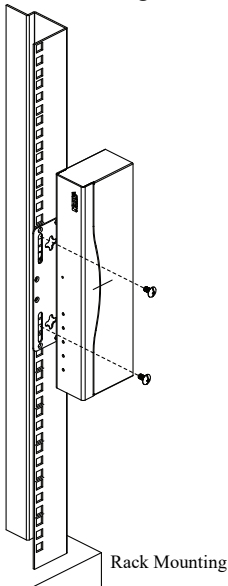

Note: Cage nuts are provided for racks that are not prethreaded.

Installation

To install the CN8600, refer to the installation diagrams on the following pages (the numbers correspond to the step numbers), and do the following:

1. Plug your USB keyboard, mouse, DVI monitor, speakers and microphone into the local console port section located on the CN8600 unit's rear panel.
2. Use the KVM cable provided with the package to connect the CN8600's PC/KVM Port to the keyboard, video, mouse, speakers and microphone ports of the server or KVM switch that you are installing.
3. (Optional) If you want to use the virtual media function, use the USB 2.0 cable provided with the package to connect a USB port on the server to the CN8600's virtual media port.
4. (Optional) If you want to use a laptop as the local console, connect the laptop's USB to this port.

Note: Check that the select switch for the virtual media / laptop USB console ports is in the right position.

5. Plug a network cable into the CN8600's LAN port 1
6. (Optional) Plug a second network cable into the CN8600's LAN port 2.

Note: Dual LAN operation is optional.

7. (Optional) If you are using a PON device (PN108), connect it to the PON port with RJ45-to-serial adapters (SA0142).

Note: Serial adapters require a separate purchase.

8. (Optional) If you are using other serial devices, such as a standard modem, connect it to the serial port with RJ45-to-serial adapters (SA0142)

Note: Serial adapters require a separate purchase.

9. Plug the power adapter provided with this package into an AC power source, then plug the power adapter cable into one of the CN8600's power jacks.
10. (Optional) Plug another power adapter into an AC power source, then plug the power cable into CN8600's other power jack.

Note: Dual power operation is optional — the second power source is for back-up; a second power adapter requires a separate purchase

11. Power on the CN8600, then power on the server/KVM switch.

Note: For safety purposes, we suggest you ground the switch using a grounding wire.

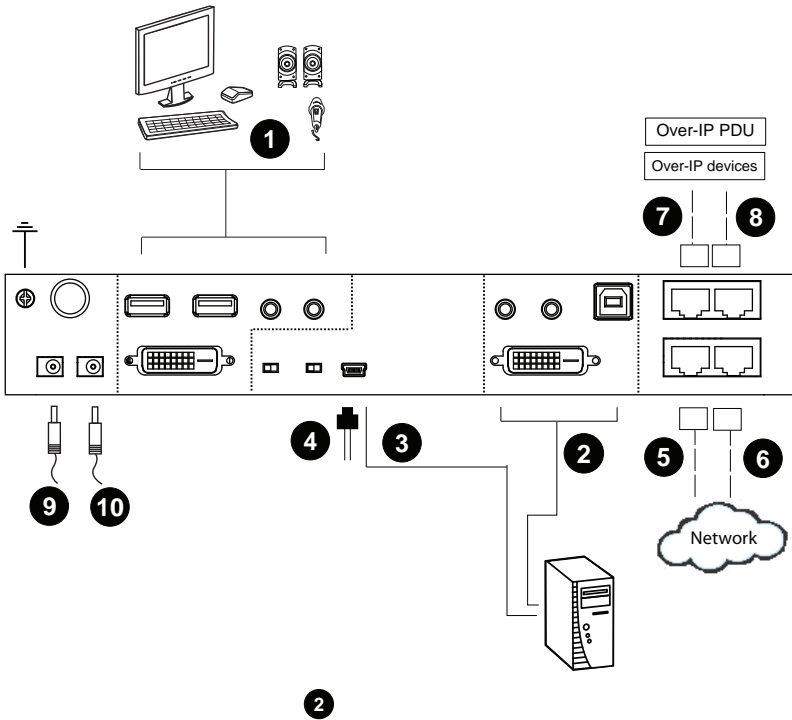

DVI KVM Cable Connection

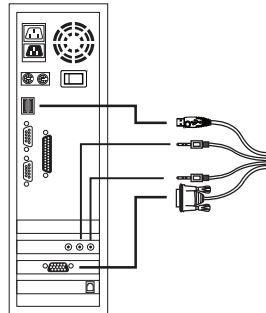

Chapter 3

Browser Login

The CN8600 can be accessed either from an Internet type browser, or via the following methods:

- ♦ Windows Client (see *The Client Viewer*, page 61);
- ♦ Java Client (see *The JavaClient Viewer*, page 97);
- ♦ Windows- or Java- application (see *AP Operation*, page 91);
- ♦ Laptop USB console (LUC) port; and
- ♦ Local console (see *Local Console*, page 109)

The next several chapters describe browser-based operations.

Logging In

To operate the CN8600 from an Internet browser, begin by logging in:

1. Open your browser and specify the IP address of the CN8600 you want to access in the browser's URL location bar.

The default IP address for non-DHCP environment is 192.168.0.60.

Note: 1. For security purposes, a login string may have been set by the administrator. If so, you must include a forward slash and the login string along with the IP address when you log in. For example:

```
192.168.0.100/CN8600
```

If you don't know the IP address and login string, ask your Administrator.

2. If you are the administrator, and are logging in for the first time, the various ways to determine the CN8600's IP address are described in the Appendix on page 127.
-

2. A **Security Alert** screen (or dialog box) appears. Accept the certificate – it can be trusted. (See *Trusted Certificates*, page 137, for details.) If a second certificate appears, accept it as well.

Note: The **Security Alert** screen's appearance varies depending on the browser version.

The CN8600 login page appears:

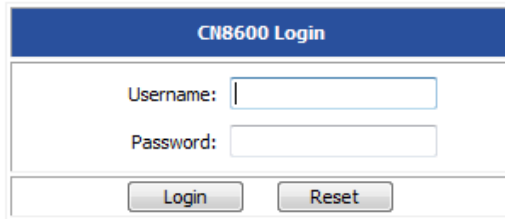

The image shows a web form titled "CN8600 Login". It features a blue header bar with the text "CN8600 Login" in white. Below the header, there are two input fields: "Username:" followed by a text box, and "Password:" followed by a text box. At the bottom of the form, there are two buttons: "Login" and "Reset".

3. Provide a valid **Username** and **Password** (set by the CN8600 administrator), then click **Login** to continue.

Note: 1. If you are the administrator and are logging in for the first time, use the default Username: *administrator*; and the default Password: *password*. For security purposes, the system will prompt you to change the login password. The password must be different from your login password.

2. If you supplied an invalid login, the authentication routine will return this message: *Invalid Username or Password. Please try again*. If you see this message, log in again being careful with the Username and Password.

The main page appears after logging in successfully.

Main Screen

After you have successfully logged in, the CN8600 Main screen appears:

KVM over IP
CN8600

Device Name:

General

MAC1 Address:	00-48-54-00-77-8b
MAC2 Address:	00-48-54-00-77-99
Firmware Version:	V1.0.063.20130312
FPGA:	Build20120809
IP Address 1:	172.17.17.21
Subnet Mask 1:	255.255.255.0
Gateway 1:	172.17.17.254
IPv6 Address 1:	FE80:0:0:0:48:54FF:FE00:778B
IPv6 Subnet Prefix Length 1:	0

Save

Viewer | Logout

The main screen consists of the user menu in the left panel, with a *Viewer* icon (to launch the Java or WinClient Viewer) as well as a *Logout* icon displayed in the bottom of the menu.

Note: If a user does not have permission to perform a particular activity, the menu option for that activity does not appear. See *Download*, page 59, for permission details.

This Page Intentionally Left Blank

Chapter 4 Configuration

Introduction

The administration utilities, represented by the links and icons located at the left panel of the CN8600 web page, are used to configure the CN8600's operating environment. This chapter discusses each of them in turn.

The screenshot shows the 'KVM over IP CN8600' web interface. The left sidebar is highlighted with a red box and contains the following menu items: Basic Setting (User Management, Sessions, Maintenance), Advanced Setting (Device Information, Network, ANMS, Security, Console Management, Date/Time, Customization), Preferences (User Preferences, Log, Remote Console, Download), and About. The main content area shows the configuration for a device named 'CN8600'. The 'General' section includes the following fields:

MAC1 Address:	00-48-54-00-77-8b
MAC2 Address:	00-48-54-00-77-99
Firmware Version:	V1.0.063.20130312
FPGA:	Build20120809
IP Address 1:	172.17.17.21
Subnet Mask 1:	255.255.255.0
Gateway 1:	172.17.17.254
IPv6 Address 1:	FE80:0:0:0:48:54FF:FE00:778B
IPv6 Subnet Prefix Length 1:	0

A 'Save' button is located at the bottom center of the configuration area.

-
- Note:**
1. As you make your configuration changes in each dialog box, click **Save** to apply the settings.
 2. Some configuration changes only take effect after a CN8600 reset. To have the changes take effect, log out and then log back in again.
 3. If you don't have configuration privileges (see *User Management*, page 20), the Administration configuration dialogs are not available.
-

Basic Setting

The following sections describe the screens under *Basic Setting*, which enable users to view or edit user information and device settings, including sessions, firmware version, configuration backup/restore and EDID. Click the **User Management**, **Sessions** and **Maintenance** links in the left panel menu to view the screens.

User Management

The User Management screen allows you to add, edit or remove user accounts to the CN8600, as well as modify the role and permissions of each account:

The screenshot shows the 'User Management' interface. On the left, a list of users includes 'administrator' and 'test123'. The main area is titled 'User Information' and contains the following fields:

- Username: [Text Input]
- Password: [Text Input]
- Confirm Password: [Text Input]
- Description: [Text Input]

Below these fields is the 'Role' section with three radio buttons: 'Administrator', 'User', and 'Select' (which is selected).

The 'Permissions' section contains a grid of checkboxes and a dropdown menu:

- Windows Client
- Config
- Telnet Client
- Enable Virtual Media
- Java Client
- System Log
- SSH Client
- View only
- Power Management
- Force to Grayscale

A 'Read Only' dropdown menu is located at the bottom of the permissions section. At the bottom of the screen are four buttons: 'Reset', 'Add', 'Update', and 'Remove'.

- ◆ **Username:** This is the user name of the account.
- ◆ **Password / Confirm Password:** Enter a new password if you are changing it. Re-enter the new password to confirm it.
- ◆ **Description:** Enter a descriptive word or phrase to describe the account.

Role

This allows the administrator to select which permissions the account will be allowed.

- ◆ **Administrator:** Gives the user Administrator level access to the CN8600. All permissions (except *View Only*) are granted (see permissions below).
- ◆ **User:** Gives the user User level access to the CN8600. Windows Client, Power Manager, and Java Client permissions are granted (see permissions below).
- ◆ **Select:** This allows you to manually select the access rights of the user by selecting them in the *Permissions* section.

Permissions

Click to place/remove a check mark next to an item to grant/withhold access to that aspect of the CN8600's operation.

- ◆ **Windows Client:** Checking this allows a user to access the CN8600 via the Windows Client software.
- ◆ **Config:** Checking this allows the user to set up and modify the CN8600's operating environment.
- ◆ **Telnet:** Checking this allows a user to access the CN8600 via the network protocol of the same name.
- ◆ **Enable Virtual Media:** Checking this allows a user to utilize the CN8600's virtual media capabilities (see *Virtual Media*, page 80 for details). Use the drop down menu to select whether the user has **Read/Write**, or **Read Only** permission.
- ◆ **Java Client:** Checking this allows a user to access the CN8600 via the Java Client software.
- ◆ **System Log:** Checking this allows a user to view the contents of the log file.
- ◆ **SSH Client:** Checking this allows a user to access the CN8600 via SSH sessions.
- ◆ **View Only:** Checking this restricts a user from configuring the CN8600.
- ◆ **Power Management:** Checking this gives a user privileges to access the Power on the Net™ device being implemented on the CN8600.
- ◆ **Force to Grayscale:** Checking this renders the remote display to be in grayscale. This can speed up I/O transfer in low bandwidth situations.

After filling out the fields, click the action you want the CN8600 to apply:

- ◆ *Reset* - Click this to clear the fields.
- ◆ *Add* - Click this to add the new account to the CN8600.
- ◆ *Update* - Click this to update the settings of an existing account.
- ◆ *Remove* - Click this to remove the selected account.

Sessions

The Sessions screen lets the administrator see at a glance all the users currently logged into the CN8600, and provides information about each of their sessions.

Username	IP	Login Time	Client	Category	Devices	Ports
administrator	10.3.41.102	2013/03/21 02:51:12	Browser	Administrator	None	

End Session

Refresh

The meanings of the headings at the top of the page are fairly straightforward.

- ♦ The *IP* heading refers to the IP address that the user has logged in from.
- ♦ The *Client* heading refers to the means the user employed to connect to the CN8600 (Browser, WinClient AP, JavaClient AP, etc.).
- ♦ The *Category* heading lists the type of user who has logged in: Admin (Administrator), User, or Select. (See *Download*, page 59 for details about user types.)

This screen also gives the administrator the option of forcing a user logout by selecting the user and clicking **End Session**.

Click **Refresh** to update the screen.

Maintenance

The Maintenance screen allows the Administrator to upgrade the CN8600's firmware, view the monitor's EDID, backup/restore the CN8600's configuration settings and ping an IP address.

Upgrade Main Firmware

As new versions of the CN8600 firmware become available, they can be downloaded from our website. Check the website regularly to find the latest information and packages.

To upgrade the firmware, do the following:

1. Download the new firmware file to your computer.
2. Open your browser; log in to the CN8600; and click *Maintenance* in the left panel menu to bring up the *Firmware File* dialog box as follows:

3. Click **Browse**; navigate to the directory that the new firmware file is in and select the file.
4. Click the **Upgrade Firmware** button.

If **Check Firmware Version** is enabled, when you perform an upgrade the current firmware level is compared with that of the upgrade file. If the current version is higher than the upgrade version, a message appears informing you of the fact and the procedure stops.

Note: If you want to install an older firmware version, you must uncheck the **Check Firmware Version** checkbox before clicking **Upgrade Firmware**.

5. After the upload completes, a message appears on the screen to inform you that the operations succeeded. Click **Logout** at the bottom left of the Main web page.
6. In the screen that comes up click **Yes** to confirm that you want to exit and reset the CN8600.

Note: You will need to wait a bit before logging back in.

Update Display Info

The Update Display Info section displays the EDID (Extended Display Identification Data) of the local monitor:

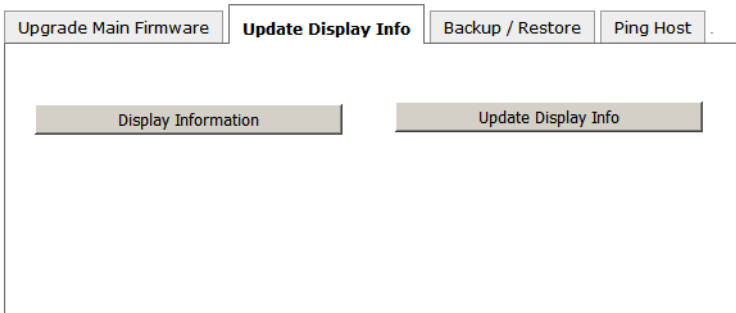

Click *Display Information* to view the EDID of the attached monitor. If you changed the monitor, click *Update Display Info* to get the EDID of the newly attached monitor.

Backup / Restore

The Backup / Restore screen gives you the ability to back up the CN8600's configuration and user profile information. Backed up User Account and Configuration information can be restored with the *Restore* section. Information currently configured on the CN8600 will be replaced with the information that you restore.

To perform a backup, do the following:

1. (Optional) In the *Password* field, key in a password for the file.

Note: If you set a password, make a note of it, since you will need it to be able to perform restore operations with the file.

2. Click **Backup**.

(Continues on next page.)

(Continued from previous page.)

3. When the browser asks what you want to do with the file, select *Save to disk*; then save it in a convenient location.

Note: The CN8600 saves all its backup files as *sysconfig.cfg*. If you want to save more than one backup file, simply rename the file to something convenient when you save it.

To restore a previous backup, do the following:

1. If a password was set when the backup was made, key the same password that you used to save the backup file in the *Password* field. If a password was not set, you can leave this field blank.
2. Click **Browse**; navigate to the file and select it.

Note: If you renamed the file, you can leave the new name. There is no need to return it to its original name.

3. Select which parts of the backup you wish to restore:
 - ◆ Select the *All* to restore both User Account and all Configuration information
 - ◆ Select the *User Account* radio button to only restore User Account information
 - ◆ Select the *User Select* radio button to choose which parts of the backed up information you wish to restore, then click the checkboxes to select/deselect the restore elements.
4. When you have made your selections, click **Restore**.
After the file is restored, a message appears to inform you that the procedure succeeded.

Ping Host

The Ping Host section enables you to ping an IP address. Enter the IP address/Hostname then click *Ping*.

The screenshot shows a web interface with a navigation bar at the top containing four buttons: 'Upgrade Main Firmware', 'Update Display Info', 'Backup / Restore', and 'Ping Host'. Below the navigation bar is a section titled 'Ping Host'. Inside this section, there is a text input field labeled 'IP address/Host Name' followed by a 'Ping' button. Below the input field is a large, empty rectangular area labeled 'Result'.

You can also enter Commands in the IP address/Host Name text bar.

Command: `tc help`

Result: Receive help information for commands.

Command: `tc get`

Result: Get current configuration.

Command: `tc enablessl2 [options]`

Result:

0 - disable SSLv2

1 - enable SSLv2

Command: `tc enablerc4 [options]`

Result:

0 - disable RC4 cipher

1 - enable RC4 cipher

Command: `tc setsslcipher [options]`

0 - uses LOW, MEDIUM and HIGH ciphers

1 - uses MEDIUM and HIGH ciphers

2 - uses HIGH ciphers only

Advanced Setting

The following sections describe the administration utilities covered under *Advanced Setting*, including the **Device Information**, **Network**, **ANMS**, **Security**, **Console Management**, **Date/Time**, **Customization** screens.

Device Information

The Device Information screen provides information about the CN8600's status. You can change the device name in this screen.

Device Name:	<input type="text" value="CN8600"/>
General	
MAC1 Address:	00-48-54-00-77-8b
MAC2 Address:	00-48-54-00-77-99
Firmware Version:	V1.0.063.20130312
FPGA:	Build20120809
IP Address 1:	172.17.17.21
Subnet Mask 1:	255.255.255.0
Gateway 1:	172.17.17.254
IPv6 Address 1:	FE80:0:0:0:48:54FF:FE00:778B
IPv6 Subnet Prefix Length 1:	0
<input type="button" value="Save"/>	

General

- ◆ **Device Name:** To make it easier to manage installations that have more than one CN8600, each one can be given a name. Enter a name (16 characters max.) for the CN8600 then click **Save**.
- ◆ **MAC (1, 2) Address:** The CN8600's MAC Address displays here.
- ◆ **Firmware Version / FPGA:** Indicates the CN8600's current firmware version level and build. New versions of the CN8600's firmware can be downloaded from our website as they become available (see *Upgrade Main Firmware*, page 23). You can reference this number to see if there are newer versions available on the website.
- ◆ **IP Address:** Displays the CN8600's Internet Protocol Version 4 (32 bit) address (in the legacy format).
- ◆ **Subnet Mask:** This is the subnet mask for the IP connection.
- ◆ **Gateway:** This is the CN8600's gateway address.
- ◆ **IPv6 Address / IPv6 Subnet Prefix Length:** Displays the CN8600's Internet Protocol Version 6 (128 bit) address (in the new format). See *IPv6*, page 132 for details.

Network

The Network screen is used to specify the CN8600's network environment.

IP Installer	
<input type="radio"/> Enabled	<input checked="" type="radio"/> View Only
<input type="radio"/> Disabled	

Service Ports	
Program:	9000
HTTP:	80
HTTPS:	443
SSH:	22
Telnet:	23

 Redundant NIC
 1000M Network Adapter 1

IPv4 Settings	
IP Address:	
<input type="radio"/> Obtain IP address automatically [DHCP]	
<input checked="" type="radio"/> Set IP address manually [Fixed IP]	
IP Address:	172.17.17.21
Subnet Mask:	255.255.255.0
Default Gateway:	172.17.17.254
DNS Server:	
<input checked="" type="radio"/> Obtain DNS server address automatically	
<input checked="" type="radio"/> Set DNS server address manually	
Preferred DNS server:	10.0.1.6
Alternate DNS server:	10.0.1.7

IPv6 Settings	
IP Address:	
<input checked="" type="radio"/> Obtain IPv6 address automatically [DHCP]	
<input type="radio"/> Set IPv6 address manually [Fixed IP]	
IPv6 Address:	
Subnet Prefix Length:	64
Default Gateway:	
DNS Server:	
<input checked="" type="radio"/> Obtain DNS server address automatically	
<input type="radio"/> Set DNS server address manually	
Preferred DNS server:	
Alternate DNS server:	

 Network Transfer Rate: 99999 KBps

DDNS	
<input type="checkbox"/> Enable	
Host Name:	
DDNS:	dyndns.org
Username:	
Password:	
DDNS Retry Time:	4 hour

IP Installer

The IP Installer is an external Windows-based utility for assigning IP addresses to the CN8600. Click one of the radio buttons to select *Enabled*, *View Only*, or *Disabled* for the IP Installer utility. See p. 129 for IP Installer details.

-
- Note:** 1. If you select *View Only*, you will be able to see the CN8600 in the IP Installer's Device List, but you will not be able to change the IP address.
2. For security, we strongly recommend that you set this to *View Only* or *Disabled* after using it.
-

Service Ports

Specify the ports that the CN8600 uses for various network services.

- ♦ **Program:** This is the port number for connecting to the CN8600 from the Windows Client and Java Applet Viewers, and from the Windows and Java Client AP programs. The default is 9000.
- ♦ **HTTP:** The port number for a browser login. The default is 80.
- ♦ **HTTPS:** The port number for a secure browser login. The default is 443.
- ♦ **SSH:** The port number for a secure shell login. The default is 22.
- ♦ **Telnet:** The port number for a secure console login. The default is 23.

-
- Note:** 1. Valid entries for all of the Service Ports are from 1–65535.
2. The service ports cannot have the same value. You must set a different value for each one.
3. If there is no firewall (on an Intranet, for example), it does not matter what these numbers are set to, since they have no effect.
-

If a firewall is being used, the Administrator can specify the port numbers that the firewall will allow (and set the firewall accordingly). If a port other than the default is set, users must specify the port number as part of the IP address when they log in. If not, an invalid port number (or no port number) is specified, the CN8600 will not be found.

Redundant NIC

A Redundant NIC ensures that the CN8600 is always online by switching to another network adapter in case the primary connection fails.

- ◆ Check *Redundant NIC* if you are using the secondary LAN port for a second IP address.
- ◆ If you are using the secondary LAN port for a second IP address, leave Redundant NIC unchecked. Use the drop-down menu and select 1000M Network Adapter 2, then set the IP and DNS addresses for it.

IPv4 Settings

The CN8600 can either have its IP address assigned dynamically at bootup (DHCP), or it can be given a fixed IP address.

- ◆ For dynamic IP address assignment, select the **Obtain an IP address automatically**, radio button. (This is the default setting.)
- ◆ To specify a fixed IP address, select the **Set IP address manually**, radio button and fill in the IP address.

-
- Note:** 1. If you choose *Obtain IP address automatically*, when the switch starts up it waits to get its IP address from the DHCP server. If it has not obtained the address after one minute, it automatically reverts to its factory default IP address, 192.168.0.60.
2. If the CN8600 is on a network that uses DHCP to assign network addresses, and you need to ascertain its IP address, you can use the IP installer. See *IP Address Determination*, page 127, for information.
-

The CN8600 can either have its DNS server address assigned automatically, or a fixed address can be specified.

- ◆ For automatic DNS Server address assignment, select the **Obtain DNS server address automatically**, radio button.
- ◆ To specify a fixed address, select the **Use the following DNS server address**, radio button and fill in the required information.

Note: Specifying at the alternate DNS Server address is optional.

IPv6 Settings

The CN8600 can either have its IPv6 address assigned dynamically at bootup (DHCP), or it can be given a fixed IPv6 address.

- ◆ For dynamic IP address assignment, select the **Obtain an IPv6 address automatically**, radio button. (This is the default setting.)
- ◆ To specify a fixed IP address, select the **Set IPv6 address manually**, radio button and fill in the IP address.

The CN8600 can either have its DNS server address assigned automatically, or a fixed address can be specified.

- ◆ For automatic DNS Server address assignment, select the **Obtain DNS server address automatically**, radio button.
- ◆ To specify a fixed address, select the **Use the following DNS server address**, radio button and fill in the required information.

Note: Specifying at the alternate DNS Server address is optional.

Network Transfer Rate

This setting allows you to tailor the size of the data transfer stream to match network traffic conditions by setting the rate at which the CN8600 transfers data to remote computers. The range is from 4–99999 Kilobytes per second (KBps).

DDNS

DDNS maps a dynamic IP address assigned by a DHCP server to a host name. The CN8600 can update the DDNS server with its IP address at certain time intervals. To enable the DDNS capability for the CN8600, do the following:

1. Check **Enable**.
2. Enter the hostname that you registered with your DDNS service provider.
3. Drop down the list to select the DDNS service you are registered with.
4. Key in the Username and Password that authenticates you with your DDNS service.
5. In the DDNS Retry Time field, key in how many hours (between 1 and 128) the CN8600 waits before updating the DDNS server.

ANMS

The Advanced Network Management Settings screen allows you to set up login authentication and authorization management from external sources. It is divided into several sections, each of which is described in the sections that follow.

Event Destination

This section lets you configure the SMTP, log server, SNMP and syslog server settings.

Event Destination Authentication

SMTP Settings

Enable report from the following SMTP Server

SMTP Server:

Service Port:

My server requires secure connection (SSL)

My server requires authentication

Account Name:

Password:

From:

To:

Report IP Address

Report system reboot

Report user login

Report user logout

Log Server

Enable

MAC Address:

Service Port:

SNMP Server

Enable SNMP Agent

Server IP:

Service Port:

Syslog Server

Enable

Server IP:

Service Port:

SMTP Settings

To have the CN8600 email reports from the SMTP server to you, do the following:

1. Check **Enable report from the following SMTP server**, and key in the IP address and service port of your SMTP server.
2. If you're connecting to a secure server, check **My server requires secure connection (SSL)**.
3. If your server requires authentication, put a check in the **My server requires authentication** checkbox, and key in the appropriate account information in the **Account Name** and **Password** fields.
4. Key in the email address of where the report is being sent from in the **From** field.

Note: Only one email address is allowed in the *From* field, and it cannot exceed 64 English alphanumeric character.

5. Key in the email address (addresses) of where you want the SMTP reports sent to in the **To** field.

Note: If you are sending the report to more than one email address, separate the addresses with a semicolon. The total cannot exceed 256 English alphanumeric character.

6. Put a check on the kind of information that you want to be included in the report email:
 - ◆ Report IP Address
 - ◆ Report system reboot
 - ◆ Report user login
 - ◆ Report user logout

Log Server

Important transactions that occur on the CN8600, such as logins and internal status messages, are kept in an automatically generated log file

- ◆ Specify the MAC address of the computer that the Log Server runs on in the *MAC address* field.
- ◆ Specify the port used by the computer that the Log Server runs on to listen for log details in the *Port* field. The valid port range is 1–65535. The default port number is 9001.

Note: The port number must be different than the one used for the *Program* port (see *Service Ports*, page 30).

See Chapter 10, *The Log Server*, for details on setting up the log server. The *Log File* is discussed on page 113.

SNMP Server

To be notified of SNMP trap events, do the following:

1. Check *Enable SNMP Agent*.
2. Key in the IP address and the port number of the computer to be notified of SNMP trap events. The valid port range is 1-65535. Default is 162.

Note: The following SNMP trap events are sent: *System Power On*, *Login Failure*, and *System Reset*.

Syslog Server

To record all the events that take place on the CN8600 and write them to a Syslog server, do the following:

1. Check **Enable**.
2. Key in the IP address and the port number of the Syslog server. The valid port range is 1-65535. Default is 514.

Authentication

The CN8600 allows log in authentication and authorization through external programs.

This screen lets you configure the RADIUS, LDAP, and CC Management settings.

If you want to use a RADIUS, LDAP, CC Authentication instead of the CN8600 device authentication, check **Disable Device Authentication**. Selecting this option will disable login authentication locally on the CN8600.

If the third party authentication server/external program you are using fails to authenticate and you cannot log on to the CN8600, you can enable local authentication through the local console. See page 128 for details on how to use the local console to enable authentication on the CN8600.

RADIUS Settings

To allow authentication and authorization for the CN8600 through a RADIUS server, do the following:

RADIUS Settings

Enable

Preferred RADIUS Server IP:

Preferred RADIUS Service Port:

Alternate RADIUS Server IP:

Alternate RADIUS Service Port:

Timeout: sec

Retries:

Shared Secret (at least 6 characters):

1. Check **Enable**.
2. Fill in the IP addresses and service port numbers for the Preferred and Alternate RADIUS servers.
3. In the *Timeout* field, set the time in seconds that the CN8600 waits for a RADIUS server reply before it times out.
4. In the *Retries* field, set the number of allowed RADIUS retries.
5. In the **Shared Secret** field, key in the character string that you want to use for authentication between the CN8600 and the RADIUS Server.

LDAP Settings

To allow authentication and authorization via LDAP or LDAPS, the Active Directory's LDAP Schema must be extended so that an extended attribute name for the CN8600 – *iKVM26-userProfile* – is added as an optional attribute to the person class.

To manually find out the attribute name of the CN8600 – *iKVM26-userProfile*, go to *Ping Host* under *Maintenance* and execute a **tc get** command, see *Ping Host*, page 27 for details.

In order to configure the LDAP server, you will have to complete the following procedures: 1) Install the Windows Server Support Tools; 2) Install the Active Directory Schema Snap-in; and 3) Extend and Update the Active Directory Schema.

To allow authentication and authorization for the CN8600 via LDAP / LDAPS, refer to the information in the following table.

Item	Action
Enable	Put a check in the <i>Enable</i> checkbox to allow LDAP / LDAPS authentication and authorization.
LDAP / LDAPS	Click a radio button to specify whether to use LDAP or LDAPS.
LDAP Server	Fill in the IP address and port number for the LDAP or LDAPS server. For LDAP, the default port number is 389; for LDAPS, the default port number is 636.
Port	
Timeout (seconds)	Set the time in seconds that the CN8600 waits for an LDAP or LDAPS server reply before it times out.
Admin DN	Consult the LDAP / LDAPS administrator to ascertain the appropriate entry for this field. For example, the entry might look like this: cn=LDAPAdmin,ou=cn8600,dc=aten,dc=com
Admin Name	Key in the Group Name for CN8600 administrator users.
Password	Key in the LDAP administrator's password.

Item	Action
Search DN	Set the distinguished name of the search base. This is the domain name where the search starts for user names.

The Permission Attribute Value (for RADIUS and LDAP)

The attribute value for *permission* is made up of two parts: 1) the IP address of the CN8600 a user will access; and 2) a string that indicates the access rights the user has on the CN8600 at that IP address. For example:

```
192.168.0.80&c,w,j;192.168.0.188&v,l
```

The makeup of the permission entry is as follows:

- ◆ An ampersand (&) connects the CN8600's IP with the access rights string.
- ◆ The access rights string is made up of various combinations of the following characters: c w j p l v s. The characters can be entered in upper or lower case. See *Permitted String Characters* table below.
- ◆ The characters in the access rights string are separated by a comma (,). There are no spaces before or after the comma.
- ◆ If a user has access rights to more than one CN8600, each permission segment is separated by a semicolon (;). There are no spaces before or after the semicolon.
- ◆ Use the following keyword for Radius and LDAP setting: **su/[username]** – the username must be a real user account that exists in the system.
- ◆ LDAP should use **CN8600 – iKVM26-userProfile**, or can waive this. The login name must exist in the local account.

Permission String Characters

Character	Meaning
C	Grants the user administrator privileges, allowing the user to configure the system.
W	Allows the user to access the system via the Windows Client program.
J	Allows the user to access the system via the Java applet.
L	Allows the user to access log information via the user's browser.
V	Limits the user's access to only viewing the video display.
M	Allows the user to use the virtual media function – Read / Write

CC Management Settings

To allow authorization for the CN8600 through a CC (Control Center) server, check *Enable* and fill in the CC Server's IP address and the port that it listens on in the appropriate fields.

CC Management

Enable

CC Server IP: CC Service Port:

Note: *Authentication* refers to determining the authenticity of the person logging in; *authorization* refers to assigning permission to use the device's various functions.

Security

The Security screen controls access to the CN8600, and lets you configure the login failure policies, login string, security settings, and so on.

Login Failures

For increased security, the Login Failures section allows administrators to set policies governing what happens when a user fails to log in successfully.

Login Failures

Enable

Allowed:

Timeout: min

Lock Client PC Lock Account

The meanings of the entries are explained below.

- ◆ Login Fail Policy: Select the login failure policy that the CN8600 applies.

Lock Client PC – If this is enabled, after the allowed number of failures have been exceeded, the computer attempting to log in is automatically locked out. No logins from that computer will be accepted. The default is enabled. This function relates to the client computer's IP. If the IP is changed, the computer will no longer be locked out.

Lock Account – If this is enabled, after the allowed number of failures have been exceeded, the user attempting to log in is automatically locked out. No logins from the username and password that have failed will be accepted. The default is enabled.

- ◆ **Allowed** - Sets the number of consecutive failed login attempts that are permitted from a remote computer. The default is 5 times.
- ◆ **Timeout** - Sets the amount of time (in minutes) that a remote computer must wait before attempting to login again after it has exceeded the number of allowed failures. The default is 3 minutes.

Note: If you don't enable **Login Failures**, users can attempt to log in an unlimited number of times with no restrictions. For security purposes, we recommend that you enable this function and enable the lockout policies.

Filter

IP and MAC Filters control access to the CN8600 based on the IP and/or MAC addresses of the computers attempting to connect. A maximum of 100 IP filters

and 100 MAC filters are allowed. If any filters have been configured, they appear in the IP Filter and/or MAC Filter list boxes.

The screenshot shows a window titled "Filter" with two main sections. The top section is for IP filtering, with a checkbox for "Enable IP Filter", radio buttons for "Include" and "Exclude", a large empty list box, and buttons for "Add", "Modify", and "Delete". Below this is a "Login String:" label and an empty text input field. The bottom section is for MAC filtering, with a checkbox for "Enable MAC Filter", radio buttons for "Include" and "Exclude", another large empty list box, and buttons for "Add", "Modify", and "Delete".

To enable IP and/or MAC filtering, put a check mark in the *IP Filter Enable* and/or *MAC Filter Enable* checkbox.

- ◆ If the **Include** button is checked, all the addresses within the filter range are allowed access; all other addresses are denied access.
- ◆ If the **Exclude** button is checked, all the addresses within the filter range are denied access; all other addresses are allowed access.

Adding Filters

To add an IP filter, do the following:

1. Click **Add**. Key in the IP address range you want to filter, and click **OK**:

The screenshot shows a small dialog box titled "IP Filter". It has a "From :" field containing "0.0.0.0" and a "To :" field which is empty. At the bottom, there are "OK" and "Cancel" buttons.

2. Repeat these steps for any additional IP addresses you want to filter.

To add a MAC filter, do the following:

1. Click **Add**. A dialog box similar to the one below appears:

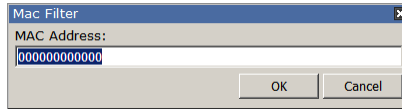

2. Specify the MAC address in the dialog box, then click **OK**.
3. Repeat these steps for any additional MAC addresses you want to filter.

Note: If there is a conflict between an IP filter and a MAC filter – for example, where a computer’s IP address is allowed by the IP filter but it’s MAC address is excluded by the MAC filter – then that computer’s access is blocked. In other words, if either filter blocks a computer, then the computer is blocked, no matter what the other filter is set to.

Modifying Filters

To modify a filter, select it in the IP Filter or MAC Filter list box and click **Modify**. The Modify dialog box is similar to the Add dialog box. When it comes up, simply delete the old address(es) and replace it with the new one(s).

Deleting Filters

To delete a filter, select it in the IP Filter or MAC Filter list box and click **Delete**.

The Filter section also lets administrators specify a *Login String* that users must include (in addition to the IP address) when they access the CN8600 with a browser. For example:

192.168.0.126/CN8600

- ♦ The following characters are allowed:
0–9 a–z A–Z ~ ! @ \$ ^ & * () _ + ‘ - = [] { } ; ’ < > , . |
- ♦ The following characters are not allowed:
 - ♦ % ” : / ? # \ [Space]
 - ♦ Compound characters (É Ç ñ ... etc.)

Note: 1. There must be a forward slash between the IP address and the string.

2. If no login string is specified here, anyone will be able to access the CN8600 login page using the IP address alone. This makes your installation less secure.

For security purposes, we recommend that you change this string occasionally.

Account Policy

Set the parameters for the username and password.

Account Policy

Minimum Username Length:

Minimum Password Length:

Password Must Contain At Least

One Upper Case

One Lower Case

One Number

Disable Duplicate Login

- ◆ Minimum Username Length: Enter the minimum number (0 - 16) of characters required for a username (default is 6).
- ◆ Minimum Password Length: Enter the minimum number (0 - 16) of characters required for a password (default is 6).
- ◆ Check whether the password must contain at least: *One Upper Case*, *One Lower Case*; and/or *One Number* character.

Note: This policy only affects user accounts created after this policy has been enabled, as well as password changes to existing user accounts.

Check *Disable Duplicate Login* to ensure that only one session for each user account is active. This prevents users from logging in with the same account at the same time.

Encryption

These flexible encryption alternatives for keyboard/mouse, video, and virtual media data let you choose any combination of DES; 3DES; AES; RC4; or a Random cycle of any or all of them.

Encryption

Keyboard/Mouse

DES 3DES AES RC4 Random

Video

DES 3DES AES RC4 Random

Virtual Media

DES 3DES AES RC4 Random

Enabling encryption will affect system performance – no encryption offers the best performance; the greater the encryption, the greater the adverse effect. If you enable encryption, the performance considerations (going from best to worst) are as follows:

- ◆ RC4 offers the least performance impact; DES is next; then 3DES or AES
- ◆ The RC4 + DES combination offers the least impact of any combination

Mode

Use this section to set the working mode parameters.

Mode

Enable ICMP

Enable Multiuser Operation

Enable Virtual Media Write

Browser Service : Disable Browser

Disable Authentication

- ◆ *Enable ICMP* so that the CN8600 can be pinged. If it is not enabled, the device cannot be pinged. The default is **Enabled**.
- ◆ *Enable Multiuser Operation* to permit more than one user to log into the CN8600 at the same time. The default is **Enabled**.
- ◆ *Enable Virtual Media Write* allows redirected virtual media devices on a user's system to send data to a remote server, as well as being able to have data from the remote server written to them. The default is **Enabled**.
- ◆ *Browser Service* allows the administrator to limit the scope of browser access to the CN8600. Put a check in the checkbox to enable this function, then select the browser limitation in the drop down list box. Choices are explained in the following table:

Item	Explanation
Disable Browser	If this is selected, the CN8600 cannot be accessed via a browser. It can only be accessed from the AP programs (see <i>AP Operation</i> , page 91).
Disable HTTP	If this is selected, the CN8600 can be accessed via a browser, but not from an ordinary (HTTP) login connection – it can only be accessed over a secure HTTPS (SSL) connection.
Disable HTTPS (SSL)	If this is selected, the CN8600 can be accessed via a browser over an ordinary (HTTP) login connection, but not via a secure HTTPS (SSL) connection.

- ◆ If *Disable Authentication* is checked, no authentication procedures are used to check users attempting to log in. Users gain Administrator access to the CN8600 switch simply by entering combination of username and password.

Note: Enabling this setting creates an extremely dangerous result as far as security goes, and should only be used under very special circumstances.

Private Certificate

When logging in over a secure (SSL) connection, a signed certificate is used to verify that the user is logging in to the intended site. For enhanced security, the Private Certificate section allows you to use your own private encryption key and signed certificate, rather than the default ATEN certificate.

Private Certificate

Private Key :

Certificate :

Certificate Signing Request

Certificate :

There are two methods for establishing your private certificate: generating a self-signed certificate; and importing a third-party certificate authority (CA) signed certificate.

Generating a Self-Signed Certificate

If you wish to create your own self-signed certificate, a free utility – openssl.exe – is available for download over the web. See *Self-Signed Private Certificates*, page 141 for details about using OpenSSL to generate your own private key and SSL certificate.

Obtaining a CA Signed SSL Server Certificate

For the greatest security, we recommend using a third party certificate authority (CA) signed certificate. To obtain a third party signed certificate, go to a CA (Certificate Authority) website to apply for an SSL certificate. After the CA sends you the certificate, save it to a convenient location on your computer.

Importing the Private Certificate

To import the private certificate, do the following:

1. Click **Browse** to the right of **Private Key**; browse to where your private encryption key file is located; and select it.
2. Click **Browse** to the right of **Certificate**; browse to where your certificate file is located; and select it.
3. Click **Upload** to complete the procedure.

Note: Both the private encryption key and the signed certificate must be imported at the same time.

Certificate Signing Request

The Certificate Signing Request (CSR) section provides an automated way of obtaining and installing a CA signed SSL server certificate.

To perform this operation do the following:

1. Click **Create CSR**. The following dialog box appears:

2. Fill in the form – with entries that are valid for your site – according to the example information in the following table:

Information	Example
Country (2 letter code)	TW
State or Province	Taiwan
Locality	Taipei
Organization	Your Company, Ltd.
Unit	Techdoc Department
Common Name	mycompany.com This must be the exact domain name of the site that you want the certificate to be valid for. If the site's domain name is <i>www.mycompany.com</i> , and you only specify <i>mycompany.com</i> , the certificate will not be valid.
Email Address	administrator@yourcompany.com

3. After filling in the form (all fields are required), click **Create**.
A self-signed certificate based on the information you just provided is now stored on the CN8600.
4. Click **Get CSR**, and save the certificate file (*csr.cer*) to a convenient location on your computer
This is the file that you give to the third party CA to apply for their signed SSL certificate.
5. After the CA sends you the certificate, save it to a convenient location on your computer. Click **Browse** to locate the file; then click **Upload** to store it on the CN8600.

Note: When you upload the file, the CN8600 checks the file to make sure the specified information still matches. If it does, the file is accepted; if not, it is rejected.

If you want to remove the certificate (to replace it with a new one because of a domain name change, for example), simply click **Remove CSR**.

Console Management

This section discusses methods of opening the CN8600 console via OOB or serial connection.

OOBC

In case the CN8600 cannot be accessed with the usual LAN-based methods, it can be accessed via the switch's modem port. To enable support for PPP (modem) operation, click to put a checkmark in the *Enable Out of Band Access* checkbox.

PPP Settings

When you enable Out of Band Access, the *Enable Dial Back*, and *Enable Dial Out* functions become available, as described in the sections that follow.

Dial Back

As an added security feature, if this function is enabled, the switch disconnects the calls that dial in to it, and dials back to one of the entries specified below:

Dial Back

Enable Dial Back

Enable Fixed Number Dial Back

Phone Number:

Enable Flexible Dial Back

Use dial back phone number for the Username

Password:

- ◆ **Enable Fixed Number Dial Back:** If *Fixed Number Dial Back* is enabled, when there is an incoming call, the CN8600 hangs up the modem and dials back to the modem whose phone number is specified in the Phone Number field.

Key the phone number of the modem that you want the CN8600 to dial back to in the *Phone Number* field.

- ◆ **Enable Flexible Dial Back:** If *Flexible Dial Back* is enabled, the modem that the CN8600 dials back to doesn't have to be fixed. It can dial back to any modem that is convenient for the user, as follows:

1. Key the password that the users must specify in the *Password* field.
2. When connecting to the CN8600's modem, users specify the phone number of the modem that they want the CN8600 to dial back to as their Username, and specify the password set in the *Password* field for their password.

Dial Out

For the dial out function, you must establish an account with an Internet Service Provider, and use a modem to dial up to your ISP account. An explanation of the Enable Dial Out items is given in the table below:

Dial Out	
<input checked="" type="checkbox"/>	Enable Dial Out
ISP Settings	
Phone Number:	<input type="text" value="986969879"/>
Account Name:	<input type="text"/>
Password:	<input type="text"/>
Dial Out Schedule	
<input checked="" type="radio"/>	Every: <input type="text" value="Never"/>
<input type="radio"/>	Daily at: <input type="text" value="0"/> : <input type="text" value="0"/>
PPP online time:	<input type="text" value="100"/> minute(s)
Emergency Dial Out	
<input checked="" type="radio"/>	PPP stays online until network recovery
<input type="radio"/>	PPP online time: <input type="text" value="0"/> minute(s)
Dial Out Mail Configuration	
SMTP Server IP Address:	<input type="text" value="198.168.0.0"/>
Service Port:	<input type="text" value="465"/>
<input checked="" type="checkbox"/>	SMTP server requires secure connection (SSL)
<input type="checkbox"/>	SMTP server requires authentication
Account Name:	<input type="text"/>
Password:	<input type="text"/>
Email From:	<input type="text"/>
To:	<input type="text"/>

- ◆ **ISP Settings:** Specify the telephone number, account name (username), and password that you use to connect to your ISP.
- ◆ **Dial Out Schedule:** This entry sets up the times you want the CN8600 to dial out over the ISP connection. *Every* provides a listing of fixed times from every hour to every four hours.
 - ◆ If you select *Every two hours* (for example), the CN8600 will start dialing out every two hours beginning at 00:00.
 - ◆ If you don't want the CN8600 to dial out on a fixed schedule, select **Never** from the list.
- ◆ *Daily at* will dial out once a day at a specified time. Use the hh:mm format to specify the time.

- ◆ *PPP online time* specifies how long you want the ISP connection to last before terminating the session and hanging up the modem. A setting of zero means it is always on line.
- ◆ **Emergency Dial Out:** If the CN8600 gets disconnected from the network, or the network goes down, this function puts the switch on line via the ISP dial up connection.
 - ◆ If you choose *PPP stays online until network recovery*, the PPP connection to the ISP will last until the network comes back up or the switch reconnects to it.
 - ◆ If you choose *PPP online time*, the connection to the ISP will terminate after the amount of time that you specify is up. A setting of zero means it is always on line.
- ◆ **Dial Out Mail Configuration:** This section provides email notification of problems that occur on the devices connected to the CN8600's ports.

Note: This email notification differs from the one configured under *SMTP Settings* in that it uses the ISP mail server rather than the internal company's mail server.

- ◆ Key in the IPv4 address, IPv6 address, or domain name of your SMTP server in the *SMTP Server IP Address* field, and enter the corresponding port in the *Service Port* field.
- ◆ If your server requires a secure SSL connection, put a check in the *SMTP server requires secure connection (SSL)* checkbox
- ◆ If your server requires authentication, put a check in the *SMTP server requires authentication* checkbox, then key in the appropriate account name and password in the fields, below.
- ◆ Key in the email address of the person responsible for the SMTP server (or some other equally responsible administrator), in the *Email From* field.
- ◆ Key in the email address (addresses) of where you want the report sent to in the *To* field. If you are sending the report to more than one email address, separate the addresses with a comma or a semicolon.

When you have finished making your settings on this page, click **Save**.

Serial Console

To configure the CN8600 to interact with the connected serial device, you need to set its parameters to match the parameters of the device in the *Port Property Settings*.

The screenshot shows a configuration window with two tabs: 'OOBC' and 'Serial Console'. The 'Serial Console' tab is active. Under 'Port Property Settings', there are five dropdown menus: Baud Rate (9600), Data Bits (8), Parity (Even), Stop Bits (2), and Flow Control (Hardware). Below this is a section titled 'Port Alert Settings' which contains ten text input fields labeled 'Alert String 1' through 'Alert String 10'. The first field, 'Alert String 1', contains the text 'admin'.

Select the values that match the ones used by the connected serial console device. The port property settings that the CN8600 supports are as follows:

- ◆ **Baud Rate:** This sets the port's data transfer speed. Choices are from 300–38400 (drop down the list to see them all). Set this to match the baud rate setting of the serial console device. Default is 9600 (which is a basic setting for many serial console devices).
- ◆ **Data Bits:** This sets the number of bits used to transmit one character of data. Choices are: 7 and 8. Set this to match the data bit setting of the serial console device. Default is 8 (which is the default for the majority of serial console devices).
- ◆ **Parity:** This bit checks the integrity of the transmitted data. Choices are: None; Odd; Even. Set this to match the parity setting of the serial console device. Default is None.
- ◆ **Stop Bits:** This indicates that a character has been transmitted. Set this to match the stop bit setting of the serial console device. Choices are: 1 and 2. Default is 1 (which is the default for the majority of serial console devices).
- ◆ **Flow Control:** This allows you to choose how the data flow will be controlled. Choices are: None, Hardware, and XON/XOFF. Set this to match the flow control setting of the serial console device. Default is None.

Note: None is only supported for baud rates of 9600 and lower. For baud rates greater than 9600, you must choose Hardware or XON/XOFF.

- ◆ **Port Alert Properties:** You can specify up to 10 types of events (e.g., Power On). Enter them in the provided *Alert String* (1 - 10) fields.

When you have finished making your selections, click **Save**.

Date/Time

The Date/Time dialog page sets the CN8600 time parameters:

Time Zone

(GMT-12:00) Eniwetok Kwajalein ▼

Daylight Savings Time

Date

March < 2013 >

March 2013

Su	Mo	Tu	We	Th	Fr	Sa
					1	2
3	4	5	6	7	8	9
10	11	12	13	14	15	16
17	18	19	20	21	22	23
24	25	26	27	28	29	30
31						

Time

20 : 32 : 03 Set

Network Time

Enable auto adjustment

Preferred time server

AU | ntp1.cs.mu.OZ.AU ▼

Preferred custom server IP

Alternate time server

AU | ntp1.cs.mu.OZ.AU ▼

Alternate custom server IP

Adjust time every 1 days Adjust Time Now

Set the parameters according to the information below.

Time Zone

- ◆ To establish the time zone that the CN8600 is located in, drop down the **Time Zone** list and choose the city that most closely corresponds to where it is at.
- ◆ If your country or region employs Daylight Saving Time (Summer Time), check the corresponding checkbox.

Date / Time

- ◆ Select the month from the drop-down list-box.
- ◆ Click < or > to move backward or forward by one year increments.
- ◆ In the calendar, click on the day.
- ◆ To set the time, key in the numbers using the 24 hour HH:MM:SS format.
- ◆ Click **Set** to save your settings.

Network Time

To have the time automatically synchronized to a network time server, do the following:

1. Check the *Enable auto adjustment* checkbox.
2. Drop down the time server list to select your preferred time server
– or –
Check the *Preferred custom server IP* checkbox, and key in the IP address of the time server of your choice.
3. If you want to configure an alternate time server, check the *Alternate time server* checkbox, and repeat step 2 for the alternate time server entries.
4. Key in your choice for the number of days between synchronization procedures.
5. If you want to synchronize immediately, click **Adjust Time Now**.

Customization

Use this section to edit the device settings.

Mode	
<input type="checkbox"/> Force All to Grayscale	
<input checked="" type="checkbox"/> Enable Client AP Device List	
USB IO Settings	
OS:	Win
Language:	US English
Multuser Mode	
Multuser Mode:	Share
Occupy Timeout:	3 sec (0-255)
Reset	
<input type="button" value="Reset Default Values"/>	
<input type="checkbox"/> Reset on exit	

- ◆ If *Force All to Grayscale* is enabled, the remote displays of all devices connected to the CN8600 are changed to grayscale. This can speed up I/O transfer in low bandwidth situations.
- ◆ If *Enable Client AP Device List* is enabled, the switch appears in the Server List when using the WinClient or Java Client AP (see *The Client Viewer*, page 61, and *The JavaClient Viewer*, page 97). If this option is not enabled, the switch can still be connected to, but its name will not appear in the Server List.
- ◆ **OS:** Specifies the operating system that the server on the connected port is using. Choices are Win, Mac, Sun, and Other. The default is Win.
- ◆ **Language:** Specifies the OS language being used by the server on the connected port. Drop down the list to see the available choices. The default is English US.

- ◆ **Multiuser Mode:** Defines how a port is to be accessed when multiple users have logged on, as follows:
 - ◆ *Exclusive:* The first user to switch to the port has exclusive control over the port. No other users can view the port.
 - ◆ *Occupy:* The first user to switch to the port has control over the port. However, additional users may view the port's video display.
 - ◆ *Share:* Users simultaneously share control over the port. Input from the users is placed in a queue and executed chronologically. Under these circumstances, users can take advantage of the Message Board, which allows a user to take control of the keyboard and mouse or keyboard, mouse, and video of a Share port (see *The Message Board*, page 78).
- ◆ **Occupy Timeout:** If there is no user input for the amount of time specified here, the control privilege is released and transferred to the next user who moves the mouse or uses the keyboard.
- ◆ **Reset:** After making any network changes, be sure *Reset on exit* has been enabled (there is a check in the checkbox), before logging out. This allows network changes to take effect without having to power the switch off and on.

Click *Reset Default Values* to use the default factory settings of the CN8600.

Preferences

The following sections describe the administration utilities covered on this section, including the **User Preferences**, **Log**, **Remote Console** and **Download** screens. You can find the links to these screens under *Preferences* in the left panel menu.

User Preferences

The *User Preferences* screen allows the user to set the device password, as well as device parameters including the Language, OSD Hotkey, Logout Timeout and the Viewer.

The screenshot shows a 'Settings' window with the following elements:

- Language:** A dropdown menu currently showing 'English'.
- OSD Hotkey:** A dropdown menu currently showing '[Scroll Lock] [Scroll Lock]'.
- Logout Timeout:** A text input field containing '30' followed by 'min'.
- Viewer:** Two radio buttons: 'Auto Detect' (selected) and 'Java Client'.
- Buttons:** A 'Save' button below the Viewer options, and a 'Change Password...' button below the password fields.
- Password Fields:** Three stacked text input fields labeled 'Old Password:', 'New Password:', and 'Confirm Password:'.

Settings

Set device parameters using the following fields:

- Language:** Selects the language that the interface displays in. Drop down the list to make your selection.

Selecting **Auto** causes the CN8600 to display the pages in the same language to which the browser is set.

If your browser is set to a non-supported language, the CN8600 looks to what your server's operating system is set to. If the operating system is set to a supported language it will use that language to display its pages. If the operating system is set to a non-supported language, the CN8600 defaults to English. After making your choice, click **Save**.

- OSD Hotkey:** Select the keyboard combination to call the OSD function.
- Logout Timeout:** Set how many minutes the CN8600 allows a user session to last before terminating the session.
- Viewer:** Choose the viewer you would like to use when viewing the remote server's display. This is set to **Auto Detect** by default, which opens the WinClient for Windows systems.

Password

Change your password using the following fields:

- ◆ **Old Password:** Key in the old password.
- ◆ **New Password:** Key in the new password.
- ◆ **Confirm Password:** Key in the exact same characters to verify you have entered the correct new password

Click **Change Password** to apply your settings.

Logs

The CN8600 logs all the events that take place on it. Following a reset, it writes them to a log file, which is a searchable database. To view the contents of the log file, click the *Log* icon at the center left of the page. A screen similar to the one below appears:

Time	Severity	User	Log Information
2012/12/04 15:16:54	Least	System	Log update 1
2012/12/04 15:06:47	Most	System	User administrator from 10.3.41.58 (00-18-6E-4D-DD-81) attempting to login via browser.
2012/12/04 15:06:21	Most	System	User administrator from 10.3.41.58 (00-18-6E-4D-DD-81) attempting to login via browser.
2012/12/04 15:02:30	Most	System	User administrator from 10.3.41.58 (00-18-6E-4D-DD-81) attempting to login via browser.
2012/12/04 15:01:07	Most	System	User administrator from 10.3.41.91 (00-18-6E-4D-DD-81) logged out via browser.
2012/12/04 15:01:06	Most	administrator	End session for user administrator.
2012/12/04 15:01:06	Most	administrator	User administrator (10.3.41.91) logged out. Online time : 00:01:25.
2012/12/04 15:01:03	Most	administrator	User administrator (10.3.41.91) logged out. Online time : 00:00:30.
2012/12/04 15:00:33	Least	administrator	User administrator changes to [01] .
2012/12/04 15:00:33	Most	administrator	User administrator logged in.
2012/12/04 15:00:33	Most	System	User administrator (10.3.41.91) attempting to login.
2012/12/04 15:00:33	Most	System	SYS: Access via windows client 10.3.41.91.
2012/12/04 15:00:33	Most	System	Sys: Connected to 10.3.41.91 (00-18-6E-4D-DD-81).
2012/12/04 15:00:19	Least	System	Get snapshot result....01B70490 9628
2012/12/04 15:00:15	Most	System	User administrator from 10.3.41.58 (00-18-6E-4D-DD-81) attempting to login via browser.
2012/12/04 15:00:08	Least	System	Send snapshot request...
2012/12/04 14:59:42	Most	administrator	Start session for user administrator.
2012/12/04 14:59:41	Least	administrator	User administrator changes to [01] .
2012/12/04 14:59:41	Most	administrator	User administrator logged in.

 Clear Log

A maximum of 512 events are kept in the log file. As new events are recorded, they are placed at the bottom of the list. When a new event is recorded after there are 512 events in the log file, the earliest event in the list is discarded.

Note: To maintain and view a record of all the events that take place (not just the most recent 512), set up the Log Server AP program. see *The Log Server*, page 115.

To clear the log file, click on the *Clear Log* icon at the lower right of the page.

Remote Console

The preview in this screen shows a snapshot of the server's display, as follows:

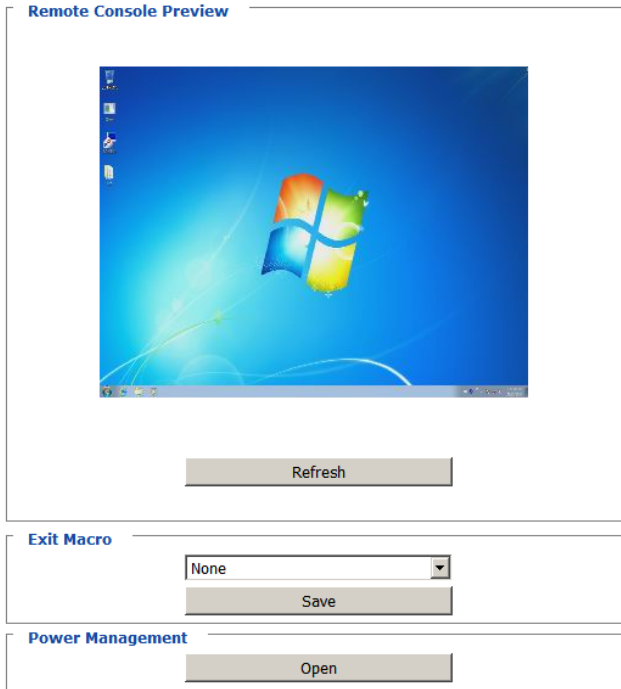

Clicking *Refresh* updates the snapshot of the remote display.

- ◆ Select the *Exit Macro* you would like to use and click **Save**.
- ◆ To configure the PN0108 (a Power Over the NET™ device), click *Open Power Management*. When connection between the devices is established, you can only use the CN8600's IP address to access the configuration screens of the PN0108. Clicking this button opens the login page of the device.

Note: 1. Connection to the PN0108 or a Power Over the NET™ (PON) device can only be viewed and managed through the browser configuration screens; these screens are not available via the Windows or Java application (AP) programs.

2. Refer to ATEN's PN0108 User Manual (or a compatible PON device's manual) for details on editing the power management configuration screens.
-

Download

The Download page lets you download the standalone *Windows Client AP*, *Java client AP* and *Log Server AP*.

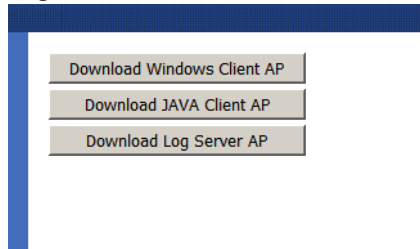

1. Click the button of the AP you want to download.
 2. Follow the on-screen instructions to complete the installation and have the program icon placed on your desktop.
- ◆ For more information on the *Windows Client AP* and *Java Client AP*, refer to Chapter 6 on page 91.
 - ◆ For details on the *Log Server AP*, refer to Chapter 10 on page 115.

About

Click *About* to see the current firmware version and copyright information of your CN8600.

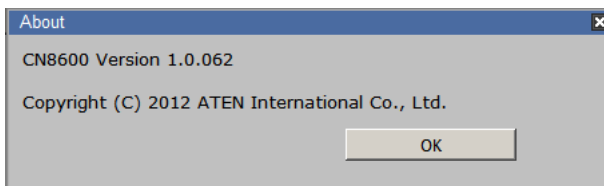

View and Logout

Click the Viewer icon to view and configure the server's display/monitor in a separate window.

Click the Logout icon when you are done configuring the CN8600's operating environment. This logs you out of the CN8600 GUI.

This Page Intentionally Left Blank

Chapter 5

The Client Viewer

Starting Up

The Client Viewer is available when you log into the CN8600 web GUI using a browser. After you log in (see *Logging In*, page 15), click the **Viewer** icon in the left panel menu. A second or two after, the remote server's display appears as a window on your desktop:

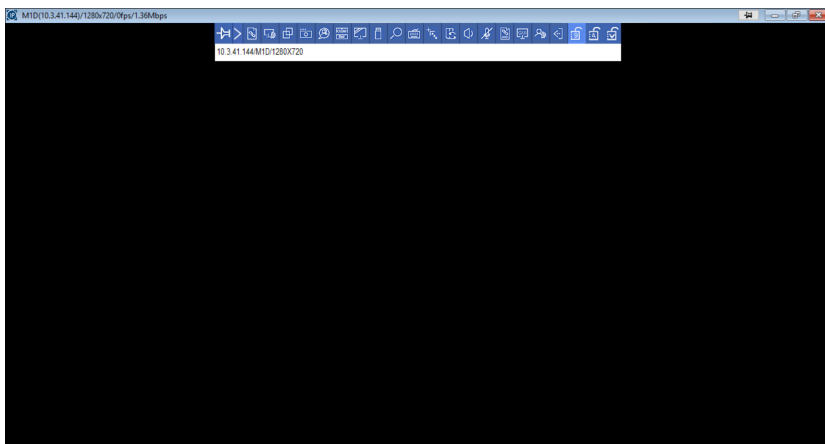

By default, the WinClient version of the viewer is displayed.

If you want to use the JavaClient version, see *User Preferences*, page 56 for details on how to configure this option. To navigate the Java version, refer to Chapter 7, page 97.

Navigation

You can work on the remote system via the screen display on your monitor just as if it were your local system.

- ♦ You can maximize the window, drag the borders to resize the window; or use the scrollbars to move around the screen.
- ♦ You can switch between your local and remote programs with [Alt + Tab].

-
- Note:**
1. Due to net lag, there might be a slight delay before your keystrokes show up. You may also have to wait a bit for the remote mouse to catch up to your local mouse before you click.
 2. Due to net lag, or insufficient computing power on the local machine, some images, especially motion images, may display poorly.
-

The WinClient Control Panel

The WinClient control panel is hidden at the upper or lower center of the screen (the default is up). It becomes visible when you move the mouse pointer over it:



The control panel has two menu styles: at startup, only the icons are displayed. Pressing this icon (▶) changes the menu into a combination of icon + text mode as show below:

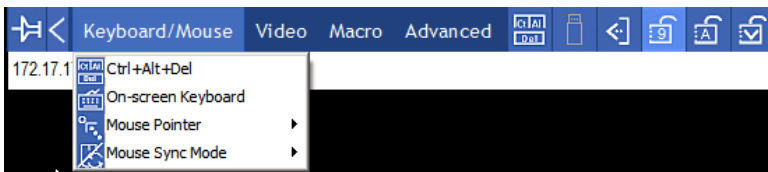

-
- Note:**
1. The above image shows the complete Control Panel. The icons that appear can be customized. See *Control Panel Configuration*, page 87, for details.
 2. To move the Control Panel to a different location on the screen, place the mouse pointer over the text bar area, then click and drag.
-



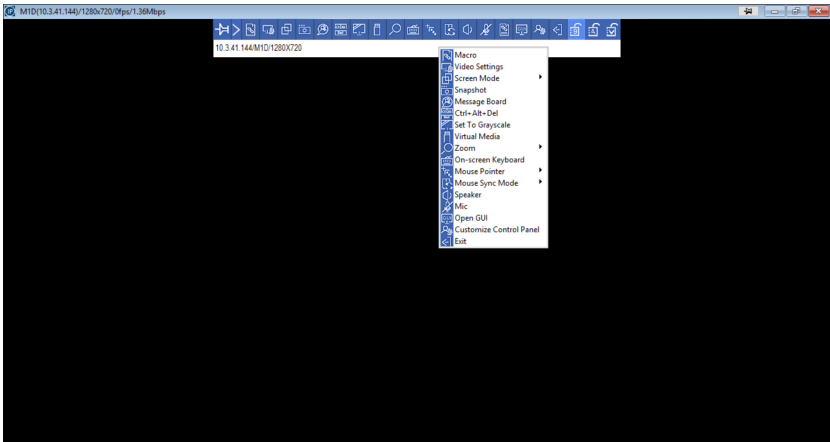







- ◆ By default, the left of the top text row shows the video resolution of the remote display. As the mouse pointer moves over the icons in the icon bar, however, the information in the top text row changes to describe the icon's function. In addition, if a message from another user is entered in the message board, and you have not opened the message board in your session, the message will appear in the top row.
- ◆ If the *User Info* function has been enabled under *Control Panel Configuration* (see *User Info*, page 88), the total number of users currently logged into the CN8600 displays in the center of the upper text row.
- ◆ Right clicking in the text row area brings up a menu that allows you to select options for the *Screen Mode*, *Zoom*, *Mouse Pointer type*, *Mouse Sync Mode* and *Macro List*. These functions are discussed in the sections that follow.

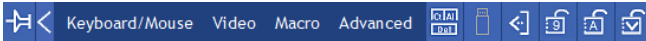













Control Panel Functions

The Control Panel functions are described in the table below.

Note: Clicking the **T** button at the top right of the dialog boxes that appear for the control panel functions brings up a slider to adjust the transparency of the dialog box. After making your adjustment, click anywhere in the dialog box to dismiss the slider.

Icon	Function
	This is a toggle. Click to make the Control Panel persistent – i.e., it always displays on top of other screen elements. Click again to have it display normally.
	<p>When you click this, the Control Panel format changes and you get 4 categories: Keyboard/Mouse, Video, Macro and Advanced. Hover your mouse over these categories to see the rest of the menu items:</p>  <p>Click the icon again to revert to the original Control Panel format.</p>
	Click to bring up the Macros dialog box (see page 66 for details).
	Click to bring up the Video Options dialog box. Right-click to perform a quick Auto Sync (see <i>Video Settings</i> , page 75, for details).
	Toggles the display between <i>Full Screen Mode</i> and <i>Windowed Mode</i> .
	Click to take a snapshot (screen capture) of the remote display. See <i>Snapshot</i> , page 88, for details on configuring the Snapshot parameters.
	Click to bring up the Message Board (see <i>The Message Board</i> , page 78).
	Click to send a <i>Ctrl+Alt+Del</i> signal to the remote system.
	Click to toggle the remote display between color and grayscale.

Icon	Function
	<p>Click to bring up the <i>virtual media</i> dialog box. The icon changes when a virtual media device is started on the port. See <i>Virtual Media</i>, page 80, for specific details.</p> <p>Note: This icon displays in gray when the function is disabled or not available to the user.</p>
	<p>Click to zoom the remote display window.</p> <p>Note: This feature is only available in windowed mode (Full Screen Mode is off). See <i>Zoom</i>, page 83 for details.</p>
	<p>Click to bring up the on-screen keyboard (see <i>The On-Screen Keyboard</i>, page 84).</p>
	<p>Click to select the mouse pointer type.</p> <p>Note: This icon changes depending on which mouse pointer type is selected (see <i>Mouse Pointer Type</i>, page 85).</p>
	<p>Click to toggle Automatic or Manual mouse sync.</p> <ul style="list-style-type: none"> ◆ When the selection is <i>Automatic</i>, a green √ appears on the icon. ◆ When the selection is <i>Manual</i>, a red X appears on the icon. <p>See <i>Mouse DynaSync Mode</i>, page 85 for a complete explanation of this feature.</p>
	<p>Click this to turn the speaker on or off.</p>
	<p>Click this to turn the microphone on or off.</p>
	<p>Click to display a drop-down Macro List of <i>User</i> macros. Access and run macros more conveniently rather than using the <i>Macros</i> dialog box (see the <i>Macros</i> icon in the table above, and the <i>Macros</i> section on page 66).</p>
	<p>Click this icon to open a Viewer based GUI with the web browser administrative functionalities. See <i>Admin Utility (GUI)</i>, page 89 for details.</p>
	<p>Click to bring up the Control Panel Configuration dialog box. See <i>Control Panel Configuration</i>, page 87, for details on configuring the Control Panel.</p>
	<p>Click to exit the remote view and go back to the web browser Main Page.</p>

Icon	Function
	<p>These icons show the Num Lock, Caps Lock, and Scroll Lock status of the remote computer.</p> <ul style="list-style-type: none"> ◆ When the lock state is <i>On</i>, the LED is bright green and the lock hasp is closed. ◆ When the lock state is <i>Off</i>, the LED is dull green and the lock hasp is open. <p>Click on the icon to toggle the status.</p> <p>Note: These icons and your local keyboard icons are in sync. Clicking an icon causes the corresponding LED on your keyboard to change accordingly. Likewise, pressing a Lock key on your keyboard causes the icon's color to change accordingly.</p>

Macros

The Macros icon provides access to three functions found in the Macros dialog box: Hotkeys, User Macros, and System Macros. Each of these functions is described in the following sections.

Hotkeys

Various actions, corresponding to clicking the Control Panel icons, can be accomplished directly from the keyboard with hotkeys. Selecting the Hotkeys radio button lets you configure which hotkeys perform the actions. The actions are listed to the left; their hotkeys are shown to the right. Use the checkbox to the left of an action's name to enable or disable its hotkey.

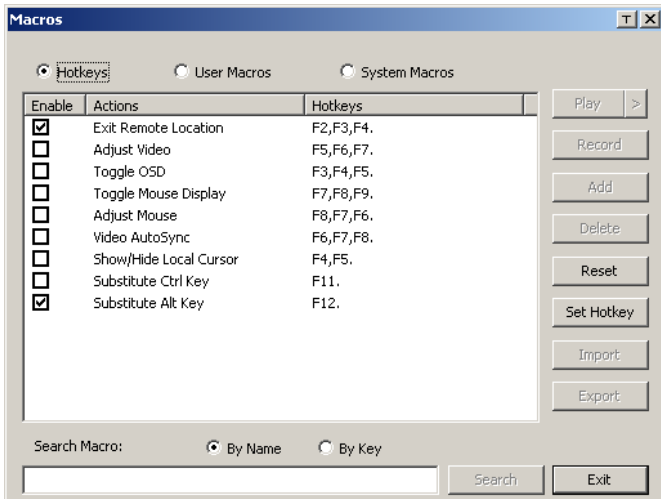

If you find the default Hotkey combinations inconvenient, you can reconfigure them as follows:

1. Highlight an *Action*, then click **Set Hotkey**.
2. Press your selected Function keys (one at a time). The key names appear in the **Hotkeys** field as you press them.
 - ♦ You can use the same function keys for more than one action, as long as the key sequence is not the same.
 - ♦ To cancel setting a hotkey value, click **Cancel**; to clear an action's Hotkeys field, click **Clear**.
3. When you have finished keying in your sequence, click **Save**.

To reset all the hotkeys to their default values, click **Reset**.

An explanation of the Hotkey actions is given in the table below:

Action	Explanation
Exit remote location	Exits the remote view and goes back to the web browser Main Page. This is equivalent to clicking the <i>Exit</i> icon on the Control Panel. The default keys are F2, F3, F4.
Adjust Video	Brings up the <i>Video Settings</i> dialog box. This is equivalent to clicking the <i>Video Settings</i> icon on the Control Panel. The default keys are F5, F6, F7.
Toggle OSD	Toggles the Control Panel Off and On . The default keys are F3, F4, F5.
Toggle mouse display	If you find the display of the two mouse pointers (local and remote) to be confusing or annoying, you can use this function to shrink the non-functioning pointer down to a barely noticeable tiny circle, which can be ignored. Since this function is a toggle, use the hotkeys again to bring the mouse display back to its original configuration. This is equivalent to selecting the <i>Dot</i> pointer type from the <i>Mouse Pointer</i> icon on the Control Panel. The default keys are F7, F8, F9. Note: The Java Control Panel does not have this feature.
Adjust mouse	This synchronizes the local and remote mouse movements. The default keys are F8, F7, F6.
Video Auto-sync	This combination performs an auto-sync operation. It is equivalent to clicking the <i>Video Autosync</i> icon on the Control Panel. The default keys are F6, F7, F8.
Show/Hide Local Cursor	Toggles the display of your local mouse pointer off and on. This is equivalent to selecting the <i>Null</i> pointer type from the <i>Mouse Pointer</i> icon on the Control Panel. The default keys are F4, F5.

Action	Explanation
Substitute Ctrl key	If your local computer captures Ctrl key combinations, preventing them from being sent to the remote system, you can implement their effects on the remote system by specifying a function key to substitute for the Ctrl key. If you substitute the F11 key, for example, pressing [F11 + 5] would appear to the remote system as [Ctrl + 5]. The default key is F11.
Substitute Alt key	Although all other keyboard input is captured and sent to the remote system, [Alt + Tab] and [Ctrl + Alt + Del] work on your local computer. In order to implement their effects on the remote system, another key may be substituted for the Alt key. If you substitute the F12 key, for example, you would use [F12 + Tab] and [Ctrl + F12 + Del]. The default key is F11.

User Macros

User Macros are used to perform specific actions on the remote server. To create the macro, do the following:

1. Select the *User Macros* radio button, then click **Add**.

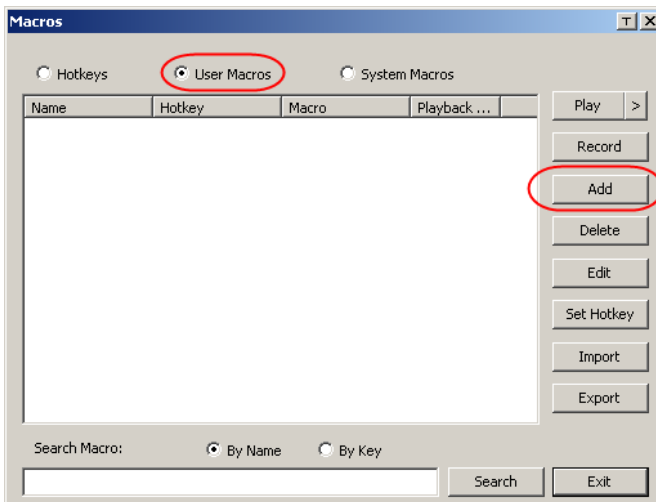

- In the dialog box that comes up, replace the “New Macro” text with a name of your choice for the macro:

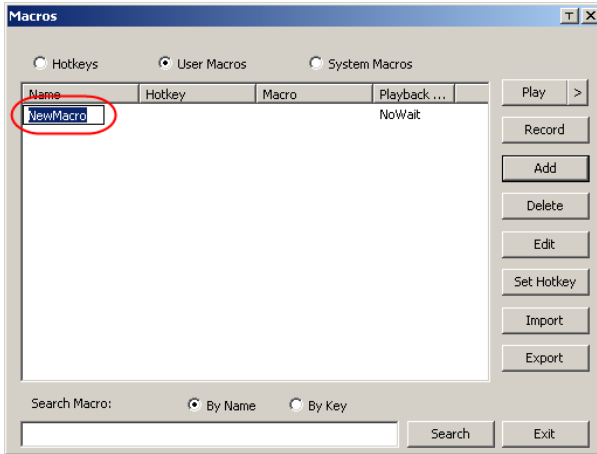

- Click **Record**.

The dialog box disappears, and a small panel appears at the top left of the screen:

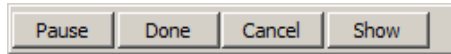

- Press the keys for the macro.
 - To pause macro recording, click **Pause**. To resume, click **Pause** again.
 - Clicking **Show** brings up a dialog box that lists each keystroke that you make, together with the amount of time each one takes:

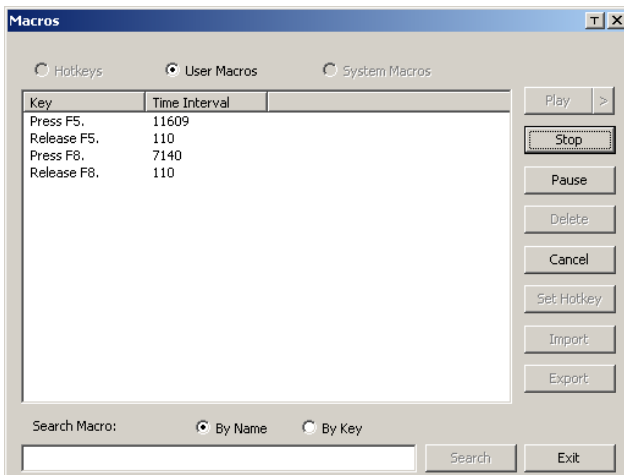

- ◆ Clicking **Cancel** cancels all keystrokes.
- ◆ When you have finished, click **Stop**. This is the equivalent of clicking *Done* in Step 5.

Note: 1. Case is not considered – typing **A** or **a** has the same effect.

2. When recording the macro the focus must be on the remote screen. It cannot be in the macro dialog box.
3. Only the default keyboard characters may be used. Alternate characters cannot be used. For example, if the keyboard is Traditional Chinese and default character is **A** the alternate Chinese character obtained via keyboard switching is not recorded.

4. If you haven't brought up the Show dialog, click **Done** when you have finished recording your macro. You return to the **Macros** dialog box shown in Step 1:

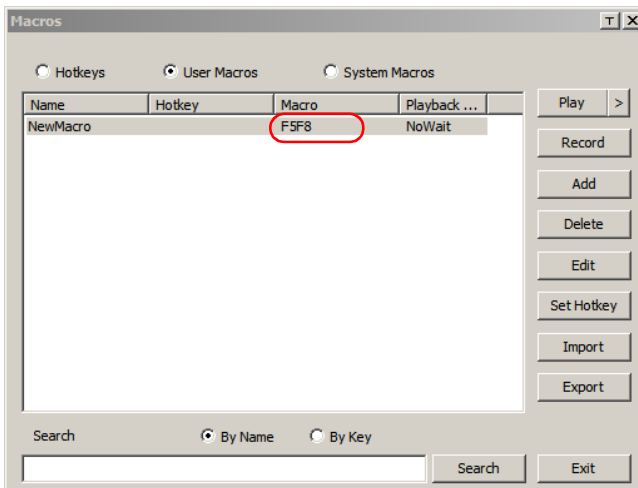

5. You can give each macro a set of hotkeys, as illustrated in *Hotkeys*, page 66.
6. You can also assign the playback mode and select either **Play Without Wait** (*Nowait*) or **Play with Time Control**.

If you run the macro from this dialog box, you have the option of specifying how the macro runs.

- ◆ If you choose *Play Without Wait*, the macro runs the key presses one after another with no time delay between them.
 - ◆ If you choose *Play With Time Control*, the macro waits for the amount of time between key presses that you took when you created it. Click on the arrow next to *Play* to make your choice.
 - ◆ If you click *Play* without opening the list, the macro runs with the default choice. The default choice (*NoWait* or *TimeCtrl*), is shown in the *Playback* column.
7. If you want to change any of the keystrokes, select the macro and click **Edit**. This brings up a dialog box similar to the one for Show. You can change the content of your keystrokes, change their order, etc.
 8. Repeat the procedure for any other macros you wish to create.

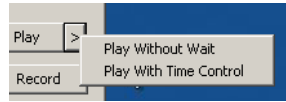

After creating your macros, you can run them in any of three ways:

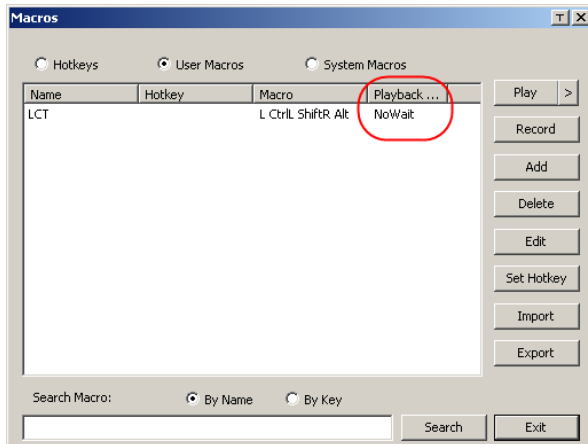

1. By using the hotkey (if one was assigned).
2. By opening the Macro List on the Control Panel and clicking the one you want (see , page 65).

3. By opening this dialog box and clicking **Play**.

Note: User Macros are stored on the Local Client computer of each user. Therefore there is no limitation on the of number of macros, the size of the macro names, or makeup of the hotkey combinations that invoke them.

Search, at the bottom of the dialog box, lets you filter the list of macros that appear in the large upper panel for you to play or edit. Click a radio button to choose whether you want to search by name or by key; key in a string for the search; then click **Search**. All instances that match your search string appear in the upper panel.

System Macros

System Macros are used to create exit macros for when you close a session. For example, as an added measure of security, you could create a macro that sends the Winkey-L combination which would cause the remote device's log in page to come up the next time the device was accessed. To create the macro, do the following:

1. Select *System Macros*, then click **Add**.

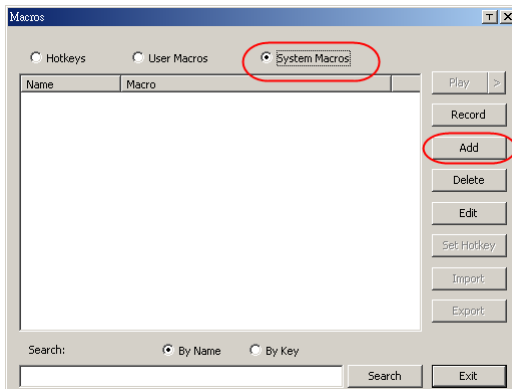

- In the dialog box that comes up, replace the “New Macro” text with a name of your choice for the macro:

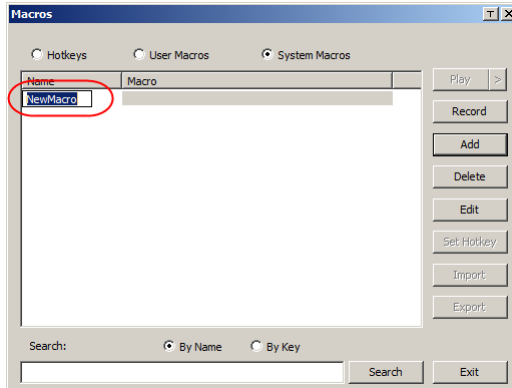

- Click **Record**.

The dialog box disappears, and a small panel appears at the top left of the screen:

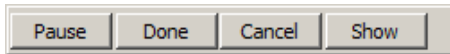

- Press the keys for the macro.
 - To pause macro recording, click **Pause**. To resume, click **Pause** again.
 - Clicking **Show** brings up a dialog box that lists each keystroke that you make, together with the amount of time each one takes (see page 73).

Note: 1. Case is not considered – typing **A** or **a** has the same effect.

- When recording the macro the focus must be on the remote screen. It cannot be in the macro dialog box.
 - Only the default keyboard characters may be used. Alternate characters cannot be used. For example, if the keyboard is Traditional Chinese and default character is **A** the alternate Chinese character obtained via keyboard switching is not recorded.
-

- If you haven't brought up the **Show** dialog, click **Done** when you have finished recording your macro. You return to the Macros dialog box with your system macro key presses displayed in the Macro column:

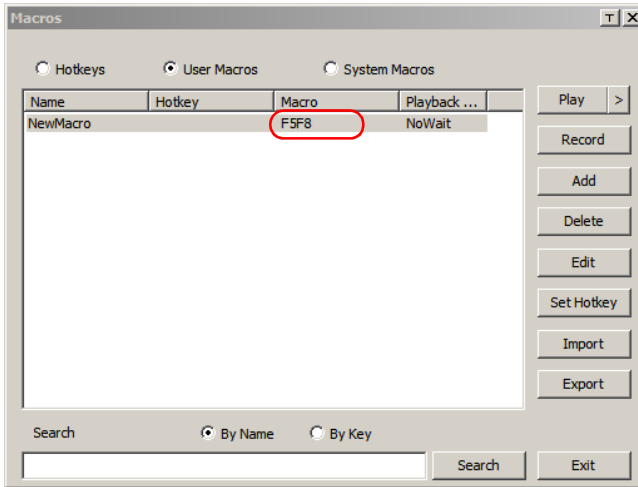

- If you want to change any of the keystrokes, select the macro and click **Edit**. This brings up a dialog box similar to the one for Show. You can change the content of your keystrokes, change their order, etc.
- Repeat the procedure for any other macros you wish to create.

Once the system macros have been created, you can choose to run any one them upon logging out of the CN8600 (see *Customization*, page 54 for details).

Note: 1. Information about the Search function is given on page 72.

- Systems macros are stored on the CN8600, therefore macro names may not exceed 64 English alphanumeric character, and hotkey combinations may not exceed 256 Bytes (each key usually takes 3–5 Bytes).
-



Video Settings

The *Video Settings* dialog box allows you to adjust the placement and picture quality of the remote screen display on your monitor.

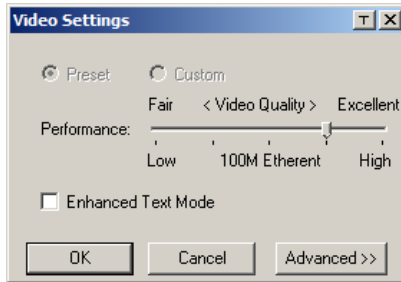

The adjustment options are as follows:

Option	Usage
	Click this to control the transparency of the Video Settings dialog box.
Performance	Select the type of internet connection that exists between the Local Client computer and the CN8600. The CN8600 will use that selection to automatically adjust the <i>Video Quality</i> and <i>Detect Tolerance</i> settings to optimize the quality of the video display. Since network conditions vary, if none of the pre-set choices seem to work well, you can select <i>Customize</i> and use the Video Quality and Detect Tolerance slider bars to adjust the settings to suit your conditions.
Enhanced Text Mode	Check this to solve video display problems related to video screen resolution that affect some interface systems (e.g., Sun Blade 1000 servers).
Advanced	See page 76 for details.

Gamma Adjustment

If it is necessary to correct the gamma level for the remote video display, use the Gamma function of the Video Adjustment dialog box.

Under **Basic** configuration, there are ten preset and four user-defined levels to choose from. Drop down the list box and choose the most suitable one.

For greater control, clicking the **Advanced** button brings up the following dialog box:

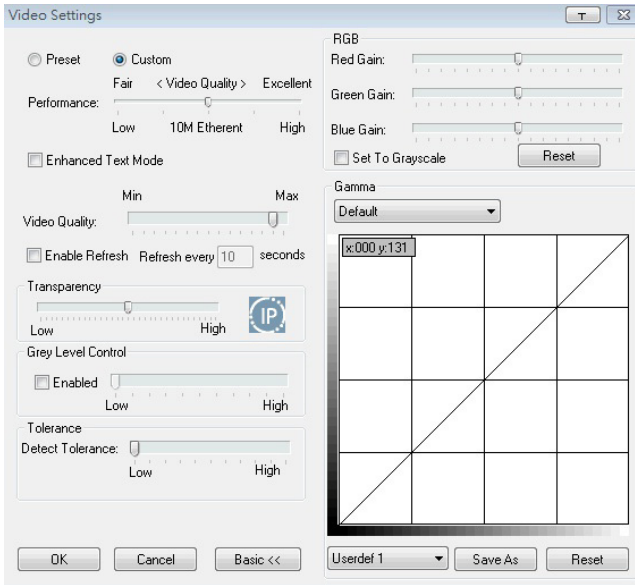

The additional options in the Advanced screen are as follows:

Option	Usage
RGB	<p>Drag the slider bars to adjust the RGB (Red, Green, Blue) values. When an RGB value is increased, the RGB component of the image is correspondingly increased.</p> <p>If you enable <i>Set to Grayscale</i>, the remote video display is changed to grayscale.</p>
Gamma	<p>This section allows you to adjust the video display's gamma level.</p> <p>Click and drag the diagonal line at as many points as you wish to achieve the display output you desire.</p> <p>Click <i>Save As</i> to save up to four user-defined configurations derived from this method. Saved configurations can be recalled from the list box at a future time.</p> <p>Click <i>Reset</i> to abandon any changes and return the gamma line to its original diagonal position.</p>

Option	Usage
Video Quality	Drag the slider bar to adjust the overall video quality. The larger the value, the clearer the picture and the more video data goes through the network. Depending on the network bandwidth, a high value may adversely affect response time.
Enable Refresh	<p>The CN8600 can redraw the screen every 1 to 99 seconds, eliminating unwanted artifacts from the screen. Select Enable Refresh and enter a number from 1 through 99. The CN8600 will redraw the screen at the interval you specify. This feature is disabled by default. Click to put a check mark in the box next to <i>Enable Refresh</i> to enable this feature.</p> <p>Note:</p> <ol style="list-style-type: none"> 1. The switch starts counting the time interval when mouse movement stops. 2. Enabling this feature increases the volume of video data transmitted over the network. The lower the number specified, the more often the video data is transmitted. Setting too low a value may adversely affect overall operating responsiveness.
Transparency	Drag the slider bars to adjust the transparency of the remote display.
Gray Level Control	Check the box and slide the bar to adjust the level of gray on the remote display.
Detect Tolerance	This setting also relates to video quality. It governs detecting or ignoring pixel changes. A high setting can result in a lower quality display due to less data transfer. A lower setting will result in better video quality, but setting the threshold too low may allow too much data to be transferred, negatively impacting network performance.

Click **OK** to save your changes and close the dialog box.

Click **Cancel** to abandon your changes and close the dialog box.

Note: For best results, change the gamma while viewing a remote computer.





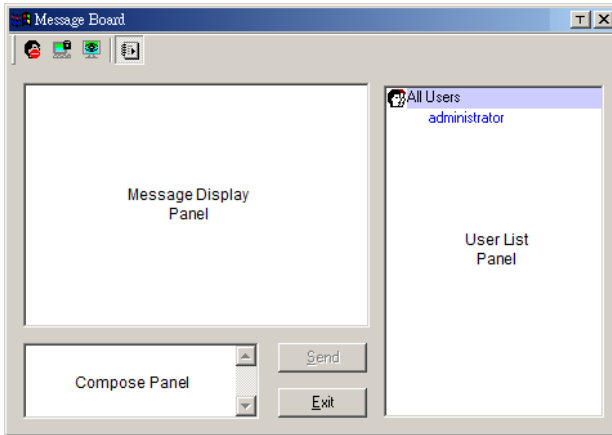

The Message Board

To alleviate the possibility of access conflicts resulting from multiple user logins, the CN8600 provides a message board that allows users to communicate with each other:



The Button Bar

The buttons on the **Button Bar** are toggles. Their actions are described in the table below:

Button	Action
	Enable/Disable Chat. When disabled, messages posted to the board are not displayed. The button is shadowed when Chat is disabled. The icon displays next to the user's name in the User List panel when the user has disabled Chat.
	Occupy/Release Keyboard/Video/Mouse. When a port is set to <i>Occupy</i> mode (see <i>Mode</i> , page 44), you can use this button to occupy the KVM. When you Occupy the KVM, other users cannot see the video, and cannot input keyboard or mouse data. The button is shadowed when the KVM is occupied. The icon displays next to the user's name in the User List panel when the user has occupied the KVM.
	Occupy/Release Keyboard/Mouse. When a port is set to <i>Occupy</i> mode (see <i>Mode</i> , page 44), you can use this button to occupy the KM. When you Occupy the KM, other users can see the video, but cannot input keyboard or mouse data. The button is shadowed when the KM is occupied. The icon displays next to the user's name in the User List panel when the user has occupied the KM.
	Show/Hide User List. When you Hide the User List, the User List panel closes. The button is shadowed when the User List is open.

Message Display Panel

Messages that users post to the board - as well as system messages - display in this panel. If you disable Chat, however, messages that get posted to the board won't appear.

Compose Panel

Key in the messages that you want to post to the board in this panel. Click **Send**, or press [**Enter**] to post the message to the board.

User List Panel

The names of all the logged in users are listed in this panel.

- ◆ Your name appears in blue; other users' names appear in black.
- ◆ By default, messages are posted to all users. To post a message to one individual user, select the user's name before sending your message.
- ◆ If a user's name is selected, and you want to post a message to all users, select **All Users** before sending your message.
- ◆ If a user has disabled Chat, its icon displays before the user's name to indicate so.
- ◆ If a user has occupied the KVM or the KM, its icon displays before the user's name to indicate so.

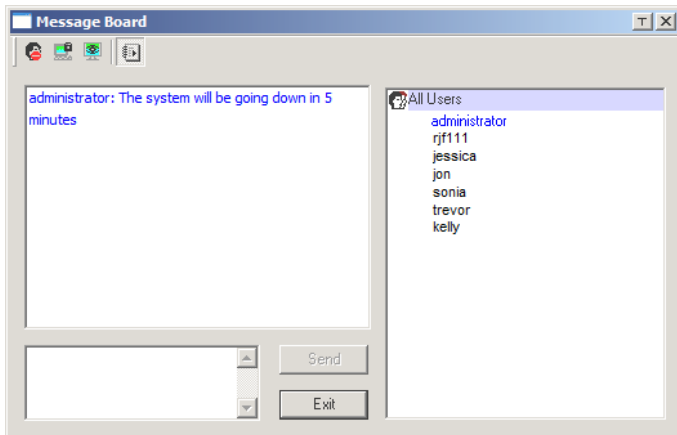





Virtual Media

The *virtual media* feature allows a drive, folder, image file, or removable disk on a local client computer to appear and act as if it were installed on the remote server. Virtual media also supports a smart card reader function that allows a reader plugged into a local client computer to appear as if it were plugged into the remote server.

Virtual Media Icons

The *virtual media* icon on the **WinClient Control Panel** changes, to indicate whether the virtual media function is available, or if a virtual media device has already been mounted on the remote server, as shown in the table below:

Icon	Function
	The icon displays in blue to indicate that the virtual media function is available. Click the icon to bring up the virtual media dialog box.
	The icon displays in blue with a red X to indicate that a virtual media device has been mounted on the remote server. Click the icon to unmount all redirected devices.

Virtual Media Redirection

To implement the virtual media redirection feature, do the following:

1. Click the virtual media icon to bring up the *virtual media* dialog box:

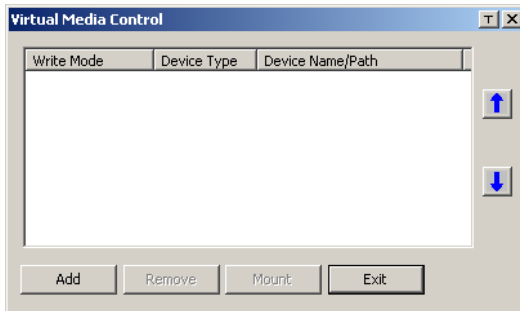

2. Click **Add**; then select the media source.

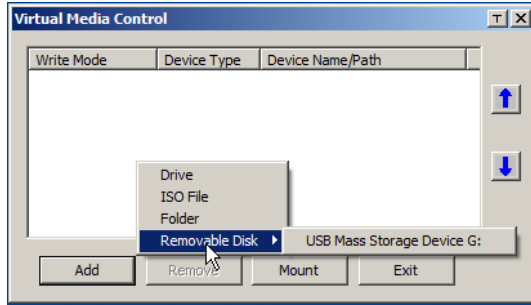

Depending on your selection, additional dialog boxes appear enabling you to select the drive, file, folder, or removable disk you desire. See *Virtual Media Support*, page 150 for details about mounting these media types.

3. To add additional media sources, click **Add**, and select the source as many times as you require.

Up to three virtual media choices can be mounted. The top three in the list are the ones that are selected. To rearrange the selection order, highlight the device you want to move, then click the **Up** or **Down** Arrow button to promote or demote it in the list.

4. *Read* refers to the redirected device being able to send data to the remote server; *Write* refers to the redirected device being able to have data from the remote server written to it. The default is for **Write** to not be enabled (Read only). If you want the redirected device to be writable as well as readable, click to put a check in the *Enable Write* checkbox:

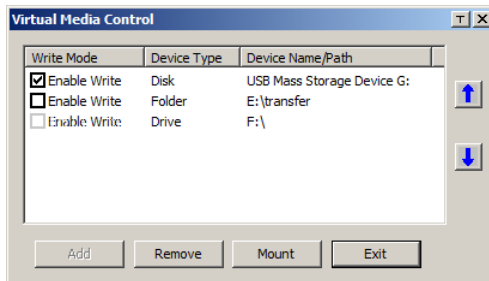

-
- Note:**
1. If a redirected device cannot be written to, or if a user does not have write permissions, it appears in gray and cannot be selected.
 2. See *Virtual Media Support*, page 150, for a list of supported virtual media types.
-

- To remove an entry from the list, highlight it and click **Remove**.
- After you have made your media source selections, click **Mount**. The dialog box closes. The virtual media devices that you have selected are redirected to the remote system, where they show up as drives, files and folders on the remote system's file system.

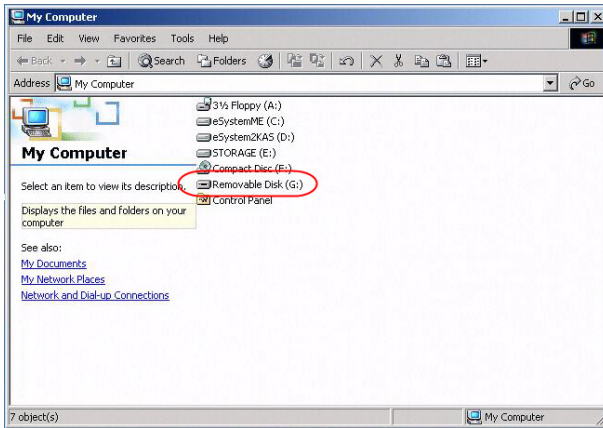

Once mounted, you can treat the virtual media as if they were really on the remote server – drag and drop files to/from them; open files on the remote system for editing and save them to the redirected media, etc.

Files that you save to the redirected media, will actually be saved on your local system. Files that you drag from the redirected media will actually come from your local system.

- To end the redirection, bring up the *Control Panel* and click on the *virtual media* icon. All mounted devices are automatically unmounted.

Smart Card Reader

Note: This feature is only available when using the *WinClient Viewer* or the *Windows Client AP*.

The smart card reader function allows a reader plugged into a local client computer's USB port to be redirected, and appear as if it were plugged into the remote server. One purpose of smart cards (Common Access Cards, for example), is to allow authentication to the remote server from the local client.

When a smart card reader is connected to the local client computer, an entry for it appears when you bring up the **virtual media** dialog box and click **Add**:

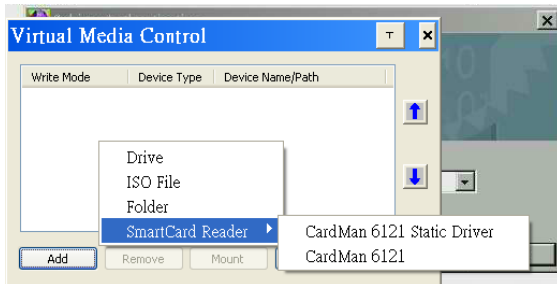

Make your selection; then click **Mount** to complete the redirection.

Note: If you mount a smart card reader, you cannot mount any other virtual media device. If any virtual media devices are already mounted, you must unmount them before you can mount the smart card reader.



Zoom

The *Zoom* icon controls the zoom factor for the remote view window. Settings are as follows:

Setting	Description
100%	Sizes and displays the remote view window at 100%.
75%	Sizes and displays the remote view window at 75%.
50%	Sizes and displays the remote view window at 50%.
25%	Sizes and displays the remote view window at 25%.
1:1	Sizes and displays the remote view window at 100%. The difference between this setting and the 100% setting is that when the remote view window is resized its contents don't resize – they remain at the size they were. To see any objects that are outside of the viewing area move the mouse to the window edge, to have the screen scroll.



The On-Screen Keyboard

The CN8600 supports an on-screen keyboard, available in multiple languages, with all the standard keys for each supported language.

Click this icon to pop up the on-screen keyboard:

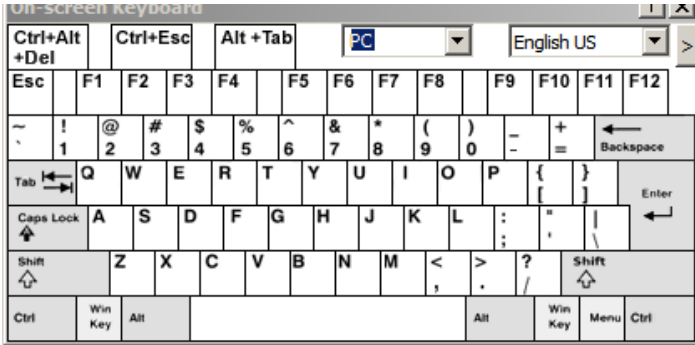

One of the major advantages of the on-screen keyboard is that if the keyboard languages of the remote and local systems are not the same, you do not have to change the configuration settings for either system. The user just has to bring up the on-screen keyboard; select the language used by the computer on the port he is accessing; and use the on-screen keyboard to communicate with it.

Note: You must use your mouse to click on the keys. You cannot use your actual keyboard.

To change languages, do the following:

1. Click the down arrow next to the currently selected language to drop down the language list.

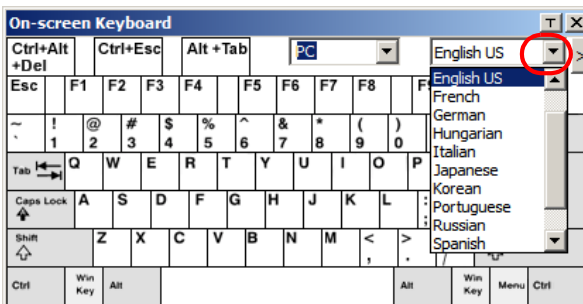

2. Select the new language from the list.

To display/hide the expanded keyboard keys, click the arrow to the right of the language list arrow.

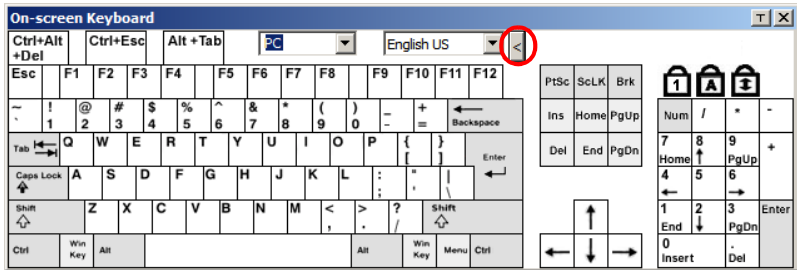

Mouse Pointer Type

The CN8600 offers a number of mouse pointer options when working in the remote display. Click this icon to select the type that you would like to work with:

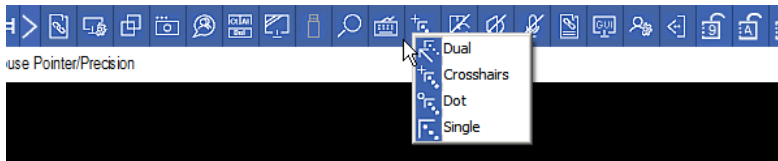

Note: The icon on the Control Panel changes to match your choice.



Mouse DynaSync Mode

Clicking this icon selects whether synchronization of the local and remote mouse pointers is accomplished either automatically or manually.

Automatic Mouse Synchronization (DynaSync)

Mouse DynaSync provides automatic locked-in synching of the remote and local mouse pointers – eliminating the need to constantly resync the two movements.

The icon on the toolbar indicates the synchronization mode status as follows:

Icon	Function
	The green check mark on this icon indicates that Mouse DynaSync is available and is enabled . This is the default setting when Mouse DynaSync is available. (See the Note, above.)
	The red X on this icon indicates that Mouse DynaSync is available but is not enabled .

When *Mouse DynaSync* is available, clicking the icon toggles its status between enabled and /disabled. If you choose to disable Mouse DynaSync mode, you must use the manual syncing procedures described in the next section.

Manual Mouse Synchronization

If you are using Manual mouse synchronization instead of automatic DynaSync and the local mouse pointer goes out of sync with the remote system's mouse pointer, there are a number of methods to bring them back into sync:

1. Perform a video and mouse auto sync by clicking the *Video Settings* icon on the Control Panel (see page 75).
2. Perform an **Auto Sync** with the Video Adjustment function (see *Video Settings*, page 75, for details).
3. Invoke the **Adjust Mouse** function with the *Adjust Mouse* hotkeys (see *Adjust mouse*, page 67, for details).
4. Move the pointer into all 4 corners of the screen (in any order).
5. Drag the Control Panel to a different position on the screen.
6. Set the mouse speed and acceleration for each problematic computer attached to the switch. See *Additional Mouse Synchronization Procedures*, page 148, for instructions.



Control Panel Configuration

Clicking the *Customize Control Panel* icon brings up a dialog box that allows you to configure the items that appear on the Control Panel, as well as its graphical settings:

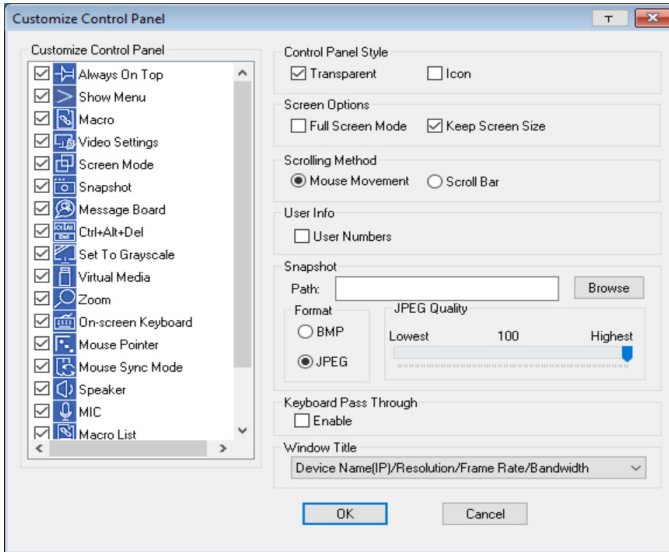

The dialog box is organized into five main sections as described in the table below:

Item	Description
Customize Control Panel	Allows you to select which icons display in the Control Panel
Control Panel Style	<ul style="list-style-type: none"> Enabling <i>Transparent</i> makes the Control Panel semi-transparent, so that you can see through it to the display underneath. Enabling <i>Icon</i> causes the Control Panel to display as an icon until you mouse over it. When you mouse over the icon, the full panel comes up.

Item	Description
Screen Options	<ul style="list-style-type: none"> ◆ If Full Screen Mode is enabled, the remote display fills the entire screen. ◆ If Full Screen Mode is not enabled, the remote display appears as a window on the client desktop. If the remote screen is larger than what is able to fit in the window, scroll bars will appear. ◆ If Keep Screen Size is enabled, the remote screen is not resized. <ul style="list-style-type: none"> ◆ If the remote resolution is smaller than that of the client monitor, its display appears like a window centered on the screen. ◆ If the remote resolution is larger than that of the client monitor, its display is scaled to the client monitor size. ◆ If Keep Screen Size is not enabled, the remote screen is resized to fit the client monitor's resolution.
Scrolling Method	<p>In cases where the remote screen display is larger than your monitor, you can choose how to scroll to the areas that are off-screen.</p> <ul style="list-style-type: none"> ◆ If you select <i>Mouse Movement</i>, the screen will scroll when you move the mouse pointer to your screen border. ◆ If you select <i>Scroll Bars</i>, scroll bars appear around the screen borders that you can use to scroll to the off-screen areas.
User Info	<p>If <i>Show User Numbers</i> is enabled, the total number of users logged into the CN8600 displays in the center of the upper text row of the Control Panel (See the <i>Control Panel</i> diagram on page 62 for an example.)</p>
Snapshot	<p>These settings let the user configure the CN8600's screen capture parameters (see the <i>Snapshot</i> description under <i>The WinClient Control Panel</i>, page 62):</p> <ul style="list-style-type: none"> ◆ Path lets you select a directory that the captured screens automatically get saved to. Click Browse; navigate to the directory of your choice; then click OK. If you don't specify a directory here, the snapshot is saved to your desktop. ◆ Click a radio button to choose whether you want the captured screen to be saved as a BMP or a JPEG (JPG) file. ◆ If you choose JPEG, you can select the quality of the captured file with the slider bar. The higher the quality, the better looking the image, but the larger the file size.
Keyboard Pass Through	<p>When this is enabled, the Alt-Tab key press is passed to the remote server and affects that server. If it is not enabled, Alt-Tab acts on your local client computer.</p>
Window Title	<p>For the drop-down menu, you can choose how much information is displayed for the remote server.</p>



Admin Utility (GUI)

Clicking the *Admin Utility* icon brings up a window that allows you to configure the CN8600 via Viewer based GUI with the web browser administrative functionalities:



The sidebar menu items available on this page are based upon the user's permissions. For information on how to use these functions, see *Configuration*, page 19 for details.

This Page Intentionally Left Blank

Chapter 6

AP Operation

Introduction

In addition to the browser based client viewers, the CN8600 also provides stand-alone Windows and Java applications that can be used without a browser. The applications can be found on the CN8600 software CD. Download the Windows Client AP and *the* Java Client AP from the web GUI. Refer to *Download*, page 59 for more details.

The Windows Client AP

Installation

To install the stand-alone Windows Client program, do the following:

1. In the web GUI, go to the Download page. Refer to *Download*, page 59 for more details.
2. Click the **Windows Client AP** button.
3. Follow the on-screen instructions to complete the installation and have the Windows Client program icon placed on your desktop.

Starting Up

To connect to the CN8600, either click its icon on the desktop or click its entry on the Start menu.

The Windows Client Connection Screen

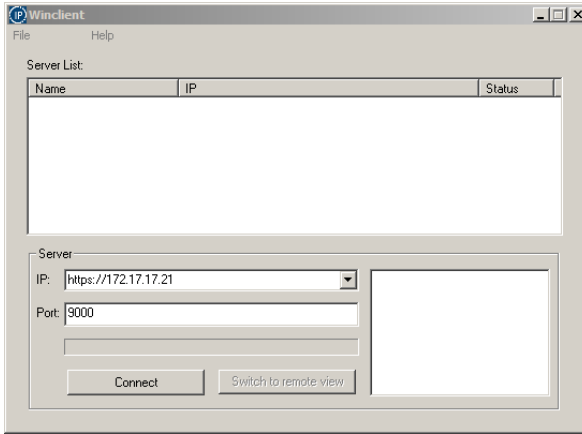

A description of the Connection Screen is given in the following table:

Item	Description
Server List	Each time the CN8600 Windows Client program is run, it searches the user's local LAN segment for CN8600 units, and lists whichever ones it finds in this box. If you want to connect to one of these units, select it, then click Login . When you have finished with your session, Click Logout to end the connection.
Server	This area is used when you want to connect to a CN8600 at a remote location. If the IP address that appears is not the one you want, or if there is no entry at all, key in the IP address you want. Next, key in the Port number in the <i>Port</i> field. If you don't know the Port number, contact the Administrator. When the IP address and Port number for the unit you wish to connect to have been specified, click Login to start the connection. When you have finished with your session, Click Logout to end the connection.
Login	Starts the connection to the CN8600.
Logout	These buttons become active once you log into the CN8600. See page 93 for details.
Remote View	
Message List	This shows the current status of the server connection.

Logging In

Once the CN8600 connects to the unit you specified, a login window appears:

The screenshot shows a 'Login' dialog box with the following fields and controls:

- Username:** administrator
- Password:** [Seven dots]
- Remember password
- Buttons:** OK, Cancel

Provide a valid Username and Password, then Click **OK** to continue.

Note: The default Username is *administrator*; the default Password is *password*. For security, we strongly recommend that you change these to something unique (see *Logs*, page 57, for details).

After you have successfully logged in, the Connection screen reappears:

The screenshot shows the 'Connection' screen with the following elements:

- Server List:** A table with columns 'Name' and 'IP'.
- Server Information:**
 - IP: 10.3.50.34
 - Port: 9000
- Buttons:** Login, Logout, Remote View
- Message List:** Server is ready.

At this time there are two active buttons, as described in the table, below:

Button	Action
Logout	Breaks the connection to the CN8600.
Remote View	In some cases, administrator's do not wish to have users connect to the CN8600 with a browser. <i>Remote View</i> solves this problem. It opens a window on the user's desktop containing the remote server's display that is the same as the one that appears with the browser-based Windows client. Refer to Chapter 5, <i>The Client Viewer</i> , for operation details.

The Administrator Utility

The Administrator Utility appears as a tabbed notebook. Each tab represents a different administrative function. A description of the functions and how to configure their settings is provided in the sections that follow.

The Settings notebook opens with the *Port Access* page displayed.

KVM over IP
CN8600

ATEN

Basic Settings

- User Management
- Sessions
- Maintenance

Advanced Setting

- Device Information
- Network
- ANMS
- Security
- Console Management
- Date/Time
- Customization

Preferences

- User Preferences
- Log
- Remote Console

Download

About

Device Name: CN8600

General	
MAC1 Address:	00-49-54-00-77-8b
MAC2 Address:	00-49-54-00-77-99
Firmware Version:	V1.0.063.20130312
FPGA:	Build20130803
IP Address 1:	172.17.17.21
Subnet Mask 1:	255.255.255.0
Gateway 1:	172.17.17.254
IPv6 Address 1:	FE80:0:0:48:5AFF:FE00:778B
IPv6 Subnet Prefix Length 1:	0

Viewer Logout Save

Copyright (C) 2012 ATEN International Co., Ltd. V1.0.061.20121221

This page is essentially the same as the browser-based version. Additionally, the icons at the top panel perform the same functions as the browser-based version. See Chapter 4, *Configuration* for information on these pages.

The Java Client AP

The Java Client AP is provided to make the CN8600 accessible to all platforms. Systems that have JRE 6 Update 3 or higher installed can connect. If you don't already have Java, it is available for free download from Sun's Java web site (<http://java.sun.com>).

Starting Up

To connect to the CN8600 with the stand-alone Java Client program, copy *JavaClient.jar* to a convenient location on your hard disk; then double-click its icon – or key in the full path to the program on the command line – to bring up the Java Client Connection screen.

The Java Client Connection Screen

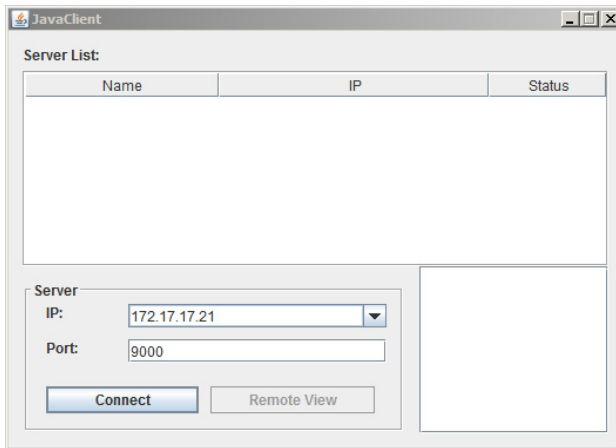

To connect to the CN8600

1. Key in its IP address in the Server field.
2. If the port number shown is not correct, key in the correct number.
3. Click **Connect**.

Logging In

Once the CN8600 connects to the unit you specified, a login window appears:

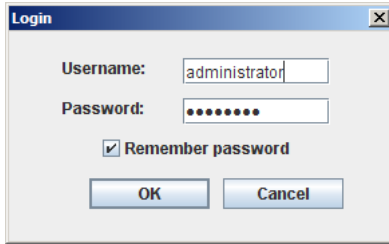

Username: administrator
Password: ●●●●●●●
 Remember password
OK Cancel

Provide a valid Username and Password, then Click **OK**.

Note: The default Username is *administrator*; the default Password is *password*. For security, we strongly recommend that you change these to something unique (see *Logs*, page 57, for details).

After you have successfully logged in, the Connection screen reappears:

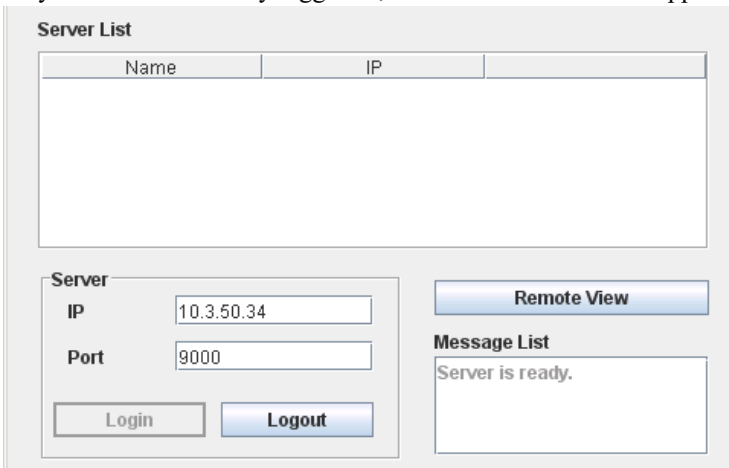

Server List

Name	IP
------	----

Server

IP: 10.3.50.34
Port: 9000

Login Logout

Remote View

Message List
Server is ready.

These function the same way as the ones described in the Windows Client AP section. See page 93 for details.

Java Client AP operation is essentially the same as Windows Client AP operation. Refer to the relevant Windows Client AP sections for operation details.

Chapter 7

The JavaClient Viewer

Introduction

The JavaClient Viewer makes the CN8600 accessible to all platforms that have the Java Runtime Environment (JRE) installed. (See *System Requirements*, page 5, for the required JRE version.) The JRE is available for free download from the Java web site (<http://java.com>).

To run the JavaClient Viewer, after you log in (see *Logging In*, page 15), Click the **Open Java Applet** link on the *Remote Console Preview* panel.

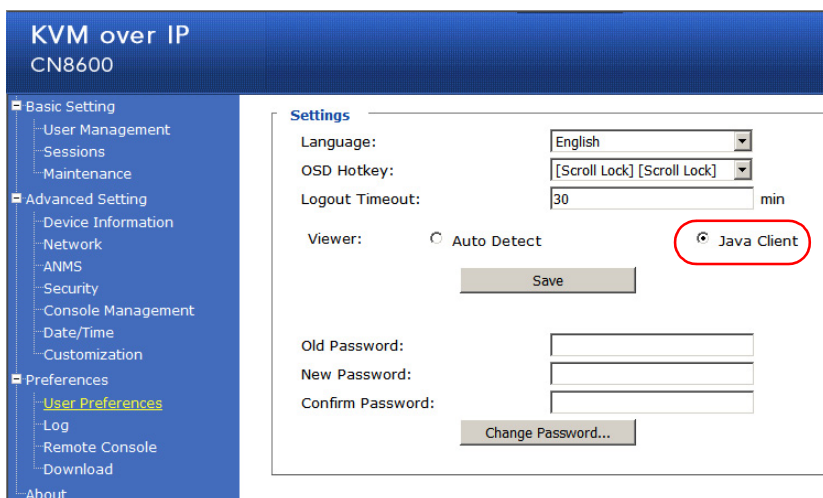

Note: The links that appear below the *Refresh* button depend on the browser you are using, and your User Preferences *viewer* choice. See *User Preferences*, page 56 for details

A second or two after you click the **Open Java Applet** (or *Open Viewer*) link, the remote server's display appears as a window on your desktop:

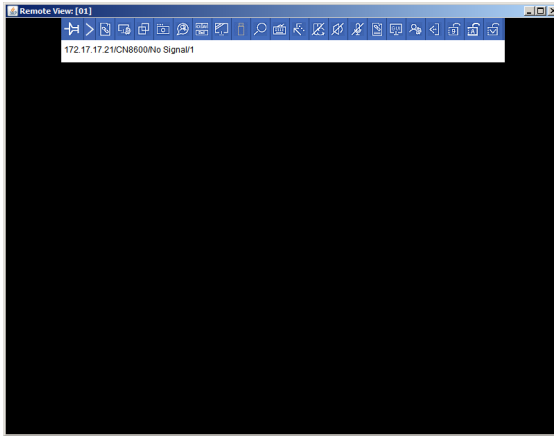

Navigation

You can work on the remote system via the screen display on your monitor just as if it were your local system.

- ◆ You can maximize the window, drag the borders to resize the window; or use the scrollbars to move around the screen.
- ◆ You can switch between your local and remote programs with [Alt + Tab].

Note: 1. Due to net lag, there might be a slight delay before your keystrokes show up. You may also have to wait a bit for the remote mouse to catch up to your local mouse before you click.

2. Due to net lag, or insufficient computing power on the local machine, some images, especially motion images, may display poorly.
-

The JavaClient Control Panel

The JavaClient control panel is hidden at the top center of the screen. It becomes visible when you move the mouse pointer into that area:



- Note:**
1. The above image shows the complete Control Panel. The icons that appear can be customized. See *Control Panel Configuration*, page 107, for details.
 2. To place the control panel anywhere on the screen, move the mouse pointer over the text bar area and drag the panel to the new position.
- ◆ By default, the left of the top text row shows the video resolution of the remote display. As the mouse pointer moves over the icons in the icon bar, however, the information in the top text row changes to describe the icon's function.
 - ◆ If the *User Info* function has been enabled under *Control Panel Configuration* (see *User Info*, page 88), the total number of users currently logged into the CN8600 displays in the right of the upper text row.
 - ◆ Right clicking in the text row area brings up a menu that allows you to select options for the *Zoom*, *Mouse Pointer type*, and *Mouse Sync Mode*. *These functions are discussed in the sections that follow.*

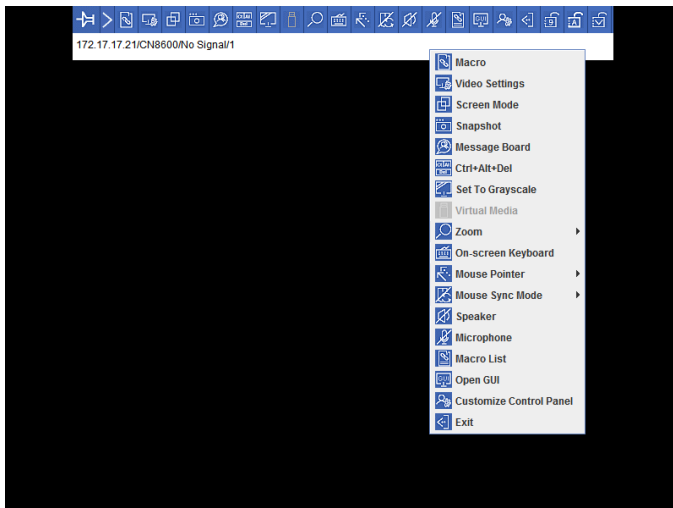

Control Panel Functions

The Control Panel functions are described in *Control Panel Functions*, page 64.



Macros

The Macros icon provides access to three functions found in the Macros dialog box: Hotkeys, User Macros, and System Macros. Each of these functions is described in the following sections.

Hotkeys

Various actions related to manipulating the remote server can be accomplished with s. Selecting the *Hotkeys radio button* lets you configure which s perform the actions.

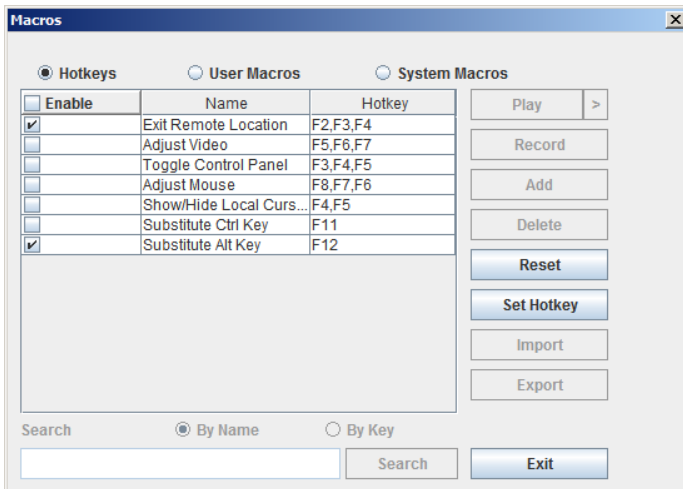

Hotkey operation is the same under the JavaClient as it is under the WinClient. See *Hotkeys*, page 66 for details.

Note: *Toggle Mouse Display* is not available in the JavaViewer version.

User Macros

User Macros are used to perform specific actions on the remote server. To create the macro, do the following:

1. Select the *User Macros* radio button, then click **Add**.

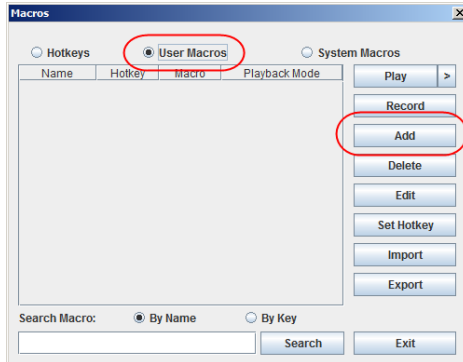

User Macro operation is the same under the JavaClient as it is under the WinClient. See *User Macros*, page 68 for details.

System Macros

System Macros are used to create exit macros for when you close a session. For example, as an added measure of security, you could create a macro that sends the Winkey-L combination which would cause the remote device's log in page to come up the next time the device was accessed. To create the macro, do the following:

1. Select *System Macros*, then click **Add**.

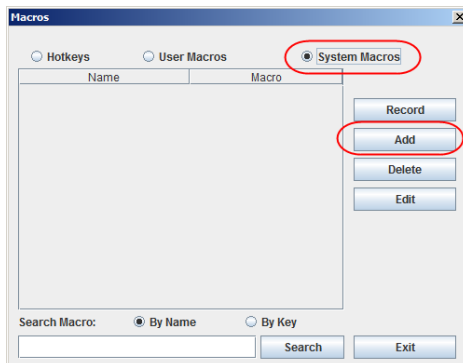

System Macro operation is the same under the JavaClient as it is under the WinClient. See *System Macros*, page 72 for details.

Search allows you to find previously created macros and have them listed in the large upper panel for you to play or edit.

The **Search** operation is the same under the JavaClient as it is under the WinClient. See p. 72 for details.



Video Settings

The *Video settings* dialog box allows you to adjust the placement and picture quality of the remote screen display on your monitor.

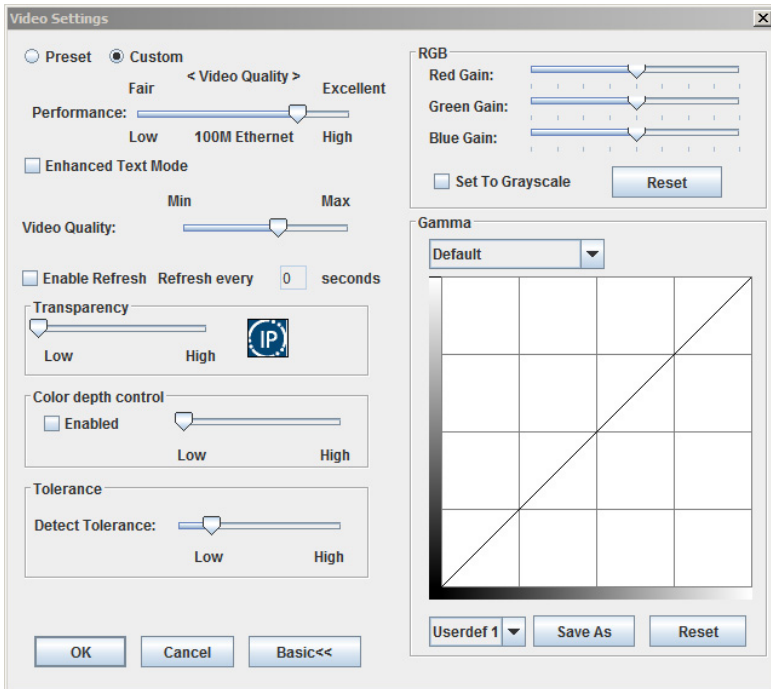

Video Settings operation is the same under the JavaClient as it is under the WinClient. See *Video Settings*, page 75 for details.



Message Board

The CN8600 supports multiple user logins, which can possibly give rise to access conflicts. To alleviate this problem, a message board feature, similar to an internet chat program, allows users to communicate with each other:

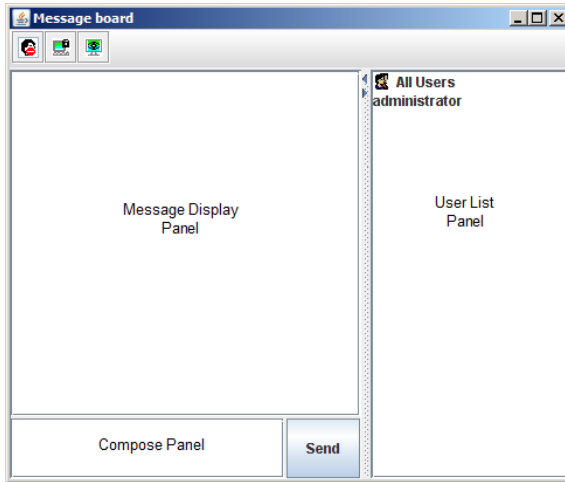

The buttons on the Button Bar are toggles. Their actions are described in the table below:

	<p>Enable/Disable Chat. When disabled, messages posted to the board are not displayed. The button is shadowed when Chat is disabled. The icon displays next to the user's name in the User List panel when he has disabled Chat.</p>
	<p>Occupy/Release Keyboard/Video/Mouse. When you Occupy the KVM, other users cannot see the video, and cannot input keyboard or mouse data. The button is shadowed when the KVM is occupied. The icon displays next to the user's name in the User List panel when he has occupied the KVM.</p>
	<p>Occupy/Release Keyboard/Mouse. When you Occupy the KVM, other users can see the video, but cannot input keyboard or mouse data. The button is shadowed when the KVM is occupied. The icon displays next to the user's name in the User List panel when he has occupied the KVM.</p>
	<p>Show/Hide User List. Click the left (show)/right (hide) arrows if you want to show or hide the user list.</p>

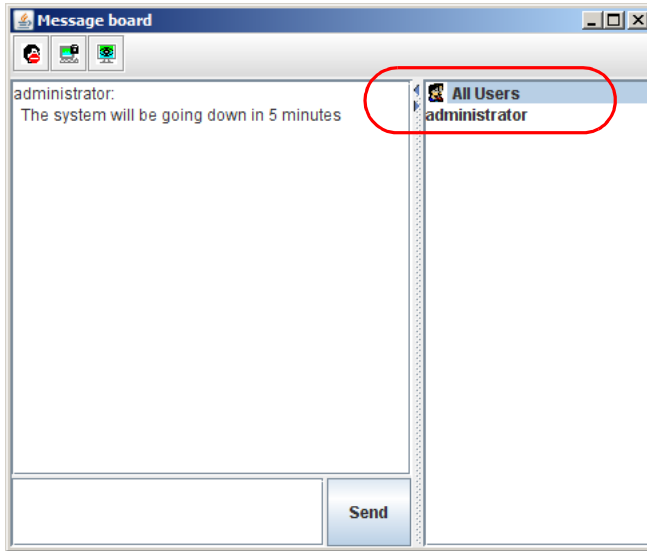

- ◆ The names of all the logged in users appear in the **User List** panel.
 - ◆ Select the users that you want to post to before sending your message. Users that are not selected will not see the message.
 - ◆ To Hide/Unhide the **User List** panel, click on the arrows in the panel separator.
 - ◆ If a user has disabled Chat, the *Disabled Chat* icon displays before the user's name to indicate so.
 - ◆ If a user has occupied the KVM or the KM, the corresponding icon displays before the user's name to indicate so.
- ◆ Key in the messages that you want to post to the board in the *Compose* panel. Click **Send**, to post the message to the board.
 - ◆ Messages that users post to the board – as well as system messages – display in the **Message Display** panel. If you disable Chat, however, messages that get posted to the board do not appear.
 - ◆ If another user sends a message to the message board and your message board is not open, a window showing the message pops up on your screen.



Virtual Media

The *Virtual Media* feature allows a folder or image file on a local client computer to appear and act as if it were installed on the remote server. Virtual media also supports a smart card reader function that allows a reader plugged into a local client computer to appear as if it were plugged into the remote server.

To implement this redirection feature, do the following:

1. Click the virtual media icon to bring up the *virtual media* dialog box:

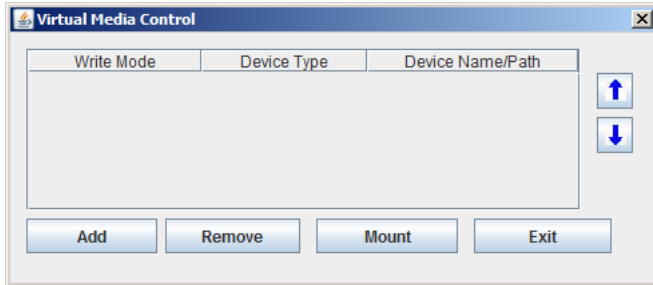

Virtual media operation is the same under the JavaClient as it is under the WinClient. See *Virtual Media*, page 80 for details.

Note: Only the *ISO File* and *Folder* virtual media functions are supported with the Java Viewer.



Zoom

The *Zoom* icon controls the zoom factor for the remote view window. Settings are as follows:

Setting	Description
100%	Sizes and displays the remote view window at 100%.
75%	Sizes and displays the remote view window at 75%.
50%	Sizes and displays the remote view window at 50%.
25%	Sizes and displays the remote view window at 25%.
1:1	Sizes and displays the remote view window at 100%. The difference between this setting and the 100% setting is that when the remote view window is resized its contents don't resize – they remain at the size they were. To see any objects that are outside of the viewing area move the mouse to the window edge, to have the screen scroll.



The On-Screen Keyboard

The CN8600 supports an on-screen keyboard, available in multiple languages, with all the standard keys for each supported language. Click this icon to pop up the on-screen keyboard:

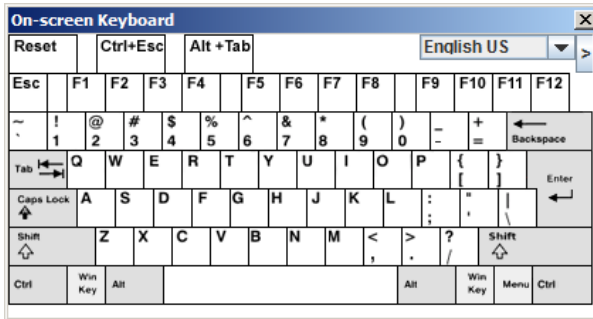

On-Screen Keyboard operation is the same under the JavaClient as it is under the WinClient. See *The On-Screen Keyboard*, page 84 for details.



Mouse Pointer Type

The CN8600 offers a number of mouse pointer options when working in the remote display. Click this icon to select the type that you would like to work with:



Note: The icon on the Control Panel changes to match your choice.



Mouse DynaSync Mode

Clicking this icon selects whether synchronization of the local and remote mouse pointers is accomplished either automatically or manually.

DynaSync operation is the same under the JavaClient as it is under the WinClient. See *Mouse DynaSync Mode*, page 85 for details.



Control Panel Configuration

Clicking the *Customize Control Panel* icon brings up a dialog box that allows you to configure the items that appear on the Control Panel, as well as its graphical settings:

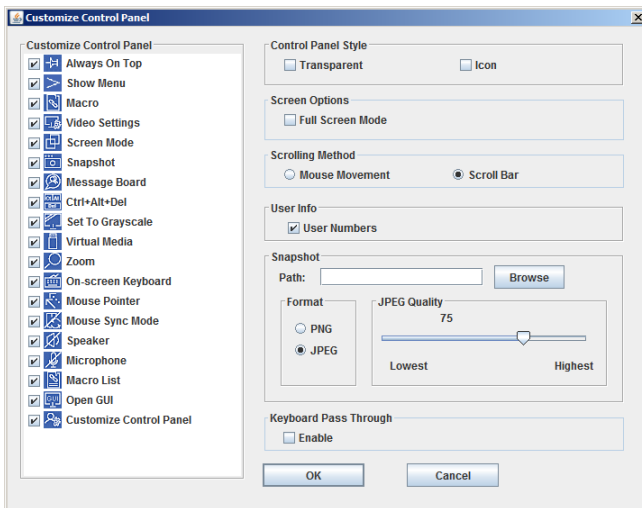

Control Panel Configuration is almost the same under the JavaClient as it is under the WinClient. See *Control Panel Configuration*, page 87 for details.

Note: The following functions found with the WinClient are not available with the JavaClient: the *Transparent* control panel style; and *Screen Options*. In addition, the BMP graphics format (in the Snapshot section), has been replaced by PNG.

This Page Intentionally Left Blank

Chapter 8

Local Console

The CN8600 can be accessed directly from a local console's keyboard/mouse/monitor or via a laptop application (AP) program at the local site.

Console Lock Switch

Use this switch to lock the console so that remote access is disabled (view only) and only the local console can operate the CN8600.

When set to unlock, the CN8600 grants access depending on the configuration stored.

Local Console

Use the keyboard, mouse and monitor to directly access and operate the local console port. The CN8600 is able to split the signal to both the local and remote consoles.

- ♦ The local console has priority by default. Refer to **Console Lock Switch** on page 9.
- ♦ To configure concurrent usage for the local console user and remote console user(s), refer to **Multiuser Mode** on page 55.

Message Tag

When a remote user logs on to the CN8600, a message tag displays in the local console. This serves as a reminder to the local user that operations may be affected. Close the message tag by pressing the ESC key.

If the local user does not want operations to be disrupted, make sure the **Console Lock Switch** is locked to the local console. The message tag does not appear in this case.

Laptop USB Console

To use the mini-B USB port for laptop USB console (LUC) operations, set the switch at the rear panel of the CN8600 to **LUC**.

Note: The LUC function only works for Windows systems.

The laptop application (AP) program for operating the LUC is built into the CN8600's firmware and does not require a download. To access the switch, do the following:

1. Use the USB 2.0 cable (A-type to mini USB) included in the package to connect your laptop to the CN8600's mini USB port, located on the unit's rear panel (see *Installation*, page 13).
2. The CN8600 appears as a virtual drive in the laptop's file system. Go to the drive and locate the Winclient or Javaclient AP. Select the preferred client and double-click the icon. The AP's connect page will appear. An example is shown:

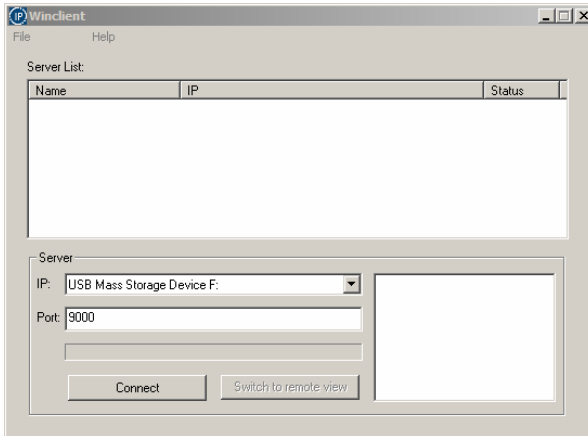

3. Select the "USB Mass Storage Device" and click **Connect**.

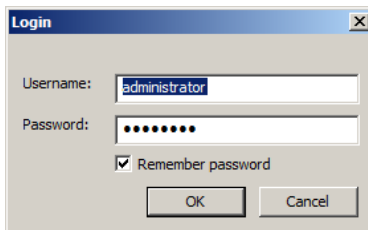

4. Enter the Username/Password (*administrator/password*) and click **OK**.
5. If the login was successful, the **Remote View** button becomes active.
6. Click **Remote View** to bring up the Laptop Console Main Page.
If this is the first time you log into the system, the system will prompt you to change the password.

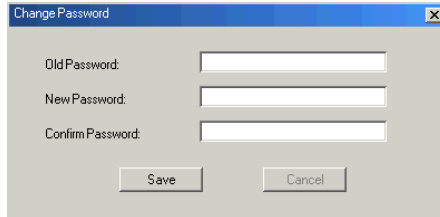
A screenshot of a 'Change Password' dialog box. The dialog has a blue title bar with the text 'Change Password' and a close button (X) on the right. The main area is light gray and contains three text input fields. The first field is labeled 'Old Password:', the second 'New Password:', and the third 'Confirm Password:'. Below the fields are two buttons: 'Save' and 'Cancel'.

Enter the empty fields and click **Save** to save the new password.

The Laptop Console Main Page is similar to the browser version, for more information, refer to *Configuration* on page 19.

Laptop USB Console Main Page

After connecting a laptop to the CN8600's Laptop port, logging in, and opening the AP, the Laptop Console main page appears.



The Laptop Console Main Page is similar to the Web Browser, WinClient and Java Client Main Pages. See *AP Operation*, page 91, for further details, and reference the AP GUI sections throughout the rest of the manual regarding operations.

Chapter 9

The Log File

The Log File Screen

The CN8600 logs all the events that take place on it. Following a reset, it writes them to a log file, which is a searchable database. To view the contents of the log file, click the *Log* icon at the center left of the page. A screen similar to the one below appears:

Time	Severity	User	Log Information
2012/12/04 15:16:54	Least	System	Log update 1
2012/12/04 15:06:47	Most	System	User administrator from 10.3.41.58 (00-18-6E-4D-DD-81) attempting to login via browser.
2012/12/04 15:06:21	Most	System	User administrator from 10.3.41.58 (00-18-6E-4D-DD-81) attempting to login via browser.
2012/12/04 15:02:30	Most	System	User administrator from 10.3.41.58 (00-18-6E-4D-DD-81) attempting to login via browser.
2012/12/04 15:01:07	Most	System	User administrator from 10.3.41.91 (00-18-6E-4D-DD-81) logged out via browser.
2012/12/04 15:01:06	Most	administrator	End session for user administrator.
2012/12/04 15:01:06	Most	administrator	User administrator (10.3.41.91) logged out. Online time : 00:01:25.
2012/12/04 15:01:03	Most	administrator	User administrator (10.3.41.91) logged out. Online time : 00:00:30.
2012/12/04 15:00:33	Least	administrator	User administrator changes to [01] .
2012/12/04 15:00:33	Most	administrator	User administrator logged in.
2012/12/04 15:00:33	Most	System	User administrator (10.3.41.91) attempting to login.
2012/12/04 15:00:33	Most	System	SYS: Access via windows client 10.3.41.91.
2012/12/04 15:00:33	Most	System	Sys: Connected to 10.3.41.91 (00-18-6E-4D-DD-81).
2012/12/04 15:00:19	Least	System	Get snapshot result....01B70490 9628
2012/12/04 15:00:15	Most	System	User administrator from 10.3.41.58 (00-18-6E-4D-DD-81) attempting to login via browser.
2012/12/04 15:00:08	Least	System	Send snapshot request...
2012/12/04 14:59:42	Most	administrator	Start session for user administrator.
2012/12/04 14:59:41	Least	administrator	User administrator changes to [01] .
2012/12/04 14:59:41	Most	administrator	User administrator logged in.

A maximum of 512 events are kept in the log file. As new events are recorded, they are placed at the bottom of the list. When a new event is recorded after there are 512 events in the log file, the earliest event in the list is discarded.

Note: To maintain and view a record of all the events that take place (not just the most recent 512), set up the Log Server AP program. see *The Log Server*, page 115.

To clear the log file, click on the *Clear Log* icon at the lower right of the page.

This Page Intentionally Left Blank

Chapter 10

The Log Server

The Log Server is a Windows-based administrative utility that records all the events that take place on selected CN8600 units and writes them to a searchable database. This chapter describes how to install and configure the Log Server.

Installation

1. In the web GUI, go to the Download page. Refer to *Download*, page 59 for more details.
2. Click the **Download Log Server AP** button.
3. Follow the on-screen instructions to complete the installation and have the Log Server program icon placed on your desktop.

Starting Up

To bring up the Log Server, either double click the program icon, or key in the full path to the program on the command line. The first time you run it, a screen similar to the one below appears:

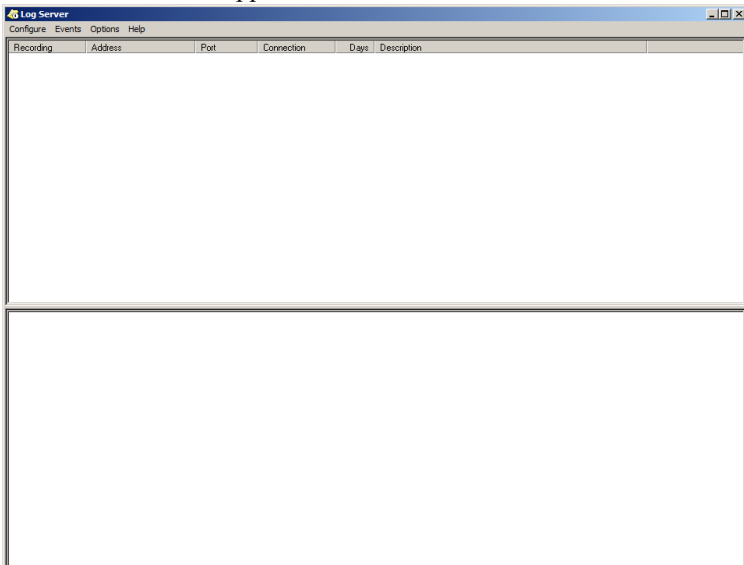

- Note:** 1. The MAC address of the Log Server computer must be specified in the *ANMS* settings – see *Log Server*, page 35 for details.
2. The Log Server requires the Microsoft Jet OLEDB 4.0 driver. See *The Log Server*, page 147 if the program does not start.
-

The screen is divided into three components:

- ◆ A *Menu Bar* at the top
- ◆ A panel that will contain a list of CN8600 units in the middle (see *The Log Server Main Screen*, page 120, for details).
- ◆ A panel that will contain an *Events List* at the bottom

Each of the components is explained in the sections that follow.

The Menu Bar

The Menu bar consists of four items:

- ◆ Configure
- ◆ Events
- ◆ Options
- ◆ Help

These are discussed in the sections that follow.

Note: If the Menu Bar appears to be disabled, click in the CN8600 List window to enable it.

Configure

The Configure menu contains three items: Add, Edit, and Delete. They are used to add new CN8600 units to the CN8600 List, edit the information for units already on the list, or delete CN8600 units from the list.

- ◆ To add a CN8600 to the CN8600 List, click **Add**.
- ◆ To edit or delete a listed CN8600, first select the one you want in the CN8600 List window, then open this menu and click **Edit** or **Delete**.

When you choose *Add* or *Edit*, a dialog box, similar to the one below appears:

A description of the fields is given in the table, below:

Field	Explanation
Address	This can either be the IP address of the CN8600 or its DNS name (if the network administrator has assigned it a DNS name). Key in the value specified for the CN8600 in the ANMS settings (see ANMS, page 33).
Port	Key in the port number that was specified for the Log Server's <i>Service Port</i> in the ANMS settings (see <i>Log Server</i> , page 35).
Description	This field is provided so that you can put in a descriptive reference for the unit to help identify it.
Limit	This specifies the number of days that an event should be kept in the Log Server's database before it expires and it is cleared out.
Enable automatic export for every (*) Days	Check this to have the server create a log file at specific intervals (in Days), and save it to your specified location. Click the Browse... button and navigate to the file folder where you want the log file to be stored.

Fill in or modify the fields, then click **OK** to finish.

Events

The Events Menu has two items: *Search* and *Maintenance*.

Search

Search allows you to search for events containing specific words or strings. When you access this function, a screen similar to the one below appears:

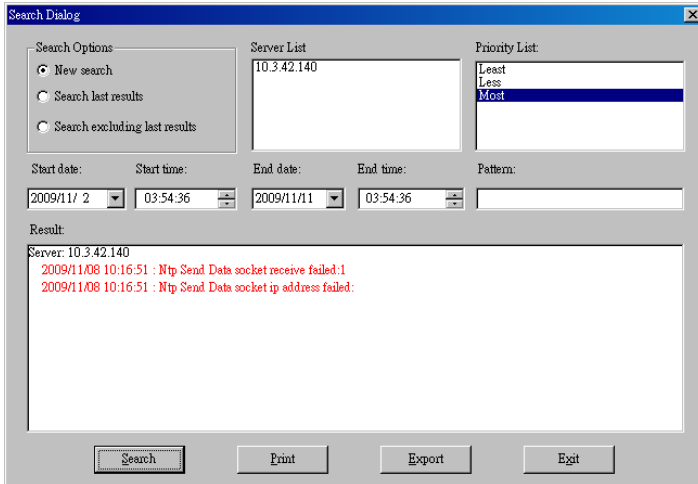

A description of the items is given in the table below:

Item	Explanation
New search	This is one of three radio buttons that define the scope of the search. If it is selected, the search is performed on all the events in the database for the selected CN8600.
Search last results	This is a secondary search performed on the events that resulted from the last search.
Search excluding last results	This is a secondary search performed on all the events in the database for the selected CN8600 <i>excluding</i> the events that resulted from the last search.
Server List	CN8600 units are listed according to their IP address. Select the unit that you want to perform the search on from this list. You can select more than one unit for the search. If no units are selected, the search is performed on all of them.
Priority List	Sets the level for how detailed the search results display should be. <i>Least</i> is the most general; <i>Most</i> is the most specific. Least results appear in black; Less results appear in blue; Most results appear in red.

Start Date	Select the date that you want the search to start from. The format follows the YYYY/MM/DD convention, as follows: 2009/11/04
Start Time	Select the time that you want the search to start from.
End Date	Select the date that you want the search to end at.
End Time	Select the time that you want the search to end at.
Pattern	Key in the pattern that you are searching for here. The multiple character wildcard (*) is supported. E.g., h*ds would match <i>hands</i> and <i>hoods</i> .
Results	Lists the events that contained matches for the search.
Search	Click this button to start the search.
Print	Click this button to print the search results.
Export	Click this button to write the search results to a .txt file.
Exit	Click this button to exit the Search dialog box.

Maintenance

This function allows the administrator to perform manual maintenance of the database, such as erasing specified records before the expiration time that was set with the *Limit* setting of the Edit function (see page 117).

Options

Network Retry allows you to set the number of seconds that the Log Server should wait before attempting to connect if the previous attempt to connect failed. When you click this item, a dialog box, similar to the one below appears:

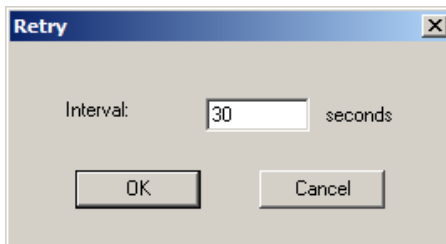

Key in the number of seconds, then click **OK** to finish.

Help

From the Help Menu, click Contents to access the online Windows Help file. The help file contains instructions about how to setup, operation and troubleshoot the Log Server.

The Log Server Main Screen

Overview

The Log Server Main Screen is divided into two main panels.

- ◆ The upper (List) panel lists the CN8600 units that have been selected for the Log Server to track (see *Configure*, page 117).
- ◆ The lower (Event) panel displays the log events for the currently selected CN8600 (the highlighted one - if there are more than one). To select a CN8600 unit in the list, simply click on it.

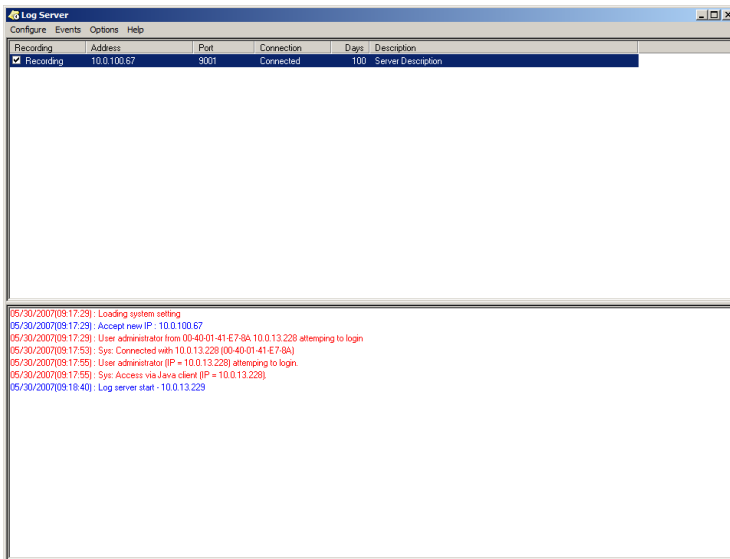

The List Panel

The List panel contains six fields:

Field	Explanation
Recording	Determines whether the Log Server records log events for this CN8600 or not. If the Recording check box is checked, the field displays <i>Recording</i> , and log events are recorded. If the Recording check box is not checked, the field displays <i>Paused</i> , and log events are not recorded. Note: Even though a CN8600 is not the currently selected one, if its Recording check box is checked, the Log Server will still record its log events.
Address	This is the IP Address or DNS name that was given to the CN8600 when it was added to the Log Server (see <i>Configure</i> , page 117).
Port	This is the port number that was assigned to the CN8600 when it was added to the Log Server (see <i>Configure</i> , page 117).
Connection	If the Log Server is connected to the CN8600, this field displays <i>Connected</i> . If it is not connected, this field displays <i>Waiting</i> . This means that the Log Server's MAC address and/or port number has not been set properly. It needs to be set in the ANMS settings (see page 33) and specified in the <i>Configure</i> dialog box (see <i>Configure</i> , page 117).
Days	This field displays the number of days that the CN8600's log events are to be kept in the Log Server's database before expiration (see <i>Configure</i> , page 117).
Description	This field displays the descriptive information given for the CN8600 when it was added to the Log Server (see <i>Configure</i> , page 117).

The Tick Panel

The lower panel displays tick information for the currently selected CN8600. Note that if the installation contains more than one switch, even though a switch is not currently selected, if its *Recording* checkbox is checked, the Log Server records its tick information and keeps it in its database.

This Page Intentionally Left Blank

Safety Instructions

General

- ◆ This product is for indoor use only.
- ◆ Read all of these instructions. Save them for future reference.
- ◆ Follow all warnings and instructions marked on the device.
- ◆ Do not place the device on any unstable surface (cart, stand, table, etc.). If the device falls, serious damage will result.
- ◆ Do not use the device near water.
- ◆ Do not place the device near, or over, radiators or heat registers.
- ◆ The device cabinet is provided with slots and openings to allow for adequate ventilation. To ensure reliable operation, and to protect against overheating, these openings must never be blocked or covered.
- ◆ The device should never be placed on a soft surface (bed, sofa, rug, etc.) as this will block its ventilation openings. Likewise, the device should not be placed in a built in enclosure unless adequate ventilation has been provided.
- ◆ Never spill liquid of any kind on the device.
- ◆ Unplug the device from the wall outlet before cleaning. Do not use liquid or aerosol cleaners. Use a damp cloth for cleaning.
- ◆ The device should be operated from the type of power source indicated on the marking label. If you are not sure of the type of power available, consult your dealer or local power company.
- ◆ To prevent damage to your installation it is important that all devices are properly grounded.
- ◆ Do not allow anything to rest on the power cord or cables. Route the power cord and cables so that they cannot be stepped on or tripped over.
- ◆ Position system cables and power cables carefully; Be sure that nothing rests on any cables.
- ◆ When connecting or disconnecting power to hot-pluggable power supplies, observe the following guidelines:
 - ◆ Install the power supply before connecting the power cable to the power supply.
 - ◆ Unplug the power cable before removing the power supply.

- ◆ If the system has multiple sources of power, disconnect power from the system by unplugging all power cables from the power supplies.
- ◆ Never push objects of any kind into or through cabinet slots. They may touch dangerous voltage points or short out parts resulting in a risk of fire or electrical shock.
- ◆ Do not attempt to service the device yourself. Refer all servicing to qualified service personnel.
- ◆ If the following conditions occur, unplug the device from the wall outlet and bring it to qualified service personnel for repair.
 - ◆ The power cord or plug has become damaged or frayed.
 - ◆ Liquid has been spilled into the device.
 - ◆ The device has been exposed to rain or water.
 - ◆ The device has been dropped, or the cabinet has been damaged.
 - ◆ The device exhibits a distinct change in performance, indicating a need for service.
 - ◆ The device does not operate normally when the operating instructions are followed.
- ◆ Only adjust those controls that are covered in the operating instructions. Improper adjustment of other controls may result in damage that will require extensive work by a qualified technician to repair.
- ◆ The socket-outlet shall be installed near the equipment and shall be easily accessible.
- ◆ Inlet power cord selection: Detachable, maximum 2.0 m long, 18 AWG, flexible cord (125V, 10A, 3C, NEMA 5-15P). Or, 0.75mm², 3G, flexible cord (E.g.: H05VV-F, 250V 10A).

Rack Mounting

- ◆ Before working on the rack, make sure that the stabilizers are secured to the rack, extended to the floor, and that the full weight of the rack rests on the floor. Install front and side stabilizers on a single rack or front stabilizers for joined multiple racks before working on the rack.
- ◆ Always load the rack from the bottom up, and load the heaviest item in the rack first.
- ◆ Make sure that the rack is level and stable before extending a device from the rack.
- ◆ Use caution when pressing the device rail release latches and sliding a device into or out of a rack; the slide rails can pinch your fingers.
- ◆ After a device is inserted into the rack, carefully extend the rail into a locking position, and then slide the device into the rack.
- ◆ Do not overload the AC supply branch circuit that provides power to the rack. The total rack load should not exceed 80 percent of the branch circuit rating.
- ◆ Make sure that all equipment used on the rack – including power strips and other electrical connectors – is properly grounded.
- ◆ Ensure that proper airflow is provided to devices in the rack.
- ◆ Ensure that the operating ambient temperature of the rack environment does not exceed the maximum ambient temperature specified for the equipment by the manufacturer
- ◆ Do not step on or stand on any device when servicing other devices in a rack.

Technical Support

International

- ◆ For online technical support – including troubleshooting, documentation, and software updates: **<http://eservice.aten.com>**
- ◆ For telephone support, see *Telephone Support*, page v.

North America

Email Support		support@aten-usa.com
Online Technical Support	Troubleshooting Documentation Software Updates	http://eservice.aten.com
Telephone Support		1-888-999-ATEN ext 4988 1-949-428-1111

When you contact us, please have the following information ready beforehand:

- ◆ Product model number, serial number, and date of purchase.
- ◆ Your computer configuration, including operating system, revision level, expansion cards, and software.
- ◆ Any error messages displayed at the time the error occurred.
- ◆ The sequence of operations that led up to the error.
- ◆ Any other information you feel may be of help.

IP Address Determination

If you are an administrator logging in for the first time, you need to access the CN8600 in order to give it an IP address that users can connect to. There are several methods to choose from. In each case, your computer must be on the same network segment as the CN8600. After you have connected and logged in you can give the CN8600 its fixed network address. (See *Network*, page 29.)

Local IP Setup

Use the local console to set the IP address. All procedures start from the OSD Main Screen.

1. To display the Main Screen, tap [Scroll Lock] twice.

Note: [Scroll Lock] is the default OSD hotkey. You can optionally change the Hotkey to the Ctrl key.

The login screen appears:

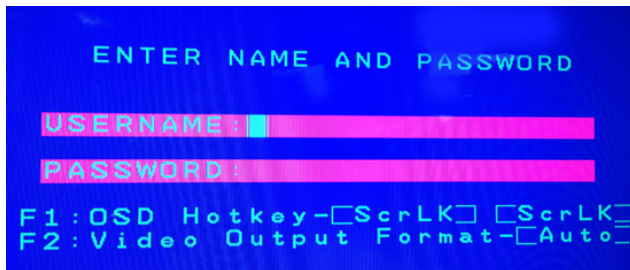

From this screen, you can select the following options:

- ◆ Press **F1** to change the hotkey for invoking the OSD screen. You can change the Hotkey to the Ctrl key instead of the Scroll lock key (shown as *ScrLK* in the screen).
 - ◆ Press **F2** to select the video output format for the remote display, which includes AUTO, DVI and HDMI.
2. Enter a valid **Username** and **Password** to continue.

The default username is *administrator*; the default password is *password*. The first time you log in, you must use these defaults. For security purposes, we strongly recommend that you change the default password to something unique.

- In the screen that appears, press **F1** to set the IP address. Proceed to step 4.



Press **F2** to enable the CN8600 to authenticate users. The CN8600 allows authentication and authorization through external programs. If the external programs fail to authenticate and you cannot log on to the device, use the local console to transfer authentication to the CN8600. The following message displays when the operation is successful.



See *Authentication*, page 36 for details.

Press the **Esc** key to exit the local console.

- When you invoke the OSD, a screen similar to the one below appears:

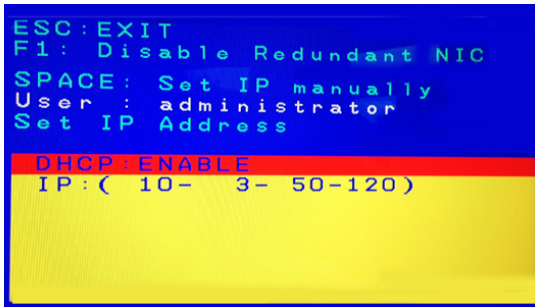

- To move up or down through the list one screen at a time, Click the Up and Down Arrow symbols (↑↓), or use the [Pg Up] and [Pg Dn] keys.
- To select or confirm a value, press the space bar [Space].
- To dismiss the menu, and deactivate OSD, press [Esc].

- From the list, select **DHCP: Enable** and hit the space bar to toggle enabling or disabling the DHCP server. It should change to **DHCP: Disable** with additional fields, as follows:

```

ESC:EXIT
SPACE:SELECT
ADMINISTRATOR
SET IP ADDRESS

DHCP:DISABLE
FIXED IP:
(192-168- 0- 60)
SUBNET MASK:
(255-255-255- 0)
DEFAULT GATEWAY:
(192-168- 0-254)

```

- For the fields **Fixed IP**, **Subnet Mask**, and **Default Gateway**, select each choice and enter the numerical address (dotted quad address).

```

ESC:EXIT
SPACE:SELECT
ADMINISTRATOR
SET IP ADDRESS

DHCP:DISABLE
FIXED IP:
(172- 17- 17- 15)
SUBNET MASK:
(255-255-255- 0)
DEFAULT GATEWAY:
(172- 17- 17-254)

SAVE AND RESET? Y/N?(Y)

```

- Go to **Save and Reset** and enter **Y** to confirm the new IP address.

IP Installer

For computers running Windows, an IP address can be assigned with the IP Installer utility:

- On the Software CD that came with your CN8600 package, go to the directory that the IP Installer program resides in, and run *IPInstaller.exe*. A dialog box similar to the one below appears:

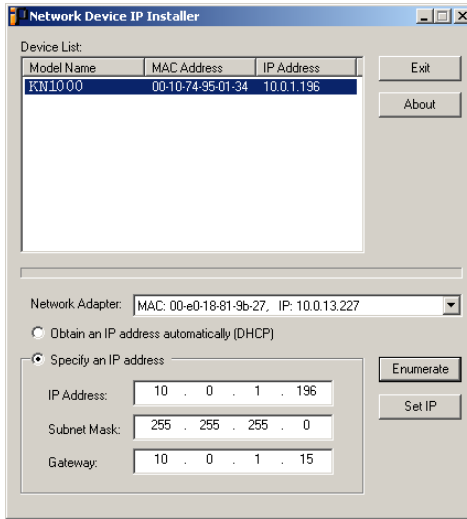

2. Select the CN8600 in the *Device List*.

Note: 1. If the list is empty, or your device doesn't appear, click **Enumerate** to refresh the Device List.

2. If there is more than one device in the list, use the MAC address to pick the one you want. The CN8600's MAC address is located on its bottom panel.

-
3. Select either *Obtain an IP address automatically (DHCP)*, or *Specify an IP address*. If you chose the latter, fill the IP Address, Subnet Mask, and Gateway fields with the information appropriate to your network.
 4. Click **Set IP**.
 5. After the IP address shows up in the Device List, click **Exit**.

Browser

1. Set your computer's IP address to 192.168.0.XXX
Where XXX represents any number or numbers except 60. (192.168.0.60 is the default address of the CN8600.)
2. Specify the switch's default IP address (192.168.0.60) in your browser, and you will be able to connect.

3. Assign a fixed IP address for the CN8600 that is suitable for the network segment that it resides on.
4. After you log out, reset your computer's IP address to its original value.

AP Windows Client

For computers running Windows, the CN8600's IP address can be determined with the Windows AP program (see *The Windows Client AP*, page 91). When you run the program it searches the network segment for CN8600 devices, and displays the results in a dialog box similar to the one below:

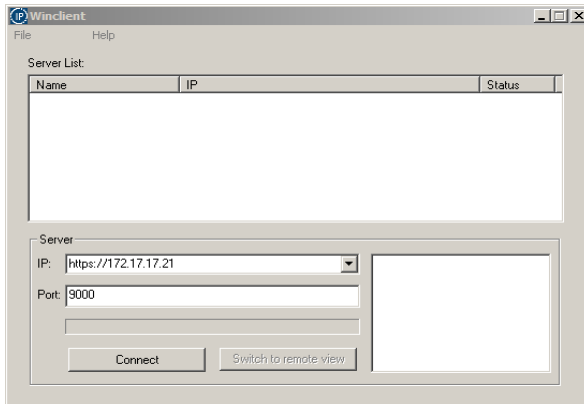

You can now use this network address, or you can change it by clicking **Login**, logging in, clicking **Remote View**, and clicking the **Device Management** tab. See page 30 for details, for details.

IPv6

At present, the CN8600 supports two IPv6 address protocols: *Link Local IPv6 Address*, and *IPv6 Stateless Autoconfiguration*

Link Local IPv6 Address

At power on, the CN8600 is automatically configured with a Link Local IPv6 Address (for example, fe80::210:74ff:fe61:1ef). To find out what the Link Local IPv6 Address is, log in with the CN8600's IPv4 address and click the *Basic Setting* icon. The address is displayed at the bottom of the *Basic Setting* page (see page 20).

Once you have determined what the IPv6 address is, you can use it when logging in from a browser or the Win and Java Client AP programs.

For example:

If you are logging in from a browser, you would key in

```
http://[fe80::2001:74ff:fe6e:59%5]
```

for the URL bar.

If you are logging in with the AP program, you would key:

```
fe80::2001:74ff:fe6e:59%5
```

for the *IP* field of the *Server* panel (see *The Windows Client Connection Screen*, page 92).

-
- Note:**
1. To log in with the Link Local IPv6 Address, the client computer must be on the same local network segment as the CN8600
 2. The %5 is the %interface used by the client computer. To see your client computer's IPv6 address: from the command line issue the following command: `ipconfig /all`. The % value appears at the end of the IPv6 address.
-

IPv6 Stateless Autoconfiguration

If the CN8600's network environment contains a device (such as a router) that supports the IPv6 Stateless Autoconfiguration function, the CN8600 can obtain its prefix information from that device in order to generate its IPv6 address. For example, 2001::74ff:fe6e:59.

As above, the address is displayed at the bottom of the *Basic Setting* page.

Once you have determined what the IPv6 address is, you can use it when logging in from a browser or the Win and Java Client AP programs.

For example:

If you are logging in from a browser, you would key in

```
http://[2001::74ff:fe6e:59]
```

for the URL bar.

If you are logging in with the AP program, you would key:

```
2001::74ff:fe6e:59
```

for the *IP* field of the *Server* panel (see *The Windows Client Connection Screen*, page 92).

Port Forwarding















For devices located behind a router, port forwarding allows the router to pass data coming in over a specific port to a specific device. By setting the port forwarding parameters, you tell the router which device to send the data coming in over a particular port to.

For example, if the CN8600 connected to a particular router has an IP address of 192.168.1.180, you would log into your router's setup program and access the Port Forwarding (sometimes referred to as *Virtual Server*) configuration page. You would then specify 192.168.1.180 for the IP address and the port number you want opened for it (9000 for internet access, for example).

Since configuration setup can vary somewhat for each brand of router, refer to the router's User Manual for specific information on configuring port forwarding for it.

Keyboard Emulation

The PC compatible (101/104 key) keyboard can emulate the functions of the Sun and Mac keyboards. The emulation mappings are listed in the table below.

PC Keyboard	Sun Keyboard	PC Keyboard	Mac Keyboard
[Ctrl] [T]	Stop	[Shift]	Shift
[Ctrl] [F2]	Again	[Ctrl]	Ctrl
[Ctrl] [F3]	Props		
[Ctrl] [F4]	Undo	[Ctrl] [1]	
[Ctrl] [F5]	Front	[Ctrl] [2]	
[Ctrl] [F6]	Copy	[Ctrl] [3]	
[Ctrl] [F7]	Open	[Ctrl] [4]	
[Ctrl] [F8]	Paste	[Alt]	Alt
[Ctrl] [F9]	Find	[Print Screen]	F13
[Ctrl] [F10]	Cut	[Scroll Lock]	F14
[Ctrl] [1]			=
[Ctrl] [2]		[Enter]	Return
[Ctrl] [3]		[Backspace]	Delete
[Ctrl] [4]		[Insert]	Help
[Ctrl] [H]	Help	[Ctrl] 	F15
	Compose		
			

Note: When using key combinations, press and release the first key (Ctrl), then press and release the activation key.

Serial Port Pin Assignment

Pin assignment for the serial port is given in the table below:

Pin	Assignment
1	RTS
2	DTR
3	TXD
4	CTS
5	GND
6	RXD
7	DCD
8	DSR

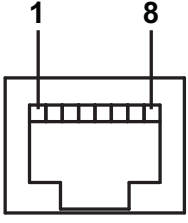

The diagram shows a top-down view of an RJ-45 female connector. It features a rectangular housing with a central opening. Eight pins are visible along the top edge of the opening. Two vertical lines extend upwards from the first and eighth pins, labeled with the numbers '1' and '8' respectively. Below the diagram, the text 'RJ-45 Female' is printed.

Trusted Certificates

Overview

When you try to log in to the device from your browser, a Security Alert message appears to inform you that the device's certificate is not trusted, and asks if you want to proceed.

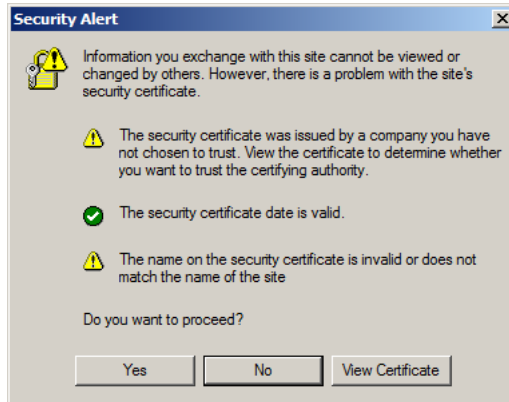

The certificate can be trusted, but the alert is triggered because the certificate's name is not found on Microsoft's list of Trusted Authorities. You have two options: 1) you can ignore the warning and click **Yes** to go on; or 2) you can install the certificate and have it be recognized as trusted.

- ◆ If you are working on a computer at another location, accept the certificate for just this session by clicking **Yes**.
- ◆ If you are working at your own computer, install the certificate on your computer (see below for details). After the certificate is installed, it will be recognized as trusted.

Installing the Certificate

To install the certificate, do the following:

3. In the *Security Alert* dialog box, click **View Certificate**. The *Certificate Information* dialog box appears:

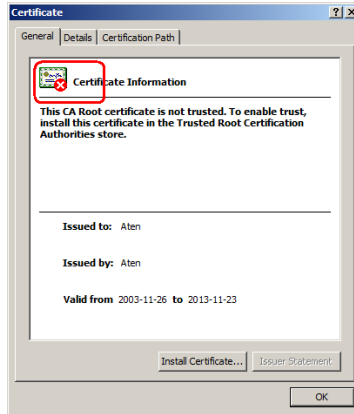

Note: There is a red and white X logo over the certificate to indicate that it is not trusted.

4. Click **Install Certificate**.
5. Follow the Installation Wizard to complete the installation. Unless you have a specific reason to choose otherwise, accept the default options.
6. When the Wizard presents a caution screen:

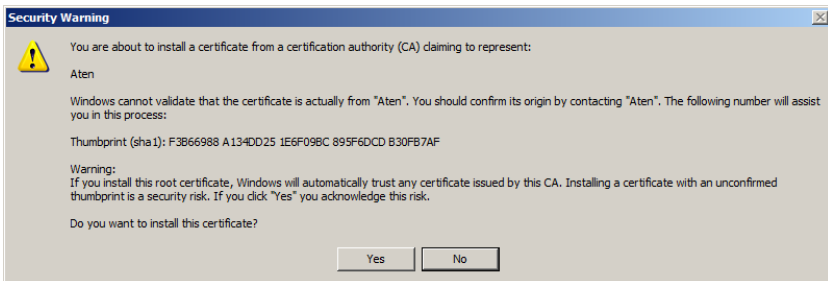

Click **Yes**.

- Next, click **Finish** to complete the installation; then click **OK** to close the dialog box.

Certificate Trusted

The certificate is now trusted:

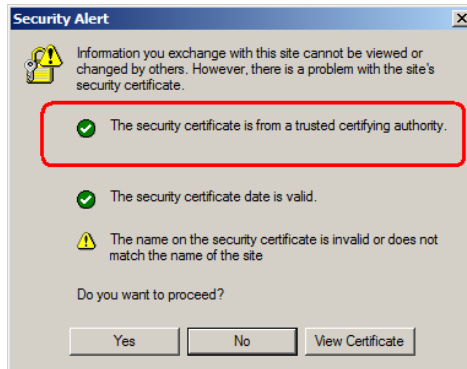

When you click *View Certificate*, you can see that the red and white X logo is no longer present – further indication that the certificate is trusted:

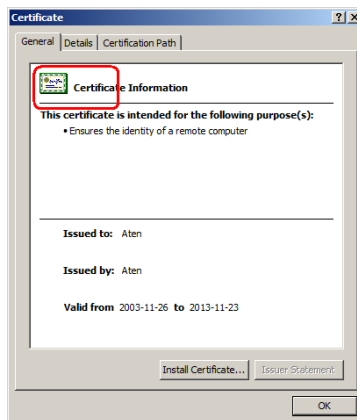

Mismatch Considerations

If the site name or IP address used for generating the certificate no longer matches the current address of the CN8600 a mismatch warning occurs:

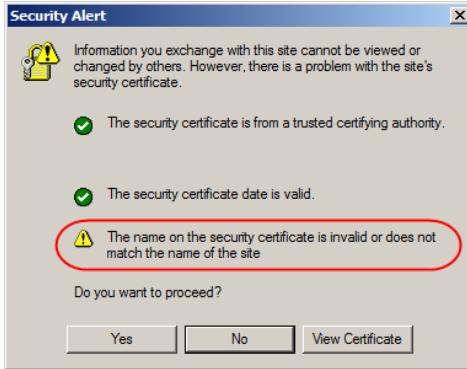

You can click **Yes** to go on, or you can disable mismatch checking.

To disable mismatch checking, do the following:

1. After the page you are logging in to comes up open the browser's Tools menu; Select *Internet Options* → *Advanced*.
2. Scroll to the bottom of the list and uncheck *Warn about trusted certificates*:

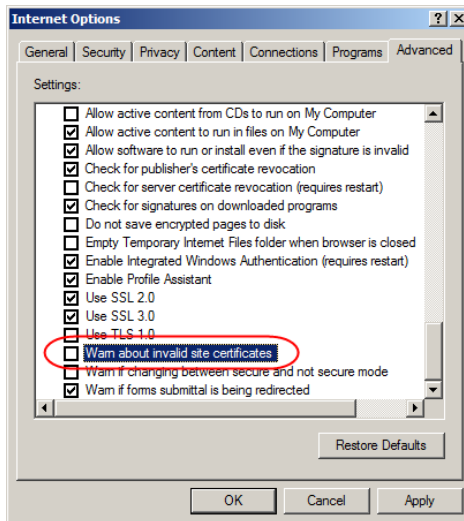

3. Click **OK**. The next time you run the browser the change will be in effect.

Self-Signed Private Certificates

If you wish to create your own self-signed encryption key and certificate, a free utility – `openssl.exe` – is available for download over the web at www.openssl.org. To create your private key and certificate do the following:

1. Go to the directory where you downloaded and extracted `openssl.exe` to.
2. Run `openssl.exe` with the following parameters:

```
openssl req -new -newkey rsa:1024 -days 3653 -nodes -x509  
-keyout CA.key -out CA.cer -config openssl.cnf
```

Note: 1. The command should be entered all on one line (i.e., do not press [Enter] until all the parameters have been keyed in).

2. If there are spaces in the input, surround the entry in quotes (e.g., “ATEN International”).
-

To avoid having to input information during key generation the following additional parameters can be used:

```
/C /ST /L /O /OU /CN /emailAddress.
```

Examples

```
openssl req -new -newkey rsa:1024 -days 3653 -nodes -x509  
-keyout CA.key -out CA.cer -config openssl.cnf -subj  
/C=yourcountry/ST=yourstateorprovince/L=yourlocationor  
city/O=yourorganization/OU=yourorganizationalunit/  
CN=yourcommonname/emailAddress=name@yourcompany.com
```

```
openssl req -new -newkey rsa:1024 -days 3653 -nodes -x509  
-keyout CA.key -out CA.cer -config openssl.cnf -subj  
/C=CA/ST=BC/L=Richmond/O="ATEN International"/OU=ATEN  
/CN=ATEN/emailAddress=eservice@aten.com.tw
```

Importing the Files

After the `openssl.exe` program completes, two files – `CA.key` (the private key) and `CA.cer` (the self-signed SSL certificate) – are created in the directory that you ran the program from. These are the files that you upload in the *Private Certificate* panel of the Security page (see page 45).

Troubleshooting

General Operation

Problem	Resolution
Erratic operation	<p>The CN8600 needs to be started before the KVM switch</p> <ol style="list-style-type: none"> 1. If the CN8600 is connected to a KVM switch, make sure to power it on before powering on the switch. 2. If the KVM switch was started before the CN8600, reset or restart the KVM switch. <p>The CN8600 needs to be reset (see <i>Upgrade Main Firmware</i>, page 23, point 1).</p>
I can't access the CN8600, even though I have specified the IP address and port number correctly.	If the CN8600 is behind a router, the router's <i>Port Forwarding</i> (also referred to as <i>Virtual Server</i>) feature must be configured. See <i>Port Forwarding</i> , page 134, for details.
Mouse pointer confusion	If you find the display of two mouse pointers (local and remote) to be confusing or annoying, you can use the <i>Toggle Mouse Display</i> function to shrink the non-functioning pointer. See page 67 for details.
Mouse movement extremely slow	There is too much data being transferred for your connection to keep up with. Lower the video quality (see <i>Video Settings</i> , page 75) so that less video data is transmitted.
Changing Mouse Sync Mode to Manual makes the CN8600 crash.	The CN8600 has not crashed. You can wait approximately 5 minutes for normal operations to resume, or you can reset the CN8600 to get it going right away (see <i>Upgrade Main Firmware</i> , page 23, point 1).
When I am in a web browser session, and making configuration changes, and I am timed out, the settings changes I have made are lost.	If you do not click Apply , the CN8600 is not aware that you are working, and times you out. Without clicking Apply , none of your changes are recognized. You must click Apply as you go along in order to have the settings saved on the CN8600 and reset the timeout counter.
The Windows Client link does not appear in the <i>Remote Console Display</i> when I log in with Firefox.	The Windows Client link requires ActiveX. Since Firefox does not support ActiveX only the Java Applet is available.
When the remote server is running Fedora the mouse pointer on the remote server does not move, whether I am accessing it from the local console or a local client computer.	If the remote server is connected with a PS/2 cable, log into the CN8600 with a browser; open a viewer; on the control panel set <i>Mouse DynaSync</i> to Manual . See page 85 for details.

Problem	Resolution
My ATEN over IP unit is not listed in the Device List of IP Installer.	<ul style="list-style-type: none">◆ Make sure the Broadcast function is enabled from your switch or router in order for the auto-discover to work properly.◆ Make sure to turn off your firewall and/or antivirus software temporarily in order for the audio-discover to work properly.◆ Make sure the ATEN over IP unit and the PC are under the same network segment.

Windows

Problem	Resolution
When I log in, the browser generates a <i>CA Root certificate is not trusted</i> , or a <i>Certificate Error</i> response.	<ol style="list-style-type: none"> <li data-bbox="366 193 938 272">1. The certificate's name is not found on Microsoft's list of Trusted Authorities. The certificate can be trusted. See <i>Trusted Certificates</i>, page 137, for details. <li data-bbox="366 272 938 395">2. You can eliminate this message by importing a certificate issued by a recognized third party certificate authority (see <i>Obtaining a CA Signed SSL Server Certificate</i>, page 45).
After I import the site's certificate, I still get a message warning me about the site when I log in.	Certificate security checking noticed a certificate address mismatch – however the certificate can be trusted. You can click <i>Continue to the website (not recommended)</i> to go on, or you can disable mismatch checking. See <i>Mismatch Considerations</i> , page 140 for a complete explanation of this topic.
Remote mouse pointer is out of step.	<ol style="list-style-type: none"> <li data-bbox="366 552 938 663">1. Check the status of the <i>Mouse DynaSync Mode</i> setting (see <i>Mouse DynaSync Mode</i>, page 85). If it is set to <i>Automatic</i>, change the setting to <i>Manual</i> and refer to the information provided. <li data-bbox="366 663 938 751">2. If you are in Manual mode, use the <i>AutoSync</i> feature (see <i>Video Settings</i>, page 75), to sync the local and remote monitors. <li data-bbox="366 751 938 839">3. If that does not resolve the problem, use the <i>Adjust Mouse</i> feature (see <i>Adjust mouse</i>, page 67) to bring the pointers back in step. <li data-bbox="366 839 938 932">4. If the above fails to resolve the problem, refer to <i>Additional Mouse Synchronization Procedures</i>, page 148, for further steps to take.
Part of remote window is off my monitor.	Use the <i>AutoSync</i> feature (see <i>Video Settings</i> , page 75), to sync the local and remote monitors.
Virtual media does not work.	This problem sometimes arises on older computers. Get the latest firmware version for your mainboard from the manufacturer and upgrade your mainboard firmware.
Under virtual media, I can mount an ISO file, but I cannot access it.	Virtual media under the WindowsClient only supports ISO files less than 4G.Bytes. If the ISO file is 4GBytes or greater it cannot be accessed.
My anti-virus program reports that there is a Trojan after I access the CN8600 with my browser and then open the Windows Client Viewer.	The Windows Client Viewer uses an ActiveX plugin (windows.ocx) that some antivirus programs mistakenly see as a virus or trojan. We have tested our firmware extensively and found no evidence of a virus or trojan. You can add the plugin to your antivirus program's White List and use the Viewer safely. If you are reluctant to use the Windows Client Viewer, however, you can simply use the Java Client Viewer, instead.

Java

For mouse synchronization problems, see *Macros*, page 100, *Mouse DynaSync Mode*, page 107, and *Sun / Linux*, page 149. For other problems, see the table below:

Problem	Resolution
Java Applet won't connect to the CN8600	<ol style="list-style-type: none"> 1. Java 6 Update 3 or higher must be installed on your computer. 2. Make sure to include the correct login string when you specify the CN8600's IP address. 3. Close the Java Applet, reopen it, and try again.
I have installed the latest Java JRE, but I am having performance and stability problems.	There may be issues with the latest version because it is so new. Try using a Java version that is one or two updates earlier than the latest one.
Java Applet performance deteriorates.	Exit the program and start again.
National language characters don't appear.	Use the CN8600's <i>On-Screen Keyboard</i> and be sure that the local and remote computers are set to the same language. (See <i>The On-Screen Keyboard</i> , page 106.)
When I log in, the browser generates a <i>CA Root certificate is not trusted</i> , or a <i>Certificate Error</i> response.	The certificate's name is not found on Microsoft's list of Trusted Authorities. The certificate can be trusted. See <i>Trusted Certificates</i> , page 137, for details.
There is no virtual media icon on my Control Panel.	The virtual media function only supports the Windows Client programs.

Sun Systems

Problem	Resolution
Video display problems with HDB15 interface systems (e.g., Sun Blade 1000 servers). ¹	<p>The display resolution should be set to 1024 x 768:</p> <p>Under Text Mode:</p> <ol style="list-style-type: none"> Go to OK mode and issue the following commands: <pre>setenv output-device screen:r1024x768x60</pre> <pre>reset-all</pre> <p>Under XWindow:</p> <ol style="list-style-type: none"> Open a console and issue the following command: <pre>m64config -res 1024x768x60</pre> Log out Log in
Video display problems with 13W3 interface systems (e.g., Sun Ultra servers).*	<p>The display resolution should be set to 1024 x 768:</p> <p>Under Text Mode:</p> <ol style="list-style-type: none"> Go to OK mode and issue the following commands: <pre>setenv output-device screen:r1024x768x60</pre> <pre>reset-all</pre> <p>Under XWindow:</p> <ol style="list-style-type: none"> Open a console and issue the following command: <pre>m64config -res 1024x768x60</pre> Log out Log in
The local and remote mouse pointers do not sync	<p>The default configuration is for the local and remote mouse pointers to automatically sync when you connect. Automatic mouse sync only supports USB mice on Windows and Mac (G4 or higher) systems, however. You must select <i>Manual</i> as the <i>Mouse DynaSync Mode</i> choice, and sync the pointers manually. See <i>Mouse DynaSync Mode</i>, page 85 for further details.</p>

* These solutions work for most common Sun VGA cards. If using them fails to resolve the problem, consult the Sun VGA card's manual.

Mac Systems

Problem	Resolution
The local and remote mouse pointers do not sync.	There are two USB I/O settings for the Mac: Mac 1, and Mac 2 (see <i>Customization</i> , page 54). In general, Mac 1 works with older operating system versions, whereas Mac 2 works with the newer ones. In some cases, however, the reverse is true. If you experience pointer sync problems, try selecting the other mode.
When I log in to the switch with my Safari browser, it hangs when I use the Snapshot feature.	Force close Safari, then reopen it. Don't use the Snapshot feature in the future.
	To use the Snapshot feature with Safari, upgrade to Mac OS 10.4.11 and Safari 3.0.4.

The Log Server

Problem	Resolution
The Log Server program does not run.	<p>The Log Server requires the Microsoft Jet OLEDB 4.0 driver in order to access the database.</p> <p>This driver is automatically installed with Windows ME, 2000 and XP.</p> <p>For Windows 98 or NT, you will have to go to the Microsoft download site:</p> <p style="padding-left: 40px;">http://www.microsoft.com/data/download.htm</p> <p>to retrieve the driver file:</p> <p style="padding-left: 40px;">MDAC 2.7 RTM Refresh (2.70.9001.0)</p> <p>Since this driver is used in Windows Office Suite, an alternate method of obtaining it is to install Windows Office Suite. Once the driver file or Suite has been installed, the Log Server will run.</p>

Additional Mouse Synchronization Procedures

If the mouse synchronization procedures mentioned in the manual fail to resolve mouse pointer problems for particular computers, try the following:

Windows:

Note: In order for the local and remote mice to synchronize, you must use the generic mouse driver supplied with the MS operating system. If you have a third party driver installed - such as one supplied by the mouse manufacturer - you must remove it.

1. Windows 2000:

- a) Open the Mouse Properties dialog box (Control Panel → Mouse → Mouse Properties)
- b) Click the *Motion* tab
- c) Set the mouse speed to the middle position (6 units in from the left)
- d) Set the mouse acceleration to *None*

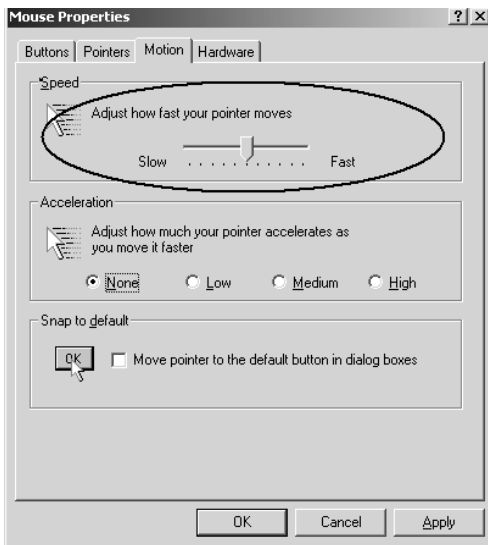

2. Windows XP / Windows Server 2003:

- a) Open the Mouse Properties dialog box (Control Panel → Mouse)

- b) Click the *Pointer Options* tab
- c) Set the mouse speed to the middle position (6 units in from the left)
- d) Disable *Enhance Pointer Precision*

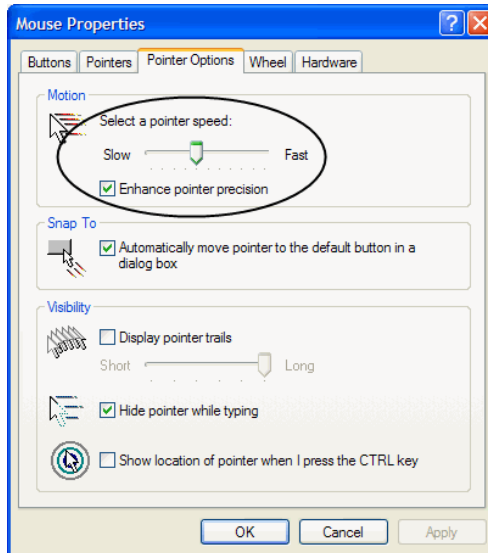

3. Windows ME:

Set the mouse speed to the middle position; disable mouse acceleration (click **Advanced** to get the dialog box for this).

4. Windows NT / Windows 98 / Windows 95:

Set the mouse speed to the slowest position.

Sun / Linux

Open a terminal session and issue the following command:

```
Sun: xset m 1
```

```
Linux: xset m 0
```

or

```
xset m 1
```

(If one does not help, try the other.)

Virtual Media Support

WinClient ActiveX Viewer / WinClient AP

- ◆ IDE CDROM/DVD-ROM Drives – Read Only
- ◆ IDE Hard Drives – Read Only
- ◆ USB CDROM/DVD-ROM Drives – Read Only
- ◆ USB Hard Drives – Read/Write*
- ◆ USB Flash Drives – Read/Write*
- ◆ USB Floppy Drives – Read/Write

* These drives can be mounted either as Drives or Removable Disks (see *Virtual Media*, page 80). Mounting them as removable disks allow booting the remote server if the disk contains a bootable OS. In addition, if the disk contains more than one partition, the remote server can access all the partitions.

- ◆ ISO Files – Read Only
- ◆ Folders – Read/Write
- ◆ Smart Card Readers

Java Applet Viewer / Java Client AP

- ◆ ISO Files – Read Only
- ◆ Folders – Read/Write

Note: 1. The Java Client supports virtual media in the same way as WinClient does – however, the account should have Administrator level privilege.

2. Folder mapping uses a FAT16 file system, so there is a 2G limitation. Virtual media only supports ISO files less than 4G.

Administrator Login Failure

If you are unable to perform an Administrator login (because the Username and Password information has become corrupted, or you have forgotten it, for example), there is a procedure you can use to clear the login information.

To clear the login information do the following:

1. Power off the CN8600, disconnect the power cord from its inlet, and remove its housing.
2. Use a jumper cap to short the jumper on the mainboard labeled **J15**.

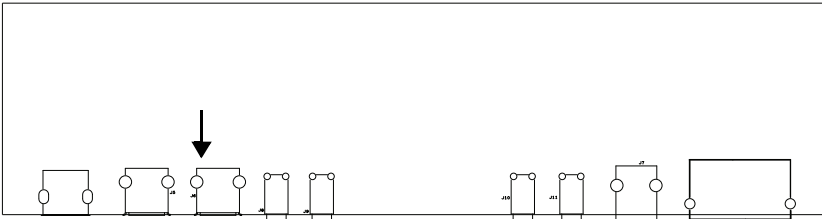

3. Power on the switch.
4. When the front panel LEDs flash, power off the switch.
5. Remove the jumper cap from **J15**.
6. Close the housing and power on the CN8600.

After you start back up, you can use the default Username and Password (see page 16, and page 93) to log in.

Specifications

Function		Specification		
Connectors	Console Ports	KB	1 x USB Type A Female (White)	
		Video	1 x DVI-D Female (White)	
		Mouse	1 x USB Type A Female (White)	
		Audio	Speaker	1 x Mini Stereo Jack Female (Green)
			Microphone	1 x Mini Stereo Jack Female (Pink)
	KVM Ports	KB/Mouse	1 x USB Type B Female (White)	
		Video	1 x DVI-D Female (White)	
		Audio	Speaker	1 x Mini Stereo Jack Female (Green)
			Microphone	1 x Mini Stereo Jack Female (Pink)
	LAN	2 x RJ-45 Female (Black)		
	Virtual Media / Laptop USB console	1 x USB Mini-B Female (Black)		
	Power	2 x DC Jack (Black)		
	PON	1 x RJ-45 Female (Black)		
	Serial Port	1 x RJ-45 Female (Black)		
Control Port	1 x PS2 port			
Switches	Reset	1 x Semi-recessed pushbutton (Black)		
	USB Function Selection	1 x Slide Switch (Black)		
	Console Lock	1 x Slide Switch (Black)		
	Power	1 (Green)		
LEDs	Console Status	1 (Green)		
	LAN 10/100/1000 Mbps	Orange: 10 Mbps Orange + Green: 100 Mbps Green: 1000 Mbps		
	Remote Login	1 (Green)		
Emulation	Keyboard/Mouse	USB		
Video		Local Console: 1920 x 1200 @ 60 Hz RB Remote: 1920 x 1200 @ 60 Hz RB		
Power Consumption		DC5.3V, 6W		
Environment	Operating Temp.	0–50° C		
	Storage Temp.	-20–60° C		
	Humidity	0–80% RH Non-condensing		
Physical Properties	Housing	Metal		
	Weight	0.88 kg		
	Dimensions (L x W x H)	26.00 x 7.64 x 4.20 cm		

Limited Warranty

ATEN warrants its hardware in the country of purchase against flaws in materials and workmanship for a Warranty Period of two [2] years (warranty period may vary in certain regions/countries) commencing on the date of original purchase. This warranty period includes the [LCD panel of ATEN LCD KVM switches](#). Select products are warranted for an additional year (see [A+ Warranty](#) for further details). Cables and accessories are not covered by the Standard Warranty.

What is covered by the Limited Hardware Warranty

ATEN will provide a repair service, without charge, during the Warranty Period. If a product is defective, ATEN will, at its discretion, have the option to (1) repair said product with new or repaired components, or (2) replace the entire product with an identical product or with a similar product which fulfills the same function as the defective product. Replaced products assume the warranty of the original product for the remaining period or a period of 90 days, whichever is longer. When the products or components are replaced, the replacing articles shall become customer property and the replaced articles shall become the property of ATEN.

To learn more about our warranty policies, please visit our website:
<http://www.aten.com/global/en/legal/policies/warranty-policy/>

© Copyright 2021 ATEN® International Co., Ltd.
Released: 2021-05-05

ATEN and the ATEN logo are registered trademarks of ATEN International Co., Ltd. All rights reserved. All other brand names and trademarks are the registered property of their respective owners.