

34093/**/16



Gebruiksaanwijzing

Notice d'emploi

Benutzerhandbuch

User manual

Manual de usuario



PHILIPS

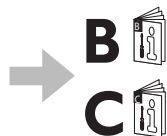
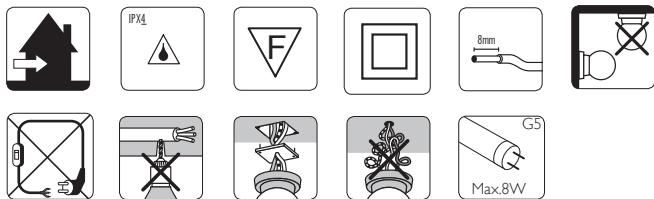
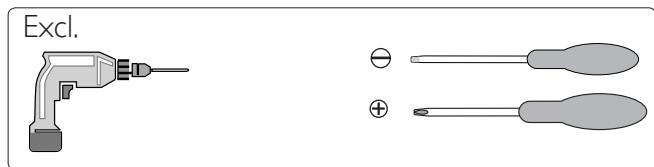
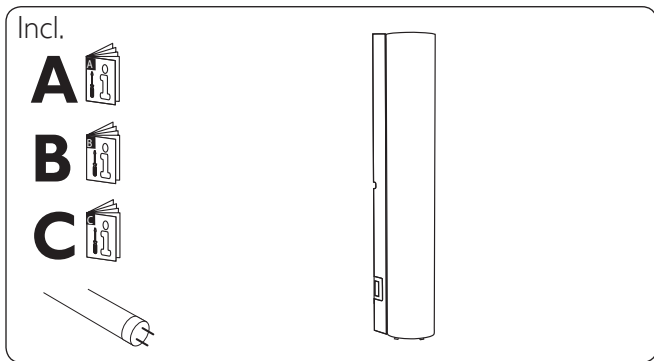

Type 1 p.4

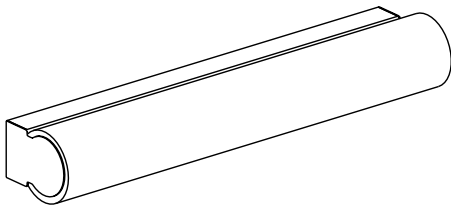

Type 2 p.6

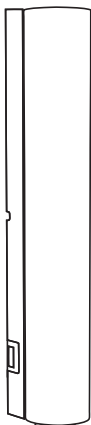
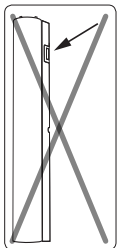

Type 1

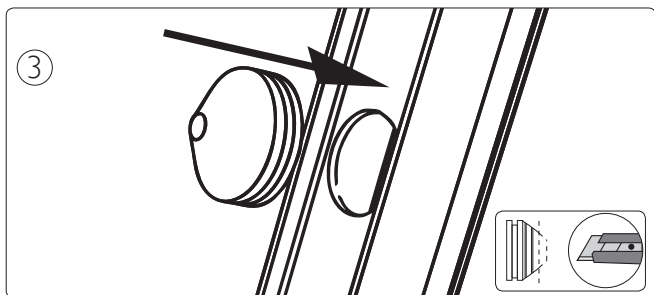
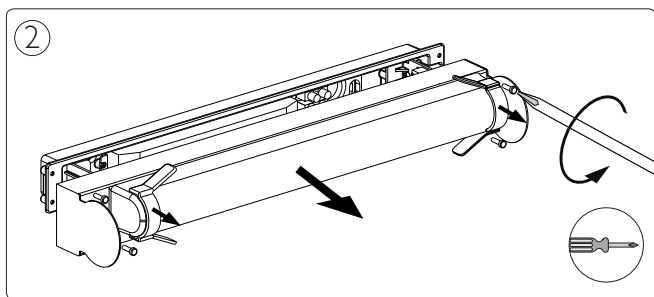
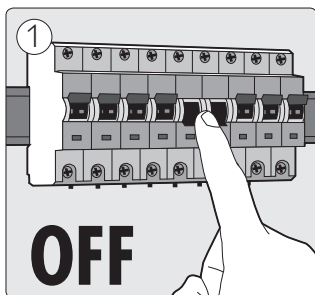
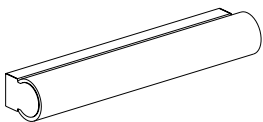

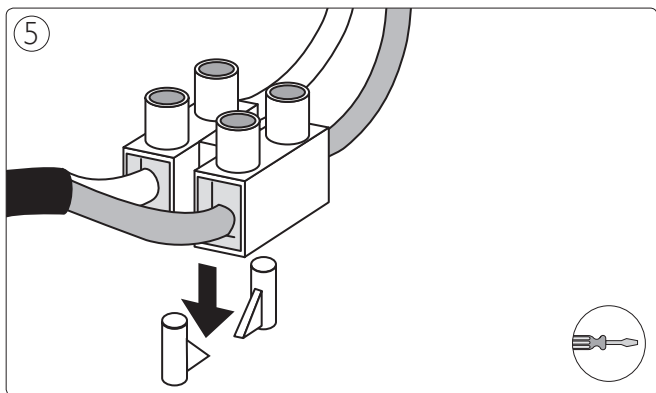
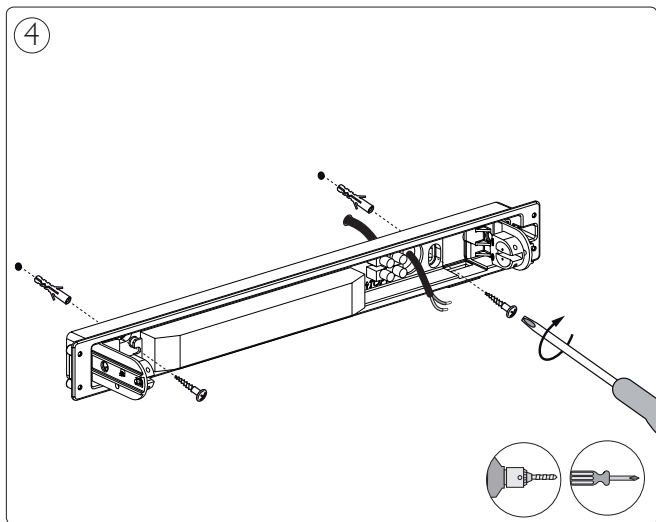

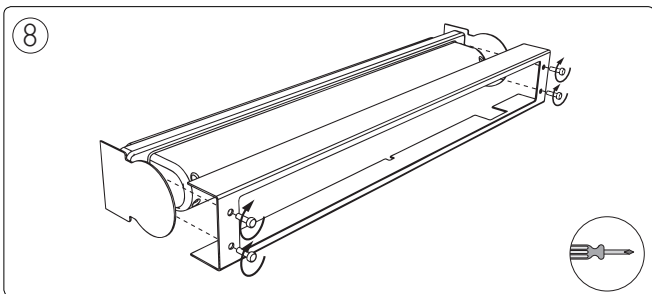
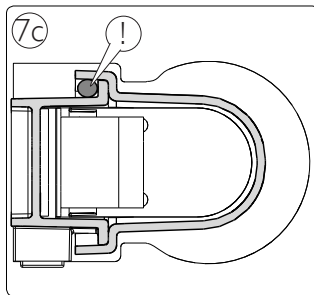
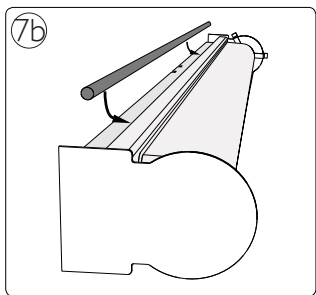
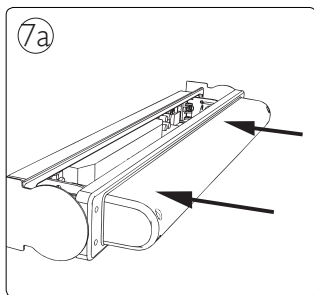
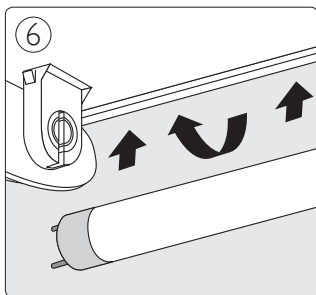

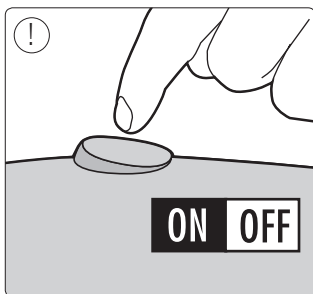
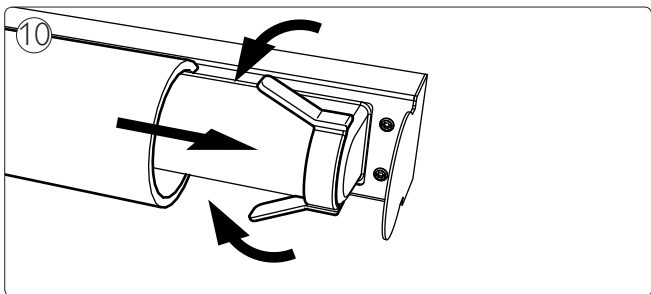
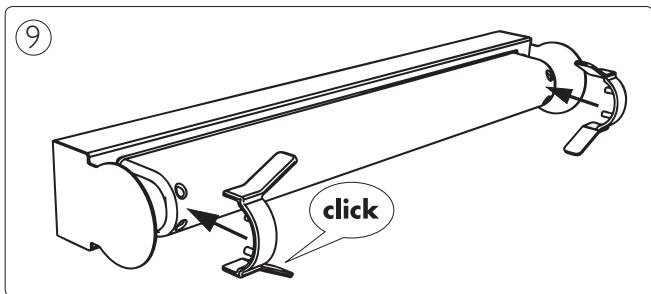

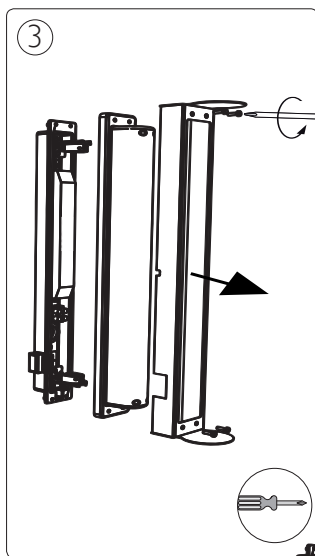
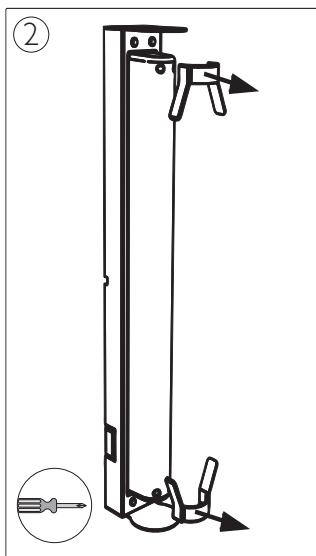
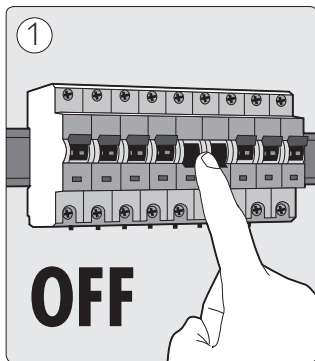
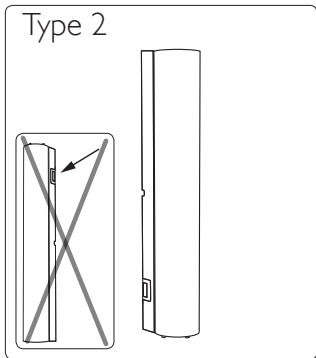

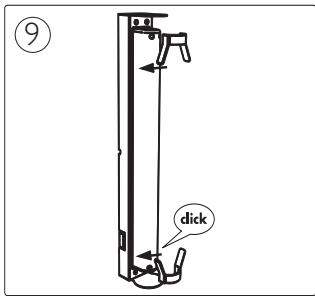
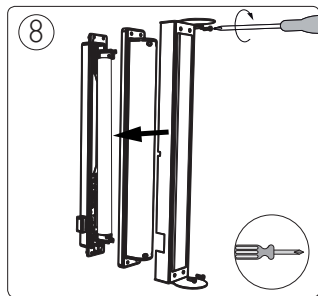
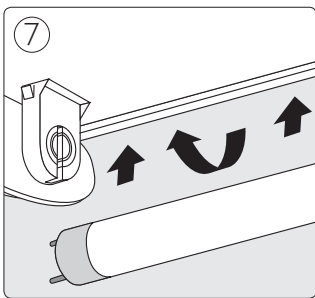
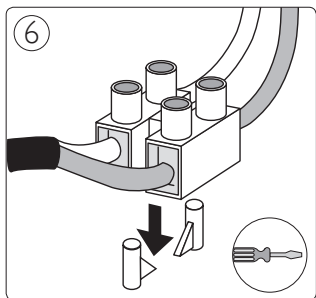
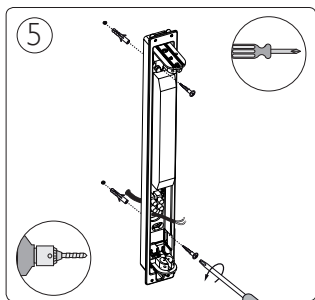
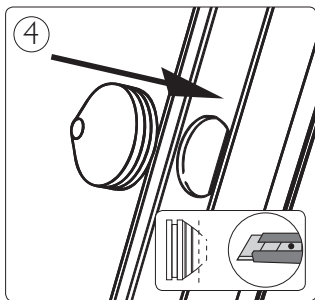

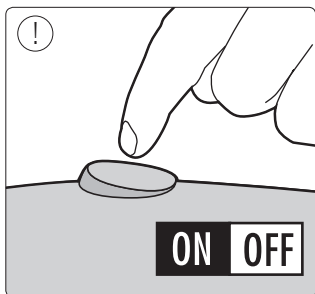
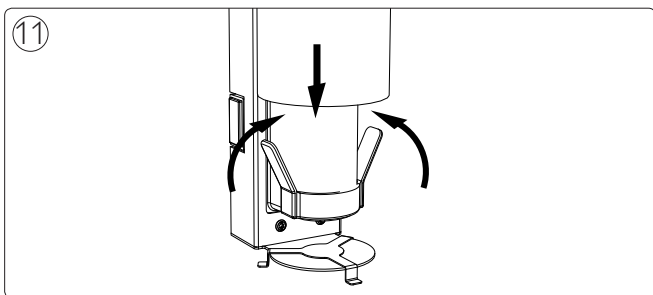
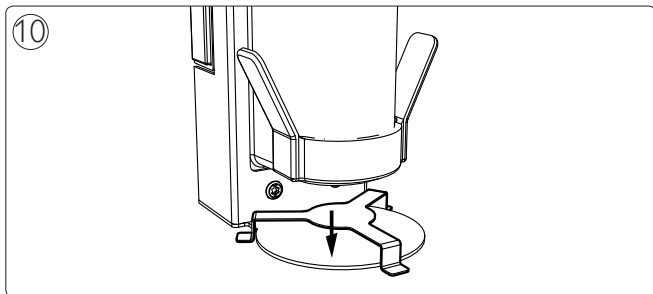



Philips Lighting Contact Centre
Int. Business Reply Service
I.B.R.S. / C.C.R.I. Numéro 10461
5600 VB Eindhoven
Pays-Bas / The Netherlands

www.philips.com/homelighting
 +800 7445 4775

4404.018.36631
Last update: 31/01/13