

Always there to help you

Register your product and get support at
www.philips.com/support



HTB4150B
HTB4152B



Quick start guide

PHILIPS

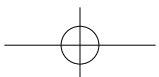

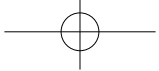

- EN** Before using your product, read all accompanying safety information
- CS** Před použitím produktu si přečtěte doprovodné bezpečnostní informace
- DA** Læs alle medfølgende sikkerhedsoplysninger, inden du tager produktet i brug
- DE** Lesen Sie vor Verwendung dieses Produkts alle begleitenden Sicherheitsinformationen
- EL** Πριν χρησιμοποιήσετε το προϊόν, διαβάστε όλες τις παρεχόμενες πληροφορίες ασφάλειας
- ES** Antes de usar el producto, lea toda la información de seguridad adjunta
- FI** Lue kaikki turvallisustiedot ennen tuotteen käyttöä
- FR** Avant d'utiliser votre produit, lisez l'intégralité des consignes de sécurité jointes
- HU** A termék használatá elótt alaposan olvassa el a mellékelt biztonsági tudnivalókat
- IT** Prima di utilizzare il prodotto, leggere tutte le relative

informazioni sulla sicurezza

- NL** Lees voordat u het product gaat gebruiken eerst alle bijbehorende veiligheidsinformatie
- NO** Lees voordat u het product gaat gebruiken eerst alle bijbehorende veiligheidsinformatie
- PL** Przed rozpoczęciem korzystania z produktu należy zapoznać się z informacjami dotyczącymi bezpieczeństwa
- PT** Antes de utilizar o produto, leia todas as informações de segurança que o acompanham
- RO** Înainte de a utiliza acest produs, citiți toate informațiile de siguranță care îl însoțesc
- SK** Pred použitím produktu si prečítajte všetky sprievodné bezpečnostné informácie maklumat keselamatan yang disertakan
- SV** Innan du använder produkten ska du läsa all tillhörande säkerhetsinformation
- TR** Ürününüzü kullanmadan önce ilgili tüm güvenlik bilgilerini okuyun

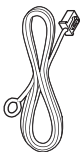
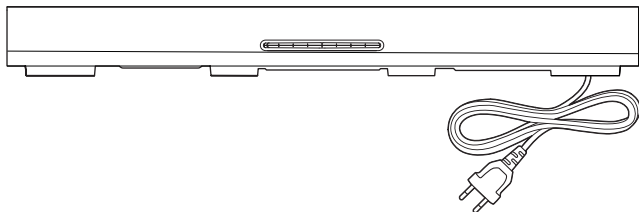
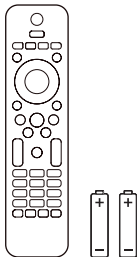

FM Antenna

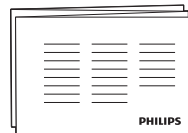
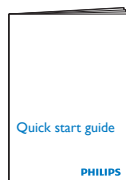
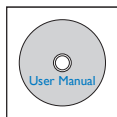

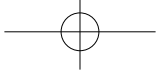

1

EN Position the Soundstage

CS Umístění zařízení Soundstage

DA Placer din Soundstage

DE Positionieren des Soundstages

EL Τοποθέτηση του Soundstage

ES Colocación del Soundstage

FI Soundstagein sijoittaminen

FR Placer la Soundstage

HU A Soundstage elhelyezése

IT Posizionamento della Soundstage

NL De Soundstage plaatsen

NO Plasser Soundstage

PL Ustawianie zestawu Soundstage

PT Posicionar o Soundstage

RO Poziționare Soundstage

SK Umiestnite zariadenie Soundstage

SV Placera Soundstage

TR Soundstage'ı yerleştirin

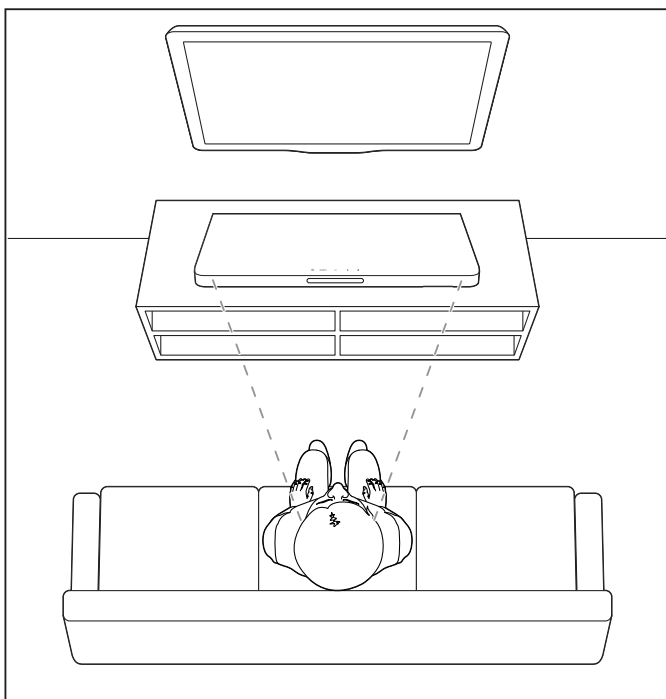

2

EN Connect to TV in one of these ways

CS Připojení k televizoru provedte jedním z následujících způsobů

DA Tilslut til TV på en af følgende måder

DE Herstellen einer Verbindung mit dem Fernseher über einer dieser Möglichkeiten

EL Συνδεθείτε στην τηλεόραση με έναν από τους παρακάτω τρόπους

ES Conexión al televisor de una de estas maneras

FI Liitä televisioon jommallakummalla tavalla

FR Connectez-vous au téléviseur via l'une de ces méthodes

HU Csatlakoztassa a tv-készülékhez az alábbi módok egyike szerint

IT Eseguì il collegamento al TV in uno dei modi indicati di seguito

NL Maak op een van de volgende manieren verbinding met de TV

NO Koble til TV'en på en av følgende måter

PL Podłącz do telewizora przy użyciu jednej z tych metod

PT Ligar ao televisor de uma destas formas

RO Conectați-vă la televizor într-unul din aceste moduri

SK Pripojte zariadenie k televizoru jedným z týchto spôsobov

SV Anslut till TV:n på något av följande sätt

TR Aşağıdaki yöntemlerden biriyle TV'ye bağlanın

HDMI ARC

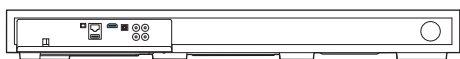

HDMI OUT (ARC)

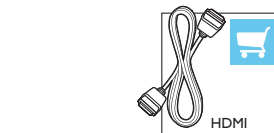

HDMI IN (ARC)

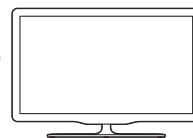

HDMI + OPTICAL



HDMI OUT



DIGITAL IN OPTICAL

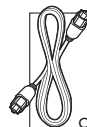
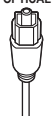

OPTICAL OUT



HDMI IN

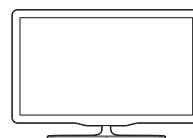

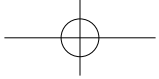

HDMI + COAXIAL

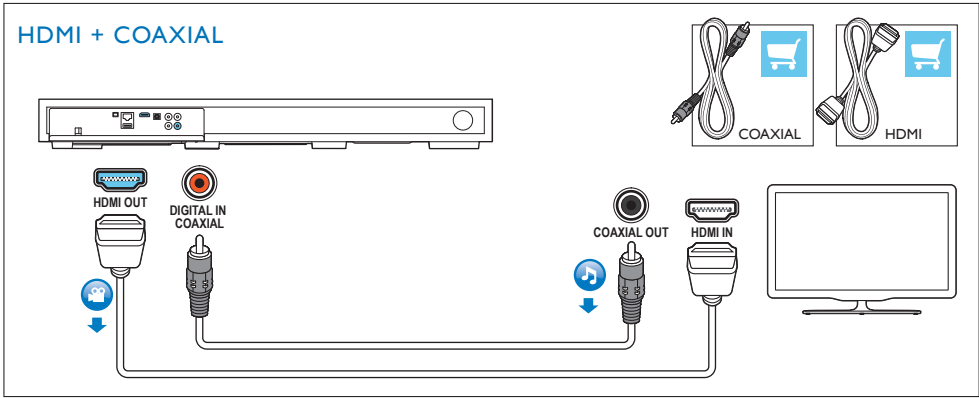

HDMI + AUX L/R

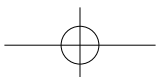
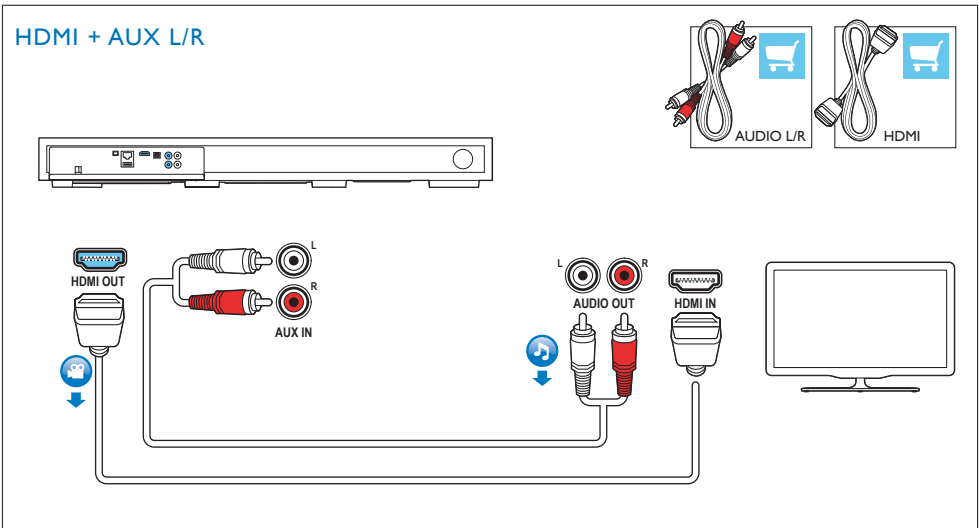

3

- EN** Switch on the Soundstage
CS Zapnutí zařízení Soundstage
DA Tænd for din Soundstage
DE Einschalten des Soundstages
EL Ένεργοποίηση του Soundstage
ES Encendido del Soundstage
FI Soundstagein käynnistäminen
FR Allumer la Soundstage
HU A Soundstage bekapcsolása
- IT** Accensione della Soundstage
NL De Soundstage inschakelen
NO Slå på Soundstage
PL Włączanie zestawu Soundstage
PT Ligar o Soundstage
RO Pornire Soundstage
SK Zapnite zariadenie Soundstage
SV Slå på Soundstage
TR Soundstage'ı açın

1

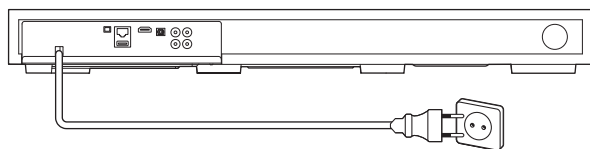

2

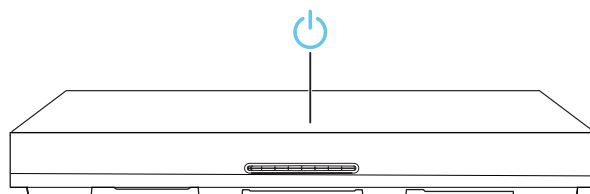

3

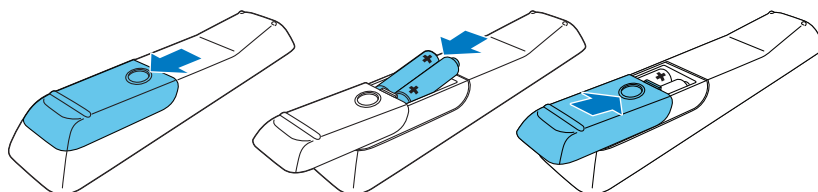

4

EN Complete the first time setup

CS Dokončili jste nastavení při prvním zapnutí

DA Fuldfør den indledende opsætning

DE Abschließen der Ersteinrichtung

EL Ολοκληρώστε τη ρύθμιση για πρώτη φορά

ES Finaliza la configuración inicial

FI Ensiasennuksen suorittaminen loppuun

FR Effectuer la configuration initiale

HU Az első üzembe helyezés

IT Completamento della configurazione iniziale

NL Volttoo! de eerste installatie

NO Fullfør den første konfigureringen

PL Pierwsza konfiguracja

PT Executar a configuração inicial

RO Realizați prima configurare

SK Dokončenie prvého nastavenia

SV Slutför förstagångsinställningen

TR İlk kullanım öncesi kurulumunu tamamlayın

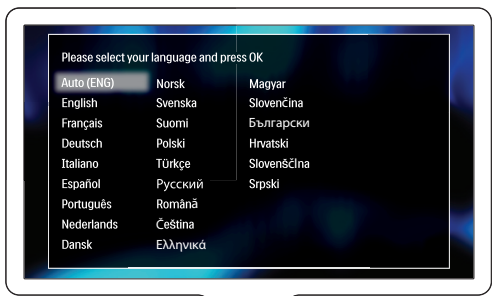
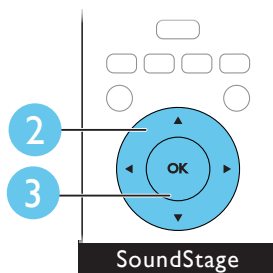
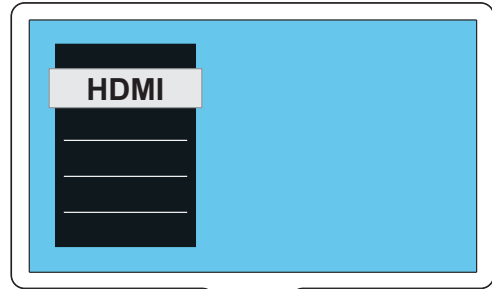
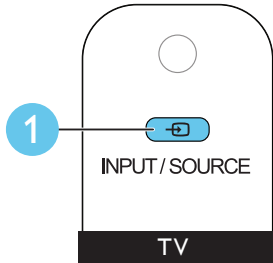

5

EN Use your SoundStage

CS Použití zařízení SoundStage

DA Brug din SoundStage

DE Verwenden des SoundStage

EL Χρήση του SoundStage

ES Utilización de SoundStage

FI SoundStagen käyttäminen

FR Utilisation de votre SoundStage

HU A SoundStage használat

IT Utilizzo di SoundStage

NL Het gebruik van uw SoundStage

NO Bruke SoundStage

PL Korzystanie z zestawu SoundStage

PT Utilizar o seu SoundStage

RO Utilizarea SoundStage

SK Používanie systému SoundStage

SV Använda SoundStage

TR SoundStage'inizi kullanma

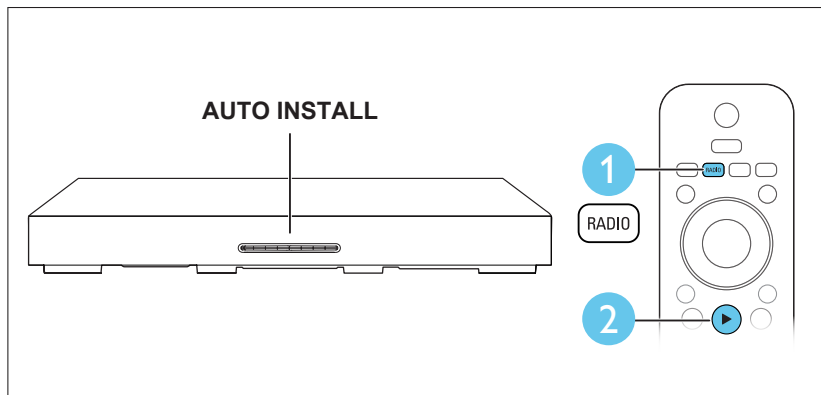
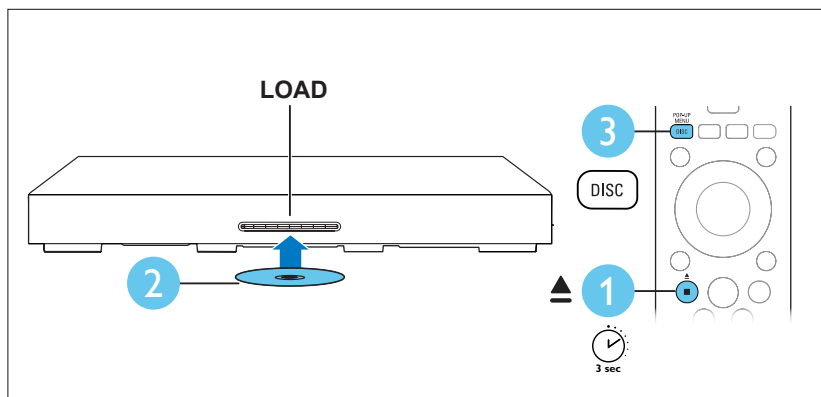

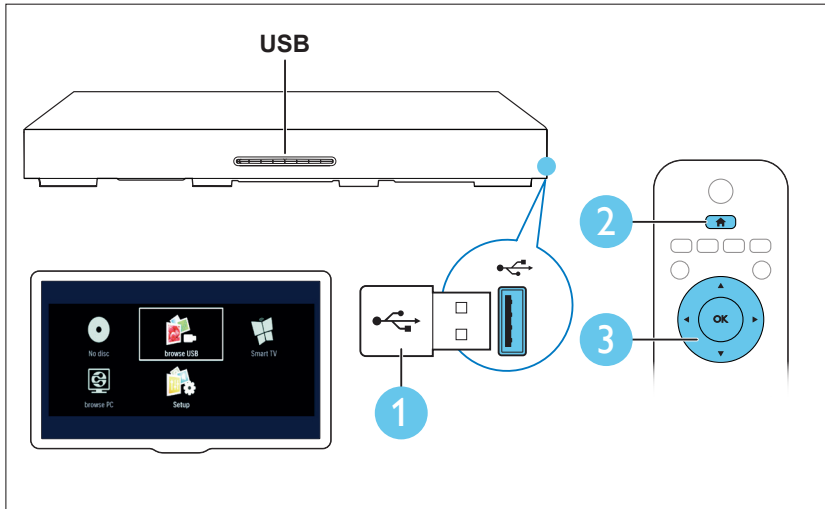
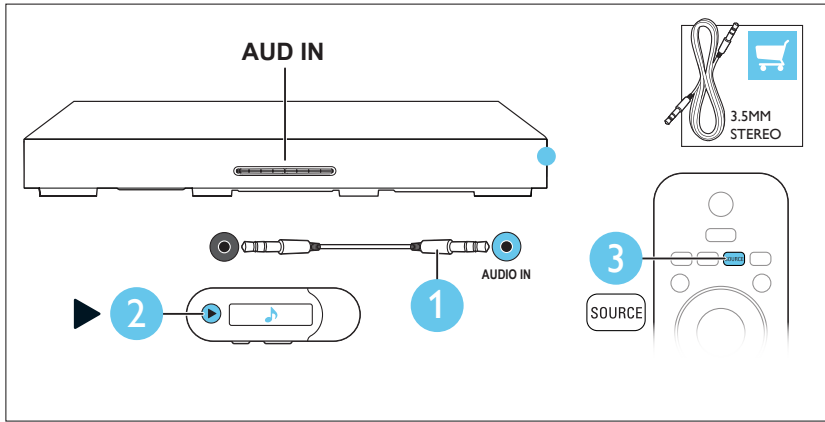
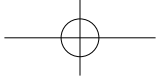

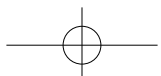
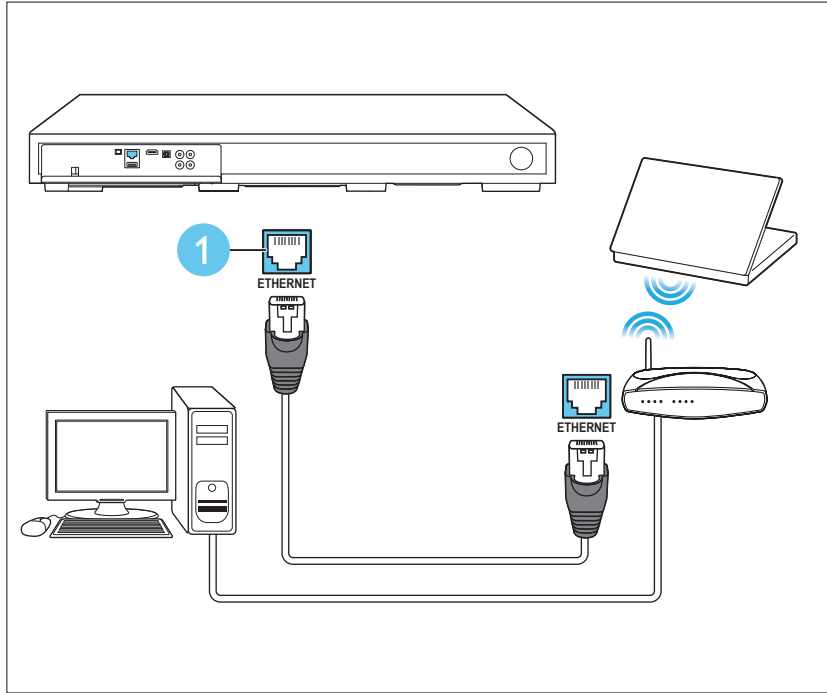
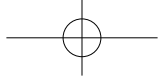

6

EN Play audio through Bluetooth (or NFC)

CS Přehrávání zvuku prostřednictvím rozhraní Bluetooth (nebo NFC)

DA Afspil lyd via Bluetooth (eller NFC)

DE Audiowiedergabe über Bluetooth (oder NFC)

EL Αναπαραγωγή ήχου μέσω Bluetooth (ή NFC)

ES Reproducción de audio a través de Bluetooth (o NFC)

FI Äänen toistaminen Bluetoothin kautta (tai NFC)

FR Lecture de musique via Bluetooth (ou NFC)

HU Játsszon le műsort más készülékről (vagy NFC)

IT Riproduzione di file audio tramite Bluetooth (o NFC)

NL Audio afspelen via Bluetooth (of NFC)

NO Spille av lyd via Bluetooth (eller NFC)

PL Odtwarzanie dźwięku przez połączenie Bluetooth (lub NFC)

PT Reproduzir noutros dispositivos (ou NFC)

RO Redați sunetul prin Bluetooth (sau NFC)

SK Prehrávanie zvukového obsahu cez rozhranie Bluetooth (alebo NFC)

SV Spela upp ljud via Bluetooth (eller NFC)

TR Bluetooth yoluyla müzik çalma (veya NFC)

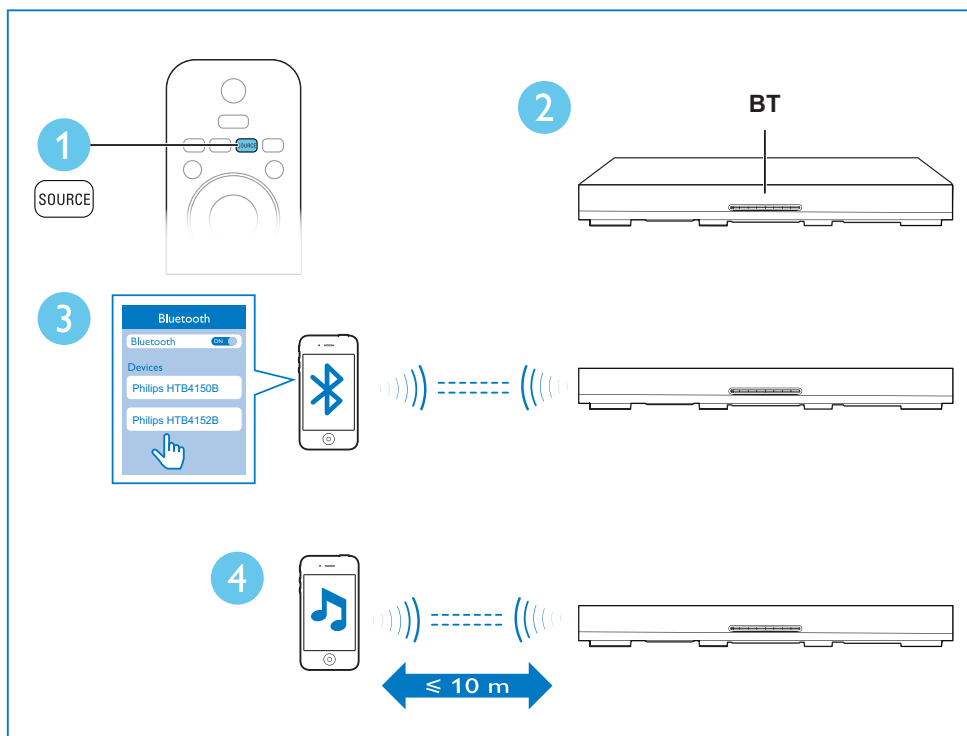

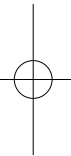
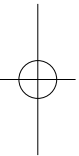
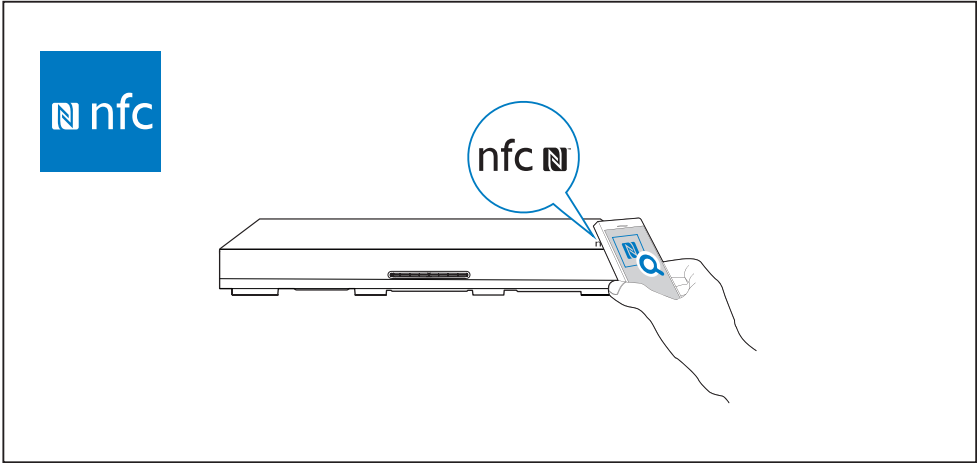
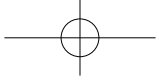

Specifications are subject to change without notice
© 2014 Koninklijke Philips N.V. All rights reserved.
Trademarks are the property of Koninklijke Philips N.V. or
their respective owners.

HTB4150B/HTB4152B_12_QSG_V3.0

 Be responsible
Respect copyrights

