

59701/**/16

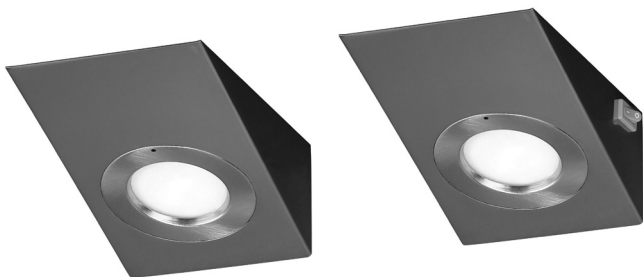

Gebruiksaanwijzing
Notice d'emploi
Benutzerhandbuch
User manual
Manual de usuario



PHILIPS

Incl.



2x 

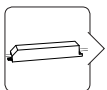
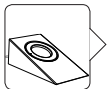
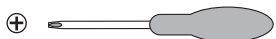
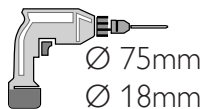
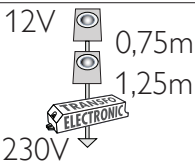
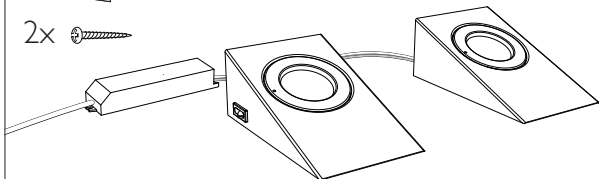

B



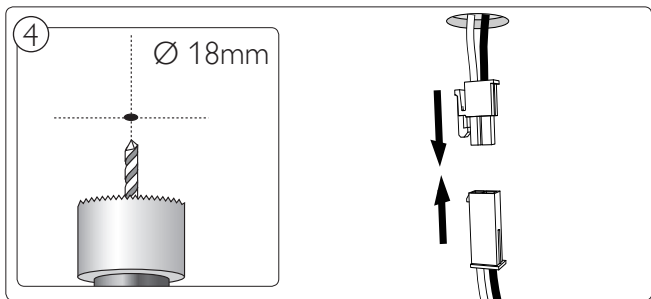
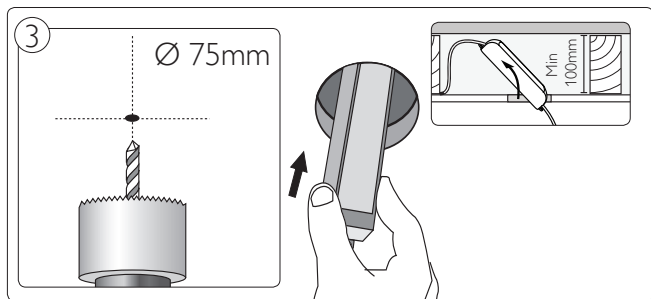
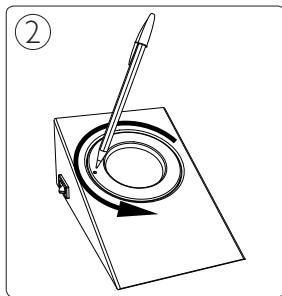
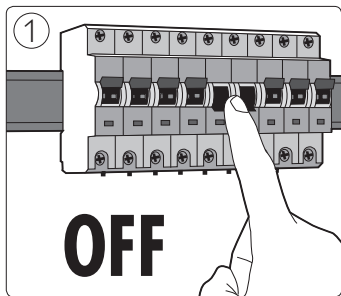

5

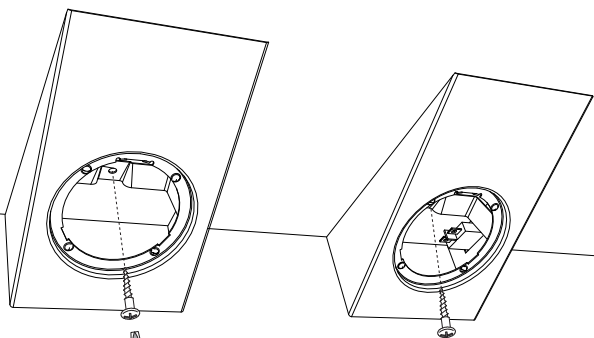

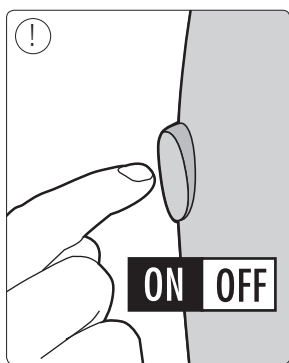
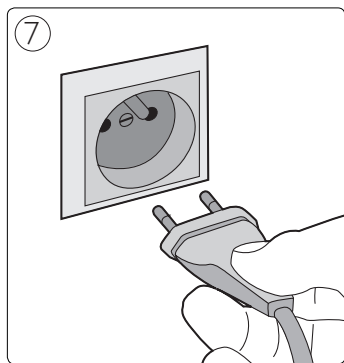
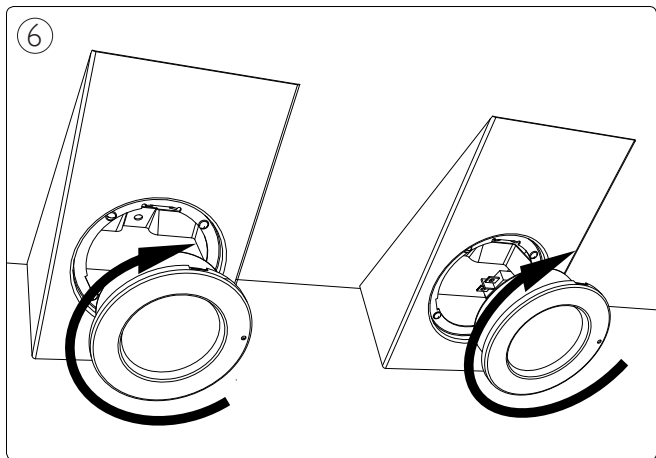

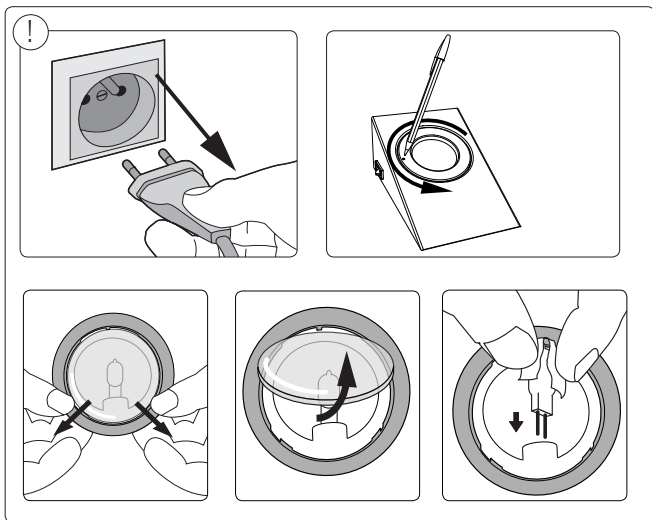



Philips Lighting Contact Centre
Int. Business Reply Service
I.B.R.S. / C.C.R.I. Numéro 10461
5600 VB Eindhoven
Pays-Bas / The Netherlands

www.philips.com/homelighting
☎ +800 7445 4775

4404.018.31871
Last update: 08/08/12