

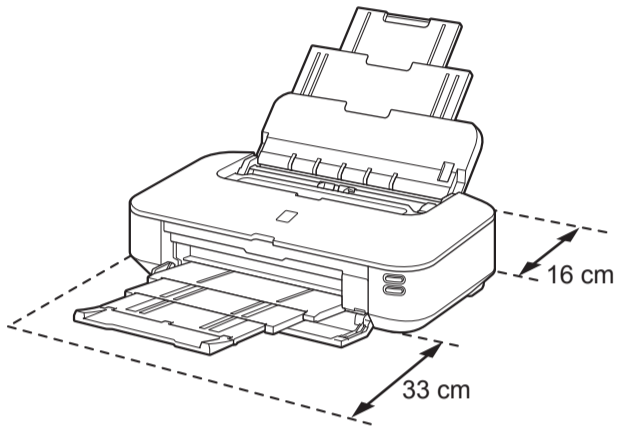

- ENGLISH
- FRANÇAIS
- DEUTSCH
- NEDERLANDS
- ITALIANO
- PORTUGUÊS
- ESPAÑOL
- ΕΛΛΗΝΙΚΗ

Canon PIXMA iX6800 series

Installation Space
Espace d'installation
Installationsplatz
Installatieruimte
Spazio di installazione
Espaço de Instalação
Espacio de instalación
Χώρος εγκατάστασης



1

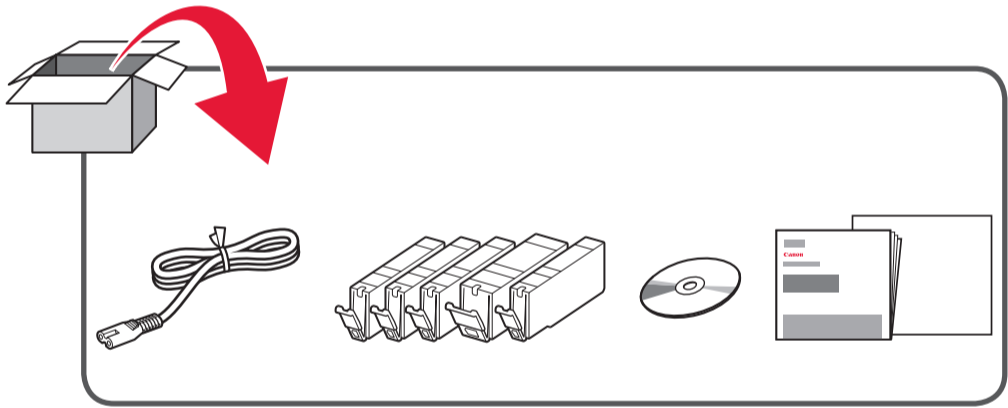

2

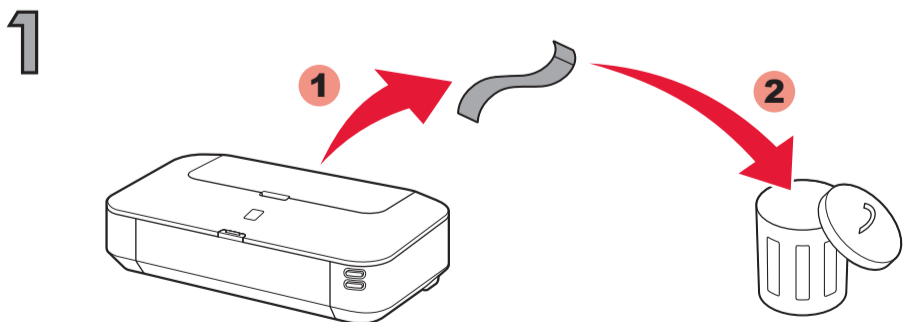

2

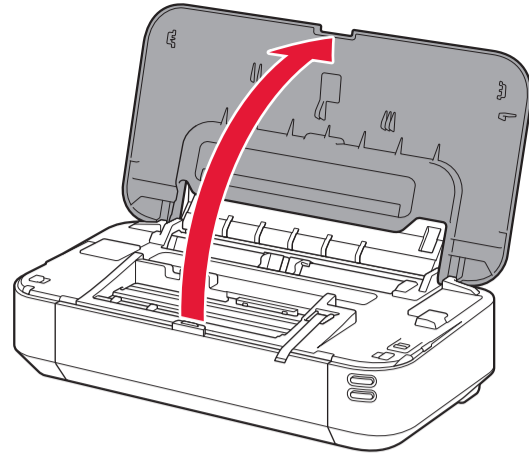

3

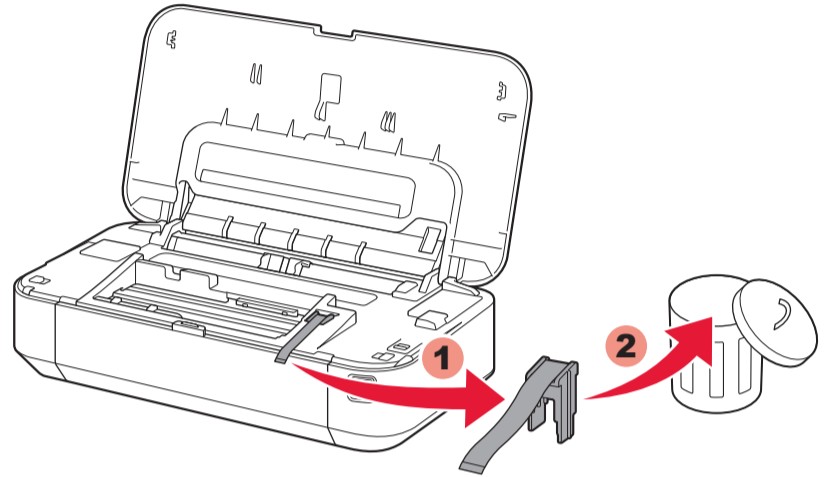

4

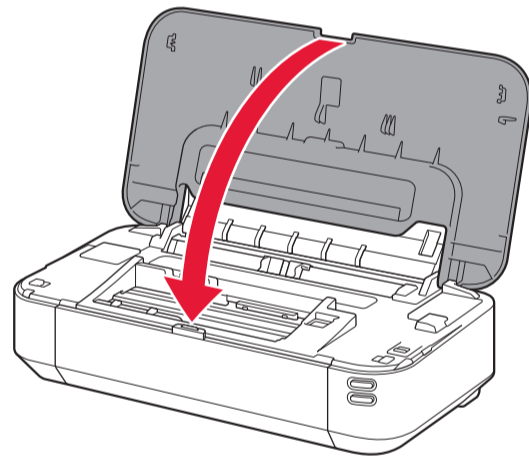

3

1

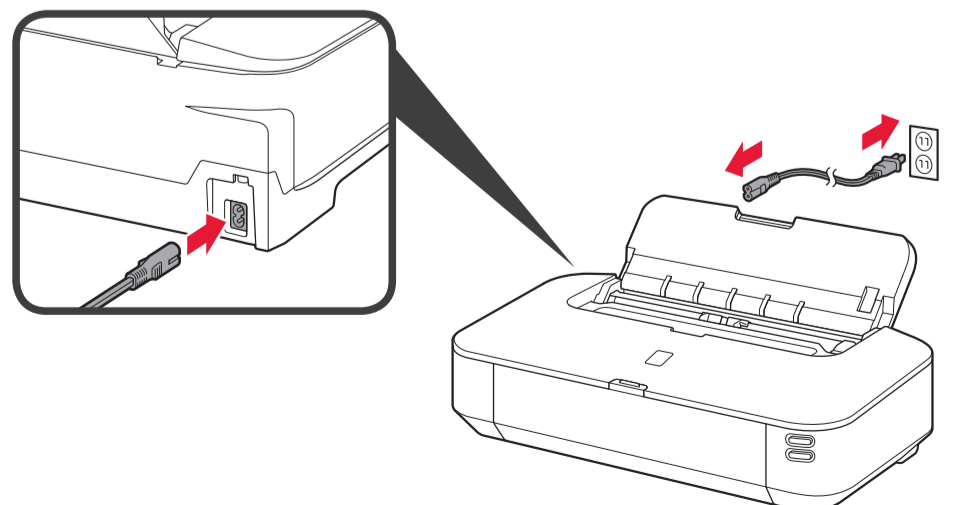

2

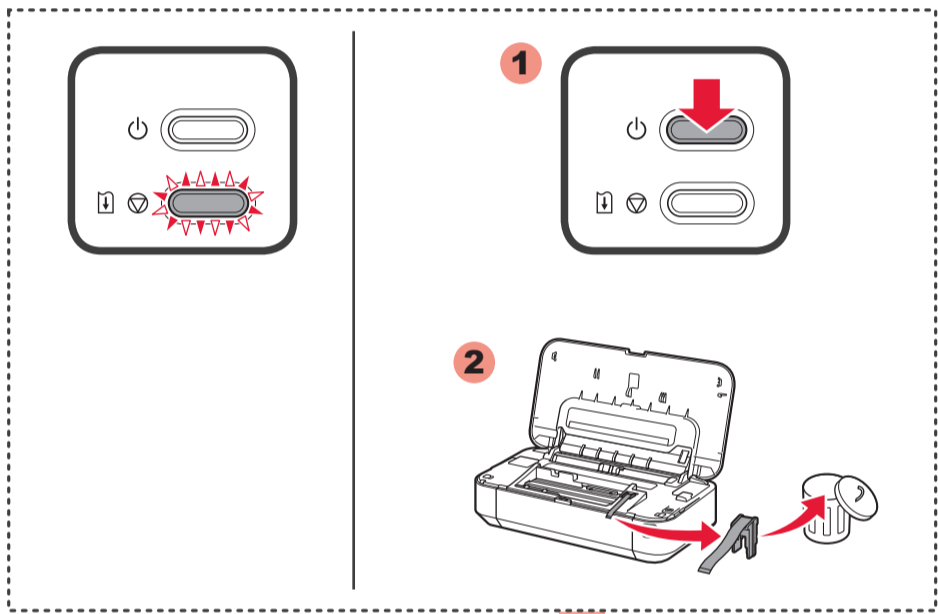
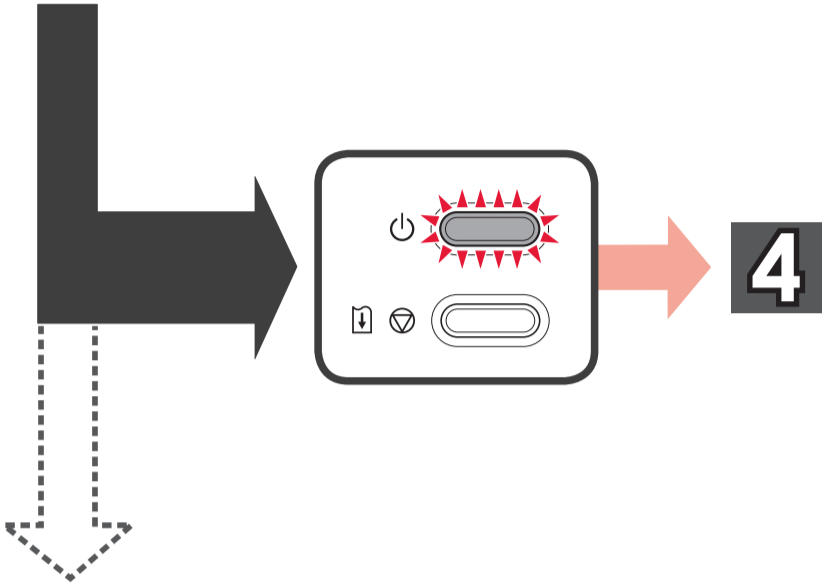
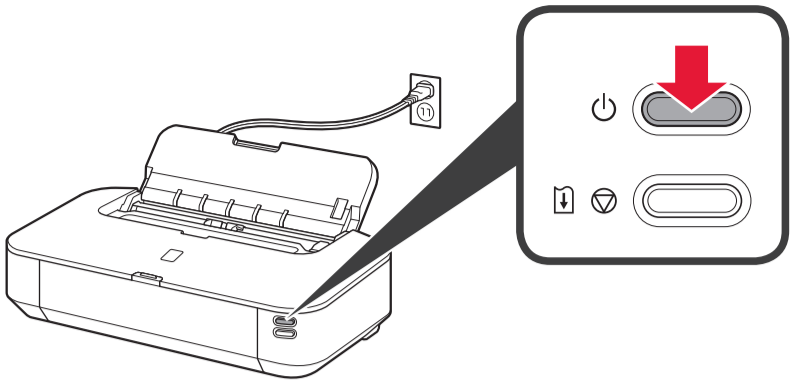

2 2

4

1

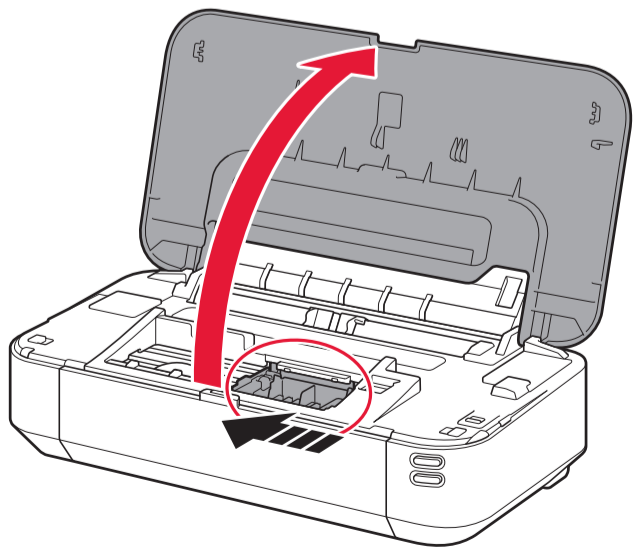

2

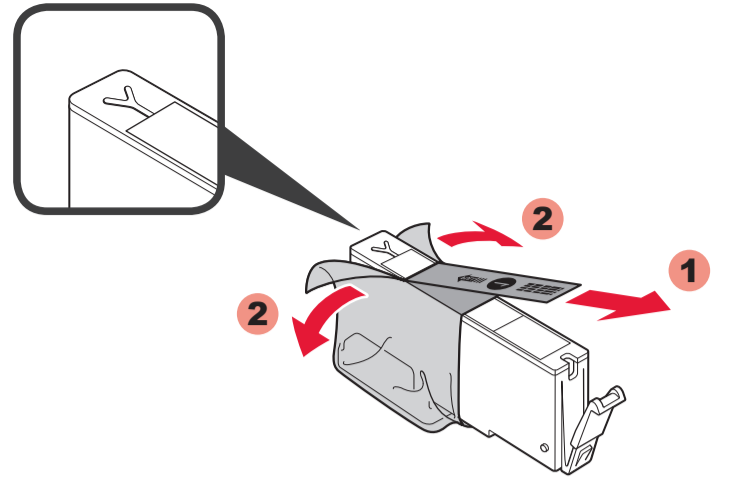

3

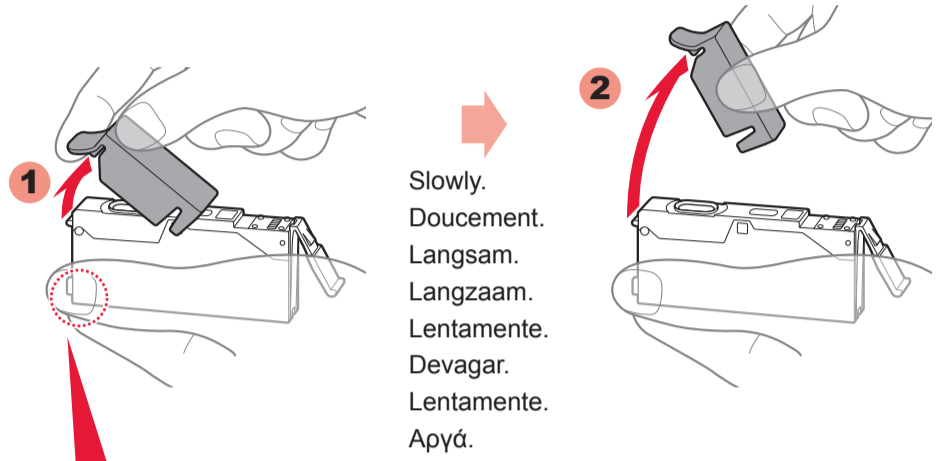

4

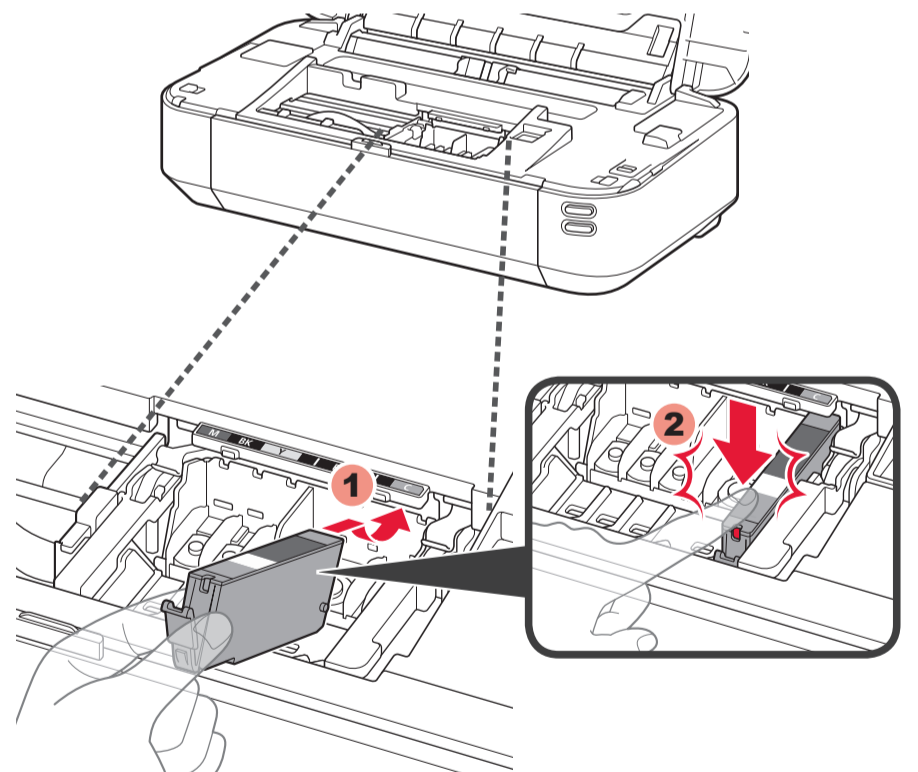

5

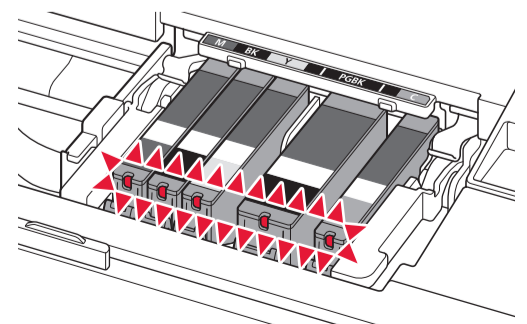

6

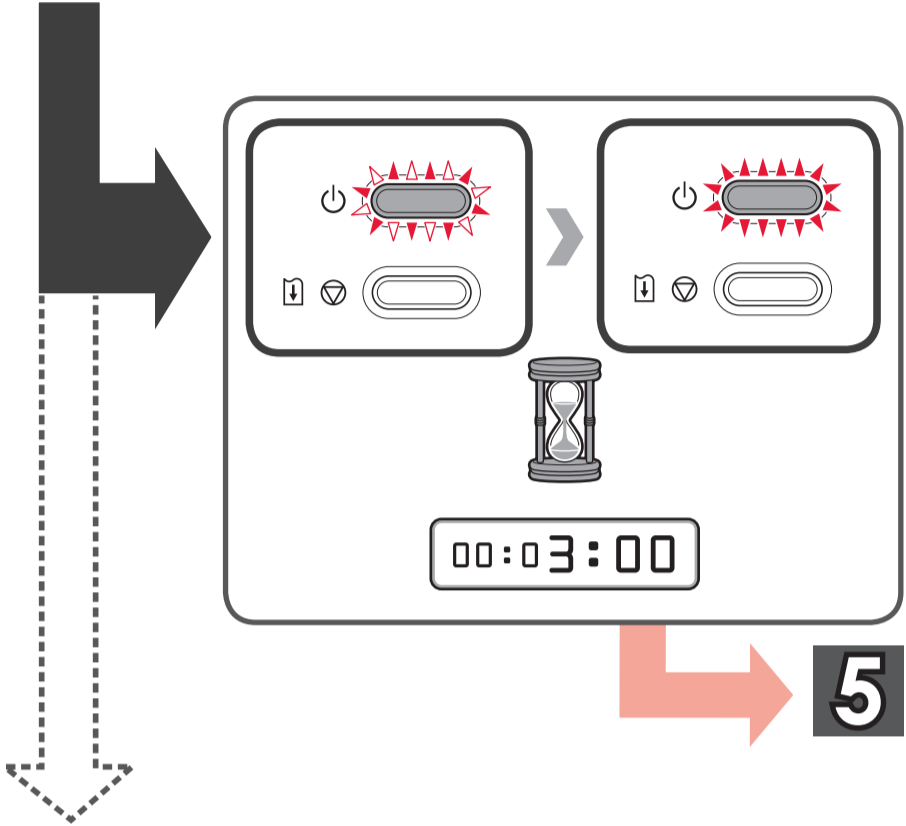
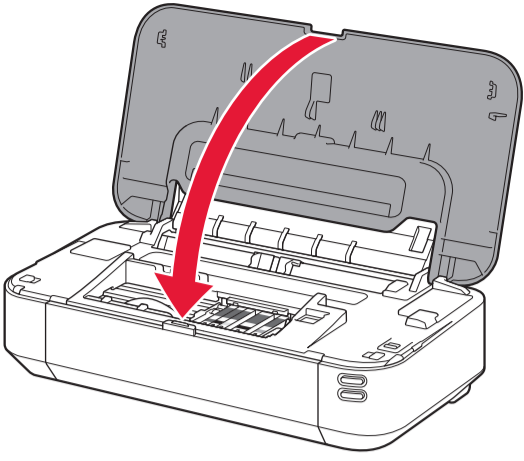

2

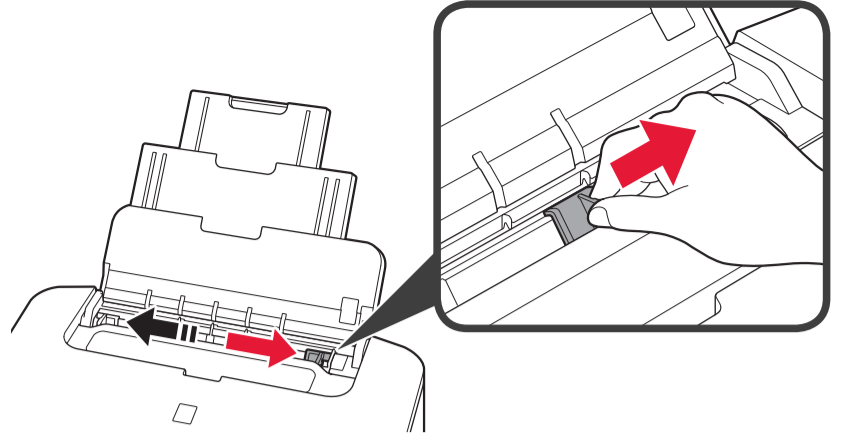

3

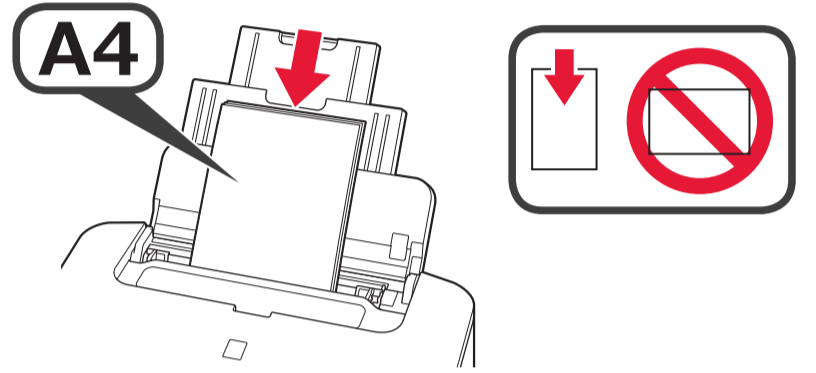

4

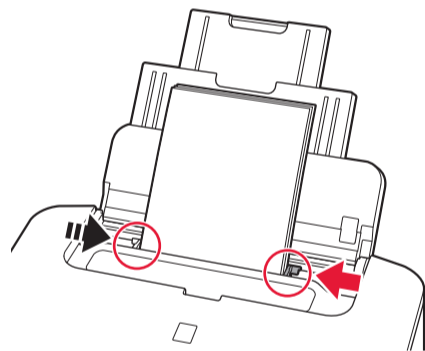

5

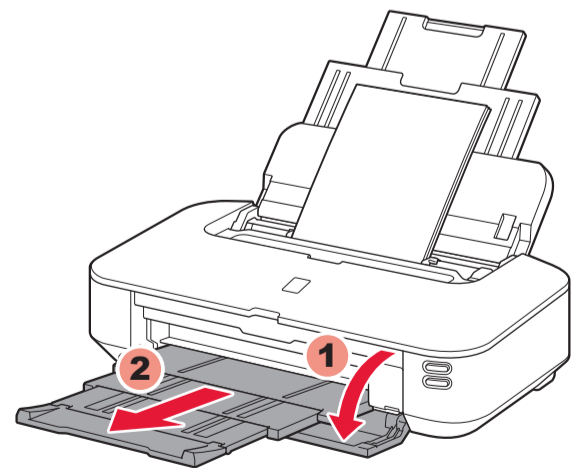

5

1

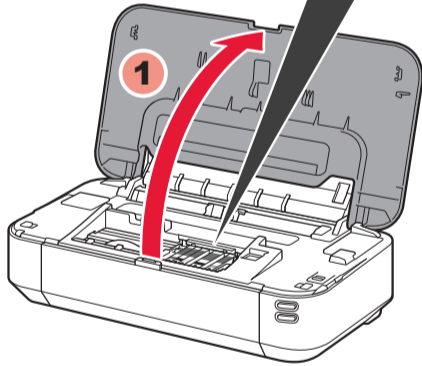
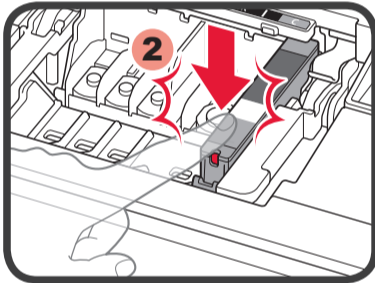
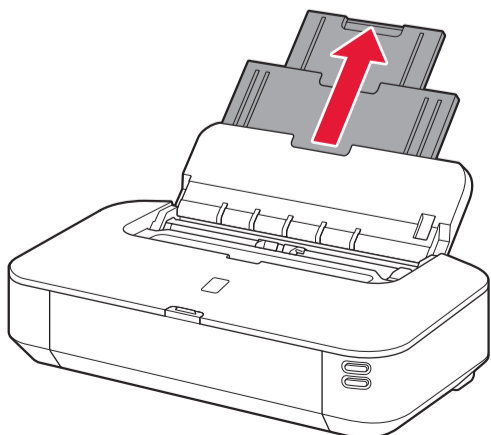

4 4

6

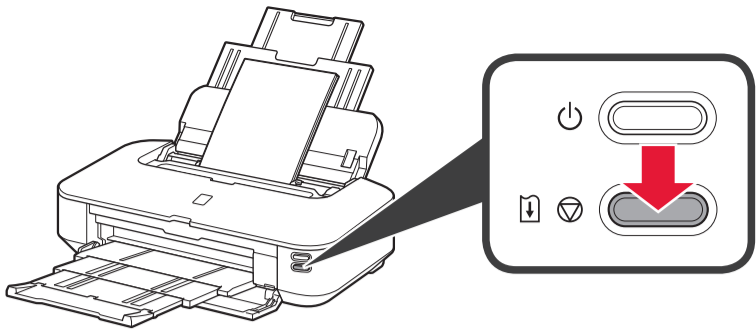

00:04:00

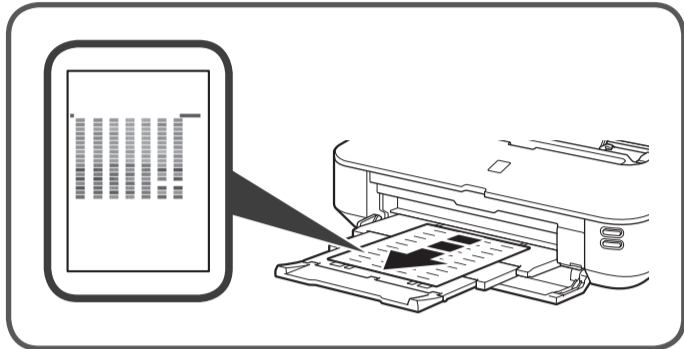

6

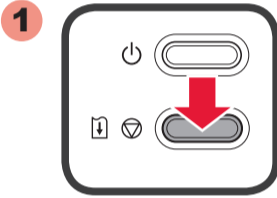
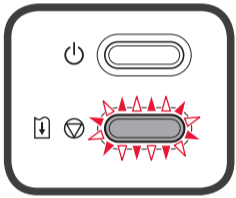

If the **Alarm** lamp flashes orange, press the **RESUME/CANCEL** button, then proceed to next chapter. Print Head Alignment can also be performed after installation.

Si le témoin d'**Alarme (Alarm)** clignote en orange, appuyez sur le bouton **REPRENDRE/ANNULER (RESUME/CANCEL)**, puis passez au chapitre suivant. La fonction Alignement tête d'impression peut également être exécutée après l'installation.

Wenn die **Alarm**-Anzeige orange blinkt, drücken Sie die Taste **FORTSETZEN/ABBRECHEN (RESUME/CANCEL)**, und fahren Sie mit dem nächsten Kapitel fort. Die Druckkopfausrichtung (Print Head Alignment) kann auch nach der Installation durchgeführt werden.

Als het **Alarm**-lampje oranje knippert, drukt u op de knop **HERVATTEN/ANNULEREN (RESUME/CANCEL)** en gaat u verder met het volgende hoofdstuk. Uitlijning printkop (Print Head Alignment) kan ook na de installatie worden uitgevoerd.

Se la spia **Allarme (Alarm)** lampeggia in arancione, premere il pulsante **RIPRENDI/ANNULLA (RESUME/CANCEL)**, quindi passare al capitolo successivo. È inoltre possibile effettuare l'Allineamento testina di stampa (Print Head Alignment) dopo l'installazione.

Se o indicador luminoso **Alarme (Alarm)** pisca em laranja, pressione o botão **RETOMAR/CANCELAR (RESUME/CANCEL)**, em seguida prossiga para o próximo capítulo. O Alinhamento da Cabeça de Impressão (Print Head Alignment) também pode ser executado após a instalação.

Si la luz de **Alarma (Alarm)** parpadea en naranja, pulse el botón **REANUDAR/CANCELAR (RESUME/CANCEL)** y continúe con el siguiente capítulo. La Alineación de los cabezales de impresión (Print Head Alignment) también puede realizarse después de la instalación.

Εάν η λυχνία **Προσοχή (Alarm)** αναβοσβήνει πορτοκαλί, πατήστε το κουμπί **ΕΠΑΝΑΦΟΡΑΣ/ΑΚΥΡΩΣΗΣ (RESUME/CANCEL)** και, στη συνέχεια, προχωρήστε στο επόμενο κεφάλαιο. Η Ευθυγράμμιση κεφαλής εκτύπωσης (Print Head Alignment) μπορεί να πραγματοποιηθεί και μετά την εγκατάσταση.

6

6

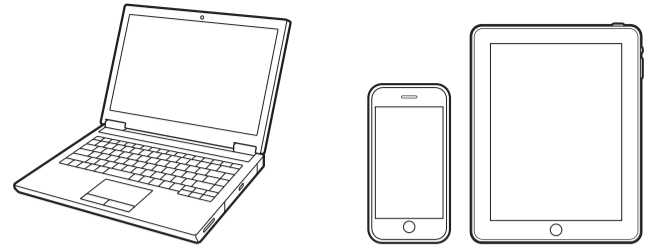
canon.com/ijsetup



Setup CD-ROM is also available for Windows PC.
 Un CD-ROM d'installation est également disponible pour Windows PC.
 Die Installations-CD-ROM ist auch für Windows-PC verfügbar.
 De Installatie-cd-rom is ook beschikbaar voor Windows-pc's.
 Il CD-ROM di installazione è disponibile anche per PC Windows.
 O CD-ROM de instalação também está disponível para PC com o Windows.
 El CD-ROM de instalación también está disponible para Windows PC.
 Το CD-ROM εγκατάστασης είναι επίσης διαθέσιμο για υπολογιστή Windows.



Quick Menu

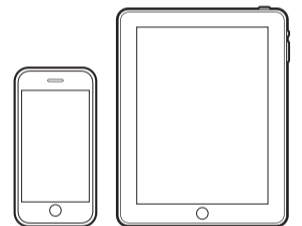

http://

canon.com/ijsetup

http://

