



LCD Monitor User Manual

60S / 60P (LED Backlight)

| | |
|----------------------------------|----|
| Safety..... | 4 |
| National Conventions..... | 4 |
| Power | 5 |
| Installation..... | 6 |
| Cleaning..... | 7 |
| Other..... | 8 |
| Setup | 9 |
| Contents of the Box | 9 |
| Setup Stand & Base | 10 |
| Adjusting Viewing Angle..... | 12 |
| Connecting the Monitor..... | 14 |
| Wall Mounting | 15 |
| Adjusting | 16 |
| Setting Optimal Resolution | 16 |
| Windows Vista | 16 |
| Windows XP | 18 |
| Windows ME/2000..... | 19 |
| Windows 8 | 19 |
| Hotkeys..... | 22 |
| OSD Setting..... | 24 |
| Luminance | 25 |
| Image Setup | 27 |
| Color Setup..... | 28 |
| Picture Boost | 29 |
| OSD Setup | 30 |
| Extra | 31 |
| Exit..... | 32 |
| LED Indicator | 33 |
| Driver | 34 |
| Monitor Driver | 34 |
| Windows 2000 | 34 |
| Windows ME..... | 34 |
| Windows XP | 35 |
| Windows Vista | 38 |
| Windows 7 | 40 |
| Windows 8 | 44 |
| i-Menu..... | 47 |
| e-Saver | 48 |
| Screen+ | 49 |
| Troubleshoot..... | 50 |
| Specification..... | 53 |
| General Specification..... | 53 |
| Preset Display Modes | 58 |
| Pin Assignments | 62 |
| Plug and Play..... | 64 |
| Regulation..... | 65 |

| | |
|---|----|
| FCC Notice | 65 |
| WEEE Declaration | 66 |
| WEEE Declaration for India | 66 |
| EPA Energy Star | 67 |
| EPEAT Declaration | 68 |
| Warranty Statement for North & South America (excluding Brazil) | 73 |
| TCO DOCUMENT | 75 |

Safety

National Conventions

The following subsections describe notational conventions used in this document.

Notes, Cautions, and Warnings

Throughout this guide, blocks of text may be accompanied by an icon and printed in bold type or in italic type. These blocks are notes, cautions, and warnings, and they are used as follows:



NOTE: A NOTE indicates important information that helps you make better use of your computer system.





CAUTION: A CAUTION indicates either potential damage to hardware or loss of data and tells you how to avoid the problem.





WARNING: A WARNING indicates the potential for bodily harm and tells you how to avoid the problem. Some warnings may appear in alternate formats and may be unaccompanied by an icon. In such cases, the specific presentation of the warning is mandated by regulatory authority.

Power

 The monitor should be operated only from the type of power source indicated on the label. If you are not sure of the type of power supplied to your home, consult your dealer or local power company.

 The monitor is equipped with a three-pronged grounded plug, a plug with a third (grounding) pin. This plug will fit only into a grounded power outlet as a safety feature. If your outlet does not accommodate the three-wire plug, have an electrician install the correct outlet, or use an adapter to ground the appliance safely. Do not defeat the safety purpose of the grounded plug.

 Unplug the unit during a lightning storm or when it will not be used for long periods of time. This will protect the monitor from damage due to power surges.

 Do not overload power strips and extension cords. Overloading can result in fire or electric shock.

 To ensure satisfactory operation, use the monitor only with UL listed computers which have appropriate configured receptacles marked between 100 - 240V ~, Min. 5A

 The wall socket shall be installed near the equipment and shall be easily accessible.

 For use only with the attached power adapter (Output 12Vdc) which have UL, CSA listed license (Only for monitors with power adapter).

Installation

! Do not place the monitor on an unstable cart, stand, tripod, bracket, or table. If the monitor falls, it can injure a person and cause serious damage to this product. Use only a cart, stand, tripod, bracket, or table recommended by the manufacturer or sold with this product. Follow the manufacturer's instructions when installing the product and use mounting accessories recommended by the manufacturer. A product and cart combination should be moved with care.

! Never push any object into the slot on the monitor cabinet. It could damage circuit parts causing a fire or electric shock. Never spill liquids on the monitor.

! Do not place the front of the product on the floor.

! If you mount the monitor on a wall or shelf, use a mounting kit approved by the manufacturer and follow the kit instructions.

! Leave some space around the monitor as shown below. Otherwise, air-circulation may be inadequate hence overheating may cause a fire or damage to the monitor.

See below the recommended ventilation areas around the monitor when the monitor is installed on the wall or on the stand:

Installed on the wall

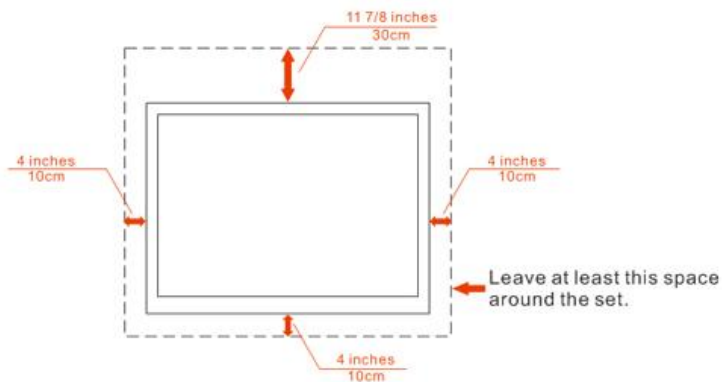

Installed with stand

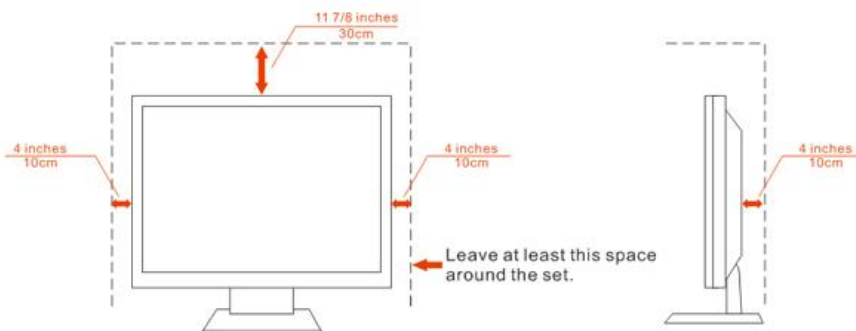

Cleaning

⚠️ Clean the cabinet regularly with cloth. You can use soft-detergent to wipe out the stain, instead of strong-detergent which will cauterize the product cabinet.

⚠️ When cleaning, make sure no detergent is leaked into the product. The cleaning cloth should not be too rough as it will scratch the screen surface.

⚠️ Please disconnect the power cord before cleaning the product.



Other

 If the product is emitting a strange smell, sound or smoke, disconnect the power plug IMMEDIATELY and contact a Service Center.

 Make sure that the ventilating openings are not blocked by a table or curtain.

 Do not engage the LCD monitor in severe vibration or high impact conditions during operation.

 Do not knock or drop the monitor during operation or transportation.

Setup

Contents of the Box

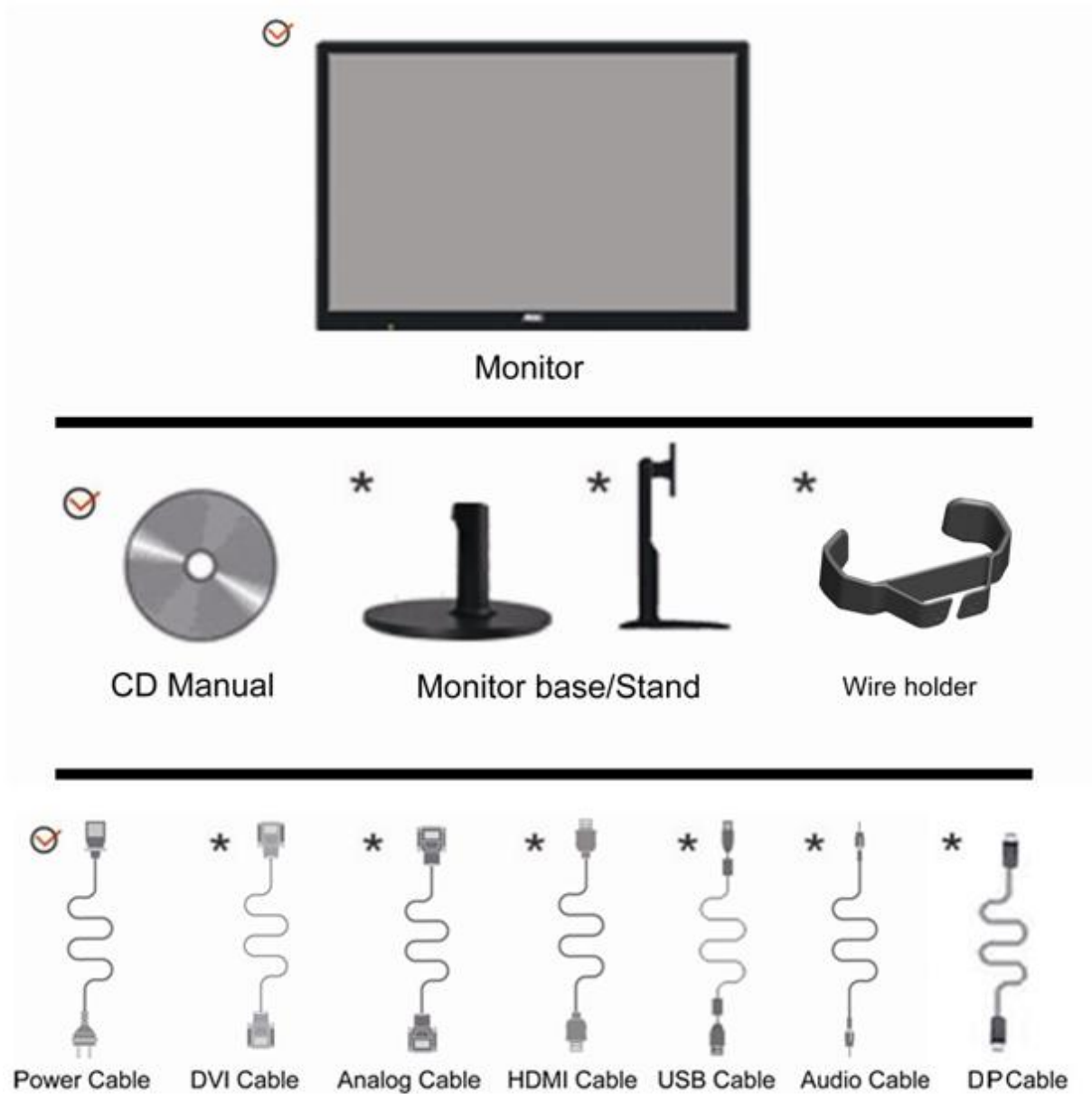

*Not all signal cables (Analog , Audio, DVI,USB 、 DP and HDMI cables) will be provided for all countries and regions. Please check with the local dealer or AOC branch office for confirmation.

Setup Stand & Base

Please setup or remove the base following the steps as below.

1>.Setup:



Remove:



2>.Setup:



Remove:



Adjusting Viewing Angle

For optimal viewing it is recommended to look at the full face of the monitor, then adjust the monitor's angle to your own preference.

Hold the stand so you will not topple the monitor when you change the monitor's angle.

1> You are able to adjust the monitor's angle from -5° to 22° .

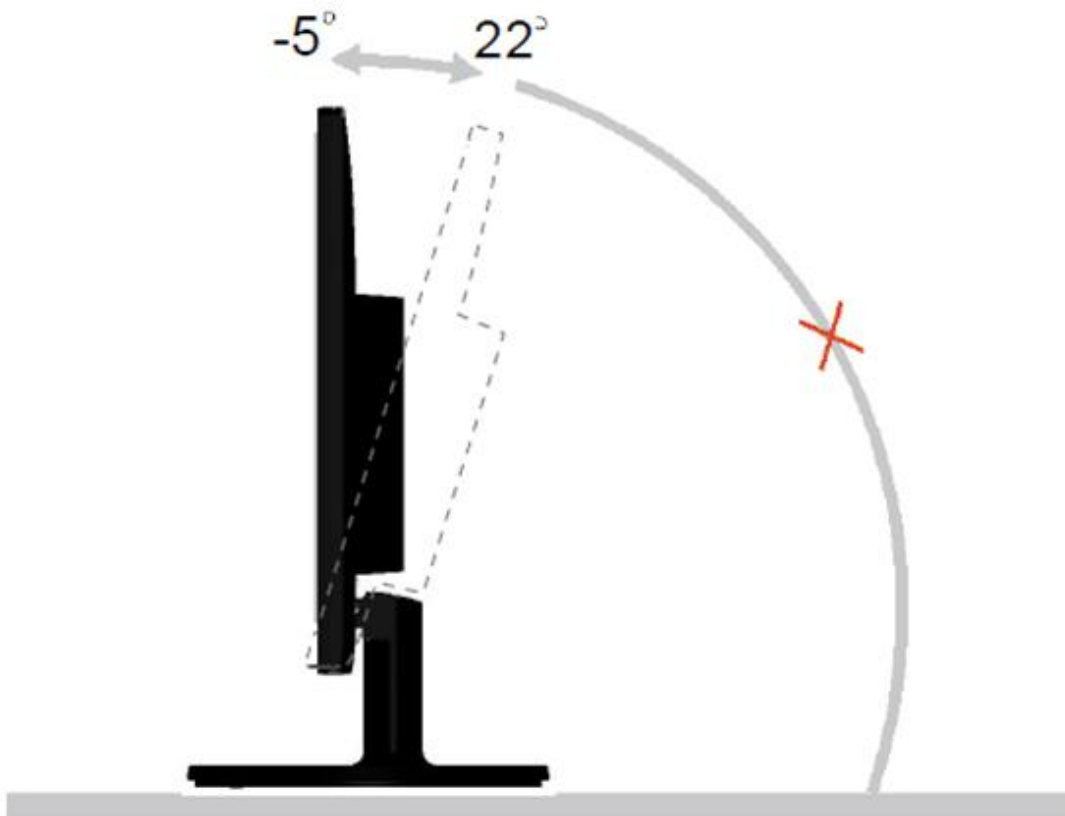

2> You are able to adjust the monitor's angle from -5° to 22° .

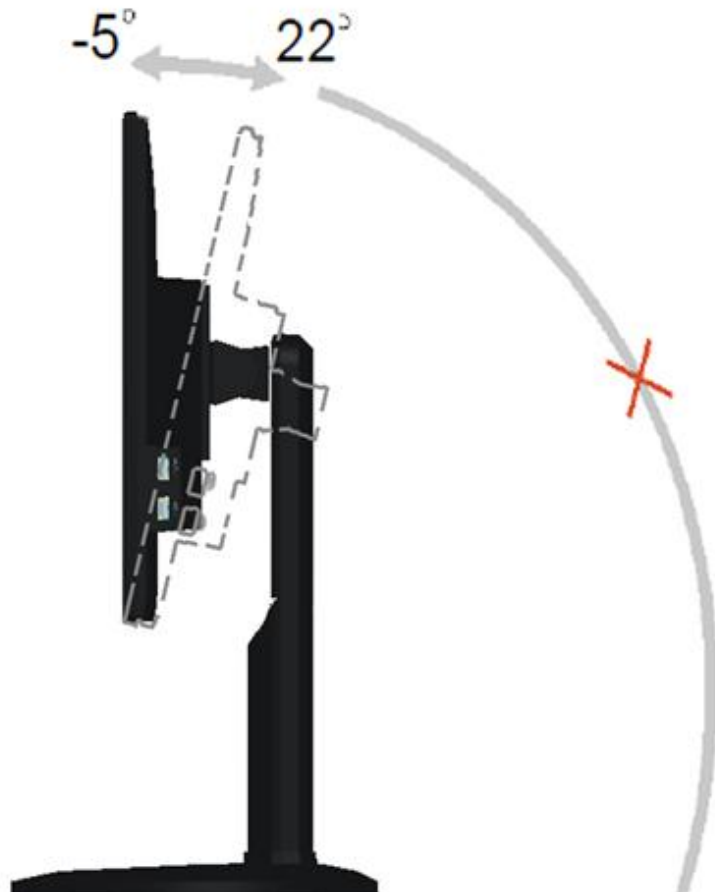

NOTE:

Do not touch the LCD screen when you change the angle. It may cause damage or break the LCD screen.

Connecting the Monitor

Cable Connections In Back of Monitor and Computer:

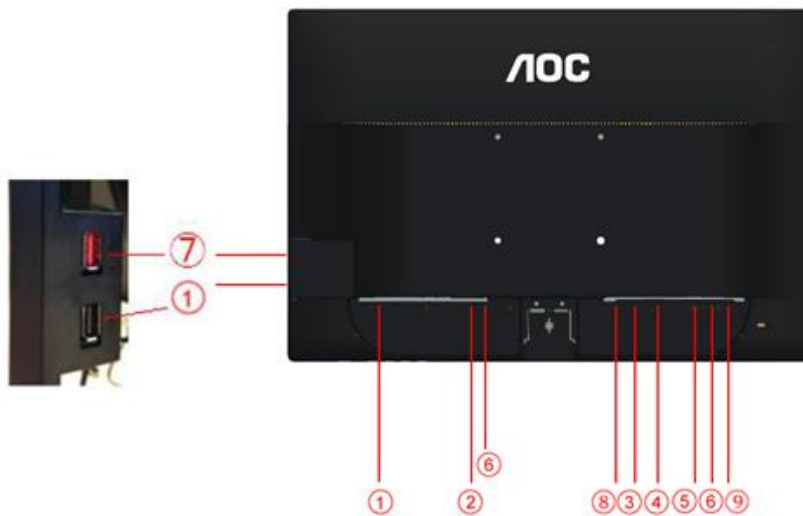

1. USB (Optional)
2. Power
- 3 HDMI (Optional)
- 4 .DVI (Optional)
5. Analog (DB-15 VGA cable)
6. Line in (Optional)
7. USB fast charging port (Optional)
8. Display port (Optional)
9. Earphone out(Optional)

To protect equipment, always turn off the PC and LCD monitor before connecting.

- 1 Connect the power cable to the AC port on the back of the monitor.
- 2 Connect one end of the 15-pin D-Sub cable to the back of the monitor and connect the other end to the computer's D-Sub port.
3. (Optional –Requires a video card with DVI port)Connect one end of the DVI cable to the back of the monitor and connect the other end to the computer's DVI port.
4. (Optional – Requires a video card with HDMI port) - Connect one end of the HDMI cable to the back of the monitor and connect the other end to the computer's HDMI port.
5. (Optional – Requires a video card with DP port) - Connect one end of the DP cable to the back of the monitor and connect the other end to the computer's DP port.
6. (Optional)Connect the audio cable to audio in port on the back of the monitor
- 7 .Turn on your monitor and computer.
8. USB fast charging port (Optional) .

If your monitor displays an image, installation is complete. If it does not display an image, please refer Troubleshooting.

Wall Mounting

Preparing to Install An Optional Wall Mounting Arm.



This monitor can be attached to a wall mounting arm you purchase separately. Disconnect power before this procedure. Follow these steps:

- 1 Remove the base.
- 2 Follow the manufacturer's instructions to assemble the wall mounting arm.
- 3 Place the wall mounting arm onto the back of the monitor. Line up the holes of the arm with the holes in the back of the monitor.
- 4 Insert the 4 screws into the holes and tighten.
- 5 Reconnect the cables. Refer to the user's manual that came with the optional wall mounting arm for instructions on attaching it to the wall.

Noted : VESA mounting screw holes are not available for all models, please check with the dealer or official department of AOC.

Adjusting

Setting Optimal Resolution

Windows Vista

For Windows Vista:

1 Click **START**.

2 Click **CONTROL PANEL**.



3 Click **Appearance and Personalization**.



4 Click **Personalization**



5 Click **Display Settings**.



6 Set the resolution **SLIDE-BAR** to Optimal preset resolution



Windows XP

For Windows XP:

1 Click **START**.



2 Click **SETTINGS**.

3 Click **CONTROL PANEL**.

4 Click **Appearance and Themes**.

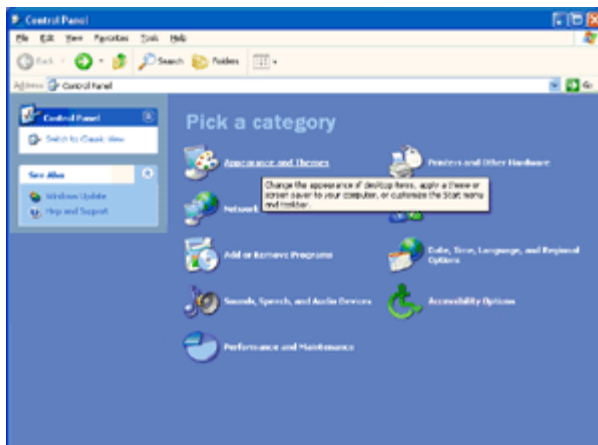

5 Double click **DISPLAY**.

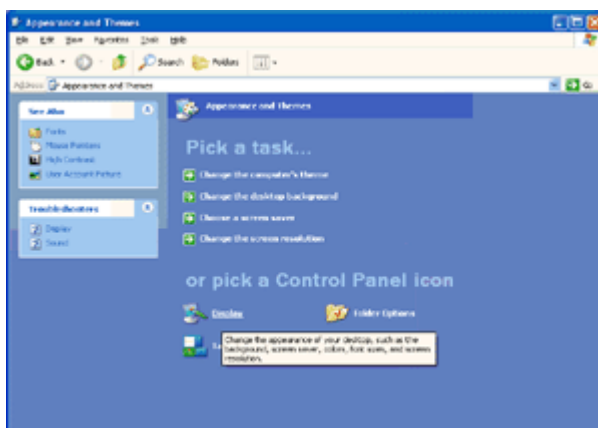

6 Click **SETTINGS**.

7 Set the resolution **SLIDE-BAR** to Optimal preset resolution

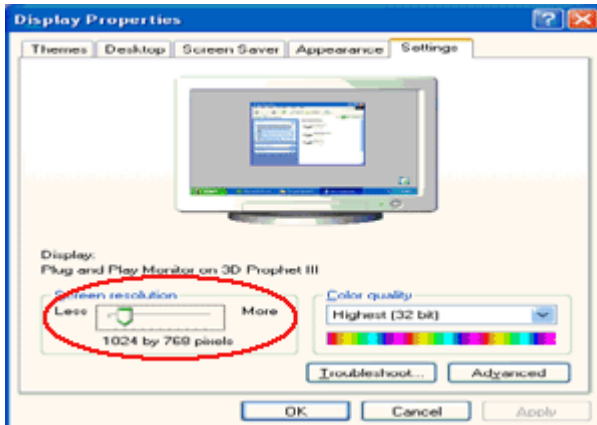

Windows ME/2000

For Windows ME/2000:

- 1 Click **START**.
- 2 Click **SETTINGS**.
- 3 Click **CONTROL PANEL**.
- 4 Double click **DISPLAY**.
- 5 Click **SETTINGS**.
- 6 Set the resolution **SLIDE-BAR** to Optimal preset resolution

Windows 8

For Windows 8:

1. Right click and click **All apps** at the bottom-right of the screen.

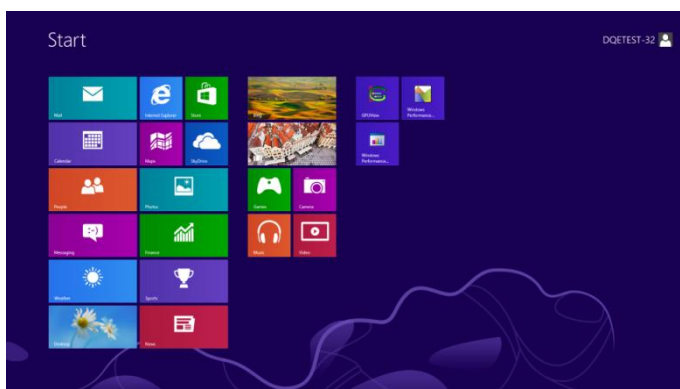

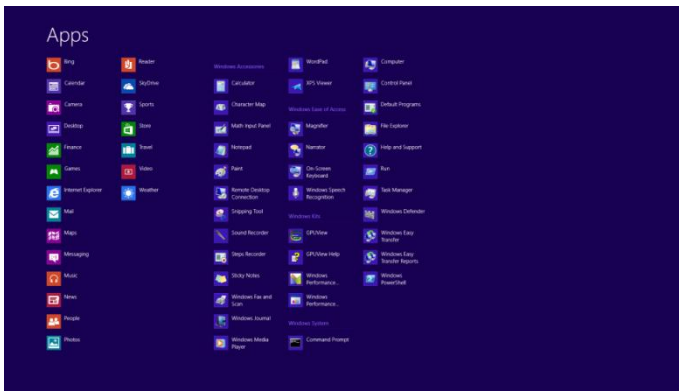

2. Set the “view by” to “Category”.
3. Click **Appearance and Personalization**.

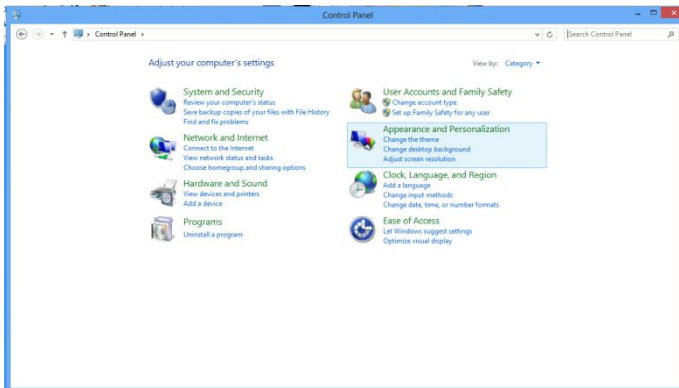

4. Click **DISPLAY**.

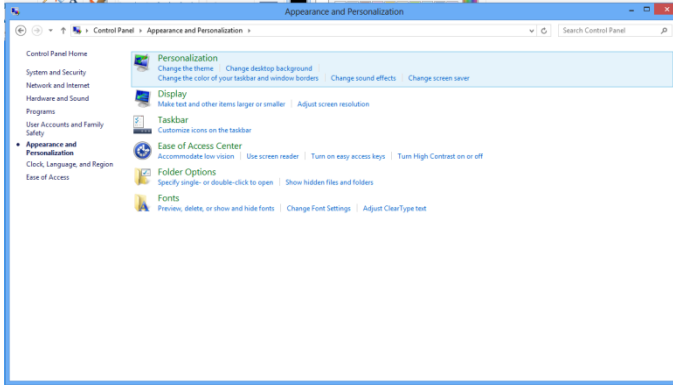

5. Set the resolution SLIDE-BAR to Optimal preset resolution .

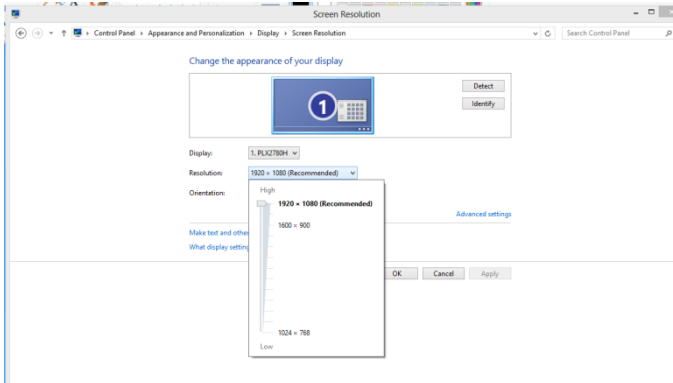

Hotkeys

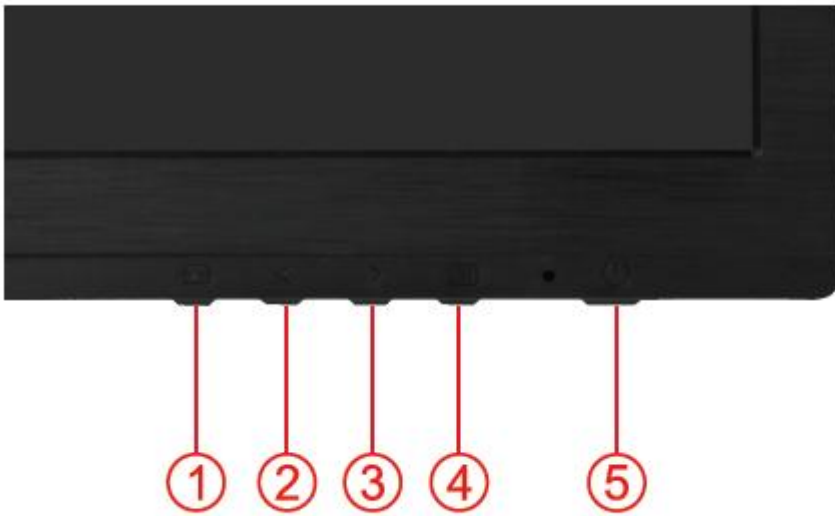

E2260P_{HU}/E2260S_{HU} /E2460P_{WHU}/E2460S_{WHU}/E2460S_{HU}/E2460P_{HU}:

| | |
|---|-------------------|
| 1 | Source/Auto/Exit |
| 2 | ECO(DCR/I-Care)/< |
| 3 | Volume / > |
| 4 | Menu/Enter |
| 5 | Power |

E2060S_{WDU}/E2060S_{WDAN}/E960S_{RDA}/ E960P_{RDA} /E2060S_{WDA}/E2060P_{WDA} / E2260S_{DA}/

E2260P_{DA}/E2260P_Q:

| | |
|---|------------------|
| 1 | Source/Auto/Exit |
| 2 | ECO(DCR)/< |
| 3 | Volume / > |
| 4 | Menu/Enter |
| 5 | Power |

E2060S_{WDN} /E2060S_{WDI}/ E2260S_D:

| | |
|---|------------------|
| 1 | Source/Auto/Exit |
| 2 | ECO(DCR)/< |
| 3 | 4:3 or Wide / > |
| 4 | Menu/Enter |
| 5 | Power |

E2060S_{WN} /E2060S_W:

| | |
|---|-----------------|
| 1 | Auto/Exit |
| 2 | ECO(DCR)/< |
| 3 | 4:3 or Wide / > |
| 4 | Menu/Enter |
| 5 | Power |

E960S_{RD}:

| | |
|---|------------------|
| 1 | Source/Auto/Exit |
| 2 | ECO(DCR)/< |
| 3 | > |
| 4 | Menu/Enter |
| 5 | Power |

Power

Press the Power button to turn on/off the monitor.

Eco (DCR/I-Care) / <

Press the Eco key continuously to select the Eco mode of brightness and DCR/I-Care on when there is no OSD.
(Eco mode hot key may not be available in all models).

Volume / >

When there is no OSD, Press Volume button to active volume adjustment bar, Press < or + to adjust volume (Only for the models with speakers)

Auto / Exit

When there is no OSD, press Auto/Source button continuously about **3** second to do auto configure .









Source hot key

When the OSD is closed, press Source button will be Source hot key function. Press Source button continuously to select the input source showed in the message bar , press Menu/Enter button to change to the source selected

OSD Setting

Basic and simple instruction on the control keys.





- 1) Press the  **MENU-button** to activate the OSD window.
- 2) Press **< or >** to navigate through the functions. Once the desired function is highlighted, press the  **MENU-button** to activate it . press **< or >** to navigate through the sub-menu functions. Once the desired function is highlighted, press  **MENU-button** to activate it.
- 3) Press **< or >** to change the settings of the selected function. Press  **AUTO** to exit. If you want to adjust any other function, repeat steps 2-3.
- 4) OSD Lock Function: To lock the OSD, press and hold the  **MENU button** while the monitor is off and then press  **power button** to turn the monitor on. To un-lock the OSD - press and hold the  **MENU button** while the monitor is off and then press  **power button** to turn the monitor on.

Notes:

- 1) If the product has only one signal input, the item of "Input Select" is disable to adjust.
- 2) If the product screen size is 4:3 or input signal resolution is wide format, the item of "Image Ratio" is disable to adjust.
- 3) One of DCR, Color Boost, and Picture Boost functions is active, the other two function is turned off accordingly.

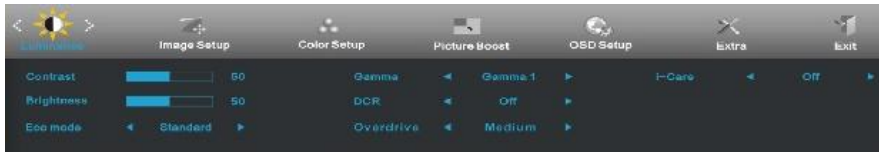
Luminance



1 Press  (Menu) to display menu.

2 Press < or > to select  (Luminance), and press  to enter.

3 Press < or > to select submenu, and press  to enter.

4 Press < or > to adjust.

5 Press  to exit.















| | | | | |
|---|------------|----------|---|--|
|  | Brightness | 0-100 | | Backlight Adjustment |
| | Contrast | 0-100 | | Contrast from Digital-register. |
| | Eco mode | Standard |  | Standard Mode |
| | | Text |  | Text Mode |
| | | Internet |  | Internet Mode |
| | | Game |  | Game Mode |
| | | Movie |  | Movie Mode |
| | | Sports |  | Sports Mode |
| | Gamma | Gamma1 | | Adjust to Gamma1 |
| | | Gamma2 | | Adjust to Gamma 2 |
| | | Gamma3 | | Adjust to Gamma 3 |
| | DCR | Off | | Disable dynamic contrast ratio |
| | | On |  | Enable dynamic contrast ratio |
| | Overdrive | Weak | | Adjust the response time (only for E2260PHU/E2260SHU/ E2460PWHU/E2460SWHU/E2460SHU/E2460PHU/E226 0PQ) |
| | | Medium | | |
| | | Strong | | |
| | | Off | | |
| i-Care | On | | adjusts the brightness according to light intensity (only for E2260PHU/E2260SHU/ E2460PWHU/E2460SWHU/E2460SHU/E2460PHU) | |
| | Off | | | |

Image Setup

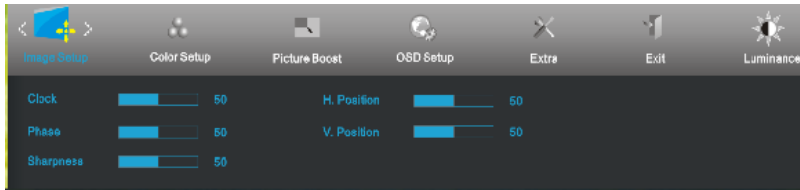





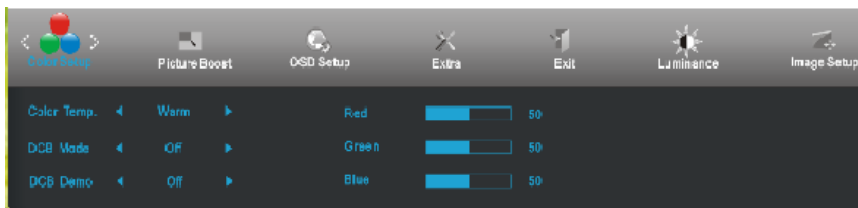

- 1 Press  to display menu.
- 2 Press **<** or **>** to select  (Image Setup), and press  to enter.
- 3 Press **<** or **>** to select submenu, and press  to enter.
- 4 Press **<** or **>** to adjust.
- 5 Press  to exit.

| | | | |
|---|------------|-------|--|
|  | Clock | 0-100 | Adjust picture Clock to reduce Vertical-Line noise. |
| | Phase | 0-100 | Adjust Picture Phase to reduce Horizontal-Line noise |
| | Sharpness | 0-100 | Adjust picture sharpness |
| | H.Position | 0-100 | Adjust the horizontal position of the picture. |
| | V.Position | 0-100 | Adjust the vertical position of the picture. |

Color Setup





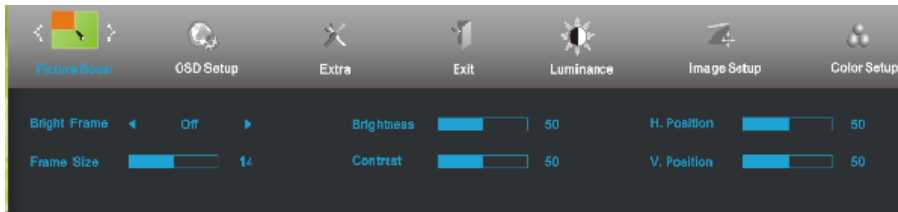

- 1 Press  (Menu) to display menu.
- 2 Press < or > to select , and press  to enter.
- 3 Press < or > to select submenu, and press  to enter.
- 4 Press < or > to adjust.
- 5 Press  to exit.

| | | | | | |
|---|--------------|--------------|-----------------------------------|--|--------------------------------|
|  | Color setup. | Warm | | Recall Warm Color Temperature from EEPROM. | |
| | | Normal | | Recall Normal Color Temperature from EEPROM. | |
| | | Cool | | Recall Cool Color Temperature from EEPROM. | |
| | | sRGB | | Recall SRGB Color Temperature from EEPROM. | |
| | | User | Red | | Red Gain from Digital-register |
| | | | Green | | Green Gain Digital-register. |
| | Blue | | | Blue Gain from Digital-register | |
| | DCB Mode | Full Enhance | on or off | Disable or Enable Full Enhance Mode | |
| | | Nature Skin | on or off | Disable or Enable Nature Skin Mode | |
| | | Green Field | on or off | Disable or Enable Green Field Mode | |
| | | Sky-blue | on or off | Disable or Enable Sky-blue Mode | |
| AutoDetect | | on or off | Disable or Enable AutoDetect Mode | | |
| DCB Demo | | On or off | Disable or Enable Demo | | |

Picture Boost









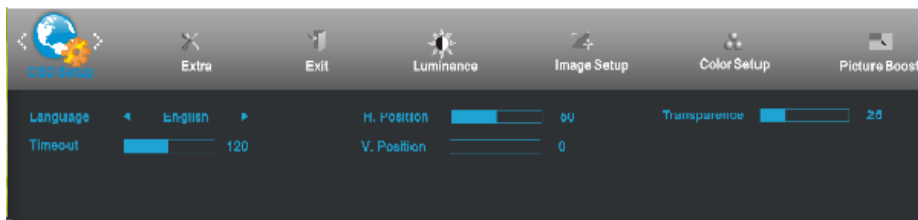





- 1 Press  (Menu) to display menu.
- 2 Press < or > to select  (Picture Boost), and press  to enter.
- 3 Press < or > to select submenu, and press  to enter.
- 4 Press < or > to adjust.
- 5 Press  to exit.

| | | | |
|---|--------------|-----------|----------------------------------|
|  | Frame Size | 14-100 | Adjust Frame Size |
| | Brightness | 0-100 | Adjust Frame Brightness |
| | Contrast | 0-100 | Adjust Frame Contrast |
| | H. position | 0-100 | Adjust Frame horizontal Position |
| | V. position | 0-100 | Adjust Frame vertical Position |
| | Bright Frame | on or off | Disable or Enable Bright Frame |

OSD Setup









- 1 Press  (Menu) to display menu.
- 2 Press  or  to select  (OSD Setup), and press  to enter.
- 3 Press  or  to select submenu, and press  to enter.
- 4 Press  or  to adjust.
- 5 Press  to exit.

| | | | |
|---|--------------|-------|---------------------------------------|
|  | H.Position | 0-100 | Adjust the horizontal position of OSD |
| | V.Position | 0-100 | Adjust the vertical position of OSD |
| | Timeout | 5-120 | Adjust the OSD Timeout |
| | Transparence | 0-100 | Adjust the transparence of OSD |
| | Language | | Select the OSD language |

Extra



- 1 Press  (Menu) to display menu.
- 2 Press < or > to select  (Extra), and press  to enter.
- 3 Press < or > to select submenu, and press  to enter.
- 4 Press < or > to adjust.
- 5 Press  to exit.

| | | | |
|---|--------------|--|---|
|  | Input Select | Auto / Analog / DVI / HDMI | Select input signal source. (E2260PHU/E2260SHU/ E2460PWHU/E2460SWHU/E2460SHU/E2460PHU) |
| | Input Select | Auto / Analog / DVI | Select input signal source. (E2060SWDN/E2060SWDAN /E960SRDA/E960PRDA/ E960SRD/E2060SWDA/E2060PWDA/E2060SWD/ E2260SD/E2260SDA/ E2260PDA/ E2060SWDU) |
| | Input Select | Analog | Select input signal source. (E2060Sw /E2060SWN) |
| | Input Select | Auto / Analog / DVI /DP | Select input signal source. (E2260PQ) |
| | Auto Config | yes or no | Auto adjust the picture to default. |
| | Off timer | 0-24hrs | Select DC off time. |
| | Image Ratio | wide or 4:3 | Select wide or 4:3 format for display. |
| | DDC-CI | yes or no | Turn ON/OFF DDC-CI Support. |
| | Reset | yes or no | Reset the menu to default. |
| Information | | Show the information of the main image and sub-image source. | |

Exit

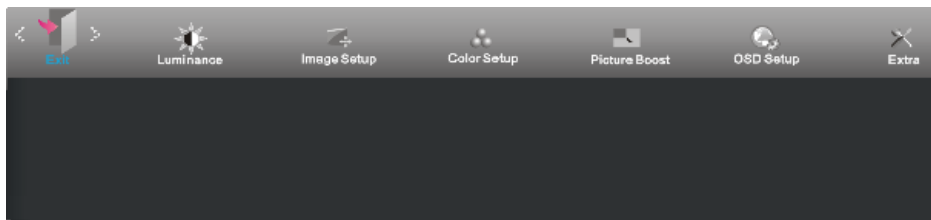

1 Press  (Menu) to display menu.

2 Press < or > to select  (Exit), and press  to enter.

3 Press  to exit

| | | | |
|--|------|--|-------------------|
|  | Exit | | Exit the main OSD |
|--|------|--|-------------------|

LED Indicator

Status

LED Color

Full Power Mode

Green or Blue



Active-off Mode

Orange or red



Driver

Monitor Driver

Windows 2000

1. Start Windows® 2000
 2. Click on the 'Start' button, point to 'Settings', and then click on 'Control Panel'.
 3. Double click on the 'Display' Icon.
 4. Select the 'Settings' tab then click on 'Advanced...'
 5. Select 'Monitor'
 - If the 'Properties' button is inactive, it means your monitor is properly configured. Please stop installation.
 - If the 'Properties' button is active. Click on 'Properties' button. Please follow the steps given below.
 6. Click on 'Driver' and then click on 'Update Driver...' then click on the 'Next' button.
 7. Select 'Display a list of the known drivers for this device so that I can choose a specific driver', then click on 'Next' and then click on 'Have disk...'
 8. Click on the 'Browse...' button then select the appropriate drive F: (CD-ROM Drive).
 9. Click on the 'Open' button, then click on the 'OK' button.
 10. Select your monitor model and click on the 'Next' button.
 11. Click on the 'Finish' button then the 'Close' button.
- If you can see the 'Digital Signature Not Found' window, click on the 'Yes' button.

Windows ME

1. Start Windows® Me
2. Click on the 'Start' button, point to 'Settings', and then click on 'Control Panel'.
3. Double click on the 'Display' Icon.
4. Select the 'Settings' tab then click on 'Advanced...'
5. Select the 'Monitor' button, then click on 'Change...' button.
6. Select 'Specify the location of the driver(Advanced)' and click on the 'Next' button.
7. Select 'Display a list of all the drivers in a specific location, so you can choose the driver you want', then click on 'Next' and then click on 'Have Disk...'
8. Click on the 'Browse...' button, select the appropriate drive F: (CD-ROM Drive) then click on the 'OK' button.
9. Click on the 'OK' button, select your monitor model and click on the 'Next' button.
10. Click on 'Finish' button then the 'Close' button.

Windows XP

1. Start Windows® XP
2. Click on the 'Start' button and then click on 'Control Panel'.



3. Select and click on the category 'Appearance and Themes'

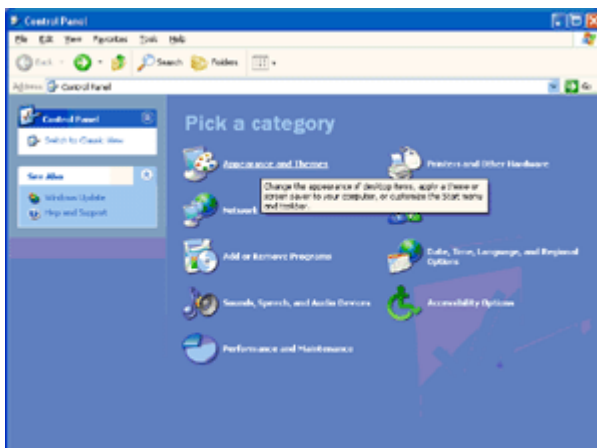

4. Click on the 'Display' Item.

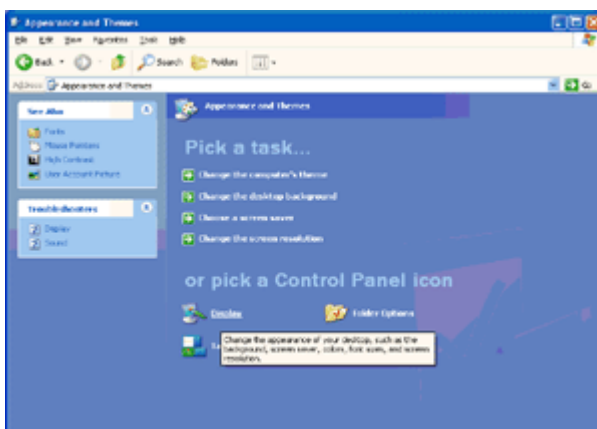

5. Select the 'Settings' tab then click on the 'Advanced' button.

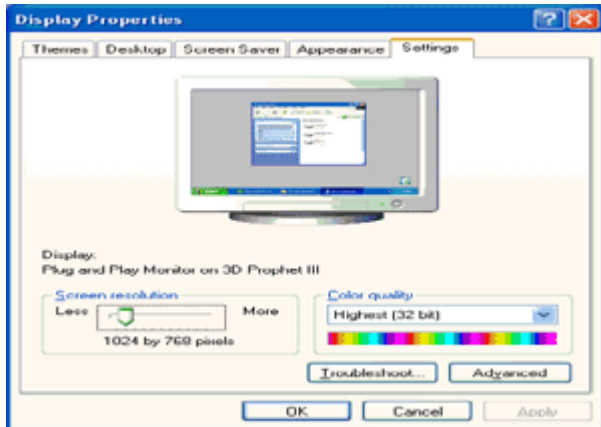

6. Select 'Monitor' tab

- If the 'Properties' button is inactive, it means your monitor is properly configured. Please stop installation.

- If the 'Properties' button is active, click on 'Properties' button.

Please follow the steps below.

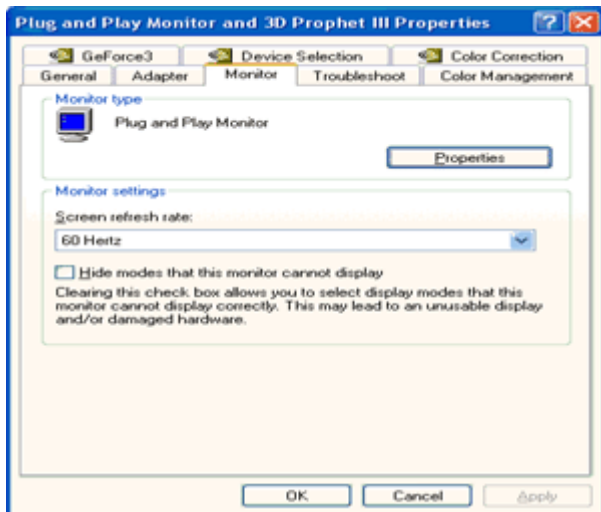

7. Click on the 'Driver' tab and then click on 'Update Driver...' button.

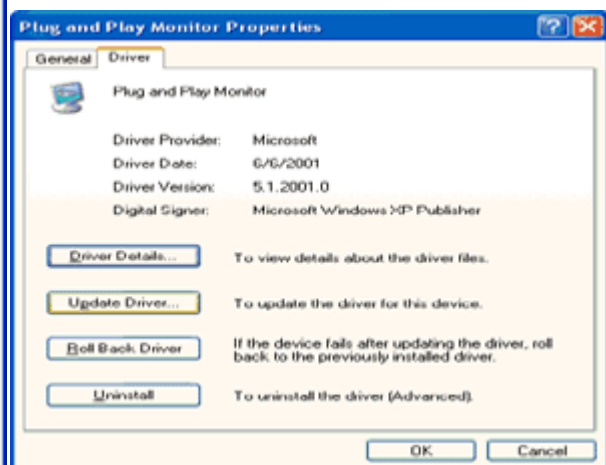
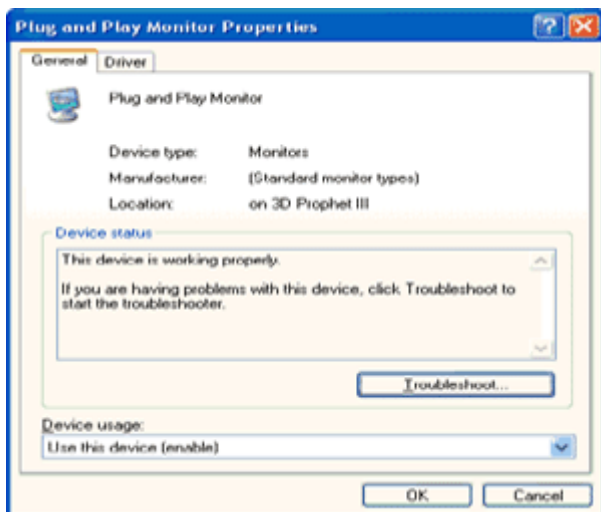

8. Select the 'Install from a list or specific location [advanced]' radio button and then click on the 'Next' button.

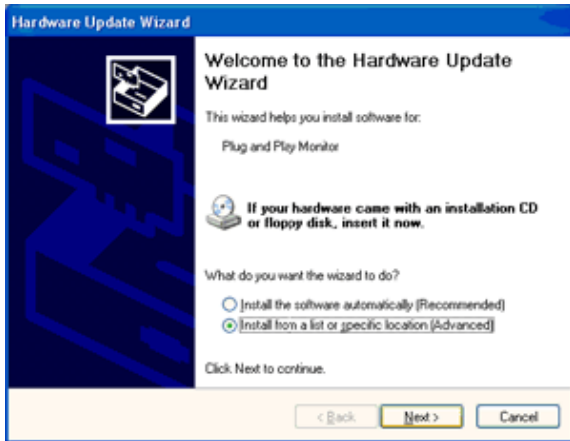

9. Select the 'Don't Search. I will choose the driver to install' radio button. Then click on the 'Next' button.

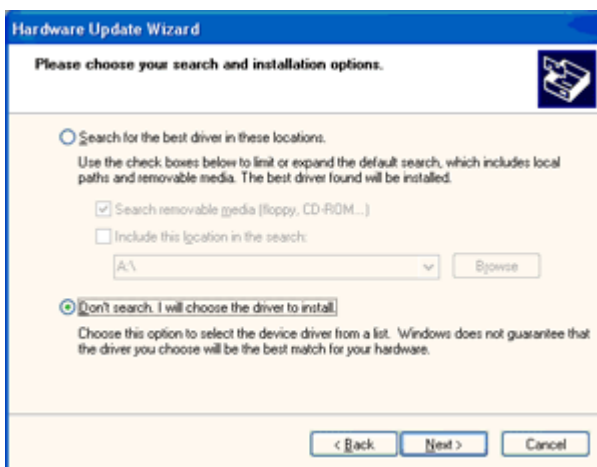

10. Click on the 'Have disk...' button, then click on the 'Browse...' button and then select the appropriate drive F: (CD-ROM Drive).

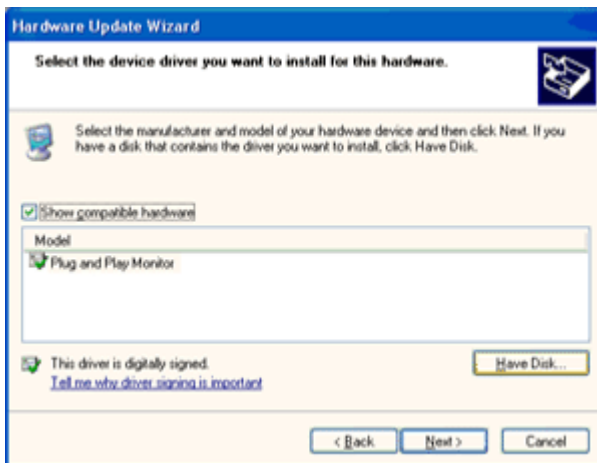

11. Click on the 'Open' button, then click the 'OK' button.

12. Select your monitor model and click on the 'Next' button.

- If you can see the 'has not passed Windows® Logo testing to verify its compatibility with Windows® XP' message, please click on the 'Continue Anyway' button.

13. Click on the 'Finish' button then the 'Close' button.

14. Click on the 'OK' button and then the 'OK' button again to close the Display Properties dialog box.

Windows Vista

1. Click "Start " and "Control Panel". Then, double-click on "Appearance and Personalization".



2. Click "Personalization" and then "Display Settings".



3. Click "Advanced Settings...".



4. Click "Properties" in the "Monitor" tab. If the "Properties" button is deactivated, it means the configuration for your monitor is completed. The monitor can be used as is.

If the message "Windows needs..." is displayed, as shown in the figure below, click "Continue".

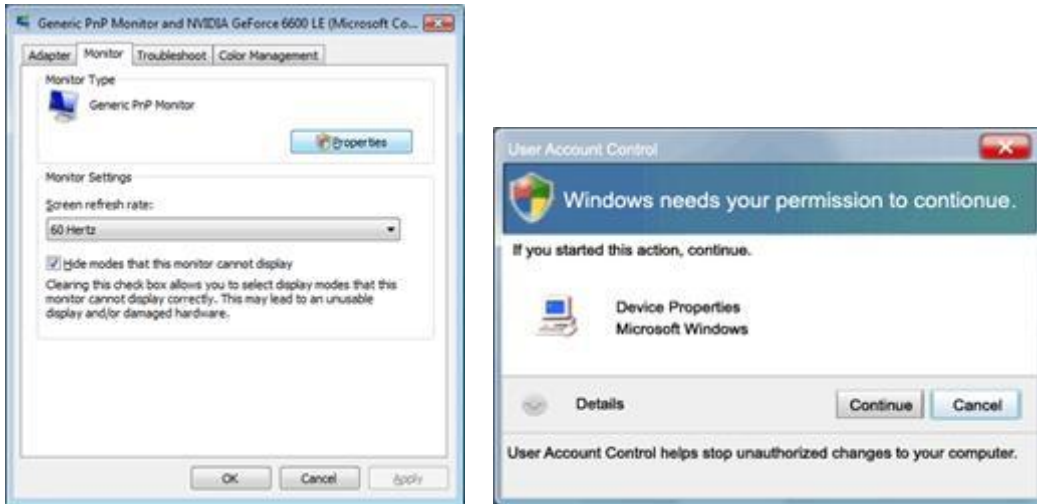

5. Click "Update Driver..." in the "Driver" tab.

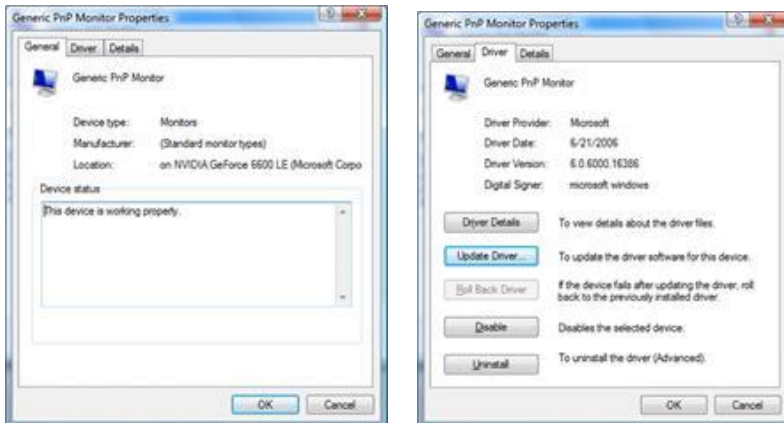

6. Check the "Browse my computer for driver software" checkbox and click "Let me pick from a list of device drivers on my computer".



7. Click on the 'Have disk...' button, then click on the 'Browse...' button and then select the appropriate drive F:\Driver (CD-ROM Drive).

8. Select your monitor model and click on the 'Next' button.

9. Click "Close" → "Close" → "OK" → "OK" on the following screens displayed in sequence.

Windows 7

1. Start Windows® 7

2. Click on the **'Start'** button and then click on **'Control Panel'**.

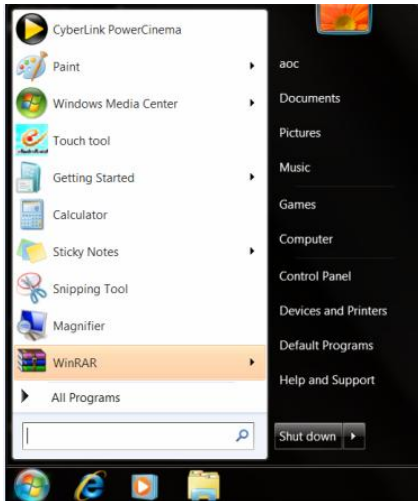

3. Click on the **'Display'** icon.

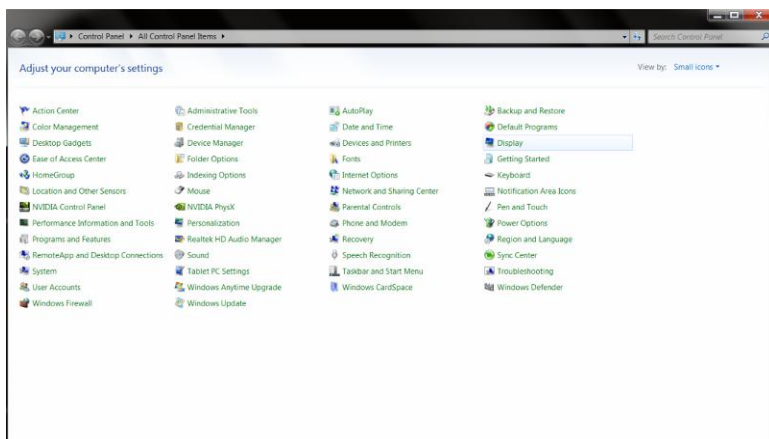

4. Click on the “Change display settings” button.

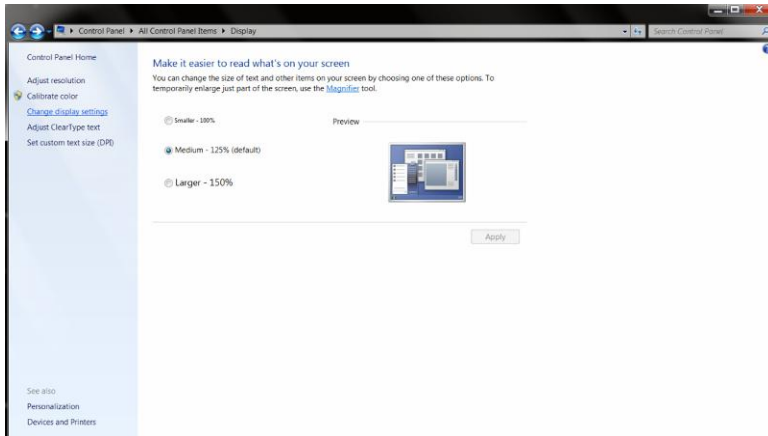

5. Click the “Advanced Settings” button.

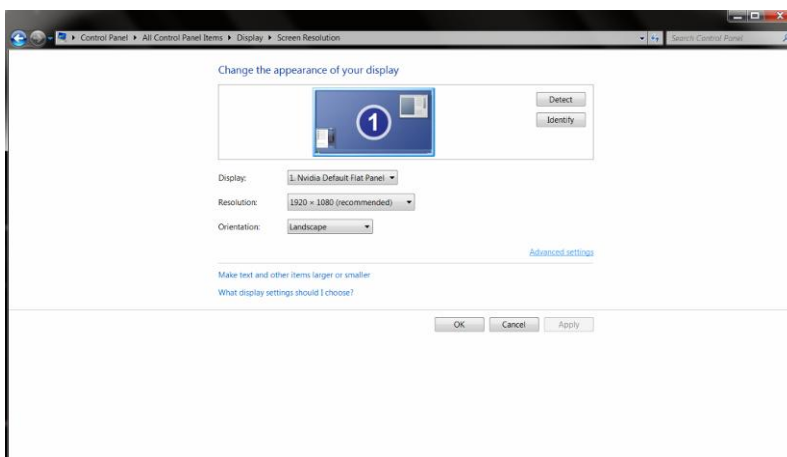

6. Click the “Monitor” tab and then click the “Properties” button.

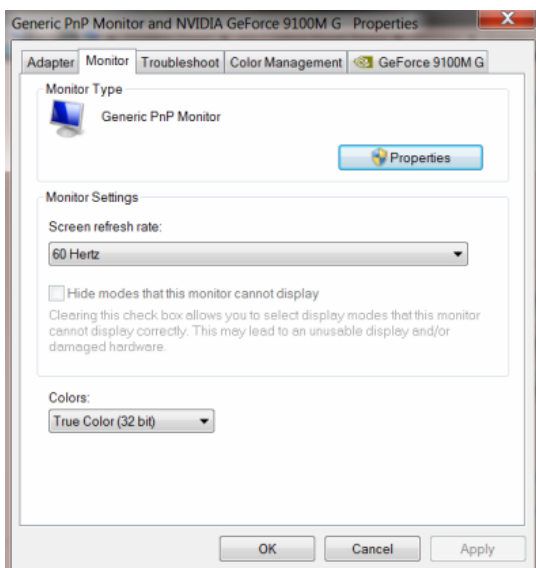

7. Click the **“Driver”** tab.

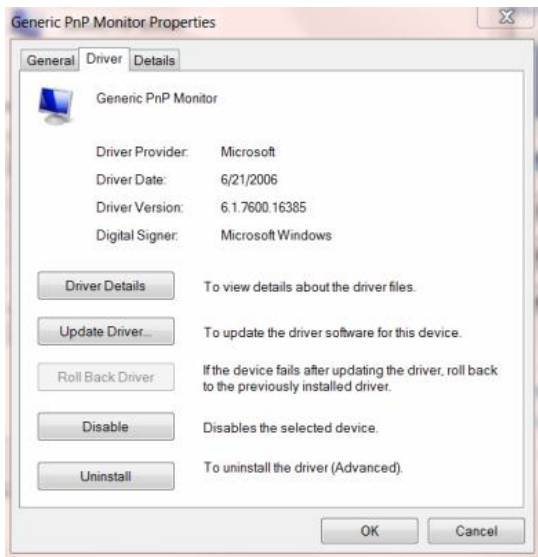

8. Open the "Update Driver Software-Generic PnP Monitor" window by clicking on **“Update Driver...”** and then click the **“Browse my computer for driver software”** button.

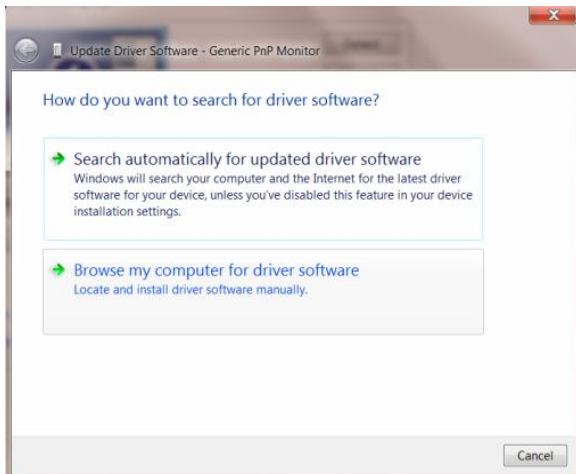

9. Select **“Let me pick from a list of device drivers on my computer”**.

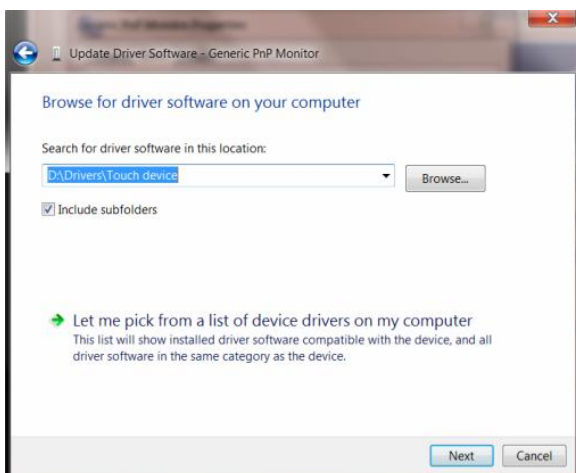

10. Click the **“Have Disk”** button. Click on the **“Browse”** button and navigate to the following directory:
X:\Driver\module name (where X is the drive letter designator for the CD-ROM drive).

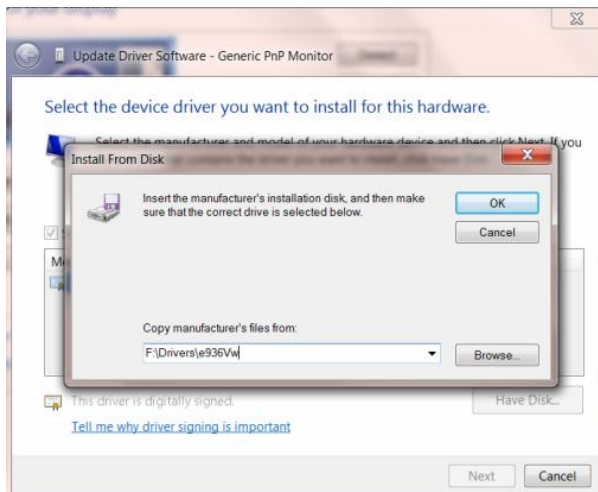

11. Select the **“xxx.inf”** file and click the **“Open”** button. Click the **“OK”** button.

12. Select your monitor model and click the **“Next”** button. The files will be copied from the CD to your hard disk drive.

13. Close all open windows and remove the CD.

14. Restart the system. The system will automatically select the maximum refresh rate and corresponding Color Matching Profiles.

Windows 8

1. Start Windows® 8
2. Right click and click **All apps** at the bottom-right of the screen.

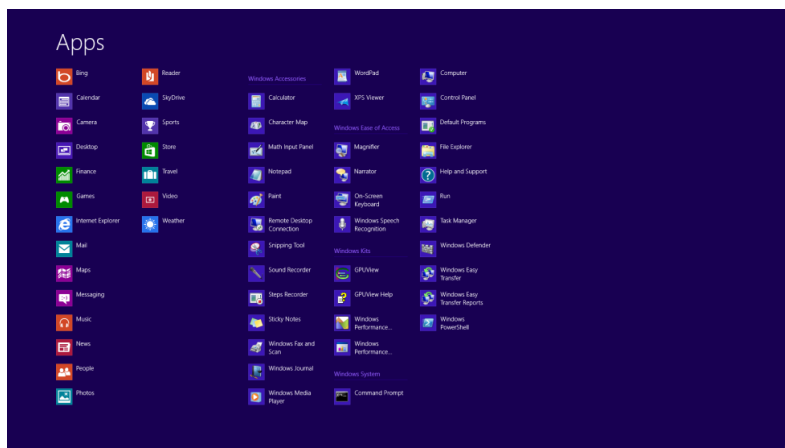
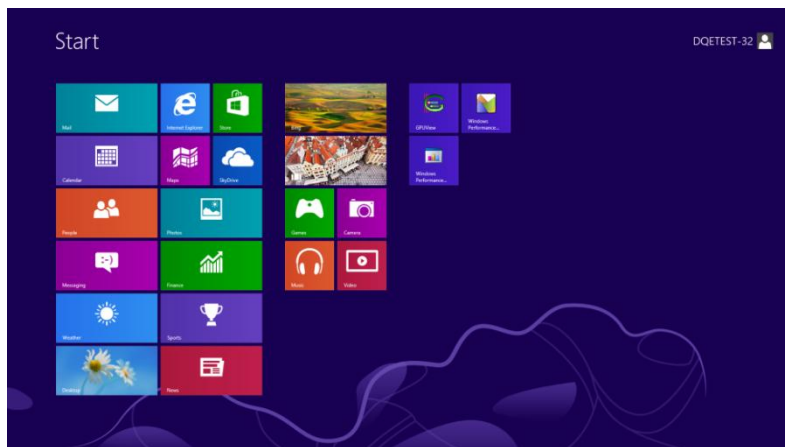

3. Click on the “Control panel” icon
4. Set the “View by” to “Large icons” or “Small icons”.

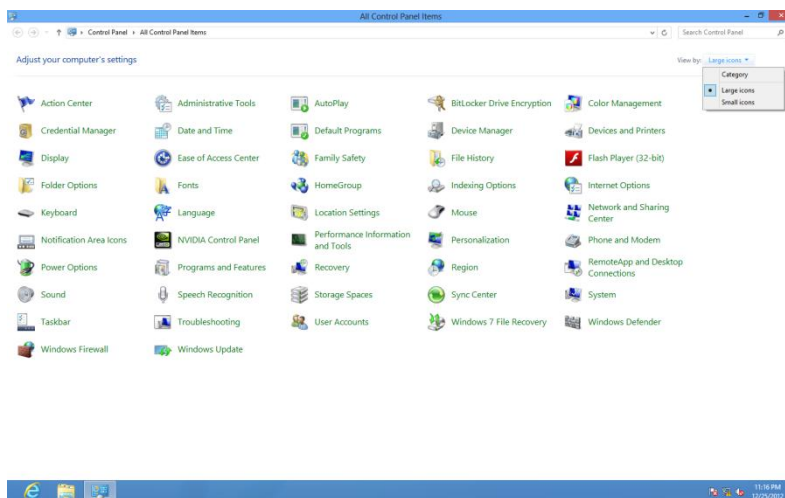

5. Click on the “Display” icon.

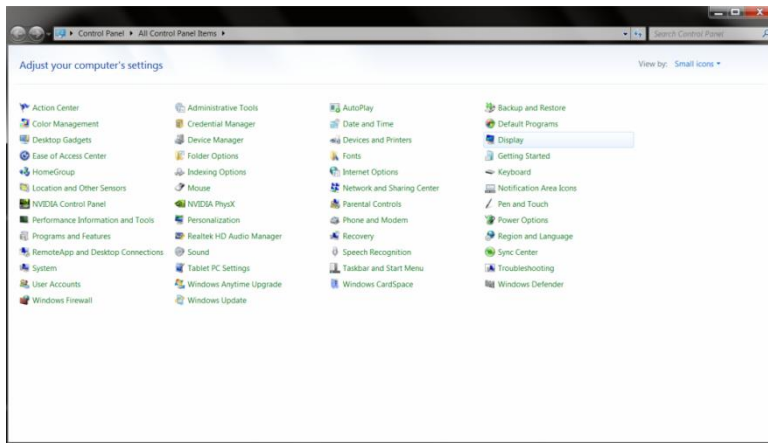

6. Click on the **“Change display settings”** button.

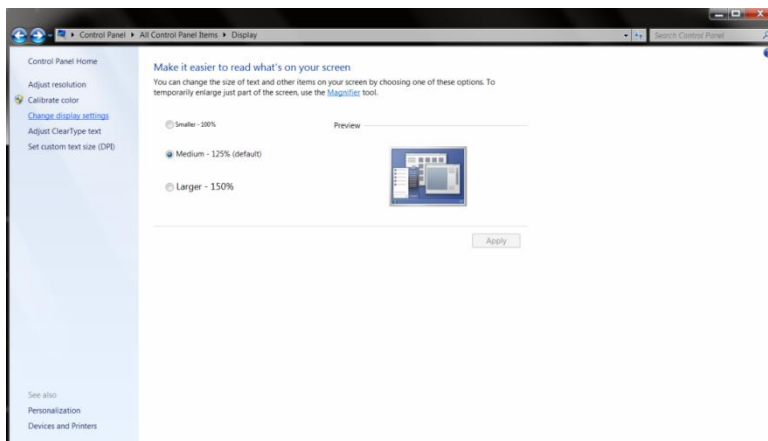

7. Click the **“Advanced Settings”** button.

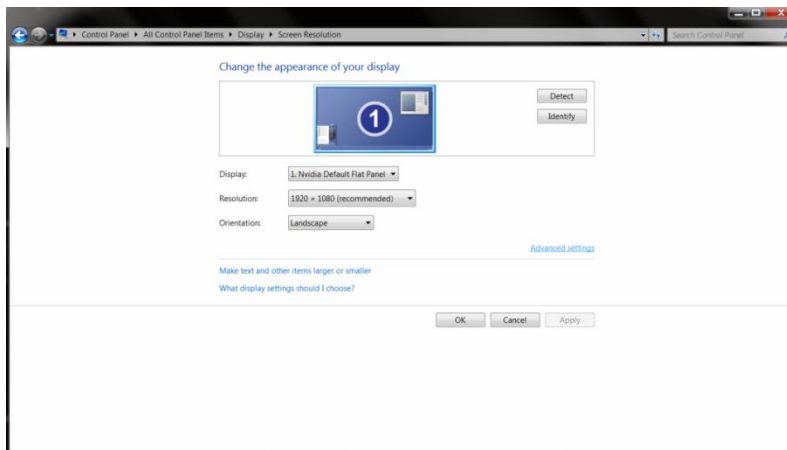

8. Click the **“Monitor”** tab and then click the **“Properties”** button.

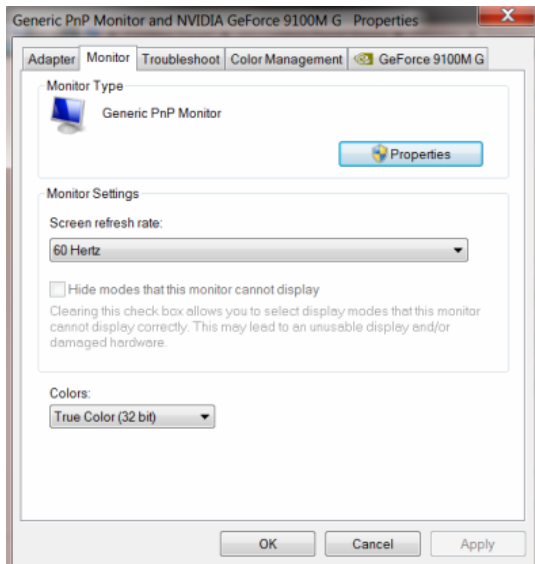

9. Click the **“Driver”** tab.

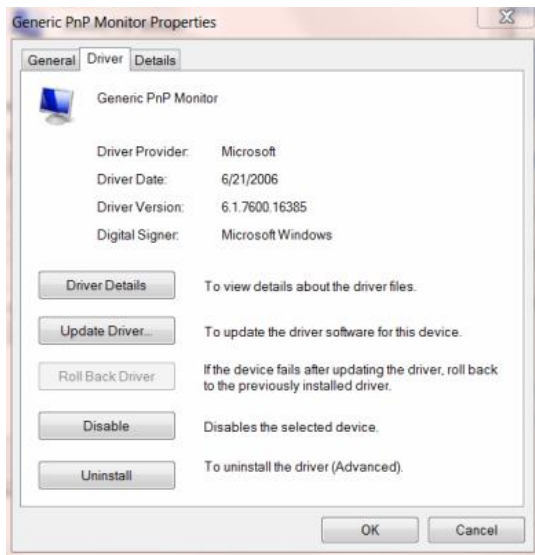

10. Open the **“Update Driver Software-Generic PnP Monitor”** window by clicking on **“Update Driver...”** and then click the **“Browse my computer for driver software”** button.

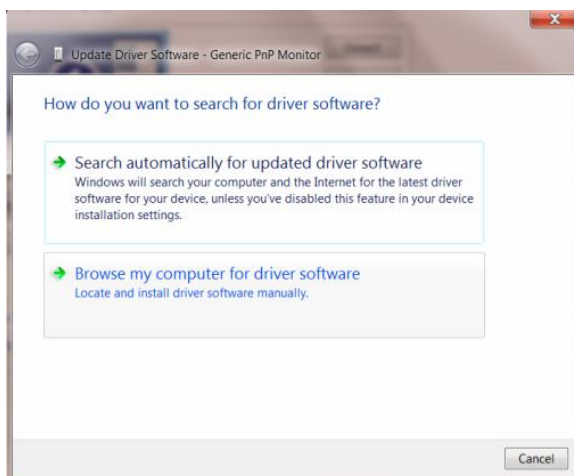

11. Select **“Let me pick from a list of device drivers on my computer”**.

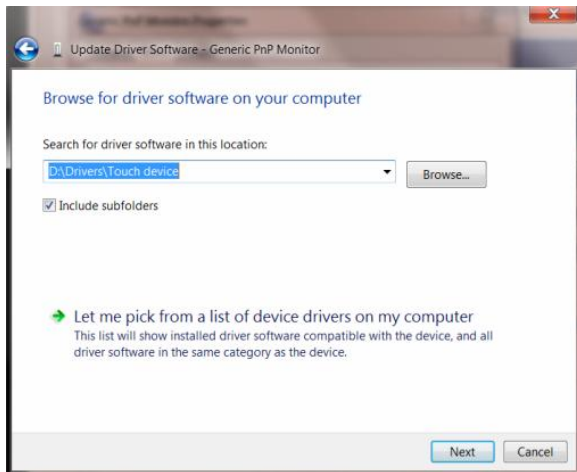

12. Click the **“Have Disk”** button. Click on the **“Browse”** button and navigate to the following directory:
X:\Driver\module name (where X is the drive letter designator for the CD-ROM drive).

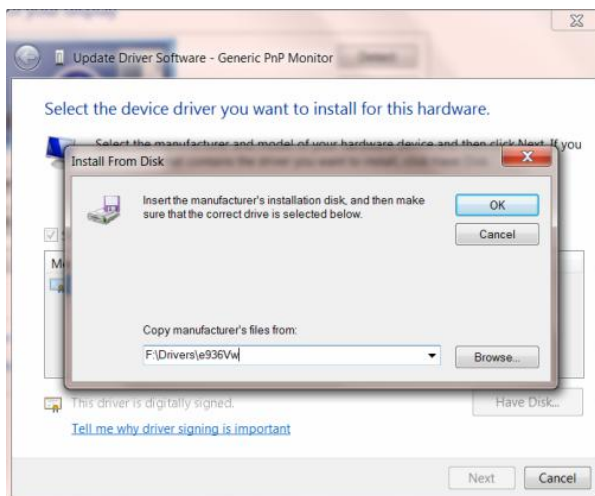

13. Select the **“xxx.inf”** file and click the **“Open”** button. Click the **“OK”** button.
14. Select your monitor model and click the **“Next”** button. The files will be copied from the CD to your hard disk drive.
15. Close all open windows and remove the CD.
16. Restart the system. The system will automatically select the maximum refresh rate and corresponding Color Matching Profiles.

i-Menu



Welcome to “i-Menu” software by AOC. i-Menu makes it easy to adjust your monitor display setting by using on screen menus instead of the OSD button on the monitor. To complete installation, please follow the installation guide.



e-Saver



Welcome to use AOC e-Saver monitor power management software! The AOC e-Saver features Smart Shutdown functions for your monitors, allows your monitor to timely shutdown when PC unit is at any status (On, Off, Sleep or Screen Saver); the actual shutdown time depends on your preferences (see example below).

Please click on "driver/e-Saver/setup.exe" to start installing the e-Saver software, follow the install wizard to complete software installation.

Under each of the four PC status, you may choose from the pull-down menu the desired time (in minutes) for your monitor to automatically shutdown. The example above illustrated:

- 1) The monitor will never shutdown when the PC is powered on.
- 2) The monitor will automatically shutdown 5 minutes after the PC is powered off.
- 3) The monitor will automatically shutdown 10 minutes after the PC is in sleep/stand-by mode.
- 4) The monitor will automatically shutdown 20 minutes after the screen saver appears.

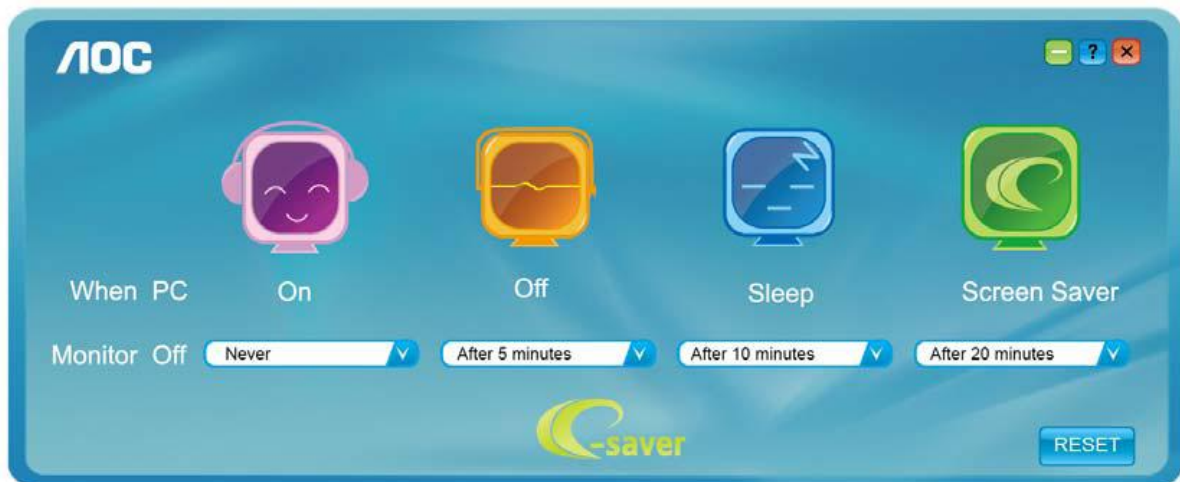

You can click "RESET" to set the e-Saver to its default settings like below.

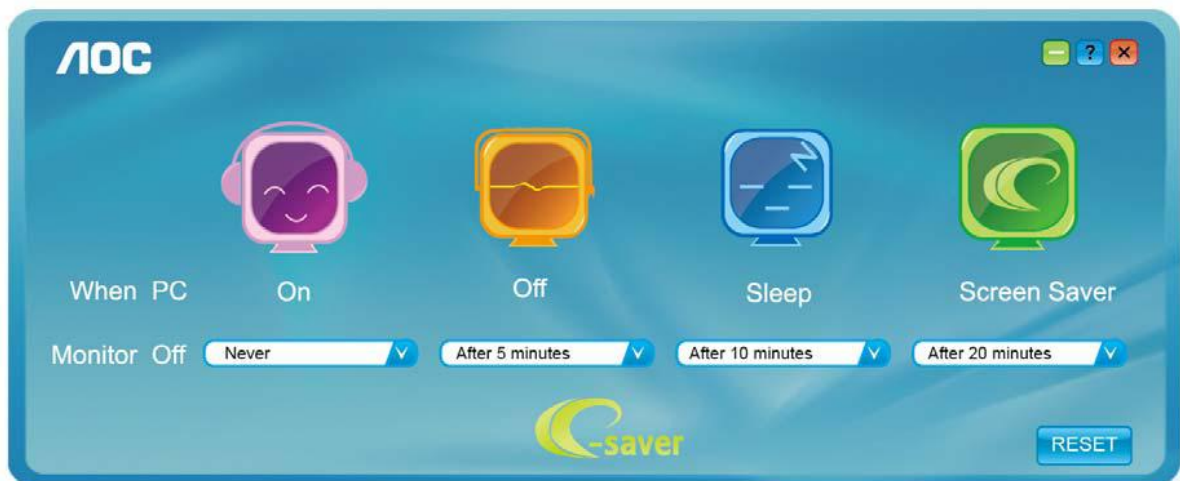

Screen+



Welcome to "Screen+" software by AOC, Screen+ software is a desktop screen splitting tool, it splits the desktop into different panes, each pane displays a different window. You only need to drag the window to a corresponding pane, when you want to access it. It supports multiple monitor display to make your task easier. Please follow the

installation software to install it.



Troubleshoot

| Problem & Question | Possible Solutions |
|----------------------------|--|
| Power LED Is Not ON | Make sure the power button is ON and the Power Cord is properly connected to a grounded power outlet and to the monitor. |

| | |
|--|---|
| <p>No images on the screen</p> | <ul style="list-style-type: none"> • Is the power cord connected properly? Check the power cord connection and power supply. • Is the cable connected correctly? (Connected using the D-sub cable) Check the DB-15 cable connection. (Connected using the DVI cable) Check the DVI cable connection. <p>* DVI input is not available on every model.</p> <ul style="list-style-type: none"> • If the power is on, reboot the computer to see the initial screen (the login screen), which can be seen. If the initial screen (the login screen) appears, boot the computer in the applicable mode (the safe mode for Windows ME/XP/2000) and then change the frequency of the video card. (Refer to the Setting the Optimal Resolution) If the initial screen (the login screen) does not appear, contact the Service Center or your dealer. • Can you see "Input Not Supported" on the screen? You can see this message when the signal from the video card exceeds the maximum resolution and frequency that the monitor can handle properly. Adjust the maximum resolution and frequency that the monitor can handle properly. • Make sure the AOC Monitor Drivers are installed. |
| <p>Picture Is Fuzzy & Has Ghosting Shadowing Problem</p> | <p>Adjust the Contrast and Brightness Controls. Press to auto adjust. Make sure you are not using an extension cable or switch box. We recommend plugging the monitor directly to the video card output connector on the back .</p> |
| <p>Picture Bounces, Flickers Or Wave Pattern Appears In The Picture</p> | <p>Move electrical devices that may cause electrical interference as far away from the monitor as possible. Use the maximum refresh rate your monitor is capable of at the resolution your are using.</p> |
| <p>Monitor Is Stuck In Active Off-Mode"</p> | <p>The Computer Power Switch should be in the ON position. The Computer Video Card should be snugly fitted in its slot. Make sure the monitor's video cable is properly connected to the computer. Inspect the monitor's video cable and make sure no pin is bent. Make sure your computer is operational by hitting the CAPS LOCK key on the keyboard while observing the CAPS LOCK LED. The LED should either turn ON or OFF after hitting the CAPS LOCK key.</p> |

| | |
|---|---|
| <p>Missing one of the primary colors (RED, GREEN, or BLUE)</p> | <p>Inspect the monitor's video cable and make sure that no pin is damaged. Make sure the monitor's video cable is properly connected to the computer.</p> |
| <p>Screen image is not centered or sized properly</p> | <p>Adjust H-Position and V-Position or press hot-key (AUTO).</p> |
| <p>Picture has color defects (white does not look white)</p> | <p>Adjust RGB color or select desired color temperature.</p> |
| <p>Horizontal or vertical disturbances on the screen</p> | <p>Use Windows 95/98/2000/ME/XP shut-down mode Adjust CLOCK and FOCUS. Press to auto-adjust.</p> |

Specification

General Specification

| | | |
|------------------------------|-------------------------------|--|
| Panel | Model name | E960SRDA/ E960PRDA/ E960SRD |
| | Driving system | TFT Color LCD |
| | Viewable Image Size | 48.2cm diagonal |
| | Pixel pitch | 0.294mm(H)X0.294mm(V) |
| | Video | R, G, B Analog Interface & Digital Interface |
| | Separate Sync. | H/V TTL |
| | Display Color | 16.7M Colors |
| | Dot Clock | 108MHz |
| Resolution | Horizontal scan range | 30 kHz - 83 kHz |
| | Horizontal scan Size(Maximum) | 376.32mm |
| | Vertical scan range | 50 Hz - 76 Hz |
| | Vertical scan Size(Maximum) | 301.056mm |
| | Optimal preset resolution | 1280x 1024 (60 Hz) |
| | Plug & Play | VESA DDC2B/CI |
| | Input Connector | D-Sub 15pin; DVI 24pin |
| | Input Video Signal | Analog: 0.7Vp-p(standard), 75 OHM, TMDS |
| | Power Source | 100-240V~, 50/60Hz |
| | Power Consumption | Active: 18 W (typical) |
| | | Standby < 0.5 W |
| | Off timer | 0-24 hrs |
| Speakers(E960SRDA/ E960PRDA) | 2WX2 | |
| Physical Characteristics | Connector Type | 15-pin Mini D-Sub ; DVI-D |
| | Signal Cable Type | Detachable |
| Environmental | Temperature: | |
| | Operating | 0° to 40° |
| | Non-Operating | -25° to 55° |
| | Humidity: | |
| | Operating | 10% to 85% (non-condensing) |
| | Non-Operating | 5% to 93% (non-condensing) |

| | | |
|--|--|--|
| Panel | Model name | E2060S _{WN} /E2060S _{WDN} /E2060S _{WDAN} /E2060S _{WDA} / E2060P _{WDA} /E2060S _W /E2060S _{WD} /E2060S _{WDU} |
| | Driving system | TFT Color LCD |
| | Viewable Image Size | 49.5cm diagonal |
| | Pixel pitch | 0.27mm(H)X0.27mm(V) |
| | Video (E2060S _{WDU} /E2060S _{WDN} /E2060S _{WDAN} /E2060S _{WDA} / E2060P _{WDA} /E2060S _{WD}) | R, G, B Analog Interface & Digital Interface |
| | Video (E2060S _W E2060S _{WN}) | R, G, B Analog Interface |
| | Separate Sync. | H/V TTL |
| | Display Color | 16.7M Colors |
| | Dot Clock | 108MHz |
| Resolution | Horizontal scan range | 30 kHz - 83 kHz |
| | Horizontal scan Size(Maximum) | 432mm |
| | Vertical scan range | 50 Hz - 76 Hz |
| | Vertical scan Size(Maximum) | 239.76mm |
| | Optimal preset resolution | 1600x900@60Hz |
| | Plug & Play | VESA DDC2B/CI |
| | Input Connector (E2060S _{WDU} /E2060S _{WDN} /E2060S _{WDAN} /E2060S _{WDA} / E2060P _{WDA} /E2060S _{WD}) | D-Sub 15pin; DVI 24pin |
| | Input Connector (E2060S _W E2060S _{WN}) | D-Sub 15pin; |
| | Input Video Signal | Analog: 0.7Vp-p(standard), 75 OHM, TMDS |
| | Power Source | 100-240V~, 50/60Hz |
| | Power Consumption | Active: 23 W (typical) 35 W (typical) (E2060S _{WDU}) |
| | | Standby < 0.5 W Standby < 1 W (E2060S _{WDU}) |
| Off timer | 0-24 hrs | |
| Speakers(E2060S _{WDU} /E2060S _{WDA} / E2060P _{WDA} /E2060S _{WDAN}) | 2WX2 | |
| Physical Characteristics | Connector Type (E2060S _{WDU} /E2060S _{WDN} /E2060S _{WDAN} /E2060S _{WDA} / E2060P _{WDA} /E2060S _{WD}) | 15-pin Mini D-Sub DVI-D |
| | Connector Type (E2060S _W /E2060S _{WN}) | 15-pin Mini D-Sub |
| | Signal Cable Type | Detachable |
| Environmental | Temperature: | |
| | Operating | 0° to 40° |
| | Non-Operating | -25° to 55° |
| | Humidity: | |

| | |
|---------------|-----------------------------|
| Operating | 10% to 85% (non-condensing) |
| Non-Operating | 5% to 93% (non-condensing) |

| | | |
|--------------------------|--|---|
| Panel | Model name | E2260PHU/E2260SHU/E2260PDA/E2260SDA/E2260SD/E2260PQ |
| | Driving system | TFT Color LCD |
| | Viewable Image Size | 55.86 cm diagonal |
| | Pixel pitch | 0.282mm(H) x 0.282mm(V) |
| | Video (E2260PQ) | R, G, B Analog Interface & Digital Interface & DP Interface |
| | Video (E2260PHU/E2260SHU) | R, G, B Analog Interface & Digital Interface & HDMI Interface |
| | Video (E2260PDA/E2260SDA/E2260SD) | R, G, B Analog Interface & Digital Interface |
| | Separate Sync. | H/V TTL |
| | Display Color | 16.7M Colors |
| | Dot Clock | 146 MHz |
| Resolution | Horizontal scan range | 30 kHz - 83 kHz |
| | Horizontal scan Size(Maximum) | 473.76mm |
| | Vertical scan range | 50Hz - 76 Hz |
| | Vertical scan Size(Maximum) | 296.1mm |
| | Optimal preset resolution | 1680 x 1050@60Hz |
| | Plug & Play | VESA DDC2B/CI |
| | Input connector (E2260PQ) | D-Sub 15pin DVI 24pin, DP |
| | Input connector (E2260PHU/E2260SHU) | D-Sub 15pin DVI 24pin, HDMI |
| | Input connector (E2260PDA/E2260SDA/E2260SD) | D-Sub 15pin DVI 24pin |
| | Input Video Signal | Analog: 0.7Vp-p(standard), 75 OHM, TMDS |
| | Power Source | 100-240V~, 50/60Hz |
| | Power Consumption | Active: 38W(typical) Standby < 0.5 W |
| | Off timer | 0-24 hrs |
| | Speakers(E2260PDA/E2260SDA E2260PHU/E2260SHU/E2260PQ) | 2W x 2 |
| Physical Characteristics | Connector type (E2260PHU/E2260SHU) | 15-pin Mini D-Sub DVI-D,HDMI |
| | Connector type (E2260PQ) | 15-pin Mini D-Sub DVI-D,DP |
| | Connector type (E2260PDA/E2260SDA/E2260SD) | 15-pin Mini D-Sub DVI-D |
| | Signal Cable Type | Detachable |
| Environmental | Temperature: | |
| | Operating | 0° to 40° |
| | Non-Operating | -25°to 55° |

| | | |
|--|---------------|-----------------------------|
| | Humidity: | |
| | Operating | 10% to 85% (non-condensing) |
| | Non-Operating | 5% to 93% (non-condensing) |

| | | | | |
|--------------------------|-------------------------------|---|-----------------------------|--|
| Panel | Model name | E2460PWHU / E2460SWHU | | |
| | Driving system | TFT Color LCD | | |
| | Viewable Image Size | 59.8 cm diagonal | | |
| | Pixel pitch | 0.2715 mm(H) x 0.2715 mm(V) | | |
| | Video | R, G, B Analog Interface & Digital Interface & HDMI Interface | | |
| | Separate Sync | H/V TTL | | |
| | Display Color | 16.7M Colors | | |
| | Dot Clock | 170 MHz | | |
| Resolution | Horizontal scan range | 30 kHz - 83 kHz | | |
| | Horizontal scan Size(Maximum) | 521.28 mm | | |
| | Vertical scan range | 50 Hz - 76 Hz | | |
| | Vertical scan Size(Maximum) | 293.22 mm | | |
| | Optimal preset resolution | 1920 x 1080 (60 Hz) | | |
| | Plug & Play | VESA DDC2B/C1 | | |
| | Input Connector | D-Sub 15pin DVI 24pin, HDMI | | |
| | Input Video Signal | Analog: 0.7Vp-p(standard), 75 OHM, TMDS | | |
| | Power Source | 100-240V~, 50/60Hz | | |
| | Power Consumption | Active: 42 W (typical) | | |
| | | Standby < 0.5 W | | |
| Off timer | 0~24 hrs | | | |
| Speakers | 2W x 2 | | | |
| Physical Characteristics | Connector Type | 15-pin Mini D-Sub DVI-D,HDMI | | |
| | Signal Cable Type | Detachable | | |
| Environmental | Temperature | Operating | 0° to 40° | |
| | | Non-Operating | -25°to 55° | |
| | Humidity | Operating | 10% to 85% (non-condensing) | |
| | | Non-Operating | 5% to 93% (non-condensing) | |

| | | | | |
|--------------------------|-------------------------------|---|-----------------------------|--|
| Panel | Model name | E2460S _{HU} / E2460P _{HU} | | |
| | Driving system | TFT Color LCD | | |
| | Viewable Image Size | 61.0 cm diagonal | | |
| | Pixel pitch | 0. 27675 mm(H) x 0. 27675 mm(V) | | |
| | Video | R, G, B Analog Interface & Digital Interface & HDMI Interface | | |
| | Separate Sync | H/V TTL | | |
| | Display Color | 16.7M Colors | | |
| | Dot Clock | 170 MHz | | |
| Resolution | Horizontal scan range | 30 kHz - 83 kHz | | |
| | Horizontal scan Size(Maximum) | 531.36 mm | | |
| | Vertical scan range | 55 Hz - 76 Hz | | |
| | Vertical scan Size(Maximum) | 298.89 mm | | |
| | Optimal preset resolution | 1920 x 1080 (60 Hz) | | |
| | Plug & Play | VESA DDC2B/CI | | |
| | Input Connector | D-Sub 15pin DVI 24pin, HDMI | | |
| | Input Video Signal | Analog: 0.7Vp-p(standard), 75 OHM, TMDS | | |
| | Power Source | 100-240V~, 50/60Hz | | |
| | Power Consumption | Active: | 42 W (typical) | |
| | | Standby: | < 0.5 W | |
| Off timer | 0~24 hrs | | | |
| Speakers | 2W x 2 | | | |
| Physical Characteristics | Connector Type | 15-pin Mini D-Sub DVI-D,HDMI | | |
| | Signal Cable Type | Detachable | | |
| Environmental | Temperature | Operating | 0° to 40° | |
| | | Non-Operating | -25°to 55° | |
| | Humidity | Operating | 10% to 85% (non-condensing) | |
| | | Non-Operating | 5% to 93% (non-condensing) | |

Preset Display Modes

19R

| STANDARD | RESOLUTION | HORIZONTAL FREQUENCY(kHZ) | VERTICAL FREQUENCY(Hz) |
|----------|----------------|------------------------------|---------------------------|
| VGA | 640x480@60Hz | 31.469 | 59.940 |
| VGA | 640x480@67Hz | 35.000 | 66.667 |
| VGA | 640x480@72Hz | 37.861 | 72.809 |
| VGA | 640x480@75Hz | 37.500 | 75.000 |
| Dos-mode | 720x400@70Hz | 31.469 | 70.087 |
| SVGA | 800x600@56Hz | 35.156 | 56.250 |
| SVGA | 800x600@60Hz | 37.879 | 60.317 |
| SVGA | 800x600@72Hz | 48.077 | 72.188 |
| SVGA | 800x600@75Hz | 46.875 | 75.000 |
| SVGA | 832x624@75Hz | 49.725 | 74.551 |
| XGA | 1024x768@60Hz | 48.363 | 60.004 |
| XGA | 1024x768@70Hz | 56.476 | 70.069 |
| XGA | 1024x768@75Hz | 60.023 | 75.029 |
| SXGA | 1280x1024@60Hz | 63.981 | 60.020 |
| SXGA | 1280x1024@75Hz | 79.976 | 75.025 |

19.5w

| STAND | RESOLUTION | HORIZONTAL FREQUENCY(kHZ) | VERTICAL FREQUENCY(Hz) |
|----------|----------------|------------------------------|---------------------------|
| VGA | 640x480 @60Hz | 31.469 | 59.940 |
| VGA | 640x480 @67Hz | 35.000 | 66.667 |
| VGA | 640x480 @72Hz | 37.861 | 72.809 |
| VGA | 640x480 @75Hz | 37.500 | 75.000 |
| Dos-mode | 720x400 @70Hz | 31.469 | 70.087 |
| SVGA | 800x600 @56Hz | 35.156 | 56.250 |
| SVGA | 800x600 @60Hz | 37.879 | 60.317 |
| SVGA | 800x600 @72Hz | 48.077 | 72.188 |
| SVGA | 800x600@75Hz | 46.875 | 75.000 |
| SVGA | 832x624 @75Hz | 49.725 | 74.500 |
| XGA | 1024x768 @60Hz | 48.363 | 60.004 |
| XGA | 1024x768 @70Hz | 56.476 | 70.069 |
| XGA | 1024x768 @75Hz | 60.023 | 75.029 |
| SXGA | 1280x1024@60Hz | 63.981 | 60.020 |
| SXGA | 1280x1024@75Hz | 79.976 | 75.025 |

| | | | |
|-------|----------------|--------|--------|
| WSXGA | 1600x900 @60Hz | 55.540 | 59.978 |
|-------|----------------|--------|--------|

22w

| STANDARD | RESOLUTION | HORIZONTAL FREQUENCY(kHZ) | VERTICAL FREQUENCY(Hz) |
|-----------------|-------------------|--------------------------------------|-----------------------------------|
| VGA | 640x480@60Hz | 31.469 | 59.940 |
| VGA | 640x480@72Hz | 37.861 | 72.809 |
| VGA | 640x480@75Hz | 37.500 | 75.000 |
| SVGA | 800x600@56Hz | 35.156 | 56.250 |
| SVGA | 800x600@60Hz | 37.879 | 60.317 |
| SVGA | 800x600@72Hz | 48.077 | 72.188 |
| SVGA | 800x600@75Hz | 46.875 | 75.000 |
| XGA | 1024x768@60Hz | 48.363 | 60.004 |
| XGA | 1024x768@75Hz | 60.023 | 75.029 |
| SXGA | 1280x1024@60Hz | 63.981 | 60.020 |
| SXGA | 1280x1024@75Hz | 79.976 | 75.025 |
| WXGA | 1440x900@60Hz | 55.935 | 59.887 |
| WSXGA | 1680x1050@60Hz | 65.290 | 59.954 |
| IBM-MODE DOS | 720x400@70Hz | 31.469 | 70.087 |
| MAC MODE VGA | 640x480@67Hz | 35.000 | 66.667 |
| MAC MODE SVGA | 832x624@75Hz | 49.725 | 74.551 |

| STANDARD | RESOLUTION | HORIZONTAL FREQUENCY(KHZ) | VERTICAL FREQUENCY(Hz) |
|----------|-----------------|------------------------------|---------------------------|
| VGA | 640x480 @60Hz | 31.469 | 59.940 |
| VGA | 640x480 @67Hz | 35.000 | 66.667 |
| VGA | 640x480 @72Hz | 37.861 | 72.809 |
| VGA | 640x480 @75Hz | 37.500 | 75.000 |
| Dos-mode | 720x400 @70Hz | 31.469 | 70.087 |
| SVGA | 800x600 @56Hz | 35.156 | 56.250 |
| SVGA | 800x600 @60Hz | 37.879 | 60.317 |
| SVGA | 800x600 @72Hz | 48.077 | 72.188 |
| SVGA | 800x600 @75Hz | 46.875 | 75.000 |
| SVGA | 832x624 @75Hz | 49.725 | 74.551 |
| XGA | 1024x768 @60Hz | 48.363 | 60.004 |
| XGA | 1024x768 @70Hz | 56.476 | 70.069 |
| XGA | 1024x768 @75Hz | 60.023 | 75.029 |
| XGA | 1024x768 @75Hz | 60.241 | 74.927 |
| *** | 1280x960 @60Hz | 60.000 | 60.000 |
| SXGA | 1280x1024 @60Hz | 63.981 | 60.02 |
| SXGA | 1280x1024 @75Hz | 79.976 | 75.025 |
| WXGA+ | 1440x900 @60Hz | 55.935 | 59.887 |
| WSXGA | 1680x1050 @60Hz | 65.290 | 59.954 |
| HD | 1920x1080@60Hz | 67.500 | 60.000 |

| STAND | RESOLUTION | Horizontal | Vertical |
|--------|----------------|------------|----------|
| VGA | 640x480@60Hz | 31.469 | 59.94 |
| | 640x480@72Hz | 37.861 | 72.809 |
| | 640x480@75Hz | 37.5 | 75 |
| SVGA | 800x600@56Hz | 35.156 | 56.25 |
| | 800x600@60Hz | 37.879 | 60.317 |
| | 800x600@72Hz | 48.077 | 72.188 |
| | 800x600@75Hz | 46.875 | 75 |
| XGA | 1024x768@60Hz | 48.363 | 60.004 |
| | 1024x768@70Hz | 56.476 | 70.069 |
| | 1024x768@75Hz | 60.023 | 75.029 |
| SXGA | 1280x1024@60Hz | 63.981 | 60.02 |
| SXGA | 1280x1024@75Hz | 79.976 | 75.025 |
| WXGA | 1440x900@60Hz | 55.935 | 59.887 |
| WSXGA+ | 1680x1050@60Hz | 65.29 | 59.954 |
| HDTV | 1920x1080@60Hz | 67.5 | 60 |
| DOS | 720x400@70Hz | 31.469 | 70.087 |
| VGA | 640x480@67Hz | 35 | 66.667 |
| SVGA | 832x624@75Hz | 49.725 | 74.551 |

Pin Assignments

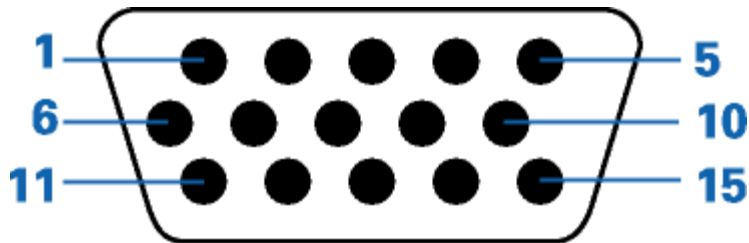

| Pin Number | 15-Pin Side of the Signal Cable |
|------------|---------------------------------|
| 1 | Video-Red |
| 2 | Video-Green |
| 3 | Video-Blue |
| 4 | N.C. |
| 5 | Detect Cable |
| 6 | GND-R |
| 7 | GND-G |
| 8 | GND-B |
| 9 | +5V |
| 10 | Ground |
| 11 | N.C. |
| 12 | DDC-Serial data |
| 13 | H-sync |
| 14 | V-sync |
| 15 | DDC-Serial clock |

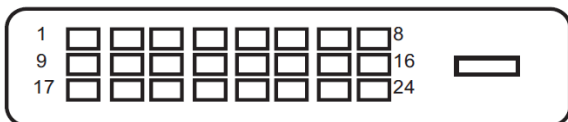

| Pin Number | 24-Pin Color Display Signal Cable | Pin Number | 24-Pin Color Display Signal Cable |
|------------|-----------------------------------|------------|-----------------------------------|
| 1 | TMDS data 2- | 13 | TMDS data 3+ |
| 2 | TMDS data 2+ | 14 | +5V Power |
| 3 | TMDS data 2/4 Shield | 15 | Ground (for+5V) |
| 4 | TMDS data 4- | 16 | Hot Plug Detect |
| 5 | TMDS data 4+ | 17 | TMDS data 0- |
| 6 | DDC Clock | 18 | TMDS data 0+ |
| 7 | DDC Data | 19 | TMDS data 0/5 Shield |
| 8 | N.C. | 20 | TMDS data 5- |
| 9 | TMDS data 1- | 21 | TMDS data 5+ |
| 10 | TMDS data 1+ | 22 | TMDS Clock Shield |
| 11 | TMDS data 1/3 Shield | 23 | TMDS Clock + |
| 12 | TMDS data 3- | 24 | TMDS Clock - |



| Pin No. | Signal Name | Pin No. | Signal Name | Pin No. | Signal Name |
|---------|--------------------|---------|--------------------------|---------|-----------------|
| 1 | TMDS Data 2+ | 9 | TMDS Data 0 | 17 | DDC/CEC Ground |
| 2 | TMDS Data 2 Shield | 10 | TMDS Clock + | 18 | +5V Power |
| 3 | TMDS Data 2 | 11 | TMDS Clock Shield | 19 | Hot Plug Detect |
| 4 | TMDS Data 1+ | 12 | TMDS Clock | | |
| 5 | TMDS Data 1Shield | 13 | CEC | | |
| 6 | TMDS Data 1 | 14 | Reserved (N.C. on device | | |
| 7 | TMDS Data 0+ | 15 | SCL | | |
| 8 | TMDS Data 0 Shield | 16 | SDA | | |

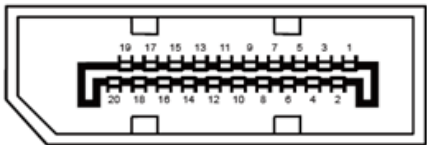

| Pin No. | Signal Name | Pin No. | Signal Name |
|---------|---------------|---------|-----------------|
| 1 | ML_Lane 3 (n) | 11 | GND |
| 2 | GND | 12 | ML_Lane 0 (p) |
| 3 | ML_Lane 3 (p) | 13 | CONFIG1 |
| 4 | ML_Lane 2 (n) | 14 | CONFIG2 |
| 5 | GND | 15 | AUX_CH(p) |
| 6 | ML_Lane 2 (p) | 16 | GND |
| 7 | ML_Lane 1 (n) | 17 | AUX_CH(n) |
| 8 | GND | 18 | Hot Plug Detect |
| 9 | ML_Lane 1 (p) | 19 | Return DP_PWR |
| 10 | ML_Lane 0 (n) | 20 | DP_PWR |

Plug and Play

Plug & Play DDC2B Feature

This monitor is equipped with VESA DDC2B capabilities according to the VESA DDC STANDARD. It allows the monitor to inform the host system of its identity and, depending on the level of DDC used, communicate additional information about its display capabilities.

The DDC2B is a bi-directional data channel based on the I2C protocol. The host can request EDID information over the DDC2B channel.

Regulation

FCC Notice

FCC Class B Radio Frequency Interference Statement WARNING: (FOR FCC CERTIFIED MODELS)

NOTE: This equipment has been tested and found to comply with the limits for a Class B digital device, pursuant to Part 15 of the FCC Rules. These limits are designed to provide reasonable protection against harmful interference in a residential installation. This equipment generates, uses and can radiate radio frequency energy, and if not installed and used in accordance with the instructions, may cause harmful interference to radio communications. However, there is no guarantee that interference will not occur in a particular installation. If this equipment does cause harmful interference to radio or television reception, which can be determined by turning the equipment off and on, the user is encouraged to try to correct the interference by one or more of the following measures:

Reorient or relocate the receiving antenna.

Increase the separation between the equipment and receiver.

Connect the equipment into an outlet on a circuit different from that to which the receiver is connected.

Consult the dealer or an experienced radio/TV technician for help.

NOTICE :

The changes or modifications not expressly approved by the party responsible for compliance could void the user's authority to operate the equipment.

Shielded interface cables and AC power cord, if any, must be used in order to comply with the emission limits.

The manufacturer is not responsible for any radio or TV interference caused by unauthorized modification to this equipment. It is the responsibilities of the user to correct such interference. It is the responsibility of the user to correct such interference.

WEEE Declaration

Disposal of Waste Equipment by Users in Private Household in the European Union.



This symbol on the product or on its packaging indicates that this product must not be disposed of with your other household waste. Instead, it is your responsibility to dispose of your waste equipment by handing it over to a designated collection point for the recycling of waste electrical and electronic equipment. The separate collection and recycling of your waste equipment at the time of disposal will help to conserve natural resources and ensure that it is recycled in a manner that protects human health and the environment. For more information about where you can drop off your waste equipment for recycling, please contact your local city office, your household waste disposal service or the shop where you purchased the product .

WEEE Declaration for India



This symbol on the product or on its packaging indicates that this product must not be disposed of with your other household waste. Instead it is your responsibility to dispose of your waste equipment by handing it over to a designated collection point for the recycling of waste electrical and electronic equipment. The separate collection and recycling of your waste equipment at the time of disposal will help to conserve natural resources and ensure that it is recycled in a manner that protects human health and the environment.

For more information about where you can drop off your waste equipment for recycling in India please visit the below web link.

www.aocindia.com/ewaste.php.

EPA Energy Star



ENERGY STAR® is a U.S. registered mark. As an ENERGY STAR® Partner, AOC International (Europe) BV and Envision Peripherals, Inc. have determined that this product meets the ENERGY STAR® guidelines for energy efficiency.

(FOR EPA CERTIFIED MODELS)

EPEAT Declaration



EPEAT is a system to help purchasers in the public and private sectors evaluate, compare and select desktop computers, notebooks and monitors based on their environmental attributes. EPEAT also provides a clear and consistent set of performance criteria for the design of products, and provides an opportunity for manufacturers to secure market recognition for efforts to reduce the environmental impact of its products.

AOC believes in protecting the environment.

With a key concern for the conservation of natural resources, as well as landfill protection, AOC announces the launch of AOC monitor's packaging recycling program. This program is designed to help you discard of your monitor carton and filler materials properly. If a local recycling center is not available, AOC will recycle the packaging material for you, including foam filler and carton. AOC Display solution will only recycle AOC monitor packaging. Please refer to the following website address:

Only for North and South American, excluding Brazil:

http://us.aoc.com/about/environmental_impact

For Germany:

<http://www.aoc-europe.com/en/service/tco.php>

For Brazil:

http://www.aoc.com.br/2007/php/index.php?req=pagina&pgn_id=134

(FOR EPEAT GOLD CERTIFIED MODELS)

Service

Warranty Statement for Europe

LIMITED THREE-YEAR WARRANTY*

For AOC LCD Monitors sold within Europe, AOC International (Europe) B.V. warrants this product to be free from defects in material and workmanship for a period of Three (3) years after the original date of consumer purchase. During this period, AOC International (Europe) B.V. will, at its option, either repair the defective product with new or rebuilt parts, or replace it with a new or rebuilt product at no charge except as *stated below. In the absent of the proof of purchase, the warranty will start 3 months after the date of manufacturing indicated on the product.

If the product appears to be defective, please contact your local dealer or refer to the service and support section on www.aoc-europe.com for the warranty instructions in your country. The freight cost for the warranty is pre-paid by AOC for the delivery and return. Please ensure you provide a dated proof of purchase along with the product and deliver to the AOC Certified or Authorized Service Center under the following condition:

- Make sure the LCD Monitor is packed in a proper carton box (AOC prefers the original carton box to protects your monitor well enough during transport).
- Put the RMA number on the address label
- Put the RMA number on the shipping carton

AOC International (Europe) B.V. will pay the return shipping charges within one of the countries specified within this warranty statement. AOC International (Europe) B.V. is not responsible for any costs associated with the transportation of product across international borders. This includes the international border within the European Union. If the LCD Monitor is not available for collection when the carrier attends, you will be charged a collection fee.

*** This limited warranty does not cover any losses or damages that occur as a result of:**

- Damages during transport due to improper packaging
- Improper installation or maintenance other than in accordance with AOC's user manual
- Misuse
- Neglect
- Any cause other than ordinary commercial or industrial application
- Adjustment by non-authorized source
- Repair, modification, or installation of options or parts by anyone other than an AOC Certified or Authorized Service Center
- Improper environments like humidity, water damage and dusts
- Damaged by violence, earthquake and terrorist attacks
- Excessive or inadequate heating or air conditioning or electrical powers failures, surges, or other irregularities

This limited warranty does not cover any of the product firmware or hardware that you or any third party have modified or altered; you bear the sole responsibility and liability for any such modifications or alteration.

All AOC LCD Monitors are produced according to the ISO 9241-307 Class 1 pixel policy standards.

If your warranty has expired, you still have access to all available service options, but you will be responsible for the cost of service, including parts, labor, shipping (if any) and applicable taxes. AOC Certified or Authorized Service Center will provide you with an estimate of service costs before receiving your authorization to perform service.

ALL EXPRESS AND IMPLIED WARRANTIES FOR THIS PRODUCT (INCLUDING THE WARRANTIES OF MERCHANTABILITY AND FITNESS FOR A PARTICULAR PURPOSE) ARE LIMITED IN DURATION TO A PERIOD OF THREE (3) YEARS FOR PARTS AND LABOR FROM THE ORIGINAL DATE OF CONSUMER PURCHASE. NO WARRANTIES (EITHER EXPRESSED OR IMPLIED) APPLY AFTER THIS PERIOD. AOC INTERNATIONAL (EUROPE) B.V. OBLIGATIONS AND YOUR REMEDIES HEREUNDER ARE SOLELY AND EXCLUSIVELY AS STATED HERE. AOC INTERNATIONAL (EUROPE) B.V. LIABILITY, WHETHER BASED ON CONTRACT, TORT, WARRANTY, STRICT LIABILITY, OR OTHER THEORY, SHALL NOT EXCEED THE PRICE OF THE INDIVIDUAL UNIT WHOSE DEFECT OR DAMAGE IS THE BASIS OF THE CLAIM. IN NO EVENT SHALL AOC INTERNATIONAL (EUROPE) B.V. BE LIABLE FOR ANY LOSS OF PROFITS, LOSS OF USE OR FACILITIES OR EQUIPMENT, OR OTHER INDIRECT, INCIDENTAL, OR CONSEQUENTIAL DAMAGE. SOME STATES DO NOT ALLOW THE EXCLUSION OR LIMITATION OF INCIDENTAL OR CONSEQUENTIAL DAMAGES, SO THE ABOVE LIMITATION MAY NOT APPLY TO YOU. ALTHOUGH THIS LIMITED WARRANTY GIVES YOU SPECIFIC LEGAL RIGHTS, YOU MAY HAVE OTHER RIGHTS, WHICH MAY VARY FROM COUNTRY TO COUNTRY. THIS LIMITED WARRANTY IS ONLY VALID FOR PRODUCTS PURCHASED IN THE MEMBER COUNTRIES OF THE EUROPEAN UNION.

Information in this document is subject to change without notice. For more information, please visit:

<http://www.aoc-europe.com>

Service

Warranty Statement for Middle East and Africa (MEA)

And

The Commonwealth of Independent States (CIS)

LIMITED ONE to THREE YEARS WARRANTY*

For AOC LCD Monitors sold within the Middle East and Africa (MEA) and the Commonwealth of Independent States (CIS), AOC International (Europe) B.V. warrants this product to be free from defects in material and workmanship for a period of One (1) to Three (3) years from the manufacture date depending on sale country. During this period, AOC International (Europe) B.V. offers a Carry-In (return to Service Center) Warranty Support at an AOC's Authorized Service Center or Dealer and at its option, either repair the defective product with new or rebuilt parts, or replace it with a new or rebuilt product at no charge except as *stated below. As a Standard Policy, the warranty will be calculated from the manufacture date identified from the product ID serial number, but the total warranty will be Fifteen (15) months to Thirty Nine (39) months from MFD (manufacture date) depending on sale country. Warranty will be considered for exceptional cases that are out of warranty as per the product ID serial number and for such exceptional cases; Original Invoice/Proof Of Purchase Receipt is mandatory.

If the product appears to be defective, please contact your AOC authorized dealer or refer to the service and support section on AOC's website for the warranty instructions in your country:

- Egypt: http://aocmonitorap.com/egypt_eng
- CIS Central Asia: <http://aocmonitorap.com/ciscentral>
- Middle East: <http://aocmonitorap.com/middleeast>
- South Africa: <http://aocmonitorap.com/southafrica>
- Saudi Arabia: <http://aocmonitorap.com/saudiarabia>

Please ensure you provide a dated proof of purchase along with the product and deliver to the AOC Authorized Service Center or Dealer under the following condition:

- Make sure the LCD Monitor is packed in a proper carton box (AOC prefers the original carton box to protect your monitor well enough during transport).
- Put the RMA number on the address label
- Put the RMA number on the shipping carton

*** This limited warranty does not cover any losses or damages that occur as a result of:**

- Damages during transport due to improper packaging
- Improper installation or maintenance other than in accordance with AOC's user manual
- Misuse
- Neglect
- Any cause other than ordinary commercial or industrial application
- Adjustment by non-authorized source
- Repair, modification, or installation of options or parts by anyone other than an AOC Certified or Authorized Service Center
- Improper environments like humidity, water damage and dusts
- Damaged by violence, earthquakes and terrorist attacks
- Excessive or inadequate heating or air conditioning or electrical power failures, surges, or other irregularities

This limited warranty does not cover any of the product firmware or hardware that you or any third party have modified or altered; you bear the sole responsibility and liability for any such modifications or alteration.

All AOC LCD Monitors are produced according to the ISO 9241-307 Class 1 pixel policy standards.

If your warranty has expired, you still have access to all available service options, but you will be responsible for the cost of service, including parts, labor, shipping (if any) and applicable taxes. AOC Certified, Authorized Service Center or dealer will provide you with an estimate of service costs before receiving your authorization to perform service.

ALL EXPRESS AND IMPLIED WARRANTIES FOR THIS PRODUCT (INCLUDING THE WARRANTIES OF MERCHANTABILITY AND FITNESS FOR A PARTICULAR PURPOSE) ARE LIMITED IN DURATION TO A PERIOD OF ONE (1) to THREE (3) YEARS FOR PARTS AND LABOR FROM THE ORIGINAL DATE OF CONSUMER PURCHASE. NO WARRANTIES (EITHER EXPRESSED OR IMPLIED) APPLY AFTER THIS PERIOD. AOC INTERNATIONAL (EUROPE) B.V. OBLIGATIONS AND YOUR REMEDIES HEREUNDER ARE SOLELY AND EXCLUSIVELY AS STATED HERE. AOC INTERNATIONAL (EUROPE) B.V. LIABILITY, WHETHER BASED ON CONTRACT, TORT, WARRANTY, STRICT LIABILITY, OR OTHER THEORY, SHALL NOT EXCEED THE PRICE OF THE INDIVIDUAL UNIT WHOSE DEFECT OR DAMAGE IS THE BASIS OF THE CLAIM. IN NO EVENT SHALL AOC INTERNATIONAL (EUROPE) B.V. BE LIABLE FOR ANY LOSS OF PROFITS, LOSS OF USE OR FACILITIES OR EQUIPMENT, OR OTHER INDIRECT, INCIDENTAL, OR CONSEQUENTIAL DAMAGE. SOME STATES DO NOT ALLOW THE EXCLUSION OR LIMITATION OF INCIDENTAL OR CONSEQUENTIAL DAMAGES, SO THE ABOVE LIMITATION MAY NOT APPLY TO YOU. ALTHOUGH THIS LIMITED WARRANTY GIVES YOU SPECIFIC LEGAL RIGHTS, YOU MAY HAVE OTHER RIGHTS, WHICH MAY VARY FROM COUNTRY TO COUNTRY. THIS LIMITED WARRANTY IS ONLY VALID FOR PRODUCTS PURCHASED IN THE MEMBER COUNTRIES OF THE EUROPEAN UNION.

Information in this document is subject to change without notice. For more information, please visit:

<http://www.aocmonitorap.com>

Warranty Statement for North & South America (excluding Brazil)

WARRANTY STATEMENT

for AOC Color Monitors

Including those Sold within North America as Specified

Envision Peripherals, Inc. warrants this product to be free from defects in material and workmanship for a period of three (3) years for parts & labor and one (1) year for CRT Tube or LCD Panel after the original date of consumer purchase. During this period, EPI (EPI is the abbreviation of Envision Peripherals, Inc.) will, at its option, either repair the defective product with new or rebuilt parts, or replace it with a new or rebuilt product at no charge except as *stated below. The parts or product that are replaced become the property of EPI.

In the USA to obtain service under this limited warranty, call EPI for the name of the Authorized Service Center closest to your area. Deliver the product freight pre-paid, along with the dated proof of purchase, to the EPI Authorized Service Center. If you cannot deliver the product in person:

- Pack it in its original shipping container (or equivalent)
- Put the RMA number on the address label
- Put the RMA number on the shipping carton
- Insure it (or assume the risk of loss/damage during shipment)
- Pay all shipping charges

EPI is not responsible for damage to inbound product that was not properly packaged.

EPI will pay the return shipment charges within one of the countries specified within this warranty statement. EPI is not responsible for any costs associated with the transportation of product across international borders. This includes the international borders of the countries within this warranty statements.

In the United States and Canada contact your Dealer or EPI Customer Service, RMA Department at the toll free number (888) 662-9888. Or you can request an RMA Number online at www.aoc.com/na-warranty.

* This limited warranty does not cover any losses or damages that occur as a result of:

- Shipping or improper installation or maintenance
- Misuse
- Neglect
- Any cause other than ordinary commercial or industrial application
- Adjustment by non-authorized source
- Repair, modification, or installation of options or parts by anyone other than an EPI Authorized Service Center
- Improper environment
- Excessive or inadequate heating or air conditioning or electrical power failures, surges, or other irregularities

This three-year limited warranty does not cover any of the product's firmware or hardware that you or any third party have modified or altered; you bear the sole responsibility and liability for any such modification or alteration.

ALL EXPRESS AND IMPLIED WARRANTIES FOR THIS PRODUCT (INCLUDING THE WARRANTIES OF

MERCHANTABILITY AND FITNESS FOR A PARTICULAR PURPOSE) ARE LIMITED IN DURATION TO A PERIOD OF THREE (3) YEARS FOR PARTS AND LABOR AND ONE (1) YEAR FOR CRT TUBE OR LCD PANEL FROM THE ORIGINAL DATE OF CONSUMER PURCHASE. NO WARRANTIES (EITHER EXPRESSED OR IMPLIED) APPLY AFTER THIS PERIOD. IN THE UNITED STATES OF AMERICA, SOME STATES DO NOT ALLOW LIMITATIONS ON HOW LONG AN IMPLIED WARRANTY LASTS, SO THE ABOVE LIMITATIONS MAY NOT APPLY TO YOU.

EPI OBLIGATIONS AND YOUR REMEDIES HEREUNDER ARE SOLELY AND EXCLUSIVELY AS STATED HERE. EPI LIABILITY, WHETHER BASED ON CONTRACT, TORT, WARRANTY, STRICT LIABILITY, OR OTHER THEORY, SHALL NOT EXCEED THE PRICE OF THE INDIVIDUAL UNIT WHOSE DEFECT OR DAMAGE IS THE BASIS OF THE CLAIM. IN NO EVENT SHALL ENVISION PERIPHERALS, INC. BE LIABLE FOR ANY LOSS OF PROFITS, LOSS OF USE OR FACILITIES OR EQUIPMENT OR OTHER INDIRECT, INCIDENTAL, OR CONSEQUENTIAL DAMAGE. IN THE UNITED STATES OF AMERICA, SOME STATES DO NOT ALLOW THE EXCLUSION OR LIMITATION OF INCIDENTAL OR CONSEQUENTIAL DAMAGES. SO THE ABOVE LIMITATION MAY NOT APPLY TO YOU. ALTHOUGH THIS LIMITED WARRANTY GIVES YOU SPECIFIC LEGAL RIGHTS. YOU MAY HAVE OTHER RIGHTS WHICH MAY VARY FROM STATE TO STATE.

In the United States of America, this limited warranty is only valid for Products purchased in the Continental United States, Alaska, and Hawaii.

Outside the United States of America, this limited warranty is only valid for Products purchased in Canada.

Information in this document is subject to change without notice.

For more details, please visit:

USA: <http://us.aoc.com/support/warranty>
ARGENTINA: <http://ar.aoc.com/support/warranty>
BOLIVIA: <http://bo.aoc.com/support/warranty>
CHILE: <http://cl.aoc.com/support/warranty>
COLOMBIA: <http://co.aoc.com/warranty>
COSTA RICA: <http://cr.aoc.com/support/warranty>
DOMINICAN REPUBLIC: <http://do.aoc.com/support/warranty>
ECUADOR: <http://ec.aoc.com/support/warranty>
EL SALVADOR: <http://sv.aoc.com/support/warranty>
GUATEMALA: <http://gt.aoc.com/support/warranty>
HONDURAS: <http://hn.aoc.com/support/warranty>
NICARAGUA: <http://ni.aoc.com/support/warranty>
PANAMA: <http://pa.aoc.com/support/warranty>
PARAGUAY: <http://py.aoc.com/support/warranty>
PERU: <http://pe.aoc.com/support/warranty>
URUGUAY: <http://pe.aoc.com/warranty>
VENEZUELA: <http://ve.aoc.com/support/warranty>
IF COUNTRY NOT LISTED: <http://latin.aoc.com/warranty>

TCO DOCUMENT

Congratulations!

This product is designed for both you and the planet!



TCO Development works for sustainable IT - manufacture, use and recycling of IT products reflecting environmental, social and economic responsibility.

TCO Certified is a third party verified program, where every product model is tested by an accredited impartial test laboratory. TCO

Certified represents one of the toughest certifications for ICT products worldwide.

Some of the Usability features of TCO Certified Displays:

- Visual Ergonomics for image quality is tested to ensure top performance and reduce sight and strain problems. Important parameters are Resolution, Luminance, Contrast, Reflection and Colour characteristics
- Products are tested according to rigorous safety standards at impartial laboratories
- Electric and magnetic fields emissions as low as normal household background levels
- Workload ergonomics to ensure a good physical environment

Some of the Environmental features of TCO Certified Displays:

- Production facilities have an Environmental Management System (EMAS or ISO 14001)
- Low energy consumption to minimize climate impact
- Restrictions on Chlorinated and Brominated flame retardants, plasticizers, plastics and heavy metals such as cadmium, mercury and lead (RoHS compliance)
- Both product and product packaging is prepared for recycling
- The brand owner offers take-back options

Corporate Social Responsibility

- The brand owner demonstrates the product is manufactured under working practices that promote good labour relations and working conditions.

The Criteria Document can be downloaded from our web site. The criteria included in this label have been developed by TCO Development in co-operation with scientists, experts, users as well as manufacturers all over the world. Since the end of the 1980s TCO has been involved in influencing the development of IT equipment in a more user and environmentally friendly direction. Our ICT product labeling system began in 1992 and is now requested by users and ICT-manufacturers all over the world.

For more information, please visit
www.tcodevelopment.com

TCO Certified Document for Displays version: 2.3



Technology for you and the planet

(FOR TCO CERTIFIED MODELS)

AOC Pixel Policy ISO 9241-307 Class 1

July 25th, 2013

AOC strives to deliver the highest quality products. We use some of the industry's most advanced manufacturing processes and practice stringent quality control. However, pixel or sub pixel defects on the TFT monitor panels used in flat panel monitors are sometimes unavoidable. No manufacturer can guarantee that all panels will be free from pixel defects, but AOC guarantees that any monitor with an unacceptable number of defects will be repaired or replaced under warranty. This Pixel Policy explains the different types of pixel defects and defines acceptable defect levels for each type. In order to qualify for repair or replacement under warranty, the number of pixel defects on a TFT monitor panel must exceed these acceptable levels.

Pixels and Sub Pixel Definition

A pixel, or picture element, is composed of three sub pixels in the primary colors of red, green and blue. When all sub pixels of pixel are lit, the three colored sub pixel together appear as a single white pixel. When all are dark, the three colored sub pixels together appear as a single black pixel.

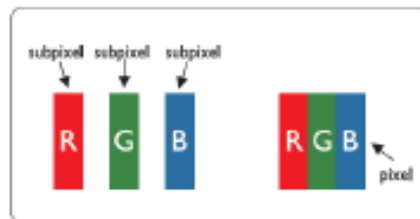

Types of Pixel Defects

- Bright Dot Defects: the monitor displays a dark pattern, sub pixels or pixels are always lit or “on”
- Black Dot Defects: the monitor displays a light pattern, sub pixels or pixels are always dark or “off”

| ISO 9241-307 Pixel Defect Class | Defect Type 1 Bright Pixel | Defect Type 2 Black Pixel | Defect Type 3 Bright Sub pixel | Defect Type 4 Black Sub pixel |
|------------------------------------|-------------------------------|------------------------------|-----------------------------------|----------------------------------|
| Class 1 | 1 | 1 | 2 1 0 | + + + |
| | | | | 1 3 5 |

AOC International (Europe) B.V.