

Always there to help you

Register your product and get support at
www.philips.com/support



HTB5520
HTB5550
HTB5580

Quick start guide

PHILIPS

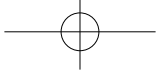

- EN** Before using your product, read all accompanying safety information
- CS** Před použitím produktu si přečtěte doprovodné bezpečnostní informace
- DA** Læs alle medfølgende sikkerhedsoplysninger, inden du tager produktet i brug
- DE** Lesen Sie vor Verwendung dieses Produkts alle begleitenden Sicherheitsinformationen
- EL** Πριν χρησιμοποιήσετε το προϊόν, διαβάστε όλες τις παρεχόμενες πληροφορίες ασφάλειας
- ES** Antes de usar el producto, lea toda la información de seguridad adjunta
- FI** Lue kaikki turvallisustiedot ennen tuotteen käyttöä
- FR** Avant d'utiliser votre produit, lisez l'intégralité des consignes de sécurité jointes
- HU** A termék használatá előtt alaposan olvassa el a mellékelt biztonsági tudnivalókat

- IT** Prima di utilizzare il prodotto, leggere tutte le relative informazioni sulla sicurezza
- NL** Lees voordat u het product gaat gebruiken eerst alle bijbehorende veiligheidsinformatie
- NO** Lees voordat u het product gaat gebruiken eerst alle bijbehorende veiligheidsinformatie
- PL** Przed rozpoczęciem korzystania z produktu należy zapoznać się z informacjami dotyczącymi bezpieczeństwa
- PT** Antes de utilizar o produto, leia todas as informações de segurança que o acompanham
- RO** Înainte de a utiliza acest produs, citiți toate informațiile de siguranță care îl însoțesc
- SK** Pred použitím produktu si prečítajte všetky sprievodné bezpečnostné informácie maklumat keselamatan yang disertakan
- SV** Innan du använder produkten ska du läsa all tillhörande säkerhetsinformation
- TR** Ürününüzü kullanmadan önce ilgili tüm güvenlik bilgilerini okuyun



HTB5520

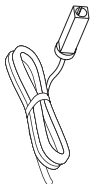
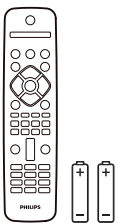
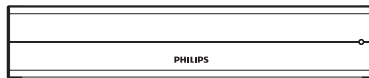
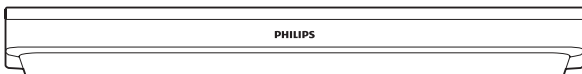

FM Antenna

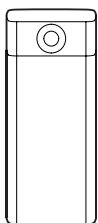
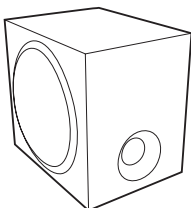
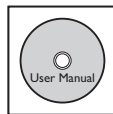
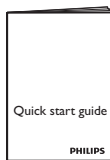

2x



2x

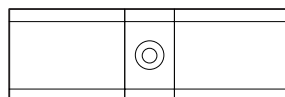

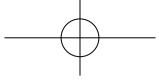

HTB5550

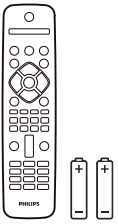
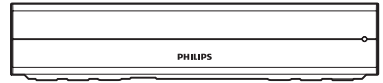
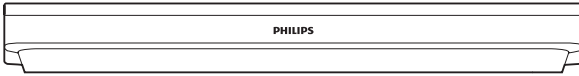

FM Antenna



Quick start guide

PHILIPS

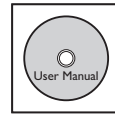

User Manual

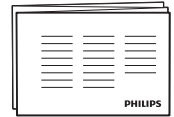

PHILIPS

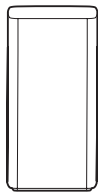
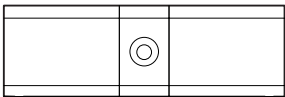
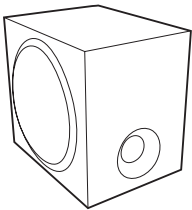

2x



2x



2x



8x



2x

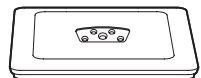

2x

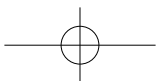

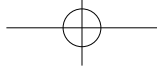

HTB5580

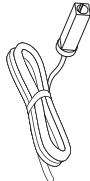
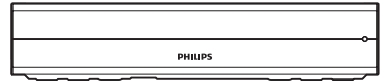
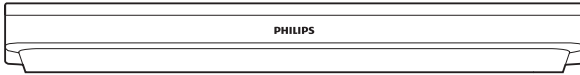

FM Antenna

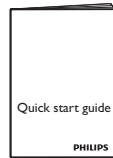

Quick start guide

PHILIPS

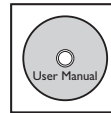

User Manual



PHILIPS

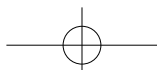
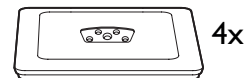
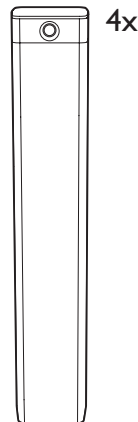
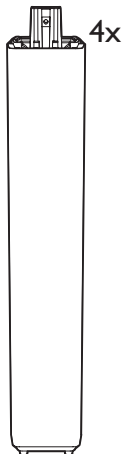
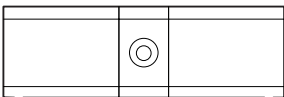
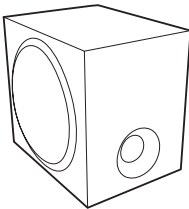

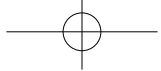

1

HTB5550 / HTB5580 only

EN Stand mount the speakers

CS Nainstalujte reproduktory

DA Monter højttalerne på fod

DE Montage der Lautsprecher auf den Standfüßen

EL Στήστε τα ηχεία πάνω στις βάσεις

ES Monta los altavoces en la pared

FI Kaiuttimien kiinnitys jalustaan

FR Monter le pied des enceintes

HU A hangsugárzók állványra szerelése

IT Montaggio degli altoparlanti su supporto

NL Monteer de luidsprekers op de standaarden

NO Montere høyttalerne på stativ

PL Montaż głośników na podstawie

PT Colocar os altifalantes no suporte

RO Montați pe suport boxe

SK Montáž reproduktorov na stojan

SV Montera högtalarna på stativ

TR Hoparlörleri kaideye monte edin

1

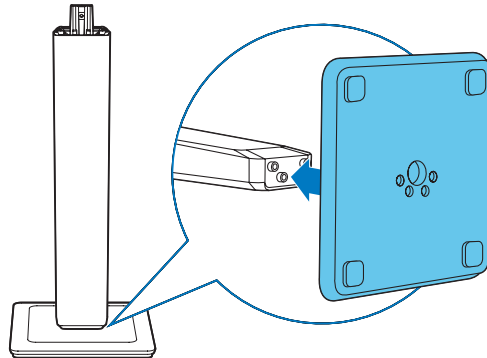

2

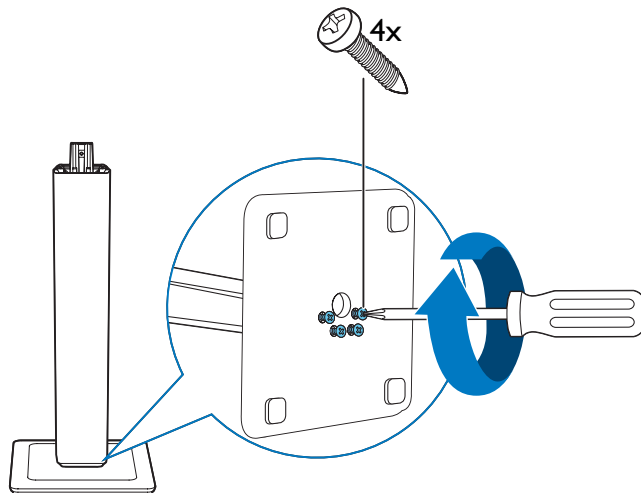

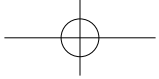

3

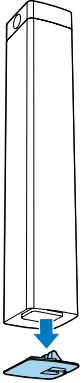

4

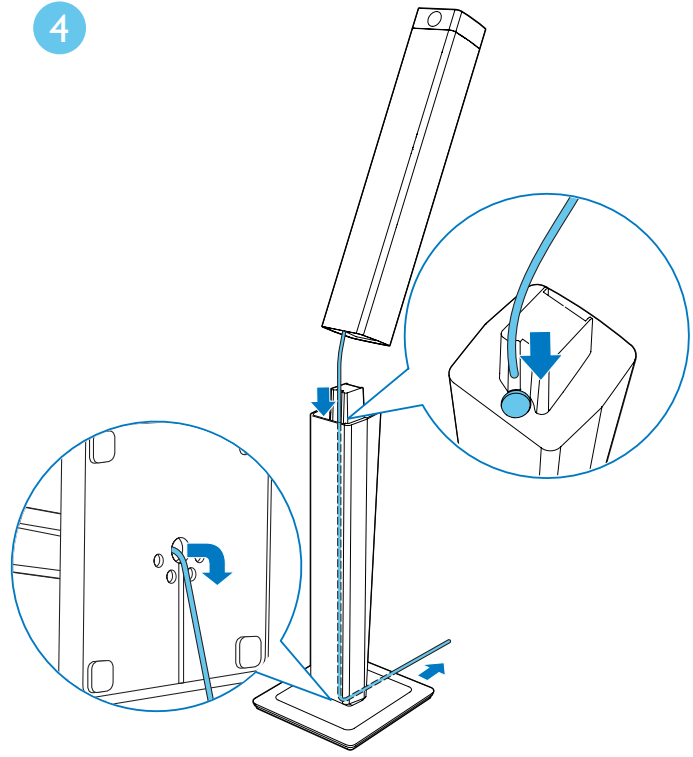

5

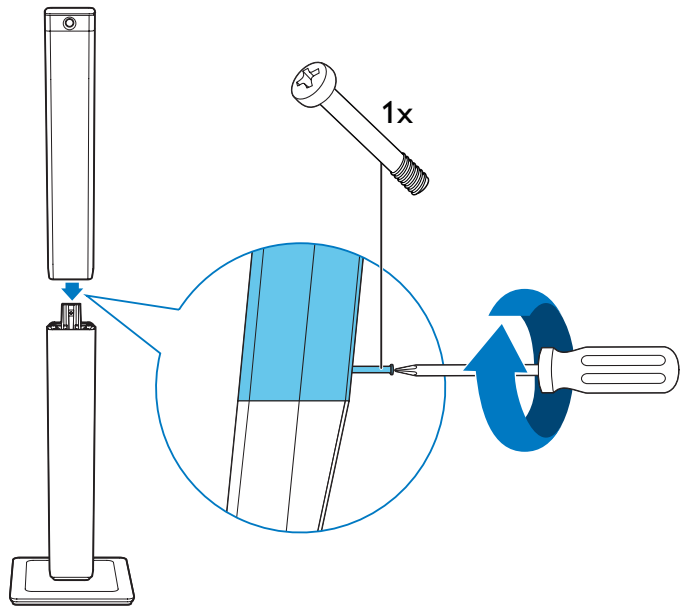

2

EN Connect the home theater

CS Připojte domácí kino

DA Tilslut hjemmebiografen

DE Anschließen des Home Entertainment-Systems

EL Συνδέστε το home cinema

ES Conecta el sistema de cine en casa

FI Kotiteatterin liitännät

FR Connecter les enceintes au Home Cinéma

HU A házimozi csatlakoztatása

IT Collegamento del sistema Home Theater

NL Sluit de home cinema aan

NO Koble til hjemmekinoanlegget

PL Podłączenie zestawu kina domowego

PT Efctuar as ligações ao sistema de cinema em casa

RO Conectați sistemul home theater

SK Pripojenie k domáckemu kinu

SV Anslut hemmabiosystemet

TR Ev sinemasını bağlayın

HTB5520

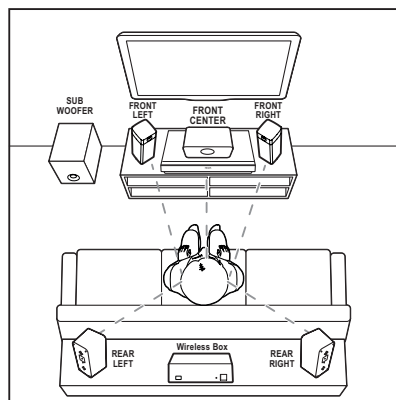
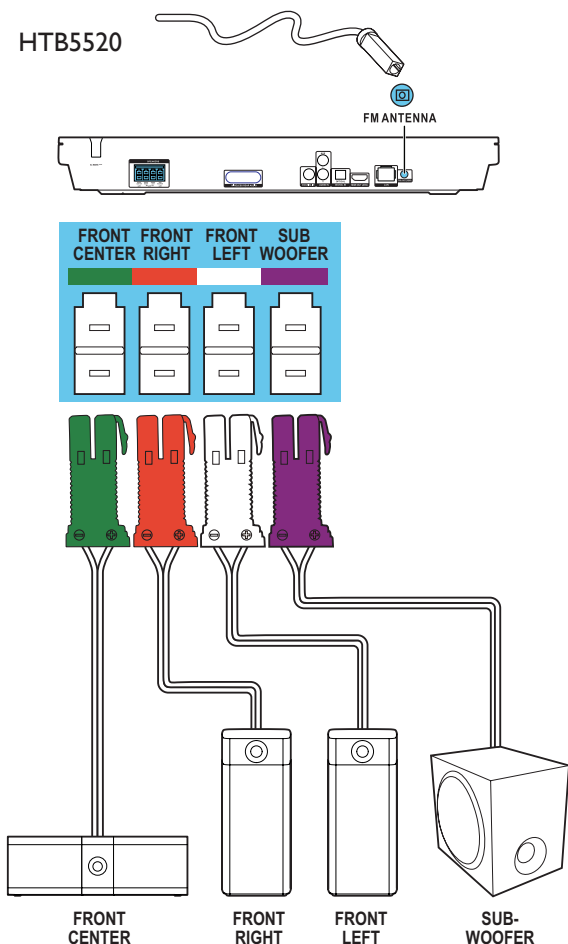

Wireless Box

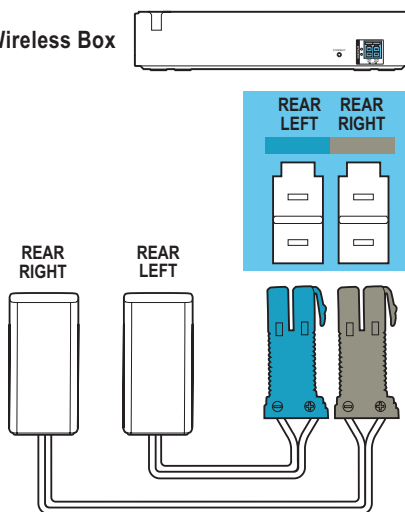

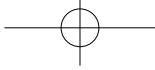

HTB5550

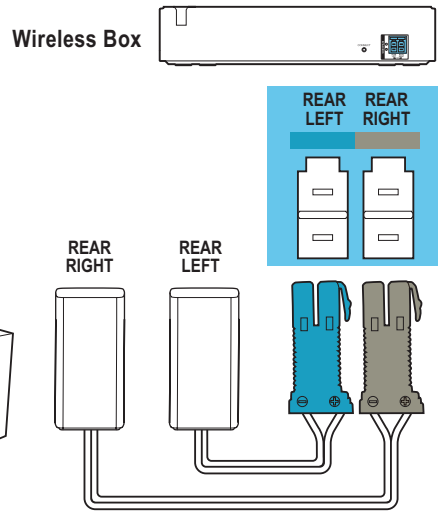
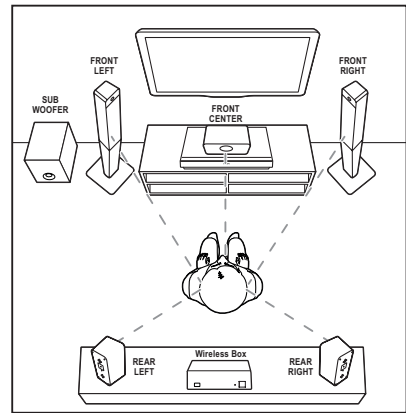
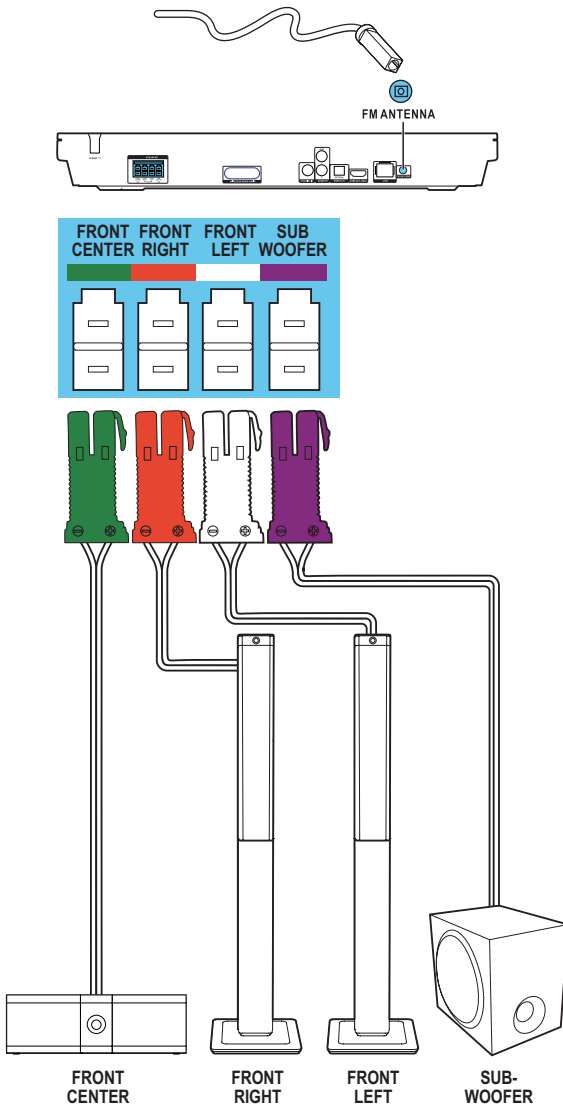

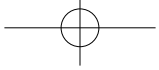

HTB5580

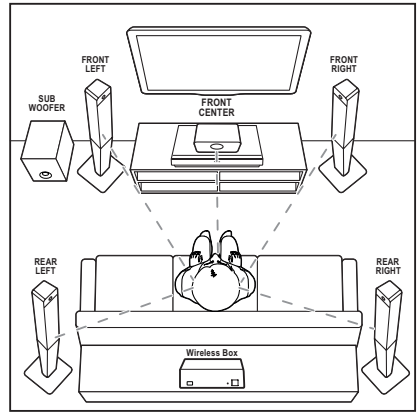
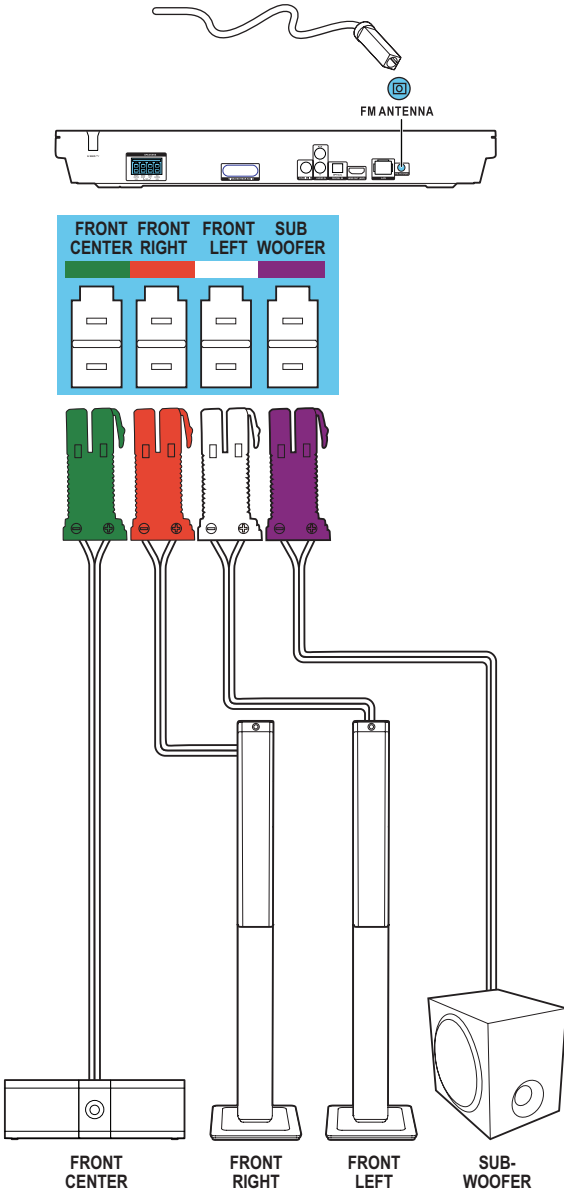

Wireless Box

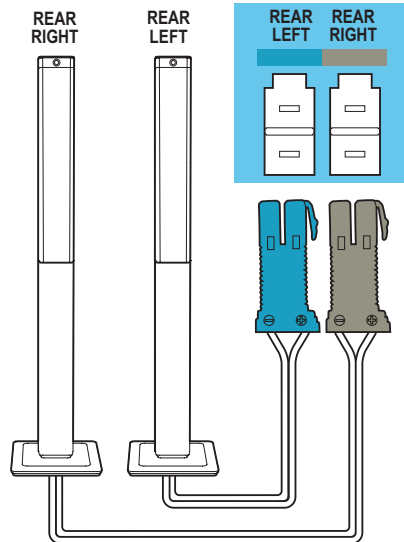

3

EN Connect to TV in one of these ways

CS Připojení k televizoru provedte jedním z následujících způsobů

DA Tilslut til TV på en af følgende måder

DE Herstellen einer Verbindung mit dem Fernseher über einer dieser Möglichkeiten

EL Συνδεθείτε στην τηλεόραση με έναν από τους παρακάτω τρόπους

ES Conexión al televisor de una de estas maneras

FI Liitä televisioon jommallakummalla tavalla

FR Connectez-vous au téléviseur via l'une de ces méthodes

HU Csatlakoztassa a tv-készülékhez az alábbi módok egyike szerint

IT Eseguì il collegamento al TV in uno dei modi indicati di seguito

NL Maak op een van de volgende manieren verbinding met de TV

NO Koble til TV'en på en av følgende måter

PL Podłącz do telewizora przy użyciu jednej z tych metod

PT Ligar ao televisor de uma destas formas

RO Conectați-vă la televizor într-unul din aceste moduri

SK Pripojte zariadenie k televizoru jedným z týchto spôsobov

SV Anslut till TV:n på något av följande sätt

TR Aşağıdaki yöntemlerden biriyile TV'ye bağlanın

HDMI ARC

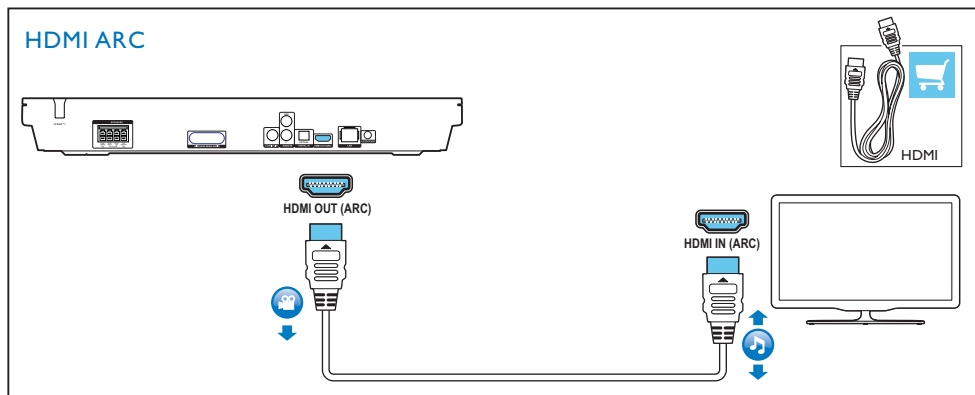

HDMI + OPTICAL

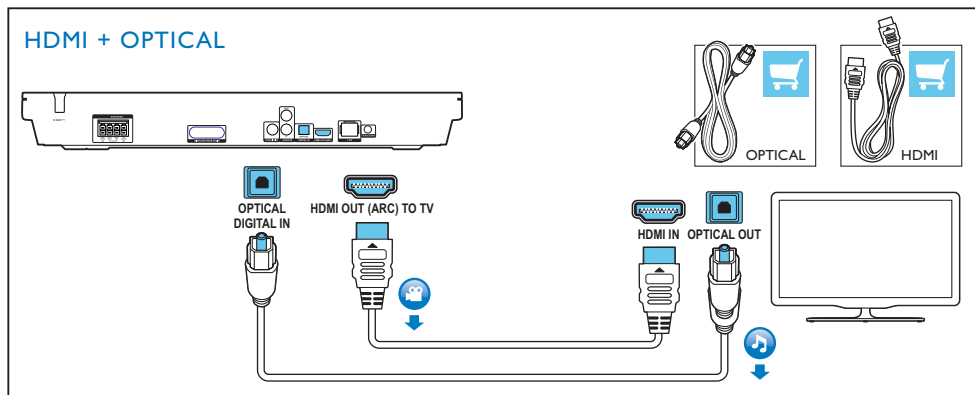

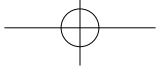

HDMI + COAXIAL

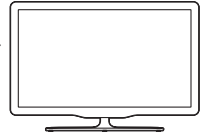
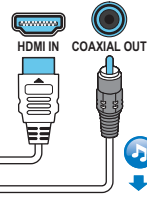
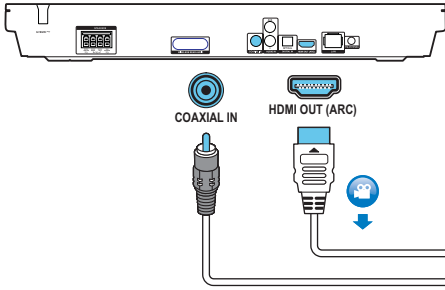

HDMI + AUDIO L/R

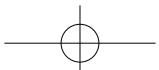
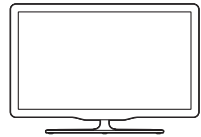
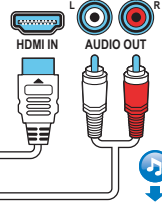
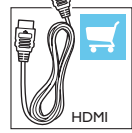
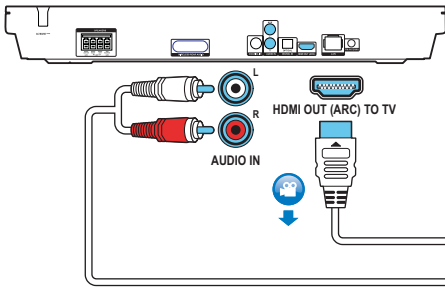

4a

EN Switch on the home theater

CS Zapněte domácí kino

DA Tænd for hjemmebiografen

DE Einschalten des Home Entertainment-Systems

EL Ενεργοποιήστε το home cinema

ES Enciende el sistema de cine en casa

FI Virran kytkeminen kotiteatteriin

FR Mettre sous tension le Home Cinéma

HU A házimozi bekapcsolása

IT Accensione del sistema Home Theater

NL Schakel de home cinema in

NO Slå på hjemmekinoanlegget

PL Włączenie zestawu kina domowego

PT Ligar o sistema de cinema em casa

RO Porniți sistemul home theater

SK Zapnutie domáceho kina

SV Sätt på hemmabiosystemet

TR Ev sinemasını açın

1

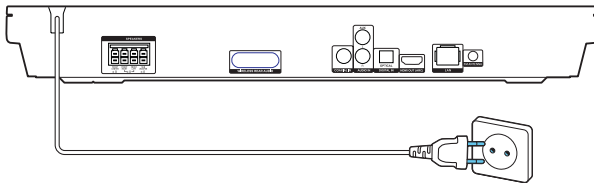

2

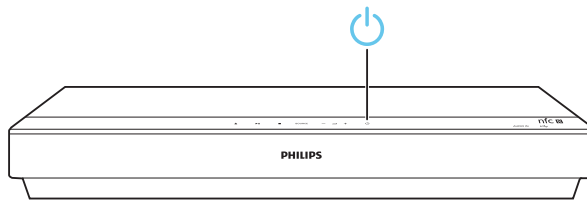

3

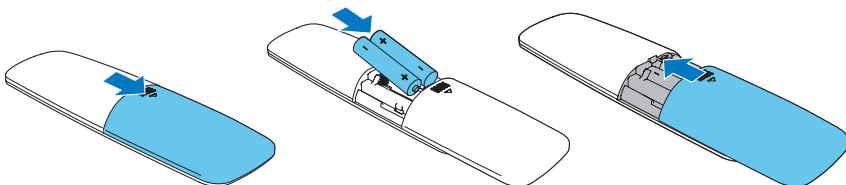

4b

EN Pair up the rear speakers (For the written instructions on pair-up of the rear speakers, refer to the user manual in the supplied CD.)

CS Párování zadních reproduktorů (Více informací o párování zadních reproduktorů naleznete v uživatelské příručce v přiloženém CD.)

DA Parring af baghøjtalere (De skriftlige instruktioner for parring af baghøjtalerne kan findes i brugervejledningen på den medfølgende CD.)

DE Kopplung mit den Rücklautsprechern (Für schriftliche Anweisungen für die Kopplung des Rücklautsprechers beziehen Sie sich auf das Benutzerhandbuch auf der mitgelieferten CD.)

EL Σύζευξη των πίσω ηχείων (Για τις γραπτές οδηγίες σχετικά με τη σύζευξη των πίσω ηχείων, ανατρέξτε στο εγχειρίδιο χρήσης στο παρεχόμενο CD.)

ES Emparejamiento con los altavoces posteriores (Para obtener instrucciones por escrito acerca del emparejamiento de los altavoces posteriores, consulte el manual de usuario incluido en el CD.)

FI Takakaiuttimien yhdistäminen (Kirjalliset takakaiuttimien yhdistämishjeet ovat mukana toimitetun CD-levyn käyttöoppaassa.)

FR Couplage avec les enceintes arrière (Pour les instructions écrites sur le couplage des enceintes arrière, reportez-vous au manuel d'utilisation sur le CD fourni.)

HU Párosítás a hátsó hangsugárzókkal (A hátsó hangsugárzók párosítására vonatkozó utasítások írásbeli változatát a mellékelt CD-n található használati útmutatóban találja.)

IT Associazione degli altoparlanti posteriori (Per le istruzioni sull'associazione degli altoparlanti posteriori, fare riferimento al manuale dell'utente all'interno del CD fornito in dotazione.)

NL De achterste luidsprekers koppelen (Raadpleeg de gebruikershandleiding op de meegeleverde CD voor de instructies voor het koppelen van de achterste luidsprekers.)

NO Pare de bakre høytalerne (Hvis du trenger skriftlige instruksjoner på paring av de bakre høytalerne, kan du se i brukerhåndboken på den medfølgende CD-en.)

PL Parowanie głośników tylnych (Pismenne instrukcje dotyczące parowania głośników tylnych można znaleźć w instrukcji obsługi na dołączonej płycie CD.)

PT Emparelhar os altifalantes traseiros (Para instruções por escrito relativas ao emparelhamento dos altifalantes traseiros, consulte o manual do utilizador no CD fornecido.)

RO Sincronizarea boxelor spate (Pentru instrucțiunile scrise privind sincronizarea boxelor spate, consultați manualul de utilizare de pe CD-ul furnizat.)

SK Párovanie so zadnými reproduktormi (Pokyny na párovanie zadných reproduktorov nájdete v návode na používanie na dodanom disku CD.)

SV Para ihop de bakre högtalarna (I användarhandboken till den medföljande CD-skivan finns instruktioner för hur du parar ihop de bakre högtalarna.)

TR Arka hoparlörleri eşleme (Arka hoparlörleri eşleme konusunda yazılı talimatlar için birlikte verilen CD'deki kullanım kılavuzuna başvurun.)

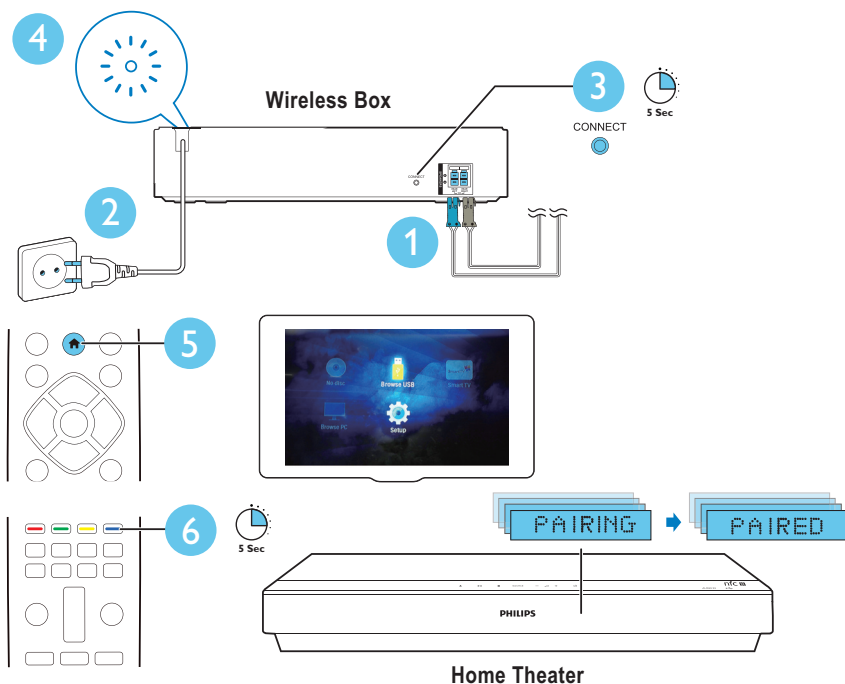

5

EN Complete the first time setup

CS Dokončili jste nastavení při prvním zapnutí

DA Fuldfør den indledende opsætning

DE Abschließen der Ersteinrichtung

EL Ολοκληρώστε τη ρύθμιση για πρώτη φορά

ES Finaliza la configuración inicial

FI Ensiasennuksen suorittaminen loppuun

FR Effectuer la configuration initiale

HU Az első üzembe helyezés

IT Completamento della configurazione iniziale

NL Volttooï de eerste installatie

NO Fullføre den første konfigureringen

PL Pierwsza konfiguracja

PT Executar a configuração inicial

RO Realizați prima configurare

SK Dokončenie prvého nastavenia

SV Slutför förstagångsinställningen

TR İlk kullanım öncesi kurulumunu tamamlayın

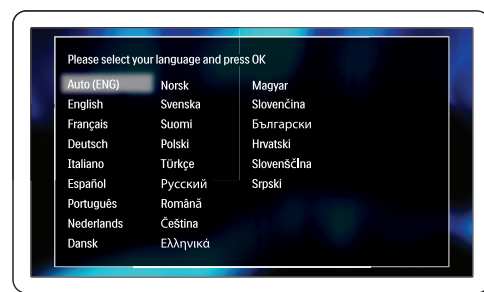
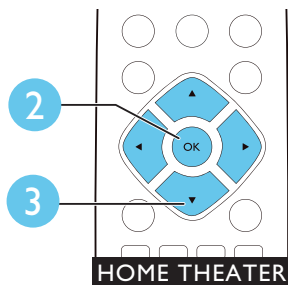
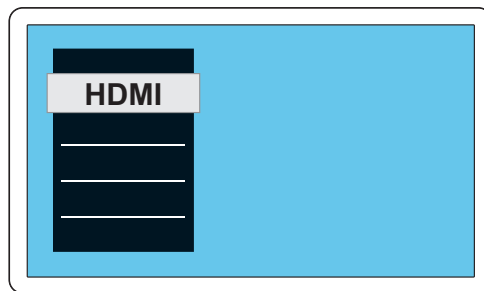
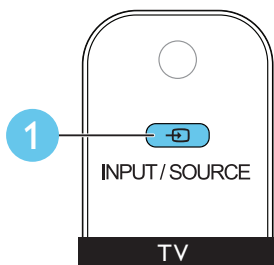

6

EN Use your home theater

CS Použití domácího kina

DA Brug af din hjemmebiograf

DE Verwenden des Home Entertainment-Systems

EL Χρησιμοποιήστε το home cinema

ES Uso del sistema de cine en casa

FI Kotiteatterin käyttäminen

FR Utiliser votre Home Cinéma

HU A házimozsi használat

IT Utilizzo del sistema Home Theater

NL Uw home cinema bedienen

NO Bruke hjemmekinoanlegget

PL Korzystanie z zestawu kina domowego

PT Utilizar o sistema de cinema em casa

RO Utilizați sistemul home theater

SK Používanie domáceho kina

SV Använda hemmabiosystemet

TR Ev sinema sisteminin kullanılması

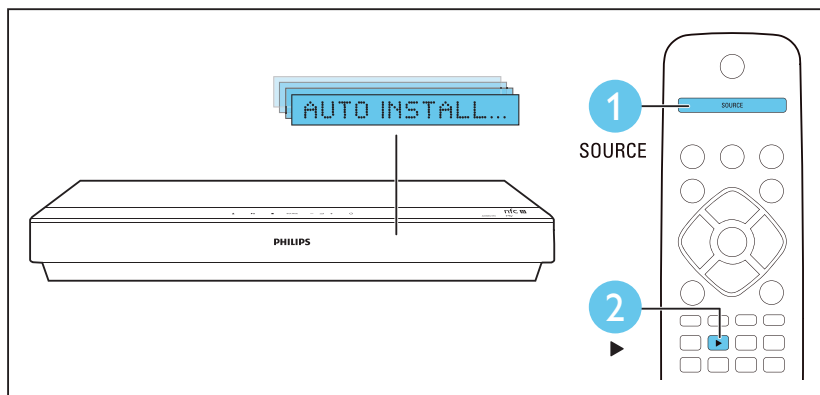
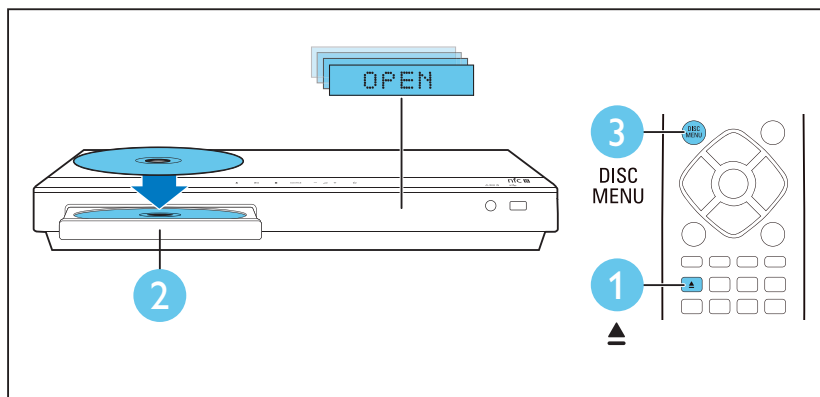

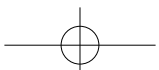
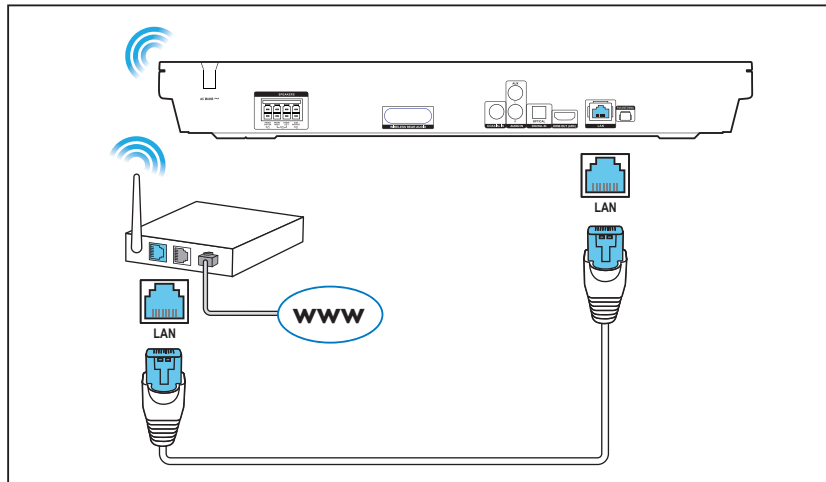
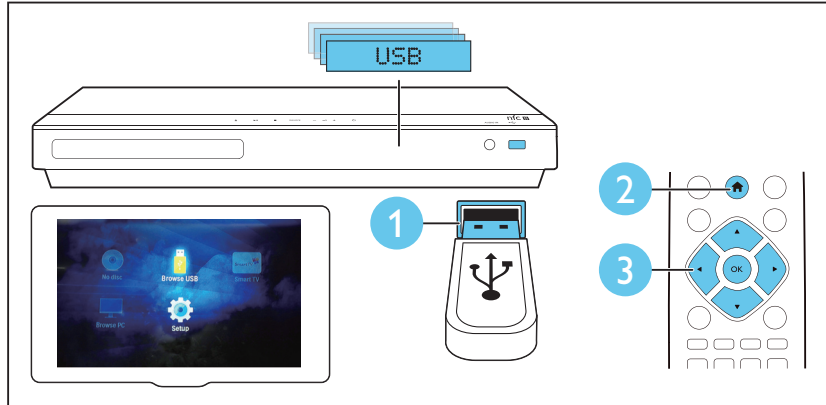
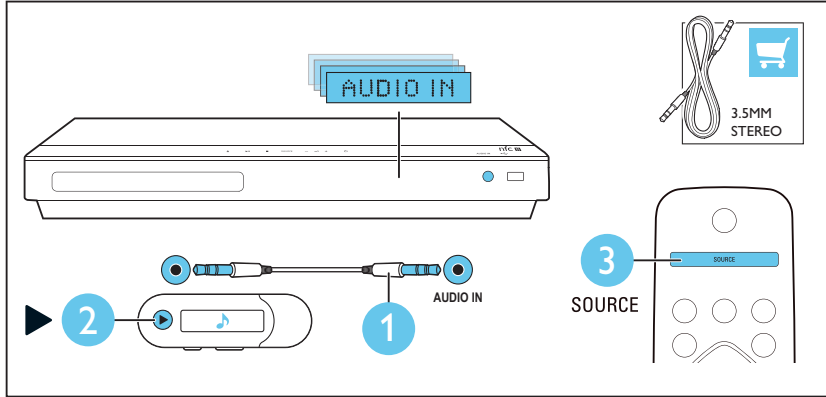
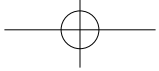

7

- EN** Play audio through Bluetooth or connect Bluetooth via NFC
- CS** Přehrajte hudbu přes Bluetooth nebo připojte Bluetooth přes funkci NFC
- DA** Afspil lyd via Bluetooth, eller tilslut Bluetooth via NFC
- DE** Geben Sie Audioinhalte über Bluetooth wieder, oder stellen Sie eine Bluetooth-Verbindung über NFC her:
- EL** Ακούστε μουσική μέσω Bluetooth ή συνδέστε το Bluetooth μέσω NFC
- ES** Reproducez audio a través de Bluetooth o realice la conexión Bluetooth a través de NFC
- FI** Äänen toistaminen Bluetoothin kautta tai Bluetooth-yhteyden muodostaminen NFC:n kautta
- FR** Lecture de fichiers audio via Bluetooth ou connexion Bluetooth via NFC
- HU** Bluetooth-on keresztül játssza le a hangfájlokat vagy NFC segítségével csatlakoztassa a Bluetooth-t

- IT** Riprodurre l'audio tramite Bluetooth o eseguire il collegamento Bluetooth tramite NFC
- NL** Speel audio af via Bluetooth of maak een Bluetooth-verbinding via NFC.
- NO** Spill av lyd via Bluetooth, eller koble til Bluetooth via NFC
- PL** Włącz odtwarzanie dźwięku przez połączenie Bluetooth lub nawiąż połączenie Bluetooth za pomocą funkcji NFC.
- PT** Reproduzir áudio através do Bluetooth ou ligar o Bluetooth via NFC
- RO** Redați semnal audio prin Bluetooth® sau conectați dispozitivul Bluetooth prin NFC
- SK** Prehrávajte zvuk cez rozhranie Bluetooth alebo pripojte rozhranie Bluetooth cez NFS
- SV** Spela upp ljud via Bluetooth eller ansluta Bluetooth via NFC
- TR** Bluetooth üzerinden müzik çalın veya NFC üzerinden Bluetooth'u bağlayın

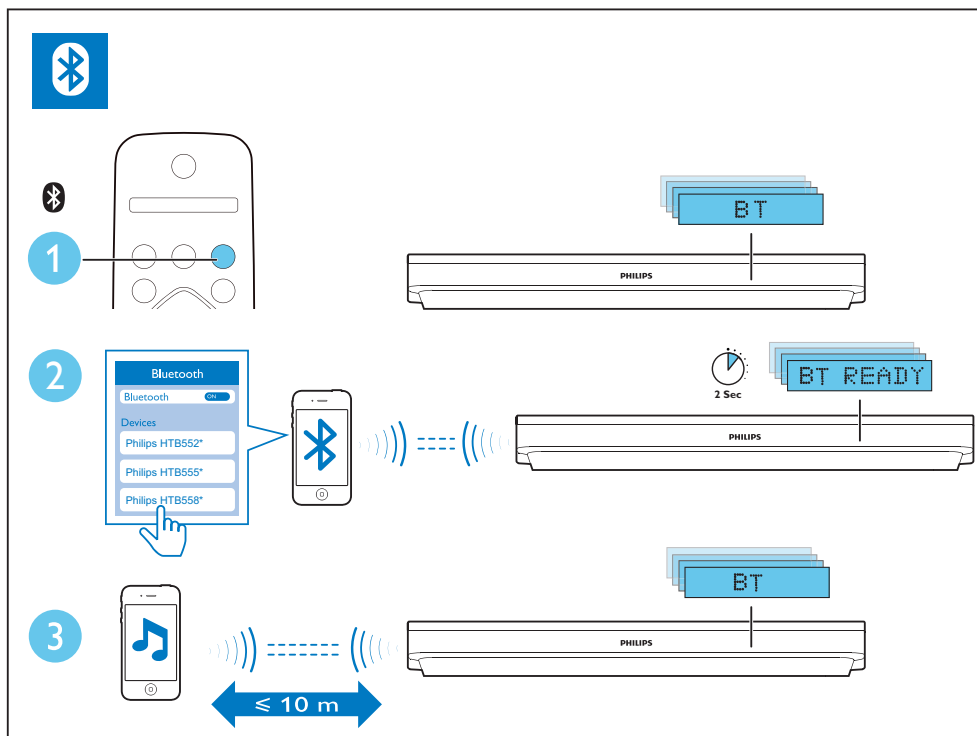

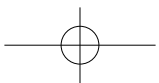
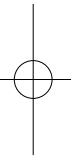
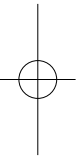
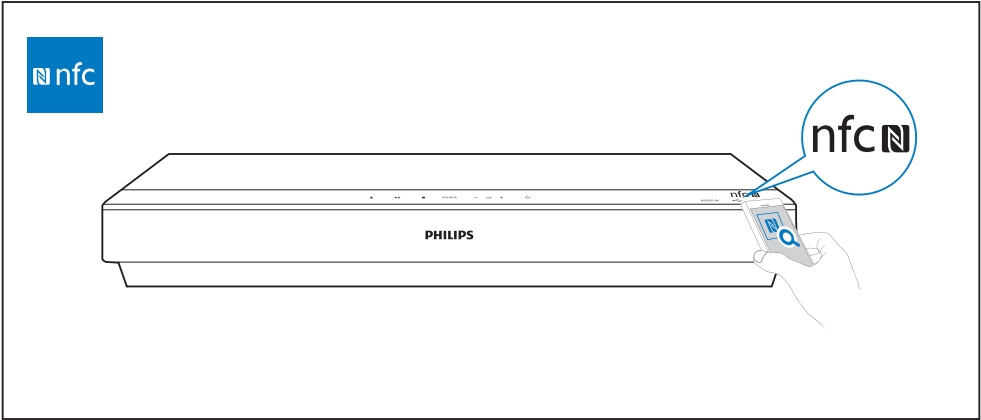
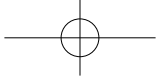

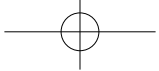

- EN** For more information about using this product, visit www.philips.com/support
- CS** Více informací o použití výrobku naleznete na stránkách www.philips.com/support
- DA** Du kan finde yderligere oplysninger om brugen af dette produkt på www.philips.com/support
- DE** Weitere Informationen zur Verwendung dieses Produkts finden Sie unter www.philips.com/support
- EL** Για περισσότερες πληροφορίες σχετικά με τη χρήση αυτού του προϊόντος, επισκεφθείτε το www.philips.com/support
- ES** Para obtener más información sobre este producto, visite www.philips.com/support
- FI** Lue lisätietoja tuotteen käytöstä osoitteessa www.philips.com/support
- FR** Pour obtenir davantage d'informations sur l'utilisation de ce produit, rendez-vous sur www.philips.com/support
- HU** A termék használatával kapcsolatos további információkkal kapcsolatban tekintse meg a www.philips.com/support weboldalt
- IT** Per ulteriori informazioni sull'uso di questo prodotto, visitare il sito www.philips.com/support
- NL** Ga voor meer informatie over dit product naar www.philips.com/support
- NO** Hvis du vil ha mer informasjon om bruk av dette produktet, kan du gå til www.philips.com/support
- PL** Więcej informacji na temat korzystania z tego produktu można znaleźć na stronie www.philips.com/support
- PT** Para mais informações sobre a utilização deste produto, visite www.philips.com/support
- RO** Pentru informații suplimentare despre utilizarea acestui produs, vizitați www.philips.com/support
- SK** Ďalšie informácie o používaní tohto výrobku nájdete na stránke www.philips.com/support
- SV** Mer information om att använda den här produkten finns på www.philips.com/support
- TR** Bu ürünün kullanımı hakkında daha fazla bilgi için www.philips.com/support adresini ziyaret edin



www.philips.com/support

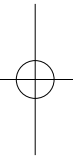
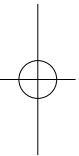
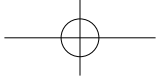

Specifications are subject to change without notice
© 2014 Koninklijke Philips N.V. All rights reserved.
Trademarks are the property of Koninklijke Philips N.V. or their respective owners.

HTB5520G/5550G/5580G_12_QSG_V3.0

