

Always there to help you

Register your product and get support at
www.philips.com/welcome



HTB3520

HTB3550

HTB3580

Quick start guide

PHILIPS



EN Before using your product, read all accompanying safety information

CS Před použitím produktu si přečtěte doprovodné bezpečnostní informace

DA Læs alle medfølgende sikkerhedsoplysninger, inden du tager produktet i brug

DE Lesen Sie vor Verwendung dieses Produkts alle begleitenden Sicherheitsinformationen

EL Πριν χρησιμοποιήσετε το προϊόν, διαβάστε όλες τις παρεχόμενες πληροφορίες ασφάλειας

ES Antes de usar el producto, lea toda la información de seguridad adjunta

FI Lue kaikki turvallisuu tiedot ennen tuotteen käyttöä

FR Avant d'utiliser votre produit, lisez l'intégralité des consignes de sécurité jointes

HU A termék használatá előtt alaposan olvassa el a mellékelt biztonsági tudnivalókat

IT Prima di utilizzare il prodotto, leggere tutte le relative informazioni sulla sicurezza

NL Lees voordat u het product gaat gebruiken eerst alle bijbehorende veiligheidsinformatie

NO Lees voordat u het product gaat gebruiken eerst alle bijbehorende veiligheidsinformatie

PL Przed rozpoczęciem korzystania z produktu należy zapoznać się z informacjami dotyczącymi bezpieczeństwa

PT Antes de utilizar o produto, leia todas as informações de segurança que o acompanham

RO Înainte de a utiliza acest produs, citiți toate informațiile de siguranță care îl însoțesc

SK Pred použitím produktu si prečítajte všetky sprievodné bezpečnostné informácie maklumat keselamatan yang disertakan

SV Innan du använder produkten ska du läsa all tillhörande säkerhetsinformation

TR Ürününüzü kullanmadan önce ilgili tüm güvenlik bilgilerini okuyun



HTB3520

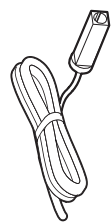
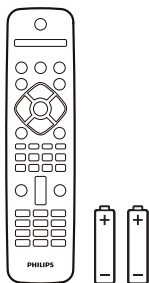
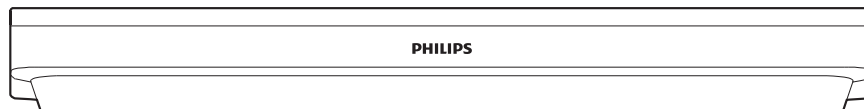

FM Antenna

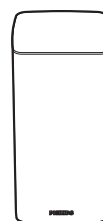
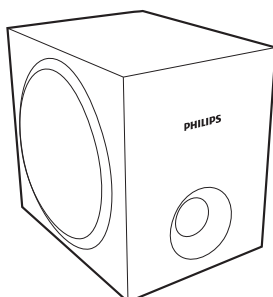
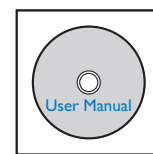
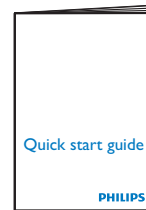
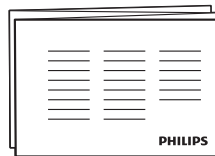

HTB3550

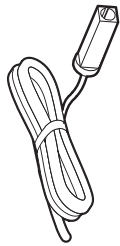
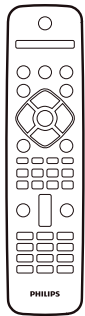

FM Antenna

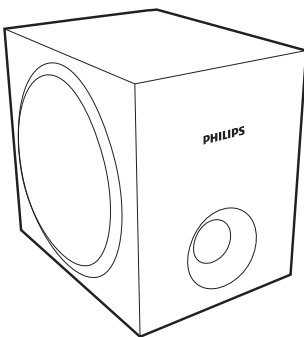
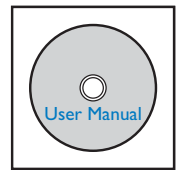
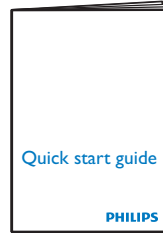
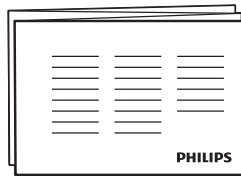

2x

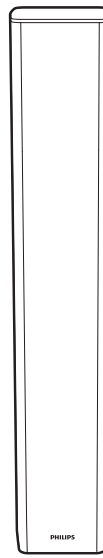

2x



8x



2x

2x

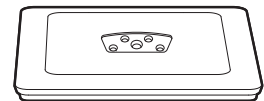

HTB3580

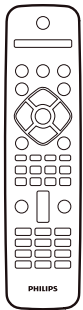

FM Antenna

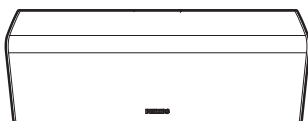
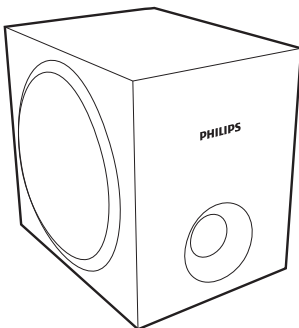
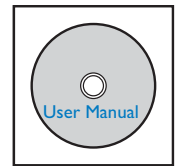
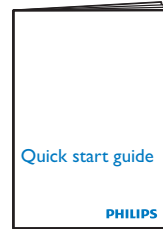
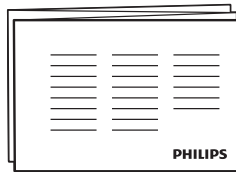

4x

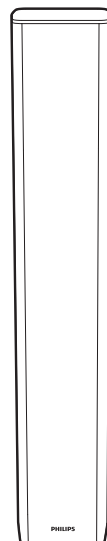

4x



16x



4x

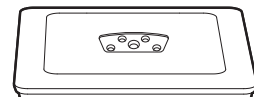

4x

1

HTB3550 / HTB3580 only

EN Stand mount the speakers

CS Nainstalujte reproduktory

DA Monter højttalerne på fod

DE Montage der Lautsprecher auf den Standfüßen

EL Στήστε τα ηχεία πάνω στις βάσεις

ES Monta los altavoces en la pared

FI Kaiuttimien kiinnitys jalustaan

FR Monter le pied des enceintes

HU A hangsugárzók állványra szerelése

IT Montaggio degli altoparlanti su supporto

NL Monteer de luidsprekers op de standaarden

NO Montere høyttalerne på stativ

PL Montaż głośników na podstawie

PT Colocar os altifalantes no suporte

RO Montați pe suport boxe

SK Montáž reproduktorov na stojan

SV Montera högtalarna på stativ

TR Hoparlörleri kaideye monte edin

1

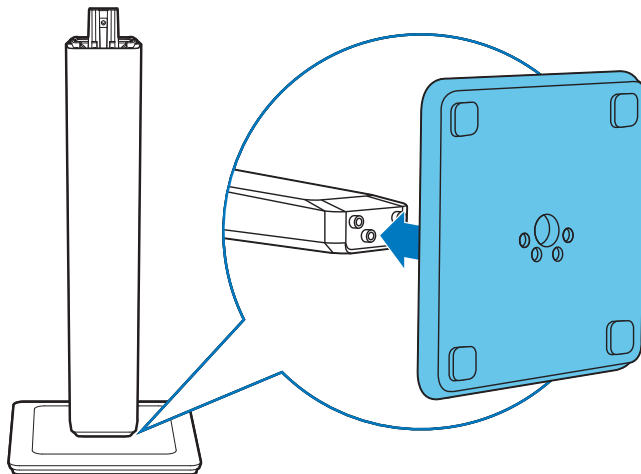

2

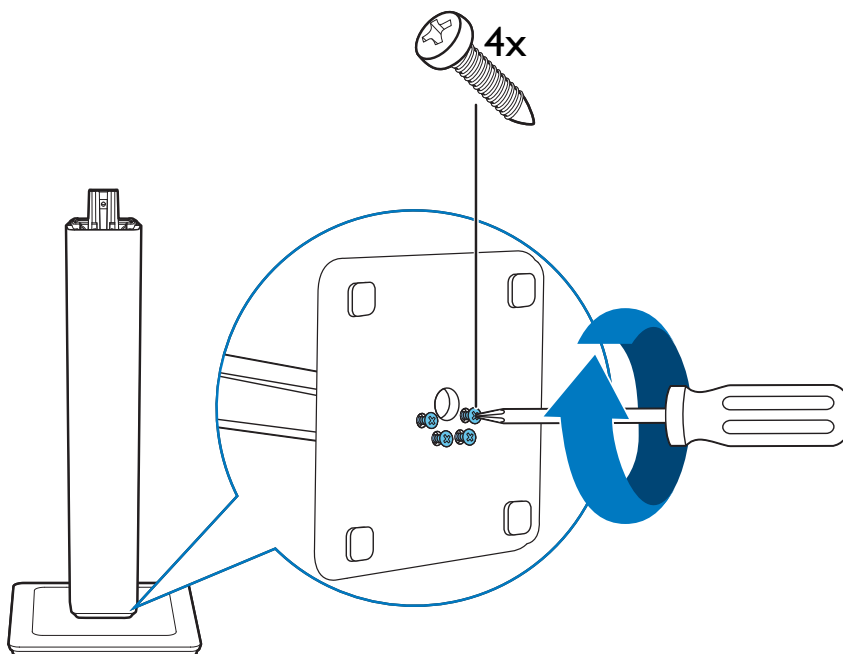

3

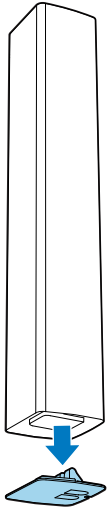

4

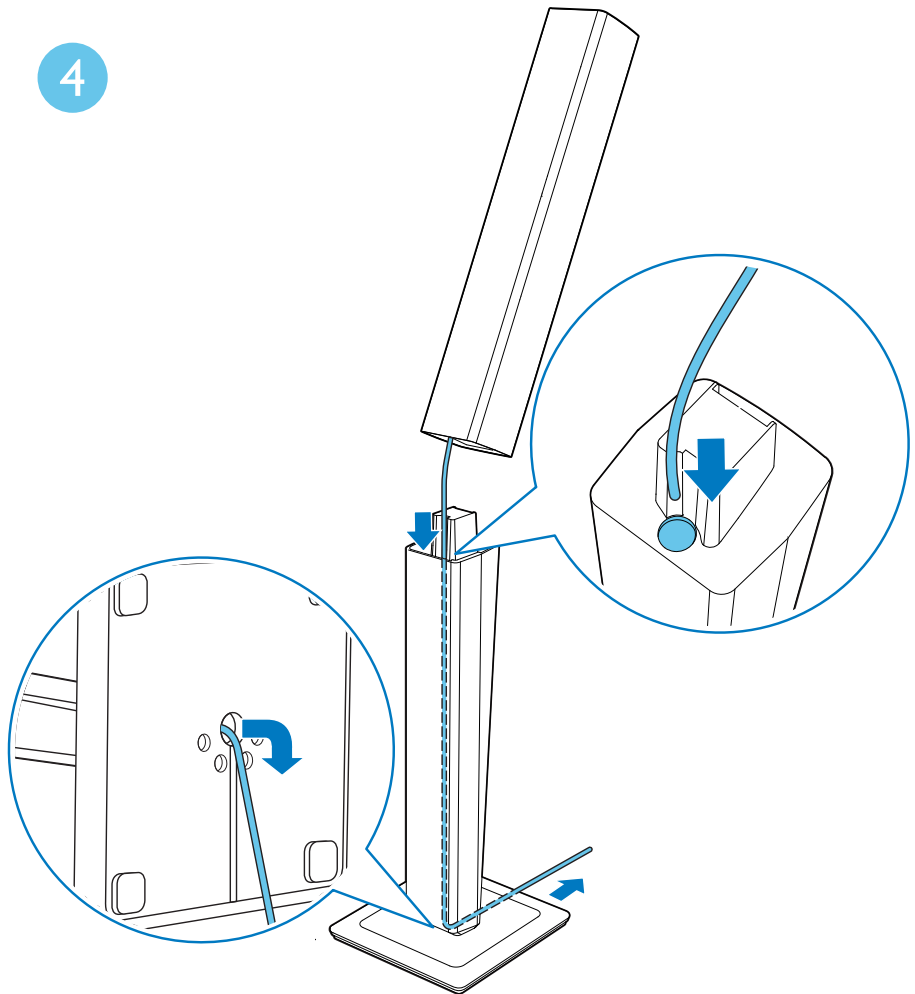

5

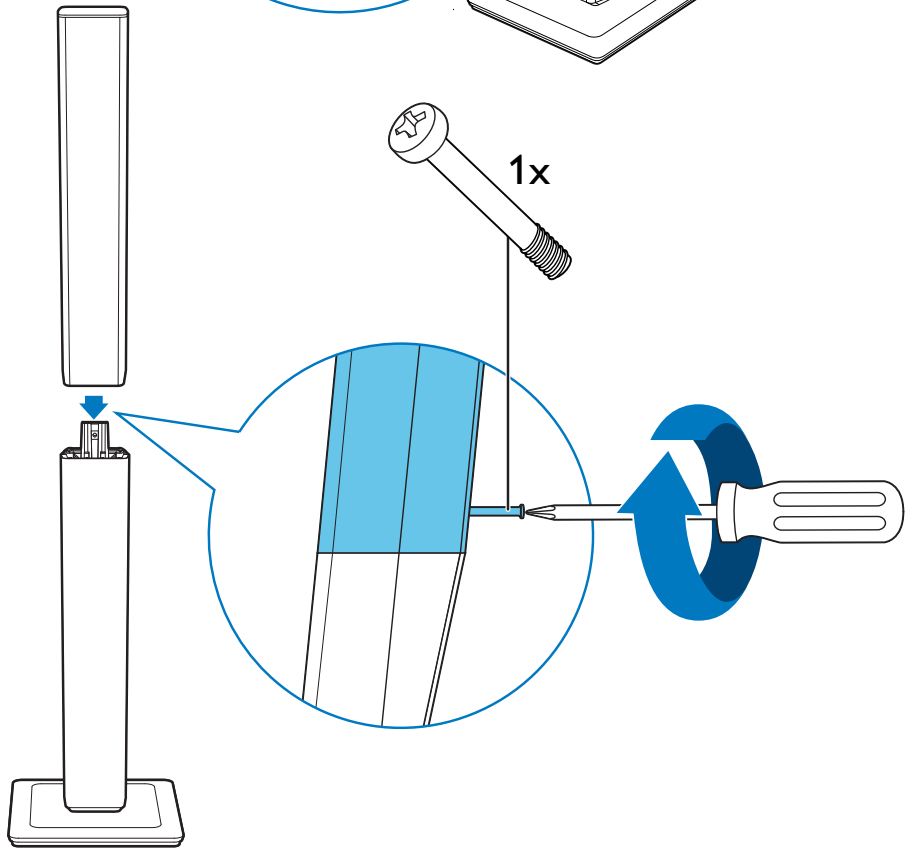

2

EN Connect the home theater

CS Připojte domácí kino

DA Tilslut hjemmebiografen

DE Anschließen des Home Entertainment-Systems

EL Συνδέστε το home cinema

ES Conecta el sistema de cine en casa

FI Kotiteatterin liittäminen

FR Connecter les enceintes au Home Cinéma

HU A házimozi csatlakoztatása

IT Collegamento del sistema Home Theater

NL Sluit de home cinema aan

NO Koble til hjemmekinoanlegget

PL Podłączanie zestawu kina domowego

PT Efectuar as ligações ao sistema de cinema em casa

RO Conectați sistemul home theater

SK Pripojenie k domácemu kinu

SV Anslut hemmabiosystemet

TR Ev sinemasını bağlayın

HTB3520

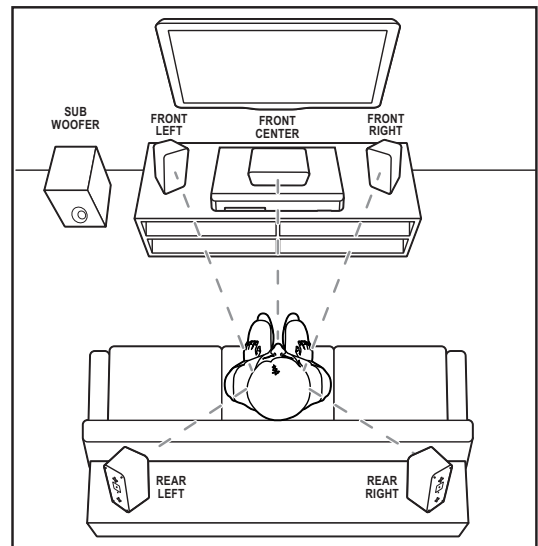
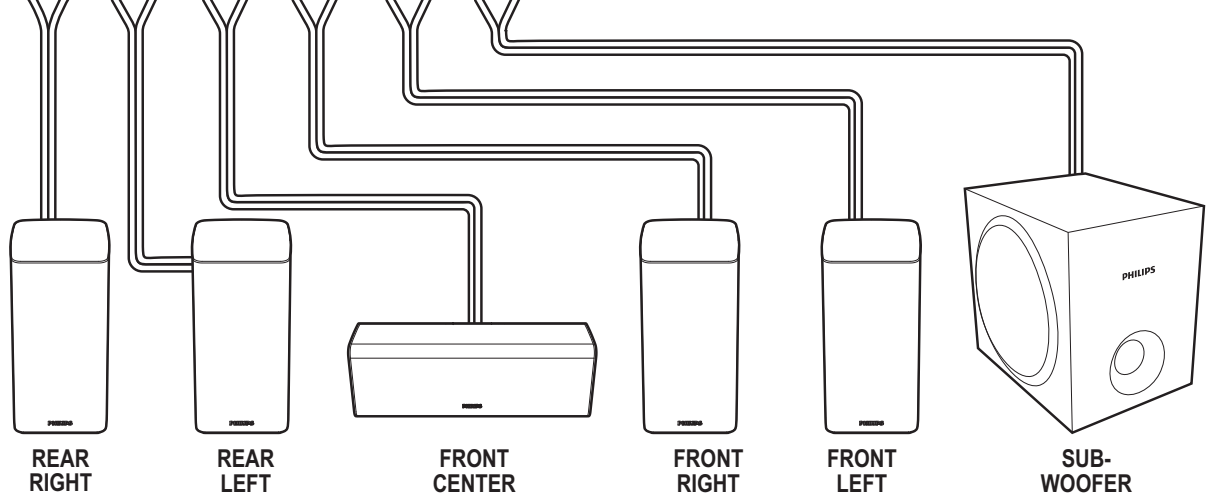
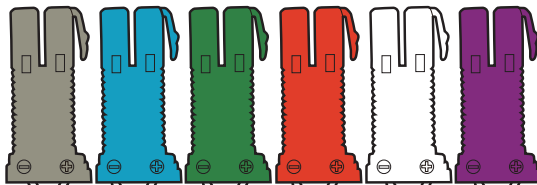
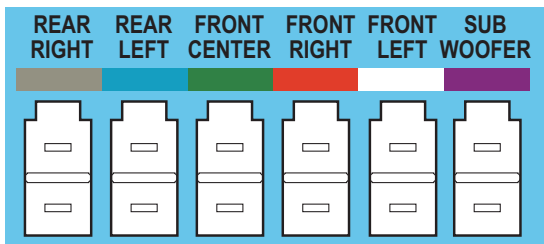
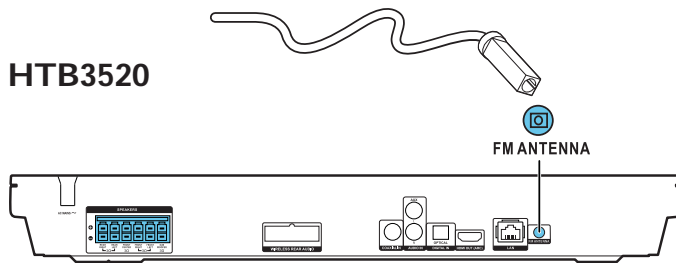

HTB3550

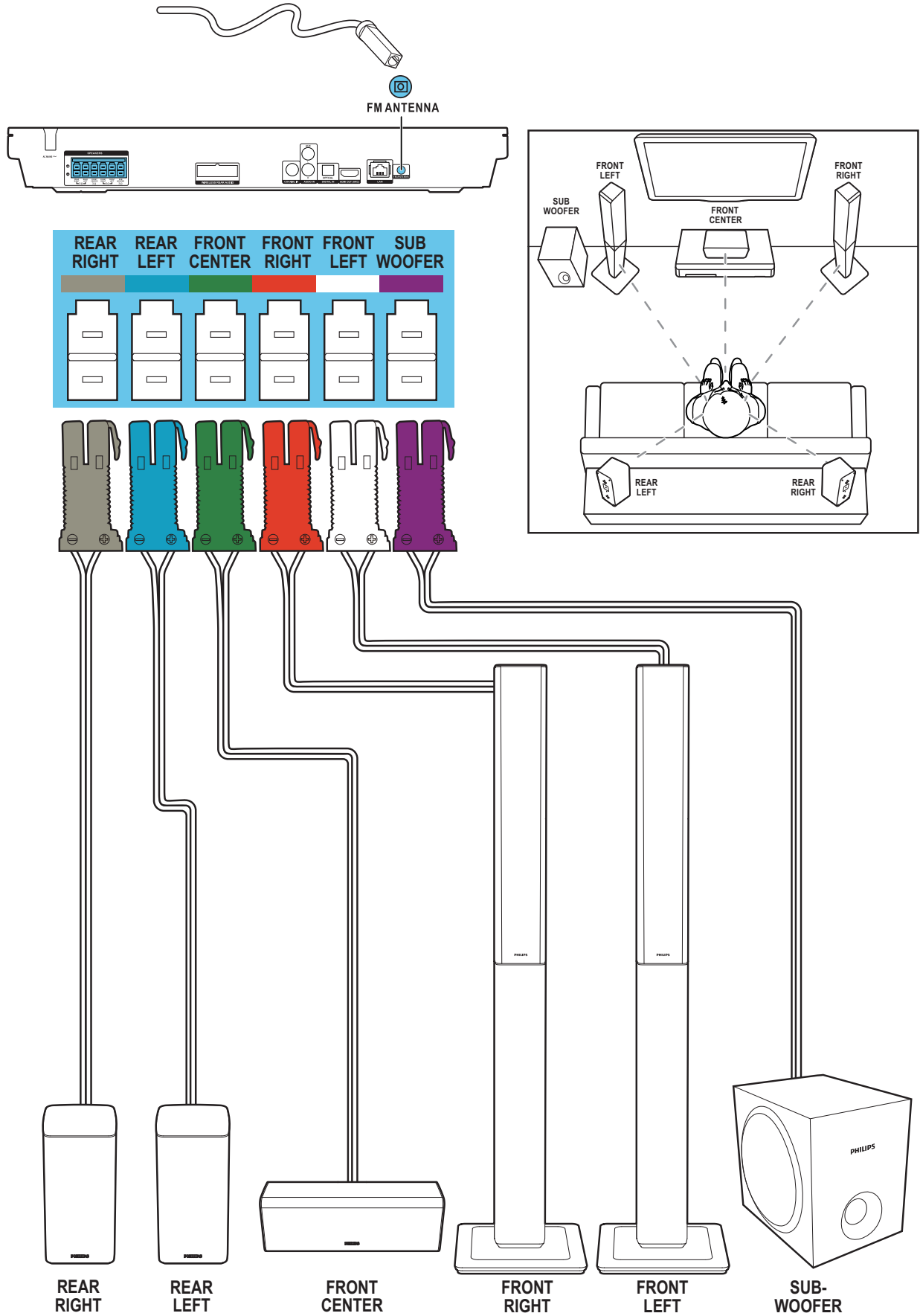

HTB3580

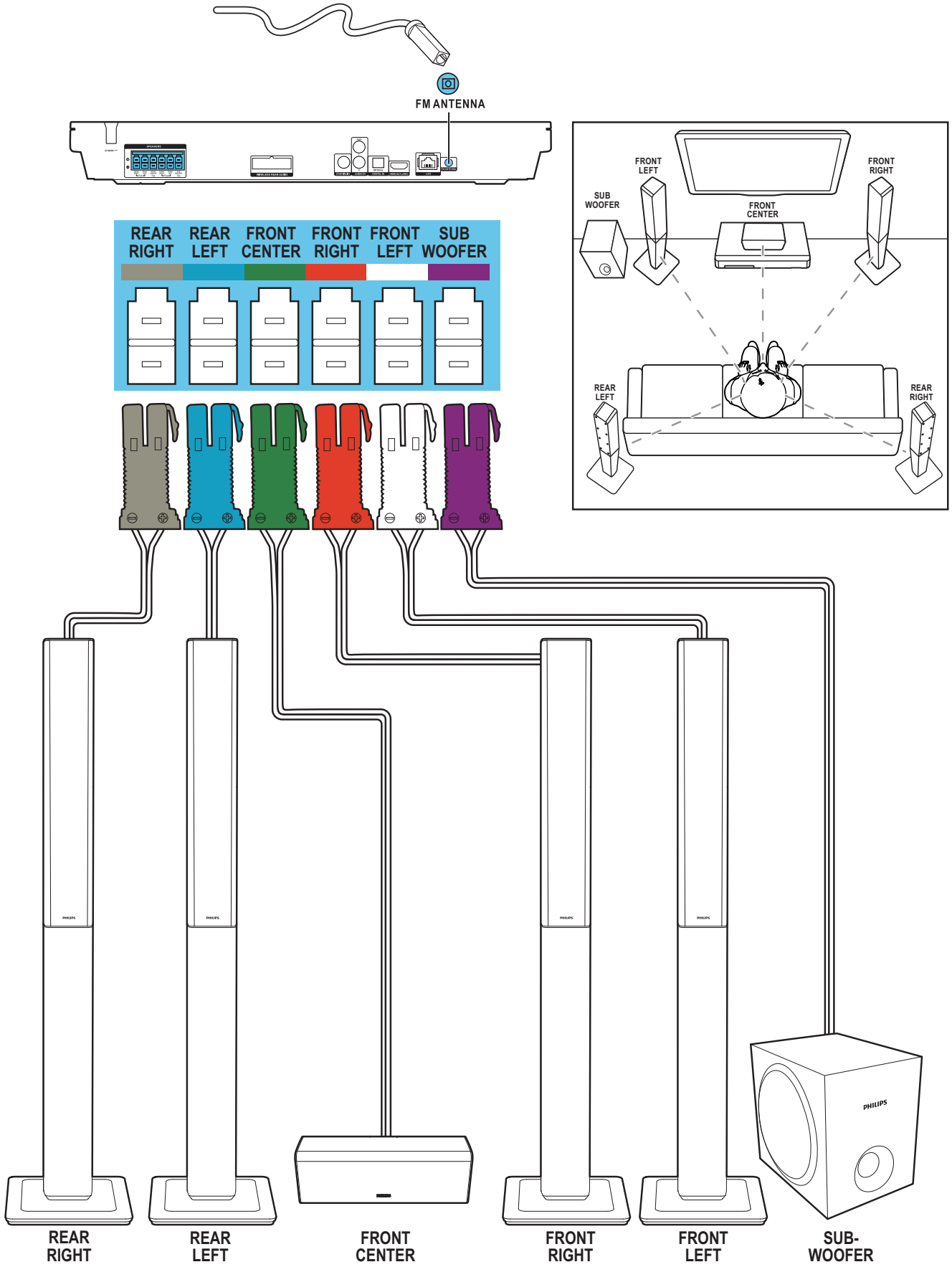

3

EN Connect to TV in one of these ways

CS Připojení k televizoru provedte jedním z následujících způsobů

DA Tilslut til TV på en af følgende måder

DE Herstellen einer Verbindung mit dem Fernseher über einer dieser Möglichkeiten

EL Συνδεθείτε στην τηλεόραση με έναν από τους παρακάτω τρόπους

ES Conexión al televisor de una de estas maneras

FI Liitä televisioon jommallakummalla tavalla

FR Connectez-vous au téléviseur via l'une de ces méthodes

HU Csatlakoztassa a tv-készülékhez az alábbi módok egyike szerint

IT Eseguì il collegamento al TV in uno dei modi indicati di seguito

NL Maak op een van de volgende manieren verbinding met de TV

NO Koble til TVen på en av følgende måter

PL Podłącz do telewizora przy użyciu jednej z tych metod

PT Ligar ao televisor de uma destas formas

RO Conectați-vă la televizor într-unul din aceste moduri

SK Pripojte zariadenie k televizoru jedným z týchto spôsobov

SV Anslut till TV:n på något av följande sätt

TR Aşağıdaki yöntemlerden biriyle TV'ye bağlanın

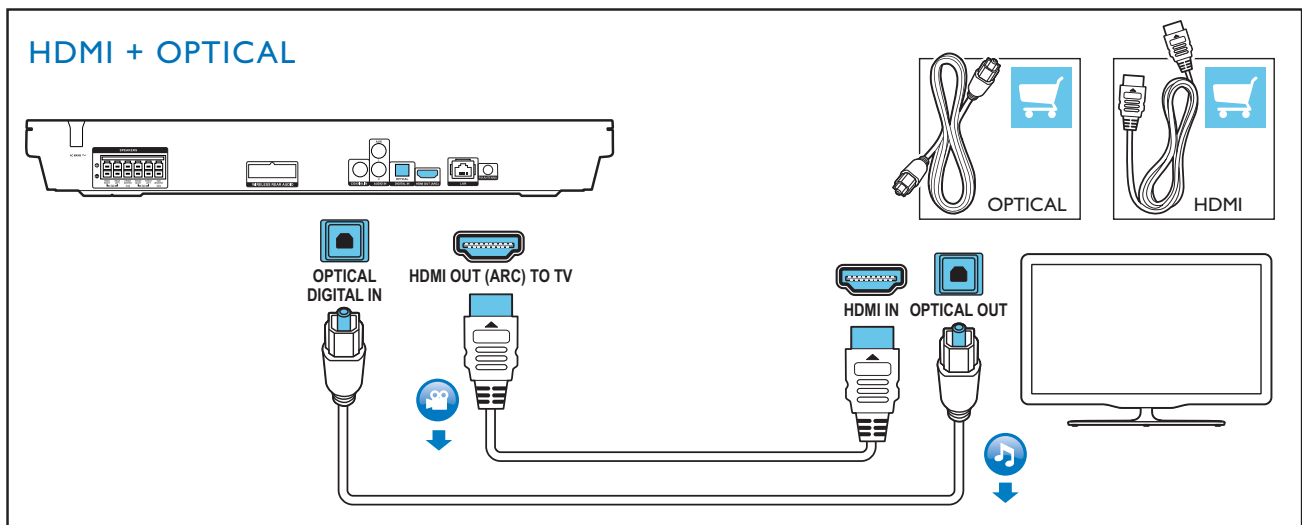
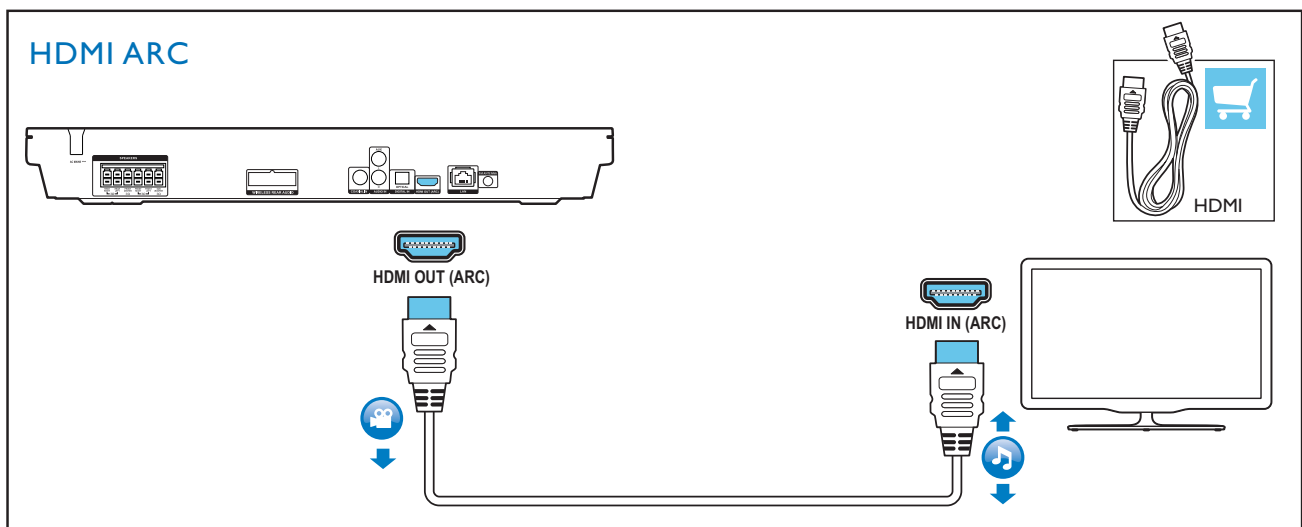

HDMI + COAXIAL

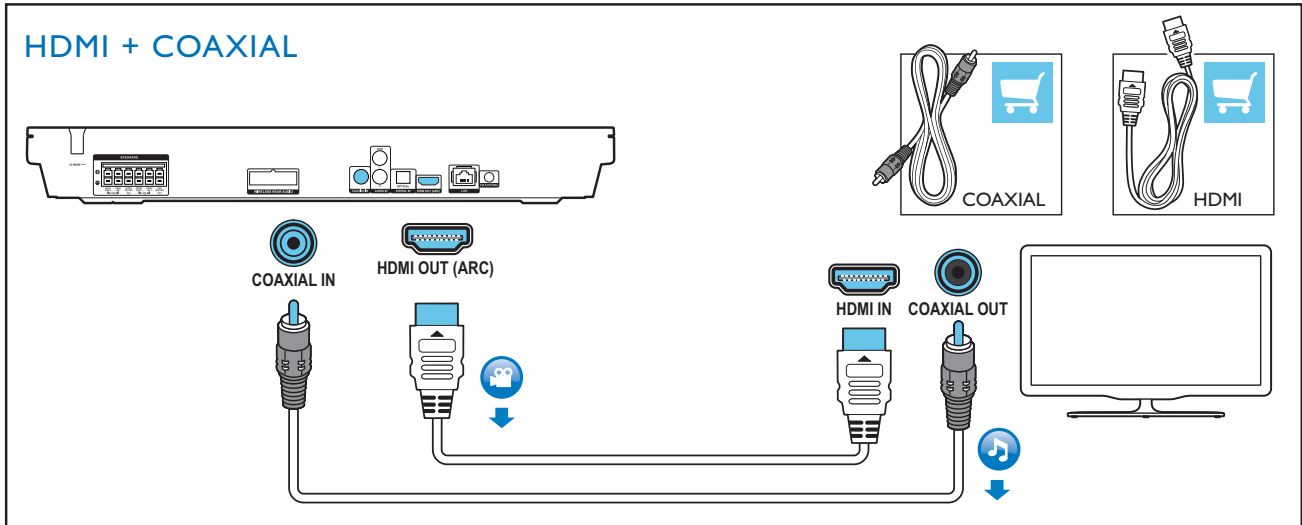

HDMI + AUDIO L/R

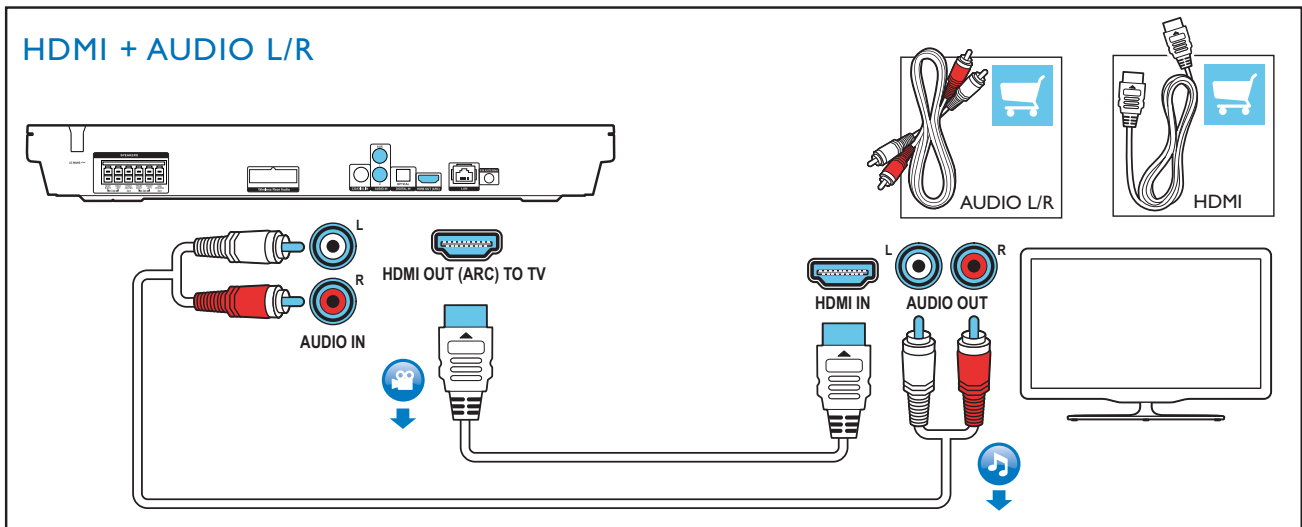

4

EN Switch on the home theater

CS Zapněte domácí kino

DA Tænd for hjemmebiografen

DE Einschalten des Home Entertainment-Systems

EL Ενεργοποιήστε το home cinema

ES Enciende el sistema de cine en casa

FI Virran kytkeminen kotiteatteriin

FR Mettre sous tension le Home Cinéma

HU A házimozi bekapcsolása

IT Accensione del sistema Home Theater

NL Schakel de home cinema in

NO Slå på hjemmekinoanlegget

PL Włączanie zestawu kina domowego

PT Ligar o sistema de cinema em casa

RO Porniți sistemul home theater

SK Zapnutie domáceho kina

SV Sätt på hemmabiosystemet

TR Ev sinemasını açın

1

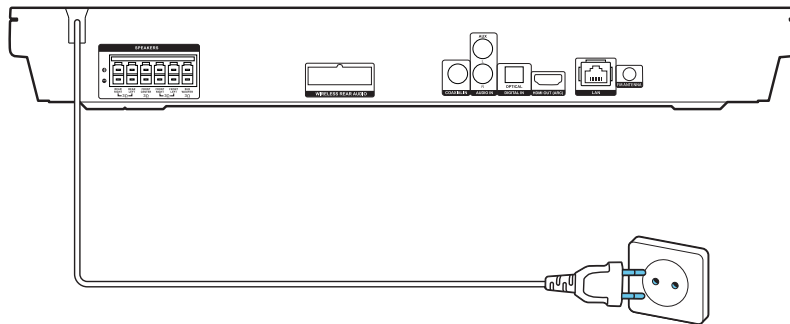

2

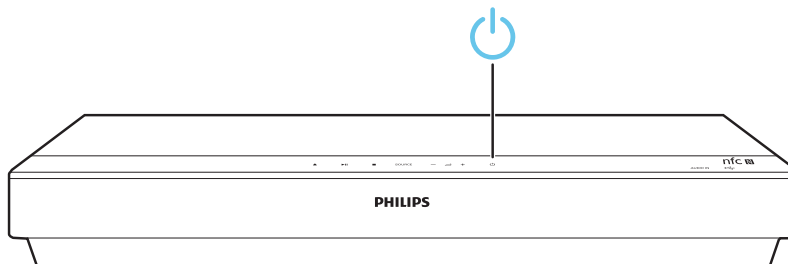

3

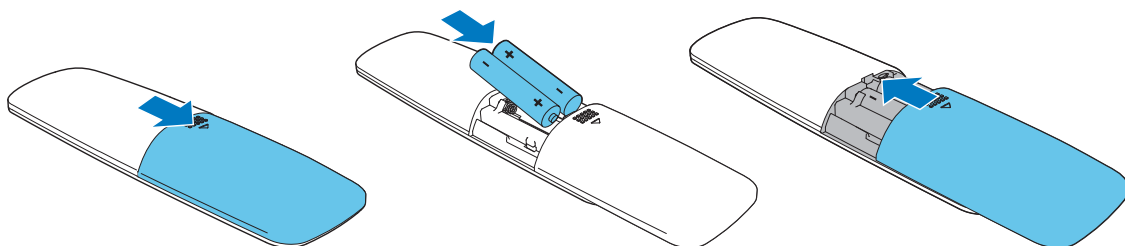

5

EN Complete the first time setup

CS Dokončili jste nastavení při prvním zapnutí

DA Fuldfør den indledende opsætning

DE Abschließen der Ersteinrichtung

EL Ολοκληρώστε τη ρύθμιση για πρώτη φορά

ES Finaliza la configuración inicial

FI Ensiasennuksen suorittaminen loppuun

FR Effectuer la configuration initiale

HU Az első üzembe helyezés

IT Completamento della configurazione iniziale

NL Voltooi de eerste installatie

NO Fullføre den første konfigureringen

PL Pierwsza konfiguracja

PT Executar a configuração inicial

RO Realizați prima configurare

SK Dokončenie prvého nastavenia

SV Slutför förstagångsinställningen

TR İlk kullanım öncesi kurulumunu tamamlayın

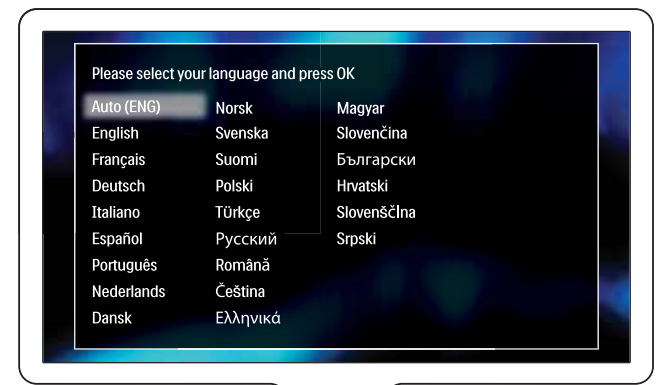
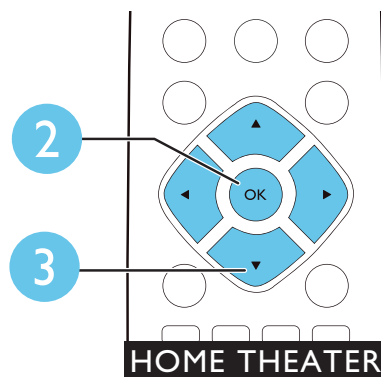
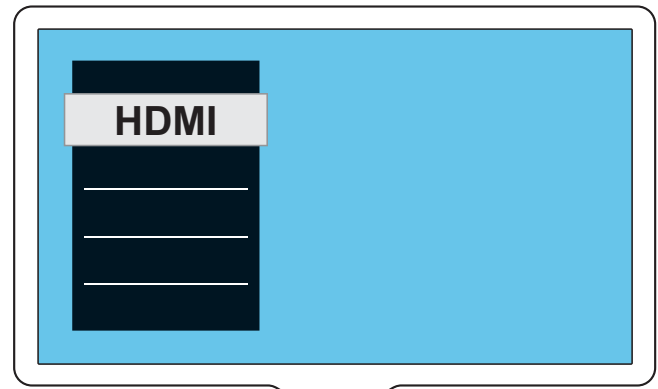
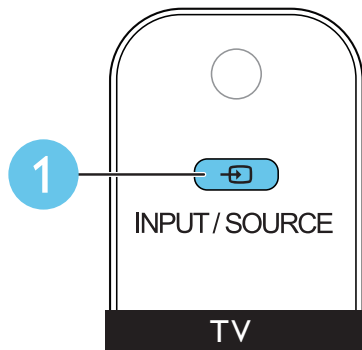

6

EN Use your home theater

CS Použití domácího kina

DA Brug af din hjemmebiograf

DE Verwenden des Home Entertainment-Systems

EL Χρησιμοποιήστε το home cinema

ES Uso del sistema de cine en casa

FI Kotiteatterin käyttäminen

FR Utiliser votre Home Cinéma

HU A házimozi használat

IT Utilizzo del sistema Home Theater

NL Uw home cinema bedienen

NO Bruke hjemmekinoanlegget

PL Korzystanie z zestawu kina domowego

PT Utilizar o sistema de cinema em casa

RO Utilizați sistemul home theater

SK Používanie domáceho kina

SV Använda hemmabiosystemet

TR Ev sinema sisteminin kullanılması

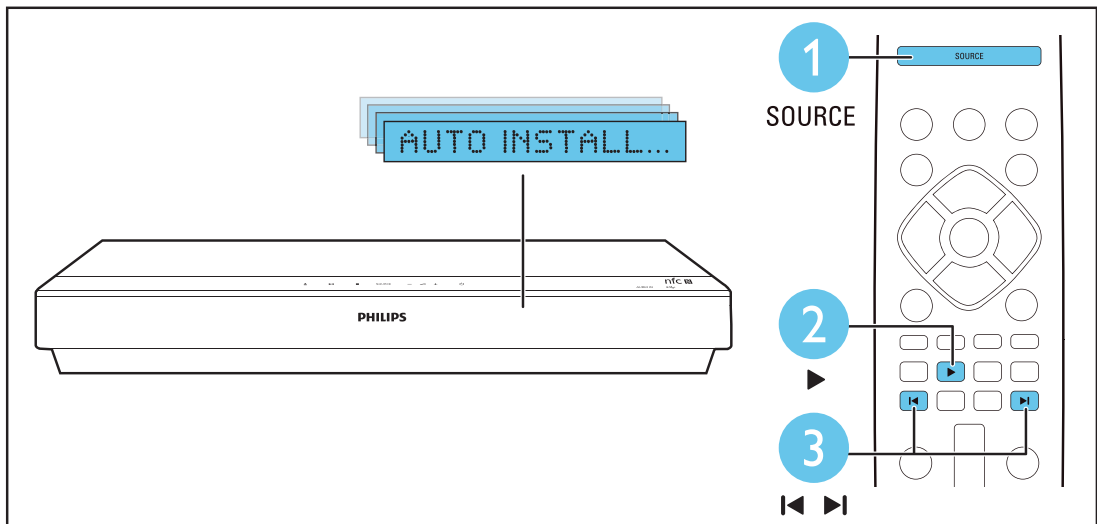
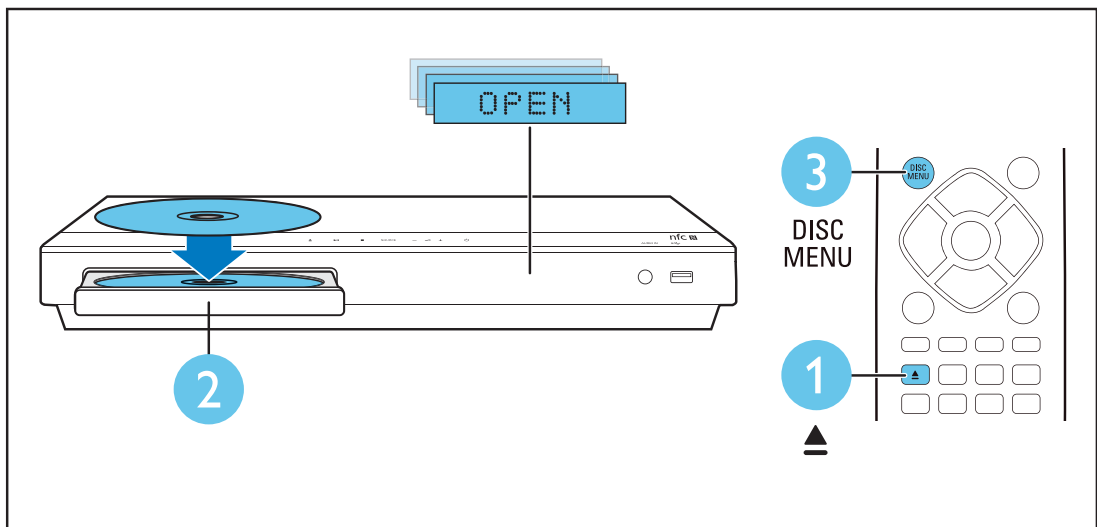
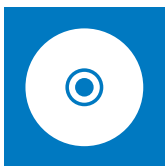

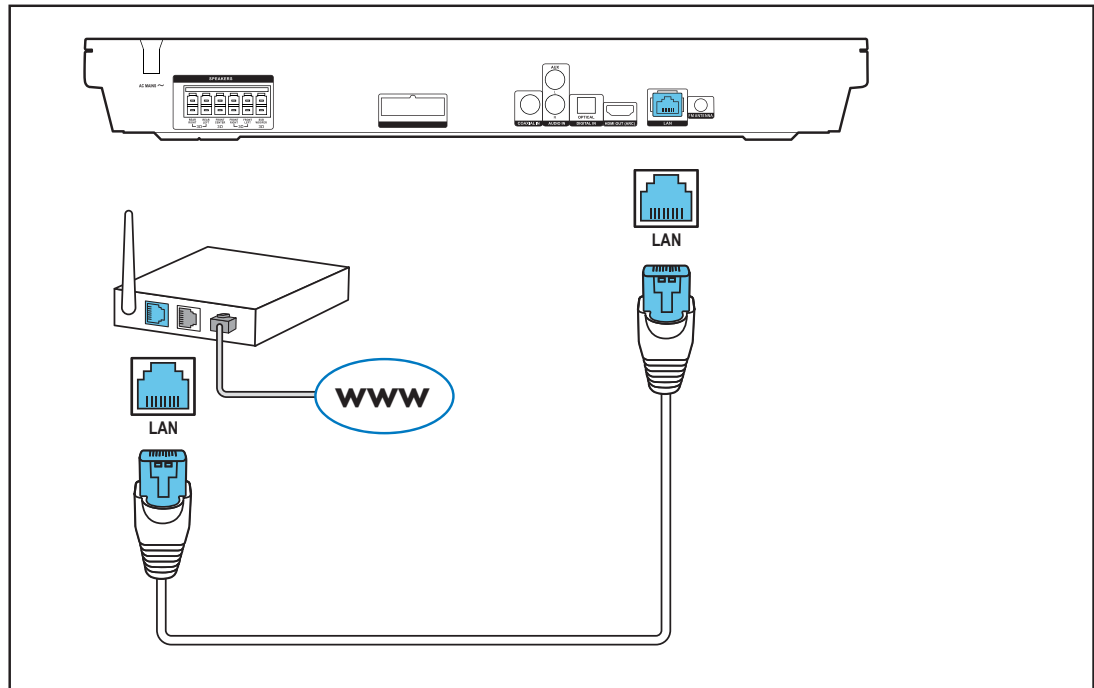
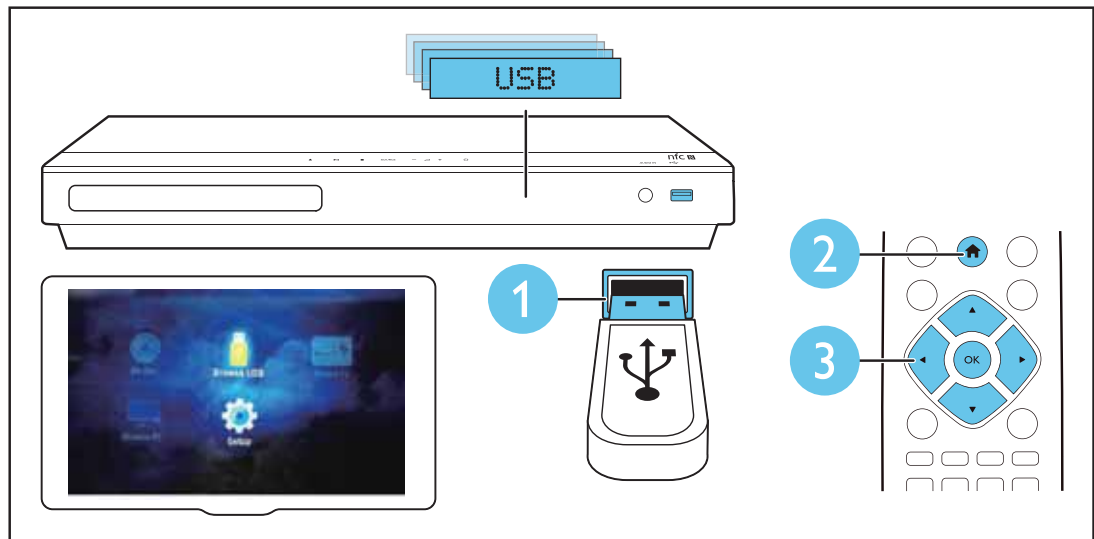
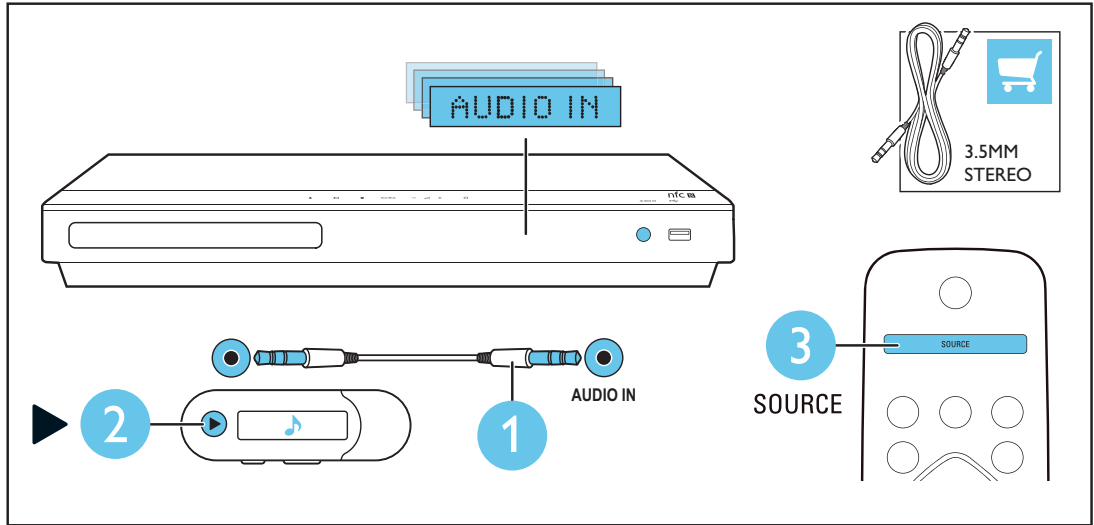

7

EN Play audio through Bluetooth or connect Bluetooth via NFC

CS Přehrajte hudbu přes Bluetooth nebo připojte Bluetooth přes funkci NFC

DA Afspil lyd via Bluetooth, eller tilslut Bluetooth via NFC

DE Geben Sie Audioinhalte über Bluetooth wieder, oder stellen Sie eine Bluetooth-Verbindung über NFC her.

EL Ακούστε μουσική μέσω Bluetooth ή συνδέστε το Bluetooth μέσω NFC

ES Reproduzca audio a través de Bluetooth o realice la conexión Bluetooth a través de NFC

FI Äänen toistaminen Bluetoothin kautta tai Bluetooth-yhteyden muodostaminen NFC:n kautta

FR Lecture de fichiers audio via Bluetooth ou connexion Bluetooth via NFC

HU Bluetooth-on keresztül játssza le a hangfájlokat vagy NFC segítségével csatlakoztassa a Bluetooth-t

IT Riprodurre l'audio tramite Bluetooth o eseguire il collegamento Bluetooth tramite NFC

NL Speel audio af via Bluetooth of maak een Bluetooth-verbinding via NFC.

NO Spill av lyd via Bluetooth, eller koble til Bluetooth via NFC

PL Włącz odtwarzanie dźwięku przez połączenie Bluetooth lub nawiąż połączenie Bluetooth za pomocą funkcji NFC.

PT Reproduzir áudio através do Bluetooth ou ligar o Bluetooth via NFC

RO Redați semnal audio prin Bluetooth® sau conectați dispozitivul Bluetooth prin NFC

SK Prehrávajte zvuk cez rozhranie Bluetooth alebo pripojte rozhranie Bluetooth cez NFS

SV Spela upp ljud via Bluetooth eller ansluta Bluetooth via NFC

TR Bluetooth üzerinden müzik çalın veya NFC üzerinden Bluetooth'u bağlayın

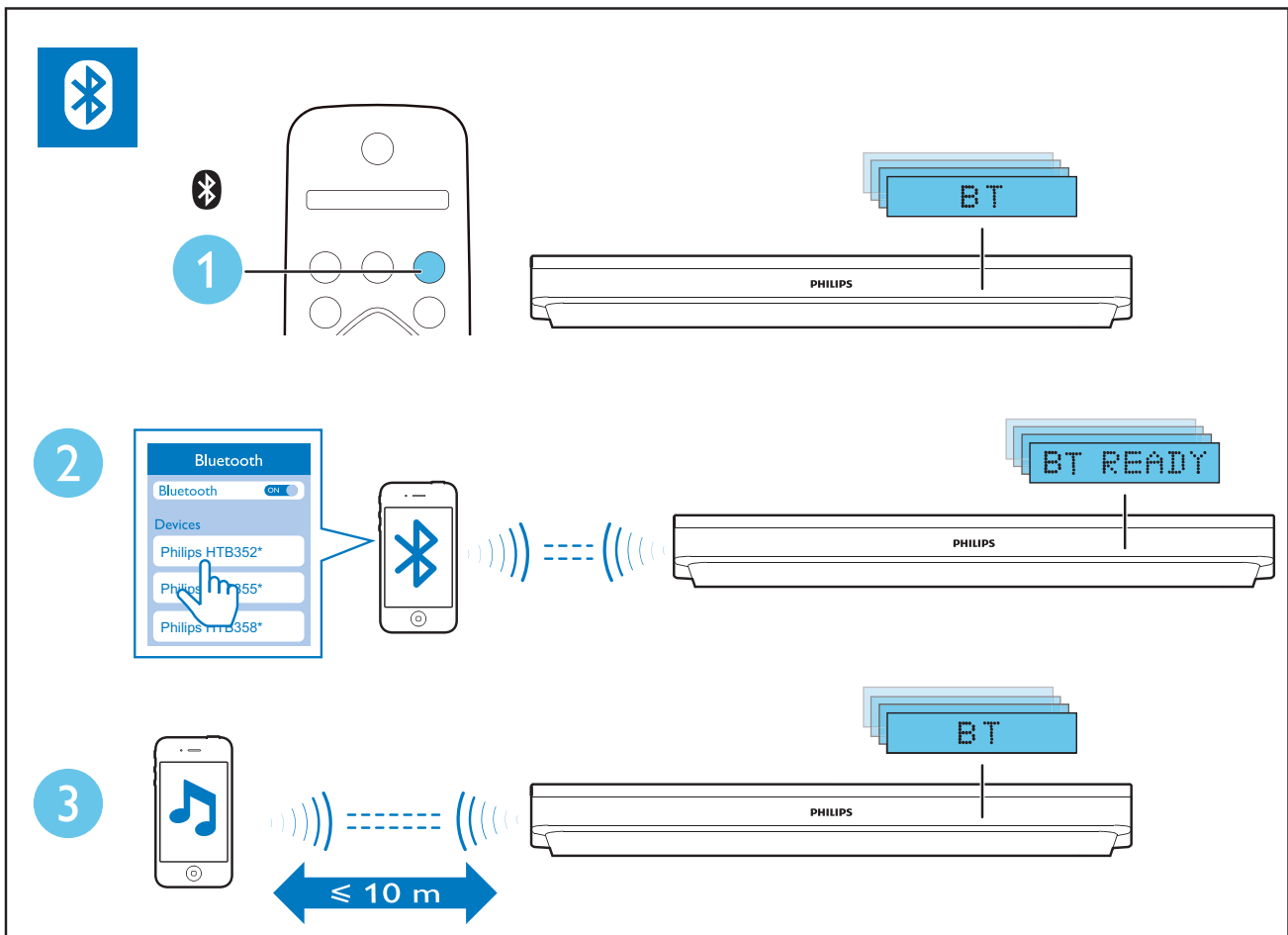

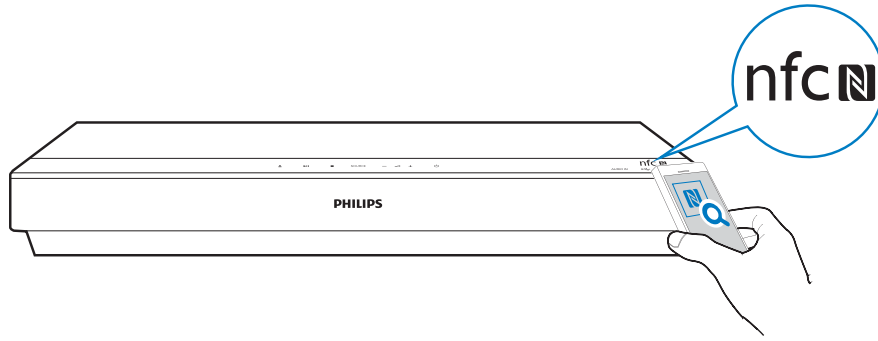



- EN** For more information about using this product, visit www.philips.com/support
- CS** Více informací o použití výrobku naleznete na stránkách www.philips.com/support
- DA** Du kan finde yderligere oplysninger om brugen af dette produkt på www.philips.com/support
- DE** Weitere Informationen zur Verwendung dieses Produkts finden Sie unter www.philips.com/support
- EL** Για περισσότερες πληροφορίες σχετικά με τη χρήση αυτού του προϊόντος, επισκεφθείτε το www.philips.com/support
- ES** Para obtener más información sobre este producto, visite www.philips.com/support
- FI** Lue lisätietoa tuotteen käytöstä osoitteessa www.philips.com/support
- FR** Pour obtenir davantage d'informations sur l'utilisation de ce produit, rendez-vous sur www.philips.com/support
- HU** A termék használatával kapcsolatos további információkkal kapcsolatban tekintse meg a www.philips.com/support weboldalt
- IT** Per ulteriori informazioni sull'uso di questo prodotto, visitare il sito www.philips.com/support
- NL** Ga voor meer informatie over dit product naar www.philips.com/support
- NO** Hvis du vil ha mer informasjon om bruk av dette produktet, kan du gå til www.philips.com/support
- PL** Więcej informacji na temat korzystania z tego produktu można znaleźć na stronie www.philips.com/support
- PT** Para mais informações sobre a utilização deste produto, visite www.philips.com/support
- RO** Pentru informații suplimentare despre utilizarea acestui produs, vizitați www.philips.com/support
- SK** Ďalšie informácie o používaní tohto výrobku nájdete na stránke www.philips.com/support
- SV** Mer information om att använda den här produkten finns på www.philips.com/support
- TR** Bu ürünün kullanımı hakkında daha fazla bilgi için www.philips.com/support adresini ziyaret edin



www.philips.com/support



"Blu-ray 3D™" and "Blu-ray 3D™" logo are trademarks of Blu-ray Disc Association.



'DVD Video' is a trademark of DVD Format/Logo Licensing Corporation.



Oracle and Java are registered trademarks of Oracle and/or its affiliates. Other names may be trademarks of their respective owners.



For DTS patents, see <http://patents.dts.com>. Manufactured under license from DTS Licensing Limited. DTS, DTS-HD, the Symbol, & DTS and the Symbol together are registered trademarks, and DTS-HD Master Audio | Essential is a trademark of DTS, Inc. © DTS, Inc. All Rights Reserved.



Manufactured under license from Dolby Laboratories. Dolby and the double-D symbol are trademarks of Dolby Laboratories.



DivX®, DivX Certified®, DivX Plus® HD and associated logos are trademarks of Rovi Corporation or its subsidiaries and are used under license.

ABOUT DIVX VIDEO: DivX® is a digital video format created by DivX, LLC, a subsidiary of Rovi Corporation. This is an official DivX Certified® device that plays DivX video. Visit divx.com for more information and software tools to convert your files into DivX videos.

ABOUT DIVX VIDEO-ON-DEMAND: This DivX Certified® device must be registered in order to play purchased DivX Video-on-Demand (VOD) movies. To obtain your registration code, locate the DivX VOD section in your device setup menu. Go to vod.divx.com for more information on how to complete your registration.

DivX Certified® to play DivX® and DivX Plus® HD (H.264/MKV) video up to 1080p HD including premium content.



The terms HDMI and HDMI High-Definition Multimedia Interface, and the HDMI Logo are trademarks or registered trademarks of HDMI Licensing LLC in the United States and other countries.



The Bluetooth® word mark and logos are registered trademarks owned by Bluetooth SIG, Inc. and any use of such marks by Philips is under license. Other trademarks and trade names are those of their respective owners.



The N Mark is a trademark of NFC Forum, Inc. in the United States and in other countries.





Specifications are subject to change without notice
© 2014 Koninklijke Philips N.V. All rights reserved.
Trademarks are the property of Koninklijke Philips N.V. or their respective owners.

HTB3520G/3550G/3580G_12_QSG_V2.0

