

For product support, visit  
Para obtener asistencia técnica, visite  
Pour en savoir plus sur l'assistance sur les produits, visitez le site

[www.philips.com/support](http://www.philips.com/support)

HTB3524



# Quick start guide

**PHILIPS**



**EN: For further assistance, call the customer support service in your country.**

- To obtain assistance in the U.S.A., Canada, Puerto Rico, or the U.S. Virgin Islands, contact Philips Customer Care Center at 1 (866) 226-6074
- To obtain assistance in Mexico, contact Philips Customer Care Center at 01 800 839 1989; Mexico city: 5887-9736

**ES: Para obtener mas informacion, llame al servicio de soporte al cliente de su pais.**

- Para obtener asistencia en los Estados Unidos, en Canada, Puerto Rico o en las Islas Virgenes de los Estados Unidos, comuniquese con Centro de atencion al cliente de Philips al 1 (866) 226-6074
- Solo para Mexico CENTRO DE ATENCION A CLIENTES LADA, 01 800 839 1989 Solo Para Mexico; Mexico city: 5887-9736

**FR: Pour obtenir de l'aide supplementaire, communiquez avec le centre de service a la clientele de votre pays.**

- Pour obtenir de l'aide aux Etats-Unis, au Canada, a Puerto Rico ou aux Iles Vierges americaines, communiquez avec le centre de service a la clientele Philips au : 1 (866) 226-6074
- Pour obtenir l'aide au Mexique, entrez en contact avec le centre de soin de client de Philips a 01 800 839 1989; Mexico city: 5887-9736

For Product recycling information, please visit - [www.recycle.philips.com](http://www.recycle.philips.com)

Para obtener información de productos de reciclaje, por favor visite - [www.recycle.philips.com](http://www.recycle.philips.com)

Pour tout renseignement sur le recyclage des produits, veuillez visiter - [www.recycle.philips.com](http://www.recycle.philips.com)



**EN** Before using your product, read all accompanying safety information

**ES** Antes de usar el producto, consulte la información de seguridad que se encuentra adjunta

**FR-CA** Avant d'utiliser votre produit, prenez le temps de lire toute l'information de sécurité connexe

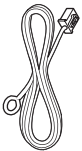
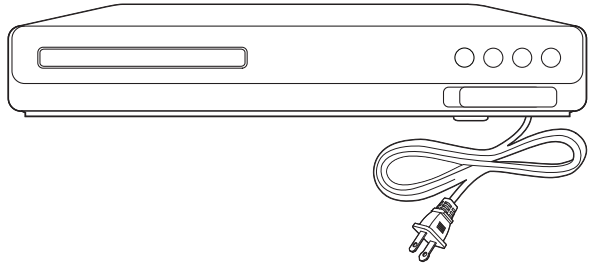
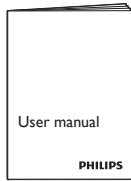
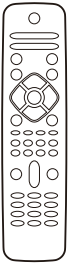

FM Antenna

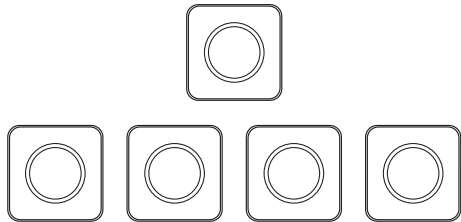
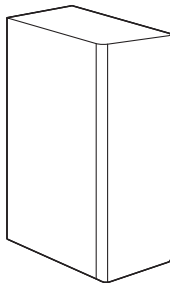

# 1

**EN** Connect the home theater

**ES** Conexión del Home Theater

**FR-CA** Branchez le cinéma maison

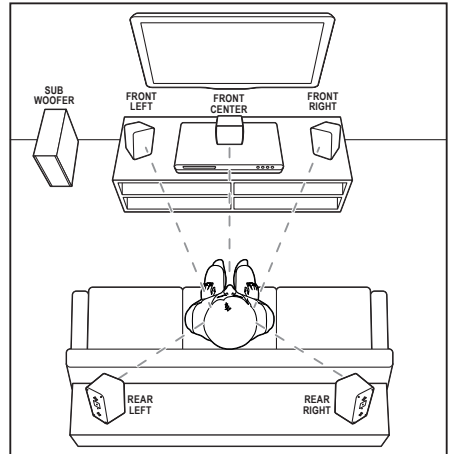
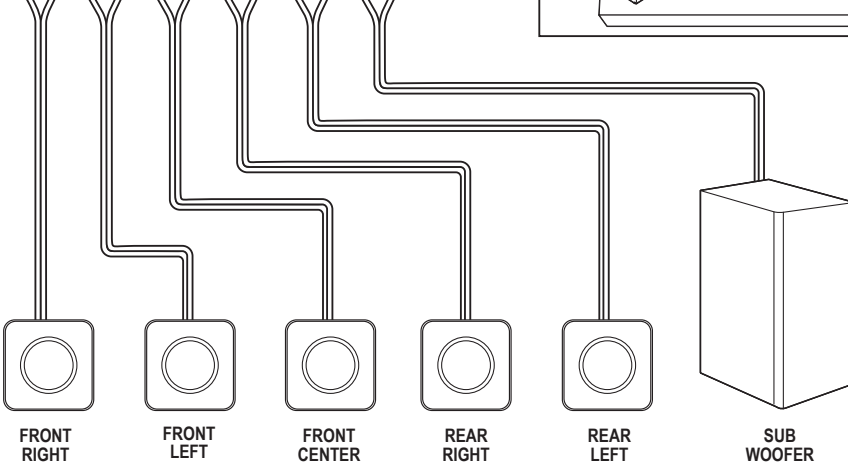
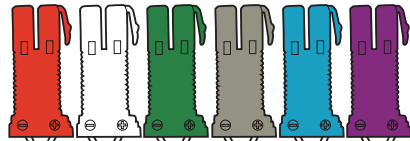
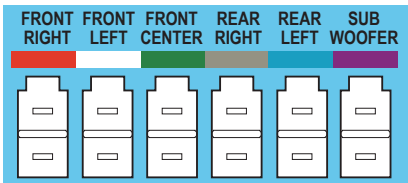
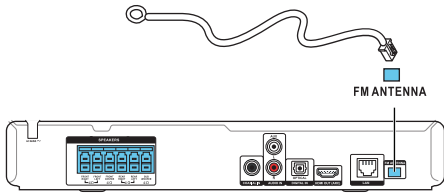

# 2

**EN** Connect to TV in one of these ways

**ES** Conecte la Home Theater a la TV de una de las siguientes formas

**FR-CA** Le branchement du cinéma maison au téléviseur peut se faire des façons suivantes

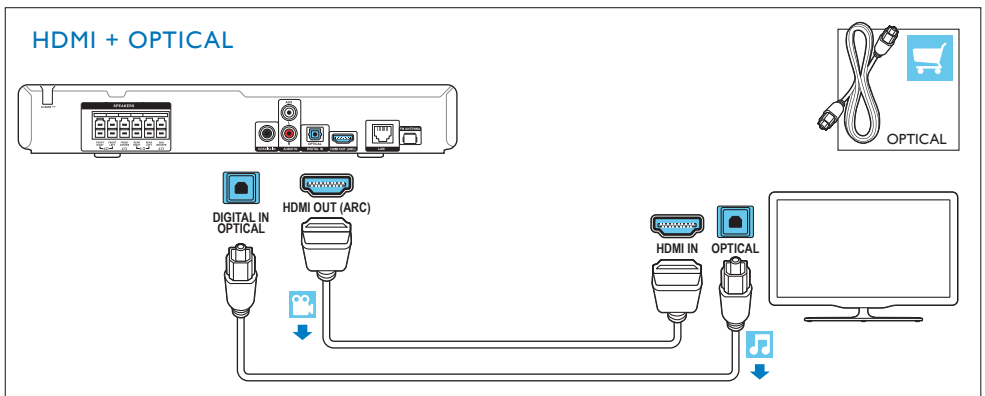
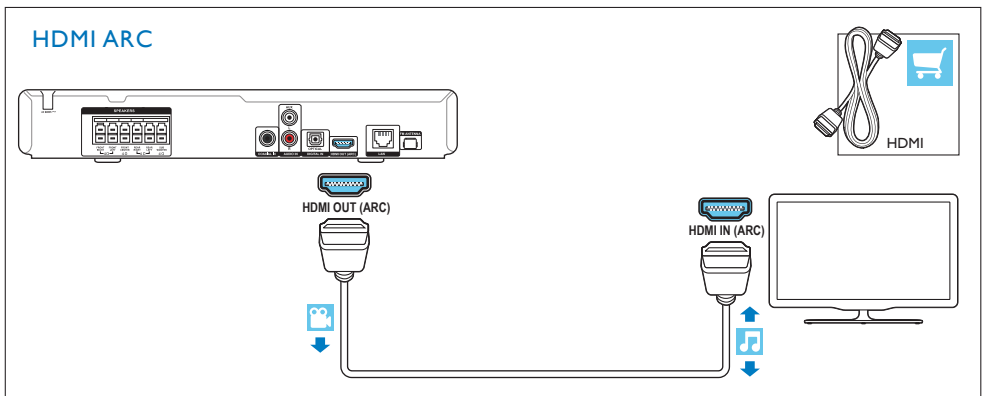

## HDMI + COAXIAL

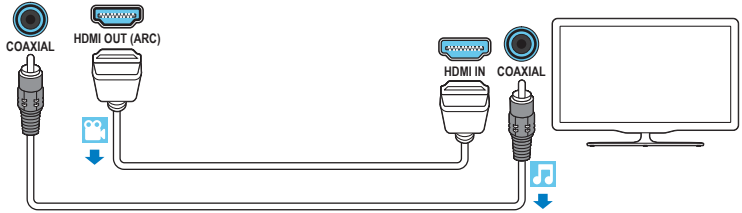

## HDMI + AUDIO L/R

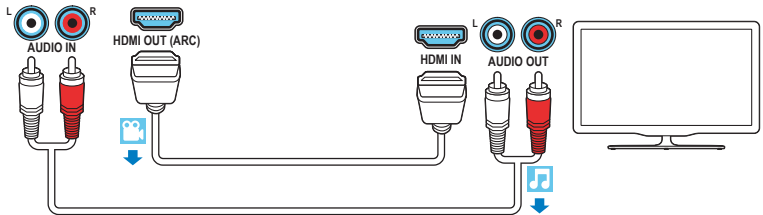
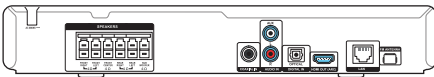

# 3

**EN** Switch on the home theater

**ES** Encendido del Home Theater

**FR-CA** Allumez le cinéma maison

1

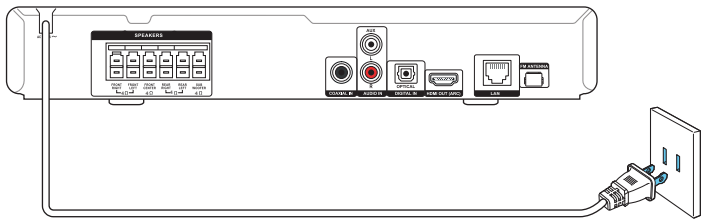

2

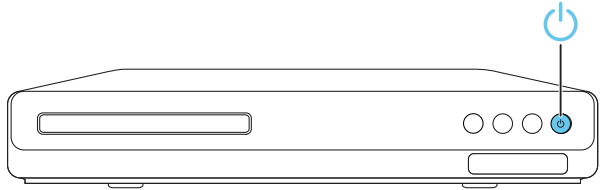

3

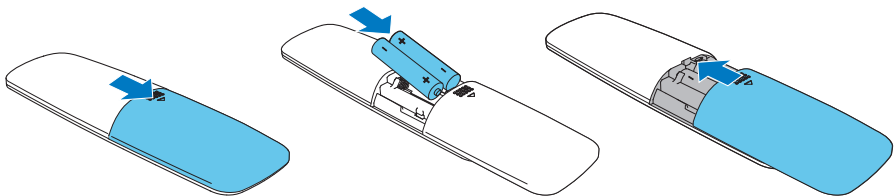

# 4

**EN** Complete the first time setup

**ES** Proceso de configuración inicial

**FR-CA** Effectuez la première configuration

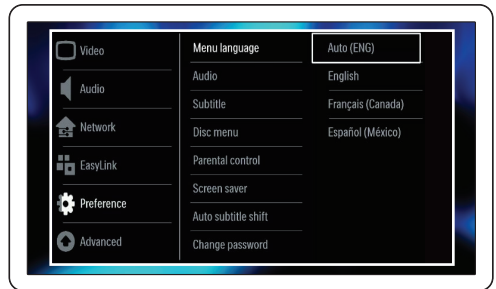
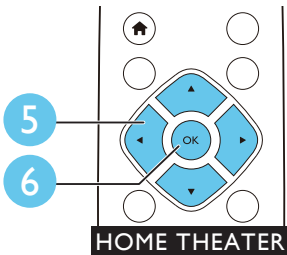
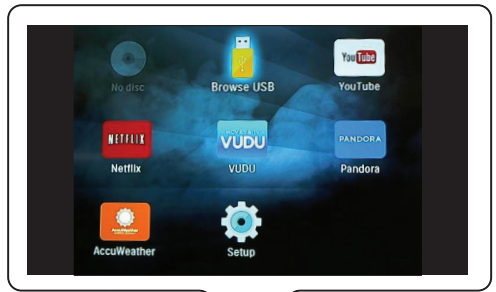
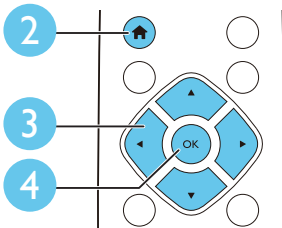
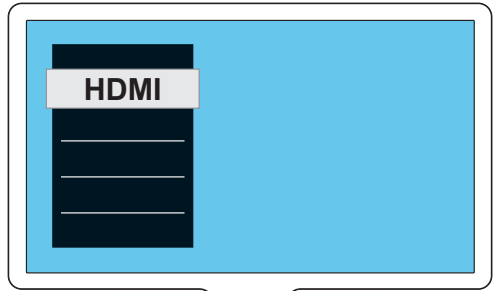
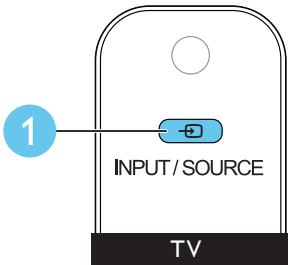



# 5

**EN** Use your home theater

**ES** Uso del sistema de Home Theater

**FR-CA** Utilisez votre cinéma maison

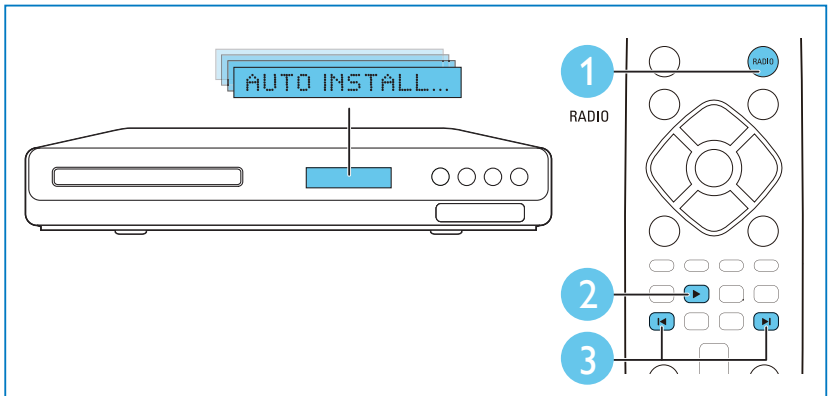
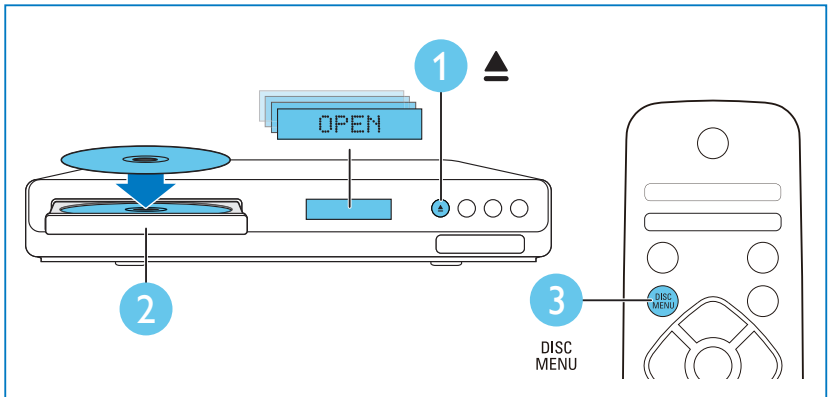



**EN** For more information about using this product, visit [www.philips.com/support](http://www.philips.com/support)

**ES** Para obtener más información acerca de este producto, visite [www.philips.com/support](http://www.philips.com/support)

**FR-CA** Pour en savoir plus sur l'utilisation de ce produit, visitez le site [www.philips.com/support](http://www.philips.com/support)



[www.philips.com/support](http://www.philips.com/support)



P&F USA, Inc.  
PO Box 2248 Alpharetta, GA 30023-2248



**SISTEMA REPRODUCTOR DE DISCO DE VIDEO DIGITAL (BLURAY)**

**HTB3524/F7**

120V ~ 60Hz

**Consumo de Energía Eléctrica**

**60 W**

**Consumo de energía eléctrica del aparato en modo de espera**

**25.158 Wh**

**0.252 Wh**

**Comercializado por :** P&F MEXICANA. S.A. DE C.V.

**IMPORTADOR:** P&F MEXICANA. S.A. DE C.V.

Av. La Palma #6.  
Col. San Fernando La Herradura  
Huixquilucan, Edo. México.  
MEXICO C.P.52787.  
Tel: 52 (55) 5269 - 9000

**EXPORTADOR:** P&F USA Inc.

**HECHO EN:** CHINA



**GARANTIA INCLUIDA EN EL INSTRUCTIVO DE USO**

**LEA CUIDADOSAMENTE ESTE INSTRUCTIVO  
ANTES DE USAR SU APARATO.**

Specifications are subject to change without notice

© 2015 Koninklijke Philips N.V. All rights reserved.

Trademarks are the property of Koninklijke Philips N.V. or their respective owners.

HTB3524 \_F7\_QSG\_V5.0

