

Register your product and get support at  
[www.philips.com/welcome](http://www.philips.com/welcome)

4000 series - LED TV

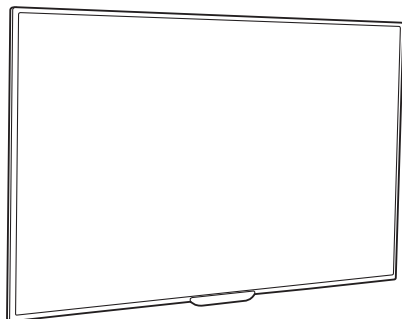

x4



(EU)



(UK)

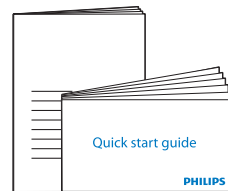

**PHILIPS**



p.3

or

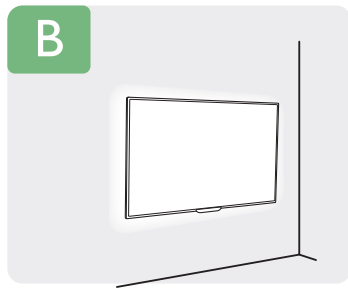

p.5



**English** Read the safety instructions.  
**Български** Прочетете инструкциите за безопасност.  
**Čeština** Přečtěte si bezpečnostní pokyny.  
**Hrvatski** Pročitajte sigurnosne upute.  
**Dansk** Læs sikkerhedsforskrifterne.  
**Deutsch** Lesen Sie die Sicherheitshinweise.  
**Ελληνικά** Διαβάστε τις οδηγίες ασφαλείας.  
**Eesti** Lugege ohutusnõudeid.  
**Español** Lea las instrucciones de seguridad.

**Français** Lisez les consignes de sécurité.  
**Italiano** Leggere le istruzioni di sicurezza.  
**Қазақша** Қорғаныстық нұсқаулар.  
**Lietuvių** Izlasiet drošības norādījumus.  
**Magyar** Perskaitykite saugos instrukcijas.  
**Nederlands** Olvassa el a biztonsági utasításokat.  
**Norsk** Lees de veiligheidsvoorschriften.  
**Polski** Les sikkerhetsforskriftene.  
**Português** Zapoznaj się z instrukcjami bezpieczeństwa.

**Português** Leia as instruções de segurança.  
**Română** Citiți instrucțiunile de siguranță.  
**Русский** Читайте инструкции по технике безопасности.  
**Srpski** Pročitajte bezbednosna uputstva.  
**Slovenščina** Preberite varnostna navodila.  
**Slovenský** Prečítajte si bezpečnostné pokyny.  
**Suomi** Lue turvaohjeet.  
**Svenska** Läs säkerhetsinstruktionerna.  
**ภาษาไทย** โปรดอ่านคำแนะนำด้านความปลอดภัย

**Türkçe** Güvenlik talimatlarını okuyun.  
**Українська** Читайте інструкції з техніки безпеки.

**العربية** قراءة تعليمات السلامة.  
**עברית** קראו את הוראות הבטיחות

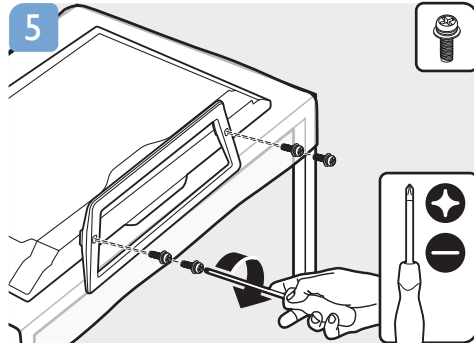
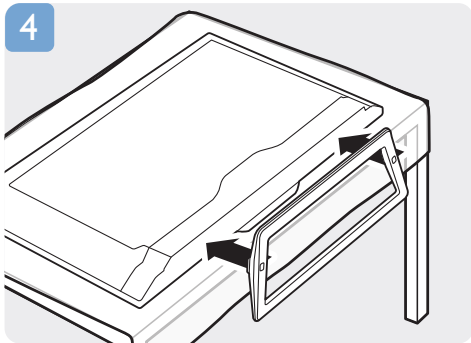
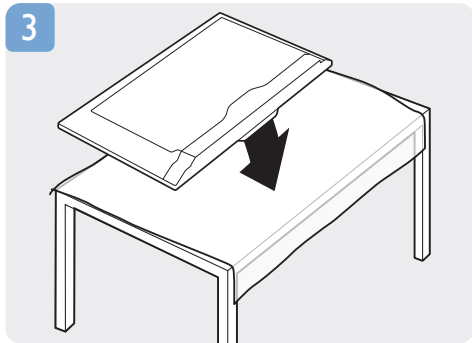
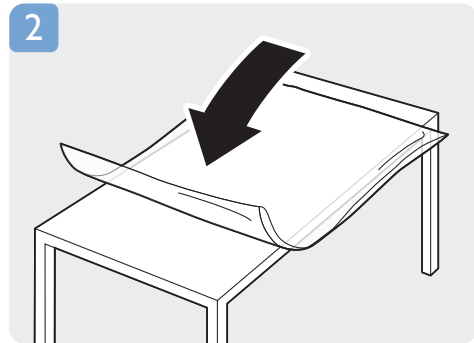
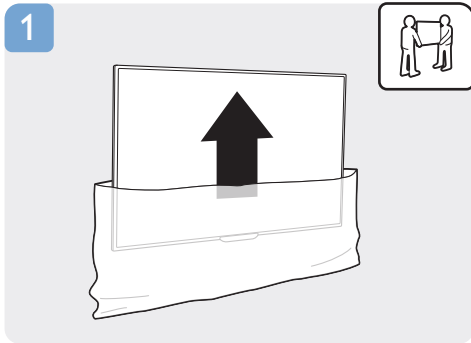
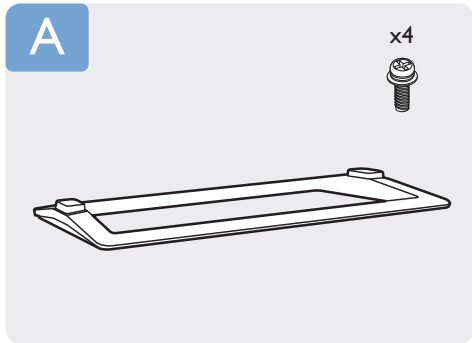

6

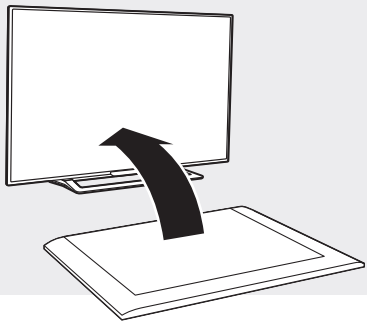

7

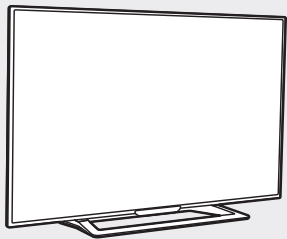

p.6

B

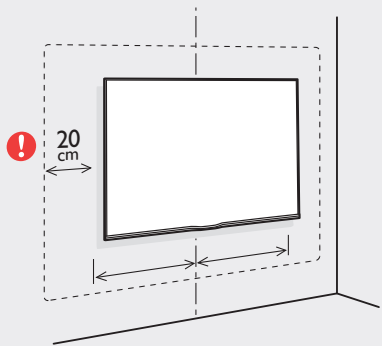

p.6

VESA (x, y)  
50" 400x200 M6  
40" 200x200 M4

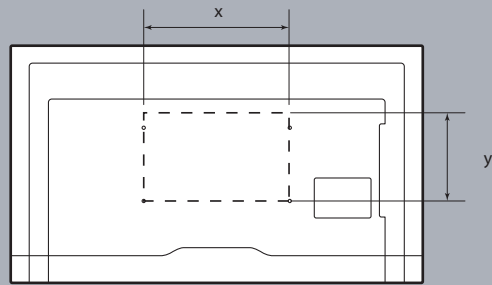
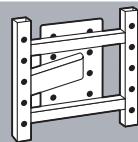

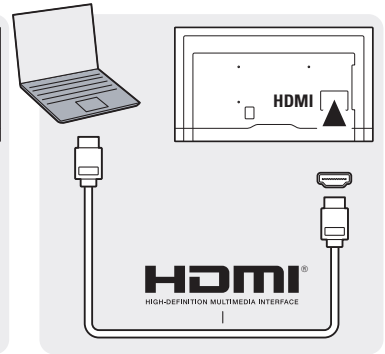
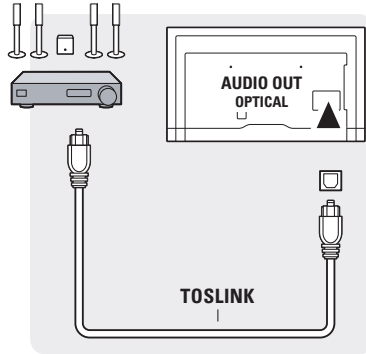
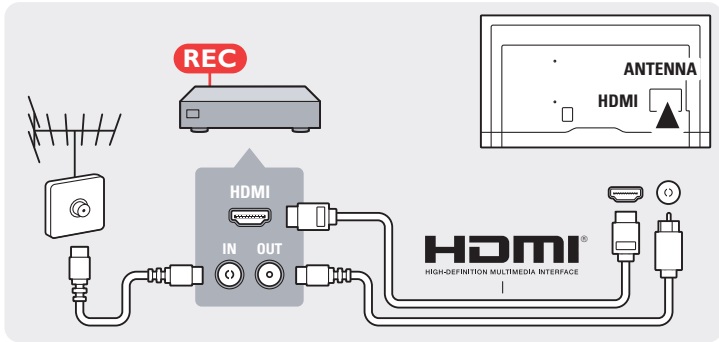
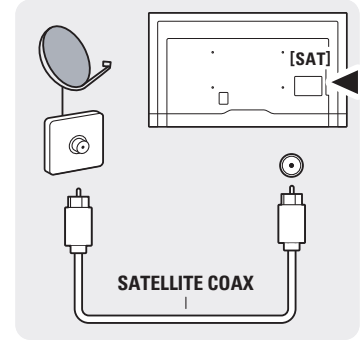
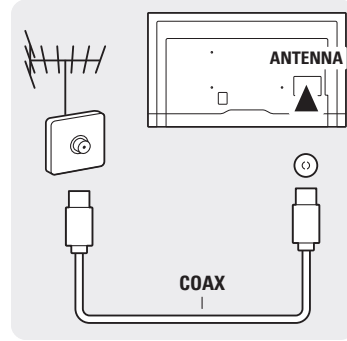
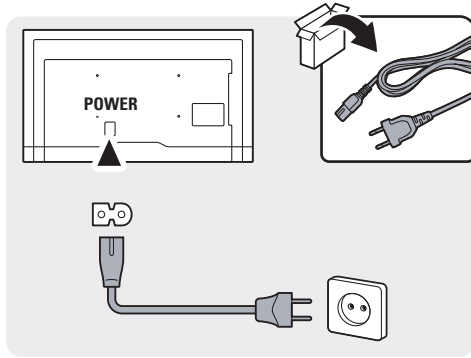
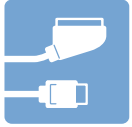

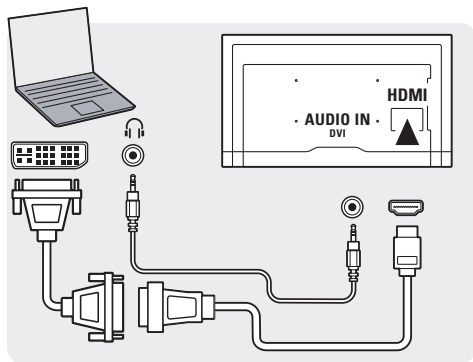
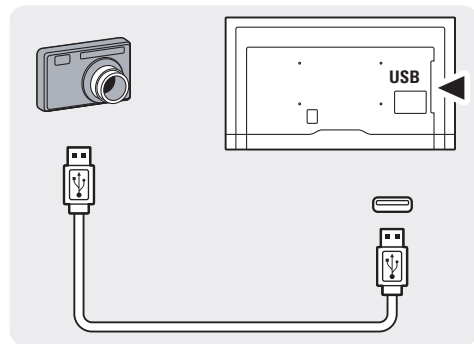
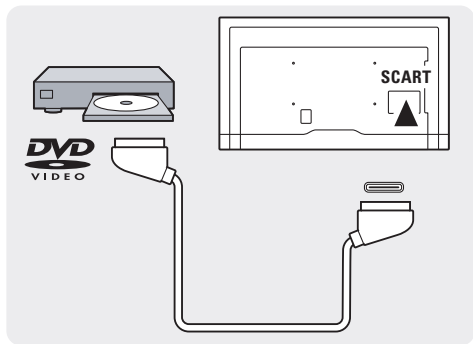
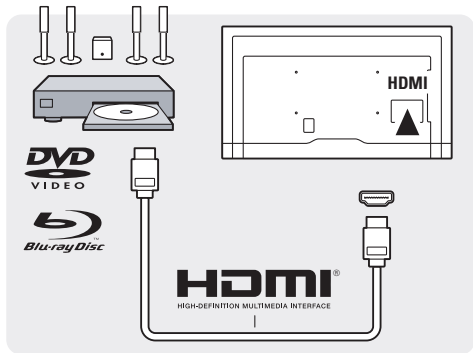

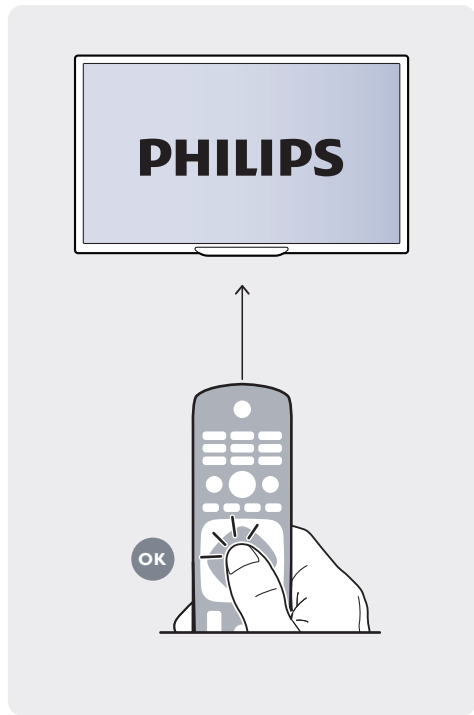
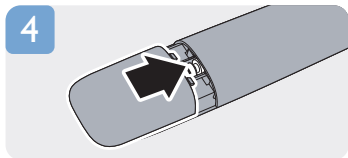
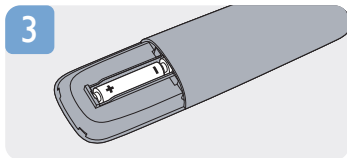
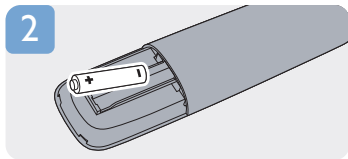
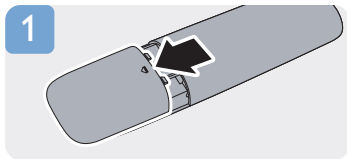











# Always here to help you

[www.philips.com/support](http://www.philips.com/support)



User Manual



Frequently Asked Questions



Warranty



Philips support forum



Live Chat



Call Center



Email

**България**  
Грижа за клиента  
**02 4916 273**  
(Национален номер)

**België/Belgique**  
Klantenservice/  
Service Consommateurs  
**070 700 035**  
(Lokaal gesprek / Appel local)

**Bosna i Hercegovina**  
Potpora potrošačima  
**033 941 251**  
(Lokalni poziv)

**Србија**  
Potpora potrošačima  
**011 321 6840**  
(Lokalni poziv)

**Česká republika**  
Zákaznická podpora  
**228 880 895**  
(Místní tarif)

**Danmark**  
Kundeservice  
**3525 8314**

**Deutschland**  
Kundendienst  
**069 66 80 10 10**  
(Zum Festnetztarif ihres Anbieters)

**Ελλάδα**  
Τμήμα καταναλωτών  
**2111983028**  
(Διεθνής κλήση)

**Eesti**  
Klienditugi  
**6683061**  
(Kohalikud kõned)

**España**  
Atención al consumidor  
**913 49 65 82**  
(Llamada local)

**France**  
Service Consommateurs  
**01 57 32 40 50**  
(coût d'un appel local sauf surcoût éventuel selon opérateur réseau)

**Hrvatska**  
Potpora potrošačima  
**01 777 66 01**  
(Lokalni poziv)

**Ireland**  
Consumer Care  
**015 24 54 45**  
(Local cost)

**Italia**  
Servizio Consumatori  
**02 45287014**  
(Chiamata nazionale)

**Қазақстан Республикасы**  
байланыс орталығы  
**810 800 2000 00 04**  
(стационарлық нөмірлерден  
Қазақстан Республикасы бойынша  
конфирмау шалу тегін)

**Latvija**  
Klientu atbalsts  
**6616 3263**  
(Vietēlais tarifs)

**Lietuva**  
Klientų palaikymo tarnyba  
**8 52140293**  
(Vietinai tarifais)

**Luxembourg**  
Service Consommateurs  
**2487 1100**  
(Appel national)/(Nationale Ruf)

**Magyarország**  
Ügyfélszolgálat  
**(06 1) 700 8151**  
(Belföldi hívás)

**Nederland**  
Klantenservice  
**0900 202 08 71**  
(1 €/per gesprek)

**Norge**  
Forbrukerstøtte  
**22 97 19 14**

**Österreich**  
Kundendienst  
**0150 28 42 140**  
(Ortsgespräch)

**Республика Беларусь**  
Контакт Центр  
**8 10 (800) 2000 00 04**  
(бесплатный звонок по  
Республике Беларусь со стационарных  
номеров)

**Российская Федерация**  
Контакт Центр  
**8 (800) 220 00 04**  
бесплатный звонок по России

**Polska**  
Wsparcie Klienta  
**22 3971504**  
(Połączenie lokalne)

**Portugal**  
Assistência a clientes  
**800 78 00 68**  
(Grátis. Operadoras de telefonia móvel podem cobrar custos.)

**România**  
Serviciul Clienti  
**031 6300042**  
(Tarif local)

**Schweiz/Suisse/Svizzera**  
Kundendienst/Service Consommateurs/  
Servizio Consumatori  
**0848 000 291**  
(0,081 CHF/Min)

**Slovenija**  
Skrb za potrošnike  
**01 8888 312**  
(Lokalni klic)

**Slovensko**  
Zákaznická podpora  
**02 - 33215493**  
(vnútroštátny hovor)

**Suomi**  
Finland Kuluttajapalvelu  
**09 8862 5040**

**Sverige**  
Kundtjänst  
**08-5792 9096**

**Türkiye**  
Tüketici Hizmetleri  
**444 8 445**

**Україна**  
Служба підтримки споживачів  
**0-800-500-480**  
(зв'язки зі стаціонарних телефонів  
безкоштовні)

**United Kingdom**  
Consumer Care  
**020 79 49 03 19**  
(Local cost)

**Argentina**  
Consumer Care  
**0800 444 7749**

**Buenos Aires**  
Consumer Care  
**0810 444 7782**

**Brasil**  
Suporte ao Consumidor  
**0800 701 0245**

**Brasil (São Paulo)**  
Suporte ao Consumidor  
**2938 0245**



All registered and unregistered trademarks are the property of their respective owners. Specifications are subject to change without notice. Philips and the Philips' shield emblem are registered trademarks of Koninklijke Philips N.V. and are used under license from Koninklijke Philips N.V. 2014 © TP Vision Europe B.V. All rights reserved. [www.philips.com](http://www.philips.com)