

Always there to help you

Register your product and get support at
www.philips.com/welcome



HTB5520

HTB5550

HTB5580

Quick start guide

PHILIPS



EN Before using your product, read all accompanying safety information

PT-BR Antes de usar o produto, leia todas as informações de segurança em anexo.



HTB5520

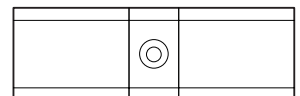
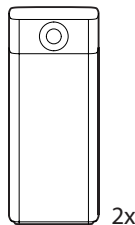
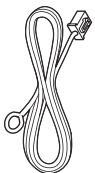
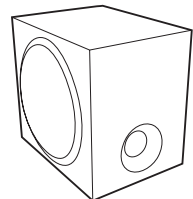
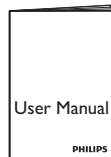
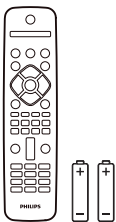
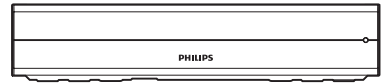

HTB5550

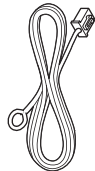
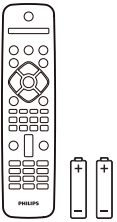
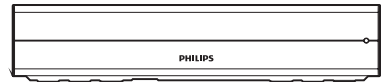
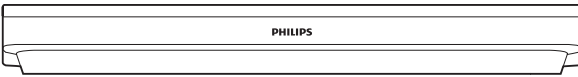

FM Antenna



HDMI

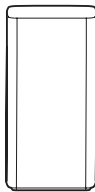
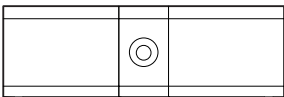
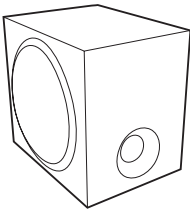
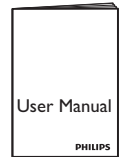

2x

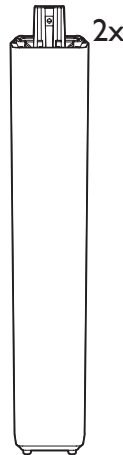

2x

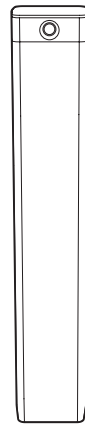

2x



8x



2x

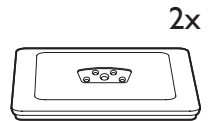

2x

HTB5580

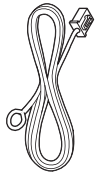
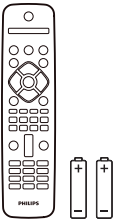
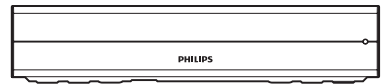
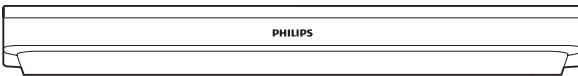

FM Antenna



HDMI

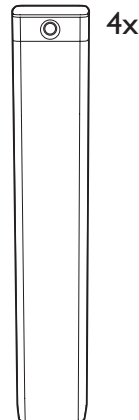
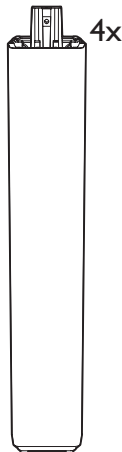
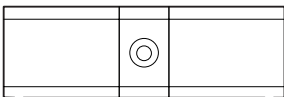
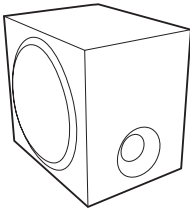
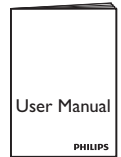

4x

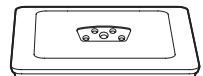

1

EN Stand mount the speakers
Applied to HTB5550 and HTB5580 only

PT-BR Montar as caixas acústicas
Aplica-se somente aos modelos HTB5550 e HTB5580

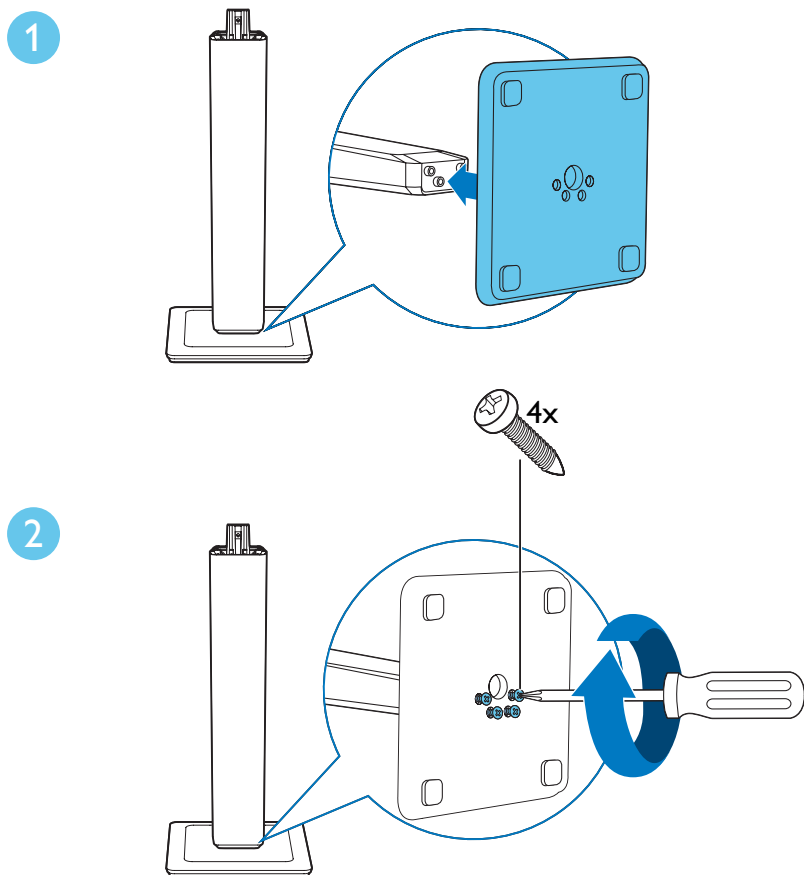

3

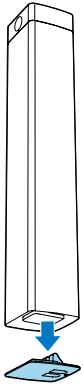

4

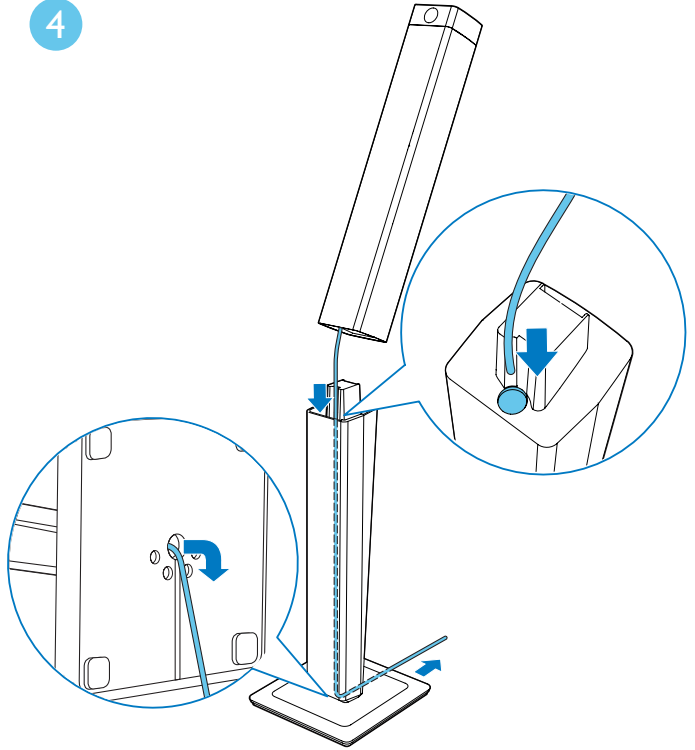

5

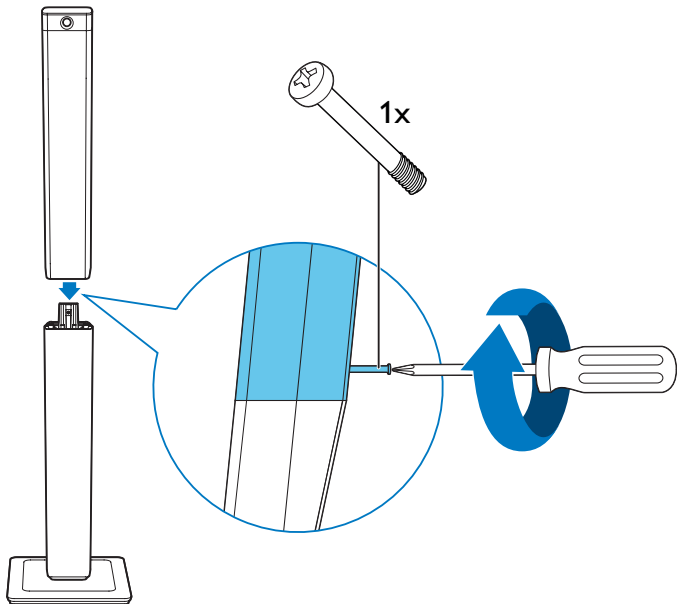

2

EN Connect the home theater

PT-BR Conectar o Home Theater

HTB5520

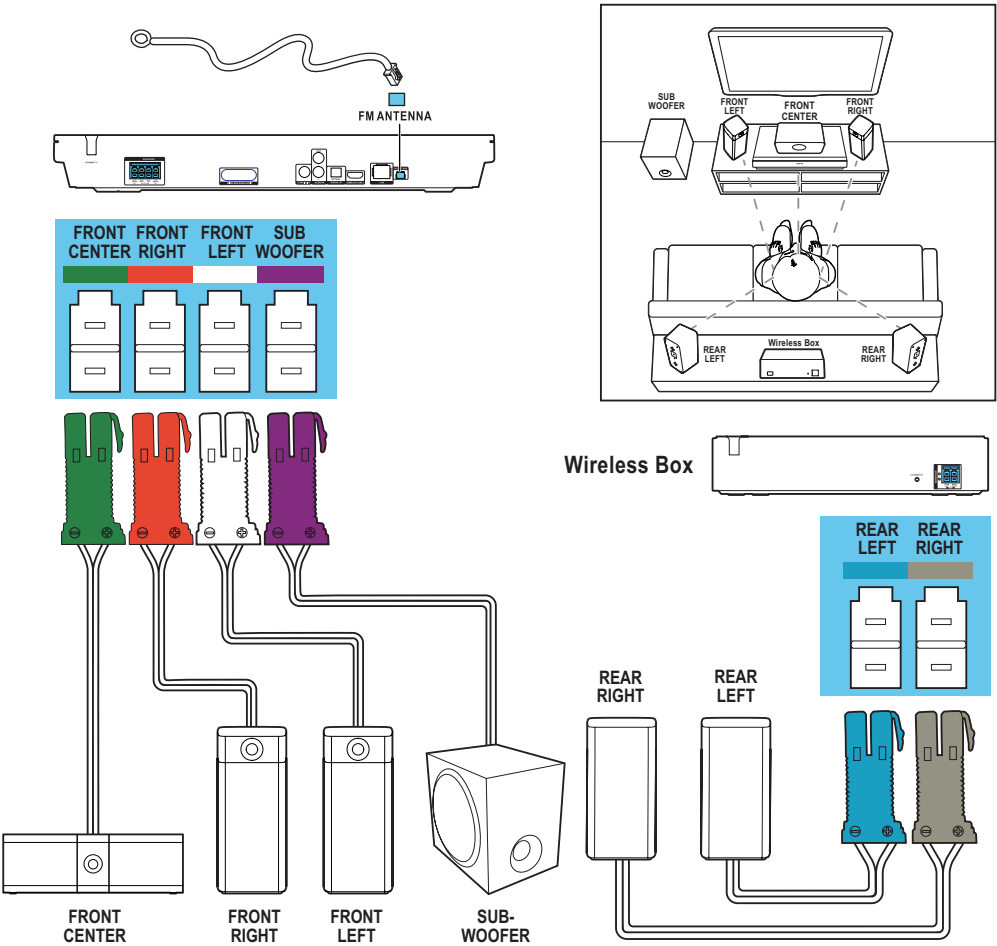

HTB5550

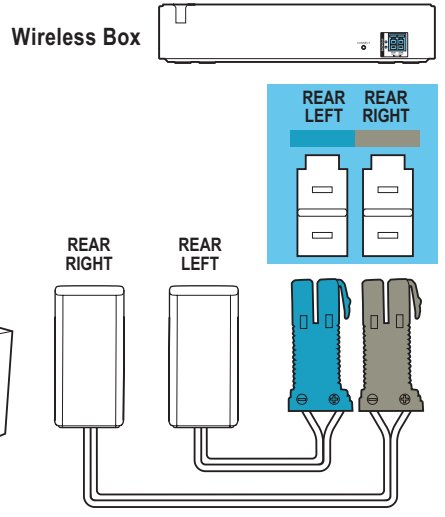
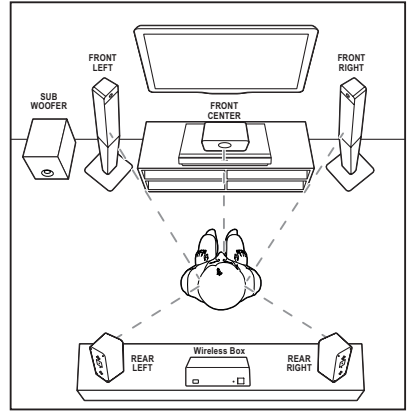
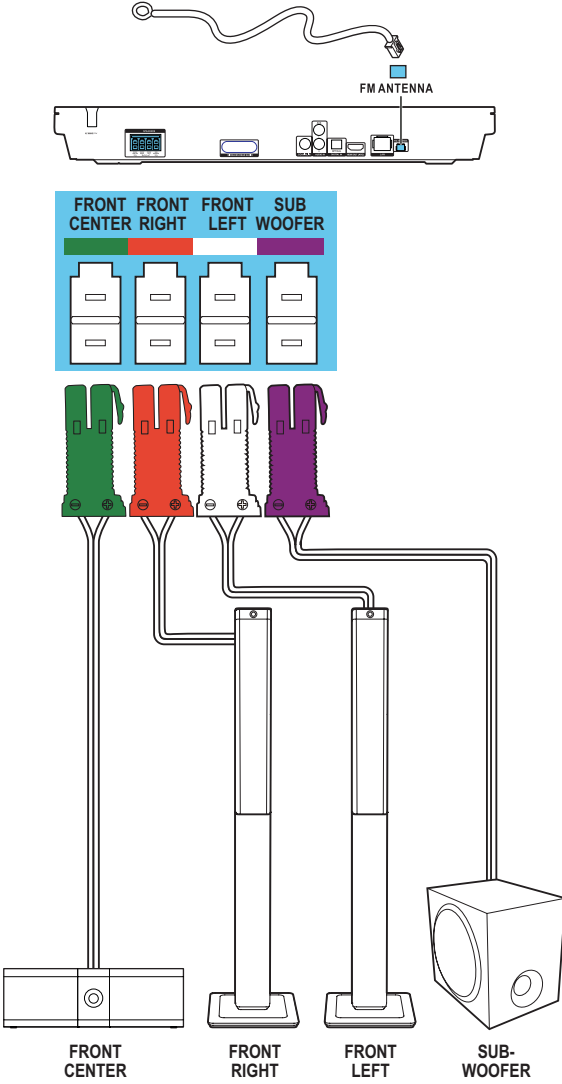

HTB5580

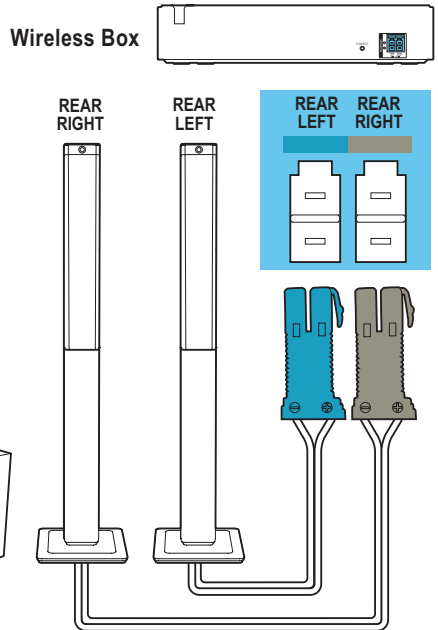
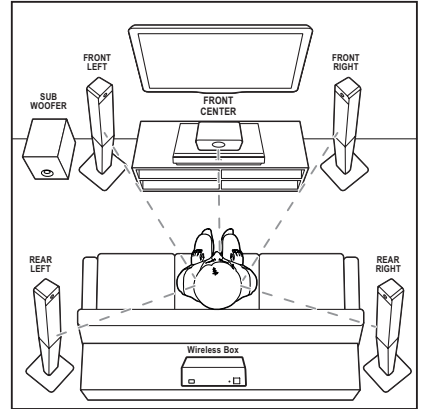
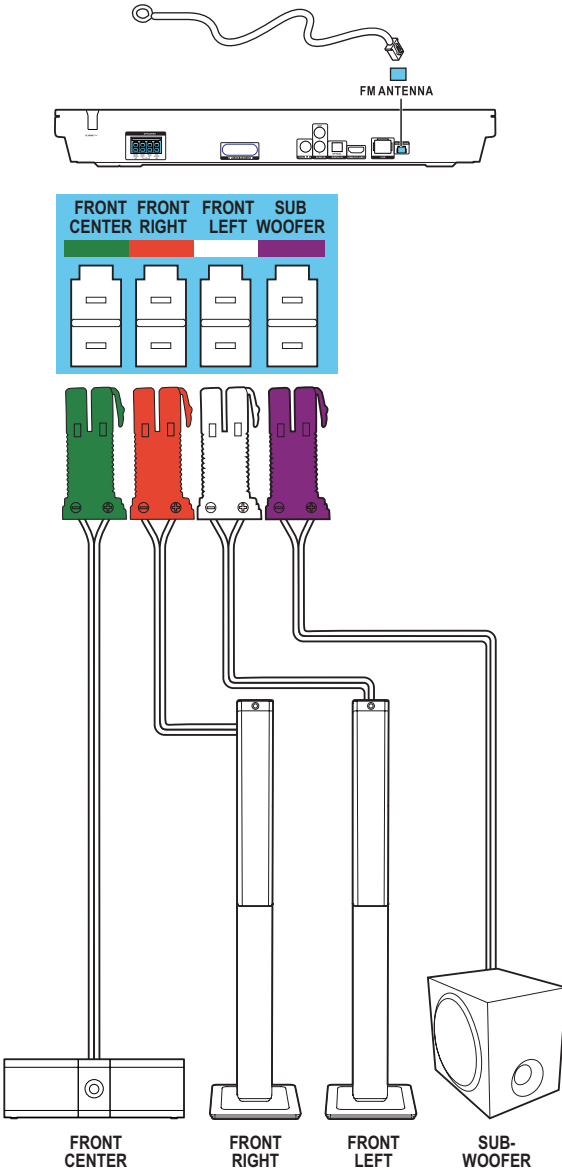

3

EN Connect to TV in one of these ways

PT-BR Conectar à TV.

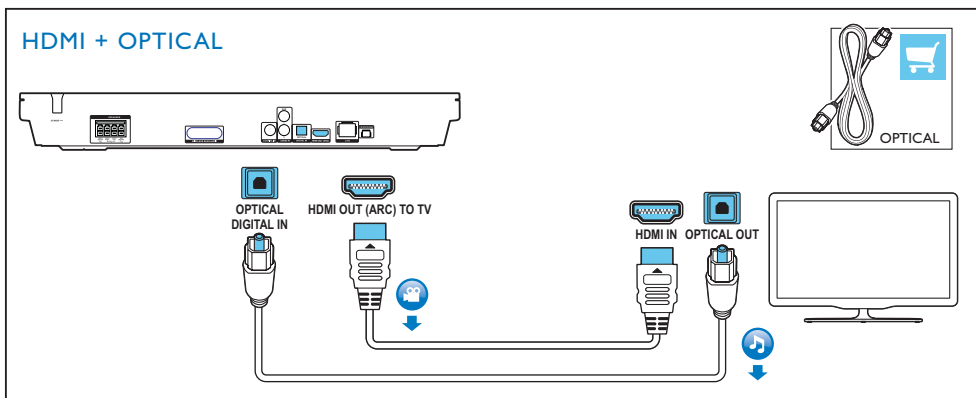
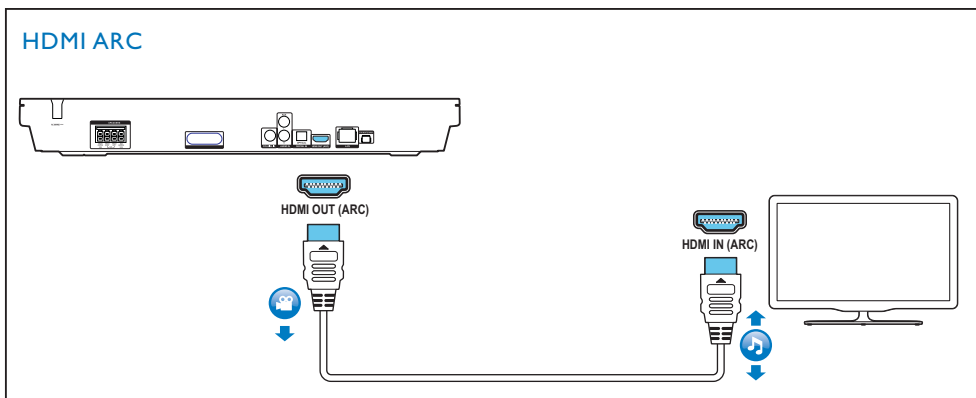

HDMI + COAXIAL



COAXIAL IN

HDMI OUT (ARC)



HDMI IN

COAXIAL OUT

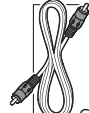
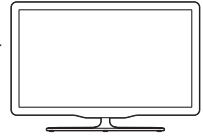

COAXIAL

HDMI + AUDIO L/R



AUDIO IN

HDMI OUT (ARC) TO TV

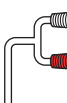

HDMI IN

AUDIO OUT

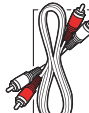
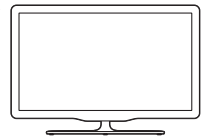

AUDIO L/R

4a

EN Switch on the home theater

PT-BR Ligar o Home Theater

1

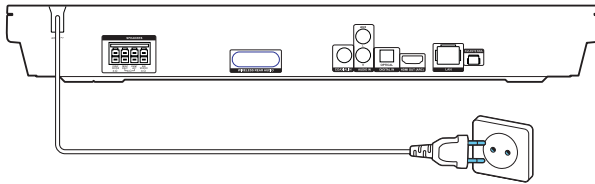

2

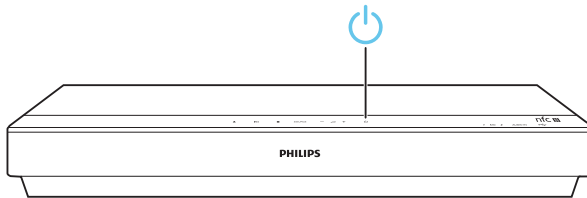

3

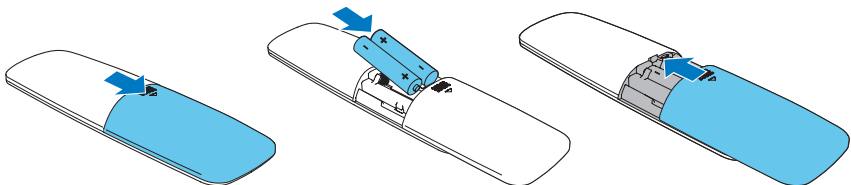

4b

EN Pair up the rear speakers (For the written instructions on pair-up of the rear speakers, refer to Chapter 3 “Connect and setup” of the User Manual.)

PT-BR Emparelhar as caixas de som traseiras (para instruções por escrito sobre o emparelhamento das caixas de som traseiras, consulte o capítulo 2 “Conectar e configurar” do manual do usuário).

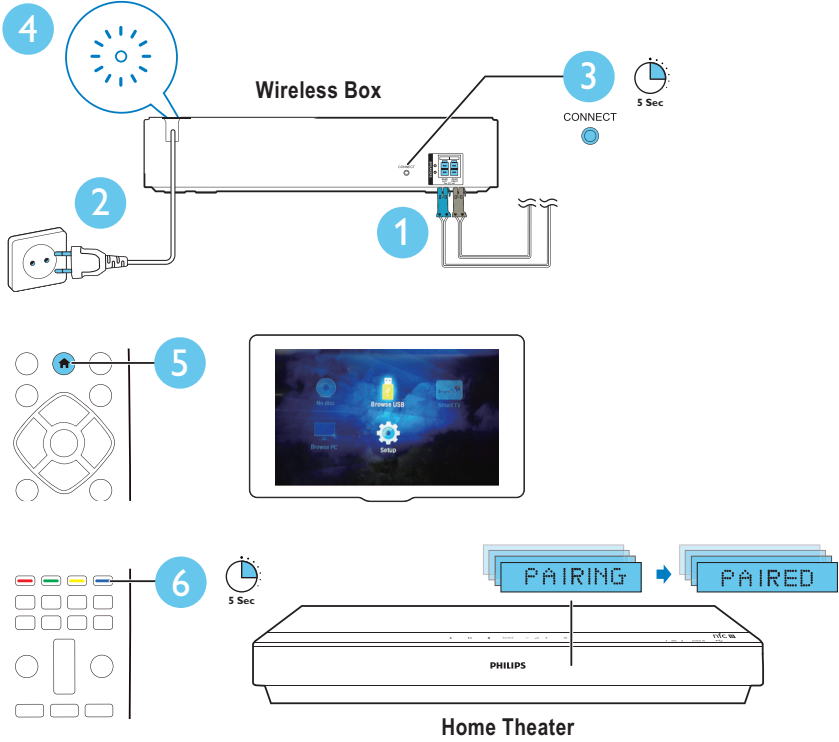

5

EN Complete the first time setup

PT-BR Fazer a configuração inicial

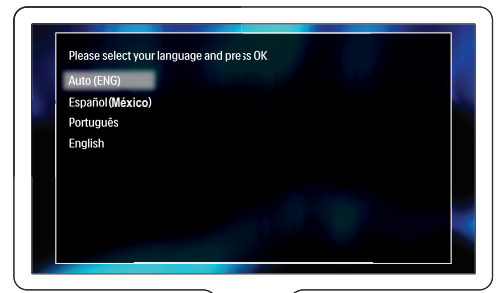
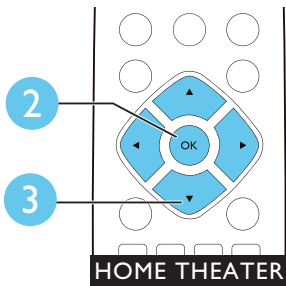
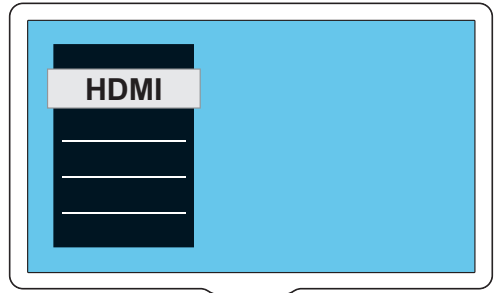
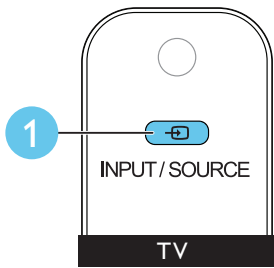

6

EN Use your home theater

PT-BR Usar o Home Theater

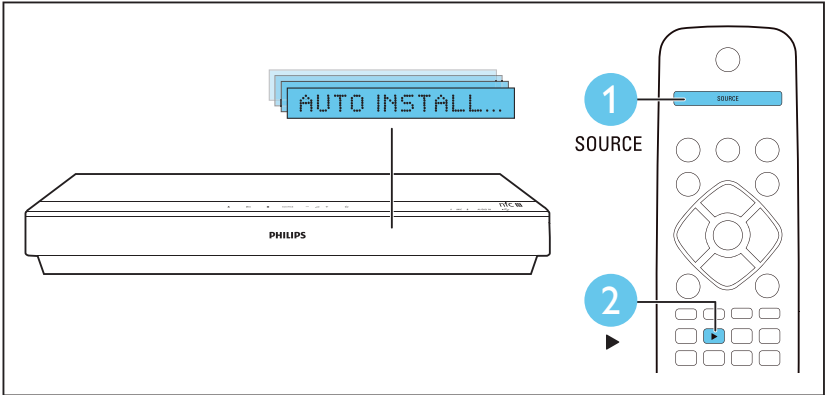
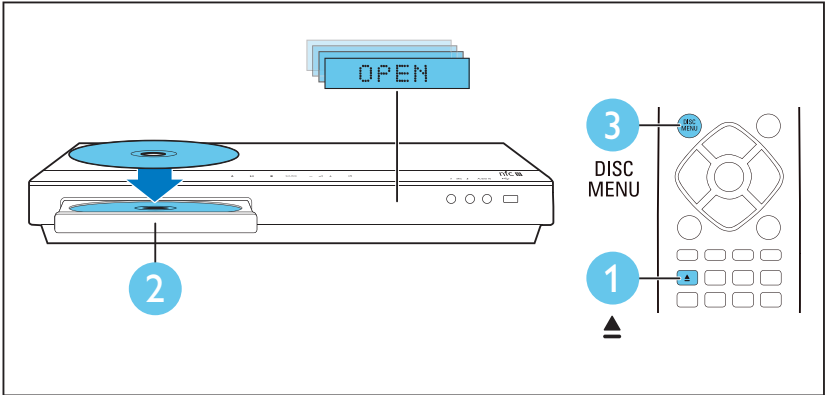

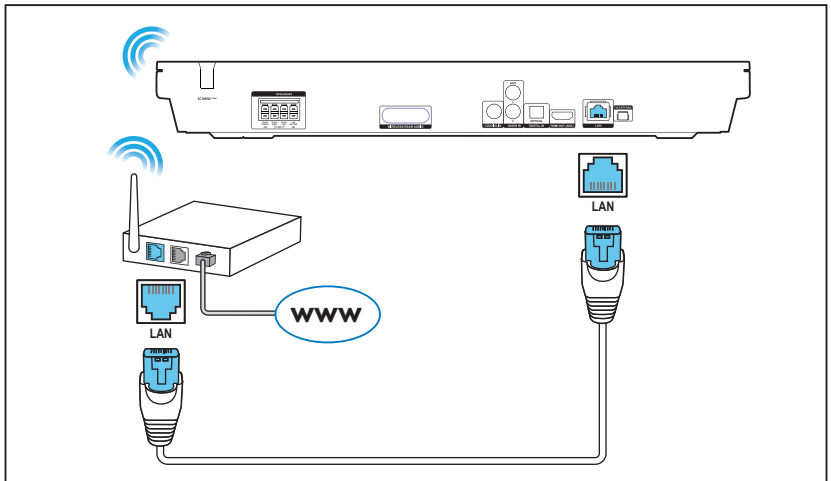
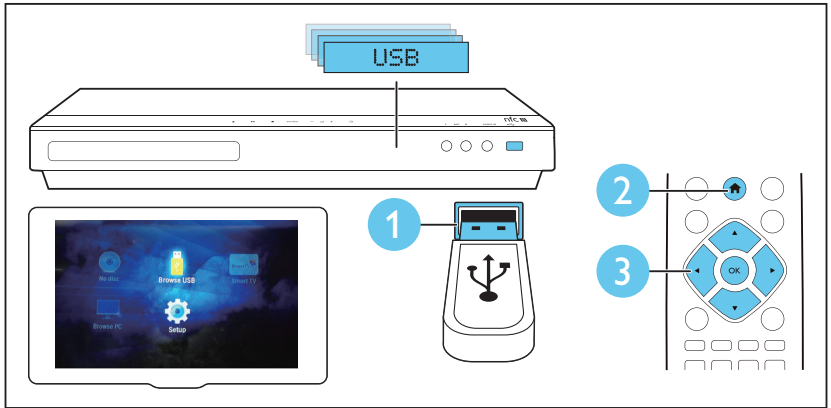
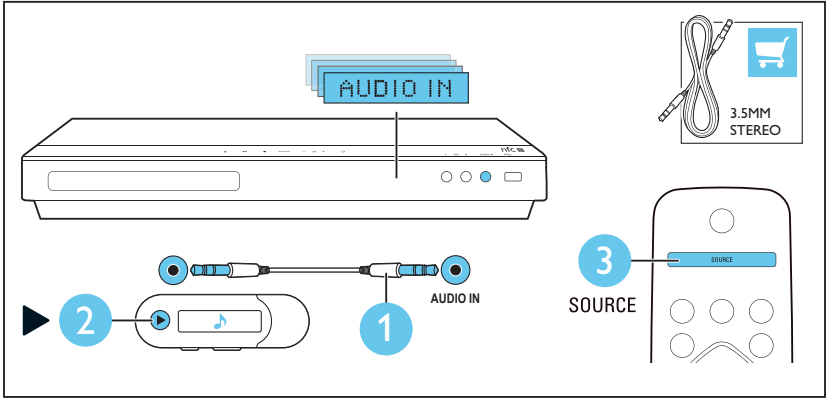

7

EN Play audio through Bluetooth or connect Bluetooth via NFC

PT-BR Reproduzir áudio via Bluetooth ou conectar o Bluetooth via NFC

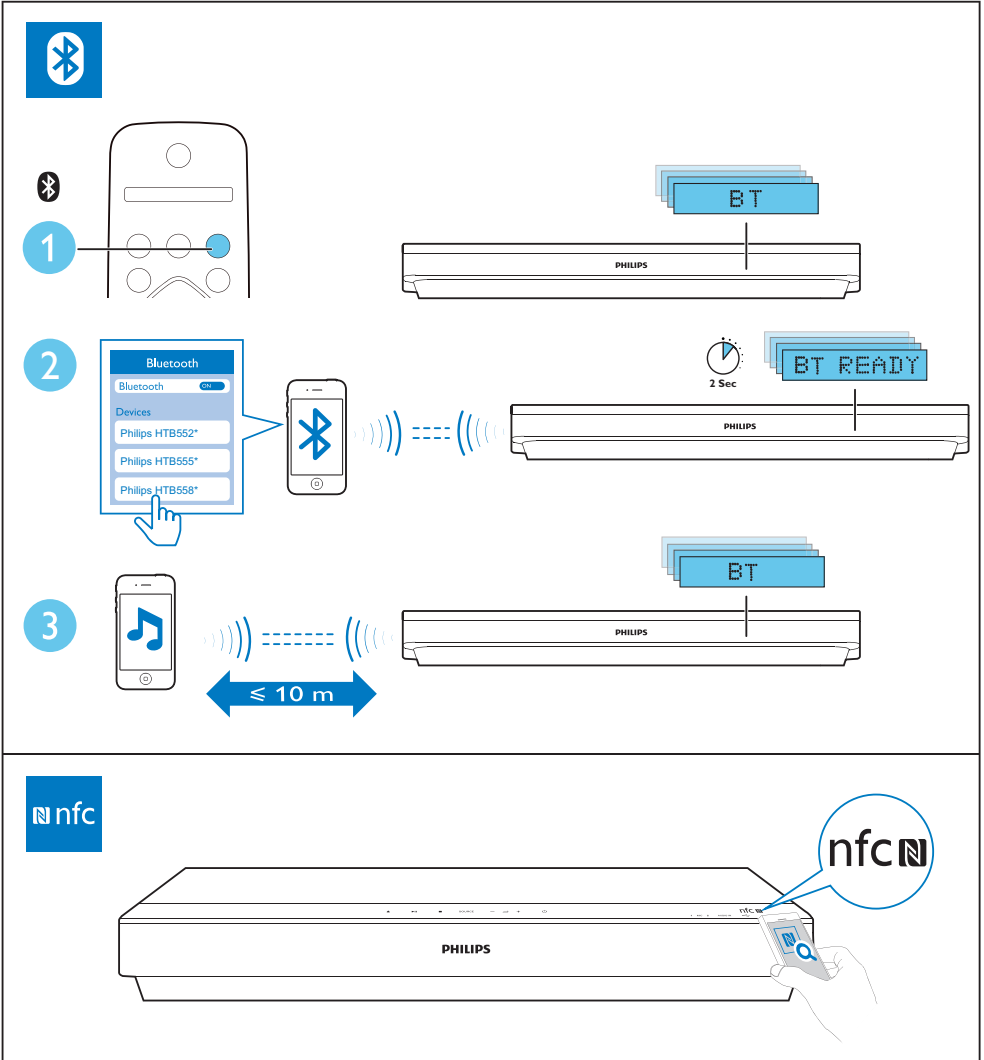



EN For more information about using this product, visit www.philips.com/support

PT-BR Faça o download de atualizações do software e do manual do usuário em www.philips.com/support



www.philips.com/support



Specifications are subject to change without notice

© 2014 Koninklijke Philips N.V. All rights reserved.

Trademarks are the property of Koninklijke Philips N.V. or their respective owners.

HTB5520/5550/5580_78_QSG_V1.0

