

NBG-418N

Wireless N Home Router

User's Guide



Default Login Details

LAN IP Address	http://192.168.1.1
User Name	admin
Password	1234

Version 1.00
Edition 1, 4/2012

www.zyxel.com

ZyXEL

IMPORTANT!

READ CAREFULLY BEFORE USE.

KEEP THIS GUIDE FOR FUTURE REFERENCE.

Graphics in this book may differ slightly from the product due to differences in operating systems, operating system versions, or if you installed updated firmware/software for your device. Every effort has been made to ensure that the information in this manual is accurate.

Related Documentation

- Quick Start Guide

The Quick Start Guide shows how to connect the NBG-418N and configure it using the Web Configurator wizard.

Contents Overview

User's Guide	11
Introduction	13
The Web Configurator	17
Connection Wizard	21
Modes	35
Tutorials	57
Technical Reference	65
Wireless LAN	67
WAN	85
LAN	93
DHCP Server	97
Network Address Translation	101
Dynamic DNS	109
Firewall	111
Remote Management	115
Universal Plug-and-Play (UPnP)	119
System	125
Logs	129
Tools	131
Sys OP Mode	137
Language	139
Troubleshooting	141

Table of Contents

Contents Overview	3
Table of Contents	5
Part I: User's Guide	11
Chapter 1	
Introduction.....	13
1.1 Overview	13
1.2 Securing the NBG-418N	14
1.3 LEDs	15
1.4 The WPS Button	15
1.5 Wall Mounting	16
Chapter 2	
The Web Configurator	17
2.1 Overview	17
2.2 Accessing the Web Configurator	17
2.3 Resetting the NBG-418N	19
2.3.1 Using the RESET Button	19
Chapter 3	
Connection Wizard	21
3.1 Wizard Setup	21
3.2 Connection Wizard: STEP 1: System Information	22
3.2.1 System Name	22
3.2.2 Domain Name	23
3.3 Connection Wizard: STEP 2: Wireless LAN	23
3.3.1 WPA-PSK or WPA2-PSK Security	24
3.4 Connection Wizard: STEP 3: Internet Configuration	25
3.4.1 Ethernet Connection	26
3.4.2 PPPoE Connection	26
3.4.3 PPTP Connection	27
3.4.4 Your IP Address	28
3.4.5 WAN IP Address Assignment	29
3.4.6 IP Address and Subnet Mask	30
3.4.7 DNS Server Address Assignment	30
3.4.8 WAN IP and DNS Server Address Assignment	30

3.4.9 WAN MAC Address	31
3.5 Connection Wizard Complete	32
Chapter 4	
Modes	35
4.1 Overview	35
4.2 Setting your NBG-418N to Router Mode	36
4.2.1 Status Screen (Router Mode)	37
4.2.2 Router Mode Navigation Panel	42
4.3 Setting your NBG-418N to AP Mode	44
4.3.1 Status Screen (AP Mode)	45
4.3.2 AP Navigation Panel	47
4.4 Setting your NBG-418N to Universal Repeater Mode	48
4.4.1 Status Screen (Universal Repeater Mode)	49
4.4.2 Universal Repeater Navigation Panel	51
4.5 Setting your NBG-418N to Client Bridge Mode	52
4.5.1 Status Screen (Client Bridge Mode)	53
4.5.2 Client Bridge Navigation Panel	54
Chapter 5	
Tutorials	57
5.1 Overview	57
5.2 How to Connect to the Internet from an AP	57
5.2.1 Configure Wireless Security Using WPS on both your NBG-418N and Wireless Client	57
5.3 Enable and Configure Wireless Security without WPS on your NBG-418N	61
 Part II: Technical Reference	 65
Chapter 6	
Wireless LAN	67
6.1 Overview	67
6.2 What You Can Do	68
6.3 What You Should Know	69
6.3.1 Wireless Security Overview	69
6.4 General Wireless LAN Screen	70
6.4.1 No Security	72
6.4.2 WEP Encryption	73
6.4.3 WPA-PSK/WPA2-PSK	74
6.5 MAC Filter	75
6.6 Wireless LAN Advanced Screen	76
6.7 Quality of Service (QoS) Screen	78

6.8 WPS Screen	79
6.9 WPS Station Screen	80
6.10 Scheduling Screen	81
6.11 AP Select Screen	82
6.12 WLAN Info Screen	83
Chapter 7	
WAN	85
7.1 Overview	85
7.2 What You Need To Know	85
7.2.1 Configuring Your Internet Connection	85
7.3 Internet Connection	86
7.3.1 Ethernet Encapsulation	86
7.3.2 PPPoE Encapsulation	88
7.3.3 PPTP Encapsulation	90
Chapter 8	
LAN	93
8.1 Overview	93
8.2 What You Need To Know	93
8.2.1 IP Pool Setup	94
8.2.2 LAN TCP/IP	94
8.3 LAN IP Screen	94
Chapter 9	
DHCP Server	97
9.1 Overview	97
9.2 What You Can Do	97
9.3 What You Need To Know	97
9.4 General Screen	97
9.5 Advanced Screen	98
9.6 Client List Screen	100
Chapter 10	
Network Address Translation	101
10.1 Overview	101
10.2 What You Can Do	102
10.2.1 What You Need To Know	102
10.3 General NAT Screen	103
10.4 NAT Application Screen	104
10.5 Technical Reference	106
10.5.1 NAT Port Forwarding: Services and Port Numbers	106
10.5.2 NAT Port Forwarding Example	107

Chapter 11	
Dynamic DNS	109
11.1 Overview	109
11.2 Dynamic DNS Screen	109
Chapter 12	
Firewall	111
12.1 Overview	111
12.2 What You Can Do	111
12.3 What You Need To Know	112
12.3.1 About the NBG-418N Firewall	112
12.3.2 VPN Pass Through Features	112
12.4 General Firewall Screen	112
12.5 Services Screen	113
Chapter 13	
Remote Management	115
13.1 Overview	115
13.1.1 Remote Management Limitations	116
13.1.2 Remote Management and NAT	116
13.1.3 System Timeout	116
13.2 WWW Screen	116
Chapter 14	
Universal Plug-and-Play (UPnP)	119
14.1 Overview	119
14.2 What You Need to Know	119
14.3 Configuring UPnP	120
14.3.1 Using UPnP in Windows XP Example	120
14.3.2 Web Configurator Easy Access	122
Chapter 15	
System	125
15.1 Overview	125
15.2 What You Can Do	125
15.3 System General Screen	125
15.4 Time Setting Screen	126
Chapter 16	
Logs	129
16.1 Overview	129
16.2 What You Need to Know	129
16.3 View Log Screen	129

Chapter 17	
Tools	131
17.1 Overview	131
17.2 What You Can Do	131
17.3 Firmware Upload Screen	131
17.4 Configuration Screen	133
17.4.1 Backup Configuration	133
17.4.2 Restore Configuration	133
17.4.3 Back to Factory Defaults	134
17.5 Restart Screen	134
Chapter 18	
Sys OP Mode	137
18.1 Overview	137
18.2 General Screen	137
Chapter 19	
Language	139
19.1 Language Screen	139
Chapter 20	
Troubleshooting	141
20.1 Power, Hardware Connections, and LEDs	141
20.2 NBG-418N Access and Login	142
20.3 Internet Access	143
20.4 Resetting the NBG-418N to Its Factory Defaults	144
20.5 Wireless Problems	145
Appendix A IP Addresses and Subnetting	147
Appendix B Pop-up Windows, JavaScripts and Java Permissions	157
Appendix C Setting Up Your Computer's IP Address	167
Appendix D Wireless LANs	195
Appendix E Common Services	209
Appendix F Legal Information	213
Index	219

PART I

User's Guide

Introduction

1.1 Overview

The NBG-418N extends the range of your existing wired network without additional wiring, providing easy network access to mobile users.

You can create the following connections using the NBG-418N:

- **LAN.** You can connect network devices via the Ethernet ports of the NBG-418N so that they can communicate with each other and access the Internet.
- **WLAN.** Wireless clients can connect to the NBG-418N to access network resources.
- **WAN.** Connect to a broadband modem/router for Internet access.

Figure 1 NBG-418N Network

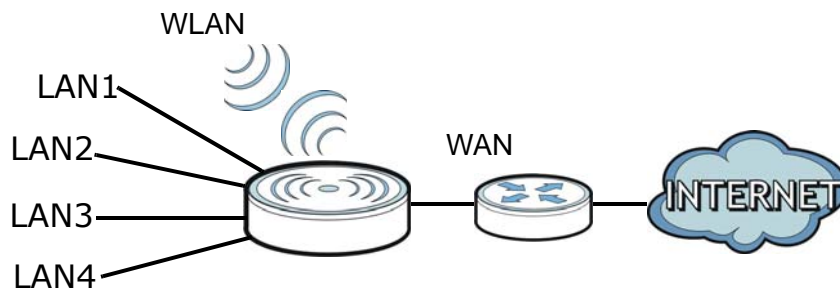

You can set up the NBG-418N with other IEEE 802.11b/g/n compatible devices in one of the following device modes:

- Router
- Access Point
- Universal Repeater
- Client Bridge

Use a (supported) web browser to manage the NBG-418N. Menus vary according to which mode you're using.

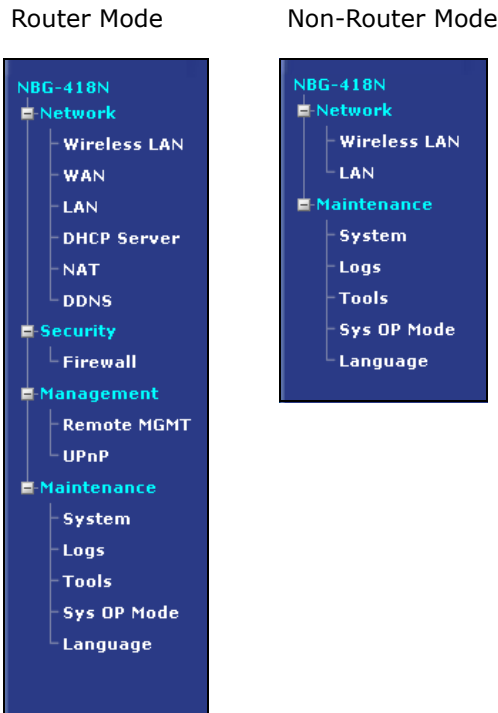

See [Chapter 4 on page 35](#) for more information on these modes.

1.2 Securing the NBG-418N

Do the following things regularly to make the NBG-418N more secure and to manage the NBG-418N more effectively.

- Change the password. Use a password that's not easy to guess and that consists of different types of characters, such as numbers and letters.
- Write down the password and put it in a safe place.
- Back up the configuration (and make sure you know how to restore it). Restoring an earlier working configuration may be useful if the device becomes unstable or even crashes. If you forget your password, you will have to reset the NBG-418N to its factory default settings. If you backed up an earlier configuration file, you would not have to totally re-configure the NBG-418N. You could simply restore your last configuration.





1.3 LEDs

Figure 2 Front Panel



The following table describes the LEDs and the WPS button.

Table 1 Front Panel LEDs and WPS Button

LED	COLOR	STATUS	DESCRIPTION
POWER 	Green	On	The NBG-418N is receiving power and functioning properly.
		Off	The NBG-418N is not receiving power.
LAN 1-4 	Green	On	The NBG-418N has a successful 10/100MB LAN connection.
		Blinking	The NBG-418N is sending/receiving data through the LAN.
		Off	The LAN is not connected.
WAN 	Green	On	The NBG-418N has a successful 10/100MB WAN connection.
		Blinking	The NBG-418N is sending/receiving data through the WAN.
		Off	The WAN connection is not ready, or has failed.
WLAN 	Green	On	The NBG-418N is ready, but is not sending/receiving data through the wireless LAN.
		Blinking	The NBG-418N is sending/receiving data through the wireless LAN. The NBG-418N is negotiating a WPS connection with a wireless client.
		Off	The wireless LAN is not ready or has failed.
WPS 	Green	On	WPS status is configured.
		Blinking	The NBG-418N is negotiating a WPS connection with a wireless client.
		Off	The WPS status is not configured or disabled.

1.4 The WPS Button

Your NBG-418N supports WiFi Protected Setup (WPS), which is an easy way to set up a secure wireless network. WPS is an industry standard specification, defined by the WiFi Alliance.

WPS allows you to quickly set up a wireless network with strong security, without having to configure security settings manually. Each WPS connection works between two devices. Both devices must support WPS (check each device's documentation to make sure).

Depending on the devices you have, you can either press a button (recommended) on the device itself, or in its configuration utility or enter a PIN (a unique Personal Identification Number that

allows one device to authenticate the other) in each of the two devices. When WPS is activated on a device, it has two minutes to find another device that also has WPS activated. Then, the two devices connect and set up a secure network by themselves.

For more information on using WPS, see [Section 5.2.1 on page 57](#).

1.5 Wall Mounting

You may need screw anchors if mounting on a concrete or brick wall.

Table 2 Wall Mounting Information

Distance between holes	12 cm
M4 Screws	Two
Screw anchors (optional)	Two

- 1 Select a position free of obstructions on a wall strong enough to hold the weight of the device.
- 2 Mark two holes on the wall at the appropriate distance apart for the screws.

Be careful to avoid damaging pipes or cables located inside the wall when drilling holes for the screws.

- 3 If using screw anchors, drill two holes for the screw anchors into the wall. Push the anchors into the full depth of the holes, then insert the screws into the anchors. Do not insert the screws all the way in - leave a small gap of about 0.5 cm.

If not using screw anchors, use a screwdriver to insert the screws into the wall. Do not insert the screws all the way in - leave a gap of about 0.5 cm.

- 4 Make sure the screws are fastened well enough to hold the weight of the NBG-418N with the connection cables.
- 5 Align the holes on the back of the NBG-418N with the screws on the wall. Hang the NBG-418N on the screws.

Figure 3 Wall Mounting Example

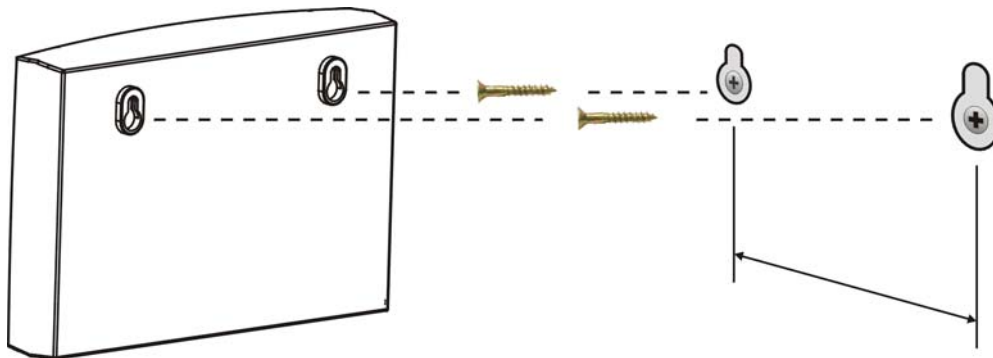

The Web Configurator

2.1 Overview

This chapter describes how to access the NBG-418N Web Configurator and provides an overview of its screens.

The Web Configurator is an HTML-based management interface that allows easy setup and management of the NBG-418N via Internet browser. Use Internet Explorer 6.0 and later versions, Mozilla Firefox 3 and later versions, or Safari 2.0 and later versions. The recommended screen resolution is 1024 by 768 pixels.

In order to use the Web Configurator you need to allow:

- Web browser pop-up windows from your device. Web pop-up blocking is enabled by default in Windows XP SP (Service Pack) 2.
- JavaScript (enabled by default).
- Java permissions (enabled by default).

Refer to [Chapter 20 Troubleshooting](#) to see how to make sure these functions are allowed in Internet Explorer.

2.2 Accessing the Web Configurator

- 1 Make sure your NBG-418N hardware is properly connected and prepare your computer or computer network to connect to the NBG-418N (refer to the Quick Start Guide).
- 2 Launch your web browser.
- 3 Type "http://192.168.1.1" as the website address in your web browser. This is the default LAN IP address in router mode, the default device mode (192.168.1.2 is the default IP address in non-router mode).

Your computer must be in the same subnet in order to access this website address. In router mode, the NBG-418N can assign your computer an IP address, so you must set your computer to get an IP address automatically (computer factory default) or give it a fixed IP address in the range between 192.168.1.3 and 192.168.1.254 (see the appendices).

- 4 Type **admin** (default) as the user name and **1234** (default) as the password and click **OK**.

Figure 4 Login Screen



Note: The management session automatically times out when the time period set in the **Administrator Inactivity Timer** field expires (default five minutes). Simply log back into the NBG-418N if this happens.

- 5 Select the setup type you want to use.
 - Click **Go to Wizard Setup** to use the Configuration Wizard for basic Internet and Wireless setup.
 - Click **Go to Advanced Setup** to view and configure all the NBG-418N's settings.
 - Select a language to go to the basic Web Configurator in that language. To change to the advanced configurator see [Chapter 19 on page 139](#).

Figure 5 Selecting the setup mode



2.3 Resetting the NBG-418N

If you forget your password or IP address, or you cannot access the Web Configurator, you will need to use the **RESET** button at the back of the NBG-418N to reload the factory-default configuration file. This means that you will lose all configurations that you had previously saved, the username will be reset to **admin** and password will be reset to **1234**. The IP address will be reset to "192.168.1.1".

2.3.1 Using the RESET Button

- 1 Make sure the power LED is on.
- 2 Press the **RESET** button for longer than 1 second to restart/reboot the NBG-418N.
- 3 Press the **RESET** button for longer than five seconds to set the NBG-418N back to its factory-default configurations.

Connection Wizard

3.1 Wizard Setup

This chapter provides information on the wizard setup screens in the Web Configurator.

The Web Configurator's wizard setup helps you configure your device to access the Internet. Refer to your ISP (Internet Service Provider) checklist in the Quick Start Guide to know what to enter in each field. Leave a field blank if you don't have that information.

- 1 After you access the NBG-418N Web Configurator, click **Go to Wizard setup**.

You can click **Go to Advanced setup** to skip this wizard setup and configure basic or advanced features accordingly.

Figure 6 Select Wizard or Advanced Mode



- 2 Choose a language by clicking on the language's button. The screen will update. Click the **Next** button to proceed to the next screen.

Figure 7 Select a Language



- 3 Read the on-screen information and click **Next**.

Figure 8 Welcome to the Connection Wizard



3.2 Connection Wizard: STEP 1: System Information

System Information contains administrative and system-related information.

3.2.1 System Name

System Name is for identification purposes. However, because some ISPs check this name you should enter your computer's "Computer Name".

- In Windows 95/98 click **Start > Settings > Control Panel > Network**. Click the Identification tab, note the entry for the **Computer Name** field and enter it as the **System Name**.
- In Windows 2000, click **Start > Settings** and **Control Panel** and then double-click **System**. Click the **Network Identification** tab and then the **Properties** button. Note the entry for the **Computer name** field and enter it as the **System Name**.
- In Windows XP, click **Start > My Computer > View system information** and then click the **Computer Name** tab. Note the entry in the **Full computer name** field and enter it as the NBG-418N **System Name**.

3.2.2 Domain Name

The **Domain Name** entry is what is propagated to the DHCP clients on the LAN. If you leave this blank, the domain name obtained by DHCP from the ISP is used. While you must enter the host name (System Name) on each individual computer, the domain name can be assigned from the NBG-418N via DHCP.

Click **Next** to configure the NBG-418N for Internet access.

Figure 9 Wizard Step 1: System Information

The following table describes the labels in this screen.

Table 3 Wizard Step 1: System Information

LABEL	DESCRIPTION
System Name	System Name is a unique name to identify the NBG-418N in an Ethernet network. Enter a descriptive name. This name can be up to 30 alphanumeric characters long. Spaces are not allowed, but dashes "-" and underscores "_" are accepted.
Domain Name	Type the domain name (if you know it) here. If you leave this field blank, the ISP may assign a domain name via DHCP. The domain name entered by you is given priority over the ISP assigned domain name.
Back	Click Back to display the previous screen.
Next	Click Next to proceed to the next screen.
Exit	Click Exit to close the wizard screen without saving.

3.3 Connection Wizard: STEP 2: Wireless LAN

Set up your wireless LAN using the following screen.

Figure 10 Wizard Step 2: Wireless LAN

The following table describes the labels in this screen.

Table 4 Wizard Step 2: Wireless LAN

LABEL	DESCRIPTION
Name (SSID)	Enter a descriptive name (up to 32 printable 7-bit ASCII characters) for the wireless LAN. If you change this field on the NBG-418N, make sure all wireless stations use the same SSID in order to access the network.
Security	Select a Security level from the drop-down list box. Choose None to have no wireless LAN security configured. If you do not enable any wireless security on your NBG-418N, your network is accessible to any wireless networking device that is within range. If you choose this option, skip directly to Section 3.4 on page 25 . Choose WPA-PSK or WPA2-PSK security to configure a Pre-Shared Key. Choose this option only if your wireless clients support WPA-PSK or WPA2-PSK respectively. If you choose this option, skip directly to Section 3.3.1 on page 24 .
Channel Selection	The range of radio frequencies used by IEEE 802.11b/g/n wireless devices is called a channel. Set the operating frequency/channel depending on your particular region. Select a channel from the drop-down list box. The options vary depending on the frequency band and the country you are in. This option is only available if Auto Channel Selection is disabled.
Auto Channel Selection	Select this option for the NBG-418N to automatically choose the channel with the least interference. Deselect this option if you wish to manually select the channel using the Channel Selection field.
Back	Click Back to display the previous screen.
Next	Click Next to proceed to the next screen.
Exit	Click Exit to close the wizard screen without saving.

Note: The wireless stations and NBG-418N must use the same SSID, channel ID, WPA-PSK (if WPA-PSK is enabled) or WPA2-PSK (if WPA2-PSK is enabled) for wireless communication.

3.3.1 WPA-PSK or WPA2-PSK Security

Choose **WPA-PSK** or **WPA2-PSK** security in the **Wireless LAN** setup screen to set up a **Pre-Shared Key**.

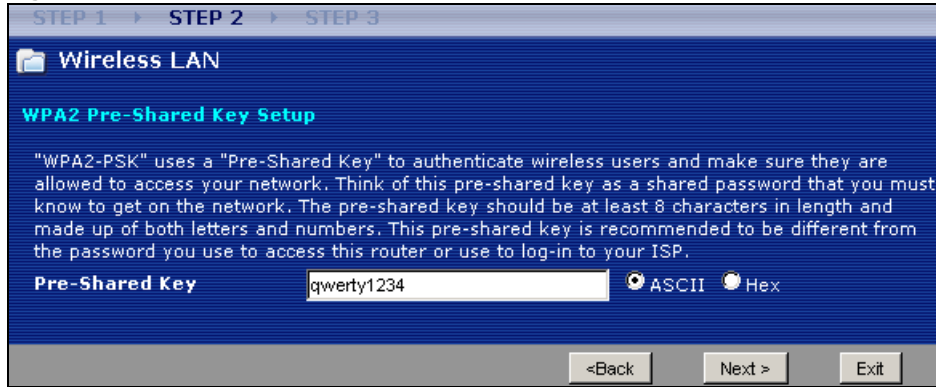
Figure 11 Wizard Step 2: WPA-PSK or WPA2-PSK Security

The following table describes the labels in this screen.

Table 5 Wizard Step 2: WPA-PSK or WPA2-PSK Security

LABEL	DESCRIPTION
Pre-Shared Key	Type from 8 to 63 case-sensitive ASCII characters or 64 HEX characters. You can set up the most secure wireless connection by configuring WPA in the wireless LAN screens. You need to configure an authentication server to do this.
Back	Click Back to display the previous screen.
Next	Click Next to proceed to the next screen.
Exit	Click Exit to close the wizard screen without saving.

3.4 Connection Wizard: STEP 3: Internet Configuration

The NBG-418N offers three Internet connection types. They are **Ethernet**, **PPP over Ethernet** or **PPTP**. The wizard attempts to detect which WAN connection type you are using. If the wizard does not detect a connection type, you must select one from the drop-down list box. Check with your ISP to make sure you use the correct type.

This wizard screen varies according to the connection type that you select.

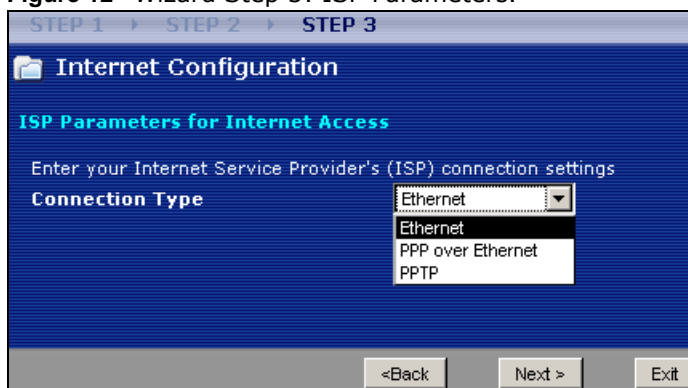
Figure 12 Wizard Step 3: ISP Parameters.

The following table describes the labels in this screen,

Table 6 Wizard Step 3: ISP Parameters

CONNECTION TYPE	DESCRIPTION
Ethernet	Select the Ethernet option when the WAN port is used as a regular Ethernet.
PPPoE	Select the PPP over Ethernet option for a dial-up connection. If your ISP gave you an IP address and/or subnet mask, then select PPTP .
PPTP	Select the PPTP option for a dial-up connection.

3.4.1 Ethernet Connection

Choose **Ethernet** when the WAN port is used as a regular Ethernet. Continue to [Section 3.4.4 on page 28](#).

Figure 13 Wizard Step 3: Ethernet Connection



3.4.2 PPPoE Connection

Point-to-Point Protocol over Ethernet (PPPoE) functions as a dial-up connection. PPPoE is an IETF (Internet Engineering Task Force) standard specifying how a host personal computer interacts with a broadband modem (for example DSL, cable, wireless, etc.) to achieve access to high-speed data networks.

For the service provider, PPPoE offers an access and authentication method that works with existing access control systems (for instance, RADIUS).

One of the benefits of PPPoE is the ability to let end users access one of multiple network services, a function known as dynamic service selection. This enables the service provider to easily create and offer new IP services for specific users.

Operationally, PPPoE saves significant effort for both the subscriber and the ISP/carrier, as it requires no specific configuration of the broadband modem at the subscriber's site.

By implementing PPPoE directly on the NBG-418N (rather than individual computers), the computers on the LAN do not need PPPoE software installed, since the NBG-418N does that part of the task. Furthermore, with NAT, all of the LAN's computers will have Internet access.

Figure 14 Wizard Step 3: PPPoE Connection

STEP 1 > STEP 2 > STEP 3

Internet Configuration

ISP Parameters for Internet Access

Enter your Internet Service Provider's (ISP) connection settings

Connection Type: PPP over Ethernet

Service Name: [] (optional)

User Name: []

Password: []

<Back Next > Exit

The following table describes the labels in this screen.

Table 7 Wizard Step 3: PPPoE Connection

LABEL	DESCRIPTION
ISP Parameter for Internet Access	
Connection Type	Select the PPP over Ethernet option for a dial-up connection.
Service Name	Type the name of your service provider.
User Name	Type the user name given to you by your ISP.
Password	Type the password associated with the user name above.
Back	Click Back to return to the previous screen.
Next	Click Next to continue.
Exit	Click Exit to close the wizard screen without saving.

3.4.3 PPTP Connection

Point-to-Point Tunneling Protocol (PPTP) is a network protocol that enables transfers of data from a remote client to a private server, creating a Virtual Private Network (VPN) using TCP/IP-based networks.

PPTP supports on-demand, multi-protocol, and virtual private networking over public networks, such as the Internet.

Refer to the appendix for more information on PPTP.

Note: The NBG-418N supports one PPTP server connection at any given time.

Figure 15 Wizard Step 3: PPTP Connection

The following table describes the fields in this screen

Table 8 Wizard Step 3: PPTP Connection

LABEL	DESCRIPTION
ISP Parameters for Internet Access	
Connection Type	Select PPTP from the drop-down list box. To configure a PPTP client, you must configure the User Name and Password fields for a PPP connection and the PPTP parameters for a PPTP connection.
User Name	Type the user name given to you by your ISP.
Password	Type the password associated with the User Name above.
PPTP Configuration	
Server IP Address	Type the IP address of the PPTP server.
Get automatically from ISP	Select this radio button if your ISP did not assign you a fixed IP address.
Use fixed IP address	Select this radio button, provided by your ISP to give the NBG-418N a fixed, unique IP address.
My IP Address	Type the (static) IP address assigned to you by your ISP.
My IP Subnet Mask	Type the subnet mask assigned to you by your ISP (if given).
My IP Gateway	Type the gateway IP address assigned to you by your ISP (if given).
Back	Click Back to return to the previous screen.
Next	Click Next to continue.
Exit	Click Exit to close the wizard screen without saving.

3.4.4 Your IP Address

The following wizard screen allows you to assign a fixed IP address or give the NBG-418N an automatically assigned IP address depending on your ISP.

Figure 16 Wizard Step 3: Your IP Address

The following table describes the labels in this screen

Table 9 Wizard Step 3: Your IP Address

LABEL	DESCRIPTION
Get automatically from your ISP	Select this option if your ISP did not assign you a fixed IP address. This is the default selection. If you choose this option, skip directly to Section 3.4.9 on page 31 .
Use fixed IP address provided by your ISP	Select this option if you were given IP address and/or DNS server settings by the ISP. The fixed IP address should be in the same subnet as your broadband modem or router.
Back	Click Back to return to the previous screen.
Next	Click Next to continue.
Exit	Click Exit to close the wizard screen without saving.

3.4.5 WAN IP Address Assignment

Every computer on the Internet must have a unique IP address. If your networks are isolated from the Internet, for instance, only between your two branch offices, you can assign any IP addresses to the hosts without problems. However, the Internet Assigned Numbers Authority (IANA) has reserved the following three blocks of IP addresses specifically for private networks.

Table 10 Private IP Address Ranges

10.0.0.0	-	10.255.255.255
172.16.0.0	-	172.31.255.255
192.168.0.0	-	192.168.255.255

You can obtain your IP address from the IANA, from an ISP or have it assigned by a private network. If you belong to a small organization and your Internet access is through an ISP, the ISP can provide you with the Internet addresses for your local networks. On the other hand, if you are part of a much larger organization, you should consult your network administrator for the appropriate IP addresses.

Note: Regardless of your particular situation, do not create an arbitrary IP address; always follow the guidelines above. For more information on address assignment, please refer to RFC 1597, Address Allocation for Private Internets and RFC 1466, Guidelines for Management of IP Address Space.

3.4.6 IP Address and Subnet Mask

Similar to the way houses on a street share a common street name, so too do computers on a LAN share one common network number.

Where you obtain your network number depends on your particular situation. If the ISP or your network administrator assigns you a block of registered IP addresses, follow their instructions in selecting the IP addresses and the subnet mask.

If the ISP did not explicitly give you an IP network number, then most likely you have a single user account and the ISP will assign you a dynamic IP address when the connection is established. The Internet Assigned Number Authority (IANA) reserved this block of addresses specifically for private use; please do not use any other number unless you are told otherwise. Let's say you select 192.168.1.0 as the network number; which covers 254 individual addresses, from 192.168.1.1 to 192.168.1.254 (zero and 255 are reserved). In other words, the first three numbers specify the network number while the last number identifies an individual computer on that network.

Once you have decided on the network number, pick an IP address that is easy to remember, for instance, 192.168.1.1, for your NBG-418N, but make sure that no other device on your network is using that IP address.

The subnet mask specifies the network number portion of an IP address. Your NBG-418N will compute the subnet mask automatically based on the IP address that you entered. You don't need to change the subnet mask computed by the NBG-418N unless you are instructed to do otherwise.

3.4.7 DNS Server Address Assignment

Use DNS (Domain Name System) to map a domain name to its corresponding IP address and vice versa, for instance, the IP address of www.zyxel.com is 204.217.0.2. The DNS server is extremely important because without it, you must know the IP address of a computer before you can access it.

The NBG-418N can get the DNS server addresses in the following ways.

- 1 The ISP tells you the DNS server addresses, usually in the form of an information sheet, when you sign up. If your ISP gives you DNS server addresses, enter them in the **DNS Server** fields in the **Wizard** and/or **WAN > Internet Connection** screen.
- 2 If the ISP did not give you DNS server information, leave the **DNS Server** fields set to **0.0.0.0** in the **Wizard** screen and/or set to **From ISP** in the **WAN > Internet Connection** screen for the ISP to dynamically assign the DNS server IP addresses.

3.4.8 WAN IP and DNS Server Address Assignment

The following wizard screen allows you to assign a fixed WAN IP address and DNS server addresses.

Figure 17 Wizard Step 3: WAN IP and DNS Server Addresses

The screenshot shows a configuration window titled 'Internet Configuration' with a blue background. At the top, it indicates 'STEP 1', 'STEP 2', and 'STEP 3'. Below the title, there are two sections: 'WAN IP Address Assignment' and 'DNS Server Address Assignment'. Each section contains two text input fields. The 'WAN IP Address' field is labeled 'My WAN IP Address', the 'Subnet Mask' field is labeled 'My WAN IP Subnet Mask', and the 'Gateway IP Address' field is labeled 'Gateway IP Address'. The 'DNS Server Address Assignment' section has two fields labeled 'First DNS Server' and 'Second DNS Server'. All input fields contain the value '0.0.0.0'. At the bottom of the window, there are three buttons: '<Back', 'Next >', and 'Exit'.

The following table describes the labels in this screen

Table 11 Wizard Step 3: WAN IP and DNS Server Addresses

LABEL	DESCRIPTION
WAN IP Address Assignment	
My WAN IP Address	Enter your WAN IP address in this field. The WAN IP address should be in the same subnet as your DSL/Cable modem or router.
My WAN IP Subnet Mask	Enter the IP subnet mask in this field.
Gateway IP Address	Enter the gateway IP address in this field.
System DNS Server Address Assignment (if applicable)	
DNS (Domain Name System) is for mapping a domain name to its corresponding IP address and vice versa. The DNS server is extremely important because without it, you must know the IP address of a computer before you can access it. The NBG-418N uses a system DNS server (in the order you specify here) to resolve domain names for DDNS and the time server.	
First DNS Server	Enter the DNS server's IP address in the fields provided.
Second DNS Server	If you do not configure a system DNS server, you must use IP addresses when configuring DDNS and the time server.
Back	Click Back to return to the previous screen.
Next	Click Next to continue.
Exit	Click Exit to close the wizard screen without saving.

3.4.9 WAN MAC Address

Every Ethernet device has a unique MAC (Media Access Control) address. The MAC address is assigned at the factory and consists of six pairs of hexadecimal characters, for example, 00:A0:C5:00:00:02.

This screen allows users to configure the WAN port's MAC address by either using the NBG-418N's MAC address, copying the MAC address of the computer from which you are configuring the NBG-418N or manually entering a MAC address. Once it is successfully configured, the address will be copied to configuration file. It is advisable to clone the MAC address from a computer on your LAN even if your ISP does not presently require MAC address authentication.

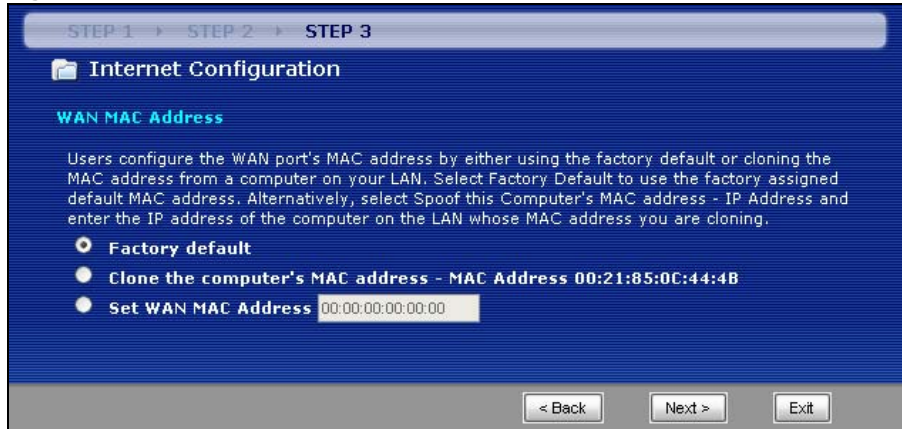
Figure 18 Wizard Step 3: WAN MAC Address

The following table describes the fields in this screen.

Table 12 Wizard Step 3: WAN MAC Address

LABEL	DESCRIPTION
Factory Default	Select Factory Default to use the factory assigned default MAC address.
Clone the computer's MAC address - MAC Address	Select this option to clone the MAC address of the computer (displaying in the screen) from which you are configuring the NBG-418N. It is advisable to clone the MAC address from a computer on your LAN even if your ISP does not presently require MAC address authentication.
Set WAN MAC Address	Select this option and enter the MAC address you want to use.
Back	Click Back to return to the previous screen.
Next	Click Next to continue.
Exit	Click Exit to close the wizard screen without saving.

3.5 Connection Wizard Complete

Click **Apply** to complete the wizard setup.

Figure 19 Connection Wizard Complete

Well done! You have successfully set up your NBG-418N to operate on your network and access the Internet.

4.1 Overview

You can set up the NBG-418N with other IEEE 802.11b/g/n compatible devices in different device modes.

Note: Choose your device mode carefully to avoid having to change it later. The NBG-418N automatically restarts when you change modes.

The default LAN IP address of the NBG-418N in Router mode is 192.168.1.1. The default IP address of the NBG-418N in other modes is 192.168.1.2.

- **Router:** Use this mode if you want to use routing functions such as LAN DHCP, NAT, firewall and so on on the NBG-418N (N). The NBG-418N has separate LAN and WAN network IP addresses. Connect the WAN port to an Internet Access Device (IAD) such as a broadband modem.

Figure 20 Router

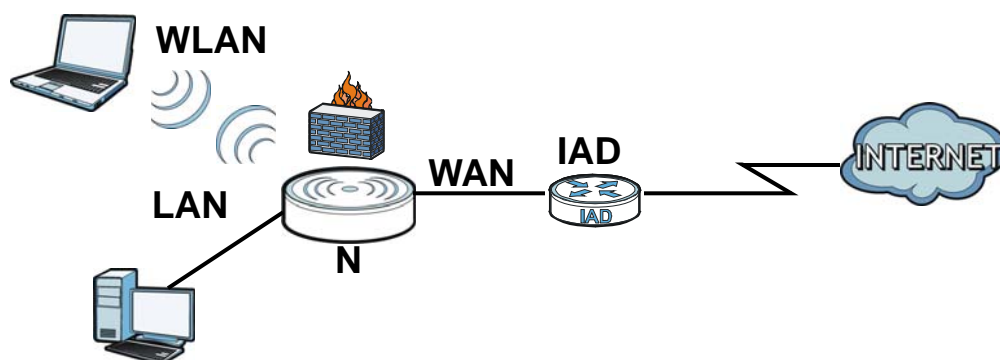

- **Access Point:** Use this mode if you already have a Router (R) in your network and you want to set up a wireless network and bridge the wired and wireless connections on the NBG-416N.

Figure 21 AP Mode

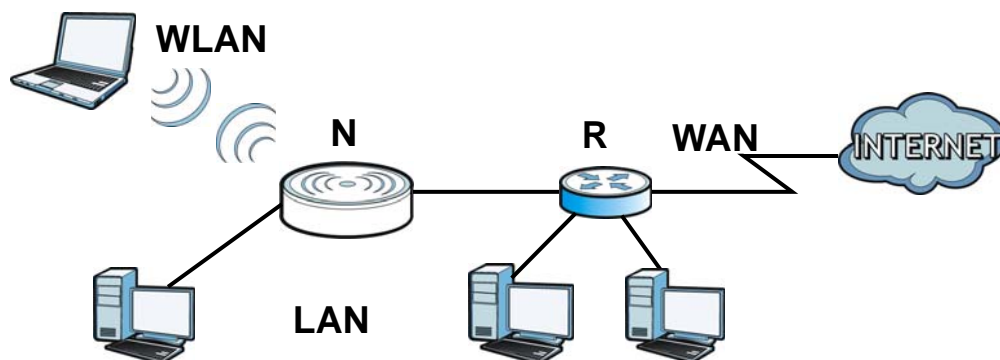

- **Universal Repeater:** In this mode, the NBG-418N (N) can be an access point and a wireless client at the same time. Use this mode if there is an existing wireless router or access point in your network and you want the NBG-418N (N) to wirelessly relay communications from its wireless clients to the access point.

Figure 22 Universal Repeater

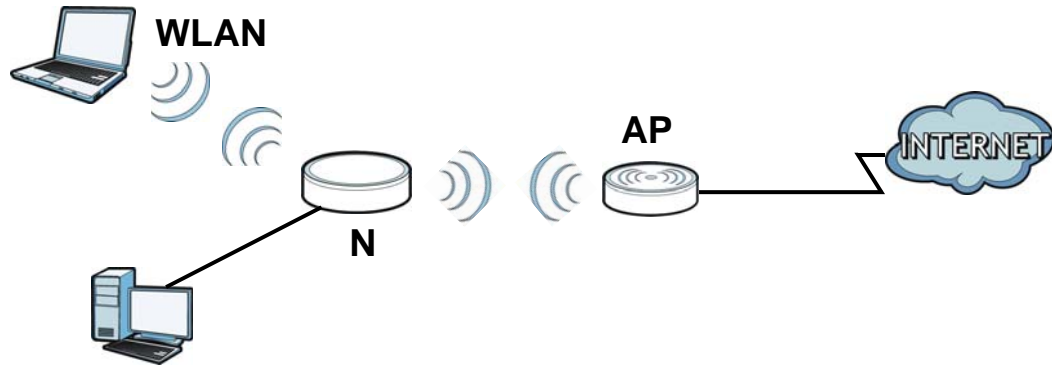

- **Client Bridge:** Use this mode if there is an existing wireless router or access point (AP) in the network to which you want to connect your NBG-418N (N) wirelessly. You should know the SSID and wireless security details of the wireless router or access point to which you want to connect.

Figure 23 Client Bridge

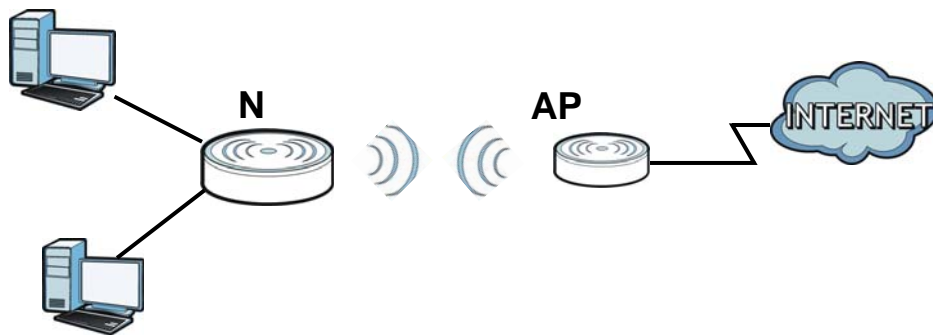

4.2 Setting your NBG-418N to Router Mode

The NBG-418N is set to wireless router mode by default. If it was changed and now you want to set it back, do the following procedure.

- 1 Connect your computer to the LAN port of the NBG-418N.
- 2 The default LAN IP address of the NBG-418N is 192.168.1.1 in router mode (192.168.1.2 by default in non-router mode). In router mode, the NBG-418N can assign your computer an IP address, so you must set your computer to get an IP address automatically (computer factory default) or give it a fixed IP address in the range between 192.168.1.3 and 192.168.1.254.
- 3 After you've set your computer's IP address, open a web browser such as Internet Explorer and type the IP address of the NBG-418N as the web address in your web browser.
- 4 Log into the Web Configurator. See the [Chapter 2 on page 17](#) for instructions on how to do this.

- 5 Go to **Maintenance > Sys OP Mode > General** and select **Router**.

Figure 24 Maintenance > Sys OP Mode > Router

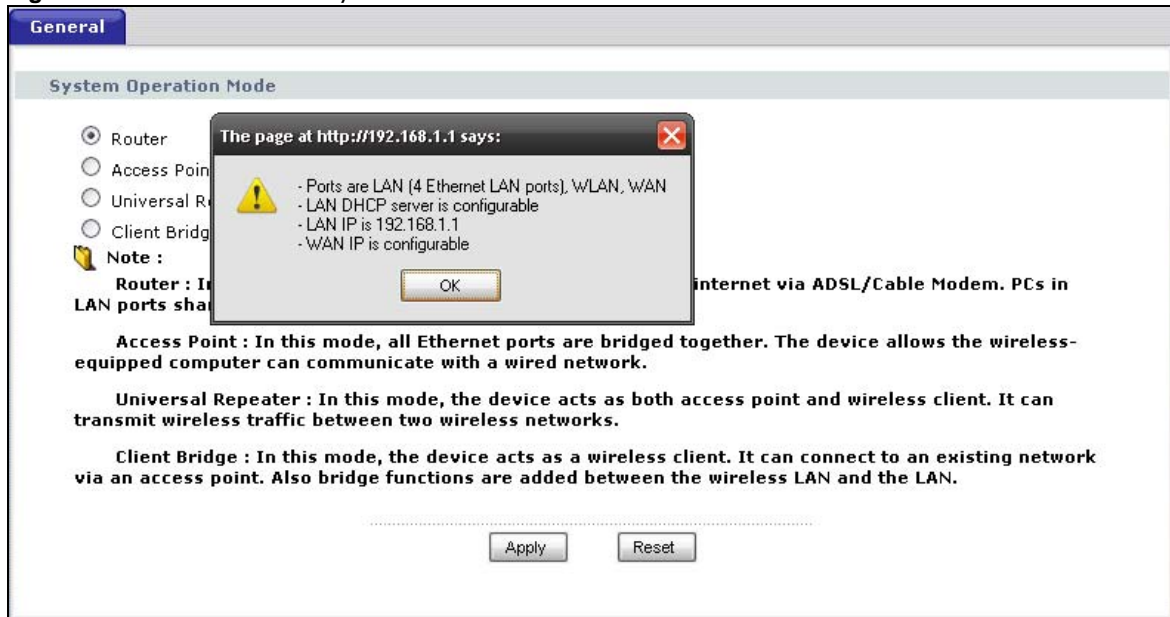

- 6 A pop-up window appears providing information on this mode. Click **OK** in the pop-up message window. Click **Apply**.

Note: Wait while the NBG-418N restarts, then log in to the Web Configurator again. The NBG-418N IP address is now 192.168.1.1.

4.2.1 Status Screen (Router Mode)

The screen below shows the status screen in **Router** mode.

Figure 25 Status Screen (Router Mode)



The following table describes the icons shown in the **Status** screen.

Table 13 Status Screen Icon Key

ICON	DESCRIPTION
	Click this icon to open the setup wizard.
	Click this icon to view copyright and a link for related product information.
	Click this icon at any time to exit the Web Configurator.
	Select a number of seconds or None from the drop-down list box to refresh all screen statistics automatically at the end of every time interval or to not refresh the screen statistics.
	Click this button to refresh the status screen statistics.

The following table describes the labels shown in the **Status** screen in **Router** mode.

Table 14 Web Configurator Status Screen (Router Mode)

LABEL	DESCRIPTION
Device Information	
System Name	This is the System Name you enter in the Maintenance > System > General screen. It is for identification purposes.

Table 14 Web Configurator Status Screen (Router Mode) (continued)

LABEL	DESCRIPTION
Firmware Version	This is the current firmware version of the NBG-418N.
WAN Information	
- MAC Address	This shows the WAN Ethernet adapter MAC Address of your device.
- Connection Type	This shows the current connection type.
- IP Address	This shows the WAN port's IP address.
- IP Subnet Mask	This shows the WAN port's subnet mask.
- Gateway	This shows the WAN port's gateway IP address.
- DNS	This shows the IP address of your DNS server.
LAN Information	
- MAC Address	This shows the LAN Ethernet adapter MAC Address of your device.
- IP Address	This shows the LAN port's IP address.
- IP Subnet Mask	This shows the LAN port's subnet mask.
- DHCP	This shows the LAN port's DHCP role - Server or None .
WLAN Information	
- MAC Address	This shows the wireless adapter MAC Address of your device.
- Status	This shows the current status of the Wireless LAN - On , Off or Off by scheduler .
- Name (SSID)	This shows a descriptive name used to identify the NBG-418N in the wireless LAN.
- Channel	This shows the channel number which you select manually or the NBG-418N automatically scans and selects.
- Operating Channel	This shows the channel number which the NBG-418N is currently using over the wireless LAN.
- Security Mode	This shows the level of wireless security the NBG-418N is using.
- 802.11 Mode	This shows the wireless standard.
- WPS	This displays Configured when the WPS has been set up. This displays Unconfigured if the WPS has not been set up. Click the status to display Network > Wireless LAN > WPS screen.
System Status	
Operation Mode	This field shows the device operation mode: Router , Access Point , Client Bridge or Universal Repeater .
System Up Time	This is the total time the NBG-418N has been on.
Current Date/Time	This field displays your NBG-418N's present date and time.
System Resource	
- CPU Usage	This displays what percentage of the NBG-418N's processing ability is currently used. When this percentage is close to 100%, the NBG-418N is running at full load, and the throughput is not going to improve anymore. If you want some applications to have more throughput, you should turn off other applications.
- Memory Usage	This shows what percentage of the heap memory the NBG-418N is using.
System Setting	
- Firewall	This shows whether the firewall is active or not.
- UPnP	This shows whether UPnP is active or not.
Interface Status	

Table 14 Web Configurator Status Screen (Router Mode) (continued)

LABEL	DESCRIPTION
Interface	This displays the NBG-418N port types. The port types are: WAN , LAN and WLAN .
Status	For the LAN and WAN ports, this field displays Down (line is down) or Up (line is up or connected). For the WLAN, it displays Up when the WLAN is enabled or Down when the WLAN is disabled.
Rate	For the LAN ports, this displays the port speed and duplex setting or NA when the line is disconnected. For the WAN port, it displays the port speed and duplex setting if you're using Ethernet encapsulation and Idle (line (ppp) idle), Dial (starting to trigger a call) and Drop (dropping a call) if you're using PPPoE or PPTP encapsulation. This field displays NA when the line is disconnected. For the WLAN, it displays the maximum transmission rate when the WLAN is enabled and NA when the WLAN is disabled.
Summary	
DHCP Table	Use this screen to view current DHCP client information.
Packet Statistics	Use this screen to view port status and packet specific statistics.
WLAN Station Status	Use this screen to view the wireless stations that are currently associated to the NBG-418N.

4.2.1.1 Summary: DHCP Table

DHCP (Dynamic Host Configuration Protocol, RFC 2131 and RFC 2132) allows individual clients to obtain TCP/IP configuration at start-up from a server. You can configure the NBG-418N's LAN as a DHCP server or disable it. When configured as a server, the NBG-418N provides the TCP/IP configuration for the clients. If DHCP service is disabled, you must have another DHCP server on that network, or else the computer must be manually configured.

Click the **DHCP Table (Details...)** hyperlink in the **Status** screen. Read-only information here relates to your DHCP status. The DHCP table shows current DHCP client information (including **IP Address**, **Host Name** and **MAC Address**) of all network clients using the NBG-418N's DHCP server.

Figure 26 Summary: DHCP Table

#	IP Address	Host Name	MAC Address
1	192.168.1.33	TWPC12731	00:19:cb:04:80:1e
2	192.168.1.35	twpc12116	00:02:e3:56:16:9d

Refresh

The following table describes the labels in this screen.

Table 15 Summary: DHCP Table

LABEL	DESCRIPTION
#	This is the index number of the host computer.
IP Address	This field displays the IP address relative to the # field listed above.
Host Name	This field displays the computer host name.

Table 15 Summary: DHCP Table (continued)

LABEL	DESCRIPTION
MAC Address	This field shows the MAC address of the computer with the name in the Host Name field. Every Ethernet device has a unique MAC (Media Access Control) address which uniquely identifies a device. The MAC address is assigned at the factory and consists of six pairs of hexadecimal characters, for example, 00:A0:C5:00:00:02.
Refresh	Click Refresh to renew the screen.

4.2.1.2 Summary: Packet Statistics

Click the **Packet Statistics (Details...)** hyperlink in the **Status** screen. Read-only information here includes port status, packet specific statistics and the "system up time". The **Poll Interval(s)** field is configurable and is used for refreshing the screen.

Figure 27 Summary: Packet Statistics

The screenshot shows a window titled "Packet Statistics". Inside, there is a table with the following data:

Port	Status	TxPkts	RxPkts	Collisions	Tx B/s	Rx B/s
WAN	100M	876235	809818	0	0	150
LAN	100M	810753	886992	0	821	1676
WLAN	N/A	958	3019	0	0	0

Below the table, it says "System Up Time : 1:41:47". At the bottom, there is a "Poll Interval" field set to "5" with a "sec" label, and two buttons: "Set Interval" and "Stop".

The following table describes the labels in this screen.

Table 16 Summary: Packet Statistics

LABEL	DESCRIPTION
Port	This is the NBG-418N's port type.
Status	For the LAN ports, this displays the port speed and duplex setting or Down when the line is disconnected. For the WAN port, it displays the port speed and duplex setting if you're using Ethernet encapsulation and Idle (line (ppp) idle), Dial (starting to trigger a call) and Drop (dropping a call) if you're using PPPoE or PPTP encapsulation. This field displays Down when the line is disconnected. For the WLAN, it displays the maximum transmission rate when the WLAN is enabled and Down when the WLAN is disabled.
TxPkts	This is the number of transmitted packets on this port.
RxPkts	This is the number of received packets on this port.
Collisions	This is the number of collisions on this port.
Tx B/s	This displays the transmission speed in bytes per second on this port.
Rx B/s	This displays the reception speed in bytes per second on this port.
System Up Time	This is the total time the NBG-418N has been on.
Poll Interval(s)	Enter the time interval for refreshing statistics in this field.
Set Interval	Click this button to apply the new poll interval you entered in the Poll Interval(s) field.
Stop	Click Stop to stop refreshing statistics.

4.2.1.3 Summary: WLAN Station Status

Click the **WLAN Station Status (Details...)** hyperlink in the **Status** screen. View the wireless stations that are currently associated to the NBG-418N in the **Association List**. Association means that a wireless client (for example, your network or computer with a wireless network card) has connected successfully to the AP (or wireless router) using the same SSID, channel and security settings.

Figure 28 Summary: WLAN Station Status

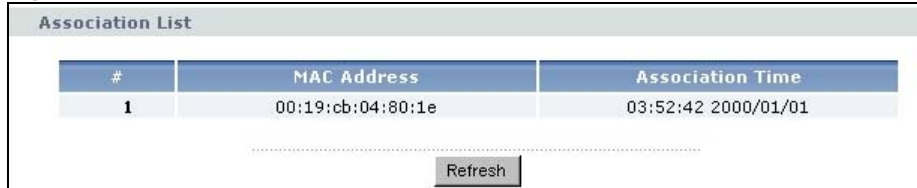

Association List		
#	MAC Address	Association Time
1	00:19:cb:04:80:1e	03:52:42 2000/01/01

Refresh

The following table describes the labels in this screen.

Table 17 Summary: WLAN Station Status

LABEL	DESCRIPTION
#	This is the index number of an associated wireless station.
MAC Address	This field displays the MAC address of an associated wireless station.
Association Time	This field displays the time a wireless station first associated with the NBG-418N's WLAN network.
Refresh	Click Refresh to reload the list.

4.2.2 Router Mode Navigation Panel

Use the menu in the navigation panel menus to configure NBG-418N features in **Router Mode**.

Figure 29 Menus: Router Mode

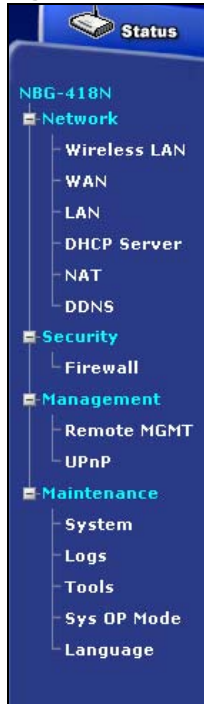

The following table describes the sub-menus.

Table 18 Menus: Router Mode

LINK	TAB	FUNCTION
Status		This screen shows the NBG-418N's general device, system and interface status information. Use this screen to access the wizard, and summary statistics tables.
Network		
Wireless LAN	General	Use this screen to configure wireless LAN.
	MAC Filter	Use the MAC filter screen to configure the NBG-418N to block access to devices or block the devices from accessing the NBG-418N.
	Advanced	This screen allows you to configure advanced wireless settings.
	QoS	Use this screen to configure Wi-Fi Multimedia Quality of Service (WMM QoS). WMM QoS allows you to prioritize wireless traffic according to the delivery requirements of individual services.
	WPS	Use this screen to configure WPS.
	WPS Station	Use this screen to add a wireless station using WPS.
	Scheduling	Use this screen to schedule the times the Wireless LAN is enabled.
WAN	Internet Connection	This screen allows you to configure ISP parameters, WAN IP address assignment, DNS servers and the WAN MAC address.
LAN	IP	Use this screen to configure LAN IP address and subnet mask.
DHCP Server	General	Use this screen to enable the NBG-418N's DHCP server.
	Advanced	Use this screen to assign IP addresses to specific individual computers based on their MAC addresses and to have DNS servers assigned by the DHCP server.
	Client List	Use this screen to view current DHCP client information and to always assign an IP address to a MAC address (and host name).

Table 18 Menus: Router Mode (continued)

LINK	TAB	FUNCTION
NAT	General	Use this screen to enable NAT.
	Application	Use this screen to configure servers behind the NBG-418N.
DDNS	General	Use this screen to configure Dynamic DNS, a service that allows you to map a fixed domain name to a non-fixed IP address.
Security		
Firewall	General	Use this screen to activate/deactivate the firewall.
	Services	Use this screen to enable or disable ICMP and VPN passthrough features.
Management		
Remote MGMT	WWW	Use this screen to configure through which interface(s) and from which IP address(es) users can use HTTP to manage the NBG-418N.
UPnP	General	Use this screen to enable UPnP on the NBG-418N.
Maintenance		
System	General	Use this screen to view and change administrative settings such as system and domain names, password and inactivity timer.
	Time Setting	Use this screen to change your NBG-418N's time and date.
Logs	View Log	Use this screen to view the logs for the categories that you selected.
Tools	Firmware	Use this screen to upload firmware to your NBG-418N.
	Configuration	Use this screen to backup and restore the configuration or reset the factory defaults to your NBG-418N.
	Restart	This screen allows you to reboot the NBG-418N without turning the power off.
Sys OP Mode	General	This screen allows you to select the device operation mode.
Language	Language	This screen allows you to select the language you prefer.

4.3 Setting your NBG-418N to AP Mode

- 1 Connect your computer to the LAN port of the NBG-418N.
- 2 The default LAN IP address of the NBG-418N is 192.168.1.1 in router mode (192.168.1.2 by default in non-router mode). In router mode, the NBG-418N can assign your computer an IP address, so you must set your computer to get an IP address automatically (computer factory default) or give it a fixed IP address in the range between 192.168.1.3 and 192.168.1.254.
- 3 After you've set your computer's IP address, open a web browser such as Internet Explorer and type the IP address of the NBG-418N as the web address in your web browser.
- 4 Log into the Web Configurator. See the [Chapter 2 on page 17](#) for instructions on how to do this.
- 5 Go to **Maintenance > Sys OP Mode > General** and select **Access Point**.

Figure 30 Maintenance > Sys OP Mode > AP

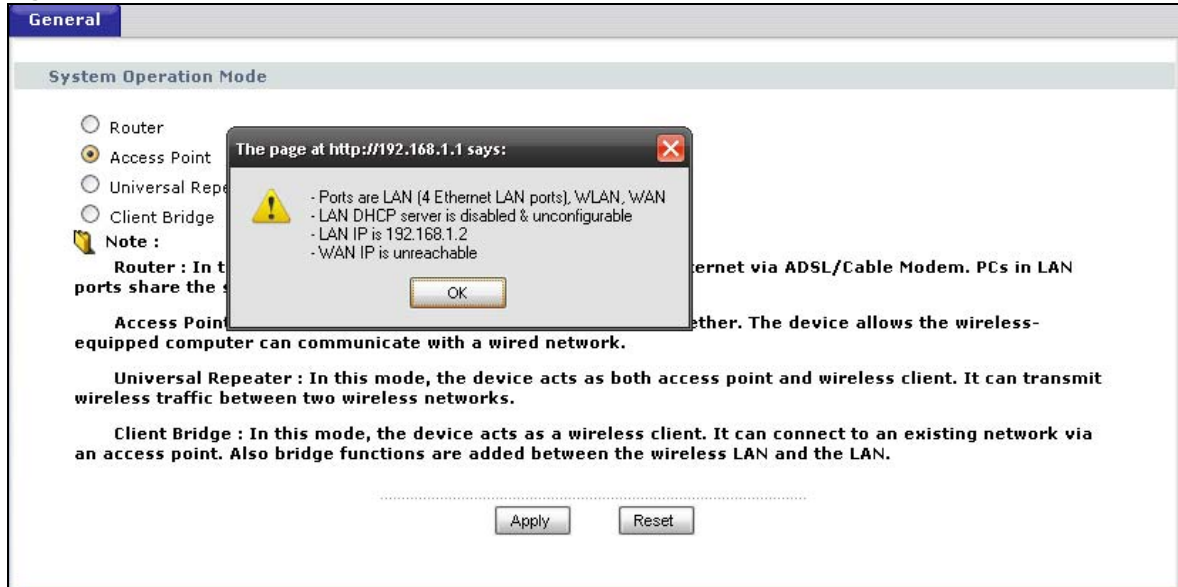

- 6 A pop-up window appears providing information on this mode. Click **OK** in the pop-up message window. Click **Apply**. Your NBG-418N is now in **AP Mode**.

Note: Wait while the NBG-418N restarts, then log in to the Web Configurator again.

4.3.1 Status Screen (AP Mode)

Click on **Status**. The screen below shows the status screen in **AP Mode**.

Figure 31 Status Screen (AP Mode)



The following table describes the labels shown in the **Status** screen.

Table 19 Status Screen (AP Mode)

LABEL	DESCRIPTION
Device Information	
System Name	This is the System Name you enter in the Maintenance > System > General screen. It is for identification purposes.
Firmware Version	This is the current firmware version of the NBG-418N.
LAN Information	
- MAC Address	This shows the LAN Ethernet adapter MAC Address of your device.
- IP Address	This shows the LAN port's IP address.
- IP Subnet Mask	This shows the LAN port's subnet mask.
- DHCP	This shows the LAN port's DHCP role - None .
WLAN Information	
- MAC Address	This shows the wireless adapter MAC Address of your device.
- Status	This shows the current status of the Wireless LAN - On , Off , or Off by scheduler .
- Name (SSID)	This shows a descriptive name used to identify the NBG-418N in the wireless LAN.
- Channel	This shows the channel number which you select manually or the NBG-418N automatically scans and selects.
- Operating Channel	This shows the channel number which the NBG-418N is currently using over the wireless LAN.
- Security Mode	This shows the level of wireless security the NBG-418N is using.
- 802.11 Mode	This shows the IEEE 802.11 standard that the NBG-418N supports. Wireless clients must support the same standard in order to be able to connect to the NBG-418N
- WPS	This shows the WPS (WiFi Protected Setup) Status. Click the status to display Network > Wireless LAN > WPS screen.
System Status	
Operation Mode	This field shows the device operation mode: Router , Access Point , Client Bridge or Universal Repeater .
System Up Time	This is the total time the NBG-418N has been on.
Current Date/Time	This field displays your NBG-418N's present date and time.
System Resource	
- CPU Usage	This displays what percentage of the NBG-418N's processing ability is currently used. When this percentage is close to 100%, the NBG-418N is running at full load, and the throughput is not going to improve anymore. If you want some applications to have more throughput, you should turn off other applications.
- Memory Usage	This shows what percentage of the heap memory the NBG-418N is using.
Interface Status	
Interface	This displays the NBG-418N port types. The port types are: LAN and WLAN .
Status	For the LAN port, this field displays Down (line is down) or Up (line is up or connected). For the WLAN, it displays Up when the WLAN is enabled or Down when the WLAN is disabled.
Rate	For the LAN ports, this displays the port speed and duplex setting or N/A when the line is disconnected. For the WLAN, it displays the maximum transmission rate when the WLAN is enabled and N/A when the WLAN is disabled.
Summary	

Table 19 Status Screen (AP Mode) (continued)

LABEL	DESCRIPTION
Packet Statistics	Use this screen to view port status and packet specific statistics.
WLAN Station Status	Use this screen to view the wireless stations that are currently associated to the NBG-418N.

4.3.2 AP Navigation Panel

Use the menu in the navigation panel to configure NBG-418N features in **AP Mode**.

The following screen and table show the features you can configure in **AP Mode**.

Figure 32 Menu: AP Mode

The following table describes the sub-menus.

Table 20 Menu: AP Mode

LINK	TAB	FUNCTION
Status		This screen shows the NBG-418N's general device, system and interface status information. Use this screen to access the wizard, and summary statistics tables.
Network		
Wireless LAN	General	Use this screen to configure wireless LAN.
	MAC Filter	Use the MAC filter screen to configure the NBG-418N to block access to devices or block the devices from accessing the NBG-418N.
	Advanced	This screen allows you to configure advanced wireless settings.
	QoS	Use this screen to configure Wi-Fi Multimedia Quality of Service (WMM QoS). WMM QoS allows you to prioritize wireless traffic according to the delivery requirements of individual services.
	WPS	Use this screen to configure WPS.
	WPS Station	Use this screen to add a wireless station using WPS.
	Scheduling	Use this screen to schedule the times the Wireless LAN is enabled.
LAN	IP	Use this screen to configure LAN IP address and subnet mask.
Maintenance		
System	General	Use this screen to view and change administrative settings such as system and domain names, password and inactivity timer.
	Time Setting	Use this screen to change your NBG-418N's time and date.

Table 20 Menu: AP Mode (continued)

LINK	TAB	FUNCTION
Logs	View Log	Use this screen to view the logs for the categories that you selected.
Tools	Firmware	Use this screen to upload firmware to your NBG-418N.
	Configuration	Use this screen to backup and restore the configuration or reset the factory defaults to your NBG-418N.
	Restart	This screen allows you to reboot the NBG-418N without turning the power off.
Sys OP Mode	General	This screen allows you to select the device operation mode: Router, Access Point, Client Bridge or Universal Repeater .
Language	Language	This screen allows you to select the language you prefer.

4.4 Setting your NBG-418N to Universal Repeater Mode

- 1 Connect your computer to the LAN port of the NBG-418N.
- 2 The default LAN IP address of the NBG-418N is 192.168.1.1 in router mode (192.168.1.2 by default in non-router mode). In router mode, the NBG-418N can assign your computer an IP address, so you must set your computer to get an IP address automatically (computer factory default) or give it a fixed IP address in the range between 192.168.1.3 and 192.168.1.254.
- 3 After you've set your computer's IP address, open a web browser such as Internet Explorer and type the IP address of the NBG-418N as the web address in your web browser.
- 4 Log into the Web Configurator. See the [Chapter 2 on page 17](#) for instructions on how to do this.
- 5 Go to **Maintenance > Sys OP Mode > General** and select **Universal Repeater**.

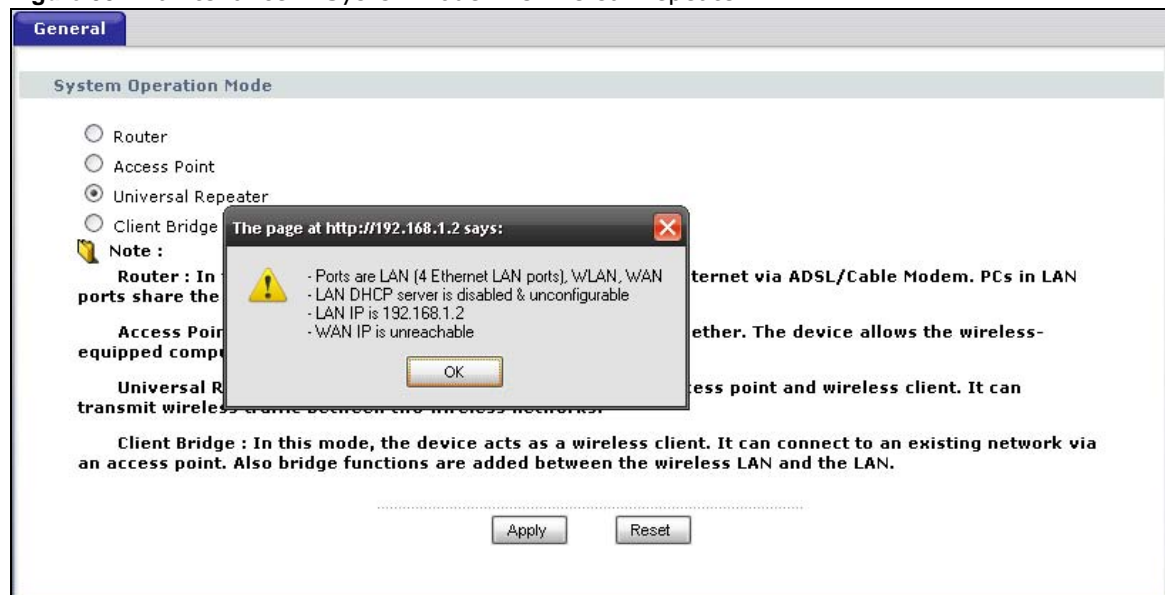
Figure 33 Maintenance > Sys OP Mode > Universal Repeater

- 6 A pop-up window appears providing information on this mode. Click **OK** in the pop-up message window. Click **Apply**. Your NBG-418N is now in **Universal Repeater** mode.

Note: Wait while the NBG-418N restarts, then log in to the Web Configurator again.

4.4.1 Status Screen (Universal Repeater Mode)

Click on **Status**. The screen below shows the status screen in Universal Repeater **Mode**.

Figure 34 Status Screen (Universal Repeater Mode)

The screenshot displays the Status screen for the NBG-418N in Universal Repeater Mode. It features a 'Refresh Interval' dropdown set to 'None' and a 'Refresh Now' button. The screen is divided into four main sections:

- Device Information:**
 - System Name: NBG-418N
 - Firmware Version: V1.00(AAD2.0)b1
 - LAN Information:
 - MAC Address: 00:E0:4C:81:86:86
 - IP Address: 192.168.1.2
 - IP Subnet Mask: 255.255.255.0
 - DHCP: Disable
 - WLAN AP Information:
 - MAC Address: 50:67:F0:32:80:A3
 - Status: On
 - SSID: SSID_Example3
 - Channel: Auto
 - Operating Channel: 11
 - Security Mode: WPA-PSK
 - 802.11 Mode: 802.11 b/g/n
 - WPS: [Configured](#)
 - WLAN STA Information:
 - SSID: ZyXEL
 - Security Mode: No Security
 - Connection Status: Disassociated
- System Status:**
 - Operation Mode: Universal Repeater
 - System Up Time: 00:18:10
 - Current Date/Time: 1976-11-30/00:18:06
 - System Resource:
 - CPU Usage: 1% (represented by a progress bar)
 - Memory Usage: 42% (represented by a progress bar)
- Interface Status:**

Interface	Status	Rate
LAN	Down	NA
WLAN AP	Up	300M
WLAN STA	Down	NA
- Summary:**
 - Packet Statistics ([Details...](#))
 - WLAN Station Status ([Details...](#))

The following table describes the labels shown in the **Status** screen.

Table 21 Status Screen (Universal Repeater Mode)

LABEL	DESCRIPTION
Device Information	
System Name	This is the System Name you enter in the Maintenance > System > General screen. It is for identification purposes.
Firmware Version	This is the current firmware version of the NBG-418N.
LAN Information	
- MAC Address	This shows the LAN Ethernet adapter MAC Address of your device.
- IP Address	This shows the LAN port's IP address.
- IP Subnet Mask	This shows the LAN port's subnet mask.
- DHCP	This shows the LAN port's DHCP role.

Table 21 Status Screen (Universal Repeater Mode) (continued)

LABEL	DESCRIPTION
WLAN AP Information	
- MAC Address	This shows the wireless adapter MAC Address of your device.
- Status	This shows the current status of the Wireless LAN - On , Off , or Off by scheduler .
- SSID	This shows a descriptive name used to identify the NBG-418N in the wireless LAN.
- Channel	This shows the channel number which you select manually or the NBG-418N automatically scans and selects.
- Operating Channel	This shows the channel number which the NBG-418N is currently using over the wireless LAN.
- Security Mode	This shows the level of wireless security the NBG-418N is using.
- 802.11 Mode	This shows the IEEE 802.11 standard that the NBG-418N supports. Wireless clients must support the same standard in order to be able to connect to the NBG-418N
- WPS	This shows the WPS (WiFi Protected Setup) Status. Click the link to display Network > Wireless LAN > WPS screen.
WLAN STA Information	
- SSID	This is the name of the selected AP that the NBG-418N is associating with.
- Security Mode	This shows the wireless security the NBG-418N is using to connect to the AP.
- Connection Status	This shows whether the NBG-418N is currently associated with the selected AP.
System Status	
Operation Mode	This field shows the device operation mode: Router , Access Point , Client Bridge or Universal Repeater .
System Up Time	This is the total time the NBG-418N has been on.
Current Date/Time	This field displays your NBG-418N's present date and time.
System Resource	
- CPU Usage	This displays what percentage of the NBG-418N's processing ability is currently used. When this percentage is close to 100%, the NBG-418N is running at full load, and the throughput is not going to improve anymore. If you want some applications to have more throughput, you should turn off other applications.
- Memory Usage	This shows what percentage of the heap memory the NBG-418N is using.
Interface Status	
Interface	This displays the NBG-418N port types. The port types are: LAN and WLAN .
Status	For the LAN port, this field displays Down (line is down) or Up (line is up or connected). For the WLAN, it displays Up when the WLAN is enabled or Down when the WLAN is disabled.
Rate	For the LAN ports, this displays the port speed and duplex setting or N/A when the line is disconnected. For the WLAN, it displays the maximum transmission rate when the WLAN is enabled and N/A when the WLAN is disabled.
Summary	
Packet Statistics	Use this screen to view port status and packet specific statistics.
WLAN Station Status	Use this screen to view the wireless stations that are currently associated to the NBG-418N.

4.4.2 Universal Repeater Navigation Panel

Use the menu in the navigation panel to configure NBG-418N features in **Universal Repeater Mode**.

The following screen and table show the features you can configure in **Universal Repeater Mode**.

Figure 35 Menu: Universal Repeater Mode

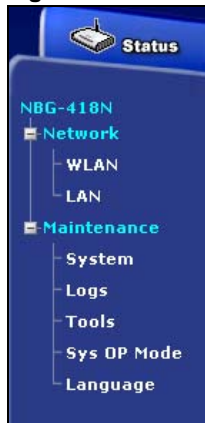

The following table describes the sub-menus.

Table 22 Menu: Universal Repeater Mode

LINK	TAB	FUNCTION
Status		This screen shows the NBG-418N's general device, system and interface status information. Use this screen to access the wizard, and summary statistics tables.
Network		
WLAN	AP Select	Use this screen to choose an access point that you want the NBG-418N to connect to. You should know the security settings of the target AP.
	General	Use this screen to configure wireless LAN.
	MAC Filter	Use the MAC filter screen to configure the NBG-418N to block access to devices or block the devices from accessing the NBG-418N.
	Advanced	This screen allows you to configure advanced wireless settings.
	QoS	Use this screen to configure Wi-Fi Multimedia Quality of Service (WMM QoS). WMM QoS allows you to prioritize wireless traffic according to the delivery requirements of individual services.
	WPS	Use this screen to configure WPS.
	WPS Station	Use this screen to add a wireless station using WPS.
	Scheduling	Use this screen to schedule the times the Wireless LAN is enabled.
LAN	IP	Use this screen to configure LAN IP address and subnet mask.
Maintenance		
System	General	Use this screen to view and change administrative settings such as system and domain names, password and inactivity timer.
	Time Setting	Use this screen to change your NBG-418N's time and date.
Logs	View Log	Use this screen to view the logs for the categories that you selected.

Table 22 Menu: Universal Repeater Mode (continued)

LINK	TAB	FUNCTION
Tools	Firmware	Use this screen to upload firmware to your NBG-418N.
	Configuration	Use this screen to backup and restore the configuration or reset the factory defaults to your NBG-418N.
	Restart	This screen allows you to reboot the NBG-418N without turning the power off.
Sys OP Mode	General	This screen allows you to select the device operation mode: Router , Access Point , Client Bridge or Universal Repeater .
Language	Language	This screen allows you to select the language you prefer.

4.5 Setting your NBG-418N to Client Bridge Mode

- 1 Connect your computer to the LAN port of the NBG-418N.
- 2 The default LAN IP address of the NBG-418N is 192.168.1.1 in router mode (192.168.1.2 by default in non-router mode). In router mode, the NBG-418N can assign your computer an IP address, so you must set your computer to get an IP address automatically (computer factory default) or give it a fixed IP address in the range between 192.168.1.3 and 192.168.1.254.
- 3 After you've set your computer's IP address, open a web browser such as Internet Explorer and type the IP address of the NBG-418N as the web address in your web browser.
- 4 Log into the Web Configurator. See the [Chapter 2 on page 17](#) for instructions on how to do this.
- 5 Go to **Maintenance > Sys OP Mode > General** and select **Client Bridge**.

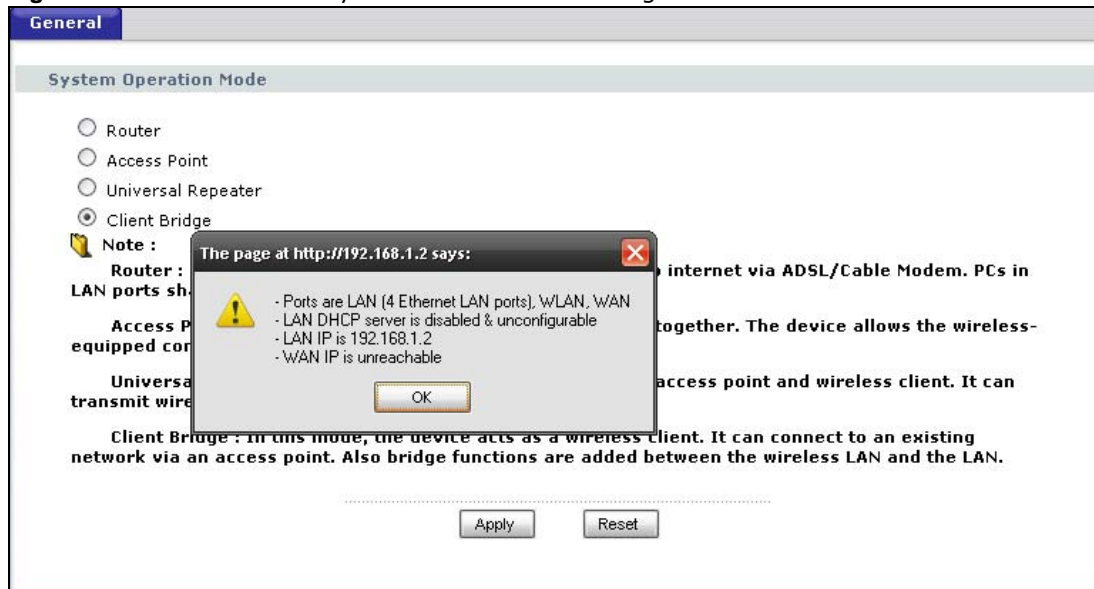
Figure 36 Maintenance > Sys OP Mode > Client Bridge

- 6 A pop-up window appears providing information on this mode. Click **OK** in the pop-up message window. Click **Apply**. Your NBG-418N is now in **Client Bridge** mode.

Note: Wait while the NBG-418N restarts, then log in to the Web Configurator again.

4.5.1 Status Screen (Client Bridge Mode)

Click on **Status**. The screen below shows the status screen in **Client Bridge Mode**.

Figure 37 Status Screen (Client Bridge Mode)



The following table describes the labels shown in the **Status** screen.

Table 23 Status Screen (Client Bridge Mode)

LABEL	DESCRIPTION
Device Information	
System Name	This is the System Name you enter in the Maintenance > System > General screen. It is for identification purposes.
Firmware Version	This is the current firmware version of the NBG-418N.
WLAN Information	
- SSID	This is the name of the selected AP that the NBG-418N is associating with.
- Operating Channel	This shows the channel that is used to connect to the selected AP.
- Security Mode	This shows the wireless security the NBG-418N is using to connect to the AP.
- Connection Status	This shows whether the NBG-418N is currently associated with the selected AP.
LAN Information	
- MAC Address	This shows the LAN Ethernet adapter MAC Address of your device.
- IP Address	This shows the LAN port's IP address.
- IP Subnet Mask	This shows the LAN port's subnet mask.
- DHCP	This shows the LAN port's DHCP role - None .
System Status	
Operation Mode	This field shows the device operation mode: Router, Access Point, Client Bridge or Universal Repeater .
System Up Time	This is the total time the NBG-418N has been on.

Table 23 Status Screen (Client Bridge Mode) (continued)

LABEL	DESCRIPTION
Current Date/Time	This field displays your NBG-418N's present date and time.
System Resource	
- CPU Usage	This displays what percentage of the NBG-418N's processing ability is currently used. When this percentage is close to 100%, the NBG-418N is running at full load, and the throughput is not going to improve anymore. If you want some applications to have more throughput, you should turn off other applications.
- Memory Usage	This shows what percentage of the heap memory the NBG-418N is using.
Interface Status	
Interface	This displays the NBG-418N port types. The port types are: LAN and WLAN .
Status	For the LAN port, this field displays Down (line is down) or Up (line is up or connected). For the WLAN, it displays Up when the WLAN is enabled or Down when the WLAN is disabled.
Rate	For the LAN ports, this displays the port speed and duplex setting or N/A when the line is disconnected. For the WLAN, it displays the maximum transmission rate when the WLAN is enabled and N/A when the WLAN is disabled.
Summary	
Packet Statistics	Use this screen to view port packet statistics.

4.5.2 Client Bridge Navigation Panel

Use the menu in the navigation panel to configure NBG-418N features in **Client Bridge Mode**.

The following screen and table show the features you can configure in **Client Bridge Mode**.

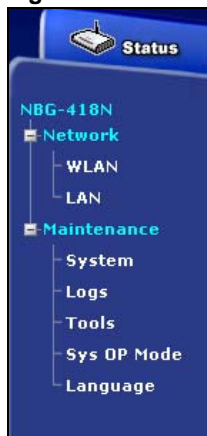
Figure 38 Menu: Client Bridge Mode

The following table describes the sub-menus.

Table 24 Menu: Client Bridge Mode

LINK	TAB	FUNCTION
Status		This screen shows the NBG-418N's general device, system and interface status information. Use this screen to access the wizard, and summary statistics tables.
Network		
WLAN	AP Select	Use this screen to choose an access point that you want the NBG-418N to connect to. You should know the security settings of the target AP.
	WLAN Information	Use this screen to view the SSID and security of the selected AP wireless network.
	Advanced	Use this screen to configure advanced wireless settings.
LAN	IP	Use this screen to configure LAN IP address and subnet mask.
Maintenance		
System	General	Use this screen to view and change administrative settings such as system and domain names, password and inactivity timer.
	Time Setting	Use this screen to change your NBG-418N's time and date.
Logs	View Log	Use this screen to view the logs for the categories that you selected.
Tools	Firmware	Use this screen to upload firmware to your NBG-418N.
	Configuration	Use this screen to backup and restore the configuration or reset the factory defaults to your NBG-418N.
	Restart	This screen allows you to reboot the NBG-418N without turning the power off.
Sys OP Mode	General	This screen allows you to select whether your device acts as a Router, Access Point, Client Bridge or Universal Repeater .
Language	Language	This screen allows you to select the language you prefer.

5.1 Overview

This chapter provides tutorials for your NBG-418N as follows:

- [How to Connect to the Internet from an AP](#)
 - [Configure Wireless Security Using WPS on both your NBG-418N and Wireless Client](#)
- [Enable and Configure Wireless Security without WPS on your NBG-418N](#)

5.2 How to Connect to the Internet from an AP

This section gives you an example of how to set up an access point (**AP**) and wireless client (a notebook, **B** in this example) for wireless communication. **B** can access the Internet through the AP wirelessly.

Figure 39 Wireless AP Connection to the Internet

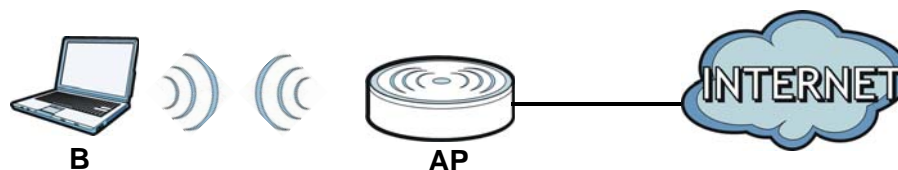

5.2.1 Configure Wireless Security Using WPS on both your NBG-418N and Wireless Client

This section gives you an example of how to set up wireless network using WPS. This example uses the NBG-418N as the AP and NWD210N as the wireless client which connects to a notebook.

Note: The wireless client must be a WPS-aware device (for example, a WPS USB adapter or PCI card).

There are two WPS methods for creating a secure connection. This tutorial shows you how to do both.

- **Push Button Configuration (PBC)** - create a secure wireless network simply by pressing a button. See [Section 5.2.1.1 on page 58](#). This is the easier method.
- **PIN Configuration** - create a secure wireless network simply by entering a wireless client's PIN (Personal Identification Number) in the NBG-418N's interface. See [Section 5.2.1.2 on page 59](#). This is the more secure method, since one device can authenticate the other.

5.2.1.1 Push Button Configuration (PBC)

- 1 Make sure that your NBG-418N is turned on and that it is within range of your computer.
- 2 Make sure that you have installed the wireless client (this example uses the NWD210N) driver and utility in your notebook.
- 3 In the wireless client utility, find the WPS settings. Enable WPS and press the WPS button (**Start** or **WPS** button)
- 4 Log into NBG-418N's Web Configurator and press **Push Button** in the **Network > Wireless LAN > WPS Station** screen.

Note: Your NBG-418N has a WPS button located on its panel, as well as a WPS button in its configuration utility. Both buttons have exactly the same function; you can use one or the other.

Note: It doesn't matter which button is pressed first. You must press the second button within two minutes of pressing the first one.

The NBG-418N sends the proper configuration settings to the wireless client. This may take up to two minutes. Then the wireless client is able to communicate with the NBG-418N securely.

The following figure shows you an example to set up wireless network and security by pressing a button on both NBG-418N and wireless client (the NWD210N in this example).

Figure 40 Example WPS Process: PBC Method

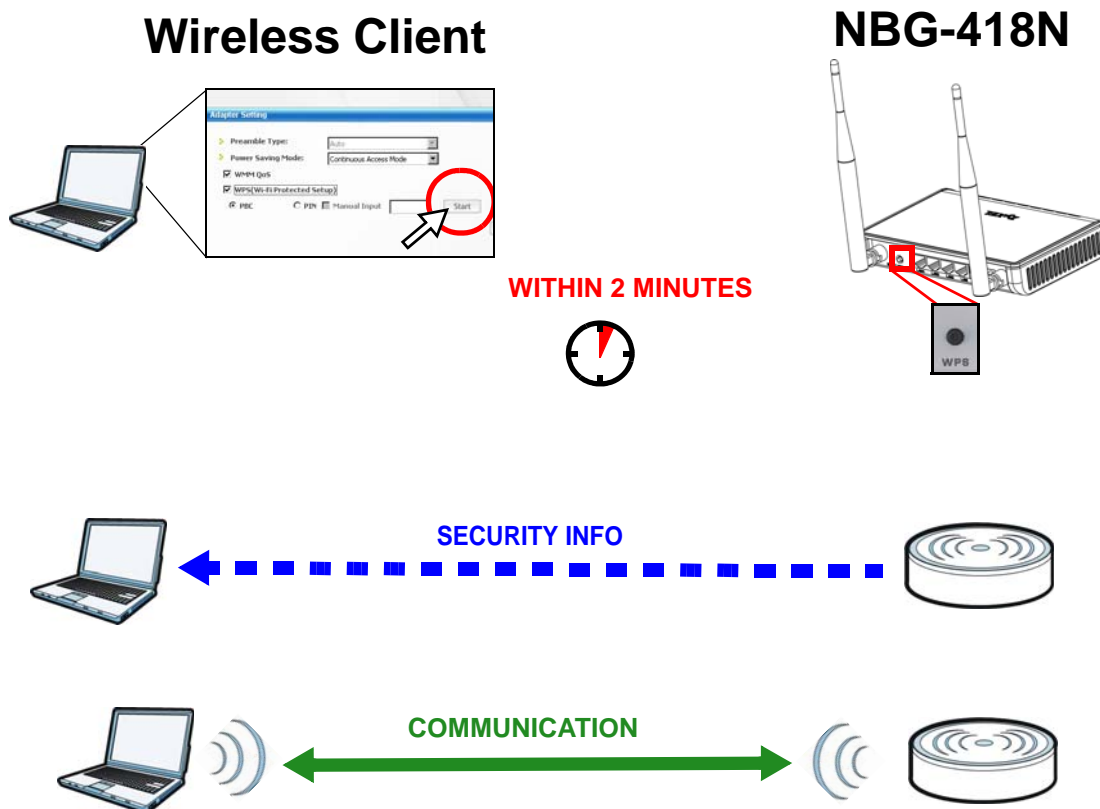

5.2.1.2 PIN Configuration

When you use the PIN configuration method, you need to use both NBG-418N's configuration interface and the client's utilities.

- 1 Launch your wireless client's configuration utility. Go to the WPS settings and select the PIN method to get a PIN number.
- 2 Enter the PIN number to the **PIN** field in the **Network > Wireless LAN > WPS Station** screen on the NBG-418N.
- 3 Click the **Start** buttons (or button next to the PIN field) on both the wireless client utility screen and the NBG-418N's **WPS Station** screen within two minutes.

The NBG-418N authenticates the wireless client and sends the proper configuration settings to the wireless client. This may take up to two minutes. Then the wireless client is able to communicate with the NBG-418N securely.

The following figure shows you the example to set up wireless network and security on NBG-418N and wireless client (ex. NWD210N in this example) by using PIN method.

Figure 41 Example WPS Process: PIN Method

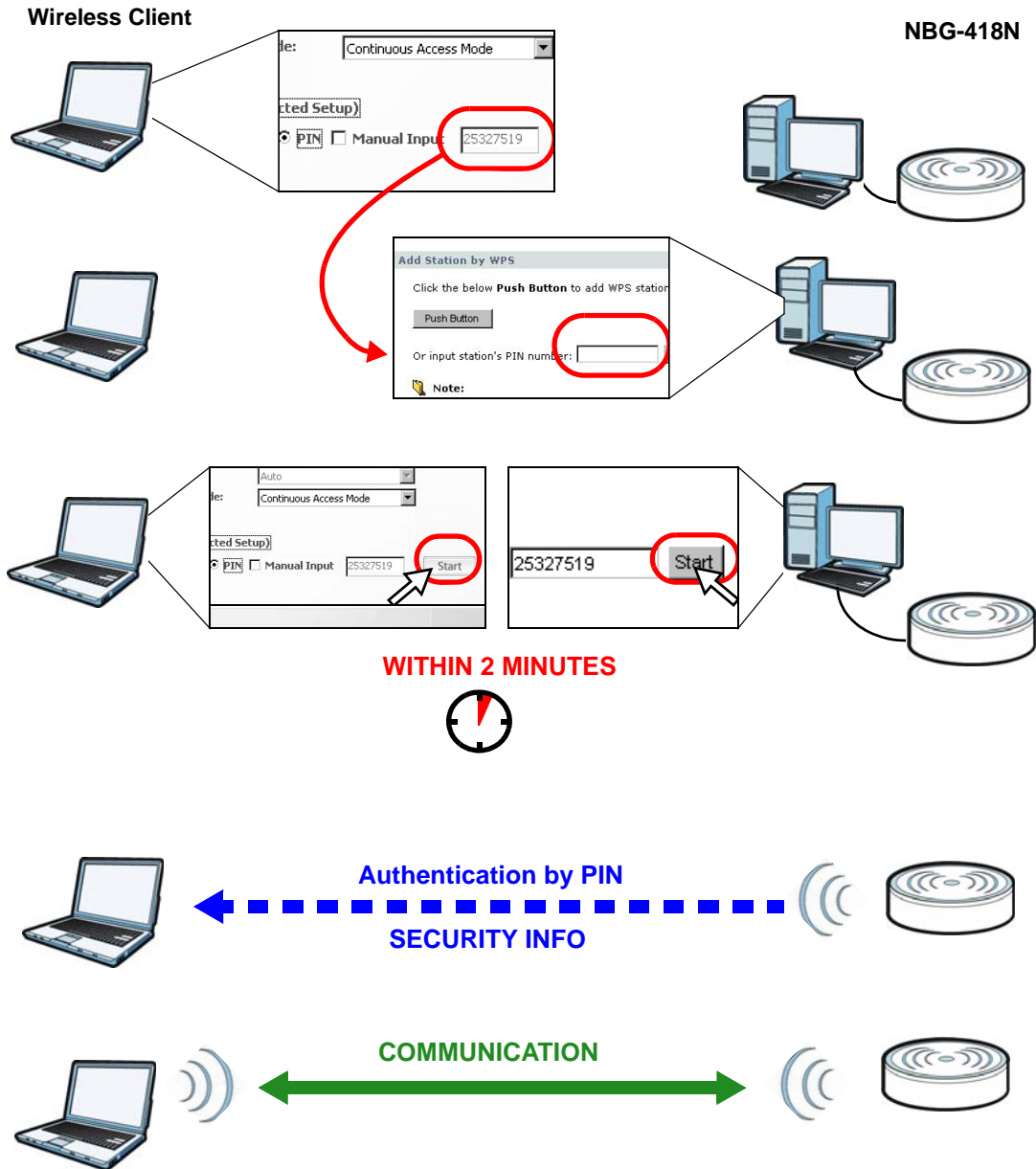

5.3 Enable and Configure Wireless Security without WPS on your NBG-418N

This example shows you how to configure wireless security settings with the following parameters on your NBG-418N.

SSID	SSID_Example3
Channel	6
Security	WPA-PSK (Pre-Shared Key: ThisismyWPA-PSKpre-sharedkey)

Follow the steps below to configure the wireless settings on your NBG-418N.

The instructions require that your hardware is connected (see the Quick Start Guide) and you are logged into the Web Configurator through your LAN connection (see [Section 2.2 on page 17](#)).

- 1 Open the **Wireless LAN > General** screen in the NBG-418N's Web Configurator.
- 2 Make sure the **Enable Wireless LAN** check box is selected.
- 3 Enter **SSID_Example3** as the SSID and select a channel.
- 4 Set security mode to **WPA-PSK** and enter **ThisismyWPA-PSKpre-sharedkey** in the **Pre-Shared Key** field. Click **Apply**.

Figure 42 Tutorial: Network > Wireless LAN > General

The screenshot displays the 'WLAN Setup' and 'Security' configuration pages. In the 'WLAN Setup' section, the 'Enable Wireless LAN' checkbox is checked and circled in red. The 'Name(SSID)' field contains 'SSID_Example3' and is also circled in red. Below this, the 'Channel Selection' is set to 'Channel-01 2412Mhz' and 'Auto Channel Selection' is checked. The 'Operating Channel' is 'Channel- 1' and 'Channel Width' is 'Auto 20/40 MHz'. The 'Security' section shows 'Security Mode' set to 'WPA-PSK', 'Cipher Type' set to 'TKIP+AES', and 'Pre-Shared Key' set to 'ThisismyWPA-PSKpre-sharedkey'. The 'Pre-Shared Key' field is circled in red. There are radio buttons for 'ASCII' (selected) and 'Hex'. A note at the bottom states: 'Note: WPA-PSK and WPA2-PSK can be configured when WPS enabled'. At the bottom of the page are 'Apply' and 'Reset' buttons.

- 5 Open the **Status** screen. Verify your wireless and wireless security settings under **Device Information** and check if the WLAN connection is up under **Interface Status**.

Figure 43 Tutorial: Status Screen

The screenshot displays the ZyXEL NBG-418N Status Screen. The left sidebar shows a navigation menu with categories like Network, Security, Management, and Maintenance. The main content area is divided into several sections:

- Device Information:** Shows System Name (NBG-418N), Firmware Version (V1.00(AADZ.0)b0), WAN Information (MAC Address: 50:67:F0:32:80:A4, Connection Type: Ethernet, IP Address: 0.0.0.0, Subnet Mask: 0.0.0.0, Gateway: 0.0.0.0, DNS: 0.0.0.0), LAN Information (MAC Address: 50:67:F0:32:80:A3, IP Address: 192.168.1.1, Subnet Mask: 255.255.255.0, DHCP: Server), and WLAN Information (MAC Address: 50:67:F0:32:80:A5, Status: On, Name(SSID): SSID_Example3, Channel: Auto, Operating Channel: 1, Security Mode: WPA-PSK, 802.11 Mode: 802.11 b/g/n, WPS: Configured).
- System Status:** Shows Operation Mode (Router), System Up Time (00:04:57), Current Date/Time (1976-11-30/00:04:52), System Resource (CPU Usage: 3%, Memory Usage: 41%), and System Setting (Firewall: Enable, UPnP: Enable).
- Interface Status:** A table showing the status of WAN, LAN, and WLAN interfaces.
- Summary:** Links to DHCP Table, Packet Statistics, and WLAN Station Status.

The WLAN Information section and the WLAN row in the Interface Status table are highlighted with red circles.

Interface	Status	Rate
WAN	Down	NA
LAN	Down	NA
WLAN	Up	150M

5.3.0.1 Configure Your Notebook

Note: We use the ZyXEL M-302 wireless adapter utility screens as an example for the wireless client. The screens may vary for different models.

- 1 The NBG-418N supports IEEE 802.11b, IEEE 802.11g and IEEE 802.11n wireless clients. Make sure that your notebook or computer's wireless adapter supports one of these standards.
- 2 Wireless adapters come with software sometimes called a "utility" that you install on your computer. See your wireless adapter's User's Guide for information on how to do that.
- 3 After you've installed the utility, open it. If you cannot see your utility's icon on your screen, go to **Start > Programs** and click on your utility in the list of programs that appears. The utility displays a list of APs within range, as shown in the example screen below.
- 4 Select **SSID_Example3** and click **Connect**.

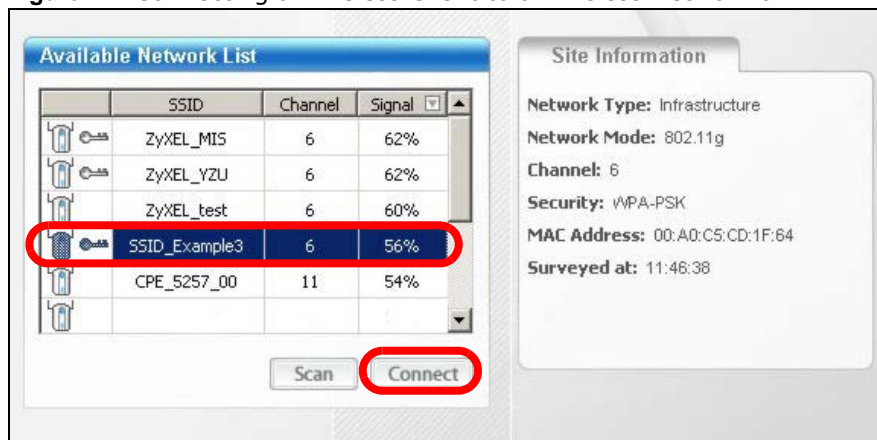
Figure 44 Connecting a Wireless Client to a Wireless Network

- 5 Select WPA-PSK and type the security key in the following screen. Click **Next**.

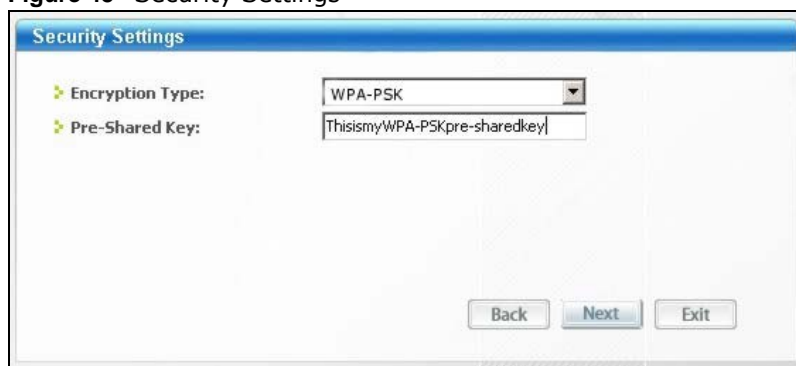
Figure 45 Security Settings

- 6 The **Confirm Save** window appears. Check your settings and click **Save** to continue.

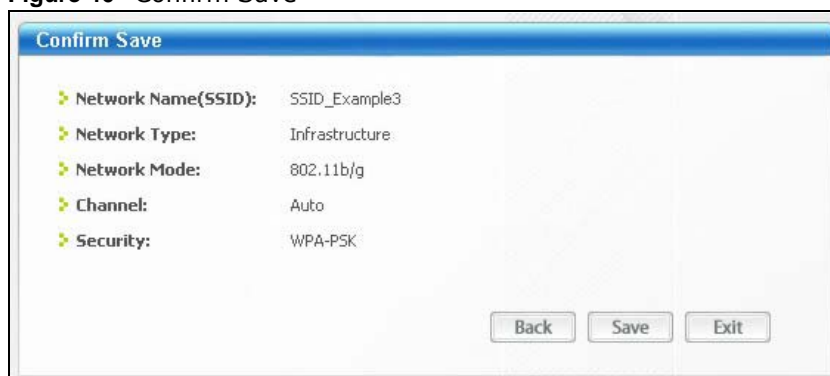
Figure 46 Confirm Save

- 7 Check the status of your wireless connection in the screen below. If your wireless connection is weak or you have no connection, see the [Troubleshooting](#) section of this User's Guide.

Figure 47 Link Status

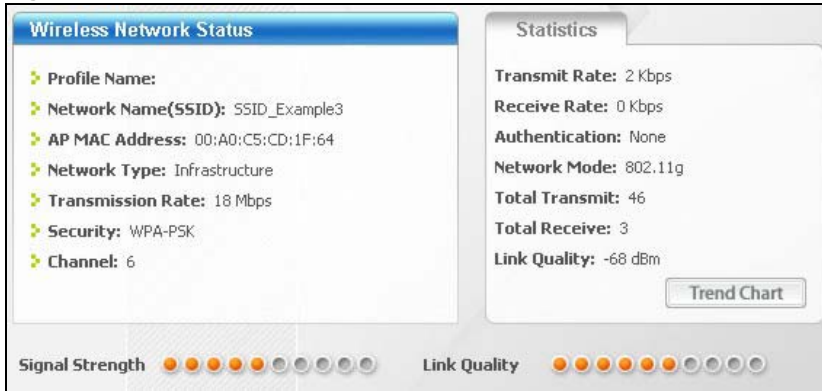

If your connection is successful, open your Internet browser and enter <http://www.zyxel.com> or the URL of any other web site in the address bar. If you are able to access the web site, your wireless connection is successfully configured.

PART II

Technical Reference

Wireless LAN

6.1 Overview

This chapter discusses how to configure the wireless network settings in your NBG-418N. See the appendices for more detailed information about wireless networks.

The following figure provides an example of a wireless network.

Figure 48 Example of a Wireless Network

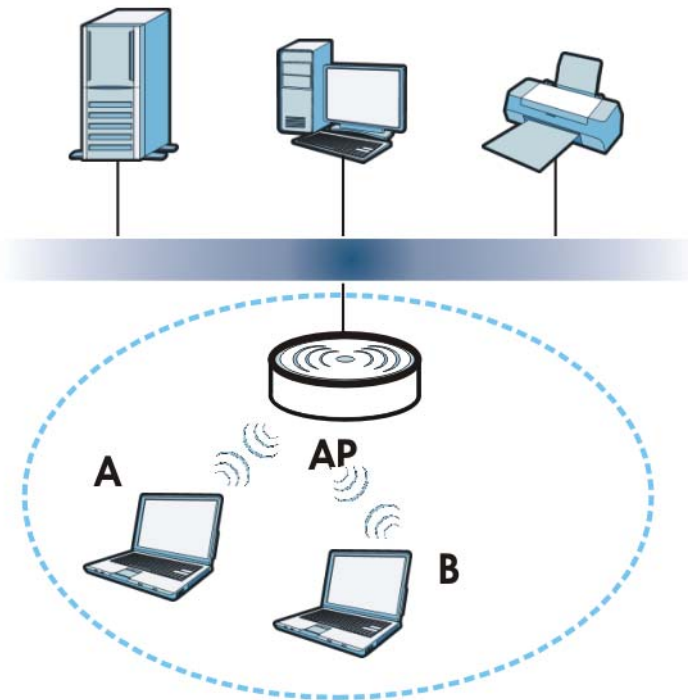

The wireless network is the part in the blue circle. In this wireless network, devices **A** and **B** are called wireless clients. The wireless clients use the access point (**AP**) to interact with other devices (such as the printer) or with the Internet. Your NBG-418N is the AP in the above example.

6.2 What You Can Do

Wireless screens vary according to the device mode you are using.

Wireless Screen	Router	Access Point	Universal Repeater	Client Bridge
General	✓	✓	✓	
MAC Filter	✓	✓	✓	
Advanced	✓	✓	✓	✓
QoS	✓	✓	✓	
WPS	✓	✓	✓	
WPS Station	✓	✓	✓	
Scheduling	✓	✓	✓	
AP Select			✓	✓
WLAN Info				✓

See [Chapter 4 on page 35](#) for more information on device modes.

- Use the **General** screen to enable the Wireless LAN, enter the SSID and select the wireless security mode ([Section 6.4 on page 70](#)).
- Use the **MAC Filter** screen to allow or deny wireless stations based on their MAC addresses from connecting to the NBG-418N ([Section 6.5 on page 75](#)).
- Use the **Advanced** screen to allow intra-BSS networking and set the RTS/CTS Threshold ([Section 6.6 on page 76](#)).
- Use the **QoS** screen to enable Wifi MultiMedia Quality of Service (WMMQoS). This allows the NBG-418N to automatically set priority levels to services, such as e-mail, VoIP, chat, and so on ([Section 6.7 on page 78](#)).
- Use the **WPS** screen to quickly set up a wireless network with strong security, without having to configure security settings manually ([Section 6.8 on page 79](#)).
- Use the **WPS Station** screen to add a wireless station using WPS ([Section 6.9 on page 80](#)).
- Use the **Scheduling** screen to set the times your wireless LAN is turned on and off ([Section 6.10 on page 81](#)).
- Use the **AP Select** screen to choose an access point that you want the NBG-418N (in universal repeater or client bridge mode) to connect to. You should know the security settings of the target AP.
- Use the **WLAN Info** screen to view the SSID and security of the selected AP wireless network.

6.3 What You Should Know

Every wireless network must follow these basic guidelines.

- Every wireless client in the same wireless network must use the same SSID.
The SSID is the name of the wireless network. It stands for Service Set IDentity.
- If two wireless networks overlap, they should use different channels.
Like radio stations or television channels, each wireless network uses a specific channel, or frequency, to send and receive information.
- Every wireless client in the same wireless network must use security compatible with the AP.
Security stops unauthorized devices from using the wireless network. It can also protect the information that is sent in the wireless network.

6.3.1 Wireless Security Overview

The following sections introduce different types of wireless security you can set up in the wireless network.

6.3.1.1 SSID

Normally, the AP acts like a beacon and regularly broadcasts the SSID in the area. You can hide the SSID instead, in which case the AP does not broadcast the SSID. In addition, you should change the default SSID to something that is difficult to guess.

This type of security is fairly weak, however, because there are ways for unauthorized devices to get the SSID. In addition, unauthorized devices can still see the information that is sent in the wireless network.

6.3.1.2 MAC Address Filter

Every wireless client has a unique identification number, called a MAC address.¹ A MAC address is usually written using twelve hexadecimal characters²; for example, 00A0C5000002 or 00:A0:C5:00:00:02. To get the MAC address for each wireless client, see the appropriate User's Guide or other documentation.

You can use the MAC address filter to tell the AP which wireless clients are allowed or not allowed to use the wireless network. If a wireless client is allowed to use the wireless network, it still has to have the correct settings (SSID, channel, and security). If a wireless client is not allowed to use the wireless network, it does not matter if it has the correct settings.

This type of security does not protect the information that is sent in the wireless network. Furthermore, there are ways for unauthorized devices to get the MAC address of an authorized wireless client. Then, they can use that MAC address to use the wireless network.

1. Some wireless devices, such as scanners, can detect wireless networks but cannot use wireless networks. These kinds of wireless devices might not have MAC addresses.

2. Hexadecimal characters are 0, 1, 2, 3, 4, 5, 6, 7, 8, 9, A, B, C, D, E, and F.

6.3.1.3 Encryption

Wireless networks can use encryption to protect the information that is sent in the wireless network. Encryption is like a secret code. If you do not know the secret code, you cannot understand the message.

Table 25 Types of Encryption for Each Type of Authentication

	NO AUTHENTICATION
Weakest	No Security
↕	Static WEP
↕	WPA-PSK
Strongest	WPA2-PSK

For example, if users do not log in to the wireless network, you can choose no encryption, **Static WEP**, **WPA-PSK**, or **WPA2-PSK**.

Usually, you should set up the strongest encryption that every wireless client in the wireless network supports. Suppose the wireless network has two wireless clients. Device A only supports WEP, and device B supports WEP and WPA-PSK. Therefore, you should set up **Static WEP** in the wireless network.

Note: It is recommended that wireless networks use WPA-PSK, or stronger encryption. IEEE 802.1x and WEP encryption are better than none at all, but it is still possible for unauthorized devices to figure out the original information pretty quickly.

When you select **WPA2-PSK** in your NBG-418N, you can also select an option (**WPA Compatible**) to support WPA-PSK as well. In this case, if some wireless clients support WPA-PSK and some support WPA2-PSK, you should set up **WPA2-PSK** and select the **WPA Compatible** option in the NBG-418N.

Many types of encryption use a key to protect the information in the wireless network. The longer the key, the stronger the encryption. Every wireless client in the wireless network must have the same key.

6.3.1.4 WPS

WiFi Protected Setup (WPS) is an industry standard specification, defined by the WiFi Alliance. WPS allows you to quickly set up a wireless network with strong security, without having to configure security settings manually. Depending on the devices in your network, you can either press a button (on the device itself, or in its configuration utility) or enter a PIN (Personal Identification Number) in the devices. Then, they connect and set up a secure network by themselves. See how to set up a secure wireless network using WPS in the [Section 5.2.1 on page 57](#).

6.4 General Wireless LAN Screen

Use this screen to enable the Wireless LAN, enter the SSID and select the wireless security mode.

Note: If you are configuring the NBG-418N from a computer connected to the wireless LAN and you change the NBG-418N's SSID, channel or security settings, you will lose your wireless connection when you press **Apply** to confirm. You must then change the wireless settings of your computer to match the NBG-418N's new settings.

Click **Network > Wireless LAN** to open the **General** screen.

Figure 49 Network > Wireless LAN > General (Router or Access Point Mode)

The screenshot shows the 'General' configuration page for Router or Access Point Mode. The page has tabs for 'General', 'MAC Filter', 'Advanced', 'QoS', 'WPS', 'WPS Station', and 'Scheduling'. The 'General' tab is selected. Under 'Wireless Setup', the 'Enable Wireless LAN' checkbox is checked. The 'Name(SSID)' field contains 'ZyXEL'. The 'Hide SSID' checkbox is unchecked. The 'Channel Selection' dropdown is set to 'Channel-01 2412Mhz', and the 'Auto Channel Selection' checkbox is checked. The 'Operating Channel' is 'Channel- Auto' and the 'Channel Width' is 'Auto 20/40 MHz'. Under 'Security', the 'Security Mode' dropdown is set to 'No Security'. A note states: 'Note: WPA-PSK and WPA2-PSK can be configured when WPS enabled'. At the bottom, there are 'Apply' and 'Reset' buttons.

Figure 50 Network > Wireless LAN > General (Universal Repeater Mode)

The screenshot shows the 'General' configuration page for Universal Repeater Mode. The page has tabs for 'AP Select', 'General', 'MAC Filter', 'Advanced', 'QoS', 'WPS', 'WPS Station', and 'Scheduling'. The 'General' tab is selected. Under 'WLAN STA Information', the 'SSID' is 'ZyXEL_MIS', the 'Security Mode' is 'WEP', and the 'Operating Channel' is 'Channel- 1'. Under 'WLAN AP Information', the 'Enable Wireless LAN' checkbox is checked. The 'Name(SSID)' field contains 'ZyXEL418N'. The 'Hide SSID' checkbox is unchecked. The 'Channel Width' dropdown is set to 'Auto 20/40 MHz'. Under 'Security', the 'Security Mode' dropdown is set to 'No Security'. A note states: 'Note: WPA-PSK and WPA2-PSK can be configured when WPS enabled'. At the bottom, there are 'Apply' and 'Reset' buttons.

The following table describes the general wireless LAN labels in this screen.

Table 26 Network > Wireless LAN > General

LABEL	DESCRIPTION
WLAN STA Information	This section is available only when the NBG-418N is in universal repeater mode. This shows the wireless and security settings of the selected AP wireless network.
SSID	This displays the Service Set IDentity of the wireless device to which you are connecting.
Security Mode	This displays the type of security configured on the wireless device to which you are connecting.
Operating Channel	This displays the channel used by the wireless device to which you are connecting.
WLAN AP Information / Wireless Setup	Use this section to configure the wireless settings between the NBG-418N and its wireless clients.
Enable Wireless LAN	Click the check box to activate wireless LAN.
Name(SSID)	(Service Set IDentity) The SSID identifies the Service Set with which a wireless station is associated. Wireless stations associating to the access point (AP) must have the same SSID. Enter a descriptive name (up to 32 printable 7-bit ASCII characters) for the wireless LAN.
Hide SSID	Select this check box to hide the SSID in the outgoing beacon frame so a station cannot obtain the SSID through scanning using a site survey tool.
Channel Selection	Set the operating frequency/channel depending on your particular region. Select a channel from the drop-down list box. The options vary depending on the frequency band and the country you are in. Refer to the Connection Wizard chapter for more information on channels. This option is only available if Auto Channel Selection is disabled.
Auto Channel Selection	Select this option for the NBG-418N to automatically choose the channel with the least interference. Deselect this option if you wish to manually select the channel using the Channel Selection field.
Operating Channel	This displays the channel the NBG-418N is currently using.
Channel Width	Select whether the NBG-418N uses a wireless channel width of 20MHz , 40MHz or Auto 20/40MHz . A standard 20MHz channel offers transfer speeds of up to 150Mbps whereas a 40MHz channel uses two standard channels and offers speeds of up to 300 Mbps. Because not all devices support 40MHz channels, select Auto 20/40MHz to allow the NBG-418N to adjust the channel bandwidth automatically.
Security	Use this section to configure the wireless security between the NBG-418N and its wireless clients.
Security Mode	Select Static WEP , WPA-PSK or WPA2-PSK to add security on this wireless network. The wireless clients which want to associate to this network must have same wireless security settings as this device. After you select to use a security, additional options appears in this screen. See 6.4.2 and 6.4.3 sections. Or you can select No Security to allow any client to associate this network without authentication.
Apply	Click Apply to save your changes back to the NBG-418N.
Reset	Click Reset to reload the previous configuration for this screen.

See the rest of this chapter for information on the other labels in this screen.

6.4.1 No Security

Select **No Security** to allow wireless stations to communicate with the access points without any data encryption.

Note: If you do not enable any wireless security on your NBG-418N, your network is accessible to any wireless networking device that is within range.

Figure 51 Network > Wireless LAN > General: No Security

The screenshot shows the 'Security' configuration page. At the top, 'Security Mode' is set to 'No Security' in a dropdown menu. Below this, there is a note: 'Note: WPA-PSK and WPA2-PSK can be configured when WPS enabled'. At the bottom of the page, there are two buttons: 'Apply' and 'Reset'.

The following table describes the labels in this screen.

Table 27 Network > Wireless LAN > General: No Security

LABEL	DESCRIPTION
Security Mode	Choose No Security from the drop-down list box.
Apply	Click Apply to save your changes back to the NBG-418N.
Reset	Click Reset to reload the previous configuration for this screen.

6.4.2 WEP Encryption

WEP encryption scrambles the data transmitted between the wireless stations and the access points to keep network communications private. It encrypts unicast and multicast communications in a network. Both the wireless stations and the access points must use the same WEP key.

Your NBG-418N allows you to configure up to four 64-bit or 128-bit WEP keys but only one key can be enabled at any one time.

In order to configure and enable WEP encryption; click **Network > Wireless LAN** to display the **General** screen. Select **Static WEP** from the **Security Mode** list.

Figure 52 Network > Wireless LAN > General: Static WEP

The screenshot shows the 'Security' configuration page for 'Static WEP'. 'Security Mode' is set to 'Static WEP'. Below it, 'WEP Encryption' is set to '64-bit WEP' and 'Authentication Method' is set to 'Open System'. A note states: 'Note: 64-bit WEP: Enter 5 ASCII characters or 10 hexadecimal characters ("0-9", "A-F") for each Key (1-4). 128-bit WEP: Enter 13 ASCII characters or 26 hexadecimal characters ("0-9", "A-F") for each Key (1-4). (Select one WEP key as an active key to encrypt wireless data transmission.)'. There are radio buttons for 'ASCII' (selected) and 'Hex'. Below this, there are four rows for 'Key 1', 'Key 2', 'Key 3', and 'Key 4', each with a radio button and a text input field. At the bottom, there is another note: 'Note: WPA-PSK and WPA2-PSK can be configured when WPS enabled'. At the very bottom, there are 'Apply' and 'Reset' buttons.

The following table describes the wireless LAN security labels in this screen.

Table 28 Network > Wireless LAN > General: Static WEP

LABEL	DESCRIPTION
Security Mode	Choose Static WEP from the drop-down list box.
WEP Encryption	Select 64-bit WEP or 128-bit WEP to enable data encryption.
Authentication Method	Select Auto , Open System or Shared Key from the drop-down list box. This field specifies whether the wireless clients have to provide the WEP key to login to the wireless client. Keep this setting at Auto or Open System unless you want to force a key verification before communication between the wireless client and the ZyXEL Device occurs. Select Shared Key to force the clients to provide the WEP key prior to communication.
ASCII	Select this option in order to enter ASCII characters as WEP key.
Hex	Select this option in order to enter hexadecimal characters as a WEP key. The preceding "0x", that identifies a hexadecimal key, is entered automatically.
Key 1 to Key 4	The WEP keys are used to encrypt data. Both the NBG-418N and the wireless stations must use the same WEP key for data transmission. If you chose 64-bit WEP , then enter any 5 ASCII characters or 10 hexadecimal characters ("0-9", "A-F"). If you chose 128-bit WEP , then enter 13 ASCII characters or 26 hexadecimal characters ("0-9", "A-F"). You must configure at least one key, only one key can be activated at any one time. The default key is key 1.
Apply	Click Apply to save your changes back to the NBG-418N.
Reset	Click Reset to reload the previous configuration for this screen.

6.4.3 WPA-PSK/WPA2-PSK

Click **Network > Wireless LAN** to display the **General** screen. Select **WPA-PSK** or **WPA2-PSK** from the **Security Mode** list.

Figure 53 Network > Wireless LAN > General: WPA-PSK/WPA2-PSK

The screenshot shows the 'Security' configuration page. The 'Security Mode' is set to 'WPA2-PSK'. There is an unchecked checkbox for 'WPA Compatible'. The 'Cipher Type' is set to 'TKIP'. The 'Pre-Shared Key' field contains the text 'ThisismyWPA-PSKpre-sharedkey'. The 'Group Key Update Timer' is set to '86400 (In Seconds)'. There are two radio buttons: 'ASCII' (selected) and 'Hex'. A note with a yellow icon says 'Note: WPA-PSK and WPA2-PSK can be configured when WPS enabled'. At the bottom, there are 'Apply' and 'Reset' buttons.

The following table describes the labels in this screen.

Table 29 Network > Wireless LAN > General: WPA-PSK/WPA2-PSK

LABEL	DESCRIPTION
Security Mode	Choose WPA-PSK or WPA2-PSK from the drop-down list box.
WPA Compatible	This option is available only when you select WPA2-PSK in the Security Mode field. Select this option to have both WPA2 and WPA wireless clients be able to communicate with the NBG-418N even when the NBG-418N is using WPA2-PSK.
Cipher Type	Select the encryption type (TKIP , AES or TKIP+AES) for data encryption. Select AES if your wireless clients can all use AES. Otherwise, select TKIP or select TKIP+AES to allow the wireless clients to use either TKIP or AES.
Pre-Shared Key	WPA-PSK/WPA2-PSK uses a simple common password for authentication. Type a pre-shared key from 8 to 63 case-sensitive ASCII characters (including spaces and symbols). Type a pre-shared key less than 64 case-sensitive HEX characters ("0-9", "A-F").
Group Key Update Timer	The Group Key Update Timer is the rate at which the AP (if using WPA-PSK/WPA2-PSK key management) or RADIUS server (if using WPA/WPA2 key management) sends a new group key out to all clients. The re-keying process is the WPA/WPA2 equivalent of automatically changing the WEP key for an AP and all stations in a WLAN on a periodic basis. Setting of the Group Key Update Timer is also supported in WPA-PSK/WPA2-PSK mode.
Apply	Click Apply to save your changes back to the NBG-418N.
Reset	Click Reset to reload the previous configuration for this screen.

6.5 MAC Filter

The MAC filter screen allows you to configure the NBG-418N to give exclusive access to up to 16 devices (Allow) or exclude up to 16 devices from accessing the NBG-418N (Deny). Every Ethernet device has a unique MAC (Media Access Control) address. The MAC address is assigned at the factory and consists of six pairs of hexadecimal characters, for example, 00:A0:C5:00:00:02. You need to know the MAC address of the devices to configure this screen.

To change your NBG-418N's MAC filter settings, click **Network > Wireless LAN > MAC Filter**. The screen appears as shown.

Figure 54 Network > Wireless LAN > MAC Filter

The following table describes the labels in this menu.

Table 30 Network > Wireless LAN > MAC Filter

LABEL	DESCRIPTION
Active	Select Yes from the drop down list box to enable MAC address filtering.
Filter Action	Define the filter action for the list of MAC addresses in the MAC Address table. Select Deny to block access to the NBG-418N, MAC addresses not listed will be allowed to access the NBG-418N. Select Allow to permit access to the NBG-418N, MAC addresses not listed will be denied access to the NBG-418N.
Set	This is the index number of the MAC address.
MAC Address	Enter the MAC addresses of the wireless station that are allowed or denied access to the NBG-418N in these address fields. Enter the MAC addresses in a valid MAC address format, that is, six hexadecimal character pairs, for example, 12:34:56:78:9a:bc.
Apply	Click Apply to save your changes back to the NBG-418N.
Reset	Click Reset to reload the previous configuration for this screen.

6.6 Wireless LAN Advanced Screen

Use this screen to allow intra-BSS networking and set the RTS/CTS Threshold.

Click **Network > Wireless LAN > Advanced**. The screen appears as shown.

Figure 55 Network > Wireless LAN > Advanced (Universal Repeater Mode)

The screenshot shows the 'WLAN Advanced Setup' configuration page. The 'Advanced' tab is active. The settings are as follows:

- 802.11 Mode: 802.11 b/g/n
- RTS/CTS Threshold: 2347 (range 0 ~ 2347)
- Fragment Threshold: 2346 (range 256 ~ 2346)
- Beacon Interval: 100 (range 20 ~ 1024 ms)
- DTIM Period: 1 (range 1 ~ 10)
- Preamble Type: Long Preamble Short Preamble
- CTS Protection: Auto None
- Tx Power: 100%
- Extension Channel (40Mhz only): None
- Aggregation: Enable Disable
- Short GI: Enable Disable
- Enable Intra-BSS Traffic: Enable Disable
- WLAN STA setting overwrites WLAN AP setting: Enable Disable

Buttons: Apply, Reset

The following table describes the labels in this screen.

Table 31 Network > Wireless LAN > Advanced

LABEL	DESCRIPTION
Wireless Advanced Setup	
RTS/CTS Threshold	Data with its frame size larger than this value will perform the RTS (Request To Send)/CTS (Clear To Send) handshake. Enter a value between 0 and 2347 .
Fragmentation Threshold	The threshold (number of bytes) for the fragmentation boundary for directed messages. It is the maximum data fragment size that can be sent. Enter an even number between 256 and 2346 .
Beacon Interval	When a wirelessly networked device sends a beacon, it includes with it a beacon interval. This specifies the time period before the device sends the beacon again. The interval tells receiving devices on the network how long they can wait in low-power mode before waking up to handle the beacon. This value can be set from 20 to 1024 ms. A high value helps save current consumption of the access point.
DTIM Period	Delivery Traffic Indication Message (DTIM) is the time period after which broadcast and multicast packets are transmitted to mobile clients in the Active Power Management mode. A high DTIM value can cause clients to lose connectivity with the network. This value can be set from 1 to 10 .
Preamble Type	A preamble affects the timing in your wireless network. There are two preamble modes: long and short. If a device uses a different preamble mode than the NBG-418N does, it cannot communicate with the NBG-418N.
CTS Protection	When set to None , the NBG-418N protects wireless communication against interference. Select Auto to let the NBG-418N determine whether to turn this feature on or off in the current environment.
Tx Power	This field controls the transmission power of the NBG-418N. When using the NBG-418N with a notebook computer, select a lower transmission power level when you are close to the AP in order to conserve battery power.

Table 31 Network > Wireless LAN > Advanced (continued)

LABEL	DESCRIPTION
Extension Channel	If you select 40 MHz or Auto 20/40MHz as your Channel Bandwidth in the Wireless LAN > General screen, the extension channel enables the NBG-419N to get higher data throughput. This also lowers radio interference and traffic.
Aggregation	Message Protocol Data Unit (MPDU) aggregation collects Ethernet frames along with their 802.11n headers and wraps them in a 802.11n MAC header. This method is useful for increasing bandwidth throughput in environments that are prone to high error rates. Mac Service Data Unit (MSDU) aggregation collects Ethernet frames without any of their 802.11n headers and wraps the header-less payload in a single 802.11n MAC header. This method is useful for increasing bandwidth throughput. It is also more efficient than A-MPDU except in environments that are prone to high error rates.
Short GI	Select Enable to use Short GI (Guard Interval). The guard interval is the gap introduced between data transmission from users in order to reduce interference. Reducing the GI increases data transfer rates but also increases interference. Increasing the GI reduces data transfer rates but also reduces interference.
Enable Intra-BSS Traffic	A Basic Service Set (BSS) exists when all communications between wireless clients or between a wireless client and a wired network client go through one access point (AP). Intra-BSS traffic is traffic between wireless clients in the BSS. When Intra-BSS is enabled, wireless client A and B can access the wired network and communicate with each other. When Intra-BSS is disabled, wireless client A and B can still access the wired network but cannot communicate with each other.
WLAN STA setting overwrites WLAN AP setting	This field is available only when the NBG-418N is in universal repeater mode. Select Enabled to have the NBG-418N copy the SSID and wireless security settings of the associated AP, and use them for wireless connections between the NBG-418N and its wireless clients. Otherwise, select Disabled to configure different wireless and security settings for wireless connections between the NBG-418N and its wireless clients.
Apply	Click Apply to save your changes to the NBG-418N.
Reset	Click Reset to reload the previous configuration for this screen.

6.7 Quality of Service (QoS) Screen

Use the **QoS** screen to enable Wifi MultiMedia Quality of Service (WMMQoS). This allows the NBG-418N to automatically set priority levels to services, such as e-mail, VoIP, chat, and so on.

Click **Network > Wireless LAN > QoS**. The following screen appears.

Figure 56 Network > Wireless LAN > QoS

The following table describes the labels in this screen.

Table 32 Network > Wireless LAN > QoS

LABEL	DESCRIPTION
Enable WMM QoS	Check this to have the NBG-418N automatically give a service a priority level according to the ToS value in the IP header of packets it sends. WMM QoS (Wifi MultiMedia Quality of Service) gives high priority to voice and video, which makes them run more smoothly.
Apply	Click Apply to save your changes to the NBG-418N.
Reset	Click Reset to reload the previous configuration for this screen.

6.8 WPS Screen

Use this screen to enable/disable WPS, view or generate a new PIN number and check current WPS status. To open this screen, click **Network > Wireless LAN > WPS** tab.

Figure 57 Network > Wireless LAN > WPS

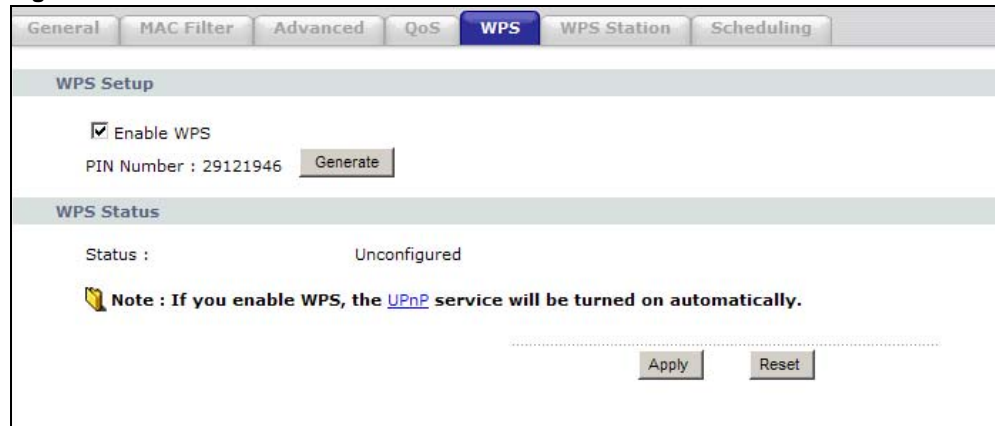

The following table describes the labels in this screen.

Table 33 Network > Wireless LAN > WPS

LABEL	DESCRIPTION
WPS Setup	
Enable WPS	Select this to enable the WPS feature.
PIN Number	This displays a PIN number last time system generated. Click Generate to generate a new PIN number.
WPS Status	
Status	This displays Configured when the NBG-418N has connected to a wireless network using WPS or when Enable WPS is selected and wireless or wireless security settings have been changed. The current wireless and wireless security settings also appear in the screen. This displays Unconfigured if WPS is disabled and there are no wireless or wireless security changes on the NBG-418N or you click Release_Configuration to remove the configured wireless and wireless security settings.

Table 33 Network > Wireless LAN > WPS (continued)

LABEL	DESCRIPTION
Release Configuration	This button is only available when the WPS status displays Configured . Click this button to remove all configured wireless and wireless security settings for WPS connections on the NBG-418N.
Apply	Click Apply to save your changes back to the NBG-418N.
Refresh	Click Refresh to get this screen information afresh.

6.9 WPS Station Screen

Use this screen when you want to add a wireless station using WPS. To open this screen, click **Network > Wireless LAN > WPS Station** tab.

Note: Note: After you click **Push Button** on this screen, you have to press a similar button in the wireless station utility within 2 minutes. To add the second wireless station, you have to press these buttons on both device and the wireless station again after the first 2 minutes.

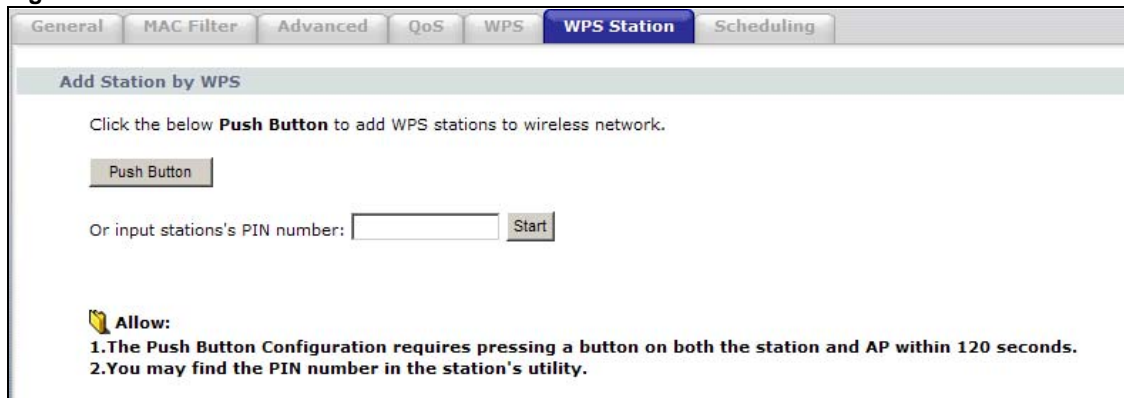
Figure 58 Network > Wireless LAN > WPS Station

The following table describes the labels in this screen.

Table 34 Network > Wireless LAN > WPS Station

LABEL	DESCRIPTION
Push Button	Use this button when you use the PBC (Push Button Configuration) method to configure wireless stations's wireless settings. See Section 5.2.1.1 on page 58 . Click this to start WPS-aware wireless station scanning and the wireless security information synchronization.
Or input station's PIN number	Use this button when you use the PIN Configuration method to configure wireless station's wireless settings. See Section 5.2.1.2 on page 59 . Type the same PIN number generated in the wireless station's utility. Then click Start to associate to each other and perform the wireless security information synchronization.

6.10 Scheduling Screen

Use this screen to set the times your wireless LAN is turned on and off. Wireless LAN scheduling is disabled by default. The wireless LAN can be scheduled to turn on or off on certain days and at certain times. To open this screen, click **Network > Wireless LAN > Scheduling** tab.

Figure 59 Network > Wireless LAN > Scheduling

Action	Day	Except for the following times			
<input checked="" type="radio"/> On <input type="radio"/> Off	<input type="checkbox"/> Everyday	00 (hour)	00 (min)	~	00 (hour) 00 (min)
<input checked="" type="radio"/> On <input type="radio"/> Off	<input type="checkbox"/> Monday	00 (hour)	00 (min)	~	00 (hour) 00 (min)
<input checked="" type="radio"/> On <input type="radio"/> Off	<input type="checkbox"/> Tuesday	00 (hour)	00 (min)	~	00 (hour) 00 (min)
<input checked="" type="radio"/> On <input type="radio"/> Off	<input type="checkbox"/> Wednesday	00 (hour)	00 (min)	~	00 (hour) 00 (min)
<input checked="" type="radio"/> On <input type="radio"/> Off	<input type="checkbox"/> Thursday	00 (hour)	00 (min)	~	00 (hour) 00 (min)
<input checked="" type="radio"/> On <input type="radio"/> Off	<input type="checkbox"/> Friday	00 (hour)	00 (min)	~	00 (hour) 00 (min)
<input checked="" type="radio"/> On <input type="radio"/> Off	<input type="checkbox"/> Saturday	00 (hour)	00 (min)	~	00 (hour) 00 (min)
<input checked="" type="radio"/> On <input type="radio"/> Off	<input type="checkbox"/> Sunday	00 (hour)	00 (min)	~	00 (hour) 00 (min)

The following table describes the labels in this screen.

Table 35 Network > Wireless LAN > Scheduling

LABEL	DESCRIPTION
Enable Wireless LAN Scheduling	Select this to enable Wireless LAN scheduling.
Action	Select On or Off to specify whether the Wireless LAN is turned on or off. This field works in conjunction with the Day and Except for the following times fields.
Day	Select Everyday or the specific days to turn the Wireless LAN on or off. If you select Everyday you can not select any specific days. This field works in conjunction with the Except for the following times field.
Except for the following times	Select a begin time using the first set of hour and minute (min) drop down boxes and select an end time using the second set of hour and minute (min) drop down boxes. If you have chosen On earlier for the WLAN Status the Wireless LAN will turn off between the two times you enter in these fields. If you have chosen Off earlier for the WLAN Status the Wireless LAN will turn on between the two times you enter in these fields. Note: Entering the same begin time and end time will mean the whole day.
Apply	Click Apply to save your changes back to the NBG-418N.
Reset	Click Reset to reload the previous configuration for this screen.

6.11 AP Select Screen

Use this screen to choose an access point that you want the NBG-418N (in universal repeater or client bridge mode) to connect to. You should know the security settings of the target AP.

To open this screen, click **Network > Wireless LAN > AP Select** tab.

Figure 60 Network > Wireless LAN > AP Select

	Select	SSID	BSSID	Channel	Mode	Security Mode	Strength
1	<input type="radio"/>	ZyXEL_MIS_WPA	50:67:F0:37:A0:85	11	bgn	WPAWPA211X	97%
2	<input type="radio"/>	5200-TUN24G-OUT-WPA2	42:4A:03:79:ED:A3	11	bgn	WPA211X	94%
3	<input type="radio"/>	ZyXEL_ESBU_MAC_AUTH	72:67:F0:37:A0:85	11	bgn	OPEN	91%
4	<input type="radio"/>	ZyXEL_GUEST	62:67:F0:37:A0:85	11	bg	WEP	91%
5	<input type="radio"/>	5200-TUN24G-OUT-OPEN	72:4A:03:79:ED:A3	11	bgn	OPEN	91%
6	<input type="radio"/>	5200-TUN24G-IN-PSK	62:4A:03:79:ED:A3	11	bgn	WPA2-PSK	91%
7	<input type="radio"/>	5200-LOC24G-WPA2	02:4A:03:79:ED:A3	11	bgn	WPA211X	91%
8	<input type="radio"/>	ZyXEL_MIS_WPA_PSK	02:67:F0:37:A0:7C	6	bgn	WPA2-PSK	91%
9	<input type="radio"/>	ZyXEL_MIS_WPA	50:67:F0:37:A0:7C	6	bgn	WPAWPA211X	91%
10	<input type="radio"/>	ZyXEL_MIS_WPA_PSK	02:67:F0:37:A0:85	11	bgn	WPA2-PSK	91%
11	<input type="radio"/>	ZyXEL_GUEST	62:67:F0:37:A0:7C	6	bg	WEP	91%
12	<input type="radio"/>	TUL24G_OUT_MAC_AUTH	52:4A:03:79:ED:A3	11	bgn	OPEN	91%
13	<input type="radio"/>	ZyXEL_MIS	52:67:F0:37:A0:85	11	bg	WEP	91%
14	<input type="radio"/>	ZyXEL_ESBU_MAC_AUTH	72:67:F0:37:A0:7C	6	bgn	OPEN	88%
15	<input type="radio"/>	5200-TUN24G-IN-WPA2	40:4A:03:79:ED:A3	11	bgn	WPA211X	88%

The following table describes the labels in this screen.

Table 36 Network > Wireless LAN > AP Select

LABEL	DESCRIPTION
Select	Use the radio button to select the wireless device to which you want to connect.
SSID	This displays the Service Set IDentity of the wireless device. The SSID is a unique name that identifies a wireless network. All devices in a wireless network must use the same SSID.
BSSID	This displays the MAC address of the wireless device.
Channel	This displays the channel number used by this wireless device.
Mode	This displays which IEEE 802.11b/g/n wireless networking standards the wireless device supports.
Security Mode	This displays the type of security configured on the wireless device. OPEN means no security is configured and you can connect to it without a password.
Strength	This displays the strength of the wireless signal. The signal strength mainly depends on the antenna output power and the distance between your NBG-418N and this device.

Table 36 Network > Wireless LAN > AP Select (continued)

LABEL	DESCRIPTION
Refresh	Click this button to search for available wireless devices within transmission range and update this table.
Connect	Click this button to associate to the selected wireless device.

6.12 WLAN Info Screen

Use this screen to view the SSID and security of the selected AP wireless network when the NBG-418N is in client bridge mode. To open this screen, click **Network > Wireless LAN > WLAN Info** tab.

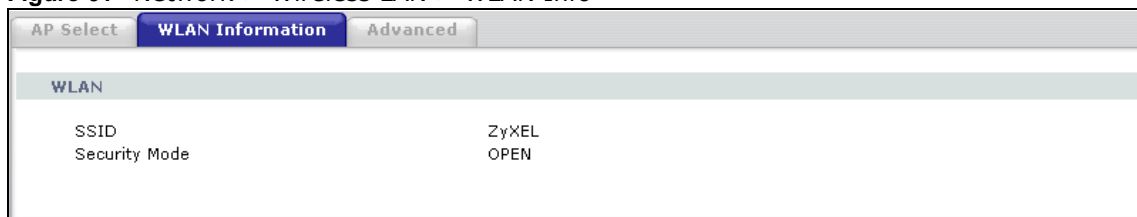
Figure 61 Network > Wireless LAN > WLAN Info

The following table describes the labels in this screen.

Table 37 Network > Wireless LAN > WLAN Info

LABEL	DESCRIPTION
WLAN	
SSID	This displays the Service Set IDentity of the selected wireless device.
Security Mode	This displays the type of security configured on the selected wireless device.

7.1 Overview

This chapter discusses the NBG-418N's **WAN** screens. Use these screens to configure your NBG-418N for Internet access.

A WAN (Wide Area Network) connection is an outside connection to another network or the Internet. It connects your private networks (such as a LAN (Local Area Network) and other networks, so that a computer in one location can communicate with computers in other locations.

Figure 62 LAN and WAN

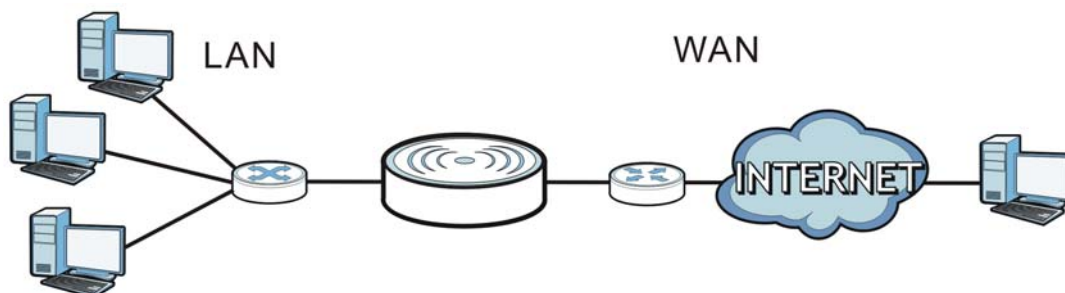

See the chapter about the connection wizard for more information on the fields in the WAN screens.

7.2 What You Need To Know

The information in this section can help you configure the screens for your WAN connection, as well as enable/disable some advanced features of your NBG-418N.

7.2.1 Configuring Your Internet Connection

Encapsulation Method

Encapsulation is used to include data from an upper layer protocol into a lower layer protocol. To set up a WAN connection to the Internet, you need to use the same encapsulation method used by your ISP (Internet Service Provider). If your ISP offers a dial-up Internet connection using PPPoE (PPP over Ethernet) or PPTP (Point-to-Point Tunneling Protocol), they should also provide a username and password (and service name) for user authentication.

WAN IP Address

The WAN IP address is an IP address for the NBG-418N, which makes it accessible from an outside network. It is used by the NBG-418N to communicate with other devices in other networks. It can be static (fixed) or dynamically assigned by the ISP each time the NBG-418N tries to access the Internet.

If your ISP assigns you a static WAN IP address, they should also assign you the subnet mask and DNS server IP address(es) (and a gateway IP address if you use the Ethernet or ENET ENCAP encapsulation method).

DNS Server Address Assignment

Use Domain Name System (DNS) to map a domain name to its corresponding IP address and vice versa, for instance, the IP address of www.zyxel.com is 204.217.0.2. The DNS server is extremely important because without it, you must know the IP address of a computer before you can access it.

The NBG-418N can get the DNS server addresses in the following ways.

- 1 The ISP tells you the DNS server addresses, usually in the form of an information sheet, when you sign up. If your ISP gives you DNS server addresses, manually enter them in the DNS server fields.
- 2 If your ISP dynamically assigns the DNS server IP addresses (along with the NBG-418N's WAN IP address), set the DNS server fields to get the DNS server address from the ISP.

WAN MAC Address

The MAC address screen allows users to configure the WAN port's MAC address by either using the factory default or cloning the MAC address from a computer on your LAN. Choose **Factory Default** to select the factory assigned default MAC Address.

Otherwise, click **Clone the computer's MAC address - IP Address** and enter the IP address of the computer on the LAN whose MAC you are cloning. Once it is successfully configured, the address will be copied to configuration file. It is recommended that you clone the MAC address prior to hooking up the WAN Port.

7.3 Internet Connection

Use this screen to change your NBG-418N's Internet access settings. Click **Network > WAN**. The screen differs according to the encapsulation you choose.

7.3.1 Ethernet Encapsulation

This screen displays when you select **Ethernet** encapsulation.

Figure 63 Network > WAN > Internet Connection: Ethernet Encapsulation

Internet Connection

ISP Parameters for Internet Access

Connection Type: Ethernet

WAN IP Address Assignment

Get automatically from ISP
 Use fixed IP Address
 IP Address: 0.0.0.0
 IP Subnet Mask: 255.255.255.0
 Gateway IP Address: 0.0.0.0
 MTU Auto: Manual
 MTU: 1500 (576-1500)

DNS Servers

First DNS Server: From ISP
 Second DNS Server:

WAN MAC Address

Factory default
 Clone the computer's MAC address - MAC Address 00:19:CB:32:BE:AC
 Set WAN MAC Address: 00:00:00:00:00:00

Apply Reset

The following table describes the labels in this screen.

Table 38 Network > WAN > Internet Connection: Ethernet Encapsulation

LABEL	DESCRIPTION
ISP Parameters for Internet Access	
Connection Type	You must choose the Ethernet option when the WAN port is used as a regular Ethernet.
WAN IP Address Assignment	
Get automatically from ISP	Select this option If your ISP did not assign you a fixed IP address. This is the default selection.
Use fixed IP Address	Select this option If the ISP assigned a fixed IP address.
IP Address	Enter your WAN IP address in this field if you selected Use Fixed IP Address .
IP Subnet Mask	Enter the IP Subnet Mask in this field.
Gateway IP Address	Enter a Gateway IP Address (if your ISP gave you one) in this field.
MTU Auto	Select Auto if you want to have the Maximum Transmission Unit (MTU) automatically configured. Select Manual if you want to enter the MTU manually in the field below.
MTU	Enter the MTU or the largest packet size per frame that your NBG-418N can receive and process.
DNS Servers	

Table 38 Network > WAN > Internet Connection: Ethernet Encapsulation (continued)

LABEL	DESCRIPTION
First DNS Server Second DNS Server	Select From ISP if your ISP dynamically assigns DNS server information (and the NBG-418N's WAN IP address). The field to the right displays the (read-only) DNS server IP address that the ISP assigns. Select User-Defined if you have the IP address of a DNS server. Enter the primary and secondary DNS server's IP address in the fields to the right.
WAN MAC Address	The MAC address section allows users to configure the WAN port's MAC address by either using the NBG-418N's MAC address, copying the MAC address from a computer on your LAN or manually entering a MAC address.
Factory default	Select Factory default to use the factory assigned default MAC Address.
Clone the computer's MAC address - MAC Address	Select this option to clone the MAC address of the computer (displaying in the screen) from which you are configuring the NBG-418N. Once it is successfully configured, the address will be copied to the rom file. It will not change unless you change the setting or upload a different ROM file.
Set WAN MAC Address	Select this option and enter the MAC address you want to use.
Apply	Click Apply to save your changes back to the NBG-418N.
Reset	Click Reset to begin configuring this screen afresh.

7.3.2 PPPoE Encapsulation

The NBG-418N supports PPPoE (Point-to-Point Protocol over Ethernet). PPPoE is an IETF standard (RFC 2516) specifying how a personal computer (PC) interacts with a broadband modem (DSL, cable, wireless, etc.) connection. The **PPP over Ethernet** option is for a dial-up connection using PPPoE.

For the service provider, PPPoE offers an access and authentication method that works with existing access control systems (for example Radius).

One of the benefits of PPPoE is the ability to let you access one of multiple network services, a function known as dynamic service selection. This enables the service provider to easily create and offer new IP services for individuals.

Operationally, PPPoE saves significant effort for both you and the ISP or carrier, as it requires no specific configuration of the broadband modem at the customer site.

By implementing PPPoE directly on the NBG-418N (rather than individual computers), the computers on the LAN do not need PPPoE software installed, since the NBG-418N does that part of the task. Furthermore, with NAT, all of the LANs' computers will have access.

This screen displays when you select **PPPoE** encapsulation.

Figure 64 Network > WAN > Internet Connection: PPPoE Encapsulation

Internet Connection

ISP Parameters for Internet Access

Connection Type: PPP over Ethernet (dropdown)

Service Name: (optional)

User Name:

Password:

Retype to Confirm:

MTU Size: 1492 (512 <= MTU Value <= 1492)

Nailed-Up Connection

Idle Timeout: 5 (in minutes)

DNS Servers

First DNS Server: From ISP (dropdown)

Second DNS Server:

WAN MAC Address

Factory default

Clone the computer's MAC address - MAC Address 00:19:CB:32:BE:AC

Set WAN MAC Address: 00:00:00:00:00:00

Apply Reset

The following table describes the labels in this screen.

Table 39 Network > WAN > Internet Connection: PPPoE Encapsulation

LABEL	DESCRIPTION
ISP Parameters for Internet Access	
Connection Type	Select PPP over Ethernet if you connect to your Internet via dial-up.
Service Name	Type the PPPoE service name provided to you. PPPoE uses a service name to identify and reach the PPPoE server.
User Name	Type the user name given to you by your ISP.
Password	Type the password associated with the user name above.
Retype to Confirm	Type your password again to make sure that you have entered is correctly.
MTU Size	Enter the MTU or the largest packet size per frame that your NBG-418N can receive and process.
Nailed-Up Connection	Select Nailed-Up Connection if you do not want the connection to time out.
Idle Timeout	This value specifies the time in minutes that elapses before the router automatically disconnects from the PPPoE server.
DNS Servers	

Table 39 Network > WAN > Internet Connection: PPPoE Encapsulation (continued)

LABEL	DESCRIPTION
First DNS Server Second DNS Server	If you do not configure a DNS server, you must know the IP address of a computer in order to access it. Select From ISP if your ISP dynamically assigns DNS server information (and the NBG-418N's WAN IP address). The field to the right displays the (read-only) DNS server IP address that the ISP assigns. Select User-Defined if you have the IP address of a DNS server. Enter the primary and secondary DNS server's IP address in the fields to the right.
WAN MAC Address	The MAC address section allows users to configure the WAN port's MAC address by using the NBG-418N's MAC address, copying the MAC address from a computer on your LAN or manually entering a MAC address.
Factory default	Select Factory default to use the factory assigned default MAC Address.
Clone the computer's MAC address - MAC Address	Select this option to clone the MAC address of the computer (displaying in the screen) from which you are configuring the NBG-418N. Once it is successfully configured, the address will be copied to the rom file. It will not change unless you change the setting or upload a different ROM file.
Set WAN MAC Address	Select this option and enter the MAC address you want to use.
Apply	Click Apply to save your changes back to the NBG-418N.
Reset	Click Reset to begin configuring this screen afresh.

7.3.3 PPTP Encapsulation

Point-to-Point Tunneling Protocol (PPTP) is a network protocol that enables secure transfer of data from a remote client to a private server, creating a Virtual Private Network (VPN) using TCP/IP-based networks.

PPTP supports on-demand, multi-protocol and virtual private networking over public networks, such as the Internet.

This screen displays when you select **PPTP** encapsulation.

Figure 65 Network > WAN > Internet Connection: PPTP Encapsulation

The following table describes the labels in this screen.

Table 40 Network > WAN > Internet Connection: PPTP Encapsulation

LABEL	DESCRIPTION
ISP Parameters for Internet Access	
Connection Type	Point-to-Point Tunneling Protocol (PPTP) is a network protocol that enables secure transfer of data from a remote client to a private server, creating a Virtual Private Network (VPN) using TCP/IP-based networks. PPTP supports on-demand, multi-protocol, and virtual private networking over public networks, such as the Internet. The NBG-418N supports only one PPTP server connection at any given time. To configure a PPTP client, you must configure the User Name and Password fields for a PPP connection and the PPTP parameters for a PPTP connection.
User Name	Type the user name given to you by your ISP.
Password	Type the password associated with the User Name above.
Retype to Confirm	Type your password again to make sure that you have entered correctly.
MTU Size	Enter the MTU or the largest packet size per frame that your NBG-418N can receive and process.

Table 40 Network > WAN > Internet Connection: PPTP Encapsulation (continued)

LABEL	DESCRIPTION
Nailed-up Connection	Select Nailed-Up Connection if you do not want the connection to time out.
Idle Timeout	This value specifies the time in minutes that elapses before the NBG-418N automatically disconnects from the PPTP server.
PPTP Configuration	
Server IP Address	Type the IP address of the PPTP server.
Get automatically from ISP	Select this option If your ISP did not assign you a fixed IP address. This is the default selection.
Use fixed IP Address	Select this option If the ISP assigned a fixed IP address.
My WAN IP Address	Enter your WAN IP address in this field if you selected Use Fixed IP Address .
My IP Subnet Mask	Your NBG-418N will automatically calculate the subnet mask based on the IP address that you assign. Unless you are implementing subnetting, use the subnet mask computed by the NBG-418N.
My IP Gateway	Enter a Gateway IP Address (if your ISP gave you one) in this field.
DNS Servers	
First DNS Server Second DNS Server	<p>If you do not configure a DNS server, you must know the IP address of a computer in order to access it.</p> <p>Select From ISP if your ISP dynamically assigns DNS server information (and the NBG-418N's WAN IP address). The field to the right displays the (read-only) DNS server IP address that the ISP assigns.</p> <p>Select User-Defined if you have the IP address of a DNS server. Enter the primary and secondary DNS server's IP address in the fields to the right.</p>
WAN MAC Address	The MAC address section allows users to configure the WAN port's MAC address by either using the NBG-418N's MAC address, copying the MAC address from a computer on your LAN or manually entering a MAC address.
Factory default	Select Factory default to use the factory assigned default MAC Address.
Clone the computer's MAC address - MAC Address	Select this option to clone the MAC address of the computer (displaying in the screen) from which you are configuring the NBG-418N. Once it is successfully configured, the address will be copied to the rom file. It will not change unless you change the setting or upload a different ROM file.
Set WAN MAC Address	Select this option and enter the MAC address you want to use.
Apply	Click Apply to save your changes back to the NBG-418N.
Reset	Click Reset to begin configuring this screen afresh.

8.1 Overview

This chapter describes how to configure LAN settings.

A Local Area Network (LAN) is a shared communication system to which many computers are attached. A LAN is a computer network limited to the immediate area, usually the same building or floor of a building. The LAN screens can help you configure a LAN DHCP server, manage IP addresses, and partition your physical network into logical networks.

Figure 66 LAN Setup

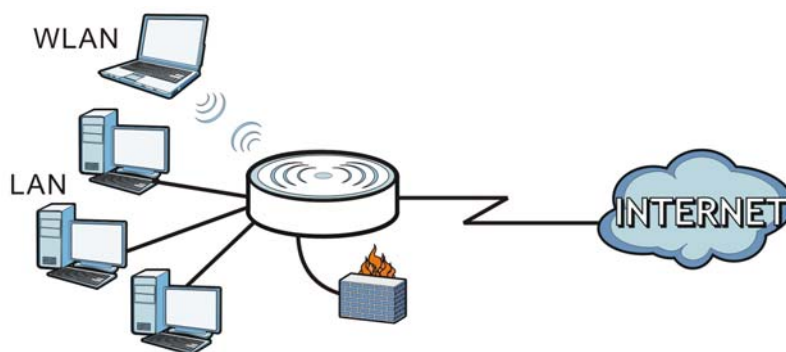

The LAN screens can help you configure a LAN DHCP server and manage IP addresses.

8.2 What You Need To Know

The actual physical connection determines whether the NBG-418N ports are LAN or WAN ports. There are two separate IP networks, one inside the LAN network and the other outside the WAN network as shown next.

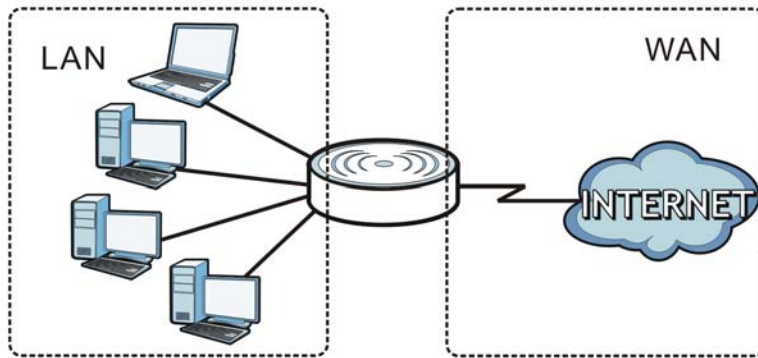
Figure 67 LAN and WAN IP Addresses

The LAN parameters of the NBG-418N are preset in the factory with the following values:

- IP address of 192.168.1.1 with subnet mask of 255.255.255.0 (24 bits)
- DHCP server enabled with 32 client IP addresses starting from 192.168.1.33.

These parameters should work for the majority of installations. If your ISP gives you explicit DNS server address(es), read the embedded Web Configurator help regarding what fields need to be configured.

8.2.1 IP Pool Setup

The NBG-418N is pre-configured with a pool of 32 IP addresses starting from 192.168.1.33 to 192.168.1.64. This configuration leaves 31 IP addresses (excluding the NBG-418N itself) in the lower range (192.168.1.2 to 192.168.1.32) for other server computers, for instance, servers for mail, FTP, TFTP, web, etc., that you may have.

Refer to [Section 3.4.6 on page 30](#) for information on IP Address and Subnet Mask.

8.2.2 LAN TCP/IP

The NBG-418N has built-in DHCP server capability that assigns IP addresses and DNS servers to systems that support DHCP client capability.

Refer to the [Section 3.4.7 on page 30](#) section for information on System DNS Servers.

8.3 LAN IP Screen

Use this screen to change your basic LAN settings. Click **Network** > **LAN**.

Figure 68 Network > LAN > IP

The screenshot shows a web-based configuration interface. At the top, there is a blue header with the text 'IP'. Below this is a light green sub-header 'LAN TCP/IP'. The main area contains two rows of configuration fields. The first row is 'IP Address' with a text box containing '192.168.1.1'. The second row is 'IP Subnet Mask' with a text box containing '255.255.255.0'. Below these fields, there is a horizontal line of dots, and then two buttons: 'Apply' and 'Reset'.

The following table describes the labels in this screen.

Table 41 Network > LAN > IP

LABEL	DESCRIPTION
IP Address	Type the IP address of your NBG-418N in dotted decimal notation 192.168.1.1 (factory default).
IP Subnet Mask	The subnet mask specifies the network number portion of an IP address. Your NBG-418N will automatically calculate the subnet mask based on the IP address that you assign. Unless you are implementing subnetting, use the subnet mask computed by the NBG-418N.
Apply	Click Apply to save your changes back to the NBG-418N.
Reset	Click Reset to begin configuring this screen afresh.

DHCP Server

9.1 Overview

DHCP (Dynamic Host Configuration Protocol, RFC 2131 and RFC 2132) allows individual clients to obtain TCP/IP configuration at start-up from a server. You can configure the NBG-418N's LAN as a DHCP server or disable it. When configured as a server, the NBG-418N provides the TCP/IP configuration for the clients. If DHCP service is disabled, you must have another DHCP server on your LAN, or else the computer must be manually configured.

9.2 What You Can Do

- Use the **General** screen to enable the DHCP server ([Section 9.4 on page 97](#)).
- Use the **Advanced** screen to assign IP addresses on the LAN to specific individual computers based on their MAC Addresses ([Section 9.5 on page 98](#)).
- Use the **Client List** screen to view the current DHCP client information ([Section 9.6 on page 100](#)).

9.3 What You Need To Know

Every Ethernet device has a unique MAC (Media Access Control) address. The MAC address is assigned at the factory and consists of six pairs of hexadecimal characters, for example, 00:A0:C5:00:00:02. Find out the MAC addresses of your network devices if you intend to add them to the DHCP Client List screen.

Refer to [Section 3.4.6 on page 30](#) for information on IP Address and Subnet Mask.

Refer to the [Section 3.4.7 on page 30](#) section for information on System DNS Servers.

9.4 General Screen

Use this screen to enable the DHCP server. Click **Network > DHCP Server**. The following screen displays.

Figure 69 Network > DHCP Server > General

The screenshot shows a web interface for configuring a DHCP server. At the top, there are three tabs: 'General' (selected), 'Advanced', and 'Client List'. Below the tabs is a section titled 'DHCP Setup'. Inside this section, there is a checkbox labeled 'Enable DHCP Server' which is checked. Below the checkbox are two input fields: 'IP Pool Starting Address' with the value '192.168.1.33' and 'Pool Size' with the value '32'. At the bottom of the section, there are two buttons: 'Apply' and 'Reset'.

The following table describes the labels in this screen.

Table 42 Network > DHCP Server > General

LABEL	DESCRIPTION
Enable DHCP Server	Enable or Disable DHCP for LAN. DHCP (Dynamic Host Configuration Protocol, RFC 2131 and RFC 2132) allows individual clients (computers) to obtain TCP/IP configuration at startup from a server. Leave the Enable DHCP Server check box selected unless your ISP instructs you to do otherwise. Clear it to disable the NBG-418N acting as a DHCP server. When configured as a server, the NBG-418N provides TCP/IP configuration for the clients. If not, DHCP service is disabled and you must have another DHCP server on your LAN, or else the computers must be manually configured. When set as a server, fill in the following four fields.
IP Pool Starting Address	This field specifies the first of the contiguous addresses in the IP address pool for LAN.
Pool Size	This field specifies the size, or count of the IP address pool for LAN.
Apply	Click Apply to save your changes back to the NBG-418N.
Reset	Click Reset to begin configuring this screen afresh.

9.5 Advanced Screen

This screen allows you to assign IP addresses on the LAN to specific individual computers based on their MAC addresses. You can also use this screen to configure the DNS server information that the NBG-418N sends to the DHCP clients.

To change your NBG-418N's static DHCP settings, click **Network > DHCP Server > Advanced**. The following screen displays.

Figure 70 Network > DHCP Server > Advanced

The following table describes the labels in this screen.

Table 43 Network > DHCP Server > Advanced

LABEL	DESCRIPTION
Static DHCP Table	
#	This is the index number of the static IP table entry (row).
MAC Address	Type the MAC address (with colons) of a computer on your LAN.
IP Address	Type the LAN IP address of a computer on your LAN.
DNS Server	
DNS Servers Assigned by DHCP Server	The NBG-418N passes a DNS (Domain Name System) server IP address (in the order you specify here) to the DHCP clients. If you do not configure the DNS server, the DHCP service is disabled and you must have another DHCP sever on your LAN, or else the computers must have their DNS server addresses manually configured.
First DNS Server Second DNS Server	<p>Select From ISP if your ISP dynamically assigns DNS server information (and the NBG-418N's WAN IP address). The field to the right displays the (read-only) DNS server IP address that the ISP assigns.</p> <p>Select User-Defined if you have the IP address of a DNS server. Enter the DNS server's IP address in the field to the right. If you chose User-Defined, but leave the IP address set to 0.0.0.0, User-Defined changes to None after you click Apply. If you set a second choice to User-Defined, and enter the same IP address, the second User-Defined changes to None after you click Apply.</p> <p>Select DNS Relay to have the NBG-418N act as a DNS proxy. The NBG-418N's LAN IP address displays in the field to the right (read-only). The NBG-418N tells the DHCP clients on the LAN that the NBG-418N itself is the DNS server. When a computer on the LAN sends a DNS query to the NBG-418N, the NBG-418N forwards the query to the NBG-418N's system DNS server (configured in the WAN > Internet Connection screen) and relays the response back to the computer. You can only select DNS Relay for one of the three servers; if you select DNS Relay for a second or third DNS server, that choice changes to None after you click Apply.</p>
Apply	Click Apply to save your changes back to the NBG-418N.
Reset	Click Reset to begin configuring this screen afresh.

9.6 Client List Screen

The DHCP table shows current DHCP client information (including **IP Address**, **Host Name** and **MAC Address**) of network clients using the NBG-418N's DHCP servers.

Configure this screen to always assign an IP address to a MAC address (and host name). Click **Network > DHCP Server > Client List**.

Note: You can also view a read-only client list by clicking the **DHCP Table (Details...)** hyperlink in the **Status** screen.

The following screen displays.

Figure 71 Network > DHCP Server > Client List

#	IP Address	Host Name	MAC Address	Reserve
1	192.168.1.33	TWPC13262-01	00:1C:C4:84:E0:4B	<input type="checkbox"/>

The following table describes the labels in this screen.

Table 44 Network > DHCP Server > Client List

LABEL	DESCRIPTION
#	This is the index number of the host computer.
IP Address	This field displays the IP address relative to the # field listed above.
Host Name	This field displays the computer host name.
MAC Address	The MAC (Media Access Control) or Ethernet address on a LAN (Local Area Network) is unique to your computer (six pairs of hexadecimal notation). A network interface card such as an Ethernet adapter has a hardwired address that is assigned at the factory. This address follows an industry standard that ensures no other adapter has a similar address.
Reserve	Select this check box in the DHCP Setup section to have the NBG-418N always assign the IP address(es) to the MAC address(es) (and host name(s)). After you click Apply , the MAC address and IP address also display in the Advanced screen (where you can edit them).
Apply	Click Apply to save your settings.
Refresh	Click Refresh to reload the DHCP table.

Network Address Translation

10.1 Overview

This chapter discusses how to configure NAT on the NBG-418N.

NAT (Network Address Translation - NAT, RFC 1631) is the translation of the IP address of a host in a packet. For example, the source address of an outgoing packet, used within one network is changed to a different IP address known within another network.

Each packet has two addresses – a source address and a destination address. For outgoing packets, NAT maps private (local) IP addresses to globally unique ones required for communication with hosts on other networks. It replaces the original IP source address in each packet and then forwards it to the Internet. The NBG-418N keeps track of the original addresses and port numbers so incoming reply packets can have their original values restored. The following figure illustrates this.

Figure 72 NAT Example

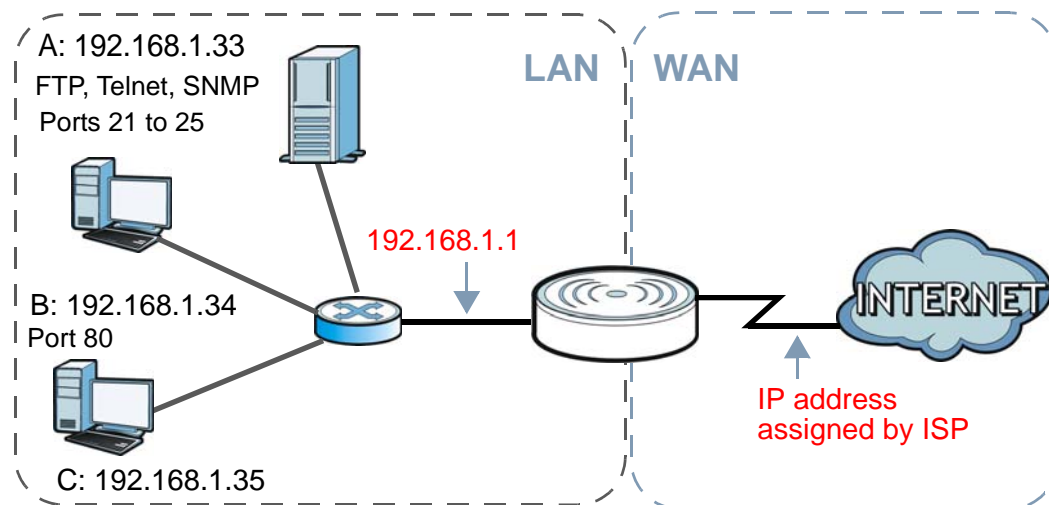

For more information on IP address translation, refer to *RFC 1631, The IP Network Address Translator (NAT)*.

Note: You must create a firewall rule in addition to setting up NAT, to allow traffic from the WAN to be forwarded through the NBG-418N.

10.2 What You Can Do

- Use the **General** screen to enable NAT and set a default server ([Section 10.3 on page 103](#)).
- Use the **Application** screen to change your NBG-418N's port forwarding settings ([Section 10.4 on page 104](#)).

10.2.1 What You Need To Know

The following terms and concepts may help as you read through this chapter.

Inside/Outside

This denotes where a host is located relative to the NBG-418N, for example, the computers of your subscribers are the inside hosts, while the web servers on the Internet are the outside hosts.

Global/Local

This denotes the IP address of a host in a packet as the packet traverses a router, for example, the local address refers to the IP address of a host when the packet is in the local network, while the global address refers to the IP address of the host when the same packet is traveling in the WAN side.

Note: Inside/outside refers to the location of a host, while global/local refers to the IP address of a host used in a packet.

An inside local address (ILA) is the IP address of an inside host in a packet when the packet is still in the local network, while an inside global address (IGA) is the IP address of the same inside host when the packet is on the WAN side. The following table summarizes this information.

Table 45 NAT Definitions

ITEM	DESCRIPTION
Inside	This refers to the host on the LAN.
Outside	This refers to the host on the WAN.
Local	This refers to the packet address (source or destination) as the packet travels on the LAN.
Global	This refers to the packet address (source or destination) as the packet travels on the WAN.

Note: NAT never changes the IP address (either local or global) of an outside host.

What NAT Does

In the simplest form, NAT changes the source IP address in a packet received from a subscriber (the inside local address) to another (the inside global address) before forwarding the packet to the WAN side. When the response comes back, NAT translates the destination address (the inside global address) back to the inside local address before forwarding it to the original inside host. Note that the IP address (either local or global) of an outside host is never changed.

The global IP addresses for the inside hosts can be either static or dynamically assigned by the ISP. In addition, you can designate servers, for example, a web server and a telnet server, on your local network and make them accessible to the outside world. If you do not define any servers, NAT offers the additional benefit of firewall protection. With no servers defined, your NBG-418N filters out all incoming inquiries, thus preventing intruders from probing your network. For more information on IP address translation, refer to *RFC 1631, The IP Network Address Translator (NAT)*.

How NAT Works

Each packet has two addresses – a source address and a destination address. For outgoing packets, the ILA (Inside Local Address) is the source address on the LAN, and the IGA (Inside Global Address) is the source address on the WAN. For incoming packets, the ILA is the destination address on the LAN, and the IGA is the destination address on the WAN. NAT maps private (local) IP addresses to globally unique ones required for communication with hosts on other networks. It replaces the original IP source address in each packet and then forwards it to the Internet. The NBG-418N keeps track of the original addresses and port numbers so incoming reply packets can have their original values restored. The following figure illustrates this.

Figure 73 How NAT Works

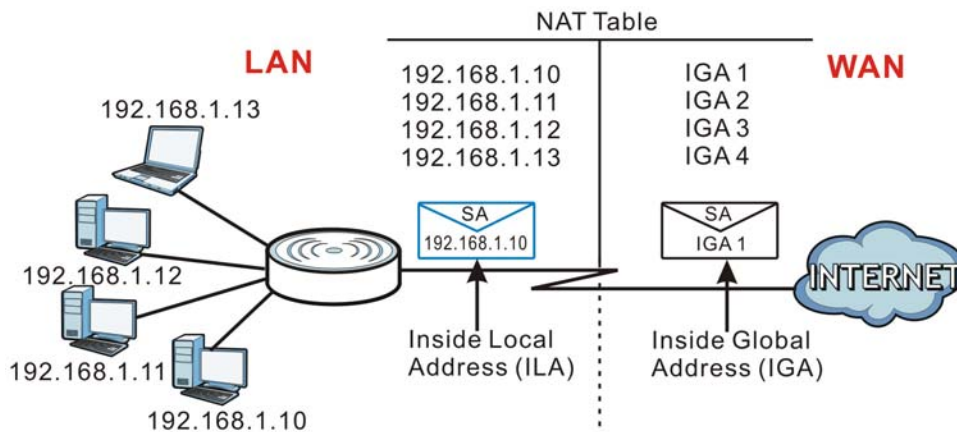

10.3 General NAT Screen

Use this screen to enable NAT and set a default server. Click **Network > NAT** to open the **General** screen.

Figure 74 Network > NAT > General

The following table describes the labels in this screen.

Table 46 Network > NAT > General

LABEL	DESCRIPTION
NAT Setup	
Enable Network Address Translation	Network Address Translation (NAT) allows the translation of an Internet protocol address used within one network (for example a private IP address used in a local network) to a different IP address known within another network (for example a public IP address used on the Internet). Select the check box to enable NAT.
Default Server Setup	
Server IP Address	In addition to the servers for specified services, NAT supports a default server. A default server receives packets from ports that are not specified in the Application screen. If you do not assign a Default Server IP address , the NBG-418N discards all packets received for ports that are not specified in the Application screen or remote management.
Apply	Click Apply to save your changes back to the NBG-418N.
Reset	Click Reset to begin configuring this screen afresh.

10.4 NAT Application Screen

Use the **Application** screen to forward incoming service requests to the server(s) on your local network. You may enter a single port number or a range of port numbers to be forwarded, and the local IP address of the desired server. The port number identifies a service; for example, web service is on port 80 and FTP on port 21. In some cases, such as for unknown services or where one server can support more than one service (for example both FTP and web service), it might be better to specify a range of port numbers.

In addition to the servers for specified services, NAT supports a default server. A service request that does not have a server explicitly designated for it is forwarded to the default server. If the default is not defined, the service request is simply discarded.

Note: Many residential broadband ISP accounts do not allow you to run any server processes (such as a Web or FTP server) from your location. Your ISP may periodically check for servers and may suspend your account if it discovers any active services at your location. If you are unsure, refer to your ISP.

Port forwarding allows you to define the local servers to which the incoming services will be forwarded. To change your NBG-418N's port forwarding settings, click **Network > NAT > Application**. The screen appears as shown.

Note: If you do not assign a **Default Server IP address** in the **NAT > General** screen, the NBG-418N discards all packets received for ports that are not specified in this screen or remote management.

Refer to [Appendix E on page 209](#) for port numbers commonly used for particular services.

Figure 75 Network > NAT > Application

The following table describes the labels in this screen.

Table 47 Network > NAT > Application

LABEL	DESCRIPTION
Add Application Rule	
Active	Select the check box to enable this rule and the requested service can be forwarded to the host with a specified internal IP address. Clear the checkbox to disallow forwarding of these ports to an inside server without having to delete the entry.
Service Name	Type a name (of up to 31 printable characters) to identify this rule in the first field next to Service Name . Otherwise, select a predefined service in the second field next to Service Name . The predefined service name and port number(s) will display in the Service Name and Port fields.
Local Port Range	Type a port number(s) to be forwarded.
Public Port Range	To specify a range of ports, enter a hyphen (-) between the first port and the last port, such as 10-20. To specify two or more non-consecutive port numbers, separate them by a comma without spaces, such as 123,567.
Protocol	Select the transport layer protocol supported by this server. Choices are TCP , UDP , or TCP&UDP .

Table 47 Network > NAT > Application (continued)

LABEL	DESCRIPTION
Server IP Address	Type the inside IP address of the server that receives packets from the port(s) specified in the Port field.
Apply	Click Apply to save your changes to the Application Rules Summary table.
Reset	Click Reset to not save and return your new changes in the Service Name and Port fields to the previous one.
Application Rules Summary	
#	This is the number of an individual port forwarding server entry.
Active	This icon is turned on when the rule is enabled.
Name	This field displays a name to identify this rule.
Local Start/End Port	This field displays the port number(s).
Public Start/End Port	
Protocol	This is the transport layer protocol used for the service.
Server IP Address	This field displays the inside IP address of the server.
Modify	Click the Edit icon to display and modify an existing rule setting in the fields under Add Application Rule . Click the Remove icon to delete a rule.

10.5 Technical Reference

The following section contains additional technical information about the NBG-418N features described in this chapter.

10.5.1 NAT Port Forwarding: Services and Port Numbers

A port forwarding set is a list of inside (behind NAT on the LAN) servers, for example, web or FTP, that you can make accessible to the outside world even though NAT makes your whole inside network appear as a single machine to the outside world.

Use the **Application** screen to forward incoming service requests to the server(s) on your local network. You may enter a single port number or a range of port numbers to be forwarded, and the local IP address of the desired server. The port number identifies a service; for example, web service is on port 80 and FTP on port 21. In some cases, such as for unknown services or where one server can support more than one service (for example both FTP and web service), it might be better to specify a range of port numbers.

In addition to the servers for specified services, NAT supports a default server. A service request that does not have a server explicitly designated for it is forwarded to the default server. If the default is not defined, the service request is simply discarded.

Note: Many residential broadband ISP accounts do not allow you to run any server processes (such as a Web or FTP server) from your location. Your ISP may periodically check for servers and may suspend your account if it discovers any active services at your location. If you are unsure, refer to your ISP.

10.5.2 NAT Port Forwarding Example

Let's say you want to assign ports 21-25 to one FTP, Telnet and SMTP server (**A** in the example), port 80 to another (**B** in the example) and assign a default server IP address of 192.168.1.35 to a third (**C** in the example). You assign the LAN IP addresses and the ISP assigns the WAN IP address. The NAT network appears as a single host on the Internet.

Figure 76 Multiple Servers Behind NAT Example

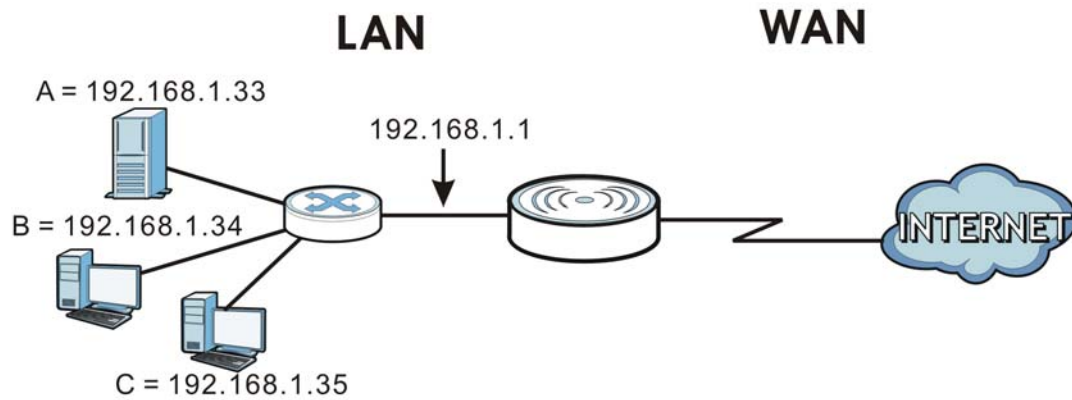

Dynamic DNS

11.1 Overview

Dynamic Domain Name Service (DDNS) services let you use a fixed domain name with a dynamic IP address. Users can always use the same domain name instead of a different dynamic IP address that changes each time to connect to the NBG-418N or a server in your network.

Note: The NBG-418N must have a public global IP address and you should have your registered DDNS account information on hand.

11.2 Dynamic DNS Screen

To configure your NBG-418N's DDNS, click **Network > DDNS**.

Figure 77 Network > DDNS

The following table describes the labels in this screen.

Table 48 Network > DDNS

LABEL	DESCRIPTION
Enable Dynamic DNS	Select this check box to use DDNS.
Service Provider	Select the name of your DDNS service provider.
Dynamic DNS Type	This field is only available if you use the DynDNS service provider. Select the type of service that you are registered for from your Dynamic DNS service provider.

Table 48 Network > DDNS

LABEL	DESCRIPTION
Host Name	The host name is the domain name that the DDNS service will map to your dynamic global IP address. Type the host name fully qualified, for example, 'yourhost.mydomain.net'. You can specify up to two host names in the field separated by a comma (",").
User Name	Type the user name that you used when you registered with the DDNS service.
Password	Type the password associated with the DDNS user name.
Timeout	This is the length of time in hours between updates to the DDNS service. If the update fails, the NBG-418N will disable DDNS.
Enable Wildcard Option	Select this if your DDNS service provider supports use of a wildcard (*) that will allow '*.yourhost.dyndns.org' (where * may be the name of a web, mail, FTP etc. server in your network) to be mapped to the same IP address as 'yourhost.dyndns.org'. This feature is useful when there are multiple servers in your network and you want users to be able to use different domain names to reach them.
Apply	Click Apply to save your changes back to the NBG-418N.
Reset	Click Reset to begin configuring this screen afresh.

12.1 Overview

Use these screens to enable and configure the firewall that protects your NBG-418N and your LAN from unwanted or malicious traffic.

Enable the firewall to protect your LAN computers from attacks by hackers on the Internet and control access between the LAN and WAN. By default the firewall:

- allows traffic that originates from your LAN computers to go to all of the networks.
- blocks traffic that originates on the other networks from going to the LAN.

The following figure illustrates the default firewall action. User **A** can initiate an IM (Instant Messaging) session from the LAN to the WAN (1). Return traffic for this session is also allowed (2). However other traffic initiated from the WAN is blocked (3 and 4).

Figure 78 Default Firewall Action

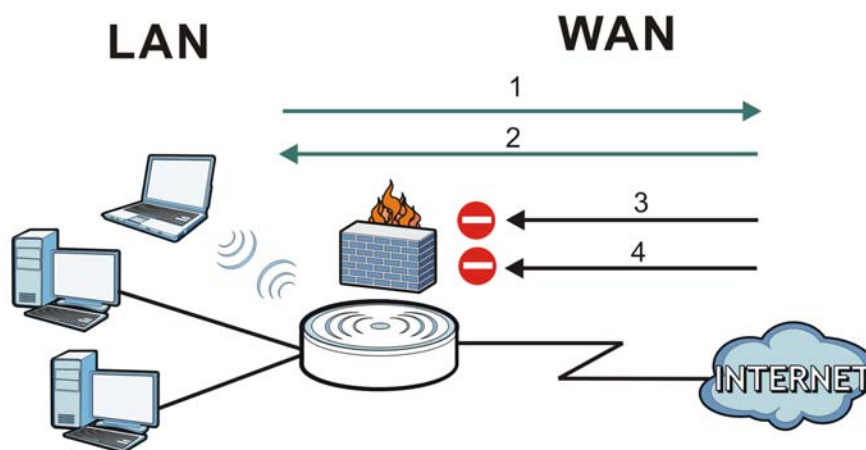

12.2 What You Can Do

- Use the **General** screen to enable or disable the NBG-418N's firewall ([Section 12.4 on page 112](#)).
- Use the **Services** screen to enable or disable ICMP and VPN passthrough features ([Section 12.5 on page 113](#)).

12.3 What You Need To Know

The NBG-418N's firewall feature physically separates the LAN and the WAN and acts as a secure gateway for all data passing between the networks.

12.3.1 About the NBG-418N Firewall

The NBG-418N firewall is a stateful inspection firewall and is designed to protect against Denial of Service attacks when activated (click the **General** tab under **Firewall** and then click the **Enable Firewall** check box). The NBG-418N's purpose is to allow a private Local Area Network (LAN) to be securely connected to the Internet. The NBG-418N can be used to prevent theft, destruction and modification of data, as well as log events, which may be important to the security of your network.

The NBG-418N is installed between the LAN and a broadband modem connecting to the Internet. This allows it to act as a secure gateway for all data passing between the Internet and the LAN.

The NBG-418N has one Ethernet WAN port and four Ethernet LAN ports, which are used to physically separate the network into two areas. The WAN (Wide Area Network) port attaches to the broadband (cable or DSL) modem to the Internet.

The LAN (Local Area Network) port attaches to a network of computers, which needs security from the outside world. These computers will have access to Internet services such as e-mail, FTP and the World Wide Web. However, "inbound access" is not allowed (by default) unless the remote host is authorized to use a specific service.

12.3.2 VPN Pass Through Features

A Virtual Private Network (VPN) is a way to securely connect two networks over the Internet. For example a home network and one in a business office. This requires special equipment on both ends of the connection.

The NBG-418N is not one of the endpoints but it does allow traffic from those endpoints to pass through. The NBG-418N allows the following types of VPN traffic to pass through:

- IP security (IPSec)
- Point-to-Point Tunneling Protocol (PPTP)

12.4 General Firewall Screen

Use this screen to enable or disable the NBG-418N's firewall, and set up firewall logs. Click **Security > Firewall** to open the **General** screen.

Figure 79 Security > Firewall > General

The following table describes the labels in this screen.

Table 49 Security > Firewall > General

LABEL	DESCRIPTION
Enable Firewall	Select this check box to activate the firewall. The NBG-418N performs access control and protects against Denial of Service (DoS) attacks when the firewall is activated.
Apply	Click Apply to save the settings.
Reset	Click Reset to start configuring this screen again.

12.5 Services Screen

Use the **Services** screen to enable or disable ICMP and VPN passthrough features.

Click **Security > Firewall > Services**. The screen appears as shown next.

Figure 80 Security > Firewall > Services

The following table describes the labels in this screen.

Table 50 Security > Firewall > Services

LABEL	DESCRIPTION
ICMP	Internet Control Message Protocol is a message control and error-reporting protocol between a host server and a gateway to the Internet. ICMP uses Internet Protocol (IP) datagrams, but the messages are processed by the TCP/IP software and directly apparent to the application user.
Respond to Ping on WAN	The NBG-418N will not respond to any incoming Ping requests when Disable is selected. Select Enable to reply to incoming WAN Ping requests.

Table 50 Security > Firewall > Services (continued)

LABEL	DESCRIPTION
VPN Passthrough	Select the checkbox to enable the advanced pass through features: <ul style="list-style-type: none">• PPTP Passthrough: Select this option to allow the NBG-418N to pass through VPN traffic using PPTP.• L2TP Passthrough: Select this option to enable computers on your LAN to make L2TP VPN connections to servers on the Internet.• IPSEC Passthrough: Select this option to allow the NBG-418N to pass through VPN traffic using the IPsec protocol.
Apply	Click Apply to save the settings.
Reset	Click Reset to start configuring this screen again.

Remote Management

13.1 Overview

This chapter provides information on the **Remote Management** screens.

Remote management allows you to determine which services/protocols can access which NBG-418N interface (if any) from which computers.

You may manage your NBG-418N from a remote location via:

- LAN only
- LAN and WAN

Note: When you configure remote management to allow management from the LAN and WAN in the options above, you still need to configure a firewall rule to allow access. See the firewall chapters for details on configuring firewall rules.

13.1.1 Remote Management Limitations

Remote management over LAN or WAN will not work when:

- 1 You have disabled that service in one of the remote management screens.
- 2 The IP address in the **Secured Client WAN IP Address** field does not match the client IP address. If it does not match, the NBG-418N will disconnect the session immediately.
- 3 There is already another remote management session with an equal or higher priority running. You may only have one remote management session running at one time.
- 4 There is a firewall rule that blocks it.

13.1.2 Remote Management and NAT

When NAT is enabled:

- Use the NBG-418N's WAN IP address when configuring from the WAN.
- Use the NBG-418N's LAN IP address when configuring from the LAN.

13.1.3 System Timeout

There is a default system management idle timeout of five minutes (three hundred seconds). The NBG-418N automatically logs you out if the management session remains idle for longer than this timeout period. The management session does not time out when a statistics screen is polling. You can change the timeout period in the **System** screen.

13.2 WWW Screen

To change your NBG-418N's World Wide Web settings, click **Management > Remote MGMT** to display the **WWW** screen.

Figure 81 Management > Remote MGMT > WWW

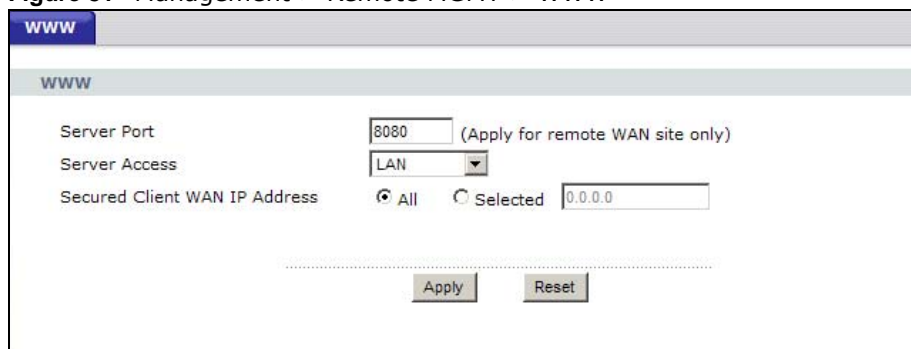

The screenshot shows the 'WWW' configuration screen. At the top, there is a blue header with the text 'WWW'. Below this, the main content area has a light gray header with 'WWW'. The configuration fields are as follows:

- Server Port:** A text input field containing '8080' with a note '(Apply for remote WAN site only)' to its right.
- Server Access:** A dropdown menu currently set to 'LAN'.
- Secured Client WAN IP Address:** A radio button labeled 'All' is selected, and a radio button labeled 'Selected' is unselected. To the right of the 'Selected' radio button is a text input field containing '0.0.0.0'.

At the bottom of the form, there are two buttons: 'Apply' and 'Reset'.

The following table describes the labels in this screen.

Table 51 Management > Remote MGMT > WWW

LABEL	DESCRIPTION
Server Port	You may change the server port number for a service if needed, however you must use the same port number in order to use that service for remote management.
Server Access	Select the interface(s) through which a computer may access the NBG-418N using this service.
Secured Client WAN IP Address	<p>A secured client is a "trusted" computer that is allowed to communicate with the NBG-418N using this service.</p> <p>Select All to allow any computer to access the NBG-418N using this service.</p> <p>Choose Selected to just allow the computer with the IP address that you specify to access the NBG-418N using this service.</p> <p>Note: This only applies on WAN IP.</p>
Apply	Click Apply to save your customized settings and exit this screen.
Reset	Click Reset to begin configuring this screen afresh.

Universal Plug-and-Play (UPnP)

14.1 Overview

This chapter introduces the UPnP feature in the Web Configurator.

Universal Plug and Play (UPnP) is a distributed, open networking standard that uses TCP/IP for simple peer-to-peer network connectivity between devices. A UPnP device can dynamically join a network, obtain an IP address, convey its capabilities and learn about other devices on the network. In turn, a device can leave a network smoothly and automatically when it is no longer in use.

14.2 What You Need to Know

How do I know if I'm using UPnP?

UPnP hardware is identified as an icon in the Network Connections folder (Windows XP). Each UPnP compatible device installed on your network will appear as a separate icon. Selecting the icon of a UPnP device will allow you to access the information and properties of that device.

NAT Traversal

UPnP NAT traversal automates the process of allowing an application to operate through NAT. UPnP network devices can automatically configure network addressing, announce their presence in the network to other UPnP devices and enable exchange of simple product and service descriptions. NAT traversal allows the following:

- Dynamic port mapping
- Learning public IP addresses
- Assigning lease times to mappings

Windows Messenger is an example of an application that supports NAT traversal and UPnP.

See the NAT chapter for more information on NAT.

Cautions with UPnP

The automated nature of NAT traversal applications in establishing their own services and opening firewall ports may present network security issues. Network information and configuration may also be obtained and modified by users in some network environments.

When a UPnP device joins a network, it announces its presence with a multicast message. For security reasons, the NBG-418N allows multicast messages on the LAN only.

All UPnP-enabled devices may communicate freely with each other without additional configuration. Disable UPnP if this is not your intention.

14.3 Configuring UPnP

Use this screen to enable UPnP. Click the **Management > UPnP** to open the following screen.

Figure 82 Management > UPnP > General

The following table describes the labels in this screen.

Table 52 Management > UPnP > General

LABEL	DESCRIPTION
Enable the Universal Plug and Play (UPnP) Feature	Select this check box to activate UPnP. Be aware that anyone could use a UPnP application to open the Web Configurator's login screen without entering the NBG-418N's IP address (although you must still enter the password to access the Web Configurator).
Allow users to make port forwarding changes through UPnP	Select this check box to allow UPnP-enabled applications to automatically configure the NBG-418N so that they can communicate through the NBG-418N, for example, by using NAT traversal. UPnP applications automatically reserve a NAT forwarding port in order to communicate with another UPnP enabled device. this eliminates the need to manually configure port forwarding for the UPnP enabled application.
Apply	Click Apply to save the setting to the NBG-418N.
Reset	Click Reset to begin configuring this screen afresh.

14.3.1 Using UPnP in Windows XP Example

This section shows you how to use the UPnP feature in Windows XP. You must already have UPnP installed in Windows XP and UPnP activated on the NBG-418N.

Make sure the computer is connected to a LAN port of the NBG-418N. Turn on your computer and the NBG-418N.

14.3.1.1 Auto-discover Your UPnP-enabled Network Device

- 1 Click **start** and **Control Panel**. Double-click **Network Connections**. An icon displays under Internet Gateway.

- 2 Right-click the icon and select **Properties**.

Figure 83 Network Connections



- 3 In the **Internet Connection Properties** window, click **Settings** to see the port mappings there were automatically created.

Figure 84 Internet Connection Properties



- 4 You may edit or delete the port mappings or click **Add** to manually add port mappings.

Figure 85 Internet Connection Properties: Advanced Settings

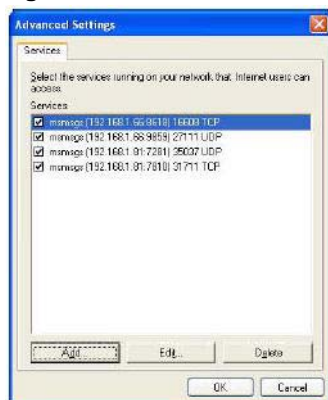
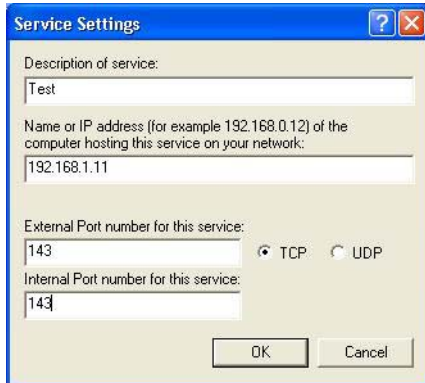

Figure 86 Internet Connection Properties: Advanced Settings: Add

Note: When the UPnP-enabled device is disconnected from your computer, all port mappings will be deleted automatically.

- 5 Select **Show icon in notification area when connected** option and click **OK**. An icon displays in the system tray.

Figure 87 System Tray Icon

- 6 Double-click on the icon to display your current Internet connection status.

Figure 88 Internet Connection Status

14.3.2 Web Configurator Easy Access

With UPnP, you can access the web-based configurator on the NBG-418N without finding out the IP address of the NBG-418N first. This comes helpful if you do not know the IP address of the NBG-418N.

Follow the steps below to access the Web Configurator.

- 1 Click **Start** and then **Control Panel**.
- 2 Double-click **Network Connections**.

3 Select **My Network Places** under **Other Places**.

Figure 89 Network Connections



4 An icon with the description for each UPnP-enabled device displays under **Local Network**.

5 Right-click on the icon for your NBG-418N and select **Invoke**. The Web Configurator login screen displays.

Figure 90 Network Connections: My Network Places



15.1 Overview

This chapter provides information on the **System** screens.

See the chapter about wizard setup for more information on the next few screens.

15.2 What You Can Do

- Use the **General** screen to enter a name to identify the NBG-418N in the network and set the password ([Section 15.3 on page 125](#)).
- Use the **Time Setting** screen to change your NBG-418N's time and date ([Section 15.4 on page 126](#)).

15.3 System General Screen

Use this screen to enter a name to identify the NBG-418N in the network and set the password. Click **Maintenance > System**. The following screen displays.

Figure 91 Maintenance > System > General

The screenshot shows a web interface for system configuration. At the top, there are two tabs: 'General' (selected) and 'Time Setting'. Below the tabs is a 'System Setup' section with three input fields: 'System Name' (containing 'NBG-418N'), 'Domain Name' (containing 'zyxel.com'), and 'Administrator Inactivity Timer' (containing '30' with a note '(minutes, 0 means no timeout)'). Below this is a 'Password Setup' section with three input fields: 'Old Password', 'New Password', and 'Retype to Confirm', all containing masked characters (dots). At the bottom of the form are two buttons: 'Apply' and 'Reset'.

The following table describes the labels in this screen.

Table 53 Maintenance > System > General

LABEL	DESCRIPTION
System Setup	
System Name	System Name is a unique name to identify the NBG-418N in an Ethernet network. It is recommended you enter your computer's "Computer name" in this field (see the chapter about wizard setup for how to find your computer's name). This name can be up to 30 alphanumeric characters long. Spaces are not allowed, but dashes "-" and underscores "_" are accepted.
Domain Name	Enter the domain name (if you know it) here. If you leave this field blank, the ISP may assign a domain name via DHCP. The domain name entered by you is given priority over the ISP assigned domain name.
Administrator Inactivity Timer	Type how many minutes a management session can be left idle before the session times out. The default is 5 minutes. After it times out you have to log in with your password again. Very long idle timeouts may have security risks. A value of "0" means a management session never times out, no matter how long it has been left idle (not recommended).
Password Setup	Change your NBG-418N's password (recommended) using the fields as shown.
Old Password	Type the default password or the existing password you use to access the system in this field.
New Password	Type your new system password (up to 30 characters). Note that as you type a password, the screen displays an asterisk (*) for each character you type.
Retype to Confirm	Type the new password again in this field.
Apply	Click Apply to save your changes back to the NBG-418N.
Reset	Click Reset to begin configuring this screen afresh.

15.4 Time Setting Screen

To change your NBG-418N's time and date, click **Maintenance > System > Time Setting**. The screen appears as shown. Use this screen to configure the NBG-418N's time based on your local time zone.

Figure 92 Maintenance > System > Time Setting

The following table describes the labels in this screen.

Table 54 Maintenance > System > Time Setting

LABEL	DESCRIPTION
Current Time and Date	
Current Time	This field displays the time of your NBG-418N. Each time you reload this page, the NBG-418N synchronizes the time with the time server.
Current Date	This field displays the date of your NBG-418N. Each time you reload this page, the NBG-418N synchronizes the date with the time server.
Time and Date Setup	
Manual	Select this radio button to enter the time and date manually. If you configure a new time and date, Time Zone and Daylight Saving at the same time, the new time and date you entered has priority and the Time Zone and Daylight Saving settings do not affect it.
Copy Your Computer's Time Settings	Click this to copy the time settings of your computer into the NBG-418N's time and date setup.
New Time (hh:mm:ss)	This field displays the last updated time from the time server or the last time configured manually. When you set Time and Date Setup to Manual , enter the new time in this field and then click Apply .

Table 54 Maintenance > System > Time Setting (continued)

LABEL	DESCRIPTION
New Date (yyyy/mm/dd)	This field displays the last updated date from the time server or the last date configured manually. When you set Time and Date Setup to Manual , enter the new date in this field and then click Apply .
Get from Time Server	Select this radio button to have the NBG-418N get the time and date from the time server you specified below.
Auto	Select Auto to have the NBG-418N automatically search for an available time server and synchronize the date and time with the time server after you click Apply .
User Defined Time Server Address	Select User Defined Time Server Address and enter the IP address or URL (up to 20 extended ASCII characters in length) of your time server. Check with your ISP/network administrator if you are unsure of this information.
Time Zone Setup	
Time Zone	Choose the time zone of your location. This will set the time difference between your time zone and Greenwich Mean Time (GMT).
Daylight Savings	Daylight saving is a period from late spring to early fall when many countries set their clocks ahead of normal local time by one hour to give more daytime light in the evening. Select this option if you use Daylight Saving Time.
Start Date	Configure the day and time when Daylight Saving Time starts if you selected Daylight Savings . The o'clock field uses the 24 hour format. Here are a couple of examples: Daylight Saving Time starts in most parts of the United States on the first Sunday of April. Each time zone in the United States starts using Daylight Saving Time at 2 A.M. local time. So in the United States you would select First, Sunday, April and type 2 in the o'clock field. Daylight Saving Time starts in the European Union on the last Sunday of March. All of the time zones in the European Union start using Daylight Saving Time at the same moment (1 A.M. GMT or UTC). So in the European Union you would select Last, Sunday, March . The time you type in the o'clock field depends on your time zone. In Germany for instance, you would type 2 because Germany's time zone is one hour ahead of GMT or UTC (GMT+1).
End Date	Configure the day and time when Daylight Saving Time ends if you selected Daylight Savings . The o'clock field uses the 24 hour format. Here are a couple of examples: Daylight Saving Time ends in the United States on the last Sunday of October. Each time zone in the United States stops using Daylight Saving Time at 2 A.M. local time. So in the United States you would select Last, Sunday, October and type 2 in the o'clock field. Daylight Saving Time ends in the European Union on the last Sunday of October. All of the time zones in the European Union stop using Daylight Saving Time at the same moment (1 A.M. GMT or UTC). So in the European Union you would select Last, Sunday, October . The time you type in the o'clock field depends on your time zone. In Germany for instance, you would type 2 because Germany's time zone is one hour ahead of GMT or UTC (GMT+1).
Apply	Click Apply to save your changes back to the NBG-418N.
Reset	Click Reset to begin configuring this screen afresh.

16.1 Overview

This chapter contains information about configuring general log settings and viewing the NBG-418N's logs.

The Web Configurator allows you to look at all of the NBG-418N's logs in one location.

16.2 What You Need to Know

An alert is a type of log that warrants more serious attention. They include system errors, attacks (access control) and attempted access to blocked web sites or web sites with restricted web features such as cookies, active X and so on. Some categories such as **System Errors** consist of both logs and alerts. You may differentiate them by their color in the **View Log** screen. Alerts display in red and logs display in black.

Alerts are e-mailed as soon as they happen. Logs may be e-mailed as soon as the log is full (see **Log Schedule**). Selecting many alert and/or log categories (especially **Access Control**) may result in many e-mails being sent.

16.3 View Log Screen

Use the **View Log** screen to see the logged messages for the NBG-418N. Options include logs about system maintenance, system errors, access control, allowed or blocked web sites, blocked web features (such as ActiveX controls, Java and cookies), attacks (such as DoS) and IPSec.

Log entries in red indicate system error logs. The log wraps around and deletes the old entries after it fills. Click a column heading to sort the entries. A triangle indicates ascending or descending sort order.

Click **Maintenance > Logs** to open the **View Log** screen.

Figure 93 Maintenance > Logs > View Log

View Log		
Logs		
<input type="button" value="Refresh"/> <input type="button" value="Clear Logs"/> <input type="button" value="First"/> <input type="button" value="Previous"/> <input type="button" value="Next"/> <input type="button" value="Last"/> 1/7		
#	Time	Message
1	Jan 1 00:00:04	started: BusyBox v1.17.3
2	Jan 1 00:00:04	Syslog daemon successfully started
3	Jan 1 00:00:07	Start WAN SETUP: wkmode=router wan_hwname=eth1 protocol=dhcp method=BOOT
4	Jan 1 00:00:07	Finish WAN SETUP: wkmode=router wan_hwname=eth1 protocol=dhcp method=BOOT
5	Jan 1 00:00:07	started, version 2.55 cachesize 150
6	Jan 1 00:00:07	compile time options: no-IPv6 GNU-getopt no-DBus no-I18N DHCP no-scripts no-TFTP
7	Jan 1 00:00:07	DHCP, IP range 192.168.1.33 -- 192.168.1.132, lease time 24m
8	Jan 1 00:00:07	reading /tmp/resolv.dnsmasq
9	Jan 1 00:00:07	using nameserver 4.2.2.4#53
10	Jan 1 00:00:07	using nameserver 156.154.70.1#53
11	Jan 1 00:00:07	using nameserver 168.126.63.1#53
12	Jan 1 00:00:07	read /etc/hosts - 0 addresses
13	Jan 1 00:00:07	read /tmp/hosts - 0 addresses
14	Jan 1 05:19:16	DHCPDISCOVER(br0) 172.23.26.4 00:24:21:7e:20:96
15	Jan 1 05:19:16	DHCPOFFER(br0) 192.168.1.83 00:24:21:7e:20:96
16	Jan 1 05:19:16	DHCPREQUEST(br0) 192.168.1.83 00:24:21:7e:20:96
17	Jan 1 05:19:16	DHCPACK(br0) 192.168.1.83 00:24:21:7e:20:96 twpc13774-02
18	Jan 1 05:19:16	Ignoring domain ZyXEL.com for DHCP host name twpc13774-02
19	Jan 1 05:33:50	DHCPREQUEST(br0) 172.23.26.4 00:24:21:7e:20:96
20	Jan 1 05:33:50	DHCPNAK(br0) 172.23.26.4 00:24:21:7e:20:96 lease not found

The following table describes the labels in this screen.

Table 55 Maintenance > Logs > View Log

LABEL	DESCRIPTION
Refresh	Click Refresh to renew the log screen.
Clear Logs	Click Clear Logs to delete all the logs.
Next	Click Next to show the next page of log entries.
Last	Click Last to show the last page of log entries.
#	This is the index number of the log entry.
Time	This field displays the time the log was recorded. See the chapter on system maintenance and information to configure the NBG-418N's time and date.
Message	This field states the reason for the log.

17.1 Overview

This chapter shows you how to upload a new firmware, upload or save backup configuration files and restart the NBG-418N.

17.2 What You Can Do

- Use the **Firmware** screen to upload firmware to your NBG-418N ([Section 17.3 on page 131](#)).
- Use the **Configuration** screen to view information related to factory defaults, backup configuration, and restoring configuration ([Section 17.4 on page 133](#)).
- Use the **Restart** screen to have the NBG-418N reboot ([Section 17.5 on page 134](#)).

17.3 Firmware Upload Screen

Find firmware at www.zyxel.com in a file that (usually) uses the system model name with a “*.bin” extension, e.g., “NBG-418N.bin”. The upload process uses HTTP (Hypertext Transfer Protocol) and may take up to two minutes. After a successful upload, the system will reboot.

Click **Maintenance > Tools**. Follow the instructions in this screen to upload firmware to your NBG-418N.

Figure 94 Maintenance > Tools > Firmware

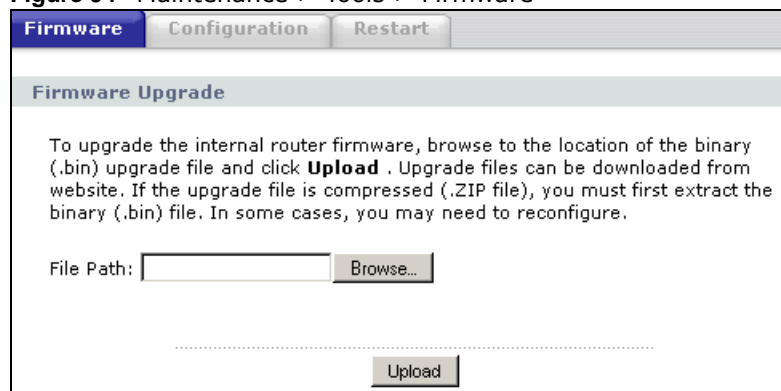

The screenshot shows the 'Firmware Upgrade' screen. At the top, there are three tabs: 'Firmware' (selected), 'Configuration', and 'Restart'. Below the tabs is a header 'Firmware Upgrade'. The main content area contains the following text: 'To upgrade the internal router firmware, browse to the location of the binary (.bin) upgrade file and click **Upload**. Upgrade files can be downloaded from website. If the upgrade file is compressed (.ZIP file), you must first extract the binary (.bin) file. In some cases, you may need to reconfigure.' Below this text is a 'File Path:' label followed by a text input field and a 'Browse...' button. At the bottom of the form is an 'Upload' button.

The following table describes the labels in this screen.

Table 56 Maintenance > Tools > Firmware

LABEL	DESCRIPTION
File Path	Type in the location of the file you want to upload in this field or click Browse... to find it.
Browse...	Click Browse... to find the .bin file you want to upload. Remember that you must decompress compressed (.zip) files before you can upload them.
Upload	Click Upload to begin the upload process. This process may take up to two minutes.

Note: Do not turn off the NBG-418N while firmware upload is in progress!

After you see the **Firmware Upload In Process** screen, wait for several minutes before logging into the NBG-418N again.

Figure 95 Upload Warning



The NBG-418N automatically restarts in this time causing a temporary network disconnect. In some operating systems, you may see the following icon on your desktop.

Figure 96 Network Temporarily Disconnected

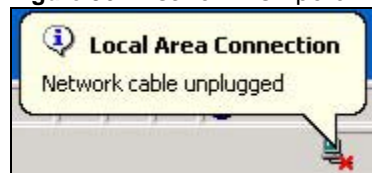

After two minutes, log in again and check your new firmware version in the **Status** screen.

If the upload was not successful, the following screen will appear. Click **Return** to go back to the **Firmware** screen.

Figure 97 Upload Error Message



17.4 Configuration Screen

Click **Maintenance > Tools > Configuration**. Information related to factory defaults, backup configuration, and restoring configuration appears as shown next.

Figure 98 Maintenance > Tools > Configuration

The screenshot shows the Configuration screen with three main sections:

- Backup Configuration:** A section with the instruction "Click **Backup** to save the current configuration of your system to your computer." and a **Backup** button.
- Restore Configuration:** A section with the instruction "To restore a previously saved configuration file to your system, browse to the location of the configuration file and click **Upload**." It includes a "File Path:" label, a text input field, a **Browse...** button, and an **Upload** button.
- Back to Factory Defaults:** A section with the instruction "Click **Reset** to clear all user-entered configuration information and return to factory defaults. After resetting, the" followed by a list of default settings:
 - Username is admin and password will be 1234
 - LAN IP address will be 192.168.1.1
 - DHCP will be reset to server
 and a **Reset** button.

17.4.1 Backup Configuration

Backup configuration allows you to back up (save) the NBG-418N's current configuration to a file on your computer. Once your NBG-418N is configured and functioning properly, it is highly recommended that you back up your configuration file before making configuration changes. The backup configuration file will be useful in case you need to return to your previous settings.

Click **Backup** to save the NBG-418N's current configuration to your computer.

17.4.2 Restore Configuration

Restore configuration allows you to upload a new or previously saved configuration file from your computer to your NBG-418N.

Table 57 Maintenance Restore Configuration

LABEL	DESCRIPTION
File Path	Type in the location of the file you want to upload in this field or click Browse... to find it.
Browse...	Click Browse... to find the file you want to upload. Remember that you must decompress compressed (.ZIP) files before you can upload them.
Upload	Click Upload to begin the upload process.

Note: Do not turn off the NBG-418N while configuration file upload is in progress.

After you see a “configuration upload successful” screen, you must then wait one minute before logging into the NBG-418N again.

Figure 99 Configuration Restore Successful



The NBG-418N automatically restarts in this time causing a temporary network disconnect. In some operating systems, you may see the following icon on your desktop.

Figure 100 Temporarily Disconnected

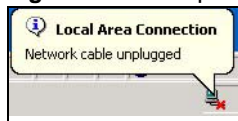

If you uploaded the default configuration file you may need to change the IP address of your computer to be in the same subnet as that of the default NBG-418N IP address (192.168.1.1 in router mode). See [Appendix C on page 167](#) for details on how to set up your computer’s IP address.

If the upload was not successful, the following screen will appear. Click **Return** to go back to the **Configuration** screen.

Figure 101 Configuration Restore Error



17.4.3 Back to Factory Defaults

Pressing the **Reset** button in this section clears all user-entered configuration information and returns the NBG-418N to its factory defaults.

You can also press the **RESET** button on the rear panel to reset the factory defaults of your NBG-418N. Refer to [Section 2.3.1 on page 19](#) for more information on the **RESET** button.

17.5 Restart Screen

System restart allows you to reboot the NBG-418N without turning the power off.

Click **Maintenance > Tools > Restart**. Click **Restart** to have the NBG-418N reboot. This does not affect the NBG-418N's configuration.

Figure 102 Maintenance > Tools > Restart

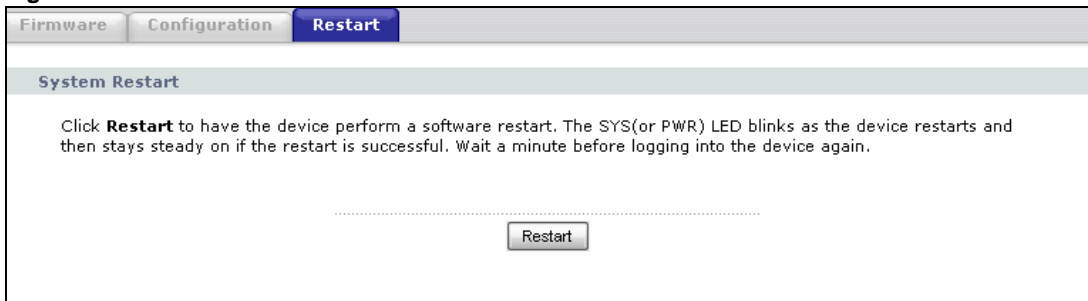

Sys OP Mode

18.1 Overview

The **Sys OP Mode** (System Operation Mode) function lets you configure select the device operation mode: **Router**, **Access Point**, **Client Bridge** or **Universal Repeater**.

See [Chapter 4 on page 35](#) for more information on which mode to choose.

18.2 General Screen

Use this screen to select how you connect to the Internet.

Figure 103 Maintenance > Sys OP Mode > General

General

System Operation Mode

Router
 Access Point
 Universal Repeater
 Client Bridge

Note :

Router : In this mode, the device is supported to connect to internet via ADSL/Cable Modem. PCs in LAN ports share the same IP to ISP through WAN Port.

Access Point : In this mode, all Ethernet ports are bridged together. The device allows the wireless-equipped computer can communicate with a wired network.

Universal Repeater : In this mode, the device acts as both access point and wireless client. It can transmit wireless traffic between two wireless networks.

Client Bridge : In this mode, the device acts as a wireless client. It can connect to an existing network via an access point. Also bridge functions are added between the wireless LAN and the LAN.

Apply Reset

The following table describes the labels in the **General** screen.

Table 58 Maintenance > Sys Op Mode > General

LABEL	DESCRIPTION
System Operation Mode	
Router	Use this mode if you want to use routing functions such as LAN DHCP, NAT, firewall and so on on the NBG-418N (N). The NBG-418N has separate LAN and WAN network IP addresses.
Access Point	Use this mode if you already have a Router (R) in your network and you want to bridge all wired and wireless network connections.

Table 58 Maintenance > Sys Op Mode > General (continued)

LABEL	DESCRIPTION
Universal Repeater	Use this mode if there is an existing wireless router or access point in your network and you want the NBG-418N to wirelessly relay communications from its wireless clients to it.
Client Bridge	Use this mode if there is an existing wireless router or access point (AP) in the network to which you want to connect your NBG-418N wirelessly. You should know the SSID and wireless security details of the wireless router or access point to which you want to connect.
Apply	Click Apply to save your settings.
Reset	Click Reset to return to the previous screen settings.

If you select **Router** mode, the following pop-up message window appears.

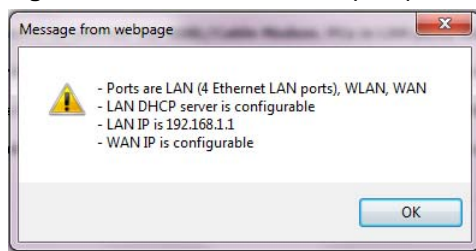
Figure 104 Maintenance > Sys Op Mode > General: Router

- In this mode there are both LAN and WAN ports. The LAN Ethernet and WAN Ethernet ports have different IP addresses.
- The DHCP server on your device is enabled and allocates IP addresses to other devices on your local network.
- The LAN IP address of the NBG-418N is set to 192.168.1.1.
- You can configure the IP address settings on your WAN port. Contact your ISP or system administrator for more information on appropriate settings.

If you select a non-router mode (**Access Point**, **Client Bridge** or **Universal Repeater**) the following pop-up message window appears.

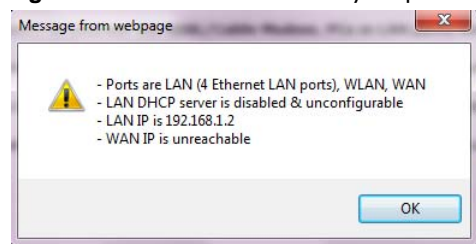
Figure 105 Maintenance > Sys Op Mode > General: Non-Router

- In non-router mode, all Ethernet ports have the same IP address.
- All ports on the rear panel of the device are LAN ports, including the port labeled WAN. There is no WAN port.
- The DHCP server on your device is disabled. In this mode there must be a device with a DHCP server on your network such as a router which can allocate IP addresses or else you need to manually assign IP addresses to devices on your network.
- The LAN IP address of the NBG-418N is set to 192.168.1.2.

Language

19.1 Language Screen

Use this screen to change the language for the Web Configurator display.

Click the language you prefer. The Web Configurator language changes after a while without restarting the NBG-418N.

Figure 106 Language

Language Selection		
English	Deutsch	Français
Español	繁體中文	Italiano
简体中文	ไทย	Türkçe
Česky	Polski	Magyar
Roman	Русский	Български

Figure 107 Language Change Example

介面語系選擇		
English	Deutsch	Français
Español	繁體中文	Italiano
简体中文	ไทย	Türkçe
Česky	Polski	Magyar
Roman	Русский	Български

Troubleshooting

This chapter offers some suggestions to solve problems you might encounter. The potential problems are divided into the following categories.

- [Power, Hardware Connections, and LEDs](#)
- [NBG-418N Access and Login](#)
- [Internet Access](#)
- [Resetting the NBG-418N to Its Factory Defaults](#)
- [Wireless Problems](#)

20.1 Power, Hardware Connections, and LEDs

The NBG-418N does not turn on. None of the LEDs turn on.

- 1 Make sure you are using the power adaptor or cord included with the NBG-418N.
- 2 Make sure the power adaptor or cord is connected to the NBG-418N and plugged in to an appropriate power source. Make sure the power source is turned on.
- 3 Disconnect and re-connect the power adaptor or cord to the NBG-418N.
- 4 If the problem continues, contact the vendor.

One of the LEDs does not behave as expected.

- 1 Make sure you understand the normal behavior of the LED. See [Section 1.3 on page 15](#).
- 2 Check the hardware connections. See the Quick Start Guide.
- 3 Inspect your cables for damage. Contact the vendor to replace any damaged cables.
- 4 Disconnect and re-connect the power adaptor to the NBG-418N.
- 5 If the problem continues, contact the vendor.

20.2 NBG-418N Access and Login

I don't know the IP address of my NBG-418N.

- 1 The default IP address in router mode is **192.168.1.1** and in non-router mode is **192.168.1.2**.
- 2 If you changed the IP address and have forgotten it, you might get the IP address of the NBG-418N by looking up the IP address of the default gateway for your computer. To do this in most Windows computers, click **Start > Run**, enter **cmd**, and then enter **ipconfig**. The IP address of the **Default Gateway** might be the IP address of the NBG-418N (it depends on the network), so enter this IP address in your Internet browser. Set your device to **Router Mode**, login (see the Quick Start Guide for instructions) and go to the **Device Information** table in the **Status** screen. Your NBG-418N's IP address is available in the **Device Information** table.
 - If the **DHCP** setting under **LAN information** is **None**, your device has a fixed IP address.
 - If the **DHCP** setting under **LAN information** is **Client**, then your device receives an IP address from a DHCP server on the network.
- 3 If your NBG-418N is a DHCP client, you can find your IP address from the DHCP server. This information is only available from the DHCP server which allocates IP addresses on your network. Find this information directly from the DHCP server or contact your system administrator for more information.
- 4 Reset your NBG-418N to change all settings back to their default. This means your current settings are lost. See [Section 20.4 on page 144](#) in the **Troubleshooting** for information on resetting your NBG-418N.

I forgot the username and password.

- 1 The default username is **admin** and default password is **1234**.
- 2 If this does not work, you have to reset the device to its factory defaults. See [Section 20.4 on page 144](#).

I cannot see or access the **Login** screen in the Web Configurator.

- 1 Make sure you are using the correct IP address.
 - The default IP address is 192.168.1.1 (router mode).
 - If you changed the IP address, use the new IP address.
 - If you changed the IP address and have forgotten it, see the troubleshooting suggestions for [I don't know the IP address of my NBG-418N](#).

- 2 Check the hardware connections, and make sure the LEDs are behaving as expected. See the Quick Start Guide.
- 3 Make sure your Internet browser does not block pop-up windows and has JavaScript and Java enabled. See [Appendix B on page 157](#).
- 4 Make sure your computer is in the same subnet as the NBG-418N. (If you know that there are routers between your computer and the NBG-418N, skip this step.)
 - If there is a DHCP server on your network, make sure your computer is using a dynamic IP address.
 - If there is no DHCP server on your network, make sure your computer's IP address is in the same subnet as the NBG-418N.
- 5 Reset the device to its factory defaults, and try to access the NBG-418N with the default IP address.
- 6 If the problem continues, contact the network administrator or vendor, or try one of the advanced suggestions.

Advanced Suggestions

- If your computer is connected to the **WAN** port or is connected wirelessly, use a computer that is connected to a **LAN/ETHERNET** port.

I can see the **Login** screen, but I cannot log in to the NBG-418N.

- 1 Make sure you have entered the password correctly. The default username is **admin** and default password is **1234**. This field is case-sensitive, so make sure [Caps Lock] is not on.
- 2 This can happen when you fail to log out properly from your last session. Try logging in again after 5 minutes.
- 3 Disconnect and re-connect the power adaptor or cord to the NBG-418N.
- 4 If this does not work, you have to reset the device to its factory defaults. See [Section 20.4 on page 144](#).

20.3 Internet Access

I cannot access the Internet.

- 1 Check the hardware connections, and make sure the LEDs are behaving as expected. See the Quick Start Guide.
- 2 Make sure you entered your ISP account information correctly in the wizard. These fields are case-sensitive, so make sure [Caps Lock] is not on.

- 3 If you are trying to access the Internet wirelessly, make sure the wireless settings in the wireless client are the same as the settings in the AP.
- 4 Disconnect all the cables from your device, and follow the directions in the Quick Start Guide again.
- 5 Go to **Maintenance > Sys OP Mode > General**. Check your **System Operation Mode** setting.
- 6 If the problem continues, contact your ISP.

I cannot access the Internet anymore. I had access to the Internet (with the NBG-418N), but my Internet connection is not available anymore.

- 1 Check the hardware connections, and make sure the LEDs are behaving as expected. See the Quick Start Guide and [Section 1.3 on page 15](#).
- 2 Reboot the NBG-418N.
- 3 If the problem continues, contact your ISP.

The Internet connection is slow or intermittent.

- 1 There might be a lot of traffic on the network. Look at the LEDs, and check [Section 1.3 on page 15](#). If the NBG-418N is sending or receiving a lot of information, try closing some programs that use the Internet, especially peer-to-peer applications.
- 2 Check the signal strength. If the signal strength is low, try moving the NBG-418N closer to the AP if possible, and look around to see if there are any devices that might be interfering with the wireless network (for example, microwaves, other wireless networks, and so on).
- 3 Reboot the NBG-418N.
- 4 If the problem continues, contact the network administrator or vendor, or try one of the advanced suggestions.

Advanced Suggestion

- Check the settings for QoS. If it is disabled, you might consider activating it.

20.4 Resetting the NBG-418N to Its Factory Defaults

If you reset the NBG-418N, you lose all of the changes you have made. The NBG-418N re-loads its default settings, and the username/password resets to **admin/1234**. You have to make all of your changes again.

You will lose all of your changes when you push the **RESET** button.

To reset the NBG-418N,

- 1 Make sure the power LED is on.
- 2 Press the **RESET** button for longer than 1 second to restart/reboot the NBG-418N.
- 3 Press the **RESET** button for longer than five seconds to set the NBG-418N back to its factory-default configurations.

If the NBG-418N restarts automatically, wait for the NBG-418N to finish restarting, and log in to the Web Configurator. The username is **admin** and password is **1234**.

If the NBG-418N does not restart automatically, disconnect and reconnect the NBG-418N's power. Then, follow the directions above again.

20.5 Wireless Problems

I cannot access the NBG-418N or ping any computer from the WLAN.

- 1 Make sure the wireless LAN is enabled on the NBG-418N.
- 2 Make sure the wireless adapter on the wireless station is working properly.
- 3 Make sure the wireless adapter installed on your computer is IEEE 802.11 compatible and supports the same wireless standard as the NBG-418N.
- 4 Make sure your computer (with a wireless adapter installed) is within the transmission range of the NBG-418N.
- 5 Check that both the NBG-418N and your wireless station are using the same wireless and wireless security settings.
- 6 Make sure traffic between the WLAN and the LAN is not blocked by the firewall on the NBG-418N.
- 7 Make sure you allow the NBG-418N to be remotely accessed through the WLAN interface. Check your remote management settings.
 - See [Chapter 6 Wireless LAN](#) for more information.

I cannot access the Web Configurator after I switched to a non-router mode.

When you change from router mode to a non-router mode, you must manually give your computer an IP address in the range between 192.168.1.3 and 192.168.1.254 as non-router mode has no LAN DHCP server.

Refer to [Appendix C on page 167](#) for instructions on how to change your computer's IP address.

IP Addresses and Subnetting

This appendix introduces IP addresses and subnet masks.

IP addresses identify individual devices on a network. Every networking device (including computers, servers, routers, printers, etc.) needs an IP address to communicate across the network. These networking devices are also known as hosts.

Subnet masks determine the maximum number of possible hosts on a network. You can also use subnet masks to divide one network into multiple sub-networks.

Introduction to IP Addresses

One part of the IP address is the network number, and the other part is the host ID. In the same way that houses on a street share a common street name, the hosts on a network share a common network number. Similarly, as each house has its own house number, each host on the network has its own unique identifying number - the host ID. Routers use the network number to send packets to the correct network, while the host ID determines to which host on the network the packets are delivered.

Structure

An IP address is made up of four parts, written in dotted decimal notation (for example, 192.168.1.1). Each of these four parts is known as an octet. An octet is an eight-digit binary number (for example 11000000, which is 192 in decimal notation).

Therefore, each octet has a possible range of 00000000 to 11111111 in binary, or 0 to 255 in decimal.

The following figure shows an example IP address in which the first three octets (192.168.1) are the network number, and the fourth octet (16) is the host ID.

Figure 108 Network Number and Host ID

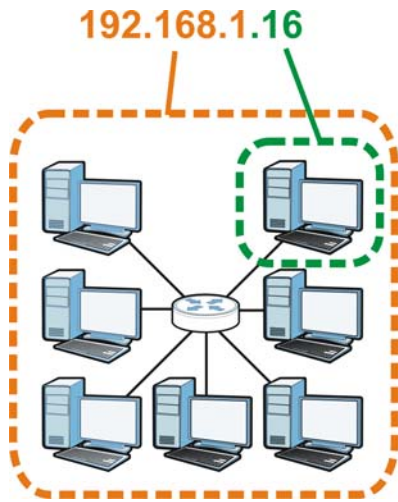

How much of the IP address is the network number and how much is the host ID varies according to the subnet mask.

Subnet Masks

A subnet mask is used to determine which bits are part of the network number, and which bits are part of the host ID (using a logical AND operation). The term “subnet” is short for “sub-network”.

A subnet mask has 32 bits. If a bit in the subnet mask is a “1” then the corresponding bit in the IP address is part of the network number. If a bit in the subnet mask is “0” then the corresponding bit in the IP address is part of the host ID.

The following example shows a subnet mask identifying the network number (in bold text) and host ID of an IP address (192.168.1.2 in decimal).

Table 59 IP Address Network Number and Host ID Example

	1ST OCTET: (192)	2ND OCTET: (168)	3RD OCTET: (1)	4TH OCTET (2)
IP Address (Binary)	11000000	10101000	00000001	00000010
Subnet Mask (Binary)	11111111	11111111	11111111	00000000
Network Number	11000000	10101000	00000001	
Host ID				00000010

By convention, subnet masks always consist of a continuous sequence of ones beginning from the leftmost bit of the mask, followed by a continuous sequence of zeros, for a total number of 32 bits.

Subnet masks can be referred to by the size of the network number part (the bits with a “1” value). For example, an “8-bit mask” means that the first 8 bits of the mask are ones and the remaining 24 bits are zeroes.

Subnet masks are expressed in dotted decimal notation just like IP addresses. The following examples show the binary and decimal notation for 8-bit, 16-bit, 24-bit and 29-bit subnet masks.

Table 60 Subnet Masks

	BINARY				DECIMAL
	1ST OCTET	2ND OCTET	3RD OCTET	4TH OCTET	
8-bit mask	11111111	00000000	00000000	00000000	255.0.0.0
16-bit mask	11111111	11111111	00000000	00000000	255.255.0.0
24-bit mask	11111111	11111111	11111111	00000000	255.255.255.0
29-bit mask	11111111	11111111	11111111	11111000	255.255.255.248

Network Size

The size of the network number determines the maximum number of possible hosts you can have on your network. The larger the number of network number bits, the smaller the number of remaining host ID bits.

An IP address with host IDs of all zeros is the IP address of the network (192.168.1.0 with a 24-bit subnet mask, for example). An IP address with host IDs of all ones is the broadcast address for that network (192.168.1.255 with a 24-bit subnet mask, for example).

As these two IP addresses cannot be used for individual hosts, calculate the maximum number of possible hosts in a network as follows:

Table 61 Maximum Host Numbers

SUBNET MASK		HOST ID SIZE		MAXIMUM NUMBER OF HOSTS
8 bits	255.0.0.0	24 bits	$2^{24} - 2$	16777214
16 bits	255.255.0.0	16 bits	$2^{16} - 2$	65534
24 bits	255.255.255.0	8 bits	$2^8 - 2$	254
29 bits	255.255.255.248	3 bits	$2^3 - 2$	6

Notation

Since the mask is always a continuous number of ones beginning from the left, followed by a continuous number of zeros for the remainder of the 32 bit mask, you can simply specify the number of ones instead of writing the value of each octet. This is usually specified by writing a "/" followed by the number of bits in the mask after the address.

For example, 192.1.1.0 /25 is equivalent to saying 192.1.1.0 with subnet mask 255.255.255.128.

The following table shows some possible subnet masks using both notations.

Table 62 Alternative Subnet Mask Notation

SUBNET MASK	ALTERNATIVE NOTATION	LAST OCTET (BINARY)	LAST OCTET (DECIMAL)
255.255.255.0	/24	0000 0000	0
255.255.255.128	/25	1000 0000	128
255.255.255.192	/26	1100 0000	192

Table 62 Alternative Subnet Mask Notation (continued)

SUBNET MASK	ALTERNATIVE NOTATION	LAST OCTET (BINARY)	LAST OCTET (DECIMAL)
255.255.255.224	/27	1110 0000	224
255.255.255.240	/28	1111 0000	240
255.255.255.248	/29	1111 1000	248
255.255.255.252	/30	1111 1100	252

Subnetting

You can use subnetting to divide one network into multiple sub-networks. In the following example a network administrator creates two sub-networks to isolate a group of servers from the rest of the company network for security reasons.

In this example, the company network address is 192.168.1.0. The first three octets of the address (192.168.1) are the network number, and the remaining octet is the host ID, allowing a maximum of $2^8 - 2$ or 254 possible hosts.

The following figure shows the company network before subnetting.

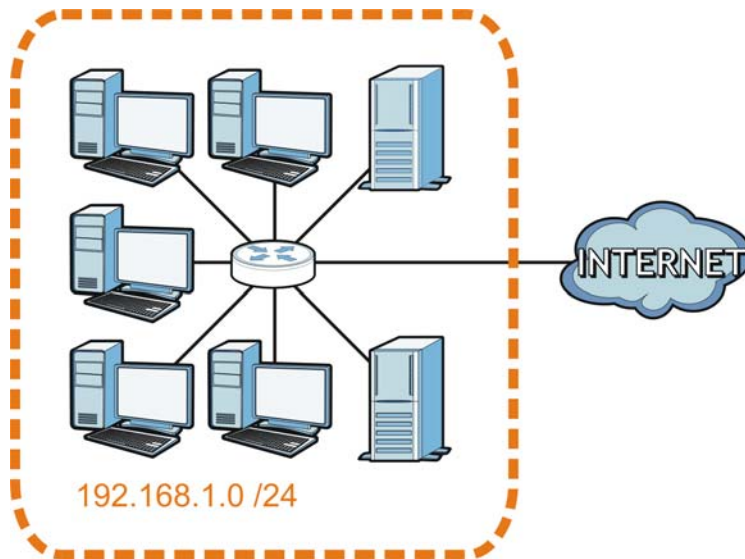
Figure 109 Subnetting Example: Before Subnetting

You can “borrow” one of the host ID bits to divide the network 192.168.1.0 into two separate sub-networks. The subnet mask is now 25 bits (255.255.255.128 or /25).

The “borrowed” host ID bit can have a value of either 0 or 1, allowing two subnets; 192.168.1.0 /25 and 192.168.1.128 /25.

The following figure shows the company network after subnetting. There are now two sub-networks, **A** and **B**.

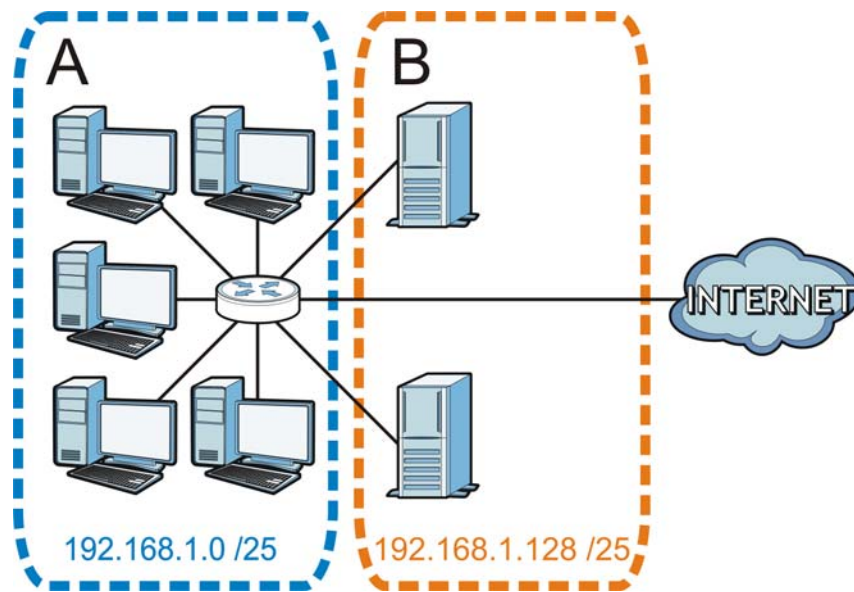
Figure 110 Subnetting Example: After Subnetting

In a 25-bit subnet the host ID has 7 bits, so each sub-network has a maximum of $2^7 - 2$ or 126 possible hosts (a host ID of all zeroes is the subnet's address itself, all ones is the subnet's broadcast address).

192.168.1.0 with mask 255.255.255.128 is subnet **A** itself, and 192.168.1.127 with mask 255.255.255.128 is its broadcast address. Therefore, the lowest IP address that can be assigned to an actual host for subnet **A** is 192.168.1.1 and the highest is 192.168.1.126.

Similarly, the host ID range for subnet **B** is 192.168.1.129 to 192.168.1.254.

Example: Four Subnets

The previous example illustrated using a 25-bit subnet mask to divide a 24-bit address into two subnets. Similarly, to divide a 24-bit address into four subnets, you need to "borrow" two host ID bits to give four possible combinations (00, 01, 10 and 11). The subnet mask is 26 bits (11111111.11111111.11111111.11000000) or 255.255.255.192.

Each subnet contains 6 host ID bits, giving $2^6 - 2$ or 62 hosts for each subnet (a host ID of all zeroes is the subnet itself, all ones is the subnet's broadcast address).

Table 63 Subnet 1

IP/SUBNET MASK	NETWORK NUMBER	LAST OCTET BIT VALUE
IP Address (Decimal)	192.168.1.	0
IP Address (Binary)	11000000.10101000.00000001.	00000000
Subnet Mask (Binary)	11111111.11111111.11111111.	11000000
Subnet Address: 192.168.1.0	Lowest Host ID: 192.168.1.1	
Broadcast Address: 192.168.1.63	Highest Host ID: 192.168.1.62	

Table 64 Subnet 2

IP/SUBNET MASK	NETWORK NUMBER	LAST OCTET BIT VALUE
IP Address	192.168.1.	64
IP Address (Binary)	11000000.10101000.00000001.	01000000
Subnet Mask (Binary)	11111111.11111111.11111111.	11000000
Subnet Address: 192.168.1.64	Lowest Host ID: 192.168.1.65	
Broadcast Address: 192.168.1.127	Highest Host ID: 192.168.1.126	

Table 65 Subnet 3

IP/SUBNET MASK	NETWORK NUMBER	LAST OCTET BIT VALUE
IP Address	192.168.1.	128
IP Address (Binary)	11000000.10101000.00000001.	10000000
Subnet Mask (Binary)	11111111.11111111.11111111.	11000000
Subnet Address: 192.168.1.128	Lowest Host ID: 192.168.1.129	
Broadcast Address: 192.168.1.191	Highest Host ID: 192.168.1.190	

Table 66 Subnet 4

IP/SUBNET MASK	NETWORK NUMBER	LAST OCTET BIT VALUE
IP Address	192.168.1.	192
IP Address (Binary)	11000000.10101000.00000001.	11000000
Subnet Mask (Binary)	11111111.11111111.11111111.	11000000
Subnet Address: 192.168.1.192	Lowest Host ID: 192.168.1.193	
Broadcast Address: 192.168.1.255	Highest Host ID: 192.168.1.254	

Example: Eight Subnets

Similarly, use a 27-bit mask to create eight subnets (000, 001, 010, 011, 100, 101, 110 and 111).

The following table shows IP address last octet values for each subnet.

Table 67 Eight Subnets

SUBNET	SUBNET ADDRESS	FIRST ADDRESS	LAST ADDRESS	BROADCAST ADDRESS
1	0	1	30	31
2	32	33	62	63
3	64	65	94	95
4	96	97	126	127
5	128	129	158	159
6	160	161	190	191

Table 67 Eight Subnets (continued)

SUBNET	SUBNET ADDRESS	FIRST ADDRESS	LAST ADDRESS	BROADCAST ADDRESS
7	192	193	222	223
8	224	225	254	255

Subnet Planning

The following table is a summary for subnet planning on a network with a 24-bit network number.

Table 68 24-bit Network Number Subnet Planning

NO. "BORROWED" HOST BITS	SUBNET MASK	NO. SUBNETS	NO. HOSTS PER SUBNET
1	255.255.255.128 (/25)	2	126
2	255.255.255.192 (/26)	4	62
3	255.255.255.224 (/27)	8	30
4	255.255.255.240 (/28)	16	14
5	255.255.255.248 (/29)	32	6
6	255.255.255.252 (/30)	64	2
7	255.255.255.254 (/31)	128	1

The following table is a summary for subnet planning on a network with a 16-bit network number.

Table 69 16-bit Network Number Subnet Planning

NO. "BORROWED" HOST BITS	SUBNET MASK	NO. SUBNETS	NO. HOSTS PER SUBNET
1	255.255.128.0 (/17)	2	32766
2	255.255.192.0 (/18)	4	16382
3	255.255.224.0 (/19)	8	8190
4	255.255.240.0 (/20)	16	4094
5	255.255.248.0 (/21)	32	2046
6	255.255.252.0 (/22)	64	1022
7	255.255.254.0 (/23)	128	510
8	255.255.255.0 (/24)	256	254
9	255.255.255.128 (/25)	512	126
10	255.255.255.192 (/26)	1024	62
11	255.255.255.224 (/27)	2048	30
12	255.255.255.240 (/28)	4096	14
13	255.255.255.248 (/29)	8192	6
14	255.255.255.252 (/30)	16384	2
15	255.255.255.254 (/31)	32768	1

Configuring IP Addresses

Where you obtain your network number depends on your particular situation. If the ISP or your network administrator assigns you a block of registered IP addresses, follow their instructions in selecting the IP addresses and the subnet mask.

If the ISP did not explicitly give you an IP network number, then most likely you have a single user account and the ISP will assign you a dynamic IP address when the connection is established. If this is the case, it is recommended that you select a network number from 192.168.0.0 to 192.168.255.0. The Internet Assigned Number Authority (IANA) reserved this block of addresses specifically for private use; please do not use any other number unless you are told otherwise. You must also enable Network Address Translation (NAT) on the NBG-418N.

Once you have decided on the network number, pick an IP address for your NBG-418N that is easy to remember (for instance, 192.168.1.1) but make sure that no other device on your network is using that IP address.

The subnet mask specifies the network number portion of an IP address. Your NBG-418N will compute the subnet mask automatically based on the IP address that you entered. You don't need to change the subnet mask computed by the NBG-418N unless you are instructed to do otherwise.

Private IP Addresses

Every machine on the Internet must have a unique address. If your networks are isolated from the Internet (running only between two branch offices, for example) you can assign any IP addresses to the hosts without problems. However, the Internet Assigned Numbers Authority (IANA) has reserved the following three blocks of IP addresses specifically for private networks:

- 10.0.0.0 — 10.255.255.255
- 172.16.0.0 — 172.31.255.255
- 192.168.0.0 — 192.168.255.255

You can obtain your IP address from the IANA, from an ISP, or it can be assigned from a private network. If you belong to a small organization and your Internet access is through an ISP, the ISP can provide you with the Internet addresses for your local networks. On the other hand, if you are part of a much larger organization, you should consult your network administrator for the appropriate IP addresses.

Regardless of your particular situation, do not create an arbitrary IP address; always follow the guidelines above. For more information on address assignment, please refer to RFC 1597, Address Allocation for Private Internets and RFC 1466, Guidelines for Management of IP Address Space.

IP Address Conflicts

Each device on a network must have a unique IP address. Devices with duplicate IP addresses on the same network will not be able to access the Internet or other resources. The devices may also be unreachable through the network.

Conflicting Computer IP Addresses Example

More than one device can not use the same IP address. In the following example computer **A** has a static (or fixed) IP address that is the same as the IP address that a DHCP server assigns to

computer **B** which is a DHCP client. Neither can access the Internet. This problem can be solved by assigning a different static IP address to computer **A** or setting computer **A** to obtain an IP address automatically.

Figure 111 Conflicting Computer IP Addresses Example

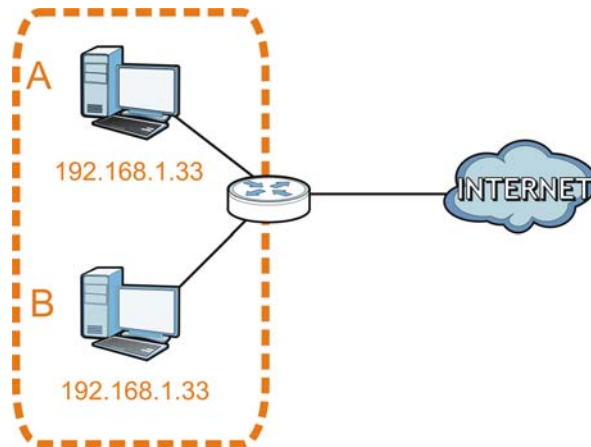

Conflicting Router IP Addresses Example

Since a router connects different networks, it must have interfaces using different network numbers. For example, if a router is set between a LAN and the Internet (WAN), the router's LAN and WAN addresses must be on different subnets. In the following example, the LAN and WAN are on the same subnet. The LAN computers cannot access the Internet because the router cannot route between networks.

Figure 112 Conflicting Router IP Addresses Example

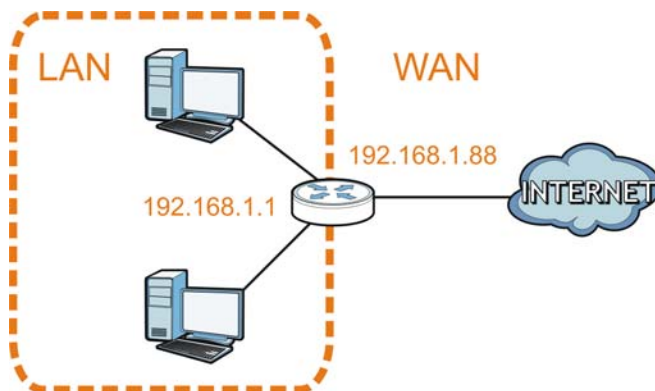

Conflicting Computer and Router IP Addresses Example

More than one device can not use the same IP address. In the following example, the computer and the router's LAN port both use 192.168.1.1 as the IP address. The computer cannot access the Internet. This problem can be solved by assigning a different IP address to the computer or the router's LAN port.

Figure 113 Conflicting Computer and Router IP Addresses Example

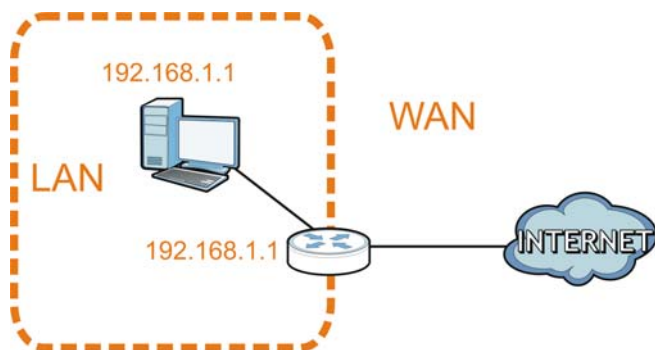

Pop-up Windows, JavaScripts and Java Permissions

In order to use the web configurator you need to allow:

- Web browser pop-up windows from your device.
- JavaScripts (enabled by default).
- Java permissions (enabled by default).

Note: The screens used below belong to Internet Explorer version 6, 7 and 8. Screens for other Internet Explorer versions may vary.

Internet Explorer Pop-up Blockers

You may have to disable pop-up blocking to log into your device.

Either disable pop-up blocking (enabled by default in Windows XP SP (Service Pack) 2) or allow pop-up blocking and create an exception for your device's IP address.

Disable Pop-up Blockers

- 1 In Internet Explorer, select **Tools, Pop-up Blocker** and then select **Turn Off Pop-up Blocker**.

Figure 114 Pop-up Blocker

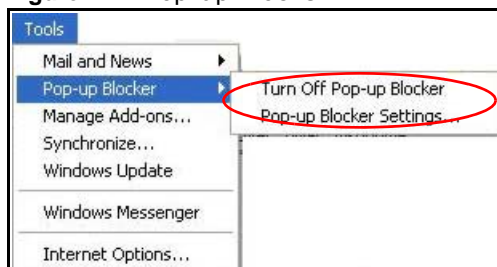

You can also check if pop-up blocking is disabled in the **Pop-up Blocker** section in the **Privacy** tab.

- 1 In Internet Explorer, select **Tools, Internet Options, Privacy**.
- 2 Clear the **Block pop-ups** check box in the **Pop-up Blocker** section of the screen. This disables any web pop-up blockers you may have enabled.

Figure 115 Internet Options: Privacy



- 3 Click **Apply** to save this setting.

Enable Pop-up Blockers with Exceptions

Alternatively, if you only want to allow pop-up windows from your device, see the following steps.

- 1 In Internet Explorer, select **Tools, Internet Options** and then the **Privacy** tab.
- 2 Select **Settings...** to open the **Pop-up Blocker Settings** screen.

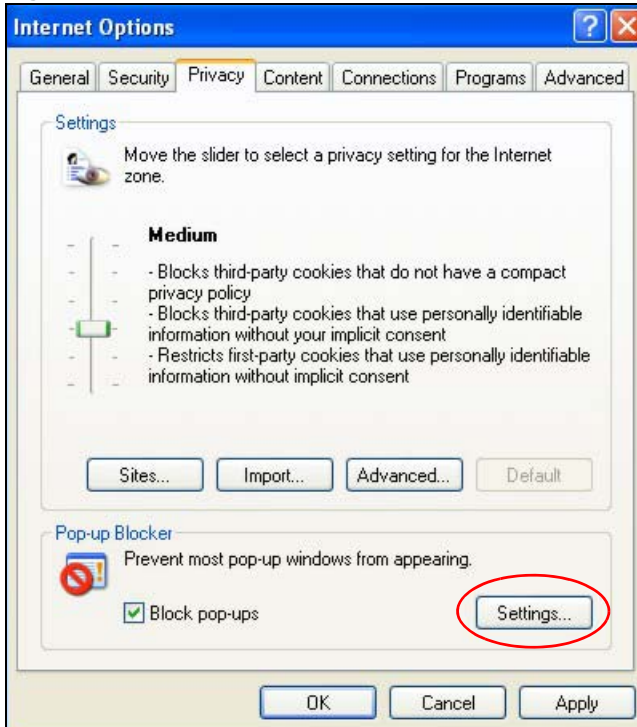
Figure 116 Internet Options: Privacy

- 3 Type the IP address of your device (the web page that you do not want to have blocked) with the prefix "http://". For example, http://192.168.167.1.
- 4 Click **Add** to move the IP address to the list of **Allowed sites**.

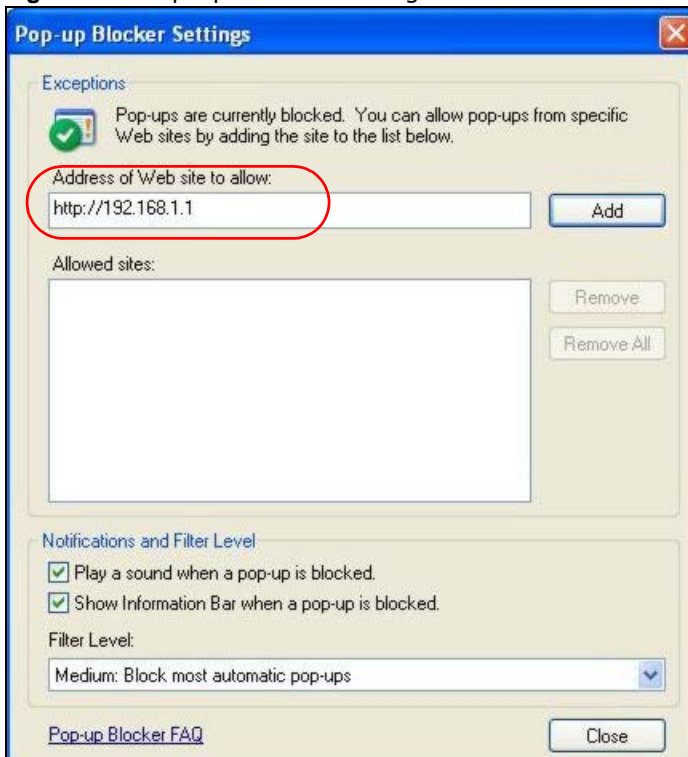
Figure 117 Pop-up Blocker Settings

- 5 Click **Close** to return to the **Privacy** screen.
- 6 Click **Apply** to save this setting.

JavaScripts

If pages of the web configurator do not display properly in Internet Explorer, check that JavaScripts are allowed.

- 1 In Internet Explorer, click **Tools**, **Internet Options** and then the **Security** tab.

Figure 118 Internet Options: Security

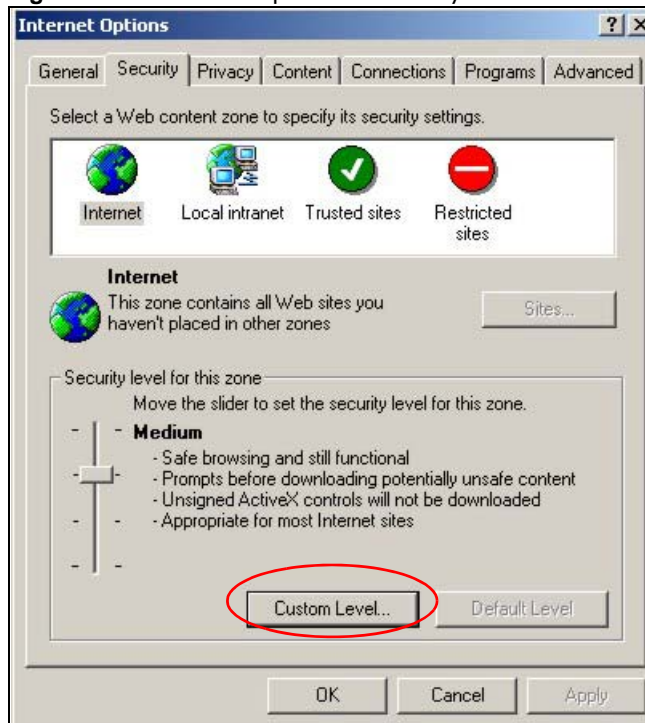

- 2 Click the **Custom Level...** button.
- 3 Scroll down to **Scripting**.
- 4 Under **Active scripting** make sure that **Enable** is selected (the default).
- 5 Under **Scripting of Java applets** make sure that **Enable** is selected (the default).
- 6 Click **OK** to close the window.

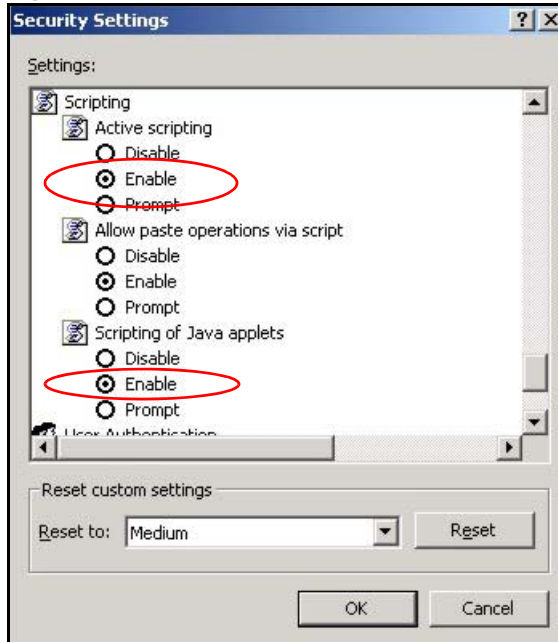
Figure 119 Security Settings - Java Scripting

Java Permissions

- 1 From Internet Explorer, click **Tools, Internet Options** and then the **Security** tab.
- 2 Click the **Custom Level...** button.
- 3 Scroll down to **Microsoft VM**.
- 4 Under **Java permissions** make sure that a safety level is selected.
- 5 Click **OK** to close the window.

Figure 120 Security Settings - Java

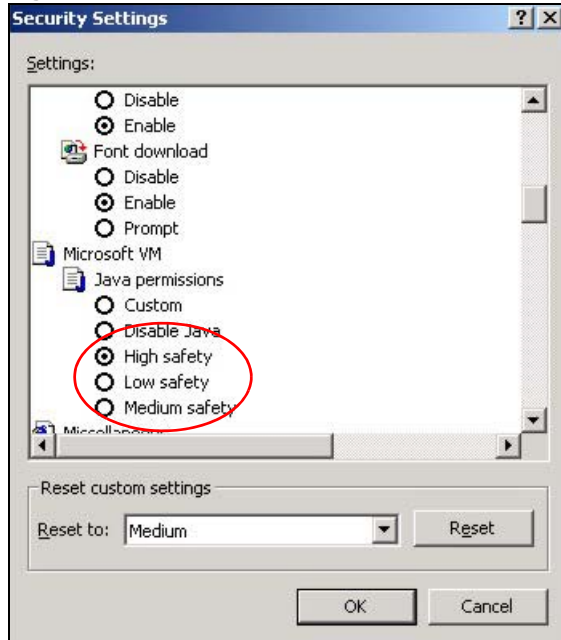

JAVA (Sun)

- 1 From Internet Explorer, click **Tools, Internet Options** and then the **Advanced** tab.
- 2 Make sure that **Use Java 2 for <applet>** under **Java (Sun)** is selected.
- 3 Click **OK** to close the window.

Figure 121 Java (Sun)

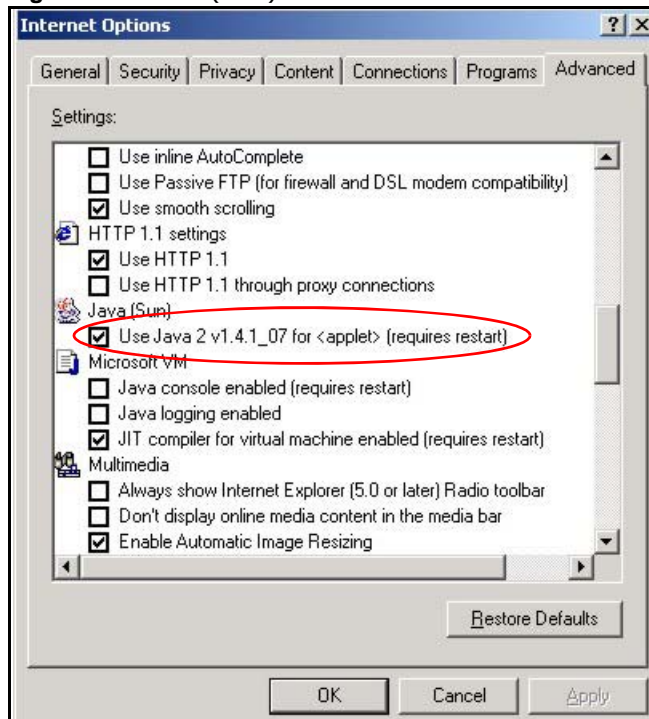

Mozilla Firefox

Mozilla Firefox 2.0 screens are used here. Screens for other versions may vary slightly. The steps below apply to Mozilla Firefox 3.0 as well.

You can enable Java, Javascripts and pop-ups in one screen. Click **Tools**, then click **Options** in the screen that appears.

Figure 122 Mozilla Firefox: TOOLS > Options

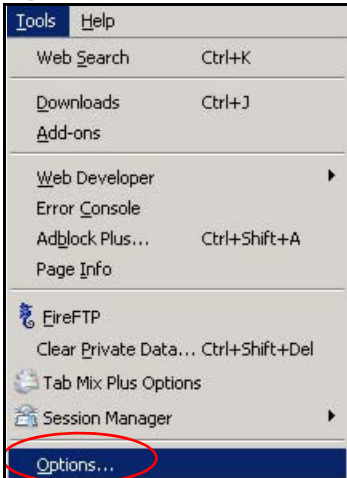

Click **Content** to show the screen below. Select the check boxes as shown in the following screen.

Figure 123 Mozilla Firefox Content Security

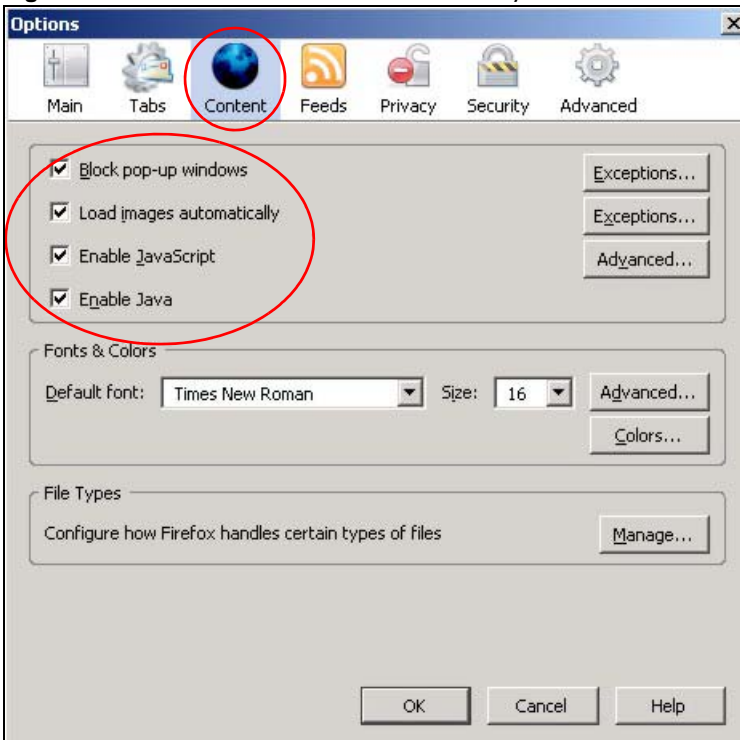

Opera

Opera 10 screens are used here. Screens for other versions may vary slightly.

Allowing Pop-Ups

From Opera, click **Tools**, then **Preferences**. In the **General** tab, go to **Choose how you prefer to handle pop-ups** and select **Open all pop-ups**.

Figure 124 Opera: Allowing Pop-Ups

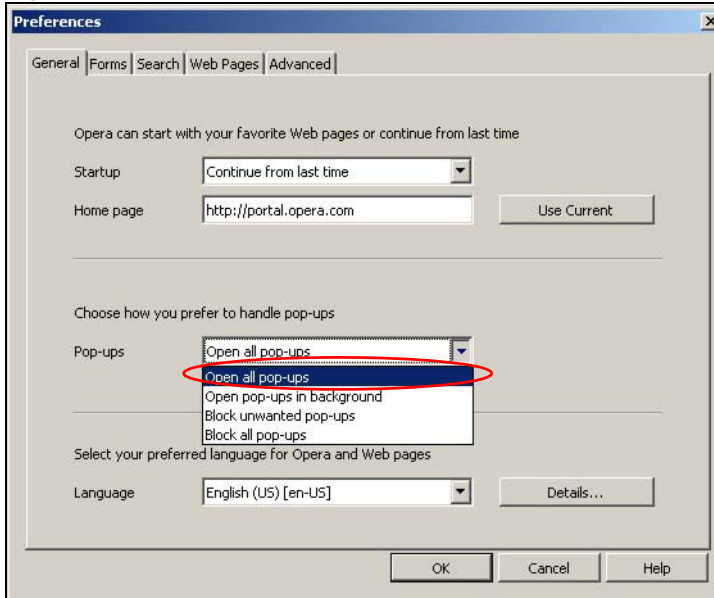

Enabling Java

From Opera, click **Tools**, then **Preferences**. In the **Advanced** tab, select **Content** from the left-side menu. Select the check boxes as shown in the following screen.

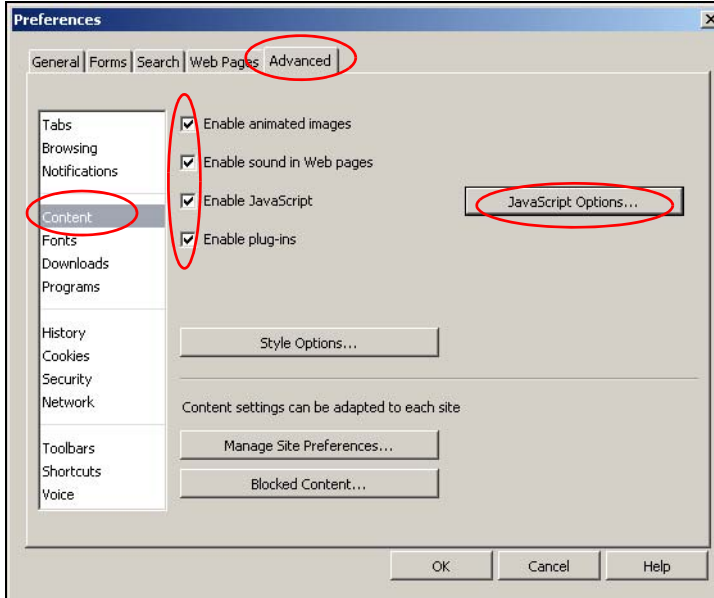
Figure 125 Opera: Enabling Java

To customize JavaScript behavior in the Opera browser, click **JavaScript Options**.

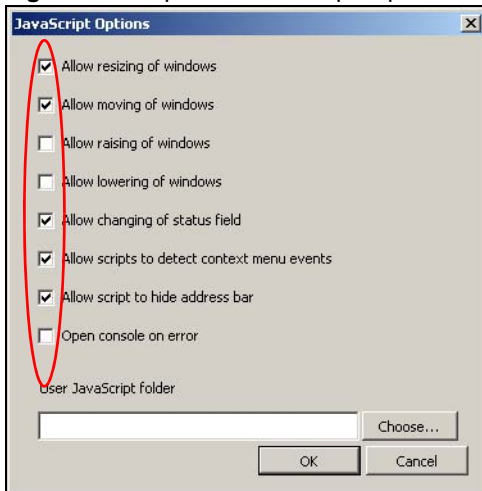
Figure 126 Opera: JavaScript Options

Select the items you want Opera's JavaScript to apply.

Setting Up Your Computer's IP Address

Note: Your specific NBG-418N may not support all of the operating systems described in this appendix. See the product specifications for more information about which operating systems are supported.

This appendix shows you how to configure the IP settings on your computer in order for it to be able to communicate with the other devices on your network. Windows Vista/XP/2000, Mac OS 9/OS X, and all versions of UNIX/LINUX include the software components you need to use TCP/IP on your computer.

If you manually assign IP information instead of using a dynamic IP, make sure that your network's computers have IP addresses that place them in the same subnet.

In this appendix, you can set up an IP address for:

- [Windows XP/NT/2000](#) on [page 167](#)
- [Windows Vista](#) on [page 171](#)
- [Windows 7](#) on [page 175](#)
- [Mac OS X: 10.3 and 10.4](#) on [page 179](#)
- [Mac OS X: 10.5 and 10.6](#) on [page 182](#)
- [Linux: Ubuntu 8 \(GNOME\)](#) on [page 185](#)
- [Linux: openSUSE 10.3 \(KDE\)](#) on [page 189](#)

Windows XP/NT/2000

The following example uses the default Windows XP display theme but can also apply to Windows 2000 and Windows NT.

- 1 Click **Start > Control Panel**.

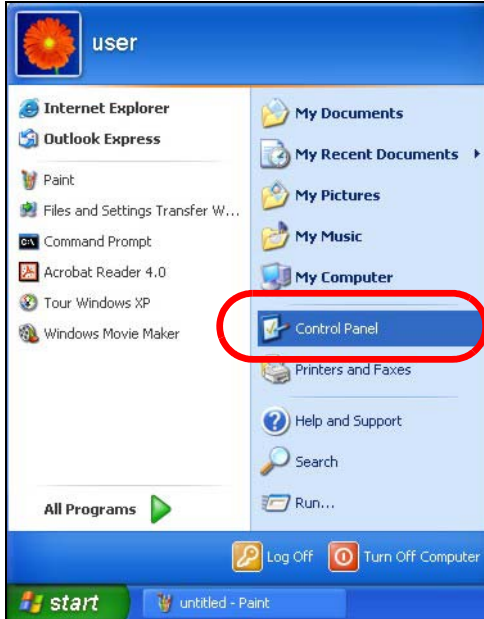

2 In the **Control Panel**, click the **Network Connections** icon.

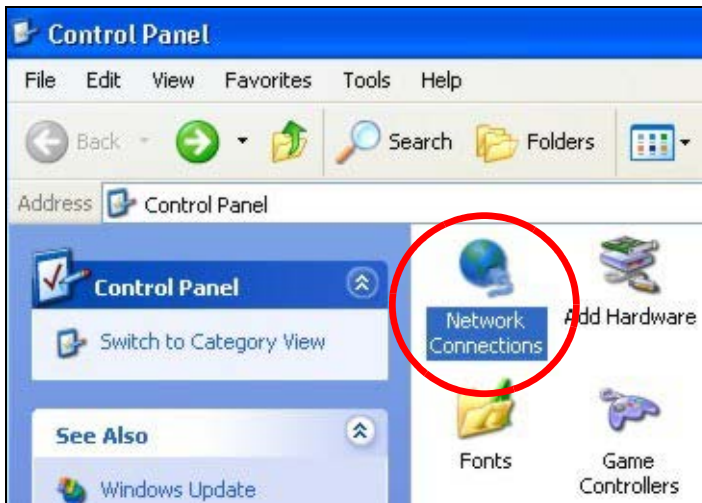

3 Right-click **Local Area Connection** and then select **Properties**.

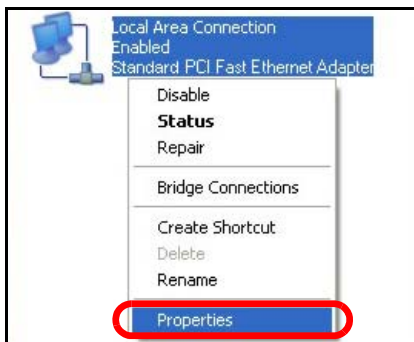

4 On the **General** tab, select **Internet Protocol (TCP/IP)** and then click **Properties**.

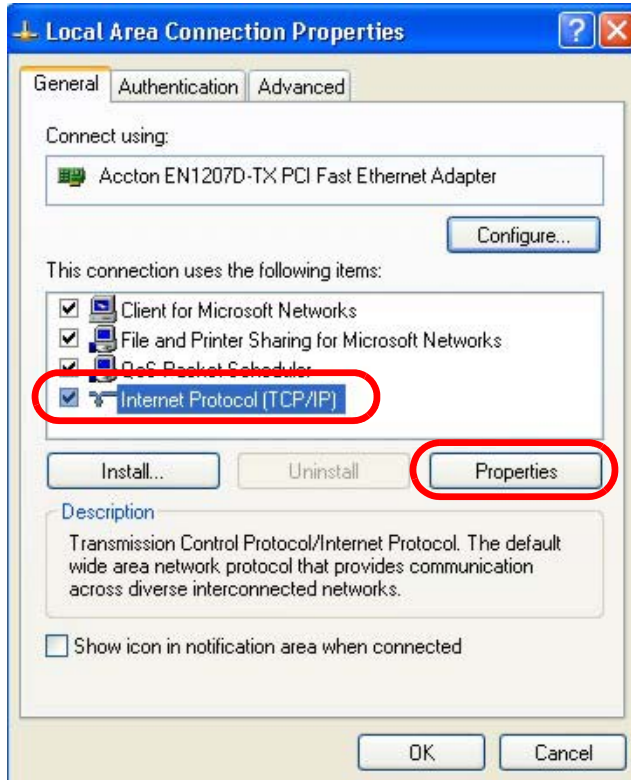

- 5 The **Internet Protocol TCP/IP Properties** window opens.

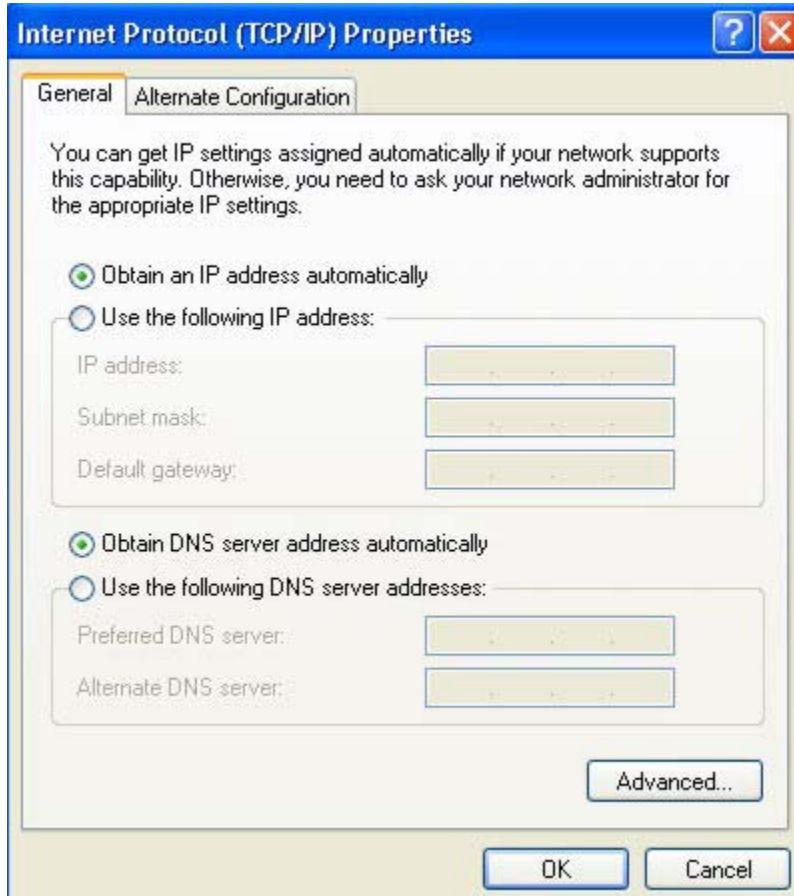

- 6 Select **Obtain an IP address automatically** if your network administrator or ISP assigns your IP address dynamically.

Select **Use the following IP Address** and fill in the **IP address**, **Subnet mask**, and **Default gateway** fields if you have a static IP address that was assigned to you by your network administrator or ISP. You may also have to enter a **Preferred DNS server** and an **Alternate DNS server**, if that information was provided.

- 7 Click **OK** to close the **Internet Protocol (TCP/IP) Properties** window.
- 8 Click **OK** to close the **Local Area Connection Properties** window.

Verifying Settings

- 1 Click **Start > All Programs > Accessories > Command Prompt**.
- 2 In the **Command Prompt** window, type "ipconfig" and then press [ENTER].

You can also go to **Start > Control Panel > Network Connections**, right-click a network connection, click **Status** and then click the **Support** tab to view your IP address and connection information.

Windows Vista

This section shows screens from Windows Vista Professional.

- 1 Click **Start > Control Panel**.

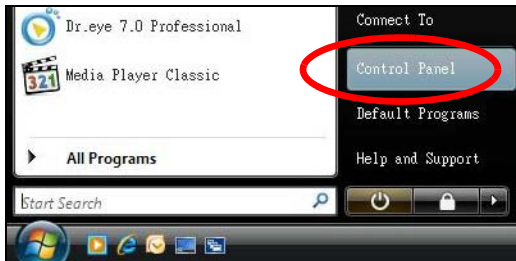

- 2 In the **Control Panel**, click the **Network and Internet** icon.

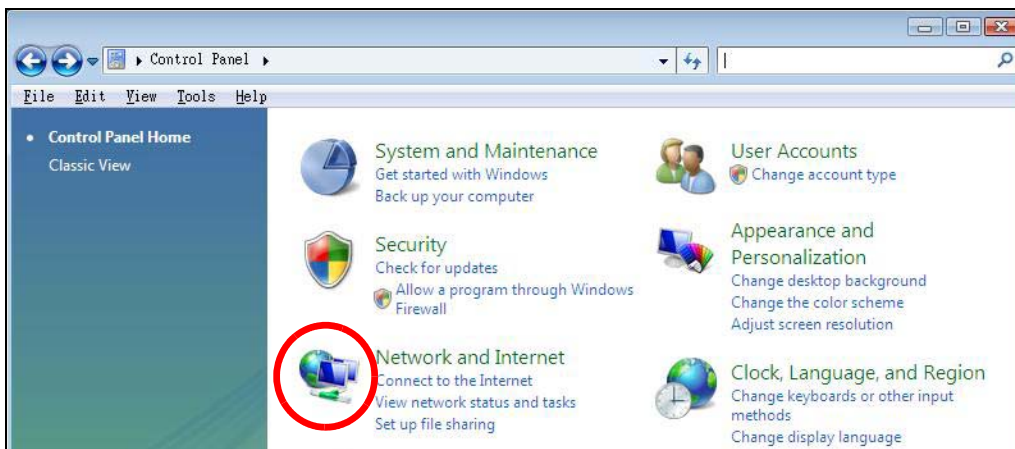

- 3 Click the **Network and Sharing Center** icon.

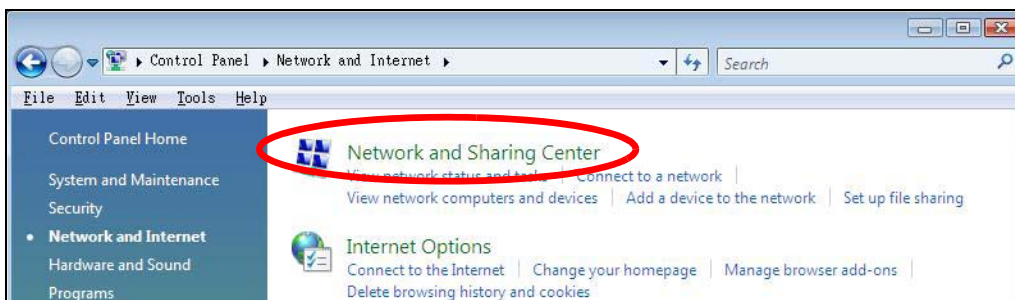

- 4 Click **Manage network connections**.

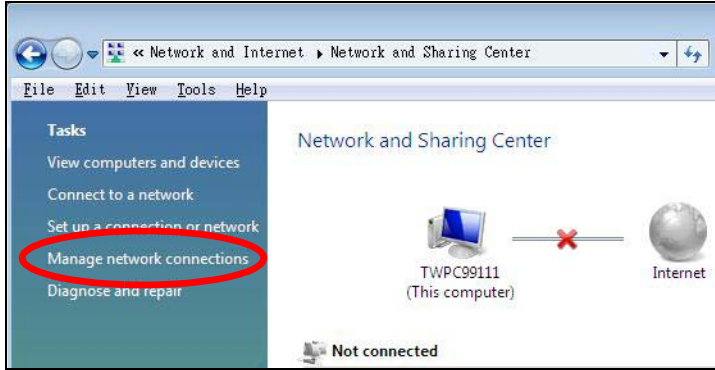

5 Right-click **Local Area Connection** and then select **Properties**.



Note: During this procedure, click **Continue** whenever Windows displays a screen saying that it needs your permission to continue.

6 Select **Internet Protocol Version 4 (TCP/IPv4)** and then select **Properties**.

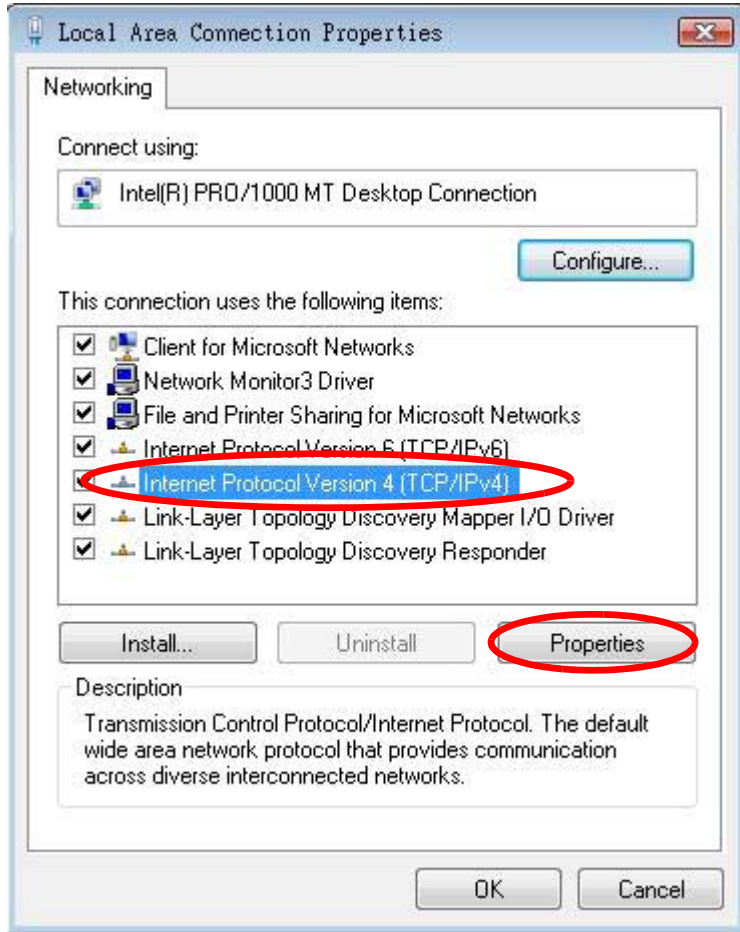

- 7 The **Internet Protocol Version 4 (TCP/IPv4) Properties** window opens.

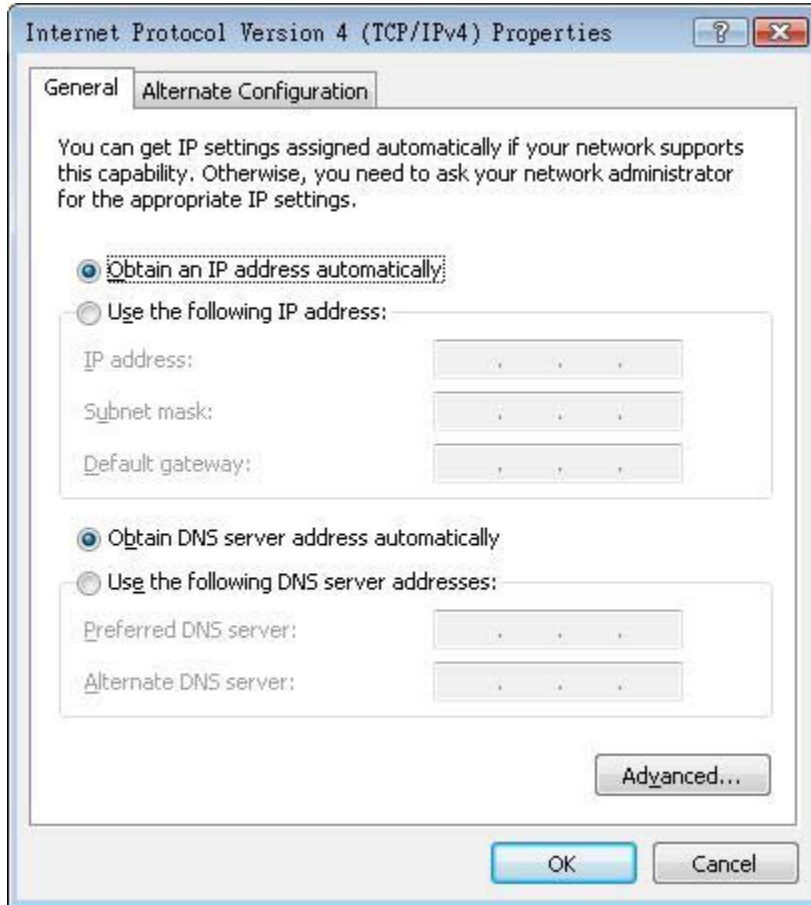

- 8 Select **Obtain an IP address automatically** if your network administrator or ISP assigns your IP address dynamically.
Select **Use the following IP Address** and fill in the **IP address**, **Subnet mask**, and **Default gateway** fields if you have a static IP address that was assigned to you by your network administrator or ISP. You may also have to enter a **Preferred DNS server** and an **Alternate DNS server**, if that information was provided. Click **Advanced**.
- 9 Click **OK** to close the **Internet Protocol (TCP/IP) Properties** window.
- 10 Click **OK** to close the **Local Area Connection Properties** window.

Verifying Settings

- 1 Click **Start > All Programs > Accessories > Command Prompt**.
- 2 In the **Command Prompt** window, type "ipconfig" and then press [ENTER].
You can also go to **Start > Control Panel > Network Connections**, right-click a network connection, click **Status** and then click the **Support** tab to view your IP address and connection information.

Windows 7

This section shows screens from Windows 7 Enterprise.

- 1 Click **Start > Control Panel**.

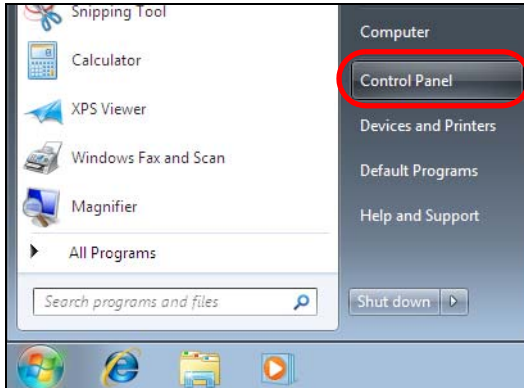

- 2 In the **Control Panel**, click **View network status and tasks** under the **Network and Internet** category.

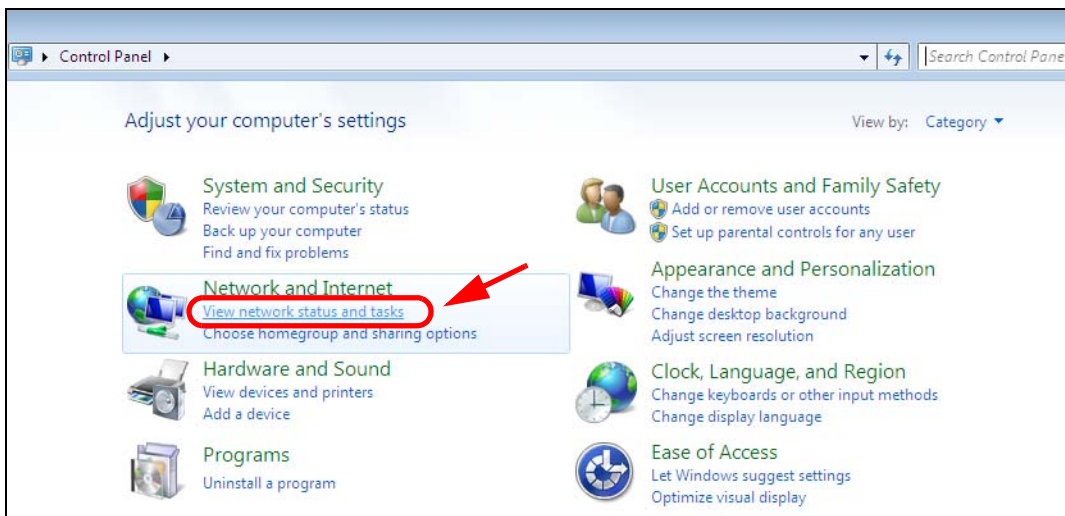

- 3 Click **Change adapter settings**.

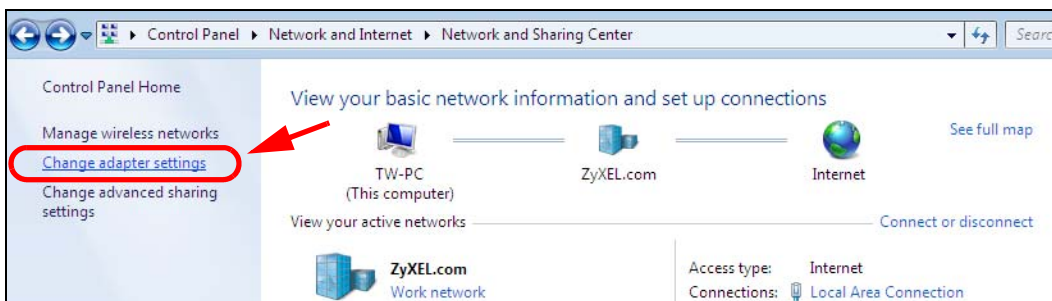

- 4 Double click **Local Area Connection** and then select **Properties**.

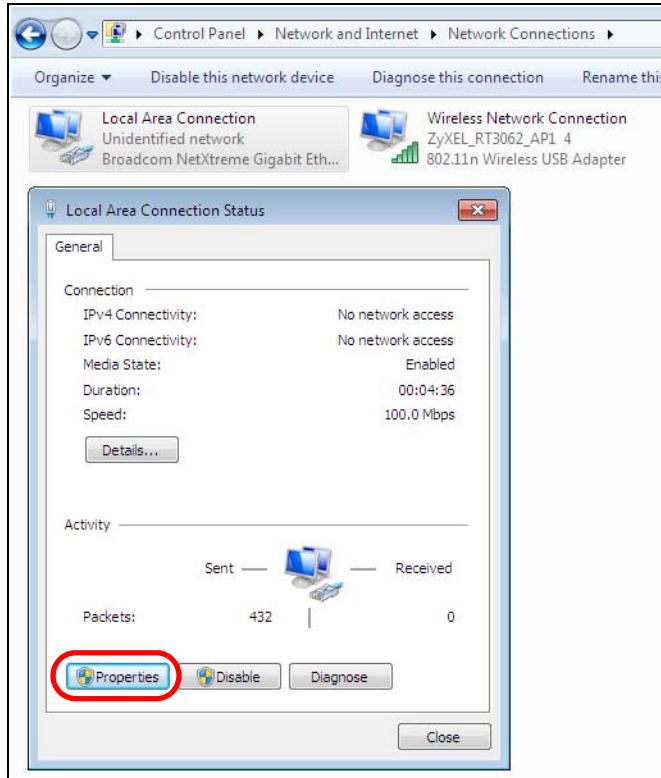

Note: During this procedure, click **Continue** whenever Windows displays a screen saying that it needs your permission to continue.

- 5 Select **Internet Protocol Version 4 (TCP/IPv4)** and then select **Properties**.

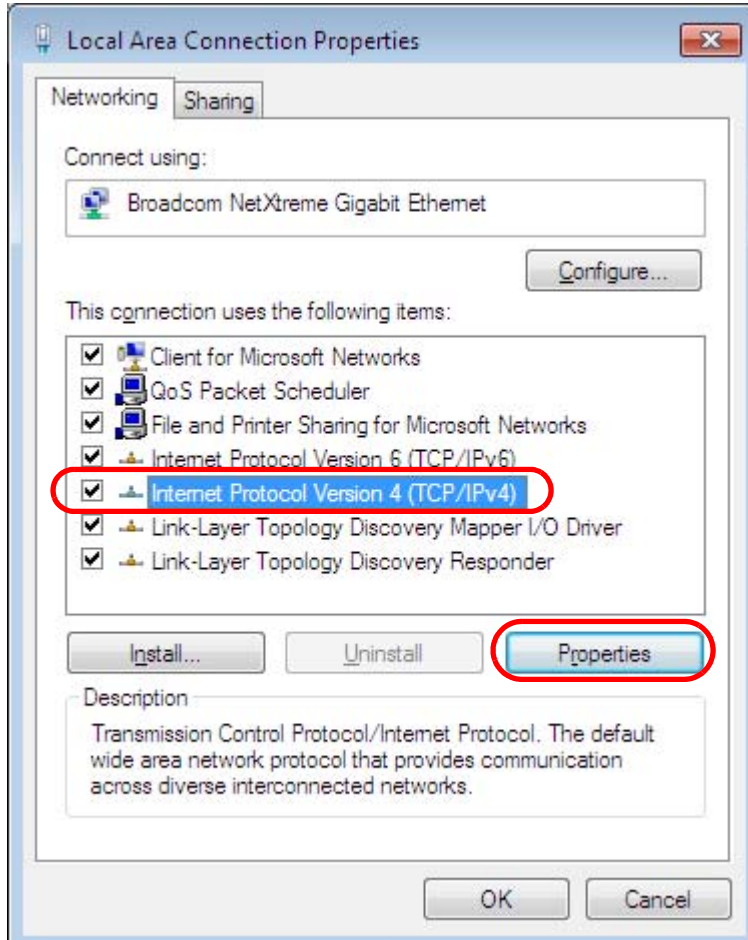

- 6 The **Internet Protocol Version 4 (TCP/IPv4) Properties** window opens.

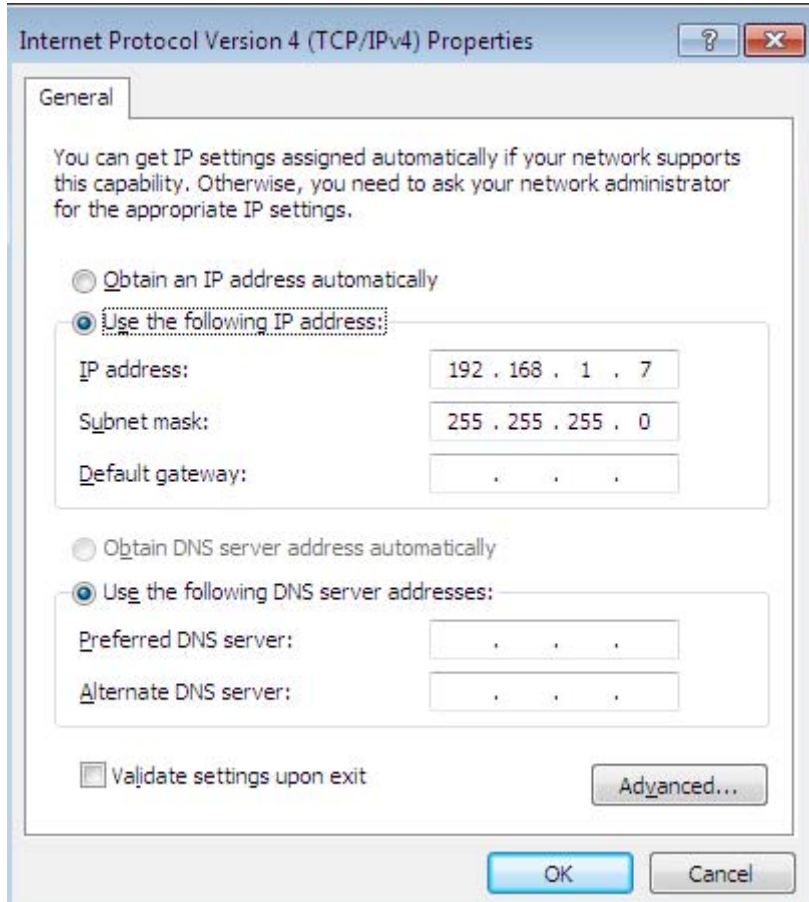

- 7 Select **Obtain an IP address automatically** if your network administrator or ISP assigns your IP address dynamically.

Select **Use the following IP Address** and fill in the **IP address**, **Subnet mask**, and **Default gateway** fields if you have a static IP address that was assigned to you by your network administrator or ISP. You may also have to enter a **Preferred DNS server** and an **Alternate DNS server**, if that information was provided. Click **Advanced** if you want to configure advanced settings for IP, DNS and WINS.

- 8 Click **OK** to close the **Internet Protocol (TCP/IP) Properties** window.
- 9 Click **OK** to close the **Local Area Connection Properties** window.

Verifying Settings

- 1 Click **Start > All Programs > Accessories > Command Prompt**.
- 2 In the **Command Prompt** window, type "ipconfig" and then press [ENTER].
- 3 The IP settings are displayed as follows.

```
C:\WINNT\system32\cmd.exe
C:\>ipconfig

Windows 2000 IP Configuration

Ethernet adapter Local Area Connection:

    Connection-specific DNS Suffix  . : P-2612HNU-F3v2
    IP Address. . . . . : 192.168.1.7
    Subnet Mask . . . . . : 255.255.255.0
    Default Gateway . . . . . : 192.168.1.1

C:\>
```

Mac OS X: 10.3 and 10.4

The screens in this section are from Mac OS X 10.4 but can also apply to 10.3.

- 1 Click **Apple** > **System Preferences**.

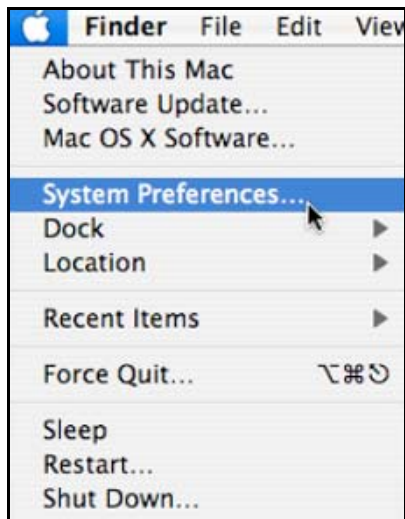

- 2 In the **System Preferences** window, click the **Network** icon.



- 3 When the **Network** preferences pane opens, select **Built-in Ethernet** from the network connection type list, and then click **Configure**.

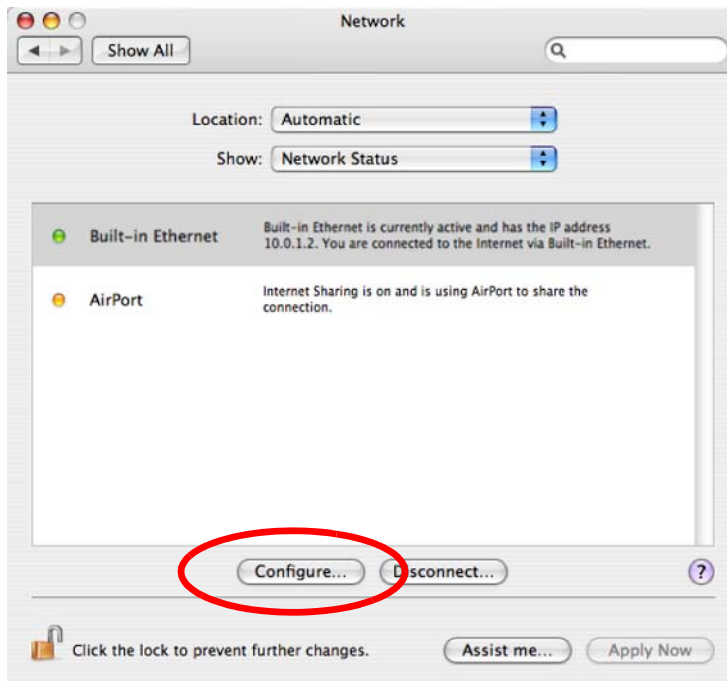

- 4 For dynamically assigned settings, select **Using DHCP** from the **Configure IPv4** list in the **TCP/IP** tab.

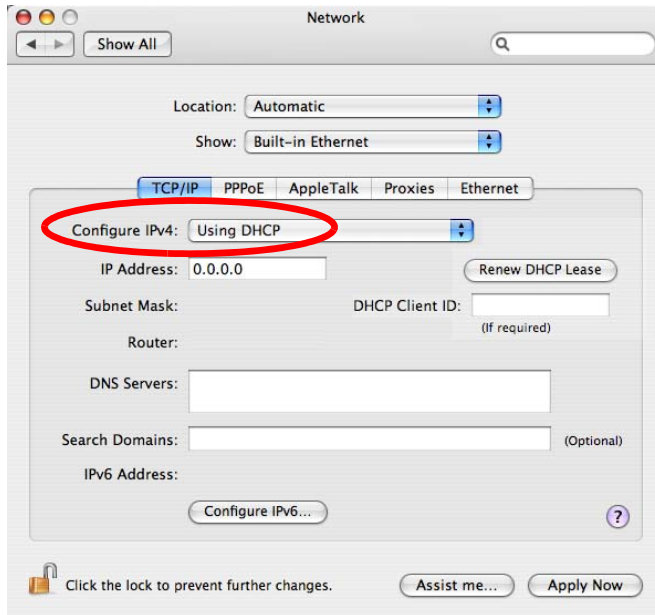

- 5 For statically assigned settings, do the following:
 - From the **Configure IPv4** list, select **Manually**.
 - In the **IP Address** field, type your IP address.
 - In the **Subnet Mask** field, type your subnet mask.
 - In the **Router** field, type the IP address of your device.

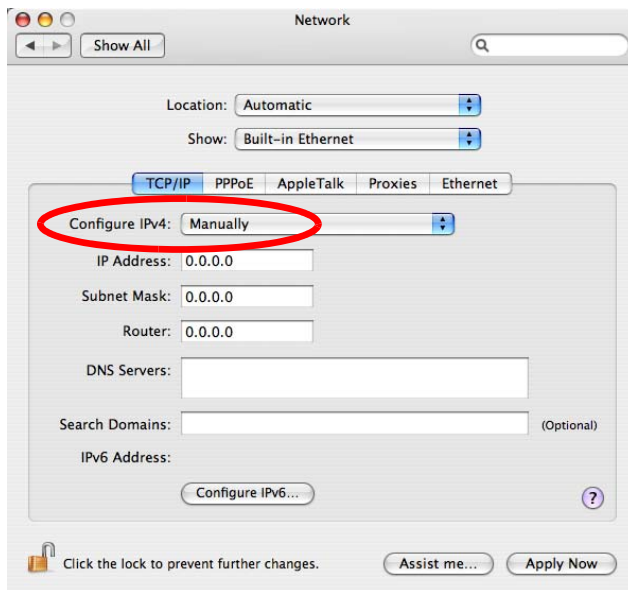

- 6 Click **Apply Now** and close the window.

Verifying Settings

Check your TCP/IP properties by clicking **Applications > Utilities > Network Utilities**, and then selecting the appropriate **Network Interface** from the **Info** tab.

Figure 127 Mac OS X 10.4: Network Utility

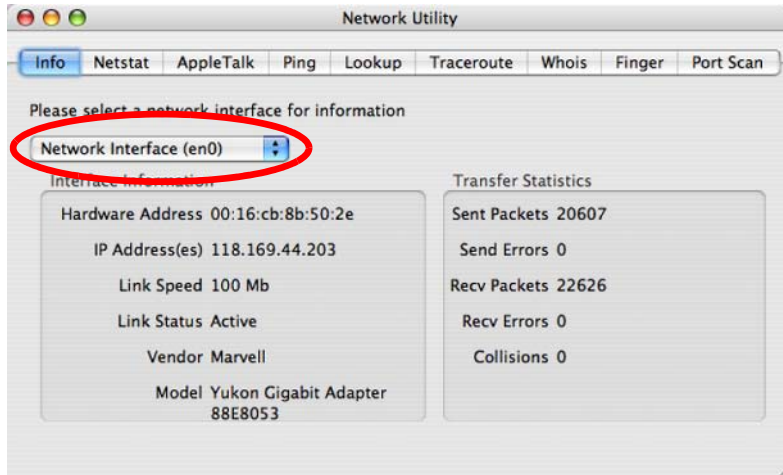

Mac OS X: 10.5 and 10.6

The screens in this section are from Mac OS X 10.5 but can also apply to 10.6.

- 1 Click **Apple** > **System Preferences**.

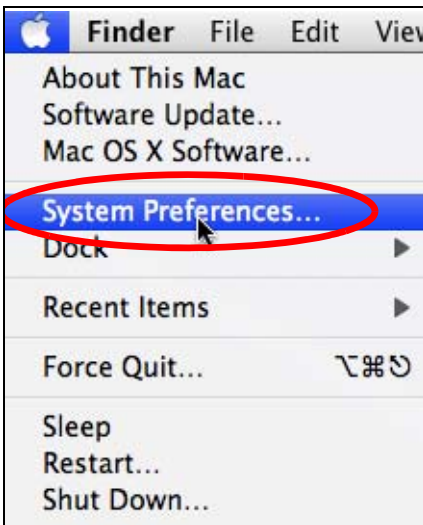

- 2 In **System Preferences**, click the **Network** icon.



- 3 When the **Network** preferences pane opens, select **Ethernet** from the list of available connection types.

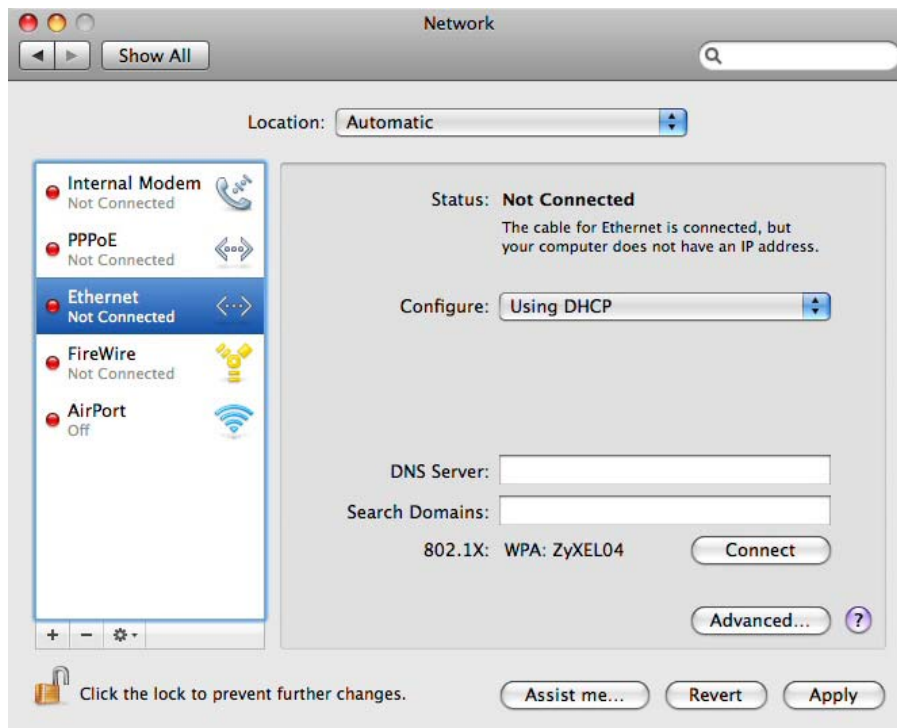

- 4 From the **Configure** list, select **Using DHCP** for dynamically assigned settings.
- 5 For statically assigned settings, do the following:
 - From the **Configure** list, select **Manually**.

- In the **IP Address** field, enter your IP address.
- In the **Subnet Mask** field, enter your subnet mask.
- In the **Router** field, enter the IP address of your NBG-418N.

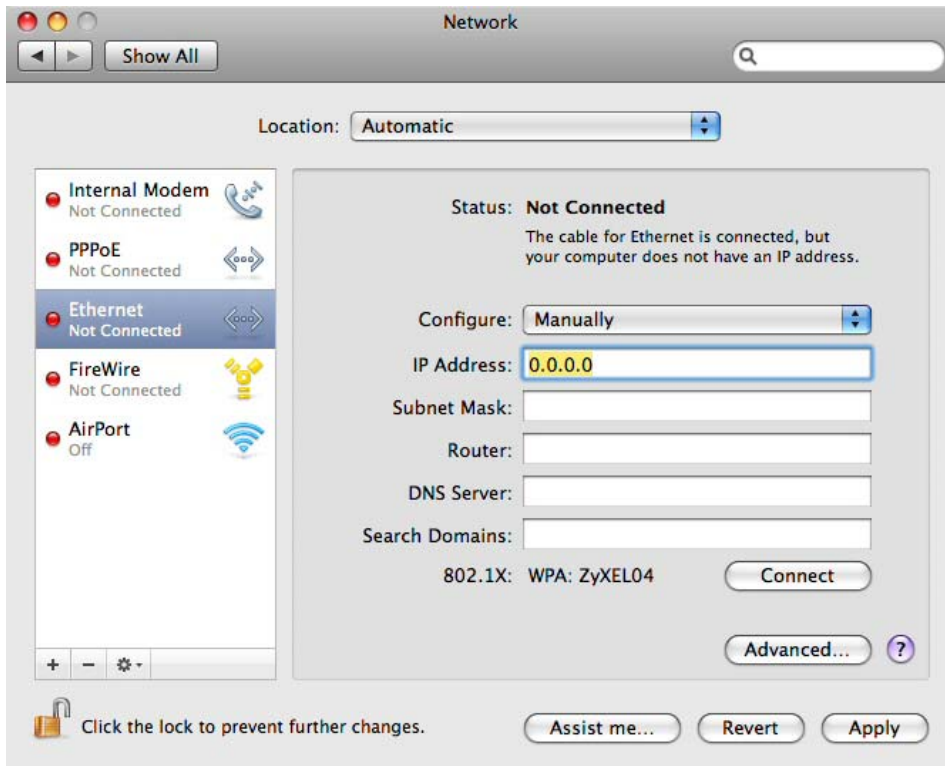

- 6 Click **Apply** and close the window.

Verifying Settings

Check your TCP/IP properties by clicking **Applications > Utilities > Network Utilities**, and then selecting the appropriate **Network interface** from the **Info** tab.

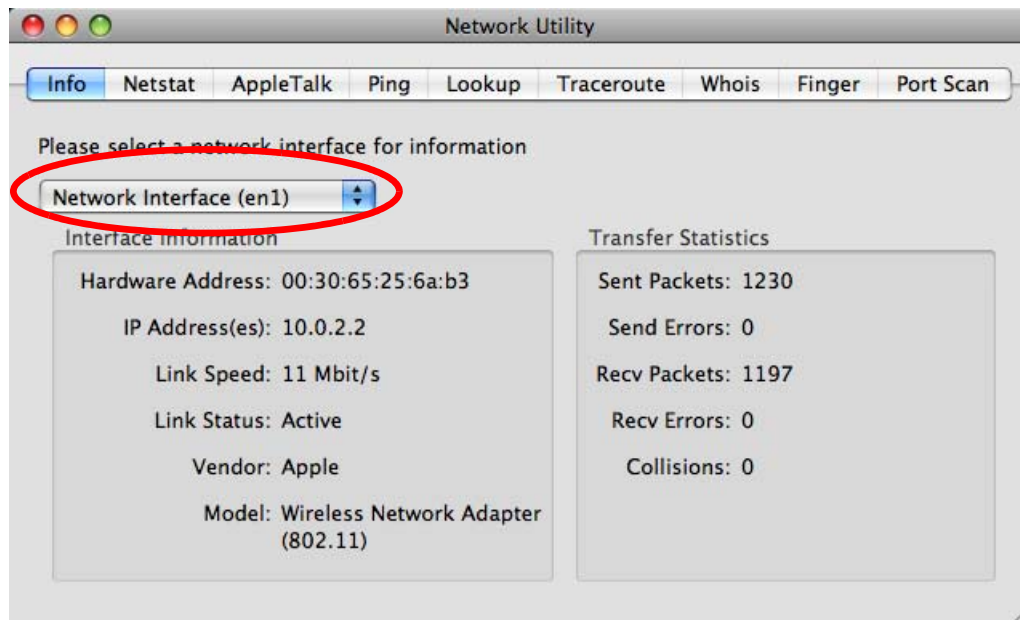
Figure 128 Mac OS X 10.5: Network Utility

Linux: Ubuntu 8 (GNOME)

This section shows you how to configure your computer's TCP/IP settings in the GNU Object Model Environment (GNOME) using the Ubuntu 8 Linux distribution. The procedure, screens and file locations may vary depending on your specific distribution, release version, and individual configuration. The following screens use the default Ubuntu 8 installation.

Note: Make sure you are logged in as the root administrator.

Follow the steps below to configure your computer IP address in GNOME:

- 1 Click **System > Administration > Network**.

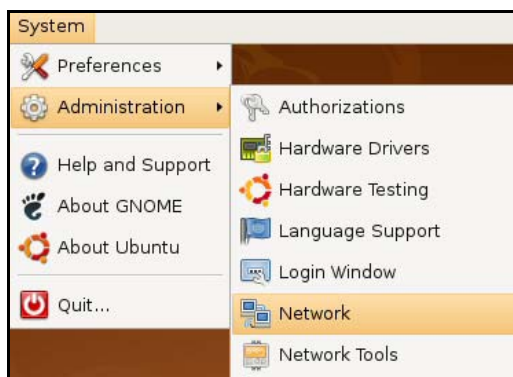

- 2 When the **Network Settings** window opens, click **Unlock** to open the **Authenticate** window. (By default, the **Unlock** button is greyed out until clicked.) You cannot make changes to your configuration unless you first enter your admin password.



- 3 In the **Authenticate** window, enter your admin account name and password then click the **Authenticate** button.



- 4 In the **Network Settings** window, select the connection that you want to configure, then click **Properties**.



- 5 The **Properties** dialog box opens.



- In the **Configuration** list, select **Automatic Configuration (DHCP)** if you have a dynamic IP address.
 - In the **Configuration** list, select **Static IP address** if you have a static IP address. Fill in the **IP address**, **Subnet mask**, and **Gateway address** fields.
- 6 Click **OK** to save the changes and close the **Properties** dialog box and return to the **Network Settings** screen.
- 7 If you know your DNS server IP address(es), click the **DNS** tab in the **Network Settings** window and then enter the DNS server information in the fields provided.



- 8 Click the **Close** button to apply the changes.

Verifying Settings

Check your TCP/IP properties by clicking **System > Administration > Network Tools**, and then selecting the appropriate **Network device** from the **Devices** tab. The **Interface Statistics** column shows data if your connection is working properly.

Figure 129 Ubuntu 8: Network Tools

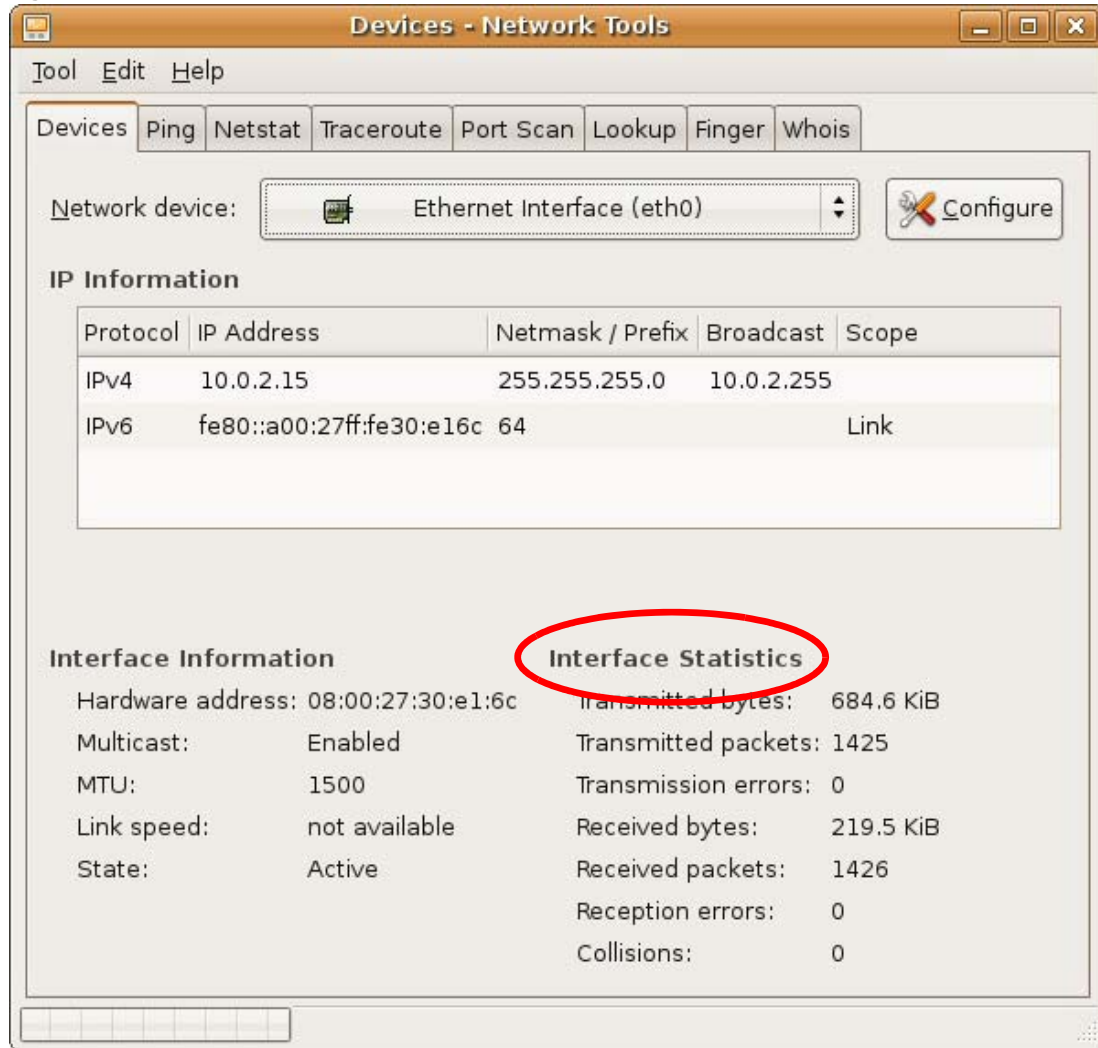

Linux: openSUSE 10.3 (KDE)

This section shows you how to configure your computer's TCP/IP settings in the K Desktop Environment (KDE) using the openSUSE 10.3 Linux distribution. The procedure, screens and file locations may vary depending on your specific distribution, release version, and individual configuration. The following screens use the default openSUSE 10.3 installation.

Note: Make sure you are logged in as the root administrator.

Follow the steps below to configure your computer IP address in the KDE:

- 1 Click **K Menu > Computer > Administrator Settings (YaST)**.

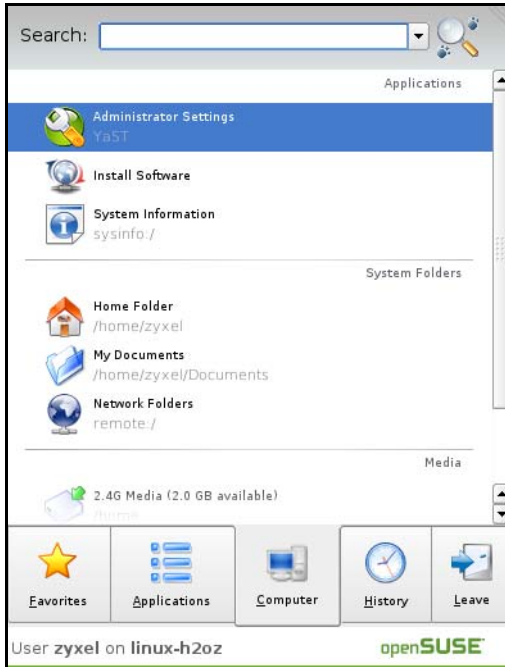

- 2 When the **Run as Root - KDE su** dialog opens, enter the admin password and click **OK**.

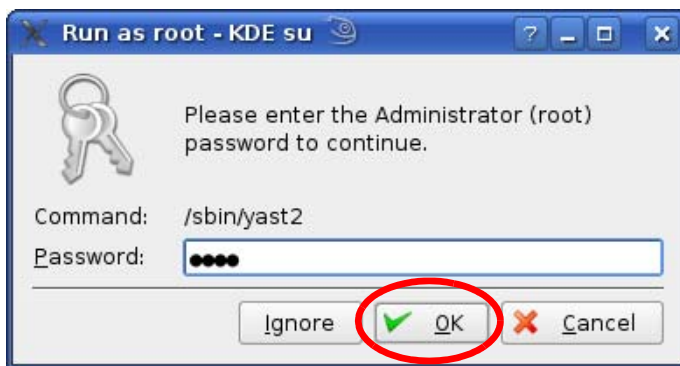

- 3 When the **YaST Control Center** window opens, select **Network Devices** and then click the **Network Card** icon.

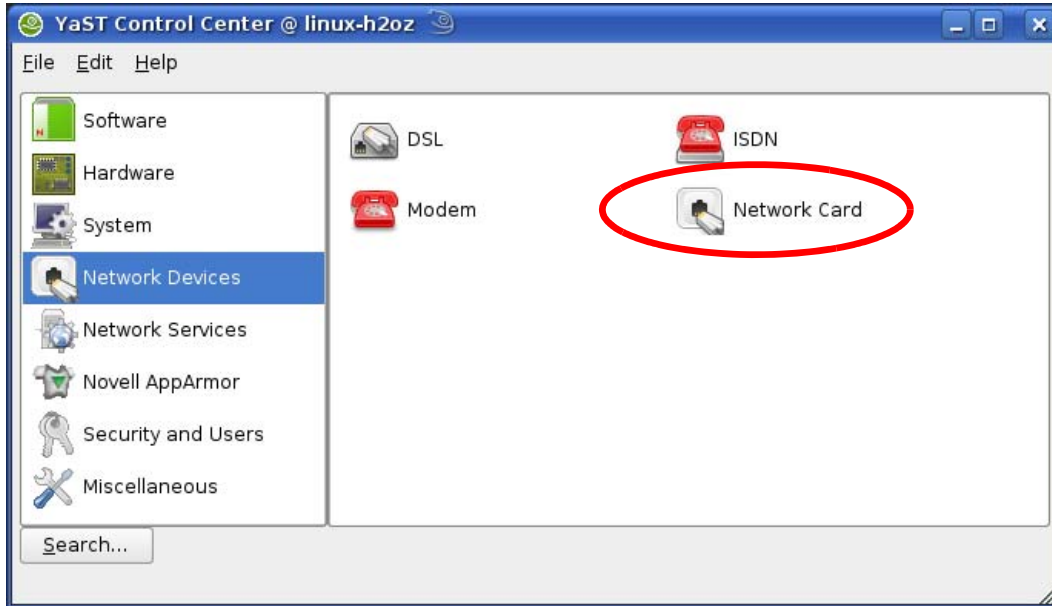

- 4 When the **Network Settings** window opens, click the **Overview** tab, select the appropriate connection **Name** from the list, and then click the **Configure** button.

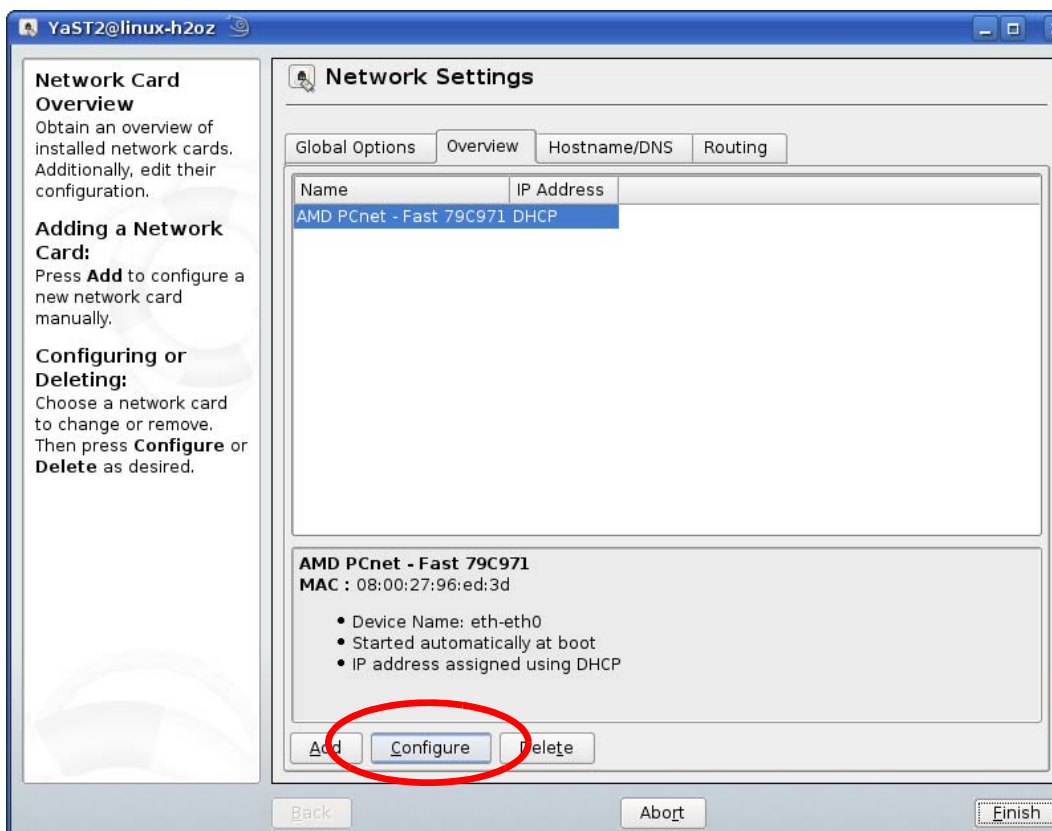

- 5 When the **Network Card Setup** window opens, click the **Address** tab

Figure 130 openSUSE 10.3: Network Card Setup

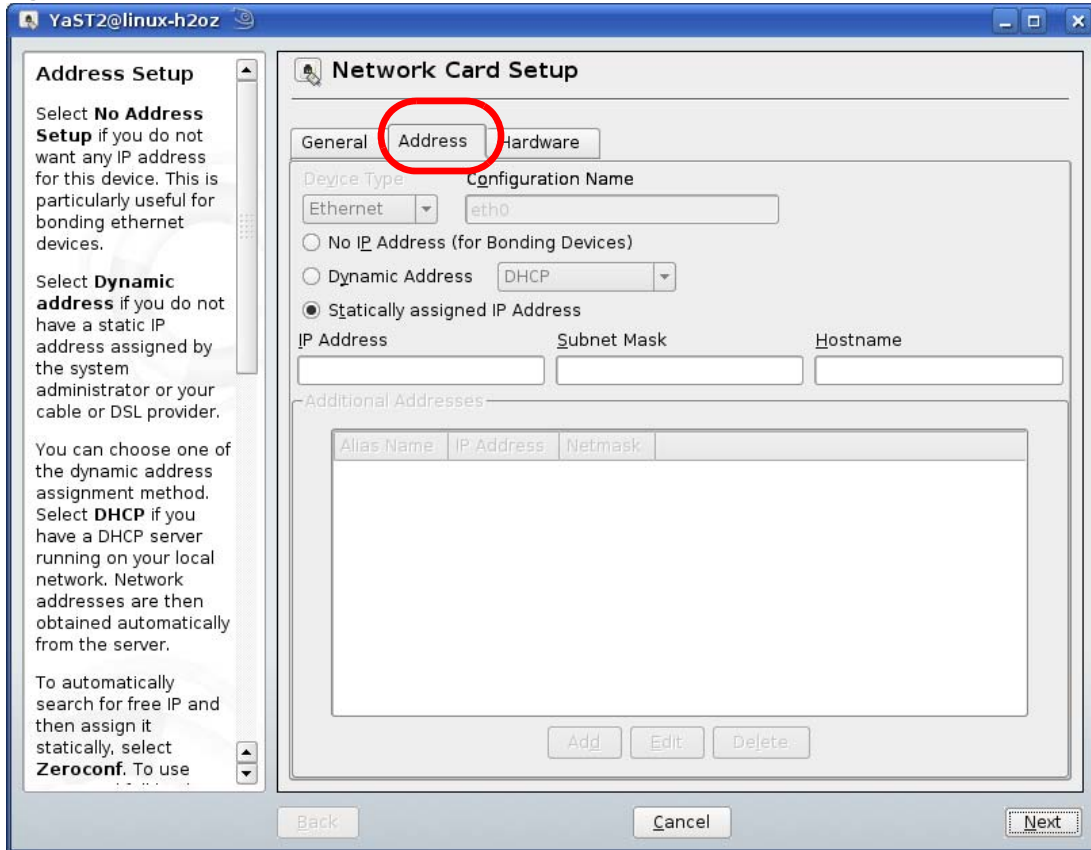

- 6 Select **Dynamic Address (DHCP)** if you have a dynamic IP address. Select **Statically assigned IP Address** if you have a static IP address. Fill in the **IP address**, **Subnet mask**, and **Hostname** fields.
- 7 Click **Next** to save the changes and close the **Network Card Setup** window.
- 8 If you know your DNS server IP address(es), click the **Hostname/DNS** tab in **Network Settings** and then enter the DNS server information in the fields provided.

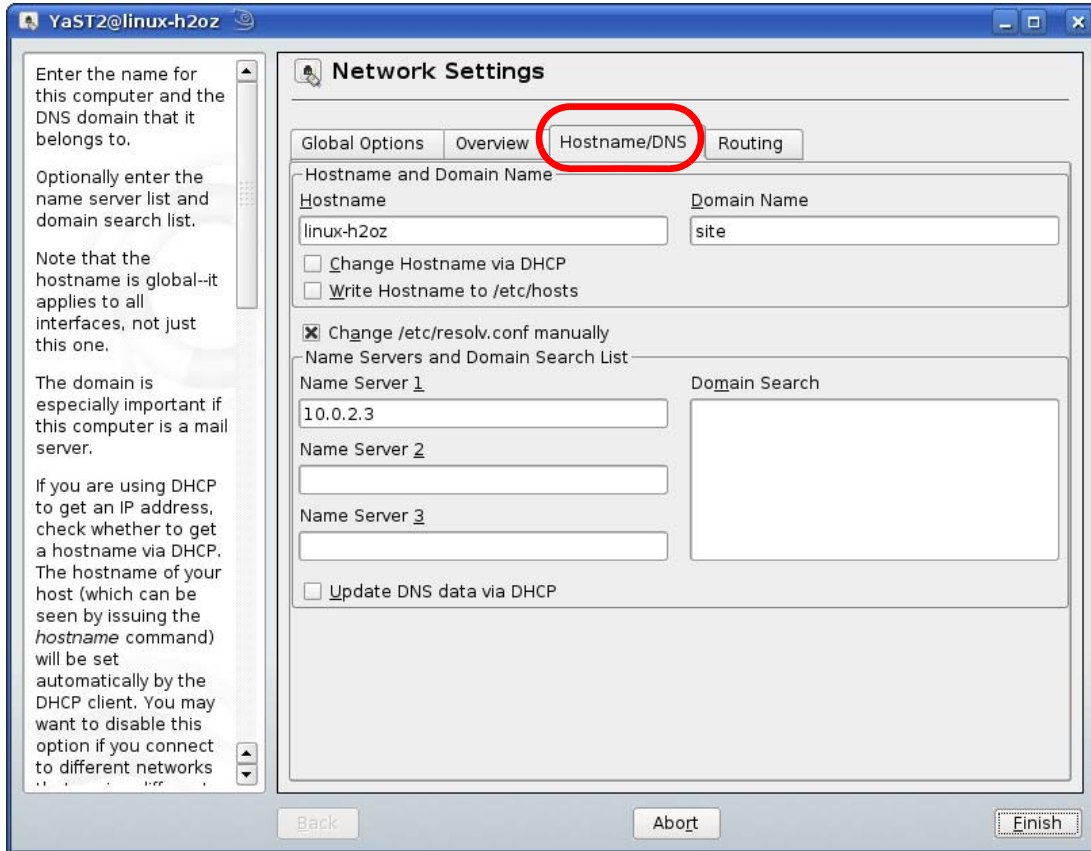

- 9 Click **Finish** to save your settings and close the window.

Verifying Settings

Click the **KNetwork Manager** icon on the **Task bar** to check your TCP/IP properties. From the **Options** sub-menu, select **Show Connection Information**.

Figure 131 openSUSE 10.3: KNetwork Manager

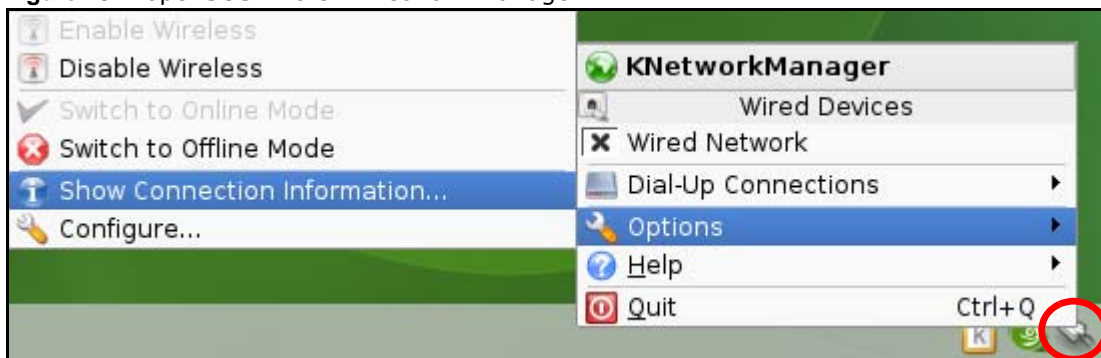

When the **Connection Status - KNetwork Manager** window opens, click the **Statistics** tab to see if your connection is working properly.

Figure 132 openSUSE: Connection Status - KNetwork Manager

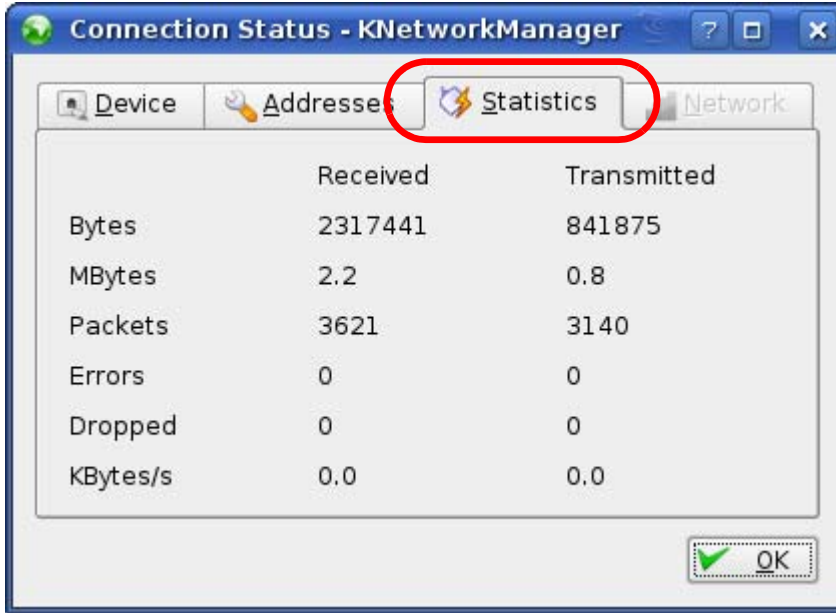

Wireless LANs

Wireless LAN Topologies

This section discusses ad-hoc and infrastructure wireless LAN topologies.

Ad-hoc Wireless LAN Configuration

The simplest WLAN configuration is an independent (Ad-hoc) WLAN that connects a set of computers with wireless adapters (A, B, C). Any time two or more wireless adapters are within range of each other, they can set up an independent network, which is commonly referred to as an ad-hoc network or Independent Basic Service Set (IBSS). The following diagram shows an example of notebook computers using wireless adapters to form an ad-hoc wireless LAN.

Figure 133 Peer-to-Peer Communication in an Ad-hoc Network

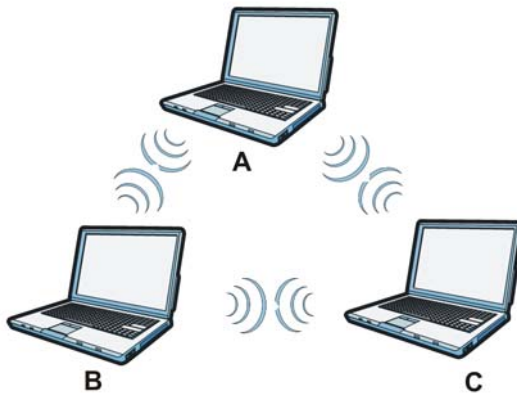

BSS

A Basic Service Set (BSS) exists when all communications between wireless clients or between a wireless client and a wired network client go through one access point (AP).

Intra-BSS traffic is traffic between wireless clients in the BSS. When Intra-BSS is enabled, wireless client **A** and **B** can access the wired network and communicate with each other. When Intra-BSS is disabled, wireless client **A** and **B** can still access the wired network but cannot communicate with each other.

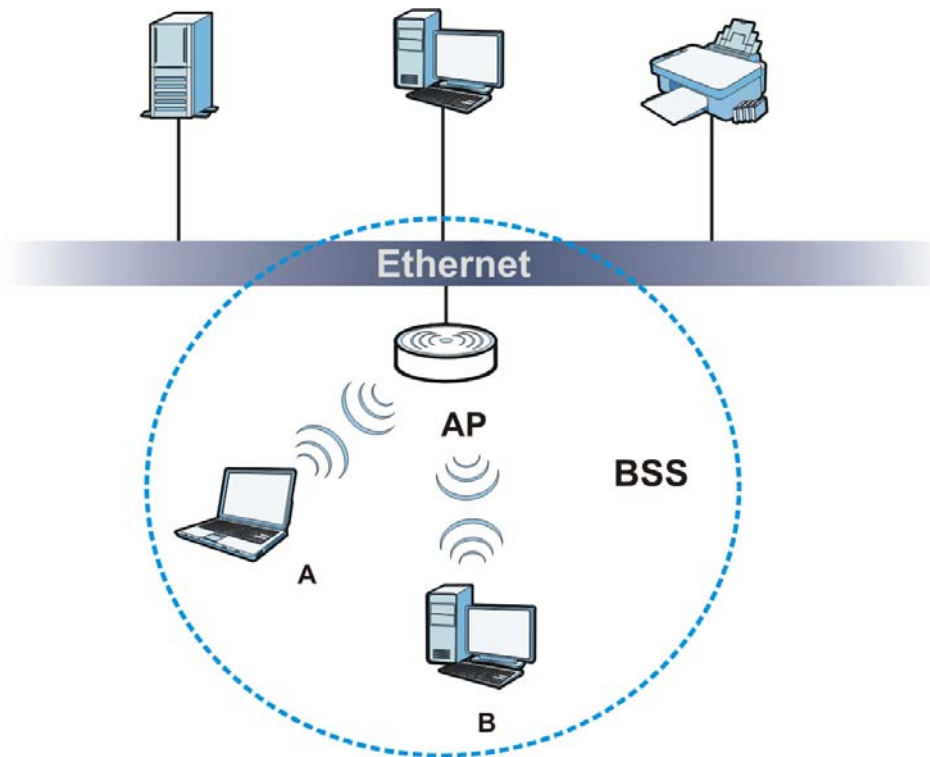
Figure 134 Basic Service Set

ESS

An Extended Service Set (ESS) consists of a series of overlapping BSSs, each containing an access point, with each access point connected together by a wired network. This wired connection between APs is called a Distribution System (DS).

This type of wireless LAN topology is called an Infrastructure WLAN. The Access Points not only provide communication with the wired network but also mediate wireless network traffic in the immediate neighborhood.

An ESSID (ESS Identification) uniquely identifies each ESS. All access points and their associated wireless clients within the same ESS must have the same ESSID in order to communicate.

Figure 135 Infrastructure WLAN

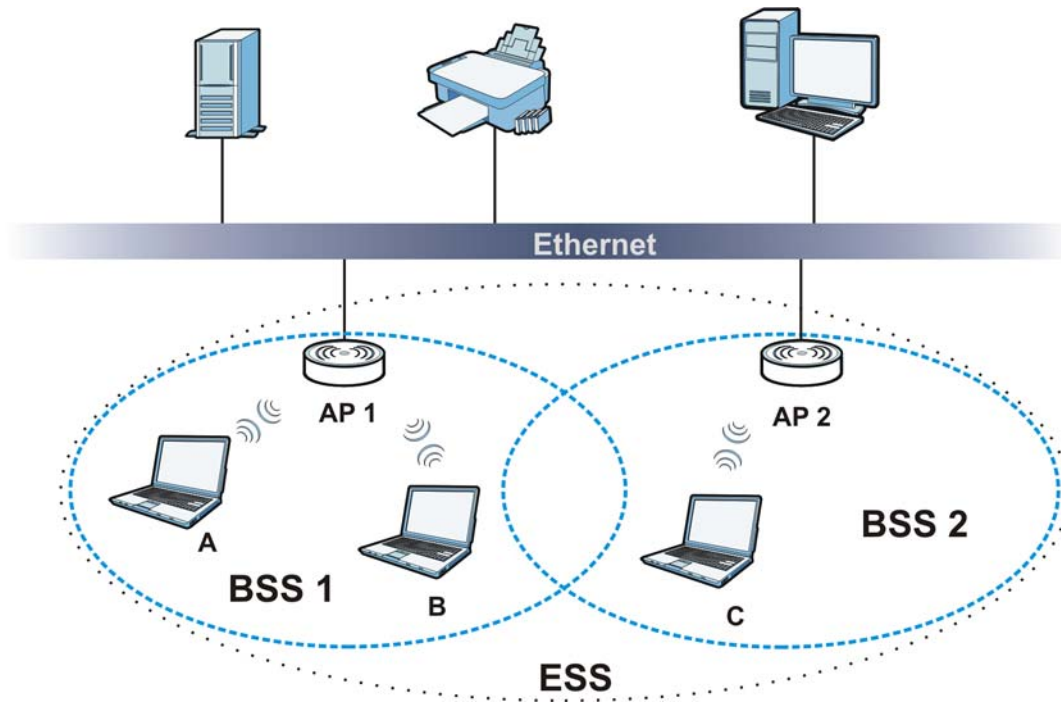

Channel

A channel is the radio frequency(ies) used by wireless devices to transmit and receive data. Channels available depend on your geographical area. You may have a choice of channels (for your region) so you should use a channel different from an adjacent AP (access point) to reduce interference. Interference occurs when radio signals from different access points overlap causing interference and degrading performance.

Adjacent channels partially overlap however. To avoid interference due to overlap, your AP should be on a channel at least five channels away from a channel that an adjacent AP is using. For example, if your region has 11 channels and an adjacent AP is using channel 1, then you need to select a channel between 6 or 11.

RTS/CTS

A hidden node occurs when two stations are within range of the same access point, but are not within range of each other. The following figure illustrates a hidden node. Both stations (STA) are within range of the access point (AP) or wireless gateway, but out-of-range of each other, so they cannot "hear" each other, that is they do not know if the channel is currently being used. Therefore, they are considered hidden from each other.

Figure 136 RTS/CTS

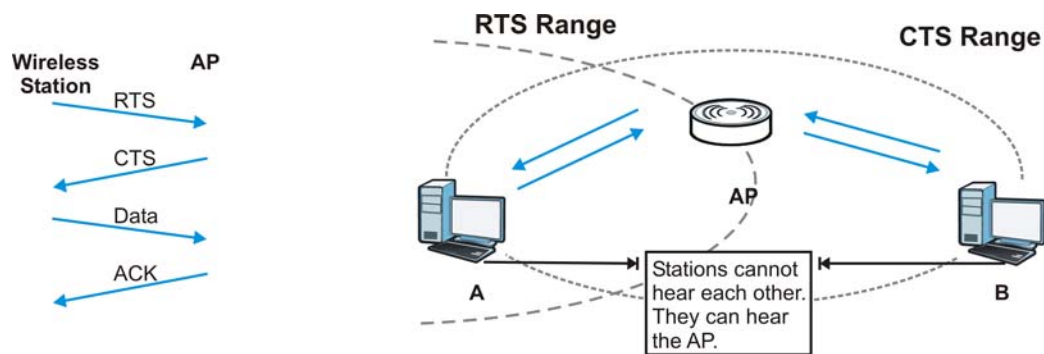

When station **A** sends data to the AP, it might not know that the station **B** is already using the channel. If these two stations send data at the same time, collisions may occur when both sets of data arrive at the AP at the same time, resulting in a loss of messages for both stations.

RTS/CTS is designed to prevent collisions due to hidden nodes. An **RTS/CTS** defines the biggest size data frame you can send before an RTS (Request To Send)/CTS (Clear to Send) handshake is invoked.

When a data frame exceeds the **RTS/CTS** value you set (between 0 to 2432 bytes), the station that wants to transmit this frame must first send an RTS (Request To Send) message to the AP for permission to send it. The AP then responds with a CTS (Clear to Send) message to all other stations within its range to notify them to defer their transmission. It also reserves and confirms with the requesting station the time frame for the requested transmission.

Stations can send frames smaller than the specified **RTS/CTS** directly to the AP without the RTS (Request To Send)/CTS (Clear to Send) handshake.

You should only configure **RTS/CTS** if the possibility of hidden nodes exists on your network and the "cost" of resending large frames is more than the extra network overhead involved in the RTS (Request To Send)/CTS (Clear to Send) handshake.

If the **RTS/CTS** value is greater than the **Fragmentation Threshold** value (see next), then the RTS (Request To Send)/CTS (Clear to Send) handshake will never occur as data frames will be fragmented before they reach **RTS/CTS** size.

Note: Enabling the RTS Threshold causes redundant network overhead that could negatively affect the throughput performance instead of providing a remedy.

Fragmentation Threshold

A **Fragmentation Threshold** is the maximum data fragment size (between 256 and 2432 bytes) that can be sent in the wireless network before the AP will fragment the packet into smaller data frames.

A large **Fragmentation Threshold** is recommended for networks not prone to interference while you should set a smaller threshold for busy networks or networks that are prone to interference.

If the **Fragmentation Threshold** value is smaller than the **RTS/CTS** value (see previously) you set then the RTS (Request To Send)/CTS (Clear to Send) handshake will never occur as data frames will be fragmented before they reach **RTS/CTS** size.

Preamble Type

Preamble is used to signal that data is coming to the receiver. Short and long refer to the length of the synchronization field in a packet.

Short preamble increases performance as less time sending preamble means more time for sending data. All IEEE 802.11 compliant wireless adapters support long preamble, but not all support short preamble.

Use long preamble if you are unsure what preamble mode other wireless devices on the network support, and to provide more reliable communications in busy wireless networks.

Use short preamble if you are sure all wireless devices on the network support it, and to provide more efficient communications.

Use the dynamic setting to automatically use short preamble when all wireless devices on the network support it, otherwise the NBG-418N uses long preamble.

Note: The wireless devices **MUST** use the same preamble mode in order to communicate.

IEEE 802.11g Wireless LAN

IEEE 802.11g is fully compatible with the IEEE 802.11b standard. This means an IEEE 802.11b adapter can interface directly with an IEEE 802.11g access point (and vice versa) at 11 Mbps or lower depending on range. IEEE 802.11g has several intermediate rate steps between the maximum and minimum data rates. The IEEE 802.11g data rate and modulation are as follows:

Table 70 IEEE 802.11g

DATA RATE (MBPS)	MODULATION
1	DBPSK (Differential Binary Phase Shift Keyed)
2	DQPSK (Differential Quadrature Phase Shift Keying)
5.5 / 11	CCK (Complementary Code Keying)
6/9/12/18/24/36/48/ 54	OFDM (Orthogonal Frequency Division Multiplexing)

Wireless Security Overview

Wireless security is vital to your network to protect wireless communication between wireless clients, access points and the wired network.

Wireless security methods available on the NBG-418N are data encryption, wireless client authentication, restricting access by device MAC address and hiding the NBG-418N identity.

The following figure shows the relative effectiveness of these wireless security methods available on your NBG-418N.

Table 71 Wireless Security Levels

SECURITY LEVEL	SECURITY TYPE
Least Secure	Unique SSID (Default)
	Unique SSID with Hide SSID Enabled
	MAC Address Filtering
	WEP Encryption
	IEEE802.1x EAP with RADIUS Server Authentication
	Wi-Fi Protected Access (WPA)
Most Secure	WPA2

Note: You must enable the same wireless security settings on the NBG-418N and on all wireless clients that you want to associate with it.

IEEE 802.1x

In June 2001, the IEEE 802.1x standard was designed to extend the features of IEEE 802.11 to support extended authentication as well as providing additional accounting and control features. It is supported by Windows XP and a number of network devices. Some advantages of IEEE 802.1x are:

- User based identification that allows for roaming.
- Support for RADIUS (Remote Authentication Dial In User Service, RFC 2138, 2139) for centralized user profile and accounting management on a network RADIUS server.
- Support for EAP (Extensible Authentication Protocol, RFC 2486) that allows additional authentication methods to be deployed with no changes to the access point or the wireless clients.

RADIUS

RADIUS is based on a client-server model that supports authentication, authorization and accounting. The access point is the client and the server is the RADIUS server. The RADIUS server handles the following tasks:

- Authentication
Determines the identity of the users.
- Authorization
Determines the network services available to authenticated users once they are connected to the network.
- Accounting
Keeps track of the client's network activity.

RADIUS is a simple package exchange in which your AP acts as a message relay between the wireless client and the network RADIUS server.

Types of RADIUS Messages

The following types of RADIUS messages are exchanged between the access point and the RADIUS server for user authentication:

- Access-Request
Sent by an access point requesting authentication.
- Access-Reject
Sent by a RADIUS server rejecting access.
- Access-Accept
Sent by a RADIUS server allowing access.
- Access-Challenge
Sent by a RADIUS server requesting more information in order to allow access. The access point sends a proper response from the user and then sends another Access-Request message.

The following types of RADIUS messages are exchanged between the access point and the RADIUS server for user accounting:

- Accounting-Request
Sent by the access point requesting accounting.
- Accounting-Response
Sent by the RADIUS server to indicate that it has started or stopped accounting.

In order to ensure network security, the access point and the RADIUS server use a shared secret key, which is a password, they both know. The key is not sent over the network. In addition to the shared key, password information exchanged is also encrypted to protect the network from unauthorized access.

Types of EAP Authentication

This section discusses some popular authentication types: EAP-MD5, EAP-TLS, EAP-TTLS, PEAP and LEAP. Your wireless LAN device may not support all authentication types.

EAP (Extensible Authentication Protocol) is an authentication protocol that runs on top of the IEEE 802.1x transport mechanism in order to support multiple types of user authentication. By using EAP to interact with an EAP-compatible RADIUS server, an access point helps a wireless station and a RADIUS server perform authentication.

The type of authentication you use depends on the RADIUS server and an intermediary AP(s) that supports IEEE 802.1x. .

For EAP-TLS authentication type, you must first have a wired connection to the network and obtain the certificate(s) from a certificate authority (CA). A certificate (also called digital IDs) can be used to authenticate users and a CA issues certificates and guarantees the identity of each certificate owner.

EAP-MD5 (Message-Digest Algorithm 5)

MD5 authentication is the simplest one-way authentication method. The authentication server sends a challenge to the wireless client. The wireless client 'proves' that it knows the password by encrypting the password with the challenge and sends back the information. Password is not sent in plain text.

However, MD5 authentication has some weaknesses. Since the authentication server needs to get the plaintext passwords, the passwords must be stored. Thus someone other than the authentication server may access the password file. In addition, it is possible to impersonate an authentication server as MD5 authentication method does not perform mutual authentication. Finally, MD5 authentication method does not support data encryption with dynamic session key. You must configure WEP encryption keys for data encryption.

EAP-TLS (Transport Layer Security)

With EAP-TLS, digital certifications are needed by both the server and the wireless clients for mutual authentication. The server presents a certificate to the client. After validating the identity of the server, the client sends a different certificate to the server. The exchange of certificates is done in the open before a secured tunnel is created. This makes user identity vulnerable to passive attacks. A digital certificate is an electronic ID card that authenticates the sender's identity. However, to implement EAP-TLS, you need a Certificate Authority (CA) to handle certificates, which imposes a management overhead.

EAP-TTLS (Tunneled Transport Layer Service)

EAP-TTLS is an extension of the EAP-TLS authentication that uses certificates for only the server-side authentications to establish a secure connection. Client authentication is then done by sending username and password through the secure connection, thus client identity is protected. For client authentication, EAP-TTLS supports EAP methods and legacy authentication methods such as PAP, CHAP, MS-CHAP and MS-CHAP v2.

PEAP (Protected EAP)

Like EAP-TTLS, server-side certificate authentication is used to establish a secure connection, then use simple username and password methods through the secured connection to authenticate the clients, thus hiding client identity. However, PEAP only supports EAP methods, such as EAP-MD5, EAP-MSCHAPv2 and EAP-GTC (EAP-Generic Token Card), for client authentication. EAP-GTC is implemented only by Cisco.

LEAP

LEAP (Lightweight Extensible Authentication Protocol) is a Cisco implementation of IEEE 802.1x.

Dynamic WEP Key Exchange

The AP maps a unique key that is generated with the RADIUS server. This key expires when the wireless connection times out, disconnects or reauthentication times out. A new WEP key is generated each time reauthentication is performed.

If this feature is enabled, it is not necessary to configure a default encryption key in the wireless security configuration screen. You may still configure and store keys, but they will not be used while dynamic WEP is enabled.

Note: EAP-MD5 cannot be used with Dynamic WEP Key Exchange

For added security, certificate-based authentications (EAP-TLS, EAP-TTLS and PEAP) use dynamic keys for data encryption. They are often deployed in corporate environments, but for public deployment, a simple user name and password pair is more practical. The following table is a comparison of the features of authentication types.

Table 72 Comparison of EAP Authentication Types

	EAP-MD5	EAP-TLS	EAP-TTLS	PEAP	LEAP
Mutual Authentication	No	Yes	Yes	Yes	Yes
Certificate – Client	No	Yes	Optional	Optional	No
Certificate – Server	No	Yes	Yes	Yes	No
Dynamic Key Exchange	No	Yes	Yes	Yes	Yes
Credential Integrity	None	Strong	Strong	Strong	Moderate
Deployment Difficulty	Easy	Hard	Moderate	Moderate	Moderate
Client Identity Protection	No	No	Yes	Yes	No

WPA and WPA2

Wi-Fi Protected Access (WPA) is a subset of the IEEE 802.11i standard. WPA2 (IEEE 802.11i) is a wireless security standard that defines stronger encryption, authentication and key management than WPA.

Key differences between WPA or WPA2 and WEP are improved data encryption and user authentication.

If both an AP and the wireless clients support WPA2 and you have an external RADIUS server, use WPA2 for stronger data encryption. If you don't have an external RADIUS server, you should use WPA2-PSK (WPA2-Pre-Shared Key) that only requires a single (identical) password entered into each access point, wireless gateway and wireless client. As long as the passwords match, a wireless client will be granted access to a WLAN.

If the AP or the wireless clients do not support WPA2, just use WPA or WPA-PSK depending on whether you have an external RADIUS server or not.

Select WEP only when the AP and/or wireless clients do not support WPA or WPA2. WEP is less secure than WPA or WPA2.

Encryption

WPA improves data encryption by using Temporal Key Integrity Protocol (TKIP), Message Integrity Check (MIC) and IEEE 802.1x. WPA2 also uses TKIP when required for compatibility reasons, but offers stronger encryption than TKIP with Advanced Encryption Standard (AES) in the Counter mode with Cipher block chaining Message authentication code Protocol (CCMP).

TKIP uses 128-bit keys that are dynamically generated and distributed by the authentication server. AES (Advanced Encryption Standard) is a block cipher that uses a 256-bit mathematical algorithm

called Rijndael. They both include a per-packet key mixing function, a Message Integrity Check (MIC) named Michael, an extended initialization vector (IV) with sequencing rules, and a re-keying mechanism.

WPA and WPA2 regularly change and rotate the encryption keys so that the same encryption key is never used twice.

The RADIUS server distributes a Pairwise Master Key (PMK) key to the AP that then sets up a key hierarchy and management system, using the PMK to dynamically generate unique data encryption keys to encrypt every data packet that is wirelessly communicated between the AP and the wireless clients. This all happens in the background automatically.

The Message Integrity Check (MIC) is designed to prevent an attacker from capturing data packets, altering them and resending them. The MIC provides a strong mathematical function in which the receiver and the transmitter each compute and then compare the MIC. If they do not match, it is assumed that the data has been tampered with and the packet is dropped.

By generating unique data encryption keys for every data packet and by creating an integrity checking mechanism (MIC), with TKIP and AES it is more difficult to decrypt data on a Wi-Fi network than WEP and difficult for an intruder to break into the network.

The encryption mechanisms used for WPA(2) and WPA(2)-PSK are the same. The only difference between the two is that WPA(2)-PSK uses a simple common password, instead of user-specific credentials. The common-password approach makes WPA(2)-PSK susceptible to brute-force password-guessing attacks but it's still an improvement over WEP as it employs a consistent, single, alphanumeric password to derive a PMK which is used to generate unique temporal encryption keys. This prevents all wireless devices sharing the same encryption keys. (a weakness of WEP)

User Authentication

WPA and WPA2 apply IEEE 802.1x and Extensible Authentication Protocol (EAP) to authenticate wireless clients using an external RADIUS database. WPA2 reduces the number of key exchange messages from six to four (CCMP 4-way handshake) and shortens the time required to connect to a network. Other WPA2 authentication features that are different from WPA include key caching and pre-authentication. These two features are optional and may not be supported in all wireless devices.

Key caching allows a wireless client to store the PMK it derived through a successful authentication with an AP. The wireless client uses the PMK when it tries to connect to the same AP and does not need to go through the authentication process again.

Pre-authentication enables fast roaming by allowing the wireless client (already connecting to an AP) to perform IEEE 802.1x authentication with another AP before connecting to it.

Wireless Client WPA Supplicants

A wireless client supplicant is the software that runs on an operating system instructing the wireless client how to use WPA. At the time of writing, the most widely available supplicant is the WPA patch for Windows XP, Funk Software's Odyssey client.

The Windows XP patch is a free download that adds WPA capability to Windows XP's built-in "Zero Configuration" wireless client. However, you must run Windows XP to use it.

WPA(2) with RADIUS Application Example

To set up WPA(2), you need the IP address of the RADIUS server, its port number (default is 1812), and the RADIUS shared secret. A WPA(2) application example with an external RADIUS server looks as follows. "A" is the RADIUS server. "DS" is the distribution system.

- 1 The AP passes the wireless client's authentication request to the RADIUS server.
- 2 The RADIUS server then checks the user's identification against its database and grants or denies network access accordingly.
- 3 A 256-bit Pairwise Master Key (PMK) is derived from the authentication process by the RADIUS server and the client.
- 4 The RADIUS server distributes the PMK to the AP. The AP then sets up a key hierarchy and management system, using the PMK to dynamically generate unique data encryption keys. The keys are used to encrypt every data packet that is wirelessly communicated between the AP and the wireless clients.

Figure 137 WPA(2) with RADIUS Application Example

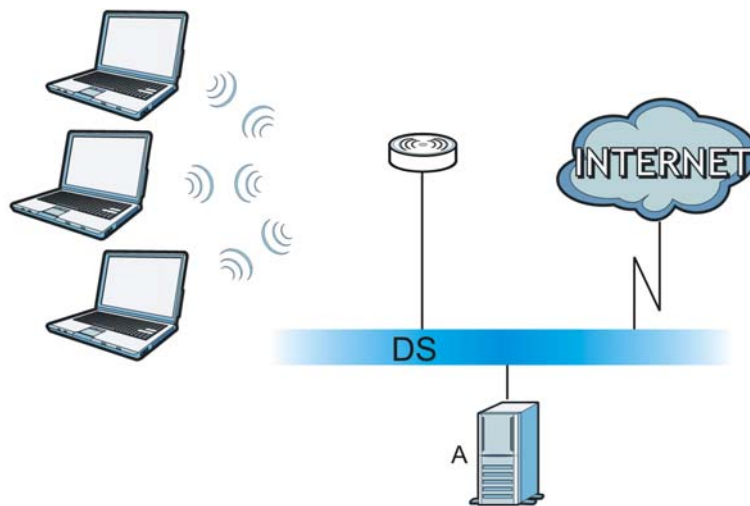

WPA(2)-PSK Application Example

A WPA(2)-PSK application looks as follows.

- 1 First enter identical passwords into the AP and all wireless clients. The Pre-Shared Key (PSK) must consist of between 8 and 63 ASCII characters or 64 hexadecimal characters (including spaces and symbols).
- 2 The AP checks each wireless client's password and allows it to join the network only if the password matches.
- 3 The AP and wireless clients generate a common PMK (Pairwise Master Key). The key itself is not sent over the network, but is derived from the PSK and the SSID.

- 4 The AP and wireless clients use the TKIP or AES encryption process, the PMK and information exchanged in a handshake to create temporal encryption keys. They use these keys to encrypt data exchanged between them.

Figure 138 WPA(2)-PSK Authentication

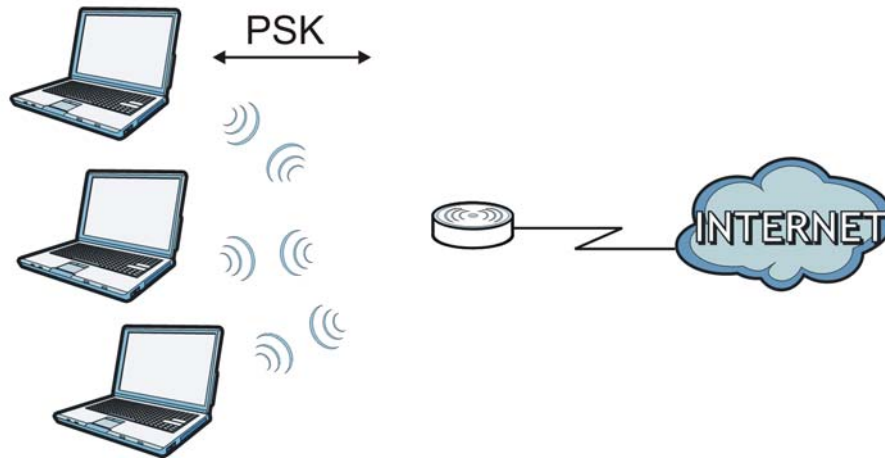

Security Parameters Summary

Refer to this table to see what other security parameters you should configure for each authentication method or key management protocol type. MAC address filters are not dependent on how you configure these security features.

Table 73 Wireless Security Relational Matrix

AUTHENTICATION METHOD/ KEY MANAGEMENT PROTOCOL	ENCRYPTION METHOD	ENTER MANUAL KEY	IEEE 802.1X
Open	None	No	Disable
			Enable without Dynamic WEP Key
Open	WEP	No	Enable with Dynamic WEP Key
		Yes	Enable without Dynamic WEP Key
		Yes	Disable
Shared	WEP	No	Enable with Dynamic WEP Key
		Yes	Enable without Dynamic WEP Key
		Yes	Disable
WPA	TKIP/AES	No	Enable
WPA-PSK	TKIP/AES	Yes	Disable
WPA2	TKIP/AES	No	Enable
WPA2-PSK	TKIP/AES	Yes	Disable

Antenna Overview

An antenna couples RF signals onto air. A transmitter within a wireless device sends an RF signal to the antenna, which propagates the signal through the air. The antenna also operates in reverse by capturing RF signals from the air.

Positioning the antennas properly increases the range and coverage area of a wireless LAN.

Antenna Characteristics

Frequency

An antenna in the frequency of 2.4GHz or 5GHz is needed to communicate efficiently in a wireless LAN

Radiation Pattern

A radiation pattern is a diagram that allows you to visualize the shape of the antenna's coverage area.

Antenna Gain

Antenna gain, measured in dB (decibel), is the increase in coverage within the RF beam width. Higher antenna gain improves the range of the signal for better communications.

For an indoor site, each 1 dB increase in antenna gain results in a range increase of approximately 2.5%. For an unobstructed outdoor site, each 1dB increase in gain results in a range increase of approximately 5%. Actual results may vary depending on the network environment.

Antenna gain is sometimes specified in dBi, which is how much the antenna increases the signal power compared to using an isotropic antenna. An isotropic antenna is a theoretical perfect antenna that sends out radio signals equally well in all directions. dBi represents the true gain that the antenna provides.

Types of Antennas for WLAN

There are two types of antennas used for wireless LAN applications.

- Omni-directional antennas send the RF signal out in all directions on a horizontal plane. The coverage area is torus-shaped (like a donut) which makes these antennas ideal for a room environment. With a wide coverage area, it is possible to make circular overlapping coverage areas with multiple access points.
- Directional antennas concentrate the RF signal in a beam, like a flashlight does with the light from its bulb. The angle of the beam determines the width of the coverage pattern. Angles typically range from 20 degrees (very directional) to 120 degrees (less directional). Directional antennas are ideal for hallways and outdoor point-to-point applications.

Positioning Antennas

In general, antennas should be mounted as high as practically possible and free of obstructions. In point-to-point application, position both antennas at the same height and in a direct line of sight to each other to attain the best performance.

For omni-directional antennas mounted on a table, desk, and so on, point the antenna up. For omni-directional antennas mounted on a wall or ceiling, point the antenna down. For a single AP application, place omni-directional antennas as close to the center of the coverage area as possible.

For directional antennas, point the antenna in the direction of the desired coverage area.

Common Services

The following table lists some commonly-used services and their associated protocols and port numbers. For a comprehensive list of port numbers, ICMP type/code numbers and services, visit the IANA (Internet Assigned Number Authority) web site.

- **Name:** This is a short, descriptive name for the service. You can use this one or create a different one, if you like.
- **Protocol:** This is the type of IP protocol used by the service. If this is **TCP/UDP**, then the service uses the same port number with TCP and UDP. If this is **USER-DEFINED**, the **Port(s)** is the IP protocol number, not the port number.
- **Port(s):** This value depends on the **Protocol**. Please refer to RFC 1700 for further information about port numbers.
 - If the **Protocol** is **TCP, UDP, or TCP/UDP**, this is the IP port number.
 - If the **Protocol** is **USER**, this is the IP protocol number.
- **Description:** This is a brief explanation of the applications that use this service or the situations in which this service is used.

Table 74 Commonly Used Services

NAME	PROTOCOL	PORT(S)	DESCRIPTION
AH (IPSEC_TUNNEL)	User-Defined	51	The IPSEC AH (Authentication Header) tunneling protocol uses this service.
AIM/New-ICQ	TCP	5190	AOL's Internet Messenger service. It is also used as a listening port by ICQ.
AUTH	TCP	113	Authentication protocol used by some servers.
BGP	TCP	179	Border Gateway Protocol.
BOOTP_CLIENT	UDP	68	DHCP Client.
BOOTP_SERVER	UDP	67	DHCP Server.
CU-SEEME	TCP UDP	7648 24032	A popular videoconferencing solution from White Pines Software.
DNS	TCP/UDP	53	Domain Name Server, a service that matches web names (for example www.zyxel.com) to IP numbers.
ESP (IPSEC_TUNNEL)	User-Defined	50	The IPSEC ESP (Encapsulation Security Protocol) tunneling protocol uses this service.
FINGER	TCP	79	Finger is a UNIX or Internet related command that can be used to find out if a user is logged on.
FTP	TCP TCP	20 21	File Transfer Program, a program to enable fast transfer of files, including large files that may not be possible by e-mail.
H.323	TCP	1720	NetMeeting uses this protocol.
HTTP	TCP	80	Hyper Text Transfer Protocol - a client/server protocol for the world wide web.

Table 74 Commonly Used Services (continued)

NAME	PROTOCOL	PORT(S)	DESCRIPTION
HTTPS	TCP	443	HTTPS is a secured http session often used in e-commerce.
ICMP	User-Defined	1	Internet Control Message Protocol is often used for diagnostic or routing purposes.
ICQ	UDP	4000	This is a popular Internet chat program.
IGMP (MULTICAST)	User-Defined	2	Internet Group Management Protocol is used when sending packets to a specific group of hosts.
IKE	UDP	500	The Internet Key Exchange algorithm is used for key distribution and management.
IRC	TCP/UDP	6667	This is another popular Internet chat program.
MSN Messenger	TCP	1863	Microsoft Networks' messenger service uses this protocol.
NEW-ICQ	TCP	5190	An Internet chat program.
NEWS	TCP	144	A protocol for news groups.
NFS	UDP	2049	Network File System - NFS is a client/server distributed file service that provides transparent file sharing for network environments.
NNTP	TCP	119	Network News Transport Protocol is the delivery mechanism for the USENET newsgroup service.
PING	User-Defined	1	Packet INternet Groper is a protocol that sends out ICMP echo requests to test whether or not a remote host is reachable.
POP3	TCP	110	Post Office Protocol version 3 lets a client computer get e-mail from a POP3 server through a temporary connection (TCP/IP or other).
PPTP	TCP	1723	Point-to-Point Tunneling Protocol enables secure transfer of data over public networks. This is the control channel.
PPTP_TUNNEL (GRE)	User-Defined	47	PPTP (Point-to-Point Tunneling Protocol) enables secure transfer of data over public networks. This is the data channel.
RCMD	TCP	512	Remote Command Service.
REAL_AUDIO	TCP	7070	A streaming audio service that enables real time sound over the web.
REXEC	TCP	514	Remote Execution Daemon.
RLOGIN	TCP	513	Remote Login.
RTELNET	TCP	107	Remote Telnet.
RTSP	TCP/UDP	554	The Real Time Streaming (media control) Protocol (RTSP) is a remote control for multimedia on the Internet.
SFTP	TCP	115	Simple File Transfer Protocol.
SMTP	TCP	25	Simple Mail Transfer Protocol is the message-exchange standard for the Internet. SMTP enables you to move messages from one e-mail server to another.
SNMP	TCP/UDP	161	Simple Network Management Program.
SNMP-TRAPS	TCP/UDP	162	Traps for use with the SNMP (RFC:1215).

Table 74 Commonly Used Services (continued)

NAME	PROTOCOL	PORT(S)	DESCRIPTION
SQL-NET	TCP	1521	Structured Query Language is an interface to access data on many different types of database systems, including mainframes, midrange systems, UNIX systems and network servers.
SSH	TCP/UDP	22	Secure Shell Remote Login Program.
STRM WORKS	UDP	1558	Stream Works Protocol.
SYSLOG	UDP	514	Syslog allows you to send system logs to a UNIX server.
TACACS	UDP	49	Login Host Protocol used for (Terminal Access Controller Access Control System).
TELNET	TCP	23	Telnet is the login and terminal emulation protocol common on the Internet and in UNIX environments. It operates over TCP/IP networks. Its primary function is to allow users to log into remote host systems.
TFTP	UDP	69	Trivial File Transfer Protocol is an Internet file transfer protocol similar to FTP, but uses the UDP (User Datagram Protocol) rather than TCP (Transmission Control Protocol).
VDOLIVE	TCP	7000	Another videoconferencing solution.

Legal Information

Copyright

Copyright © 2012 by ZyXEL Communications Corporation.

The contents of this publication may not be reproduced in any part or as a whole, transcribed, stored in a retrieval system, translated into any language, or transmitted in any form or by any means, electronic, mechanical, magnetic, optical, chemical, photocopying, manual, or otherwise, without the prior written permission of ZyXEL Communications Corporation.

Published by ZyXEL Communications Corporation. All rights reserved.

Disclaimer

ZyXEL does not assume any liability arising out of the application or use of any products, or software described herein. Neither does it convey any license under its patent rights nor the patent rights of others. ZyXEL further reserves the right to make changes in any products described herein without notice. This publication is subject to change without notice.

Certifications

Federal Communications Commission (FCC) Interference Statement

The device complies with Part 15 of FCC rules. Operation is subject to the following two conditions:

- This device may not cause harmful interference.
- This device must accept any interference received, including interference that may cause undesired operations.

This device has been tested and found to comply with the limits for a Class B digital device pursuant to Part 15 of the FCC Rules. These limits are designed to provide reasonable protection against harmful interference in a residential installation. This device generates, uses, and can radiate radio frequency energy, and if not installed and used in accordance with the instructions, may cause harmful interference to radio communications. However, there is no guarantee that interference will not occur in a particular installation.

If this device does cause harmful interference to radio/television reception, which can be determined by turning the device off and on, the user is encouraged to try to correct the interference by one or more of the following measures:

- 1 Reorient or relocate the receiving antenna.
- 2 Increase the separation between the equipment and the receiver.
- 3 Connect the equipment into an outlet on a circuit different from that to which the receiver is connected.
- 4 Consult the dealer or an experienced radio/TV technician for help.



FCC Radiation Exposure Statement

- This transmitter must not be co-located or operating in conjunction with any other antenna or transmitter.
- IEEE 802.11b, 802.11g or 802.11n (20MHz) operation of this product in the U.S.A. is firmware-limited to channels 1 through 11. IEEE 802.11n (40MHz) operation of this product in the U.S.A. is firmware-limited to channels 3 through 9.
- To comply with FCC RF exposure compliance requirements, a separation distance of at least 20 cm must be maintained between the antenna of this device and all persons.

注意！

依據 低功率電波輻射性電機管理辦法

第十二條 經型式認證合格之低功率射頻電機，非經許可，公司、商號或使用者均不得擅自變更頻率、加大功率或變更原設計之特性及功能。

第十四條 低功率射頻電機之使用不得影響飛航安全及干擾合法通信；經發現有干擾現象時，應立即停用，並改善至無干擾時方得繼續使用。前項合法通信，指依電信規定作業之無線電信。低功率射頻電機須忍受合法通信或工業、科學及醫療用電波輻射性電機設備之干擾。

Notices

Changes or modifications not expressly approved by the party responsible for compliance could void the user's authority to operate the equipment.

This device has been designed for the WLAN 2.4 GHz network throughout the EC region and Switzerland, with restrictions in France.

Ce produit est conçu pour les bandes de fréquences 2,4 GHz conformément à la législation Européenne. En France métropolitaine, suivant les décisions n°03-908 et 03-909 de l'ARCEP, la puissance d'émission ne devra pas dépasser 10 mW (10 dB) dans le cadre d'une installation WiFi en extérieur pour les fréquences comprises entre 2454 MHz et 2483,5 MHz.

This Class B digital apparatus complies with Canadian ICES-003.
Cet appareil numérique de la classe B est conforme à la norme NMB-003 du Canada.

Viewing Certifications

Go to <http://www.zyxel.com> to view this product's documentation and certifications.

ZyXEL Limited Warranty

ZyXEL warrants to the original end user (purchaser) that this product is free from any defects in material or workmanship for a specific period (the Warranty Period) from the date of purchase. The Warranty Period varies by region. Check with your vendor and/or the authorized ZyXEL local distributor for details about the Warranty Period of this product. During the warranty period, and upon proof of purchase, should the product have indications of failure due to faulty workmanship and/or materials, ZyXEL will, at its discretion, repair or replace the defective products or components without charge for either parts or labor, and to whatever extent it shall deem necessary to restore the product or components to proper operating condition. Any replacement will consist of a new or re-manufactured functionally equivalent product of equal or higher value, and will be solely at the discretion of ZyXEL. This warranty shall not apply if the product has been modified, misused, tampered with, damaged by an act of God, or subjected to abnormal working conditions.

Note

Repair or replacement, as provided under this warranty, is the exclusive remedy of the purchaser. This warranty is in lieu of all other warranties, express or implied, including any implied warranty of merchantability or fitness for a particular use or purpose. ZyXEL shall in no event be held liable for indirect or consequential damages of any kind to the purchaser.

To obtain the services of this warranty, contact your vendor. You may also refer to the warranty policy for the region in which you bought the device at http://www.zyxel.com/web/support_warranty_info.php.

Registration

Register your product online to receive e-mail notices of firmware upgrades and information at www.zyxel.com for global products, or at www.us.zyxel.com for North American products.

Open Source Licenses (all products)

This product contains in part some free software distributed under GPL license terms and/or GPL like licenses. Open source licenses are provided with the firmware package. You can download the latest firmware at www.zyxel.com. To obtain the source code covered under those Licenses, please contact support@zyxel.com.tw to get it.

Regulatory Information

European Union

The following information applies if you use the product within the European Union.

Declaration of Conformity with Regard to EU Directive 1999/5/EC (R&TTE Directive)

Compliance Information for 2.4GHz and 5GHz Wireless Products Relevant to the EU and Other Countries Following the EU Directive 1999/5/EC (R&TTE Directive)

[Czech]	ZyXEL tímto prohlašuje, že tento zařízení je ve shodě se základními požadavky a dalšími příslušnými ustanoveními směrnice 1999/5/EC.
[Danish]	Undertegnede ZyXEL erklærer herved, at følgende udstyr overholder de væsentlige krav og øvrige relevante krav i direktiv 1999/5/EF.
[German]	Hiermit erkläre ZyXEL, dass sich das Gerät Ausstattung in Übereinstimmung mit den grundlegenden Anforderungen und den übrigen einschlägigen Bestimmungen der Richtlinie 1999/5/EU befindet.
[Estonian]	Käesolevaga kinnitab ZyXEL seadme seadmed vastavust direktiivi 1999/5/EÜ põhinõuetele ja nimetatud direktiivist tulenevatele teistele asjakohastele sätetele.
English	Hereby, ZyXEL declares that this equipment is in compliance with the essential requirements and other relevant provisions of Directive 1999/5/EC.
[Spanish]	Por medio de la presente ZyXEL declara que el equipo cumple con los requisitos esenciales y cualesquiera otras disposiciones aplicables o exigibles de la Directiva 1999/5/CE.
[Greek]	ΜΕ ΤΗΝ ΠΑΡΟΥΣΑ ΖΥΧΕΛ ΔΗΛΩΝΕΙ ΟΤΙ ΕΞΟΠΛΙΣΜΟΣ ΣΥΜΜΟΡΦΩΝΕΤΑΙ ΠΡΟΣ ΤΙΣ ΟΥΣΙΩΔΕΙΣ ΑΠΑΙΤΗΣΕΙΣ ΚΑΙ ΤΙΣ ΛΟΙΠΕΣ ΣΧΕΤΙΚΕΣ ΔΙΑΤΑΞΕΙΣ ΤΗΣ ΟΔΗΓΙΑΣ 1999/5/ΕΚ.
[French]	Par la présente ZyXEL déclare que l'appareil équipements est conforme aux exigences essentielles et aux autres dispositions pertinentes de la directive 1999/5/EC.
[Italian]	Con la presente ZyXEL dichiara che questo attrezzatura è conforme ai requisiti essenziali ed alle altre disposizioni pertinenti stabilite dalla direttiva 1999/5/CE.
[Latvian]	Ar šo ZyXEL deklarē, ka iekārtas atbilst Direktīvas 1999/5/EK būtiskajām prasībām un citiem ar to saistītajiem noteikumiem.
[Lithuanian]	Šiuo ZyXEL deklaruoja, kad šis įranga atitinka esminius reikalavimus ir kitas 1999/5/EB Direktyvos nuostatas.
[Dutch]	Hierbij verklaart ZyXEL dat het toestel uitrusting in overeenstemming is met de essentiële eisen en de andere relevante bepalingen van richtlijn 1999/5/EC.
[Maltese]	Hawnhekk, ZyXEL, jiddikjara li dan taghmir jikkonforma mal-htigijiet essenzjali u ma provvedimenti oħrajn rilevanti li hemm fid-Dirrettiva 1999/5/EC.

[Hungarian]	Alulírott, ZyXEL nyilatkozom, hogy a berendezés megfelel a vonatkozó alapvető követelményeknek és az 1999/5/EK irányelv egyéb előírásainak.
[Polish]	Niniejszym ZyXEL oświadcza, że sprzęt jest zgodny z zasadniczymi wymogami oraz pozostałymi stosownymi postanowieniami Dyrektywy 1999/5/EC.
[Portuguese]	ZyXEL declara que este equipamento está conforme com os requisitos essenciais e outras disposições da Directiva 1999/5/EC.
[Slovenian]	ZyXEL izjavlja, da je ta oprema v skladu z bistvenimi zahtevami in ostalimi relevantnimi določili direktive 1999/5/EC.
[Slovak]	ZyXEL týmto vyhlasuje, že zariadenia spĺňa základné požiadavky a všetky príslušné ustanovenia Smernice 1999/5/EC.
[Finnish]	ZyXEL vakuuttaa täten että laitteet tyyppinen laite on direktiivin 1999/5/EY oleellisten vaatimusten ja sitä koskevien direktiivin muiden ehtojen mukainen.
[Swedish]	Härmed intygar ZyXEL att denna utrustning står i överensstämmelse med de väsentliga egenskapskrav och övriga relevanta bestämmelser som framgår av direktiv 1999/5/EC.
[Bulgarian]	С настоящото ZyXEL декларира, че това оборудване е в съответствие със съществените изисквания и другите приложими разпоредбите на Директива 1999/5/EC.
[Icelandic]	Hér með lýsir, ZyXEL því yfir að þessi búnaður er í samræmi við grunnkröfur og önnur viðeigandi ákvæði tilskipunar 1999/5/EC.
[Norwegian]	Erklærer herved ZyXEL at dette utstyret er i samsvar med de grunnleggende kravene og andre relevante bestemmelser i direktiv 1999/5/EF.
[Romanian]	Prin prezenta, ZyXEL declară că acest echipament este în conformitate cu cerințele esențiale și alte prevederi relevante ale Directivei 1999/5/EC.



National Restrictions

This product may be used in all EU countries (and other countries following the EU directive 1999/5/EC) without any limitation except for the countries mentioned below:

Ce produit peut être utilisé dans tous les pays de l'UE (et dans tous les pays ayant transposés la directive 1999/5/CE) sans aucune limitation, excepté pour les pays mentionnés ci-dessous:

Questo prodotto è utilizzabile in tutte i paesi EU (ed in tutti gli altri paesi che seguono le direttive EU 1999/5/EC) senza nessuna limitazione, eccetto per i paesi menzionati di seguito:

Das Produkt kann in allen EU Staaten ohne Einschränkungen eingesetzt werden (sowie in anderen Staaten die der EU Direktive 1995/5/CE folgen) mit Ausnahme der folgenden aufgeführten Staaten:

In the majority of the EU and other European countries, the 2, 4- and 5-GHz bands have been made available for the use of wireless local area networks (LANs). Later in this document you will find an overview of countries in which additional restrictions or requirements or both are applicable.

The requirements for any country may evolve. ZyXEL recommends that you check with the local authorities for the latest status of their national regulations for both the 2,4- and 5-GHz wireless LANs.

The following countries have restrictions and/or requirements in addition to those given in the table labeled "Overview of Regulatory Requirements for Wireless LANs":.

Overview of Regulatory Requirements for Wireless LANs			
Frequency Band (MHz)	Max Power Level (EIRP) ¹ (mW)	Indoor ONLY	Indoor and Outdoor
2400-2483.5	100		✓
5150-5350	200	✓	
5470-5725	1000		✓

Belgium

The Belgian Institute for Postal Services and Telecommunications (BIPT) must be notified of any outdoor wireless link having a range exceeding 300 meters. Please check <http://www.bipt.be> for more details.

Draadloze verbindingen voor buitengebruik en met een reikwijdte van meer dan 300 meter dienen aangemeld te worden bij het Belgisch Instituut voor postdiensten en telecommunicatie (BIPT). Zie <http://www.bipt.be> voor meer gegevens.

Les liaisons sans fil pour une utilisation en extérieur d'une distance supérieure à 300 mètres doivent être notifiées à l'Institut Belge des services Postaux et des Télécommunications (IBPT). Visitez <http://www.ibpt.be> pour de plus amples détails.

Denmark

In Denmark, the band 5150 - 5350 MHz is also allowed for outdoor usage.

I Danmark må frekvensbåndet 5150 - 5350 også anvendes udendørs.

France

For 2.4 GHz, the output power is restricted to 10 mW EIRP when the product is used outdoors in the band 2454 - 2483.5 MHz. There are no restrictions when used indoors or in other parts of the 2.4 GHz band. Check <http://www.arcep.fr> for more details.

Pour la bande 2.4 GHz, la puissance est limitée à 10 mW en p.i.r.e. pour les équipements utilisés en extérieur dans la bande 2454 - 2483.5 MHz. Il n'y a pas de restrictions pour des utilisations en intérieur ou dans d'autres parties de la bande 2.4 GHz. Consultez <http://www.arcep.fr/> pour de plus amples détails.

R&TTE 1999/5/EC		
WLAN 2.4 – 2.4835 GHz		
IEEE 802.11 b/g/n		
Location	Frequency Range(GHz)	Power (EIRP)
Indoor (No restrictions)	2.4 – 2.4835	100mW (20dBm)
Outdoor	2.4 – 2.454	100mW (20dBm)
	2.454 – 2.4835	10mW (10dBm)

Italy

This product meets the National Radio Interface and the requirements specified in the National Frequency Allocation Table for Italy. Unless this wireless LAN product is operating within the boundaries of the owner's property, its use requires a "general authorization." Please check <http://www.sviluppoeconomico.gov.it/> for more details.

Questo prodotto è conforme alla specifiche di Interfaccia Radio Nazionali e rispetta il Piano Nazionale di ripartizione delle frequenze in Italia. Se non viene installato all'interno del proprio fondo, l'utilizzo di prodotti Wireless LAN richiede una "Autorizzazione Generale". Consultare <http://www.sviluppoeconomico.gov.it/> per maggiori dettagli.

Latvia

The outdoor usage of the 2.4 GHz band requires an authorization from the Electronic Communications Office. Please check <http://www.esd.lv> for more details.

2.4 GHz frekvenču joslas izmantošanai ārpus telpām nepieciešama atļauja no Elektronisko sakaru direkcijas. Vairāk informācijas: <http://www.esd.lv>.

Notes:

1. Although Norway, Switzerland and Liechtenstein are not EU member states, the EU Directive 1999/5/EC has also been implemented in those countries.
2. The regulatory limits for maximum output power are specified in EIRP. The EIRP level (in dBm) of a device can be calculated by adding the gain of the antenna used (specified in dBi) to the output power available at the connector (specified in dBm).

List of national codes

COUNTRY	ISO 3166 2 LETTER CODE	COUNTRY	ISO 3166 2 LETTER CODE
Austria	AT	Malta	MT
Belgium	BE	Netherlands	NL
Cyprus	CY	Poland	PL
Czech Republic	CR	Portugal	PT
Denmark	DK	Slovakia	SK
Estonia	EE	Slovenia	SI
Finland	FI	Spain	ES
France	FR	Sweden	SE
Germany	DE	United Kingdom	GB
Greece	GR	Iceland	IS
Hungary	HU	Liechtenstein	LI
Ireland	IE	Norway	NO
Italy	IT	Switzerland	CH
Latvia	LV	Bulgaria	BG
Lithuania	LT	Romania	RO
Luxembourg	LU	Turkey	TR

Safety Warnings

- Do NOT use this product near water, for example, in a wet basement or near a swimming pool.
- Do NOT expose your device to dampness, dust or corrosive liquids.
- Do NOT store things on the device.
- Do NOT install, use, or service this device during a thunderstorm. There is a remote risk of electric shock from lightning.
- Connect ONLY suitable accessories to the device.
- Do NOT open the device or unit. Opening or removing covers can expose you to dangerous high voltage points or other risks. ONLY qualified service personnel should service or disassemble this device. Please contact your vendor for further information.
- Make sure to connect the cables to the correct ports.
- Place connecting cables carefully so that no one will step on them or stumble over them.
- Always disconnect all cables from this device before servicing or disassembling.
- Use ONLY an appropriate power adaptor or cord for your device.

- Connect the power adaptor or cord to the right supply voltage (for example, 110V AC in North America or 230V AC in Europe).
- Do NOT allow anything to rest on the power adaptor or cord and do NOT place the product where anyone can walk on the power adaptor or cord.
- Do NOT use the device if the power adaptor or cord is damaged as it might cause electrocution.
- If the power adaptor or cord is damaged, remove it from the power outlet.
- Do NOT attempt to repair the power adaptor or cord. Contact your local vendor to order a new one.
- Do not use the device outside, and make sure all the connections are indoors. There is a remote risk of electric shock from lightning.
- Do NOT obstruct the device ventilation slots, as insufficient airflow may harm your device.
- Antenna Warning! This device meets ETSI and FCC certification requirements when using the included antenna(s). Only use the included antenna(s).
- If you wall mount your device, make sure that no electrical lines, gas or water pipes will be damaged.

Your product is marked with this symbol, which is known as the WEEE mark. WEEE stands for Waste Electronics and Electrical Equipment. It means that used electrical and electronic products should not be mixed with general waste. Used electrical and electronic equipment should be treated separately.



Index

A

- Address Assignment [86](#)
- Advanced Encryption Standard
 - See AES.
- AES [203](#)
- Alert [129](#)
- alternative subnet mask notation [149](#)
- antenna
 - directional [207](#)
 - gain [207](#)
 - omni-directional [207](#)
- AP (access point) [197](#)
- AP Mode
 - menu [42, 47](#)
 - overview [35](#)
 - status screen [37, 45, 49, 53](#)

B

- Backup configuration [133](#)
- Basic Service Set, See BSS [195](#)
- BSS [195](#)

C

- CA [202](#)
- Certificate Authority
 - See CA.
- certifications
 - notices [213](#)
 - viewing [214](#)
- Channel [39, 46, 50, 53](#)
- channel [69, 197](#)
 - interference [197](#)
- client bridge [13](#)
- Configuration
 - backup [133](#)

- reset the factory defaults [134](#)
 - restore [133](#)
- copyright [213](#)
- CPU usage [39, 46, 50, 54](#)
- CTS (Clear to Send) [198](#)

D

- Daylight saving [128](#)
- DDNS
 - service providers [109](#)
- device mode [13, 35](#)
- DHCP [40, 97](#)
 - DHCP server
 - see also Dynamic Host Configuration Protocol
- DHCP client information [100](#)
- DHCP client list [100](#)
- DHCP server [94, 97](#)
- DHCP table [40, 100](#)
 - DHCP client information
 - DHCP status
- disclaimer [213](#)
- DNS [30, 99](#)
 - DNS server
 - see also Domain name system
- DNS Server [86](#)
- DNS server [99](#)
- documentation
 - related [2](#)
- Domain name [23](#)
 - vs host name. see also system name
- Domain Name System [99](#)
- Domain Name System. See DNS.
- duplex setting [40, 46, 50, 54](#)
- Dynamic DNS [109](#)
- Dynamic Host Configuration Protocol [97](#)
- dynamic WEP key exchange [202](#)
- DynDNS [109](#)
- DynDNS see also DDNS [109](#)

E

EAP Authentication [201](#)
encryption [70, 203](#)
 key [70](#)
 WPA compatible [70](#)
ESS [196](#)
ESSID [145](#)
Extended Service Set, See ESS [196](#)
Extended wireless security [24](#)

F

Factory LAN defaults [94, 97](#)
FCC interference statement [213](#)
Firewall
 ICMP packets [113](#)
 ZyXEL device firewall [112](#)
firewall
 stateful inspection [111](#)
Firmware upload [131](#)
 file extension
 using HTTP
firmware version [39, 46, 49, 53](#)
fragmentation threshold [198](#)

G

General wireless LAN screen [70](#)
Guide
 Quick Start [2](#)

H

hidden node [197](#)

I

IANA [154](#)
IBSS [195](#)

IEEE 802.11g [199](#)
Independent Basic Service Set
 See IBSS [195](#)
initialization vector (IV) [204](#)
Internet Assigned Numbers Authority
 See IANA [154](#)
Internet connection
 Ethernet
 PPPoE. see also PPP over Ethernet
 PPTP
 WAN connection
Internet connection wizard [25](#)
IP Address [95, 104](#)
IP address [30](#)
 dynamic
IP Pool [98](#)

L

LAN [93](#)
 IP pool setup [94](#)
LAN overview [93](#)
LAN setup [93](#)
LAN TCP/IP [94](#)
Language [139](#)
Link type [40, 46, 50, 54](#)
Local Area Network [93](#)
Log [129](#)

M

MAC [75](#)
MAC address [69, 86](#)
 cloning [31, 86](#)
MAC address filter [69](#)
MAC address filtering [75](#)
MAC filter [75](#)
managing the device
 good habits [14](#)
Media access control [75](#)
Memory usage [39, 46, 50, 54](#)
Message Integrity Check (MIC) [203](#)

mode [13](#)

N

NAT [101](#), [104](#), [154](#)
 global [102](#)
 how it works [101](#), [103](#)
 inside [102](#)
 local [102](#)
 outside [102](#)
 overview [101](#)
 port forwarding [106](#)
 see also Network Address Translation
 server [103](#)
 server sets [106](#)
 NAT traversal [119](#)
 Navigation Panel [42](#), [47](#), [51](#), [54](#)
 navigation panel [42](#), [47](#), [51](#), [54](#)
 Network Address Translation [101](#), [104](#)

O

operating mode [13](#)
 operation mode [35](#), [137](#)
 access point [35](#)
 client [36](#)
 router [35](#)
 universal repeater [36](#)
 other documentation [2](#)
 overview [13](#)

P

Pairwise Master Key (PMK) [204](#), [205](#)
 Point-to-Point Protocol over Ethernet [26](#), [88](#)
 Point-to-Point Tunneling Protocol [27](#), [90](#)
 Pool Size [98](#)
 Port forwarding [104](#), [106](#)
 default server [104](#), [106](#)
 example [107](#)
 local server [104](#)
 port numbers

services
 port speed [40](#), [46](#), [50](#), [54](#)
 PPPoE [26](#), [88](#)
 benefits [26](#)
 dial-up connection
 see also Point-to-Point Protocol over Ethernet [26](#)
 PPTP [27](#), [90](#)
 see also Point-to-Point Tunneling Protocol [27](#)
 preamble mode [199](#)
 product registration [214](#)
 PSK [204](#)

Q

Quality of Service (QoS) [78](#)
 Quick Start Guide [2](#)

R

RADIUS [200](#)
 message types [201](#)
 messages [201](#)
 shared secret key [201](#)
 registration
 product [214](#)
 related documentation [2](#)
 Remote management [115](#)
 and NAT [116](#)
 and the firewall [115](#)
 limitations [116](#)
 system timeout [116](#)
 Reset button [19](#), [134](#)
 Reset the device [19](#)
 Restore configuration [133](#)
 Roaming [76](#)
 RTS (Request To Send) [198](#)
 threshold [197](#), [198](#)
 RTS/CTS Threshold [68](#), [76](#), [77](#)

S

safety warnings [216](#)

- Scheduling [81](#)
- screw anchor [16](#)
- Service Set [72](#)
- Service Set IDentification [72](#), [82](#), [83](#)
- Service Set IDentity. See SSID.
- SSID [39](#), [46](#), [53](#), [69](#), [72](#), [82](#), [83](#)
- stateful inspection firewall [111](#)
- Static DHCP [98](#)
- subnet [147](#)
- Subnet Mask [95](#)
- subnet mask [30](#), [148](#)
- subnetting [150](#)
- Summary
 - DHCP table [40](#)
 - Packet statistics [41](#)
 - Wireless station status [42](#)
- Sys Op Mode [137](#)
- System General Setup [125](#)
- System Name [126](#)
- System name [22](#)
 - vs computer name
- System restart [134](#)

T

- TCP/IP configuration [97](#)
- Temporal Key Integrity Protocol (TKIP) [203](#)
- Time setting [126](#)

U

- Universal Plug and Play [119](#)
 - application [119](#)
- universal repeater [13](#)
- UPnP [119](#)
 - security issues [119](#)

V

- VPN [90](#)

W

- wall mounting [16](#)
- WAN
 - IP address assignment [29](#)
- WAN (Wide Area Network) [85](#)
- WAN IP address [29](#)
- WAN IP address assignment [30](#)
- WAN MAC address [86](#)
- warranty [214](#)
 - note [214](#)
- Web Configurator
 - how to access [17](#)
 - Overview [17](#)
- WEP Encryption [74](#)
- WEP encryption [73](#)
- WEP key [73](#)
- Wi-Fi Protected Access [203](#)
- Wireless association list [42](#)
- wireless channel [145](#)
- wireless client WPA supplicants [204](#)
- wireless LAN [145](#)
- wireless LAN scheduling [81](#)
- Wireless LAN wizard [23](#)
- Wireless network
 - basic guidelines [68](#)
 - channel [69](#)
 - encryption [70](#)
 - example [67](#)
 - MAC address filter [69](#)
 - overview [67](#)
 - security [69](#)
 - SSID [69](#)
- Wireless security [69](#)
 - overview [69](#)
 - type [69](#)
- wireless security [145](#), [199](#)
- Wireless tutorial [57](#)
 - WPS [57](#)
- Wizard setup [21](#)
 - complete [32](#)
 - Internet connection [25](#)
 - system information [22](#)
 - wireless LAN [23](#)
- WLAN
 - interference [197](#)

- security parameters [206](#)
- WPA [203](#)
 - key caching [204](#)
 - pre-authentication [204](#)
 - user authentication [204](#)
 - vs WPA-PSK [204](#)
 - wireless client supplicant [204](#)
 - with RADIUS application example [205](#)
- WPA compatible [70](#)
- WPA2 [203](#)
 - user authentication [204](#)
 - vs WPA2-PSK [204](#)
 - wireless client supplicant [204](#)
 - with RADIUS application example [205](#)
- WPA2-Pre-Shared Key [203](#)
- WPA2-PSK [203](#), [204](#)
 - application example [205](#)
- WPA-PSK [203](#), [204](#)
 - application example [205](#)
- WPS [15](#)
- WPS button [15](#)

