

Always there to help you

Register your product and get support at
www.philips.com/support



HTL1180B



Quick start guide

PHILIPS



- EN** Before using your product, read all accompanying safety information
- CS** Před použitím produktu si přečtěte doprovodné bezpečnostní informace
- DA** Læs alle medfølgende sikkerhedsoplysninger, inden du tager produktet i brug
- DE** Lesen Sie vor Verwendung dieses Produkts alle begleitenden Sicherheitsinformationen
- EL** Πριν χρησιμοποιήσετε το προϊόν, διαβάστε όλες τις παρεχόμενες πληροφορίες ασφάλειας
- ES** Antes de usar el producto, lea toda la información de seguridad adjunta
- FI** Lue kaikki turvallisuuksiedot ennen tuotteen käyttöä
- FR** Avant d'utiliser votre produit, lisez l'intégralité des consignes de sécurité jointes
- HU** A termék használatá előtt alaposan olvassa el a mellékelt biztonsági tudnivalókat
- IT** Prima di utilizzare il prodotto, leggere tutte le relative informazioni sulla sicurezza
- NL** Lees voordat u het product gaat gebruiken eerst alle bijbehorende veiligheidsinformatie
- NO** Les all vedlagt sikkerhetsinformasjon før du bruker produktet
- PL** Przed rozpoczęciem korzystania z produktu należy zapoznać się z informacjami dotyczącymi bezpieczeństwa
- PT** Antes de utilizar o produto, leia todas as informações de segurança que o acompanham
- RO** Înainte de a utiliza acest produs, citiți toate informațiile de siguranță care îl însoțesc
- SK** Pred použitím produktu si prečítajte všetky sprievodné bezpečnostné informácie maklumat keselamatan yang disertakan
- SV** Innan du använder produkten ska du läsa all tillhörande säkerhetsinformation
- TR** Ürününüzü kullanmadan önce ilgili tüm güvenlik bilgilerinizi okuyun

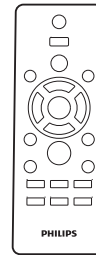
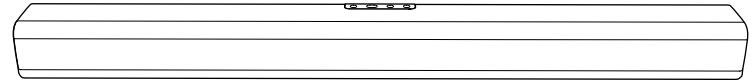

Power Cord

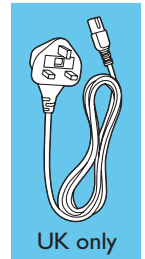

UK only

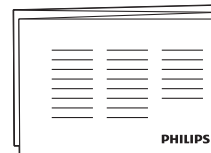

1



- EN** Position the SoundBar / Wall mount the SoundBar (optional)
- CS** Umístění zařízení SoundBar / Montáž zařízení SoundBar na stěnu (volitelné)
- DA** Placer din SoundBar / Monter din SoundBar på væggen (valgfrit)
- DE** Positionieren des SoundBars / Wandmontage des SoundBars (optional)
- EL** Τοποθέτηση του SoundBar / Επιτοίχια τοποθέτηση του SoundBar (προαιρετικά)
- ES** Colocación del SoundBar / Montaje en pared del SoundBar (opcional)
- FI** SoundBarin sijoittaminen / SoundBarin kiinnittäminen seinään (valinnainen)
- FR** Placer la barre de son / Fixer la barre de son sur un mur (facultatif)
- HU** A SoundBar elhelyezése / A SoundBar falí rögzítése (opcionális)
- IT** Posizionamento della SoundBar / Montaggio a parete della SoundBar (opzionale)
- NL** De SoundBar plaatsen / De SoundBar aan de wand bevestigen (optioneel)
- NO** Plasser SoundBar / Monter SoundBar på veggene (valgfritt)
- PL** Ustawianie zestawu SoundBar / Montaż ścienny zestawu SoundBar (opcjonalnie)
- PT** Posicionar o SoundBar / Montar o SoundBar na parede (opcional)
- RO** Poziționare SoundBar / Montare pe perete SoundBar (opțional)
- SK** Umiestnite zariadenie SoundBar / Upevnite zariadenie SoundBar na stenu (voliteľné)
- SV** Placera SoundBar / Vägghmontera SoundBar (valfritt)
- TR** SoundBar'ı yerleştirin / SoundBar'ı duvara monte edin (isteğe bağlı)

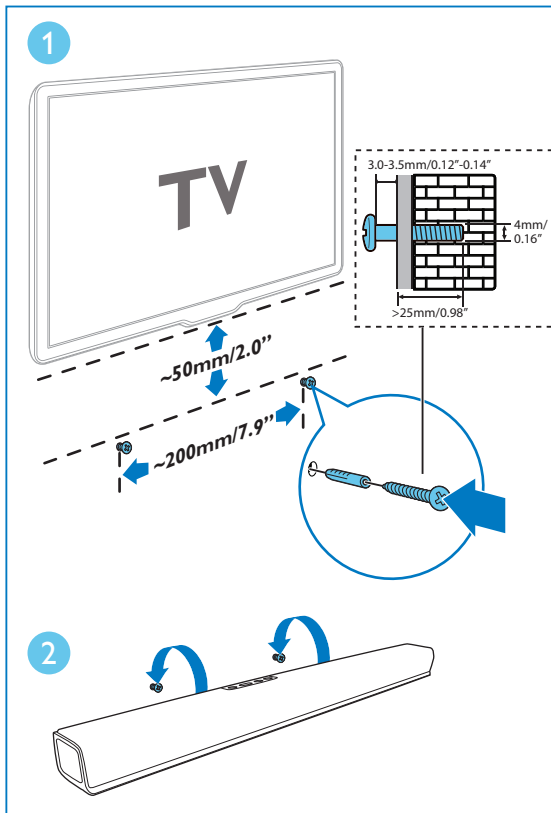
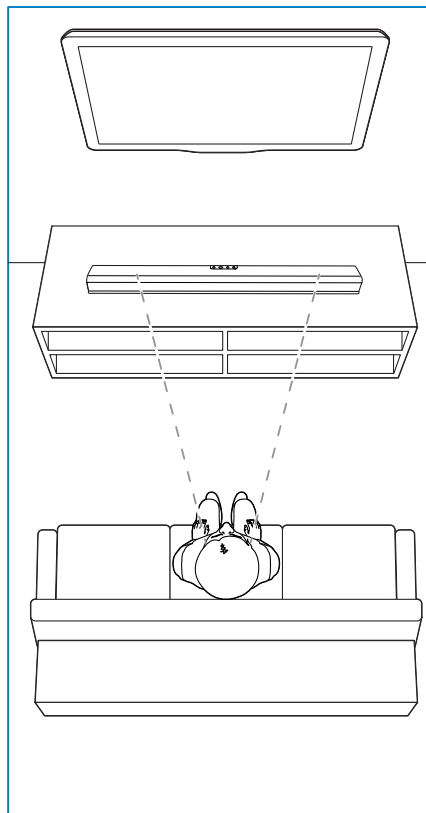

2

- EN** Connect the SoundBar
- CS** Připojení zařízení SoundBar
- DA** Tilslut din SoundBar
- DE** Anschließen des SoundBars
- EL** Σύνδεση του SoundBar
- ES** Conexión del SoundBar
- FI** SoundBarin liittäminen
- FR** Connecter la barre de son
- HU** A SoundBar csatlakoztatása
- IT** Collegamento della SoundBar
- NL** De SoundBar aansluiten
- NO** Koble til SoundBar
- PL** Podłączenie zestawu SoundBar
- PT** Ligar os cabos do SoundBar
- RO** Conectare SoundBar
- SK** Pripojte zariadenie SoundBar
- SV** Ansluta SoundBar
- TR** SoundBar'ı bağlayın

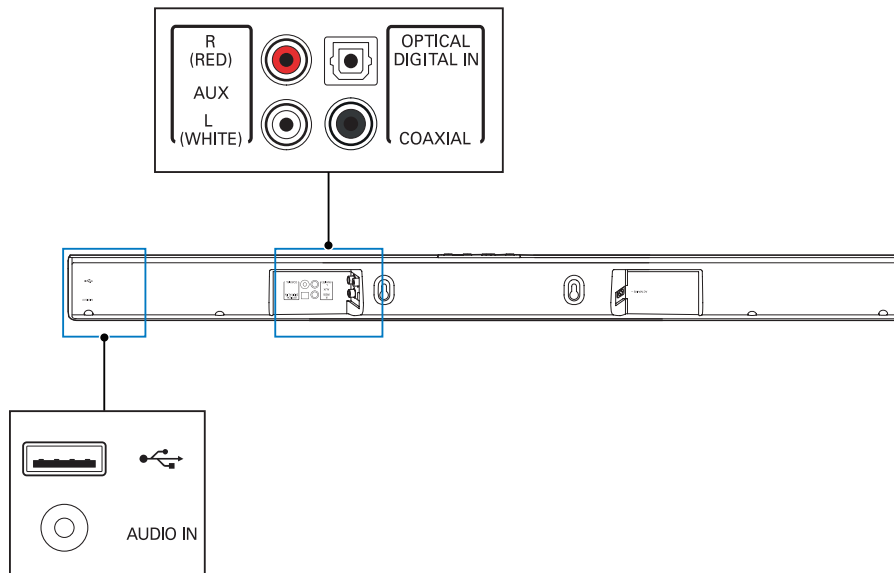

3

- EN** Hear audio from TV in one of the following ways (Mute your TV).
- CS** Zvuk můžete poslouchat z televizoru jedním z následujících způsobů (Ztlumení zvuku).
- DA** Hør lyd fra tv'et på en af følgende måder (Sæt dit tv på lydløs).
- DE** Genießen Sie den Ton Ihres Fernsehers auf eine der folgenden Arten (Stellen Sie den Ton Ihres Fernsehgeräts stumm).
- EL** Ακούστε τον ήχο από την τηλεόραση με έναν από τους παρακάτω τρόπους (Σίγαση της τηλεόρασης).
- ES** Escuche el audio del televisor utilizando uno de los métodos siguientes (Quite el sonido a su TV).
- FI** Kuuntele television ääntä jollakin seuraavista tavoista (Mykistä televisio).
- FR** Vous pouvez lire du contenu audio à partir du téléviseur de plusieurs façons (Désactivation du son du téléviseur).
- HU** A televízió hangja a következő módok valamelyikén hallgatható (Némítsa le a TV-készüléket).
- IT** È possibile ascoltare l'audio dal televisore in uno dei modi indicati di seguito (Disattivare l'audio del televisore).
- NL** Het TV-geluid beluisteren op een van deze manieren (De TV dempen).
- NO** Hør lyd fra TV-en på en av følgende måter (Dempe TV-en).
- PL** Odtwarzaj dźwięk z telewizora w następujący sposób (Wycisz telewizor).
- PT** Ouvir áudio no televisor de uma das seguintes formas (Tire o som do televisor).
- RO** Beneficiați de conținutul audio de la TV într-unul dintre următoarele moduri (Anulați sunetul televizorului).
- SK** Zvuk z televizora môžete prehrávať niekoľkými spôsobmi (Vypnutie zvuku televizora).
- SV** Spela upp TV-ljud på ett av följande sätt (Stäng av TV-ljudet).
- TR** TV'den ses almak için aşağıdaki yöntemlerden birini kullanın (TV'nizin sesini kısın).

OPTICAL

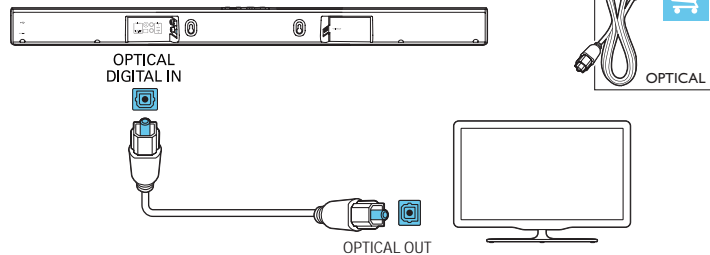

COAXIAL

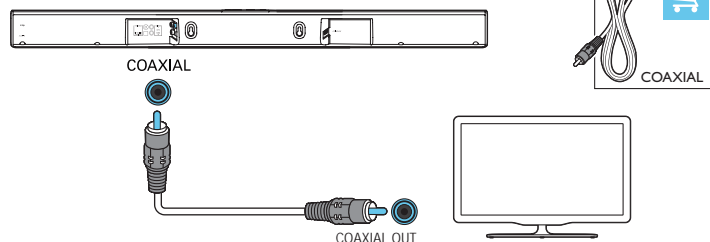

AUDIO L/R

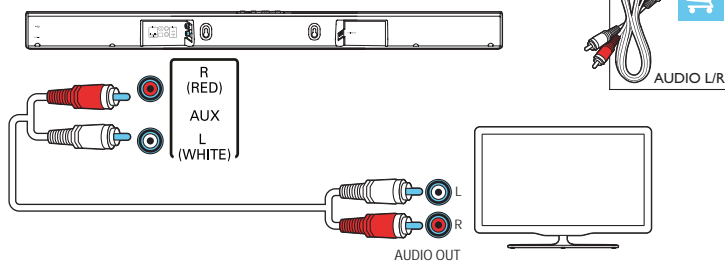

4

- EN** Enjoy audio from your devices
- CS** Užijte si hudbu díky vašim zařízením
- DA** Få lyd fra dine enheder
- DE** Audio von Ihren Geräten genießen
- EL** Απολαύστε ήχο από τις συσκευές σας
- ES** Disfrute del audio y de sus dispositivos
- FI** Nauti laitteidesi äänestä
- FR** Lire le contenu audio de vos périphériques
- HU** Élvezze a készülékekről lejátszott zenét
- IT** Ascolto di audio dai dispositivi
- NL** Genieten van audio op uw apparaten
- NO** Få lyd fra enhetene dine
- PL** Ciesz się dźwiękiem ze swoich urządzeń
- PT** Reproduzir áudio nos seus dispositivos
- RO** Bucurați-vă de conținutul audio de pe dispozitivele dvs
- SK** Vychutnajte si zvuk zo svojich zariadení
- SV** Njut av ljud från dina enheter
- TR** Diğer cihazlarınızdan ses dosyaları oynatın

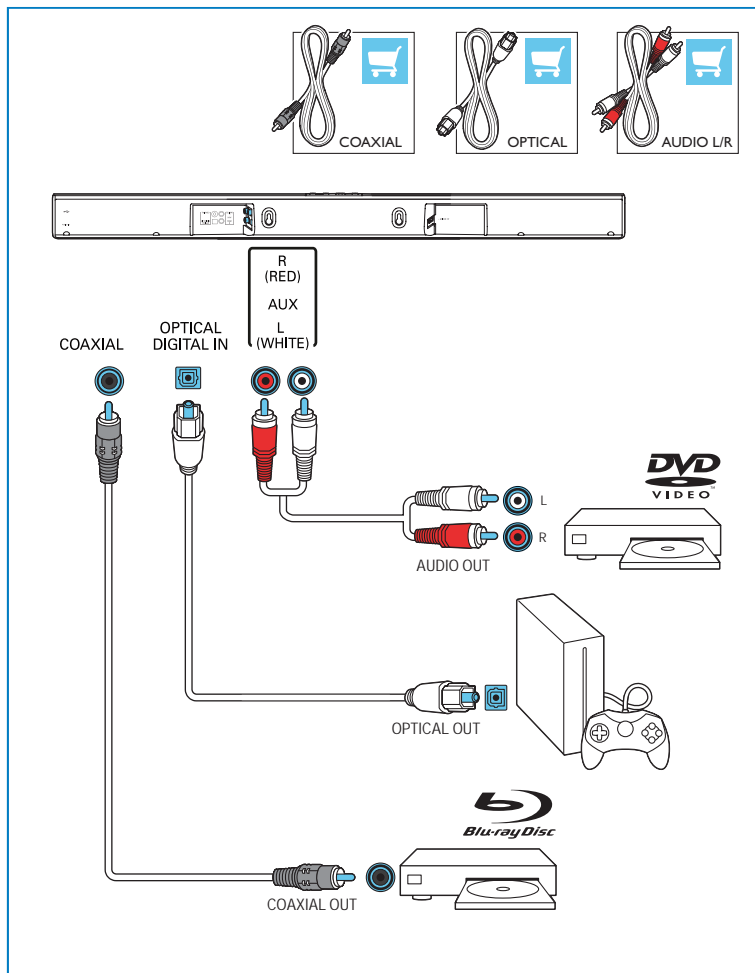

5

- EN** Switch on the SoundBar
- CS** Zapnutí zařízení SoundBar
- DA** Tænd for din SoundBar
- DE** Einschalten des SoundBars
- EL** Ενεργοποίηση του SoundBar
- ES** Encendido del SoundBar
- FI** SoundBarin käynnistäminen
- FR** Allumer la barre de son
- HU** A SoundBar bekapcsolása
- IT** Accensione della SoundBar
- NL** De SoundBar inschakelen
- NO** Slå på SoundBar
- PL** Włączenie zestawu SoundBar
- PT** Ligar o SoundBar
- RO** Pornire SoundBar
- SK** Zapnite zariadenie SoundBar
- SV** Slå på SoundBar
- TR** SoundBar'ı açın

1

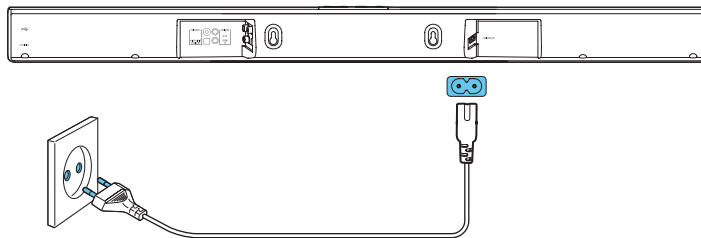

2

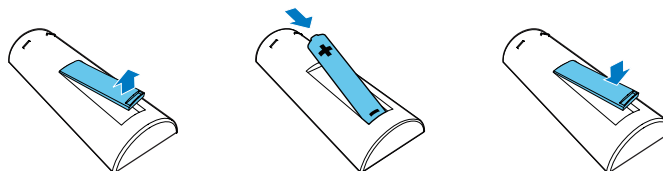

3

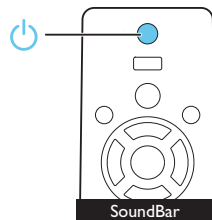

6

- EN** Select the correct audio source
- CS** Zvolte správný zdroj zvuku
- DA** Vælg den korrekte lydkilde
- DE** Korrekte Audioquelle wählen
- EL** Επιλέξτε τη σωστή πηγή ήχου
- ES** Selecciona la fuente de audio correcta
- FI** Valitse oikea äänilähde
- FR** Sélectionner la source audio adéquate
- HU** Válassza ki a megfelelő hangforrást
- IT** Selezionare la sorgente audio corretta
- NL** De juiste audiobron selecteren
- NO** Velg riktig lydkilde
- PL** Wybierz prawidłowe źródło audio
- PT** Seleccionar a fonte de áudio correcta
- RO** Selectarea sursei audio corecte
- SK** Výber správneho zdroja zvuku
- SV** Välj korrekt ljudkälla
- TR** Doğru ses kaynağını seçme

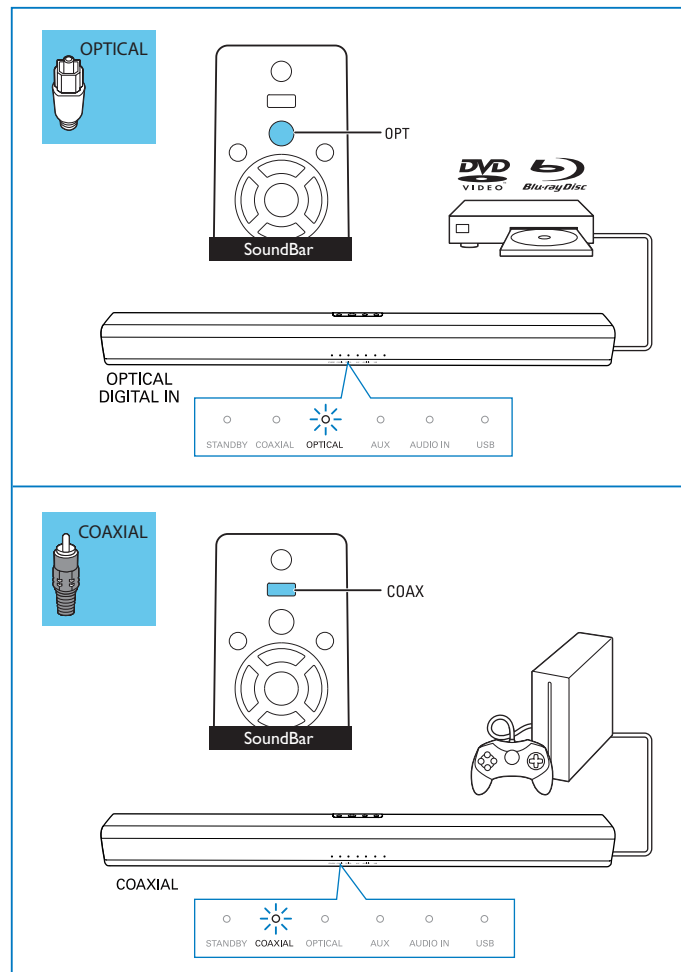

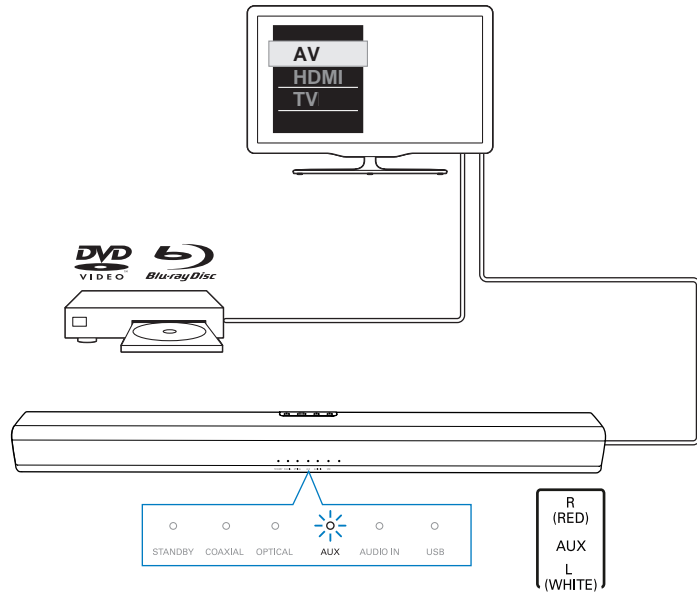
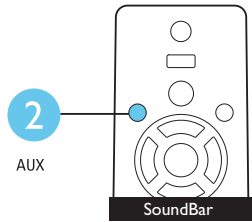
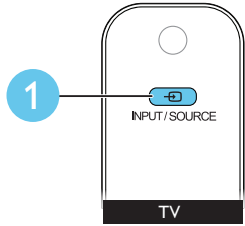
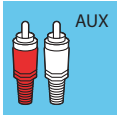

7

- EN** Play other devices
- CS** Spustte z jiného zařízení
- DA** Afspil fra andre enheder
- DE** Andere Geräte abspielen
- EL** Εκτελέστε αναπαραγωγή άλλων συσκευών
- ES** Reproduzca otros dispositivos
- FI** Toista muilla laitteilla
- FR** Lire d'autres périphériques
- HU** Játsszon le másfélel más készülékről
- IT** Riproduzione di altri dispositivi
- NL** Andere apparaten afspelen
- NO** Spill av fra andre enheter
- PL** Odtwarzaj z innych urządzeń
- PT** Reproduzir noutros dispositivos
- RO** Redarea de pe alte dispozitive
- SK** Prehrávanie iných zariadení
- SV** Spela upp från andra enheter
- TR** Diğer cihazlardan içerik oynatma

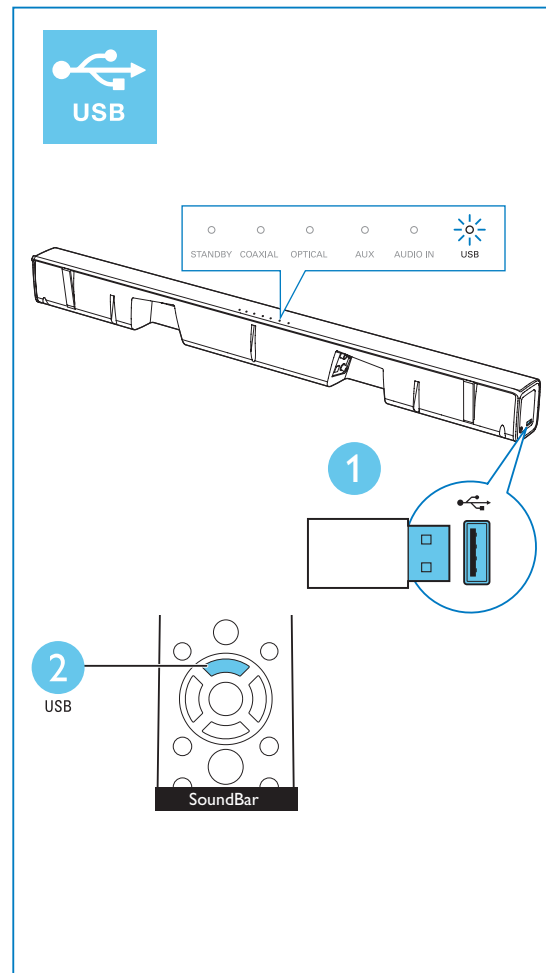
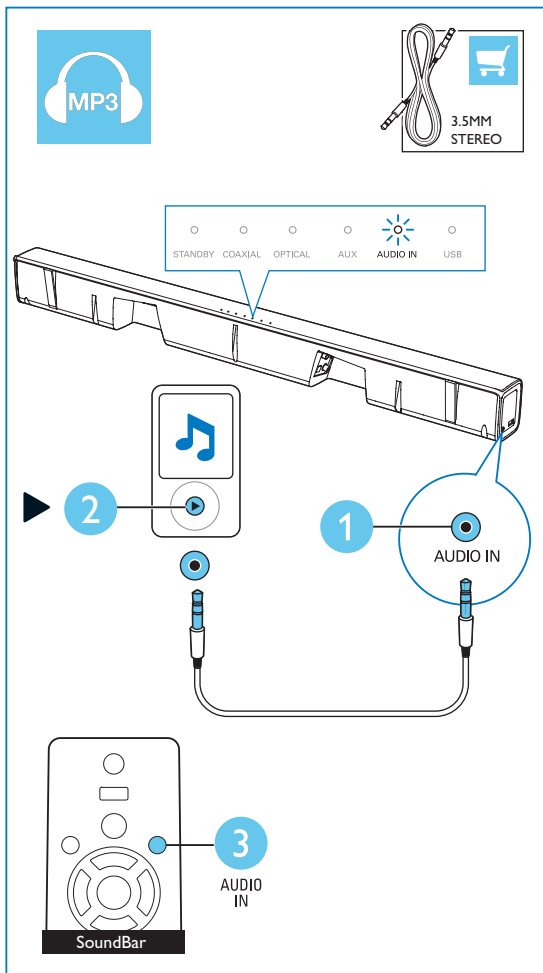



EN For more information about using this product, visit www.philips.com/support

CS Více informací o použití výrobku naleznete na stránkách www.philips.com/support

DA Du kan finde yderligere oplysninger om brugen af dette produkt på www.philips.com/support

DE Weitere Informationen zur Verwendung dieses Produkts finden Sie unter www.philips.com/support

EL Για περισσότερες πληροφορίες σχετικά με τη χρήση αυτού του προϊόντος, επισκεφθείτε το www.philips.com/support

ES Para obtener más información sobre este producto, visite www.philips.com/support

FI Lue lisätietoja tuotteen käytöstä osoitteessa www.philips.com/support

FR Pour obtenir davantage d'informations sur l'utilisation de ce produit, rendez-vous sur www.philips.com/support

HU A termék használatával kapcsolatos további információkkal kapcsolatban tekintse meg a www.philips.com/support weboldalt

IT Per ulteriori informazioni sull'uso di questo prodotto, visitate il sito www.philips.com/support

NL Ga voor meer informatie over dit product naar www.philips.com/support

NO Hvis du vil ha mer informasjon om bruk av dette produktet, kan du gå til www.philips.com/support

PL Więcej informacji na temat korzystania z tego produktu można znaleźć na stronie www.philips.com/support

PT Para mais informações sobre a utilização deste produto, visite www.philips.com/support

RO Pentru informații suplimentare despre utilizarea acestui produs, vizitați www.philips.com/support

SK Ďalšie informácie o používaní tohto výrobku nájdete na stránke www.philips.com/support

SV Mer information om att använda den här produkten finns på www.philips.com/support

TR Bu ürünün kullanımı hakkında daha fazla bilgi için www.philips.com/support adresini ziyaret edin



www.philips.com/support



Manufactured under license from Dolby Laboratories. Dolby and the double-D symbol are trademarks of Dolby Laboratories.



Specifications are subject to change without notice
2015 © Gibson Innovations Limited. All rights reserved.
This product has been manufactured by, and is sold under the responsibility of Gibson Innovations Ltd., and
Gibson Innovations Ltd. is the warrantor in relation to this product. Philips and the Philips Shield Emblem
are registered trademarks of Koninklijke Philips N.V. and are used under license from Koninklijke Philips N.V.

HTL1180B_12_QSG_V2.0

 Be responsible
Respect copyrights

