

# Always there to help you

Register your product and get support at  
[www.philips.com/welcome](http://www.philips.com/welcome)



HTB5520  
HTB5550  
HTB5580

# Quick start guide

**PHILIPS**



Before using your product, read all accompanying safety information



## HTB5520

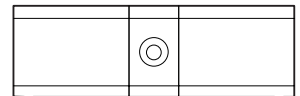
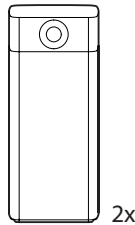
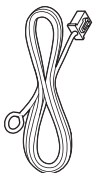
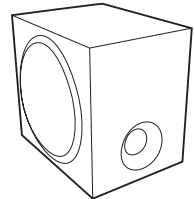
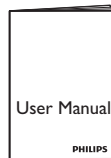
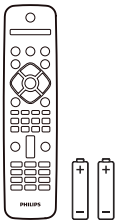
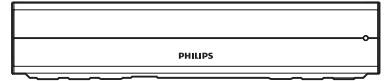
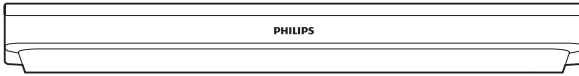

HTB5550

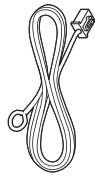
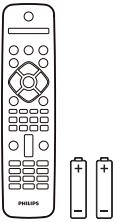
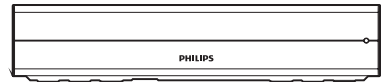
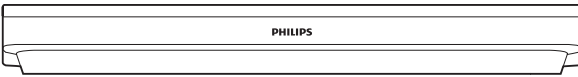

FM Antenna



HDMI

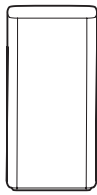
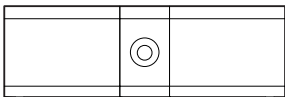
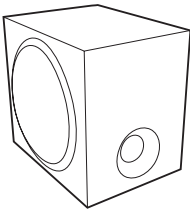
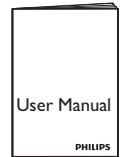

2x



2x

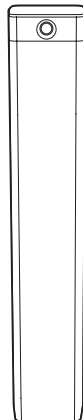

2x



8x



2x

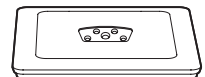

2x

HTB5580

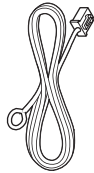
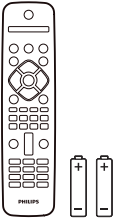
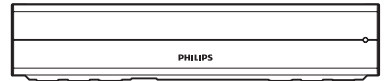
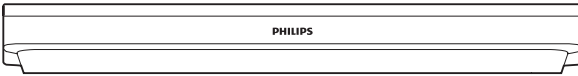

FM Antenna



HDMI

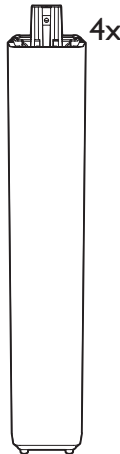
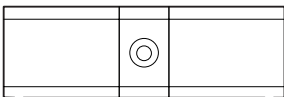
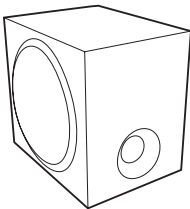
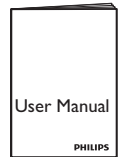

4x

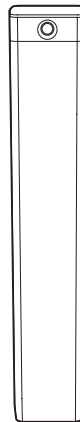

4x



16x



4x



4x

# 1

Stand mount the speakers  
Applied to HTB5550 and HTB5580 only

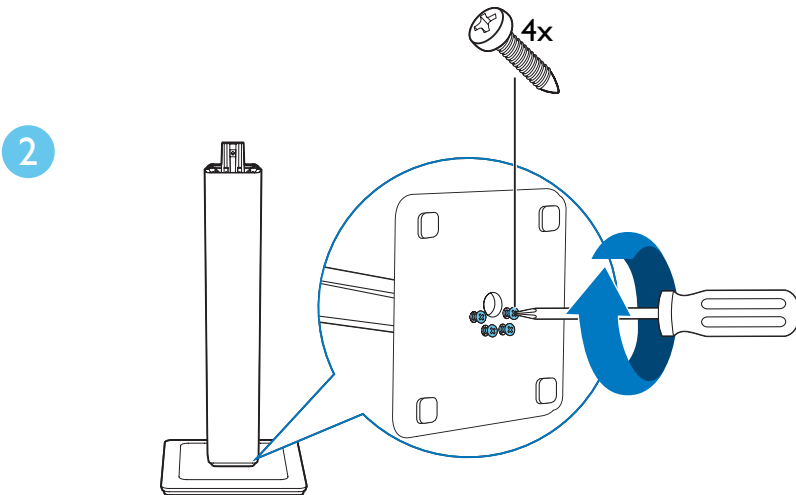
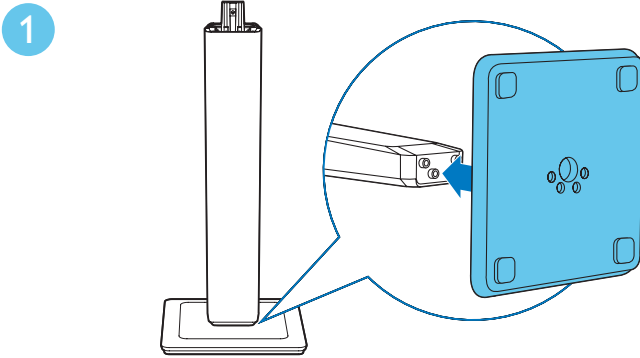

3

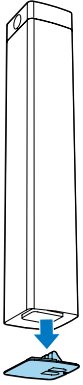

4

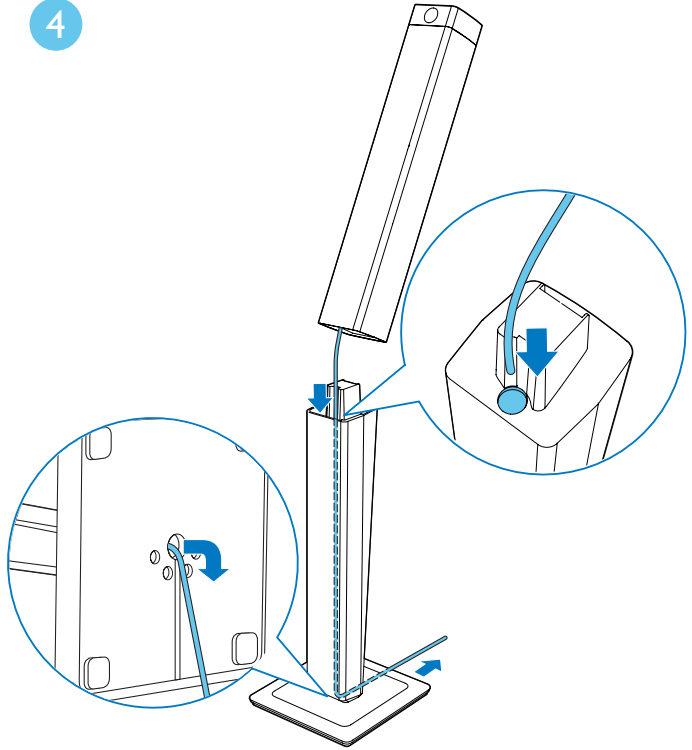

5

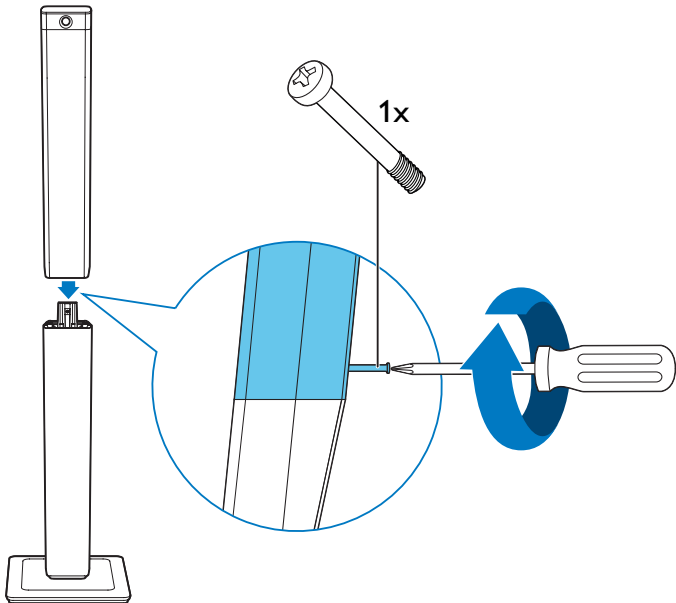

# 2

Connect and position the home theater

## HTB5520

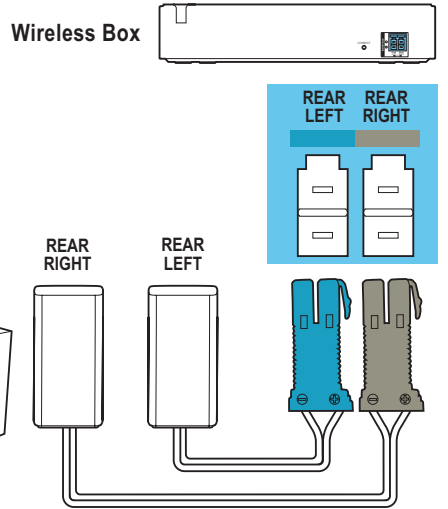
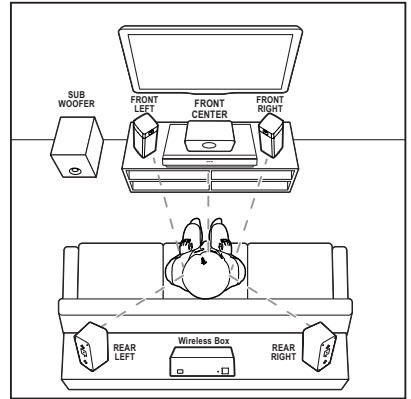
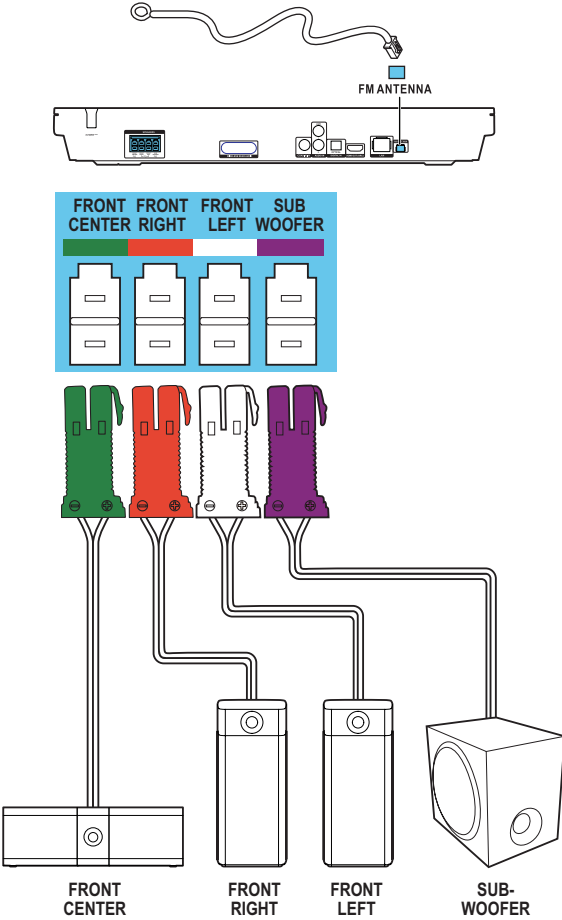

# HTB5550

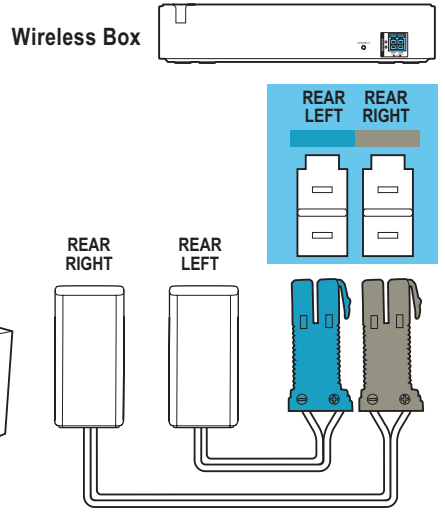
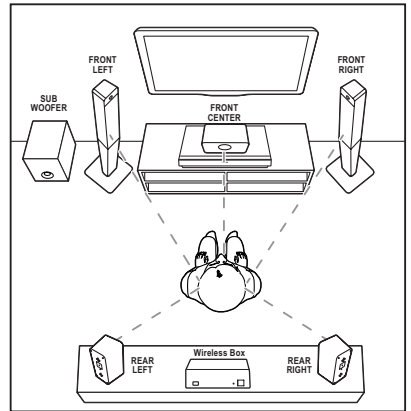
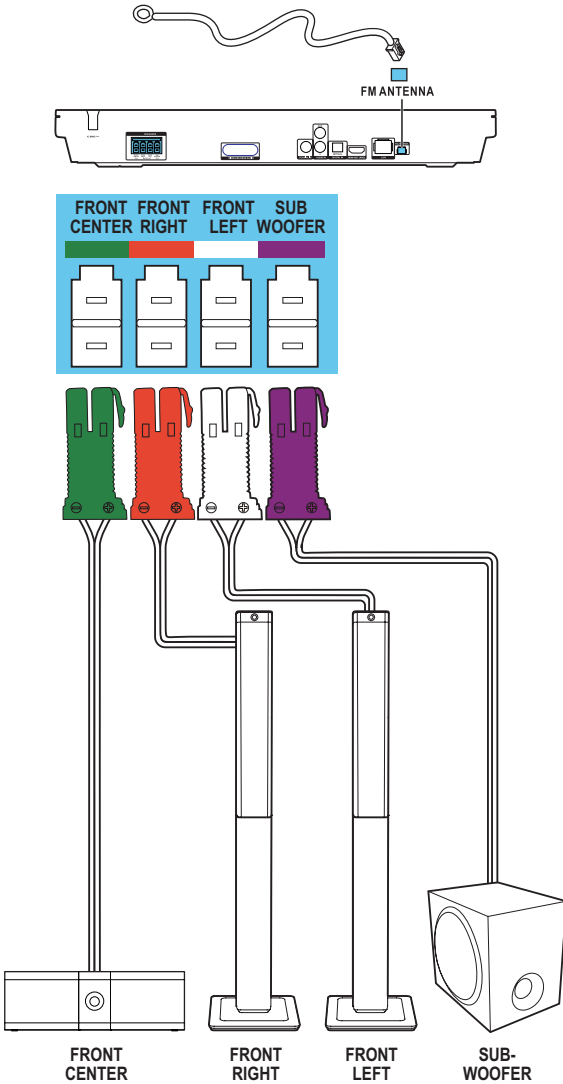



HTB5580

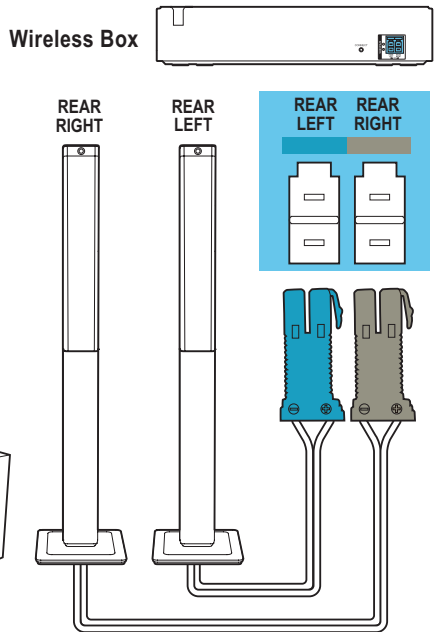
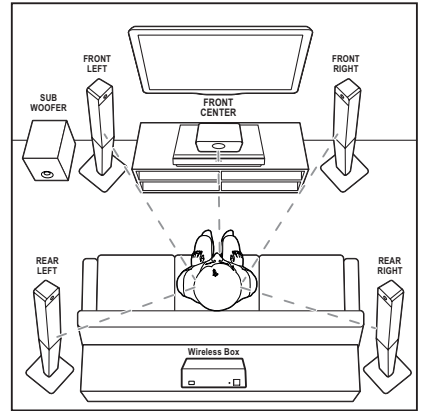
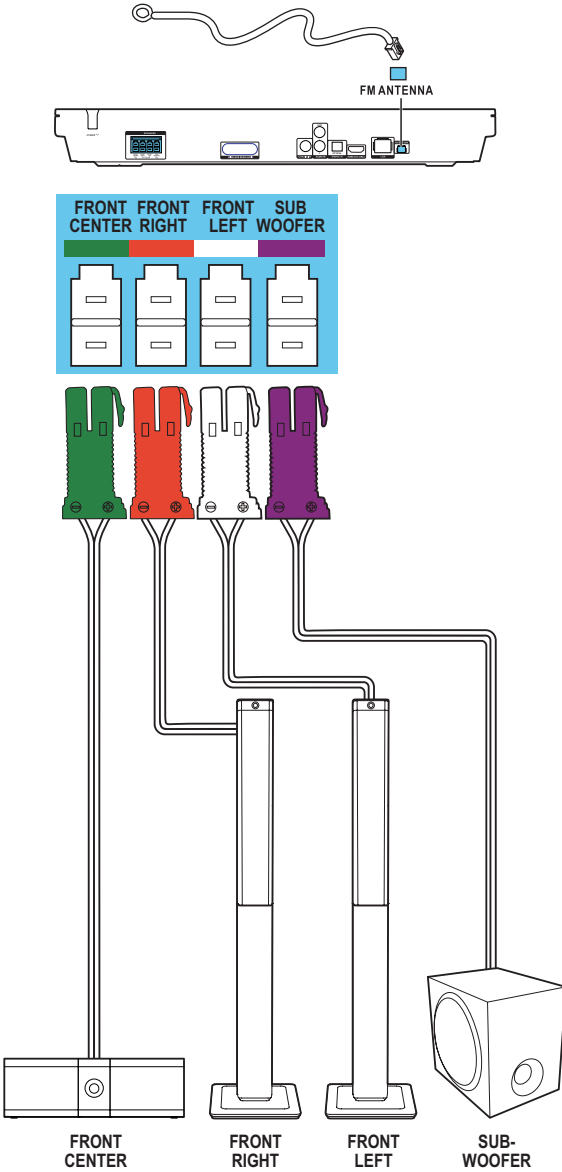

# 3

Connect to TV in one of these ways

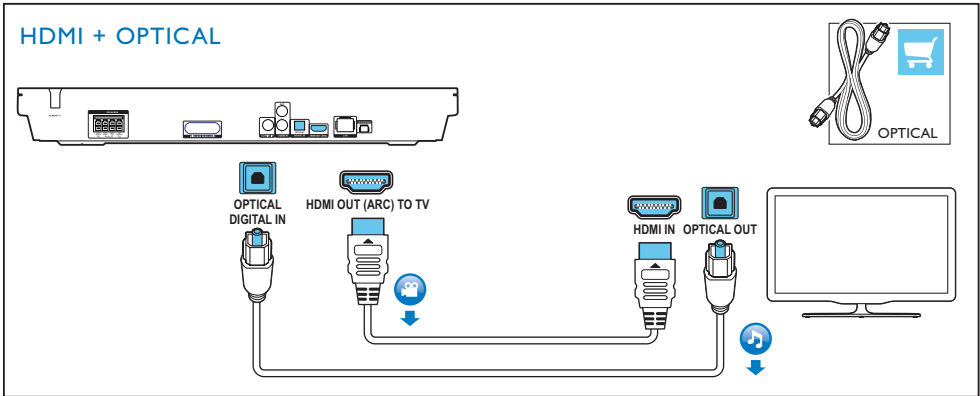
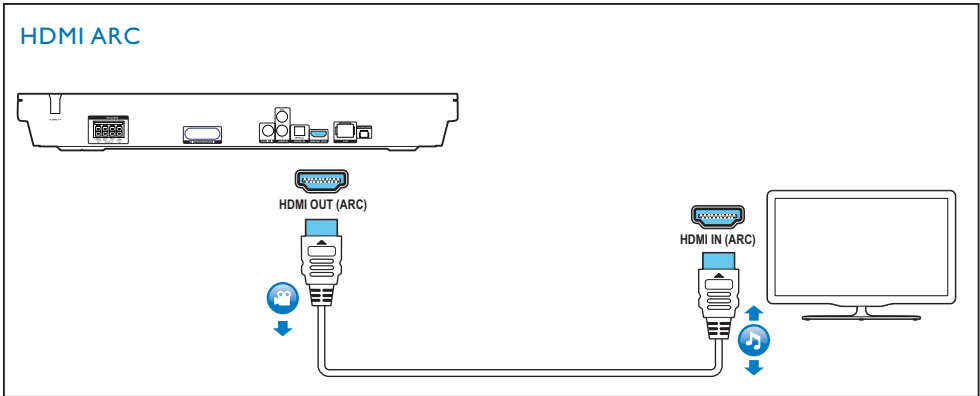

## HDMI + COAXIAL

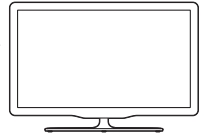
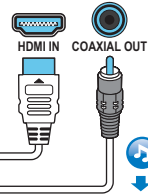
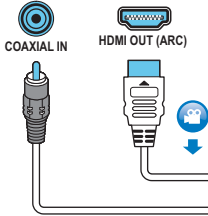
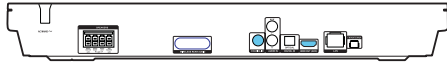

## HDMI + AUDIO L/R

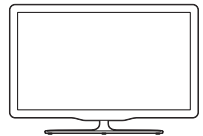
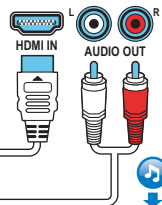
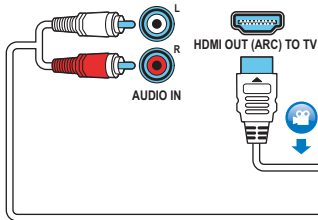

# 4a

Switch on the home theater

1

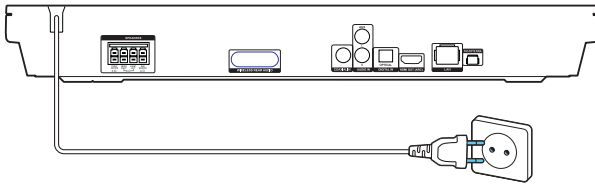

2

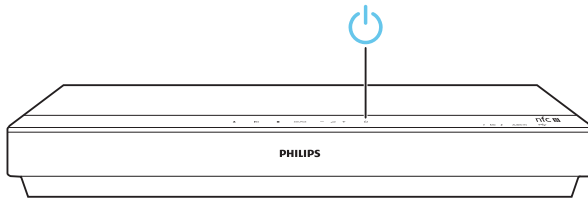

3

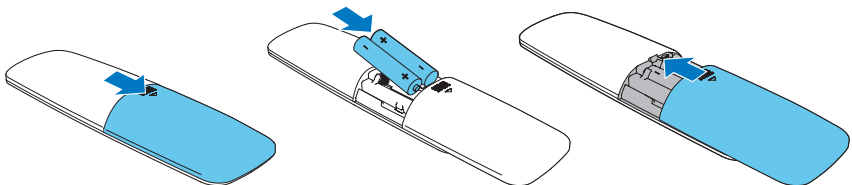

# 4b

Pair up the rear speakers (for the written instructions on pair-up of the rear speakers, refer to Chapter 2 “Connect and setup” of the User Manual)

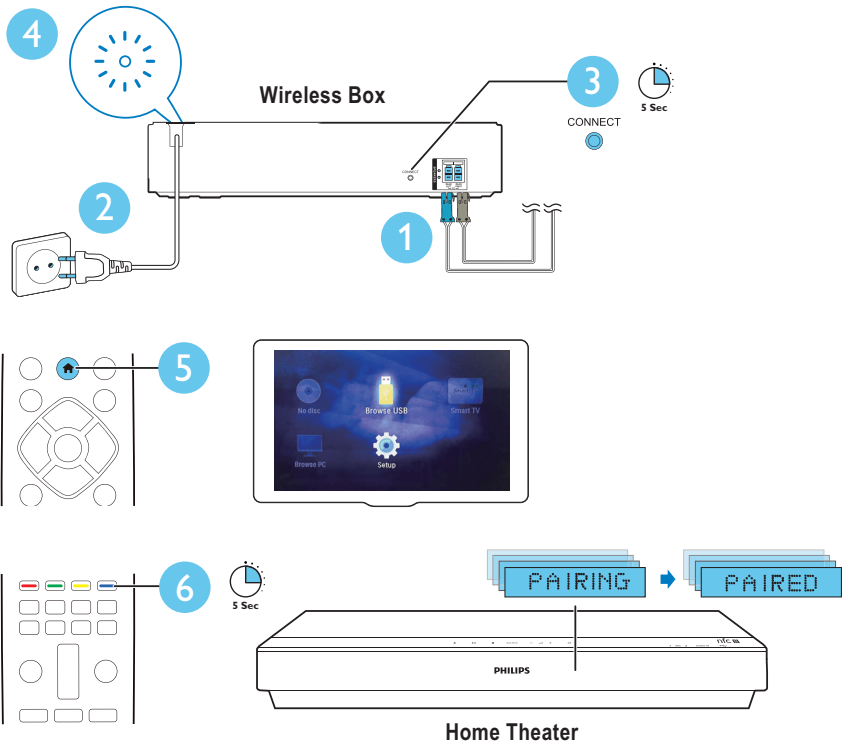

# 5

Complete the first time setup

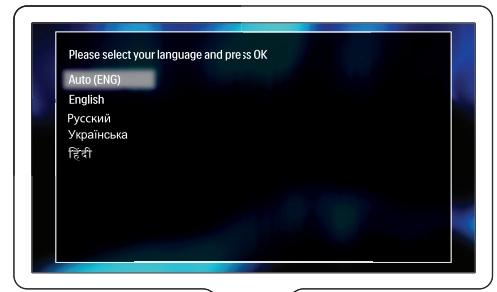
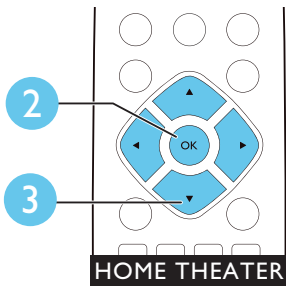
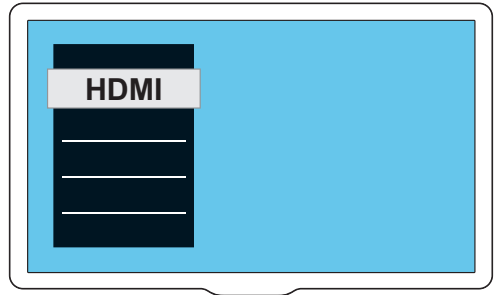
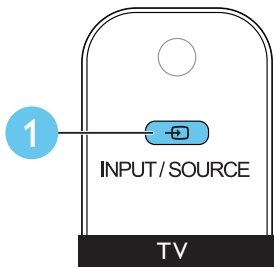

# 6

Use your home theater

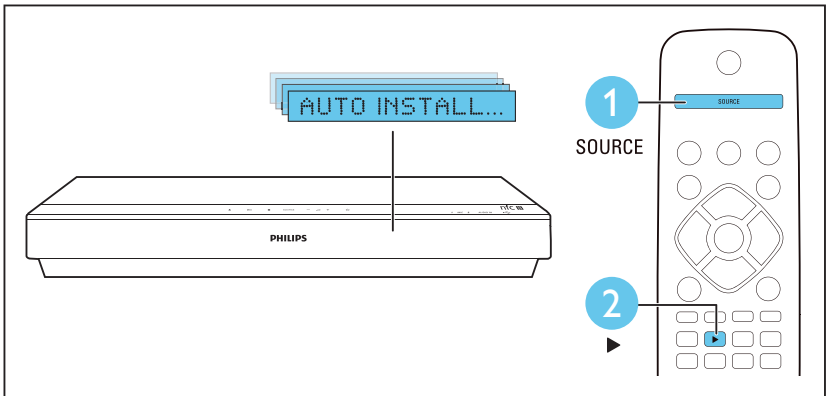
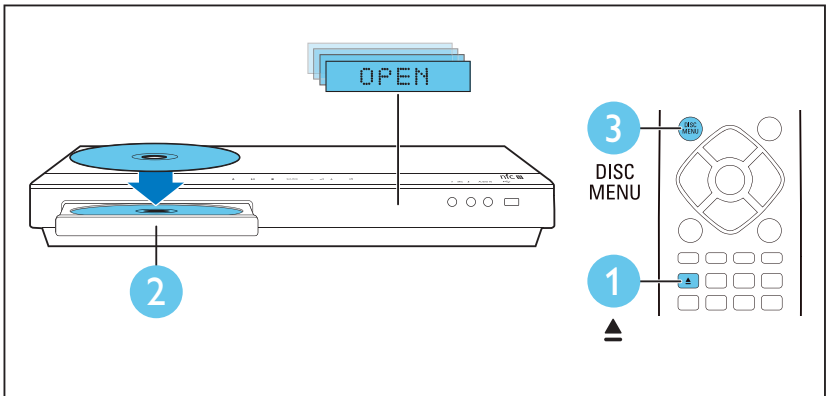

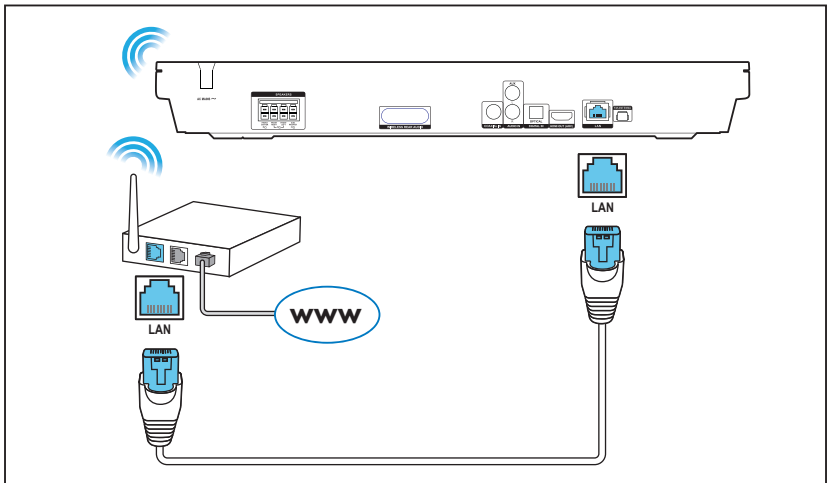
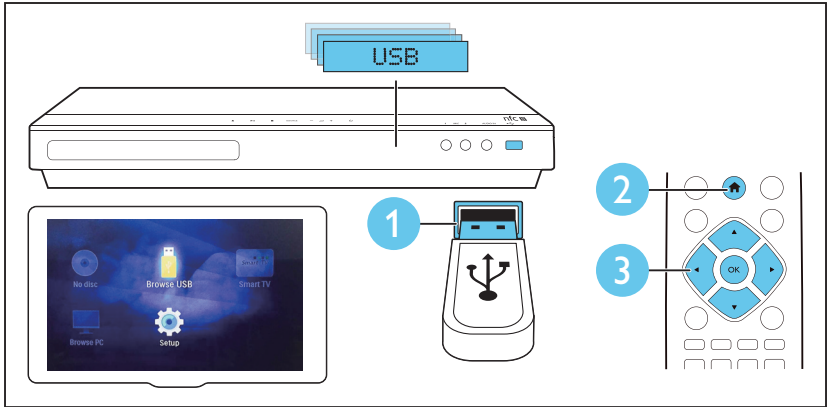
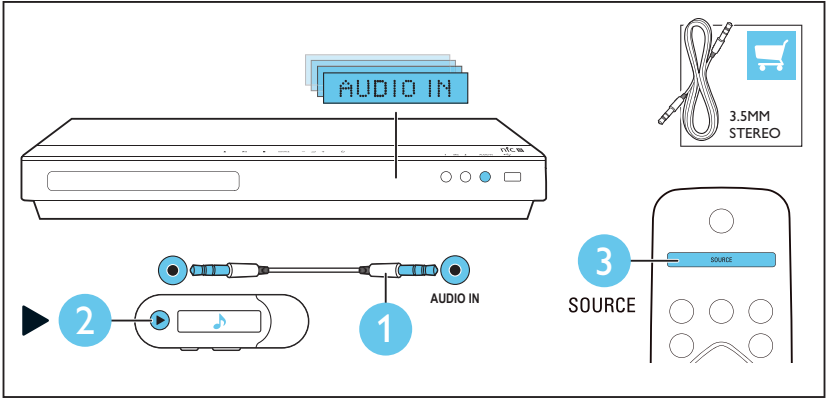



# 7

Play audio through Bluetooth or connect Bluetooth via NFC

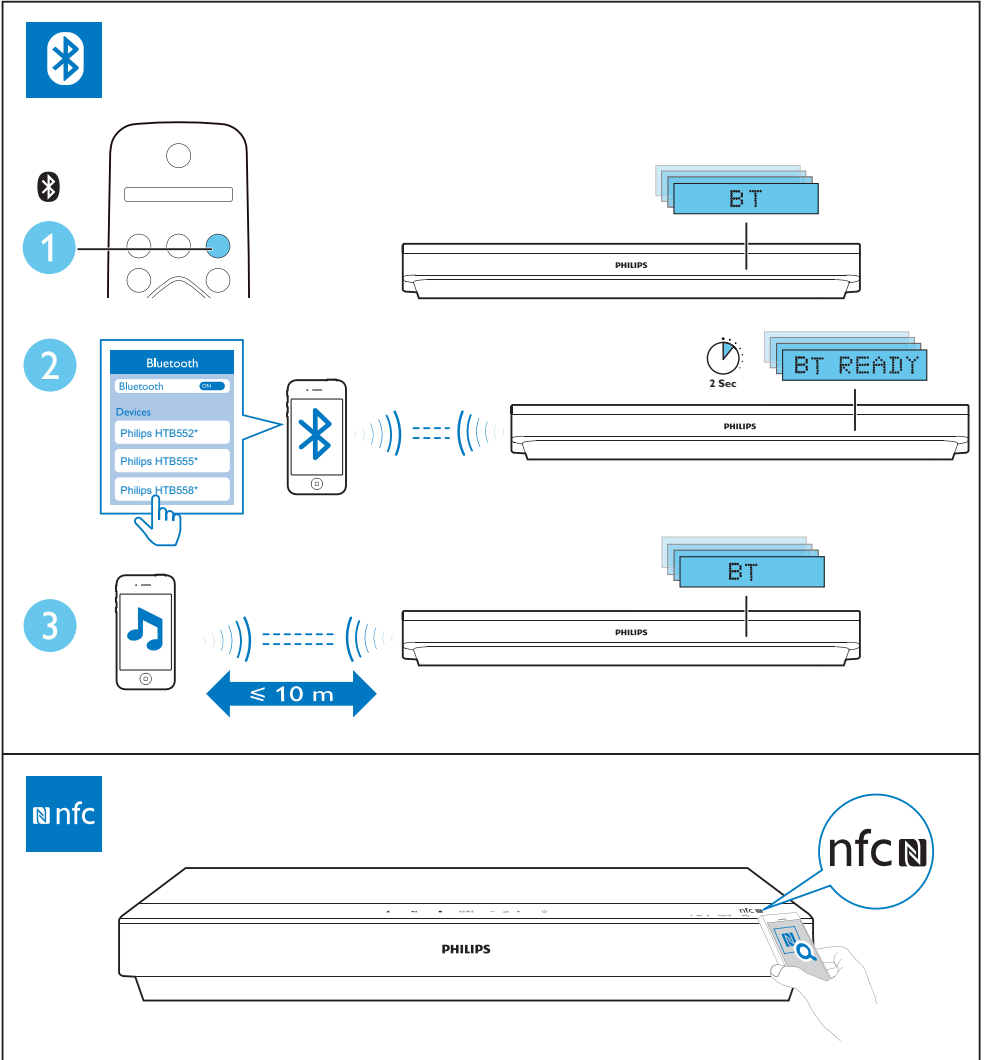



For more information about using this product, visit [www.philips.com/support](http://www.philips.com/support)



[www.philips.com/support](http://www.philips.com/support)



Specifications are subject to change without notice

© 2015 Koninklijke Philips N.V. All rights reserved.

Trademarks are the property of Koninklijke Philips N.V. or their respective owners.

HTD5520/5550/5580\_94\_QSG\_V2.0

