

Register your product and get support at
www.philips.com/welcome

5300 series

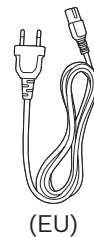

PHILIPS

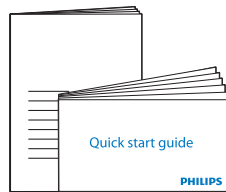
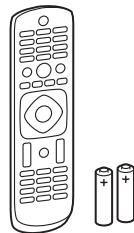
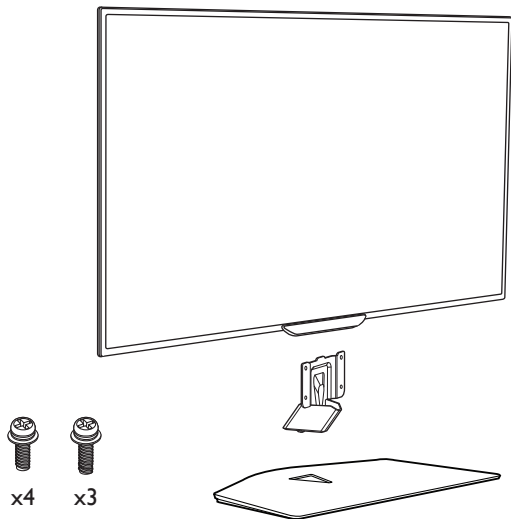

| | |
|------------------|--|
| English | Read the safety instructions. |
| Български | Прочетете инструкциите за безопасност. |
| Čeština | Přečtěte si bezpečnostní pokyny. |
| Hrvatski | Pročitajte sigurnosne upute. |
| Dansk | Læs sikkerhedsforskrifterne. |
| Deutsch | Lesen Sie die Sicherheitshinweise. |
| Ελληνικά | Διαβάστε τις οδηγίες ασφαλείας. |
| Eesti | Lugege ohutusnõudeid. |
| Español | Lea las instrucciones de seguridad. |
| Français | Lisez les consignes de sécurité. |
| Italiano | Leggere le istruzioni di sicurezza. |
| Қазақша | Қорғаныстық нұсқаулар. |
| Latviešu | Izlasiet drošības norādījumus. |
| Lietuvių | Perskaitykite saugos instrukcijas. |
| Magyar | Olvassa el a biztonsági utasításokat. |

| | |
|--------------------|---|
| Nederlands | Lees de veiligheidsvoorschriften. |
| Norsk | Les sikkerhetsforskriftene. |
| Polski | Zapoznaj się z instrukcjami bezpieczeństwa. |
| Português | Leia as instruções de segurança. |
| Română | Citiți instrucțiunile de siguranță. |
| Русский | Читайте инструкции по технике безопасности. |
| Srpski | Pročitajte bezbednosna uputstva . |
| Slovenščina | Preberite varnostna navodila. |
| Slovenský | Prečítajte si bezpečnostné pokyny. |
| Suomi | Lue turvaohjeet. |
| Svenska | Läs säkerhetsinstruktionerna. |
| ภาษาไทย | โปรดอ่านคำแนะนำด้านความปลอดภัย |
| Türkçe | Güvenlik talimatlarını okuyun. |
| Українська | Читайте інструкції з техніки безпеки. |

العربية قراءة تعليمات السلامة.
עברית קראו את הוראות הבטיחות

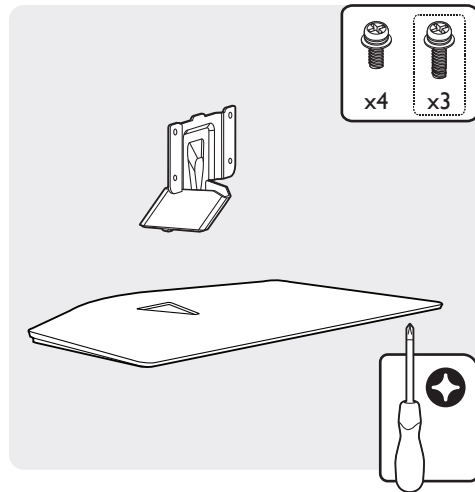

1

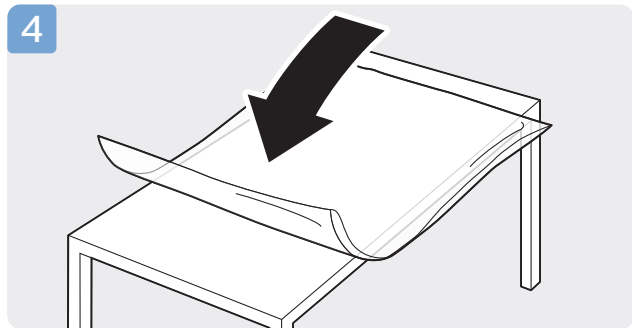
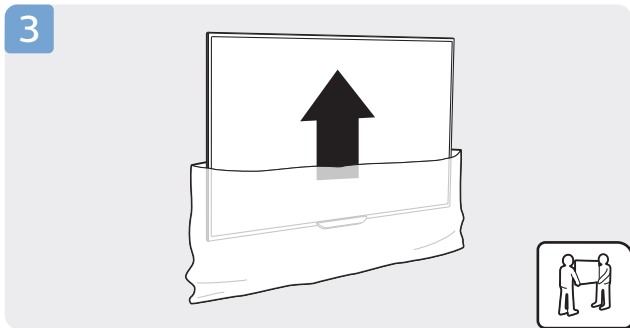
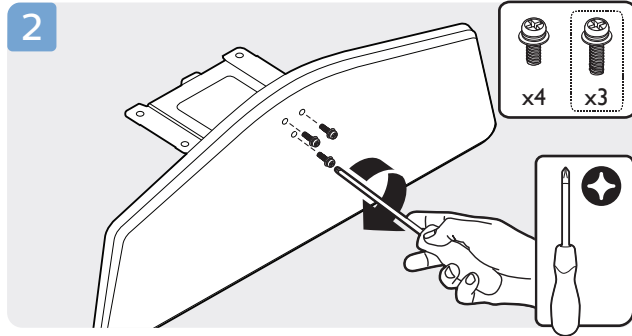
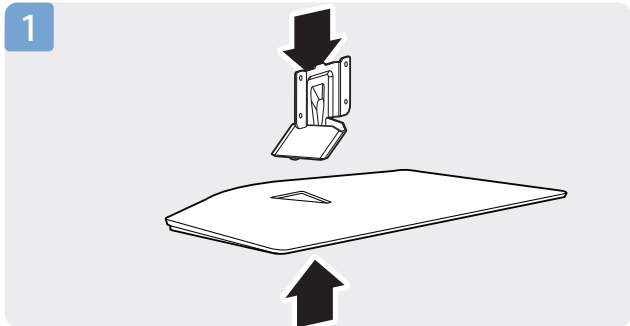

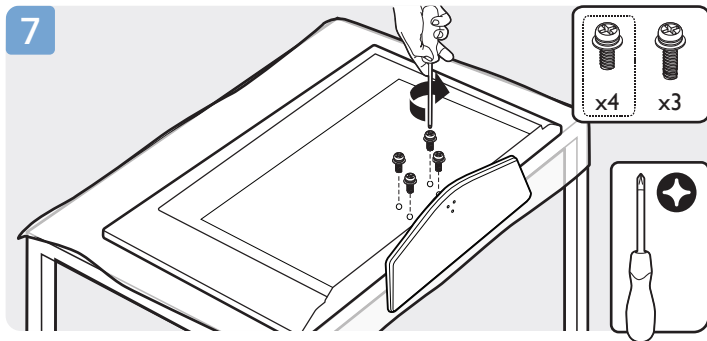
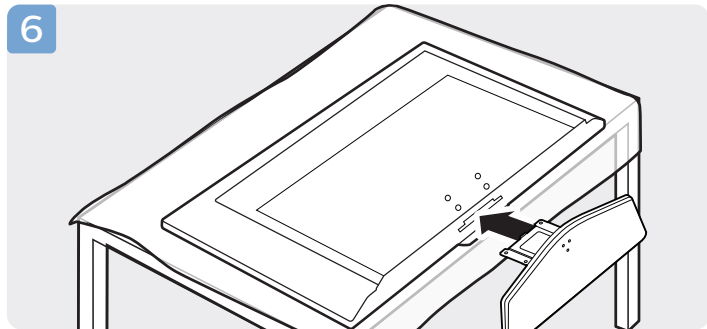
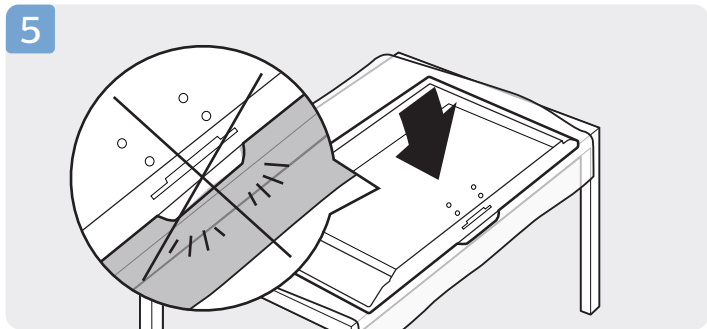

VESA (x,y)
50" 400x200 M6

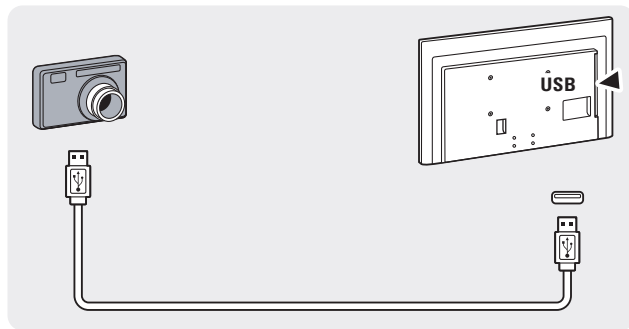
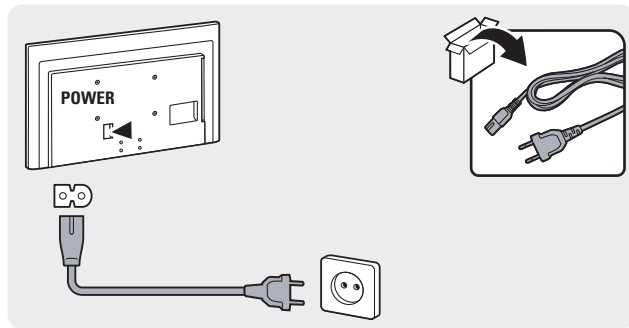
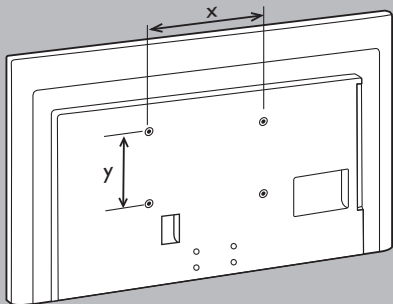

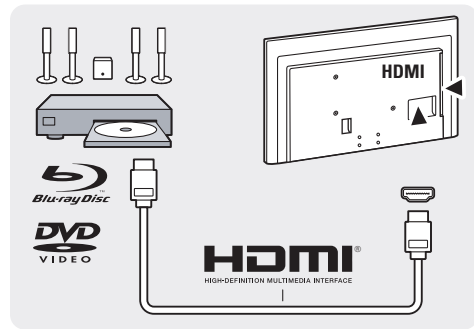
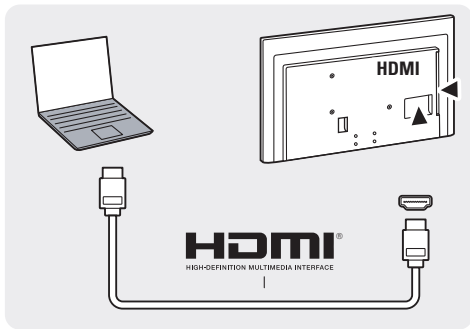
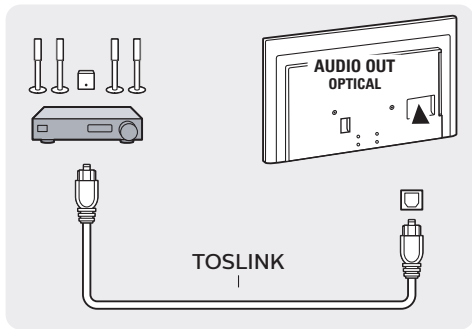
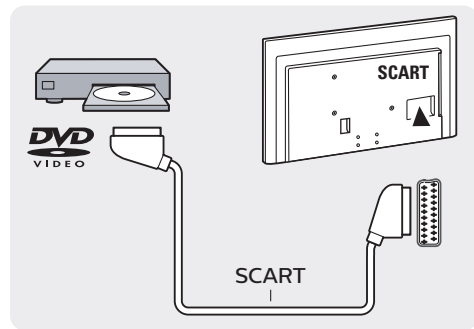
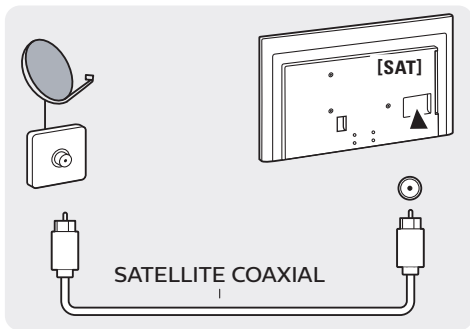
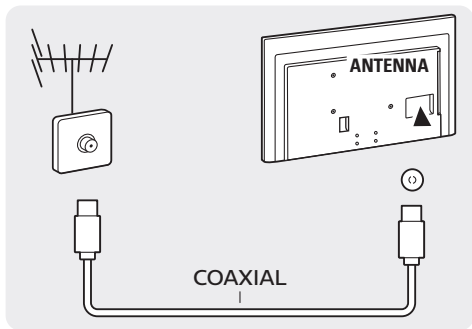

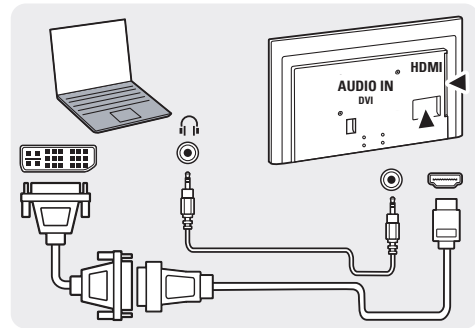
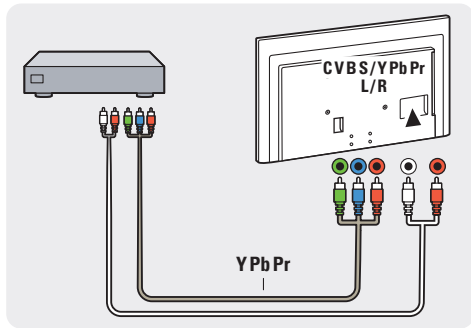
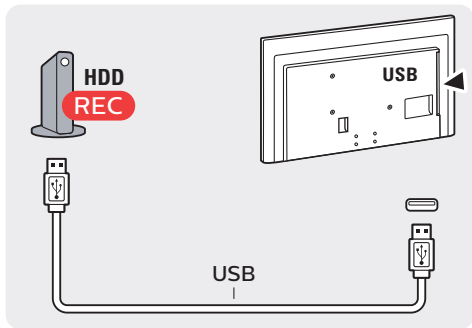
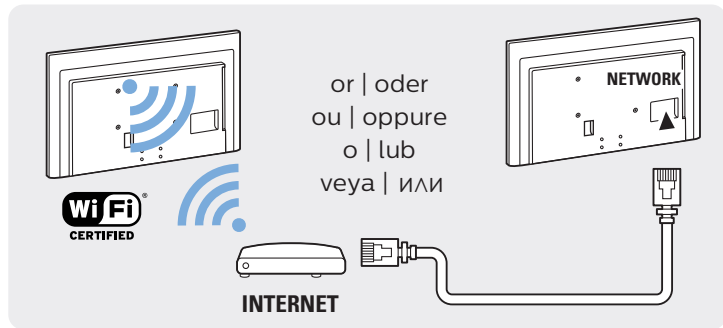
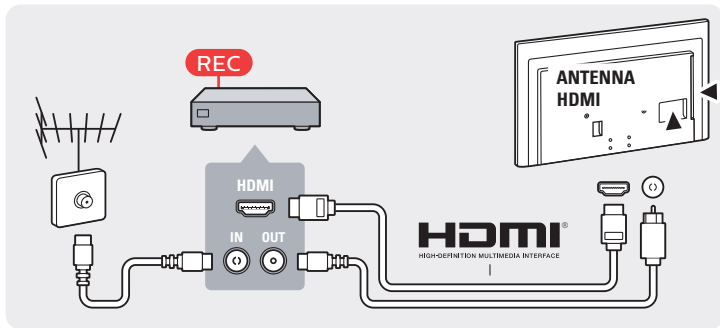

3

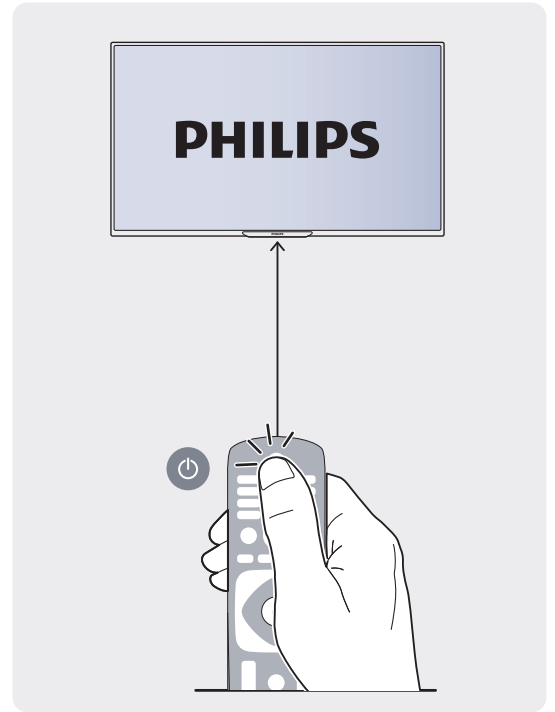
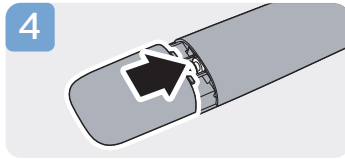
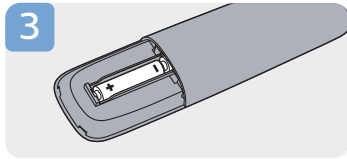
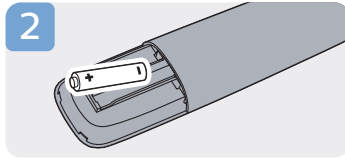
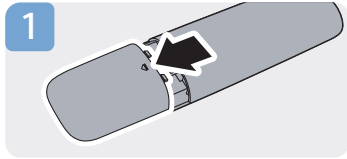

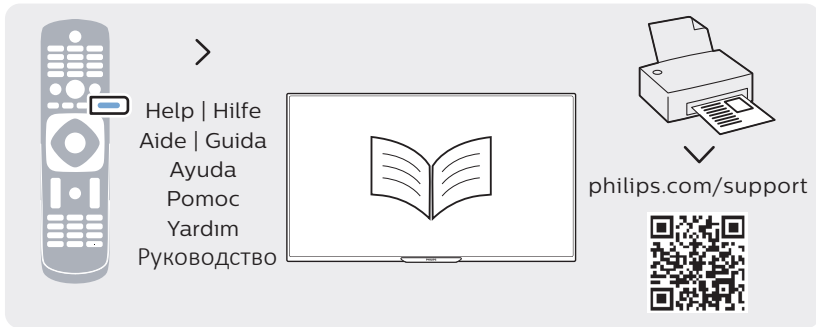
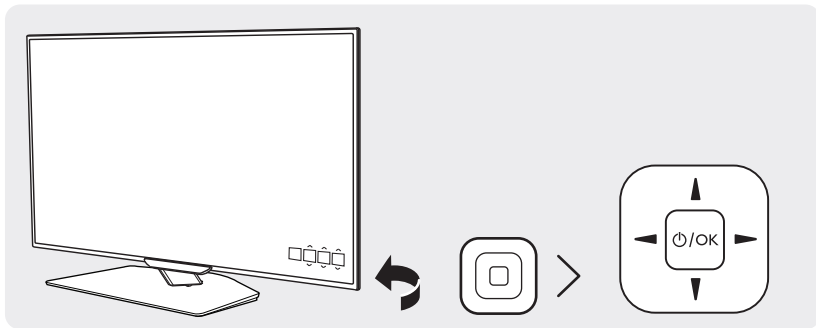



User Manual



FAQ



Chat



Forum



Call



Email



Warranty

www.philips.com/support

България

Грижа за клиента
02 4916 273
(Национален номер)

België/Belgique

Klantenservice/
Service Consommateurs
02 700 72 62
(0,15€/min.)

Bosna i Hercegovina

Potpora potrošačima
033 941 251
(Lokalni poziv)

Republika Srbija

Potpora potrošačima
011 321 6840
(Lokalni poziv)

Česká republika

Zákaznická podpora
228 880 895
(Místní tarif)

Danmark

Kundeservice
3525 8314

Deutschland

Kundendienst
069 66 80 10 10
(Zum Festnetzтариф ihres
Anbieters)

Ελλάδα

Τμήμα καταναλωτών
2111983028
(Διεθνής κλήση)

Eesti

Klienditugi
668 30 61
(Kohalikud kõned)

España

Atención al consumidor
913 496 582
(0,10€ + 0,08€/min.)

France

Service Consommateurs
01 57 32 40 50
(coût d'un appel local sauf
surcoût éventuel selon
opérateur réseau)

Hrvatska

Potpora potrošačima
01 777 66 01
(Lokalni poziv)

Ireland

Consumer Care
0150 284 21 40
(National Call)

Italia

Servizio Consumatori
02 452 870 14
(Chiamata nazionale)

Қазақстан

Республикасы
байланыс орталығы
810 800 2000 00 04
(стационарлық нөмірлерден
Қазақстан Республикасы
бойынша қоңырау шалу тегін)

Latvija

Klientu atbalsts
6616 32 63
(Vietēlais tarifs)

Lietuva

Klientų palaikymo
tarnyba
8 521 402 93
(Vietinai tarifais)

Luxembourg

Service Consommateurs
2487 11 00
(Appel national)/(Nationale
Ruf)

Magyarország

Ügyfélszolgálat
(061) 700 81 51
(Belföldi hívás)

Nederland

Klantenservice
0900 202 08 71
(0,10€/min.)

Norge

Forbrukerstøtte
22 97 19 14

Österreich

Kundendienst
0150 284 21 40
(0,145€/Min.)

Республика Беларусь

Контакт Центр
8 10 (800) 2000 00 04
(бесплатный звонок по
Республике Беларусь со
стационарных номеров)

Российская Федерация

Контакт Центр
8 (800) 220 00 04
(бесплатный звонок по
России)

Polska

Wsparcie Klienta
22 397 15 04
(Połączenie lokalne)

Portugal

Assistência a clientes
800 780 068
(0,12€/min. – Móvel 0,30€/min.)

România

Serviciul Clienti
031 630 00 42
(Tarif local)

Schweiz/Suisse/

Svizzera
Kundendienst/Service
Consommateurs/
Servizio Consumatori
0848 000 291
(0,081 CHF/Min)

Slovenija

Skrb za potrošnike
01 88 88 312
(Lokalni klic)

Slovensko

Zákaznická podpora
02 332 154 93
(vnútroštátny hovor)

Suomi

Finland Kuluttajapalvelu
09 88 62 50 40

Sverige

Kundtjänst
08 57 92 90 96

Türkiye

Tüketiciler Hizmetleri
0 850 222 44 66

Україна

Служба підтримки
споживачів
0-800-500-480
(дзвінки зі
стаціонарних телефонів
безкоштовні)

United Kingdom

Consumer Care
020 79 49 03 19
(5p/min BT landline)

Argentina

Consumer Care
0800 444 77 49
- Buenos Aires
0810 44 7782

Brasil

Suporte ao Consumidor
0800 701 02 45
- São Paulo
29 38 02 45



All registered and unregistered trademarks are property of their respective owners. Specifications are subject to change without notice. Philips and the Philips' shield emblem are trademarks of Koninklijke Philips N.V. and are used under license from Koninklijke Philips N.V. 2015 © TP Vision Europe B.V. All rights reserved. philips.com