

Always there to help you

Register your product and get support at
www.philips.com/support

HTL1177B



User manual

EN: For further assistance, call the customer support service in your country.

- To obtain assistance in the U.S.A., Canada, Puerto Rico, or the U.S. Virgin Islands, contact Philips Customer Care Center at 1 (866) 226-6074
- To obtain assistance in Mexico, contact Philips Customer Care Center at 01 800 839 1989; Mexico city: 5887-9736

For Product recycling information, please visit - www.recycle.philips.com

PHILIPS

Contents

1	Important	2
	Help and support	2
	Important safety instructions	2
	Care for your product	4
	Care of the environment	4

2	Your SoundBar	4
	Main unit	4
	Remote control	5
	Connectors	6

3	Connect	6
	Placement	6
	Connect audio from TV and other devices	7

4	Use your SoundBar	8
	Adjust the volume	8
	Choose your sound	8
	MP3 player	9
	USB storage devices	9
	Play audio through Bluetooth	10
	Apply factory settings	10
	Update software	10

5	Wall mount	11
----------	-------------------	----

6	Product specifications	11
----------	-------------------------------	----

7	Troubleshooting	12
----------	------------------------	----

8	Notice	13
----------	---------------	----

1 Important

Read and understand all instructions before you use your product. If damage is caused by failure to follow instructions, the warranty does not apply.

Help and support

For extensive online support, visit www.philips.com/support to:

- download the user manual and the quick start guide
- watch video tutorials (available only for selected models)
- find answers to frequently answered questions (FAQs)
- email us a question
- chat with our support representative.

Follow the instructions on the website to select your language, and then enter your product model number.

Alternatively, you can contact Consumer Care in your country. Before you contact, note down the model number and serial number of your product. You can find this information on the back or bottom of your product.

Important safety instructions

- **Read these instructions.**
 - **Keep these instructions.**
 - **Heed all warnings.**
 - **Follow all instructions.**
 - **Do not use this apparatus near water.**
 - **Clean only with dry cloth.**
 - **Do not block any ventilation openings.**
- Install in accordance with the manufacturer's instructions.**

- **Do not install near any heat sources** such as radiators, heat registers, stoves, or other apparatus (including amplifiers) that produce heat.



- **Do not defeat the safety purpose** of the polarized or grounding-type plug. A polarized plug has two blades with one wider than the other. A grounding type plug has two blades and a third grounding prong. The wide blade or the third prong are provided for your safety. If the provided plug does not fit into your outlet, consult an electrician for replacement of the obsolete outlet.
- **Protect the power cord** from being walked on or pinched, particularly at plugs, convenience receptacles, and the point where they exit from the apparatus.
- **Only use attachments/accessories** specified by the manufacturer:



- **Use only with the cart**, stand, tripod, bracket or table specified by the manufacturer or sold with the apparatus. When a cart is used, use caution when moving the cart/apparatus combination to avoid injury from tip-over.
- **Unplug this apparatus** during lightning storm or when unused for long periods of time.
- **Refer all servicing** to qualified service personnel. Servicing is required when the apparatus has been damaged in any way, such as power-supply cord or plug is damaged, liquid has been spilled or objects have fallen into the apparatus, the apparatus has been exposed to rain or moisture, does not operate normally, or has been dropped.

- **Battery usage CAUTION** - To prevent battery leakage which may result in bodily injury, property damage, or damage to the unit:
 - Install **all** batteries correctly, + and - as marked on the unit.
 - Do not mix batteries (**old and new** or **carbon and alkaline**, etc.).
 - Remove batteries when the unit is not used for a long time.
 - The batteries shall not be exposed to excessive heat such as sunshine, fire or the like.
 - Perchlorate Material - special handling may apply. See www.dtsc.ca.gov/hazardouswaste/perchlorate.
- The product/remote control may contain a coin/button type battery, which can be swallowed. Keep the battery out of reach of children at all times! If swallowed, the battery can cause serious injury or death. Severe internal burns can occur within two hours of ingestion.
- If you suspect that a battery has been swallowed or placed inside any part of the body, seek immediate medical attention.
- When you change the batteries, always keep all new and used batteries out of reach of children. Ensure that the battery compartment is completely secure after you replace the battery.
- If the battery compartment cannot be completely secured, discontinue use of the product. Keep out of reach of children and contact the manufacturer.
- **Apparatus shall not be exposed to dripping or splashing.**
- **Do not place any sources of danger on the apparatus** (for example, liquid filled objects, lighted candles).
- This apparatus may contain lead and mercury. Dispose according to local, State or Federal laws. For disposal or recycling information, please contact your local authorities. For additional assistance on recycling options, please contact www.mygreenelectronics.com or www.eiae.org or www.recycle.philips.com.

- Where the MAINS plug or an appliance coupler is used as the disconnect device, the disconnect device shall remain readily operable.
- Do not place this apparatus on the furniture that is capable of being tilted by a child and an adult leaning, pulling, standing or climbing on it. A falling apparatus can cause serious injury or even death.
- This apparatus should not be placed in a built-in installation such as a bookcase or rack unless proper ventilation is provided. Make sure to leave a space of 7.8 inches (20cm) or more around this apparatus.

Class II equipment symbol



This symbol indicates that the unit has a double insulation system.



This 'bolt of lightning' indicates uninsulated material within your unit may cause an electrical shock. For the safety of everyone in your household, please do not remove product covering.



The 'exclamation point' calls attention to features for which you should read the enclosed literature closely to prevent operating and maintenance problems.

WARNING: To reduce the risk of fire or electric shock, this apparatus should not be exposed to rain or moisture and objects filled with liquids, such as vases, should not be placed on this apparatus.

CAUTION: To prevent electric shock, match wide blade of plug to wide slot, fully insert.

Care for your product

Use only microfiber cloth to clean the product.

Care of the environment

Disposal of your old product and battery



Your product is designed and manufactured with high quality materials and components, which can be recycled and reused.

This product may contain lead and mercury. Disposal of these materials may be regulated due to environmental considerations. For disposal or recycling information, please contact your local authorities or visit www.recycle.philips.com.

This product contains batteries:

- Dispose of batteries properly. Do not incinerate. Batteries may explode if overheated.
- Do not wrap in metal or aluminum foil. Wrap in newspaper before discarding.
- It is suggested that you contact your local town or city to determine proper battery redemption site(s) in your area.
- Please visit www.call2recycle.org for additional information on a recycling center in your area for rechargeable batteries.

2 Your SoundBar

Congratulations on your purchase, and welcome to Philips! To fully benefit from the support that Philips offers, register your SoundBar at www.philips.com/welcome.

Main unit

This section includes an overview of the main unit.

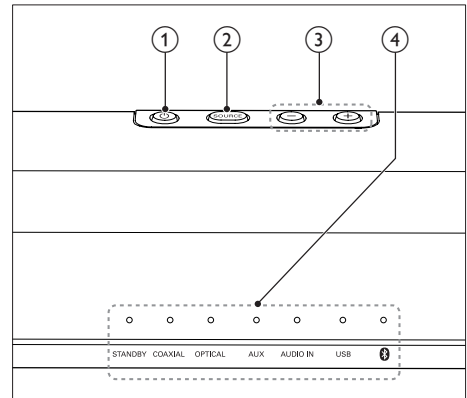

- ① Switch the SoundBar on or to standby.
- ② **SOURCE**
Select an input source for the SoundBar.
- ③ **Volume+/-**
Increase or decrease volume.
- ④ **LED indicators**
 - **STANDBY:** Lights up when the SoundBar is in standby.
 - **COAXIAL:** Lights up when you switch to coaxial input source.
 - **OPTICAL:** Lights up when you switch to optical input source.
 - **AUX:** Lights up when you switch to analog input source.
 - **AUDIO IN:** Lights up when you switch to audio input source (3.5mm jack).

- **USB:** Lights up you switch to USB source.
- **🔌**
Lights up when you switch to Bluetooth mode and Bluetooth devices are paired.
Blinks when you switch to Bluetooth mode and Bluetooth devices are not paired.

- **AUX:** Switch your audio source to the AUX connection.
- **AUDIO IN:** Switch your audio source to the MP3 connection (3.5mm jack).
- **🔌**: Switch to Bluetooth mode.
- **USB:** Switch your audio source to the USB connection.

Remote control

This section includes an overview of the remote control.

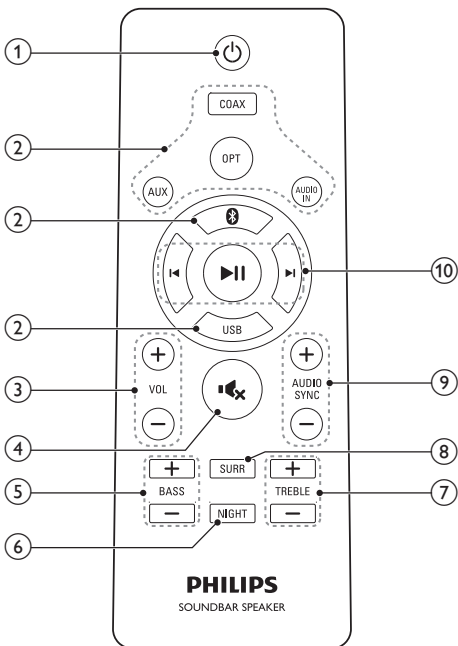

- +/- (Volume)**
 - Increase or decrease volume.
- 🔌**
Mute or restore volume.
- BASS +/-**
Increase or decrease bass.
- NIGHT**
Turn night mode on or off.
- TREBLE +/-**
Increase or decrease treble.
- SURR**
 - Toggle between stereo and virtual surround sound.
- AUDIO SYNC +/-**
Applicable to **COAXIAL (COAX)** and **OPTICAL (OPT)** sources only. Increase or decrease audio delay.
- Play buttons**
 - **▶||**: Play, pause or resume play in USB mode and Bluetooth mode (only for AVRCP-supported Bluetooth devices).
 - **⏮ / ⏭**: Skip to the previous or next track in USB mode and Bluetooth mode (only for AVRCP-supported Bluetooth devices).

- ⏻ (Standby-On)**
Switch the SoundBar on or to standby.

- Source buttons**
 - **COAX:** Switch your audio source to the coaxial connection.
 - **OPT:** Switch your audio source to the optical connection.

Connectors

This section includes an overview of the connectors available on your SoundBar:

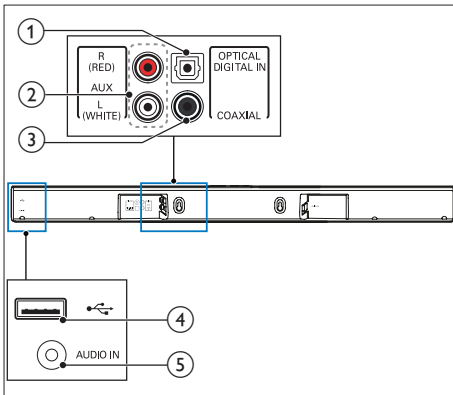

- ① **DIGITAL IN-OPTICAL**
Connect to an optical audio output on the TV or a digital device.
- ② **AUX**
Connect to an analog audio output on the TV or an analog device.
- ③ **COAXIAL**
Connect to a coaxial audio output on the TV or a digital device.
- ④ 
Audio input from a USB storage device.
- ⑤ **AUDIO IN**
Audio input from, for example, an MP3 player (3.5mm jack).

3 Connect

This section helps you connect your SoundBar to a TV and other devices.

For information about the basic connections of your SoundBar and accessories, see the quick start guide.

Note

- For identification and supply ratings, refer to the type plate at the back or bottom of the product.
- Before you make or change any connections, make sure that all devices are disconnected from the power outlet.

Placement

Place your Soundbar as shown below.

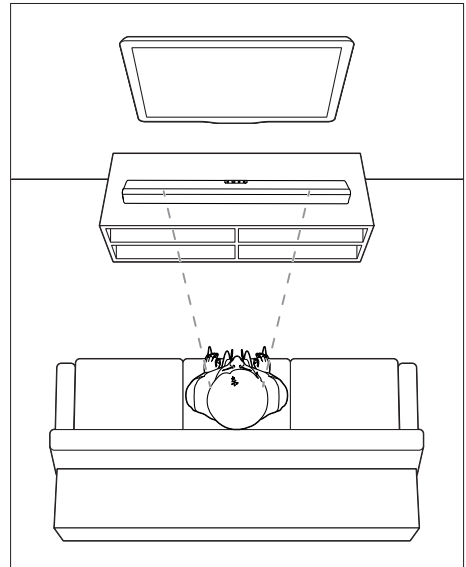

Connect audio from TV and other devices

Play audio from TV or other devices through your Soundbar.

Use the best quality connection available on your TV and other devices.

Option 1: Connect audio through a digital optical cable

Best quality audio

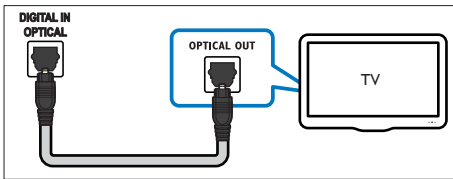

- 1 Using an optical cable, connect the **OPTICAL** connector on your SoundBar to the **OPTICAL OUT** connector on the TV or other device.
 - The digital optical connector might be labeled **SPDIF** or **SPDIF OUT**.

Option 2: Connect audio through a digital coaxial cable

Best quality audio

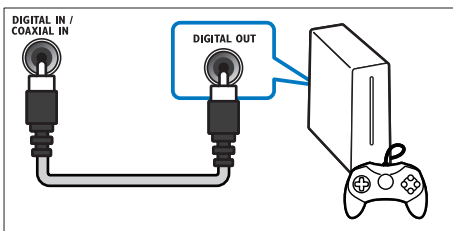

- 1 Using a coaxial cable, connect the **COAXIAL** connector on your SoundBar to the **COAXIAL/DIGITAL OUT** connector on the TV or other device.
 - The digital coaxial connector might be labeled **DIGITAL AUDIO OUT**.

Option 3: Connect audio through analog audio cables

Basic quality audio

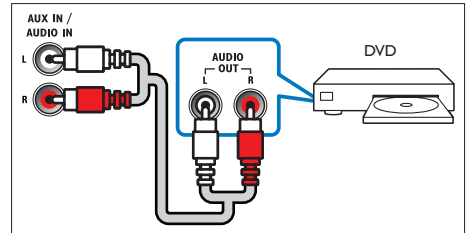

- 1 Using an analog cable, connect the **AUX** connectors on your SoundBar to the **AUDIO OUT** connectors on the TV or other device.

4 Use your SoundBar

This section helps you use the SoundBar to play audio from connected devices.

Before you start

- Make the necessary connections described in the Quick Start Guide or download the User Manual from www.philips.com/support.
- Switch the SoundBar to the correct source for other devices.

Adjust the volume

- 1 Press **+/- (Volume)** to increase or decrease a volume level.
 - To mute sound, press **MUTE**.
 - To restore the sound, press **MUTE** again or press **+/- (Volume)**.

Volume indicator

- The higher volume level you change to, the more LED indicators light up. If you do not press the volume button for three seconds, the volume indicators light off.
- All the LED indicators blink three times when a volume level is set to the maximum or minimum.
- When sound is muted, the current source indicator blinks.

Choose your sound

This section helps you choose the ideal sound for your video or music.

Surround sound mode

Experience an immersive audio experience with surround sound modes.

- 1 Press **SURR** to turn surround mode on or off.
 - **On:** Create a surround listening experience.
 - **Off:** Two-channel stereo sound. Ideal for listening to music.

Sound mode indicator

- If surround mode is turned on, all the LED indicators light up one by one, with all the LED indicators on for three seconds. Finally the current source indicator stays on.
- If surround mode is turned off, all the LED indicators light up, then light off one by one. Finally the current source indicator stays on.

Equalizer

Change the high frequency (treble) and low frequency (bass) settings of the SoundBar.

- 1 Press **TREBLE +/-** or **BASS +/-** to change the treble or bass.

Treble/bass indicator

- The more treble/bass you change to, the more LED indicators light up. If you do not press the treble/bass button for three seconds, the treble/bass indicators light off.
- All the LED indicators blink three times when treble or bass is set to the maximum or minimum value.

Synchronize video and sound

If the audio and video are not synchronized, delay the audio to match the video.

- 1 Press **AUDIO SYNC +/-** to synchronize the audio with the video.
 - **AUDIO SYNC +** increases the sound delay, and **AUDIO SYNC -** decreases the sound delay.

Sound delay indicator

- The more delay you change to, the more LED indicators light up. If you do not press the sound delay button for three seconds, the sound delay indicators light off.

Note

- This feature is only applicable to **COAXIAL (COAX)** and **OPTICAL (OPT)** sources.

Night mode

For quiet listening, night mode decreases the volume of loud sounds when audio is played. Night mode is only available for Dolby Digital soundtracks.

- 1 Press **NIGHT** to turn night mode on or off.

Night mode indicator

- If night mode is turned on, all the LED indicators light up one by one, with all the LED indicators on for three seconds. Finally the current source indicator stays on.
- If night mode is turned off, all the LED indicators light up, then light off one by one. Finally the current source indicator stays on.

MP3 player

Connect your MP3 player to play your audio files or music.

What you need

- An MP3 player.
- A 3.5mm stereo audio cable.

- 1 Using the 3.5mm stereo audio cable, connect the MP3 player to the **AUDIO IN** connector on your SoundBar.
- 2 Press **AUDIO IN** on the remote control.
- 3 Press the buttons on the MP3 player to select and play audio files or music.

USB storage devices

Enjoy audio on a USB storage device, such as an MP3 player and USB flash memory, etc.

What you need

- A USB storage device that is formatted for FAT or NTFS file systems, and complies with the Mass Storage Class.
- An MP3 file on a USB storage device.

- 1 Connect a USB storage device to the SoundBar.
- 2 Press **USB** on the remote control.
- 3 Use the remote control to control play.

Button	Action
▶ 	Start or pause or resume play.
◀/▶	Skip to the previous or next track.
USB	During play, press to toggle: repeat one track and repeat off.
	Repeat play indicator
	<ul style="list-style-type: none">• If repeat mode is turned on, all the LED indicators light up for one second, then the current source indicator stays on.• If repeat mode is turned off, all the LED indicators light up, then light off one by one. Finally the current source indicator stays on.

Note

- This product may not be compatible with certain types of USB storage device.
- If you use a USB extension cable, USB HUB, or USB multi-reader, the USB storage device may not be recognized.
- Digital camera PTP and MTP protocols are not supported.
- Do not remove the USB storage device while it is being read.
- DRM-protected music files (MP3) are not supported.
- Support a USB port: 5V $\overline{\text{V}}$, 1A.

Play audio through Bluetooth

Through Bluetooth, connect the SoundBar with your Bluetooth device (such as an iPad, iPhone, iPod touch, Android phone, or laptop), and then you can listen to the audio files stored on the device through your SoundBar speakers.

What you need

- A Bluetooth device which supports Bluetooth profile A2DP, and with Bluetooth version as 2.1 + EDR.
- The operational range between the SoundBar and a Bluetooth device is approximately 10 meters (30 feet).

- 1** Press **⏻** on the remote control to switch the SoundBar to Bluetooth mode.
↳ The **⏻** indicator blinks at a fast rate.
- 2** On the Bluetooth device, switch on Bluetooth, search for and select **Philips HTL1177B** to start connection (see the user manual of the Bluetooth device on how to enable Bluetooth).
 - When prompted for a password, enter "0000".↳ During connection, the **⏻** indicator blinks at a lower rate.
- 3** Wait until the **⏻** indicator lights up.
↳ If the connection fails, the **⏻** indicator blinks continually at a lower rate.
- 4** Select and play audio files or music on your Bluetooth device.
 - During play, if a call is coming, music play is paused.
 - If your Bluetooth device supports AVRCP profile, on the remote control you can press **⏪** / **⏩** to skip to a track, or press **⏸** to pause/resume play.
- 5** To exit Bluetooth, select other source.
 - When your switch back to Bluetooth mode, Bluetooth connection remains active.

Note

- The music streaming may be interrupted by obstacles between the device and SoundBar; such as wall, metallic casing that covers the device, or other devices nearby that operate in the same frequency.
- If you want to connect your SoundBar with another Bluetooth device, press and hold **⏻** on the remote control to disconnect the currently connected Bluetooth device.

Apply factory settings

You can reset your SoundBar to the default setting mode.

- 1** In mute mode, quickly press **AUX** two times.
↳ The factory settings is restored.

Update software

To continually improve the product, software upgrade may be offered. Visit www.philips.com/support to check if the latest software version is available.

5 Wall mount

Note

- Improper wall mounting may result in accident, injury or damage. If you have any query, contact Consumer Care in your country.
- Before wall mounting, make sure the wall can support the weight of your SoundBar.

Screw length/diameter

Depending on the type of wall mounting your SoundBar, make sure that you use screws of a suitable length and diameter:

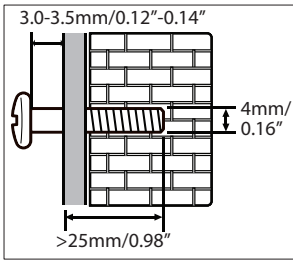

See the illustration in the quick start guide on how to wall mount the SoundBar:

- 1) Drill two holes on the wall.
- 2) Secure the dowels and screws in the holes.
- 3) Hang the SoundBar on the fastening screws.

6 Product specifications

Note

- Specifications and design are subject to change without notice.

Amplifier

- FTC total output power 30W
 - Left + Right :
30W (1%THD, 8ohm, 100Hz-20kHz)
- RMS total output power:
40W RMS (+/- 0.5 dB, 10% THD)
- Frequency response: 20 Hz-20 kHz / ± 3 dB
- Signal-to-noise ratio:
> 65 dB (CCIR) / (A-weighted)
- Input sensitivity:
 - AUX: 2Vrms
 - AUDIO IN: 1Vrms

Audio

- S/PDIF Digital audio input:
 - Coaxial: IEC 60958-3
 - Optical: TOSLINK
- Sampling frequency:
 - MP3: 8 kHz, 11 kHz, 12 kHz, 16 kHz, 22 kHz, 24 kHz, 32 kHz, 44.1 kHz, 48 kHz
- Constant bit rate:
 - MP3: 8 kbps-320 kbps

USB

- Compatibility: Hi-Speed USB (2.0)
- Class support: USB Mass Storage Class (MSC)
- File system: FAT16, FAT32, NTFS
- Supports MP3 file formats

Bluetooth

- Bluetooth profiles: A2DP,AVRCP
- Bluetooth version: 2.1 + EDR

Main unit

- Power supply: 120 V~, 60 Hz
- Power consumption: 25 W
- Standby power consumption: ≤ 0.5 W
- Speaker impedance: 4 ohm (full range)
- Speaker drivers: 4 x 54.5 mm (2")
- Dimensions (W x H x D):
865 x 67.8 x 85.5 mm (34.1" x 2.7" x 3.4")
- Weight: 1.8 kg / 3.96 lbs

Remote control batteries

- 1 x AAA-R03-1.5 V

7 Troubleshooting



Warning

- Risk of electric shock. Never remove the casing of the product.

To keep the warranty valid, never try to repair the product yourself.

If you have problems using this product, check the following points before you request service. If you still have a problem, get support at www.philips.com/support.

Main unit

The buttons on the SoundBar do not work.

- Disconnect the SoundBar from the power supply for a few minutes, then reconnect.

Sound

No sound from SoundBar speakers.

- Connect the audio cable from your SoundBar to your TV or other devices.
- Reset your SoundBar to its factory settings.
- On the remote control, select the correct audio input.
- Make sure that the SoundBar is not muted.

Distorted sound or echo.

- If you play audio from the TV through the SoundBar, make sure that the TV is muted.

Bluetooth

A device cannot connect with the SoundBar.

- The device does not support the compatible profiles required for the SoundBar.
- You have not enabled the Bluetooth function of the device. See the user manual of the device on how to enable the function.

- The device is not correctly connected. Connect the device correctly. (see 'Play audio through Bluetooth' on page 10)
- The SoundBar is already connected with another Bluetooth device. Disconnect the connected device, then try again.

Quality of audio play from a connected Bluetooth device is poor.

- The Bluetooth reception is poor. Move the device closer to the SoundBar, or remove any obstacle between the device and the SoundBar.

The connected Bluetooth device connects and disconnects constantly.

- The Bluetooth reception is poor. Move the device closer to the SoundBar, or remove any obstacle between the device and the SoundBar.
- Turn off Wi-Fi function on the Bluetooth device to avoid interference.
- For some Bluetooth, the Bluetooth connection can be deactivated automatically to save power. This does not indicate any malfunction of the SoundBar.

8 Notice

This section contains the legal and trademark notices.

Notice of compliance

The device complies with the FCC rules, Part 15. Operation is subject to the following two conditions:

- ① **This device may not cause harmful interference, and**
- ② **This device must accept any interference received, including interference that may cause undesired operation.**

FCC rules

This equipment has been tested and found to comply with the limits for a Class B digital device, pursuant to part 15 of the FCC Rules. These limits are designed to provide reasonable protection against harmful interference in a residential installation. This equipment generates, uses and can radiate radio frequency energy and, if not installed and used in accordance with the instruction manual, may cause harmful interference to radio communications. However, there is no guarantee that interference will not occur in a particular installation. If this equipment does cause harmful interference to radio or television reception, which can be determined by turning the equipment off and on, the user is encouraged to try to correct the interference by one or more of the following measures:

- Relocate the receiving antenna.
- Increase the separation between equipment and receiver.
- Connect the equipment into an outlet on a circuit different from that to which the receiver is connected.
- Consult the dealer or an experienced radio/TV technician for help.

FCC Radiation Exposure Statement:This equipment complies with FCC radiation exposure limits set forth for an uncontrolled environment.This equipment should be installed and operated with a minimum distance of 20cm between the radiator and your body. This transmitter must not be co-located or operated in conjunction with any other antenna or transmitter.

Warning: Any changes or modifications made to this device that are not expressly approved by Gibson Innovations may void the user's authority to operate the equipment.

Model number: HTL1177B/F7

Trade Name: Philips

Responsible Party:P&F USA, Inc. PO

Box 2248 Alpharetta, GA 30023-2248;

1 (866) 226-6074

Canada:

CAN ICES-3(B)/NMB-3(B)

This device complies with Industry Canada licence-exempt RSS standard(s). Operation is subject to the following Two conditions: (1) this device may not cause harmful interference, and (2) this device must accept any interference received, including interference that may cause undesired operation.

The device meets the exemption from the routine evaluation limits in section 2.5 of RSS 102 and compliance with RSS-102 RF exposure, users can obtain Canadian information on RF exposure and compliance.

This transmitter must not be co-located or operating in conjunction with any other antenna or transmitter.This equipment should be installed and operated with a minimum distance of 20 centimeters between the radiator and your body.



Manufactured under license from Dolby Laboratories. Dolby and the double-D symbol are trademarks of Dolby Laboratories.



The Bluetooth ® word mark and logos are registered trademarks owned by Bluetooth SIG, Inc. and any use of such marks by Gibson Innovations Ltd is under license. Other trademarks and trade names are those of their respective owners.

ONE (1) YEAR LIMITED WARRANTY

WARRANTY COVERAGE:

This warranty obligation is limited to the terms set forth below.

WHO IS COVERED:

This product is warranted to the original purchaser or the person receiving the product as a gift against defects in materials and workmanship as based on the date of original purchase ("Warranty Period") from an Authorized Dealer. The original sales receipt showing the product name and the purchase date from an authorized retailer is considered such proof.

WHAT IS COVERED:

This warranty covers new products if a defect in material or workmanship occurs and a valid claim is received within the Warranty Period. At its option, the company will either (1) repair the product at no charge, using new or refurbished replacement parts, or (2) exchange the product with a product that is new or which has been manufactured from new, or serviceable used parts and is at least functionally equivalent or most comparable to the original product in current inventory, or (3) refund the original purchase price of the product.

The company warrants replacement products or parts provided under this warranty against defects in materials and workmanship from the date of the replacement or repair for ninety (90) days or for the remaining portion of the original product's warranty, whichever provides longer coverage for you. When a product or part is exchanged, any replacement item becomes your property and the replaced item becomes the company property. When a refund is given, your product becomes the company property.

Note: Any product sold and identified as refurbished or renewed carries a ninety (90) day limited warranty.

Replacement product can only be sent if all warranty requirements are met. Failure to follow all requirements can result in delay.

WHAT IS NOT COVERED - EXCLUSIONS AND LIMITATIONS:

This Limited Warranty applies only to the new products that can be identified by the trademark, trade name, or logo affixed to it. This Limited Warranty does not apply to any non-Philips hardware product or any software, even if packaged or sold with the product. Non-Philips manufacturers, suppliers, or publishers may provide a separate warranty for their own products packaged with the bundled product.

The company is not liable for any damage to or loss of any programs data, or other information stored on any media contained within the product, or any non-Philips product or part not covered by this warranty. Recovery or reinstallation of programs, data or other information is not covered under this Limited Warranty.

This warranty does not apply (a) to damage caused by accident, abuse, misuse, neglect, misapplication, or non-Philips product, (b) to damage caused by service performed by anyone other than an Authorized Service Location, (c) to a product or a part that has been modified without written permission,

or (d) if any serial number has been removed or defaced, or (e) product, accessories or consumables sold "AS IS" without warranty of any kind by including refurbished Philips product sold "AS IS" by some retailers.

This Limited Warranty does not cover:

- Shipping charges to return defective product.
- Labor charges for installation or setup of the product, adjustment of customer controls on the product, and installation or repair of antenna/signal source systems outside of the product.
- Product repair and/or part replacement because of improper installation or maintenance, connections to improper voltage supply, power line surge, lightning damage, retained images or screen markings resulting from viewing fixed stationary content for extended periods, product cosmetic appearance items due to normal wear and tear, unauthorized repair or other cause not within the control of the company.
- Damage or claims for products not being available for use, or for lost data or lost software.
- Damage from mishandled shipments or transit accidents when returning product.
- A product that requires modification or adaptation to enable it to operate in any country other than the country for which it was designed, manufactured, approved and/or authorized, or repair of products damaged by these modifications.
- A product used for commercial or institutional purposes (including but not limited to rental purposes).
- Product lost in shipment and no signature verification receipt can be provided.
- Failure to operate per Owner's Manual.

TO OBTAIN ASSISTANCE IN THE U.S.A., CANADA, PUERTO RICO, OR U.S. VIRGIN ISLANDS...

Contact Customer Care Center at:

1 (866) 226-6074

REPAIR OR REPLACEMENT AS PROVIDED UNDER THIS WARRANTY IS THE EXCLUSIVE REMEDY FOR THE CONSUMER. PHILIPS SHALL NOT BE LIABLE FOR ANY INCIDENTAL OR CONSEQUENTIAL DAMAGES FOR BREACH OF ANY EXPRESS OR IMPLIED WARRANTY ON THIS PRODUCT. EXCEPT TO THE EXTENT PROHIBITED BY APPLICABLE LAW, ANY IMPLIED WARRANTY OF MERCHANTABILITY OR FITNESS FOR A PARTICULAR PURPOSE ON THIS PRODUCT IS LIMITED IN DURATION TO THE DURATION OF THIS WARRANTY.

Some states do not allow the exclusions or limitation of incidental or consequential damages, or allow limitations on how long an implied warranty lasts, so the above limitations or exclusions may not apply to you.

This warranty gives you specific legal rights. You may have other rights which vary from state/province to state/province.

P&F USA Inc. PO Box 2248 Alpharetta, GA 30023-2248

P&F USA, Inc.
PO Box 2248 Alpharetta, GA 30023-2248



Reproductor de Barra de Sonido

HTLI 1177B/F7

120V ~ 60Hz

25W

Consumo de Energía Eléctrica:

18,75 Wh

Consumo de Energía Eléctrica de el aparato en Modo de Espera:

0,48 Wh

Comercializado por : P&F MEXICANA. S.A. DE C.V.

IMPORTADOR: P&F MEXICANA. S.A. DE C.V.

Av. La Palma # 6
Col. San Fernando La Herradura
Huixquilucan, Edo. México.
MEXICO C.P.52787.
Tel: 52 (55) 5269 - 9000

EXPORTADOR: P&F USA Inc.

HECHO EN: CHINA



GARANTIA INCLUIDA EN EL INSTRUCTIVO DE USO

LEA CUIDADOSAMENTE ESTE INSTRUCTIVO
ANTES DE USAR SU APARATO.

Specifications are subject to change without notice
2015 © Gibson Innovations Limited. All rights reserved.

This product has been manufactured by, and is sold under the responsibility of Gibson Innovations Ltd., and Gibson Innovations Ltd. is the warrantor in relation to this product. Philips and the Philips Shield Emblem are registered trademarks of Koninklijke Philips N.V. and are used under license from Koninklijke Philips N.V.

HTL1177B_F7_UM_V3.0

