



Samsung **SUHD TV**^{4K}

user manual

Thank you for purchasing this Samsung product.

To receive more complete service,
please register your product at
www.samsung.com/register

Model _____ Serial No. _____

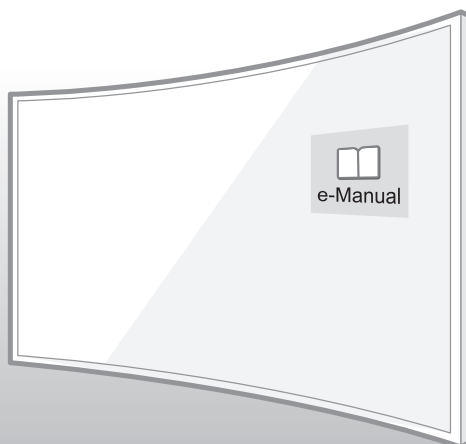

Warning! Important Safety Instructions

(Please read the Safety Instructions before using your TV.)

CAUTION

RISK OF ELECTRIC SHOCK DO NOT OPEN

CAUTION: TO REDUCE THE RISK OF ELECTRIC SHOCK, DO NOT REMOVE COVER (OR BACK). THERE ARE NO USER SERVICEABLE PARTS INSIDE. REFER ALL SERVICING TO QUALIFIED PERSONNEL.



This symbol indicates that high voltage is present inside. It is dangerous to make any kind of contact with any internal part of this product.



This symbol indicates that this product has included important literature concerning operation and maintenance.

The slots and openings in the cabinet and in the back or bottom are provided for necessary ventilation. To ensure reliable operation of this apparatus and to protect it from overheating, these slots and openings must never be blocked or covered.

- Do not place this apparatus in a confined space, such as a bookcase or built-in cabinet, unless proper ventilation is provided.
- Do not place this apparatus near or over a radiator or heat register, or where it is exposed to direct sunlight.
- Do not place vessels (vases etc.) containing water on this apparatus, as this can result in a fire or electric shock.

Do not expose this apparatus to rain or place it near water (near a bathtub, washbowl, kitchen sink, or laundry tub, in a wet basement, or near a swimming pool etc.). If this apparatus accidentally gets wet, unplug it and contact an authorised dealer immediately.

This apparatus uses batteries. In your community, there might be environmental regulations that require you to dispose of these batteries properly. Please contact your local authorities for disposal or recycling information.

Do not overload wall outlets, extension cords or adaptors beyond their capacity, since this can result in fire or electric shock.

Power-supply cords should be placed so that they are not likely to be walked on or pinched by items placed upon or against them. Pay particular attention to cords at the plug end, at wall outlets, and the point where they exit from the appliance.

To protect this apparatus from a lightning storm, or when it is left unattended and unused for long periods of time, unplug it from the wall outlet and disconnect the antenna or cable system. This will prevent damage to the set due to lightning and power line surges.

Before connecting the AC power cord to the DC adaptor outlet, make sure that the voltage designation of the DC adaptor corresponds to the local electrical supply.

Never insert anything metallic into the open parts of this apparatus. This may cause a danger of electric shock.

To avoid electric shock, never touch the inside of this apparatus. Only a qualified technician should open this apparatus.

Be sure to plug in the power cord until it is firmly seated. When unplugging the power cord from a wall outlet, always pull on the power cord's plug. Never unplug it by pulling on the power cord. Do not touch the power cord with wet hands.

If this apparatus does not operate normally - in particular, if there are any unusual sounds or smells coming from it - unplug it immediately and contact an authorised dealer or service centre.

Be sure to pull the power plug out of the outlet if the TV is to remain unused or if you are to leave the house for an extended period of time (especially when children, elderly or disabled people will be left alone in the house).

- Accumulated dust can cause an electric shock, an electric leakage, or a fire by causing the power cord to generate sparks and heat or by causing the insulation to deteriorate.

Be sure to contact an authorised service centre for information if you intend to install your TV in a location with heavy dust, high or low temperatures, high humidity, chemical substances, or where it will operate 24 hours a day such as in an airport, a train station, etc. Failure to do so may lead to serious damage to your TV.

Use only a properly grounded plug and wall outlet.

- An improper ground may cause electric shock or equipment damage. (Class I Equipment only.)

To turn off this apparatus completely, disconnect it from the wall outlet. Be sure to have the wall outlet and power plug readily accessible.

Do not allow children to hang onto the product.

Store the accessories (battery, etc.) in a location safely out of the reach of children.

Do not install the product in an unstable location such as a shaky shelf or a slanted floor or in a location exposed to vibration.

Do not drop or strike the product. If the product is damaged, disconnect the power cord and contact a service centre.

To clean this apparatus, unplug the power cord from the wall outlet and wipe the product with a soft, dry cloth. Do not use any chemicals such as wax, benzene, alcohol, thinners, insecticide, aerial fresheners, lubricants, or detergents. These chemicals can damage the appearance of the TV or erase the printing on the product.

Do not expose this apparatus to dripping or splashing.

Do not dispose of batteries in a fire.

Do not short-circuit, disassemble, or overheat the batteries.

There is danger of an explosion if you replace the batteries used in the remote with the wrong type of battery. Replace only with the same or equivalent type.

WARNING - TO PREVENT THE SPREAD OF FIRE, KEEP CANDLES OR OTHER ITEMS WITH OPEN FLAMES AWAY FROM THIS PRODUCT AT ALL TIMES.



Features of your new TV

SMART HUB

Your TV features Smart Hub, a multi-purpose entertainment and family centre. With Smart Hub, you can surf the web, download applications. In addition, you can view or play photo, video, and music files stored on external storage devices.

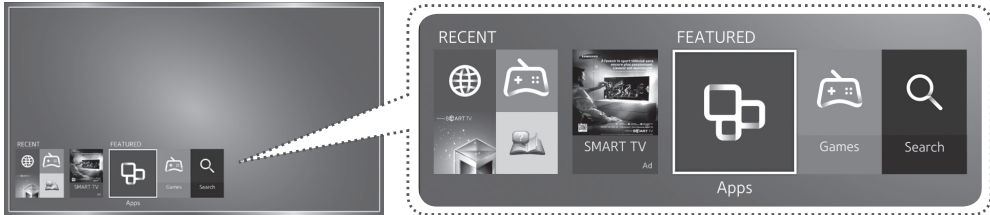

- See the e-Manual chapter, "Smart Features > Smart Hub."
- To use this feature, the TV must be connected to the Internet, refer to page 12.
 - Games:** You can play and manage games downloaded or purchased with your Samsung account.
 - APPS:** Install and enjoy free news, sports, weather, and gaming apps on the TV.
 - MY CONTENT:** Play content saved on external storage devices supported by the TV.

e-Manual

Get help from a detailed, on-screen user's manual built into your TV.

Voice Control

Access and control menu options and functions using voice commands.

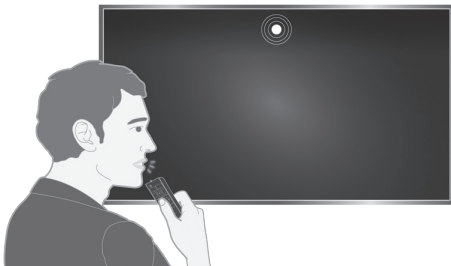

- Refer to the e-Manual chapter, **Smart Features > Controlling the TV with Your Voice.**

Samsung Smart Control

You can control easy to use with the Samsung Smart Control's POINTER, without the buttons on standard remote control.

Contents

01 What's in the Box?

02 Assembling the TV

- 7 Attaching the TV to the Stand
- 7 Mounting the TV on a Wall (Optional)
- 9 Providing proper ventilation for your TV
- 9 Arranging the cables with the Cable guide
- 10 Safety Precaution: Securing the TV to the wall

03 Connections

- 11 Connecting devices to your TV
- 12 Connecting to the Internet
- 14 TV Camera Connection (sold separately)
- 14 Connecting to a COMMON INTERFACE slot (Your TV viewing Card Slot)

04 The TV Controller

- 16 Using the Control Stick
- 17 The Standard Remote Control
- 18 The Samsung Smart Control
- 20 About the Samsung Smart Control
- 21 Using the POINTER to operate the TV
- 22 Using the On-Screen Remote
- 23 Controlling External Devices with the TV Remote - Using the Universal Remote

05 Performing the initial setup

- 24 Initial setup
- 24 Setting up a password

06 Selecting Connected Devices

07 The e-Manual

08 Troubleshooting and Maintenance

- 29 Eco sensor and screen brightness
- 30 Support through Remote Management
- 31 Caring for the TV

09 Specifications and other information

- 32 TV Specifications
- 33 Licences
- 35 Warranty Card

* The figures and illustrations in this User Manual are provided for reference only and may differ from the actual product appearance. The product design and specifications may change without notice. CIS languages (Russian, Ukrainian, Kazakhs) are not available for this product, since this is manufactured for customers in the EU region.

01 What's in the Box?

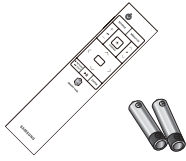

Samsung Smart Control & Batteries (AA x 2)



Remote Control & Batteries (AAA x 2)



Power Cord

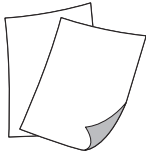

Regulatory Guide / Warranty Card

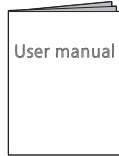

User Manual



One connect Mini



One connect Mini cable



Wall mount Adapter

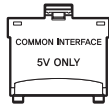

CI Card Adapter



AV Adapter



Component Adapter

- To use the 3D function, you must purchase the 3D glasses.
- Please make sure the following items are included with your TV. If any items are missing, contact your dealer.
- The items' colours and shapes may vary depending on the models.
- Cables not included can be purchased separately.
- Check for any accessories hidden behind or in the packing materials when opening the box.

An administration fee may be charged if either

(a) an engineer is called out at your request and there is no defect with the product (i.e. where the user manual has not been read).

(b) you bring the unit to a repair centre and there is no defect with the product (i.e. where the user manual has not been read).

You will be informed of the administration fee amount before a technician visits.



Warning: Screens can be damaged from direct pressure when handled incorrectly. We recommend lifting the TV at the edges, as shown.

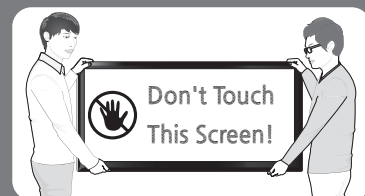

02 Assembling the TV

Attaching the TV to the Stand

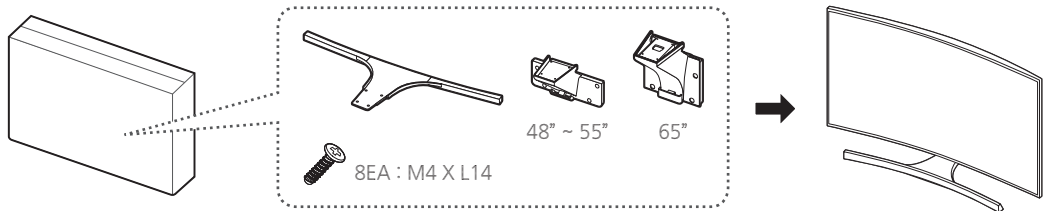

Make sure you have all the accessories shown, and that you assemble the stand following the provided assembly instructions.

Mounting the TV on a Wall (Optional)



If you mount this product on a wall, follow the instructions exactly as recommended by the manufacturer. Unless it is correctly mounted, the product may slide or fall, thus causing serious injury to a child or adult and serious damage to the product.

Installing the wall mount kit

You can mount the TV on the wall using a wall mount kit (sold separately). For models providing wall mount adapters, install them as shown in the figures below before installing the wall mount kit.

- Refer to the installation manual included with the Samsung wall mount kit.

Before you install the screws for the wall mount, put the Styrofoam that came with the TV's packaging on the TV to protect it. Then, lay the TV down and attach the screws. To mount both a soundbar and the TV onto a wall using the wall mount, mount the soundbar onto the TV first, and then mount the TV/Soundbar combination onto the wall mount. For detailed information, see the instructions provided with the soundbar.

- The soundbar installation with the wall mount may not be supported for the specific region or model.

For detailed information about installing the wall mount, see the instructions provided with the wall mount kit. We recommend that you contact a technician for assistance when installing the wall mount bracket. We do not advise you to do it yourself. Samsung Electronics is not responsible for any damage to the product or injury to yourself or others if you choose to install the wall mount on your own.

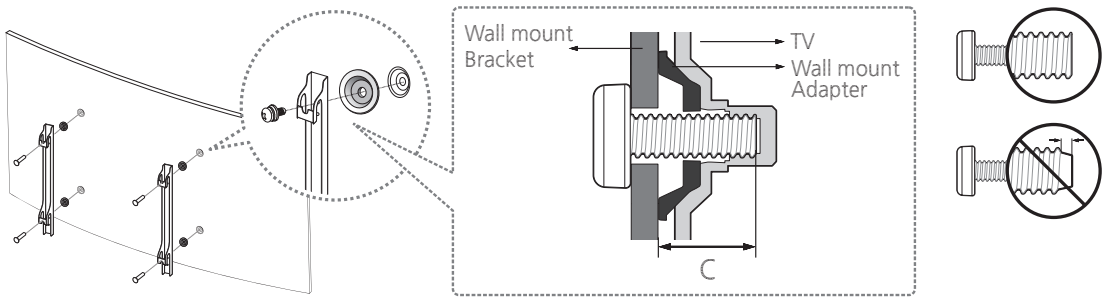

VESA wall mount kit notes and specifications

You can install your wall mount on a solid wall perpendicular to the floor. Before attaching the wall mount to surfaces other than plaster board, contact your nearest dealer for additional information. If you install the TV on a ceiling or slanted wall, it may fall and result in severe personal injury.

- Standard dimensions for wall mount kits are shown in the table below.
- When purchasing our wall mount kit, a detailed installation manual and all parts necessary for assembly are provided.
- Do not use screws that do not comply with the VESA standard screw specifications.
- Do not use screws that are longer than the standard length or do not comply with VESA standard screw specifications. Screws that are too long may cause damage to the inside of the TV set.
- For wall mounts that do not comply with the VESA standard screw specifications, the length of the screws may differ depending on the wall mount specifications.
- Do not fasten the screws too firmly. This may damage the product or cause the product to fall, leading to personal injury. Samsung is not liable for these kinds of accidents.
- Samsung is not liable for product damage or personal injury when a non-VESA or non-specified wall mount is used or the consumer fails to follow the product installation instructions.
- Do not mount the TV at more than a 15 degree tilt.

When using a third-party wall mount, note that the assembling screw length(C) is shown below.

Product Family	Inches	VESA Spec. (A * B)	C (mm)	Standard Screw	Quantity
UHD-TV [Curved]	48~65	400 X 400	32~40	M8	4

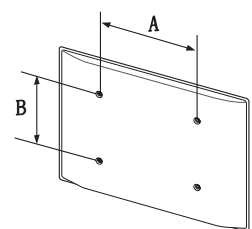

Do not install your wall mount kit while your TV is turned on. This may result in personal injury from electric shock.

Providing proper ventilation for your TV

When you install your TV, maintain a distance of at least 10 cm between the TV and other objects (walls, cabinet sides, etc.) to ensure proper ventilation. Failing to maintain proper ventilation may result in a fire or a problem with the product caused by an increase in its internal temperature.

When you install your TV with a stand or a wall mount, we strongly recommend you use parts provided by Samsung Electronics only. Using parts provided by another manufacturer may cause difficulties with the product or result in injury caused by the product falling.

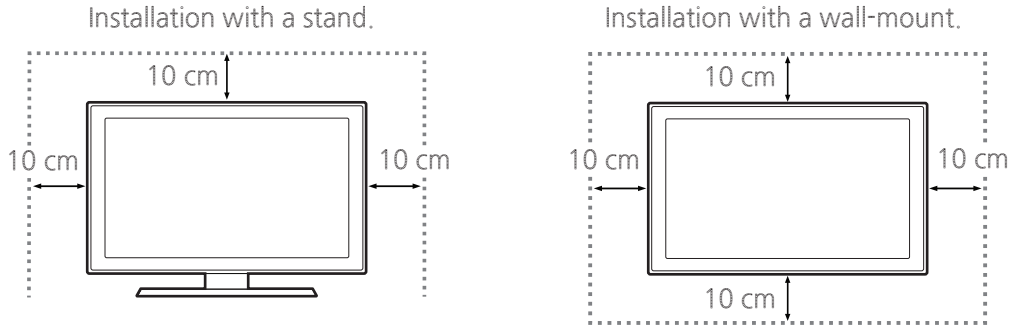

Other Cautions

- The actual appearance of the TV may differ from the images in this manual, depending on the model.
- Be careful when you touch the TV. Some parts can be somewhat hot.

Arranging the cables with the Cable guide

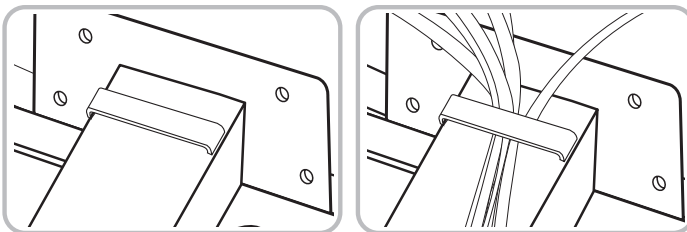

Safety Precaution: Securing the TV to the wall



Caution: Pulling, pushing, or climbing on the TV may cause the TV to fall. In particular, ensure your children do not hang on or destabilize the TV. This action may cause the TV to tip over, causing serious injuries or death. Follow all safety precautions provided in the Safety Flyer included with your TV. For added stability and safety, you can purchase and install the anti-fall device as described below.

Preventing the TV from falling

1. Put the screws into the clamps and firmly fasten them into the wall. Confirm that the screws have been firmly installed into the wall.
 - You may need additional material such as anchors depending on the type of wall.
 - Since the necessary clamps, screws, and string are not supplied, please purchase these additionally.
2. Remove the screws from the centre back of the TV, put the screws into the clamps, and then fasten the screws into the TV again.
 - These screws may not be supplied with the TV. For a 48~65 inch model, purchase M8 screws.
3. Connect the clamps fixed into the TV and the clamps fixed onto the wall with a strong cable and then tie the string tightly.
 - Install the TV close to the wall so that it does not fall backwards.
 - Connect the string so that the clamps fixed on the wall are at the same height as or lower than the clamps fixed on the TV.
 - Untie the string before moving the TV.
4. Make sure that all connections are properly secured. Periodically check connections for any sign of damage. If you have any doubt about the security of your connections, contact a professional installer.

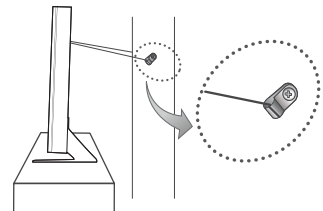
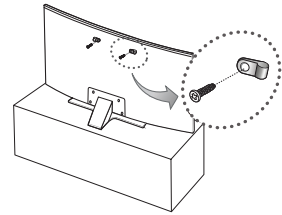

- The displayed image may differ depending on the model.

03 Connections



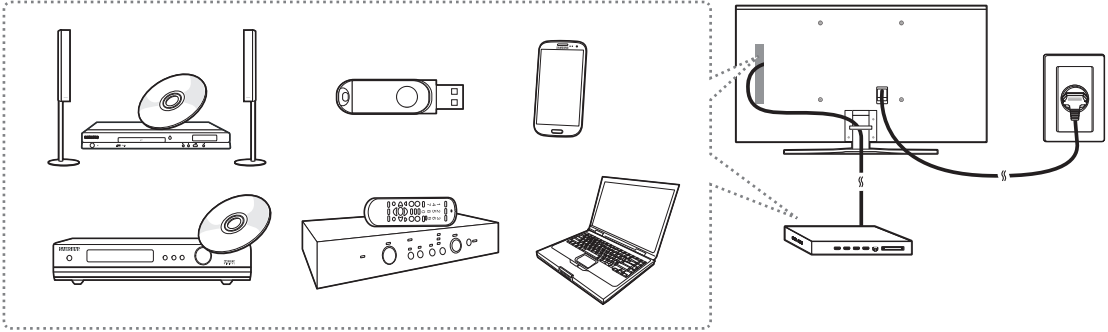



Connecting devices to your TV

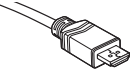

You can connect various external devices using the connectors located at the back of the product. Check the connectors and then refer to the Quick Guide for more instructions on supported external devices.

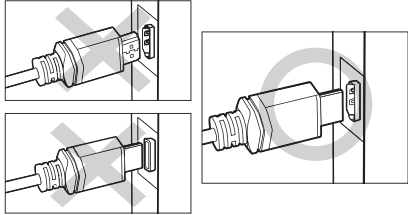
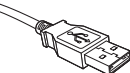
For more information about connections, see the **e-Manual** chapter "**Connections.**"

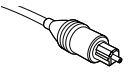
Make sure you have the correct cable before plugging it in. Illustrations of common plugs and ports are shown below.

	Cable Plugs	Ports	
HDMI			
USB			
Optical			



Warning

Do not plug cables in upside down. Be sure to check the orientation of the plug before plugging it in.

Connecting to the Internet

Connecting the TV to a network gives you access to online services such as the Smart Hub, as well as software updates.

- For more information about Smart Hub, see the e-Manual chapter, "Smart Features > Smart Hub."
- The shape of the rear panel differs among the models.

Network Connection - Wireless

Connect the TV to the Internet using a standard router or modem.

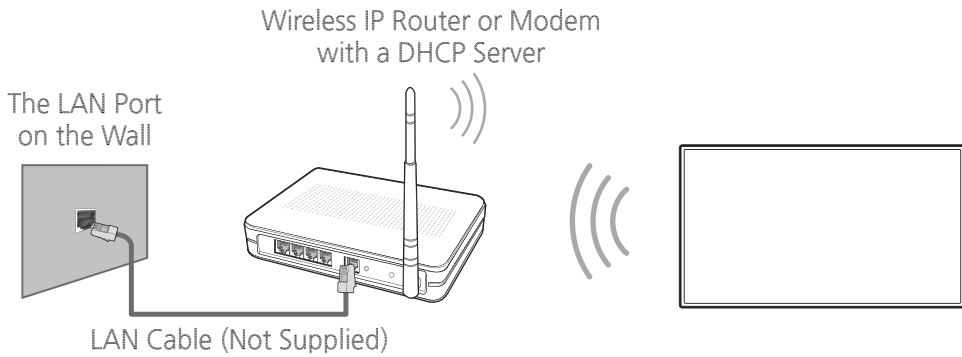

Network Connection - Wired

There are three main ways to connect your TV to your network using cable, depending on your network setup. They are illustrated starting below:

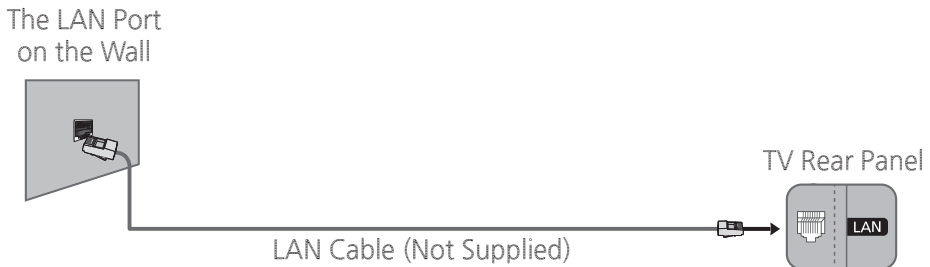
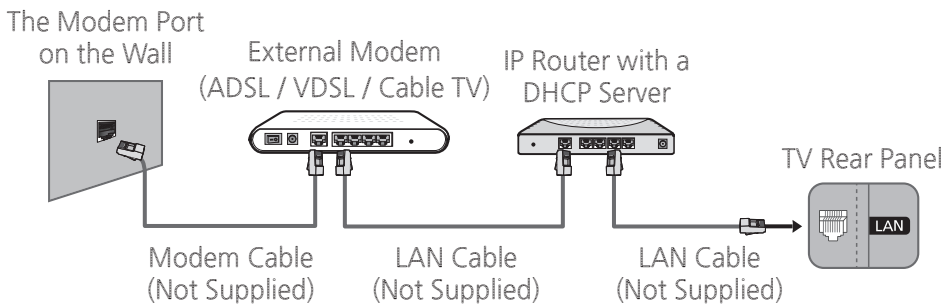
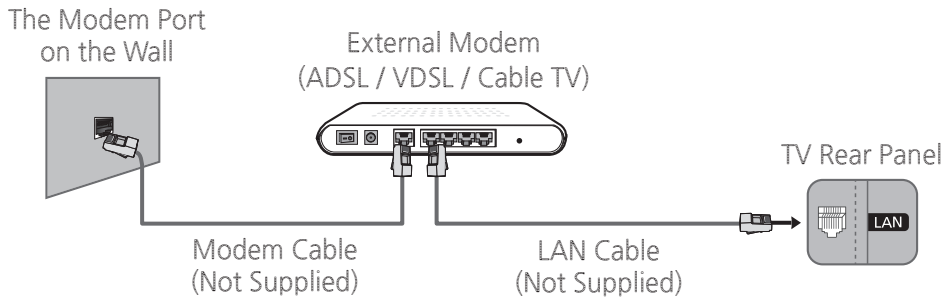

- The TV does not support network speeds less than or equal to 10Mbps.
- Use Cat 7 cable for the connection.

TV Camera Connection (sold separately)

You can use Motion Control and Face Recognition function, if you connect the TV Camera.

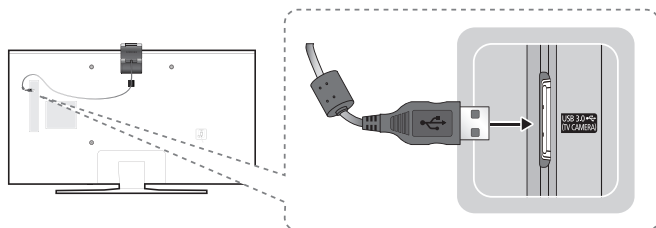

- Make sure to connect only the TV camera to the TV CAMERA port.
- Remove the cover of the TV CAMERA port, and then connect the TV camera's USB cable to the port. You cannot cover the port with the port cover while the cable is connected to the port.

Connecting to a COMMON INTERFACE slot (Your TV viewing Card Slot)

- Turn the TV off to connect or disconnect a CI card or CI card adapter.

Attaching the CI Card Adapter

- A CI Card Adapter that lets the TV use two different CI Cards is available, depending on the model.

Attach the adapter as shown.

- To install the CI CARD Adapter, please remove the sticker attached to the TV.

To connect the CI CARD Adapter, follow these steps.

- We recommend attaching the adapter before installing the wall mount, or inserting the "CI or CI+ CARD".

1. Insert the CI CARD Adapter into the two holes on the product 1.
 - Please locate the two holes at the back of the TV next to the **COMMON INTERFACE** port.
2. Connect the CI CARD Adapter to the **COMMON INTERFACE** port on the product 2.
3. Insert the "CI or CI+ CARD".

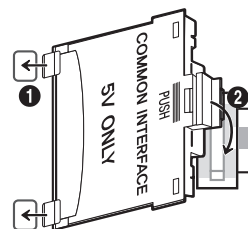

We recommend that you attach the CI Card adapter and insert the CI card (viewing card) before you mount the TV on the wall because it may be difficult and dangerous to do this when it is on the wall.

Using the “CI or CI+ CARD”

To watch paid channels, the “CI or CI+ CARD” must be inserted.

- If you don't insert the “CI or CI+ CARD”, some channels will display the “Scrambled Signal” message.
- Samsung TV follow up CI+ 1.3 standard. When TV product display the "Scrambled Signal", it may happen due to CI+1.3 Version inconsistency. If you have a problem, please contact Samsung Call Centre.
- The pairing information containing a telephone number, the “CI or CI+ CARD” ID, the Host ID, and other information will be displayed in about 2~3 minutes. If an error message is displayed, please contact your service provider.
- When the configuration of channel information has finished, the message “Updating Completed” is displayed, indicating the channel list is updated.

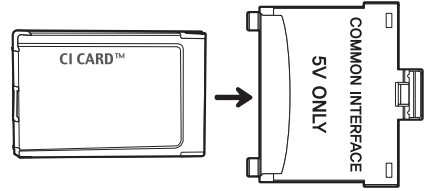

NOTE

- You must obtain a “CI or CI+ CARD” from a local cable service provider.
- When removing the “CI or CI+ CARD”, carefully pull it out as dropping the “CI or CI+ CARD” may damage it.
- Insert the “CI or CI+ CARD” in the direction marked on the card.
- The location of the COMMON INTERFACE slot may differ depending on the model.
- A “CI or CI+ CARD” is not supported in some countries and regions, therefore, check with your authorised dealer.
- If you have any problems, please contact a service provider.
- Insert the “CI or CI+ CARD” that supports the current aerial settings. The screen will be distorted or will not be visible.

04 The TV Controller

Using the Control Stick

- The product colour and shape may vary depending on the model.
- The TV's **Control Stick**, a small joystick-like button at the right back of the TV, lets you control the TV without the remote control.

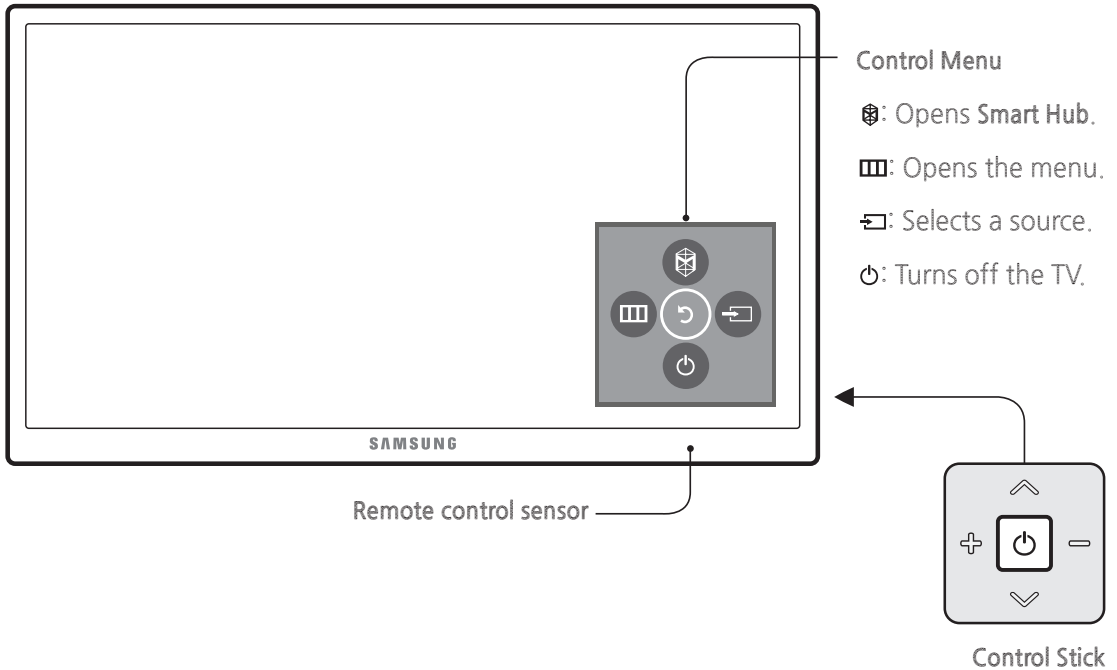

The **Control Stick** is located on the lower left corner of the back of the TV.

The Standard Remote Control

Learn where the function buttons are on your remote, such as: SOURCE, MUTE, - ▲ +, ^ P ▼, MENU, TOOLS, ↵, INFO, CH LIST, RETURN, GUIDE and EXIT.

- This remote control has Braille points on the **Power**, **Channel**, and **Volume** buttons and can be used by visually impaired persons.
- Your TV also comes with a Samsung Smart Control. For information about the Samsung Smart Control, refer to page 18.
- The button names above may be differ from the actual names.

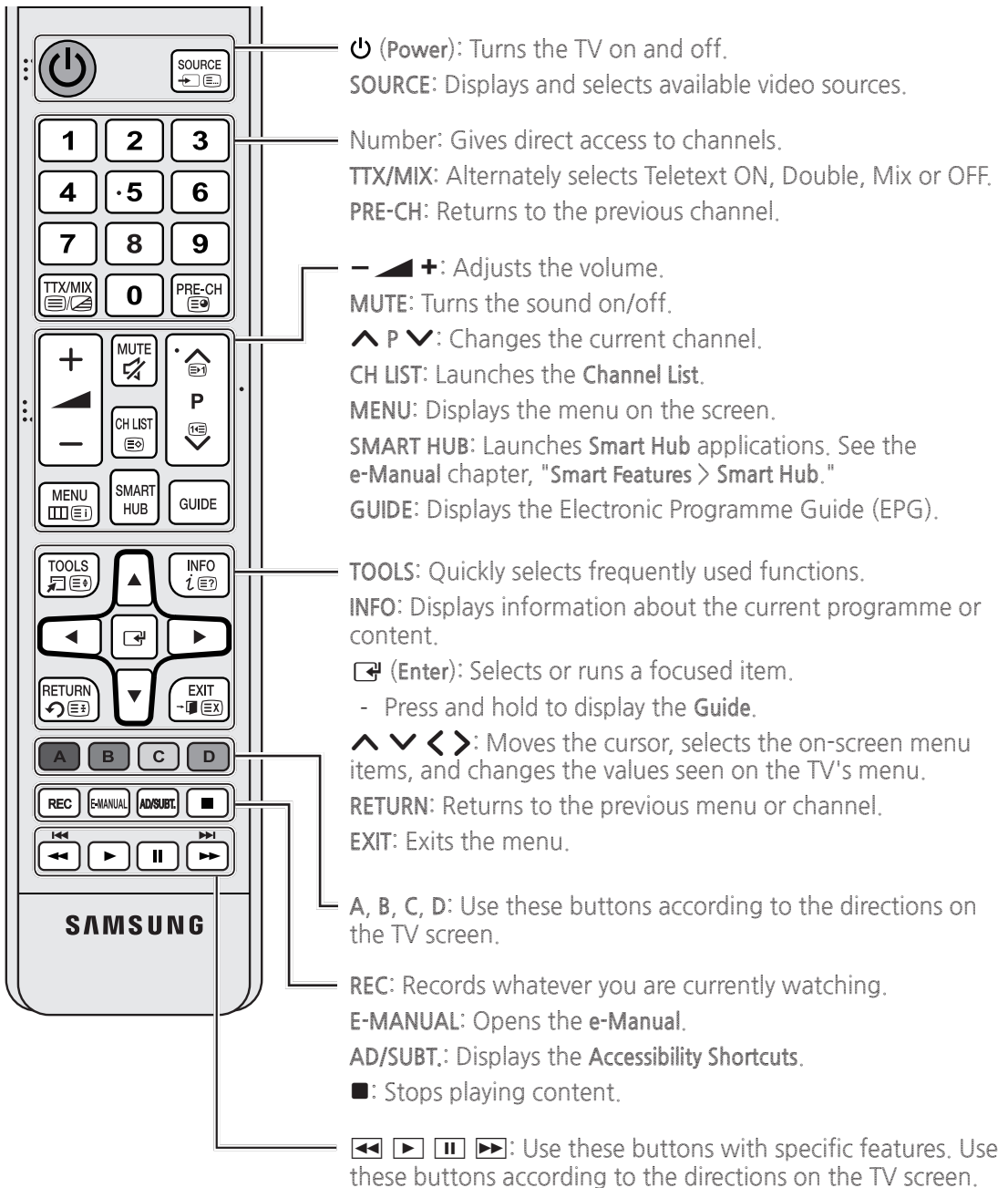

The Samsung Smart Control

Without the buttons on the standard remote control, you can control your TV easily with the **POINTER** button on the Samsung Smart Control. Also, you can control the Voice Recognition and Voice functions through the microphone on the Samsung Smart Control.

- Colours and shape may vary depending on the model.
- For more information about "Using the Samsung Smart Control", refer to page 20.
- For more information about Samsung Smart Control, see the e-Manual chapter, "Remote Control and Peripherals > Using the Samsung Smart Control."



: Press this button to mute the sound temporarily.

- **AD**: Press and hold this button to bring up **Accessibility Shortcuts** that enables or disables Accessibility menus.



MIC: Use the microphone with the Voice Recognition and Voice functions.

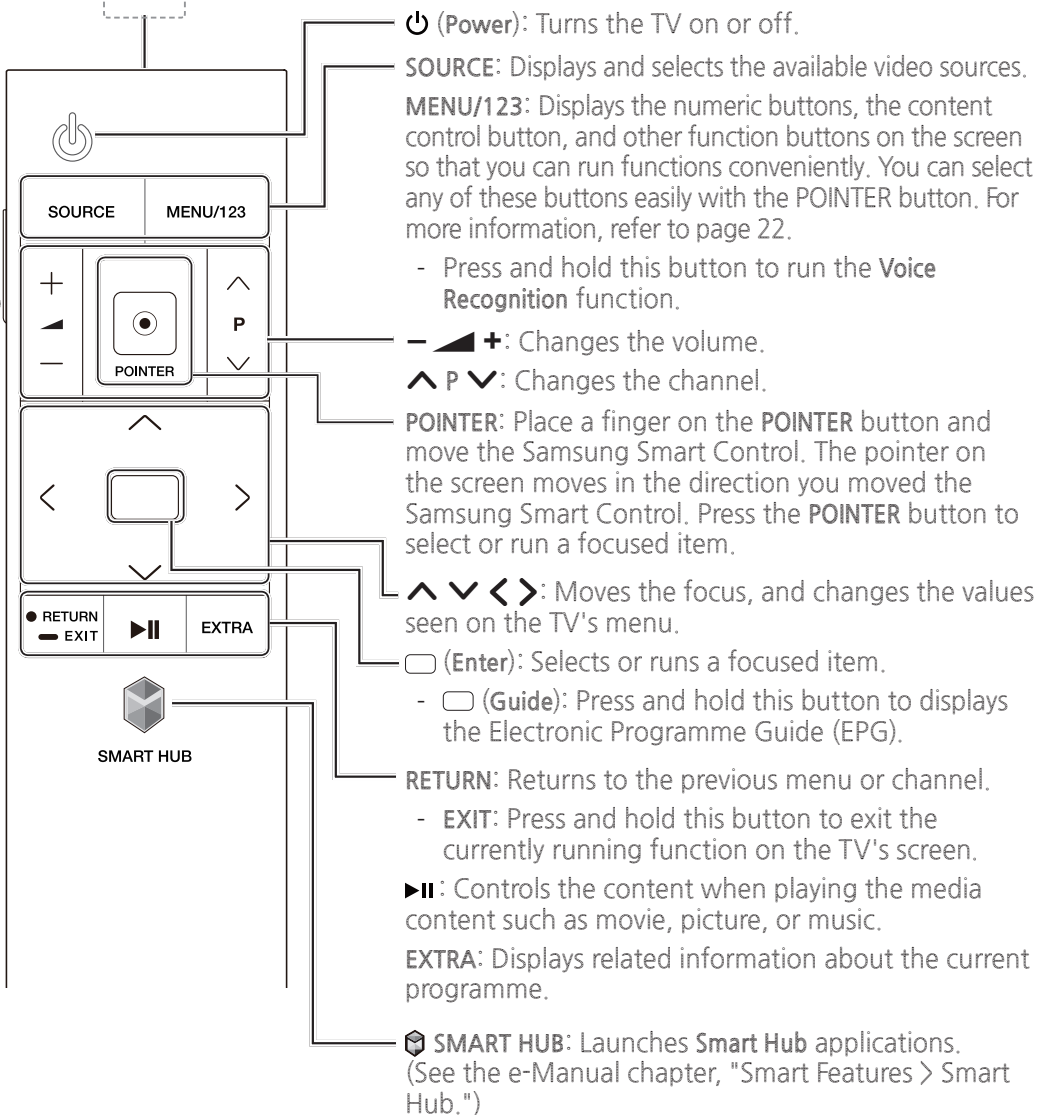

Installing batteries into the remote control (Battery size: AAA)

Match the polarities of the batteries to the symbols on the battery compartment.

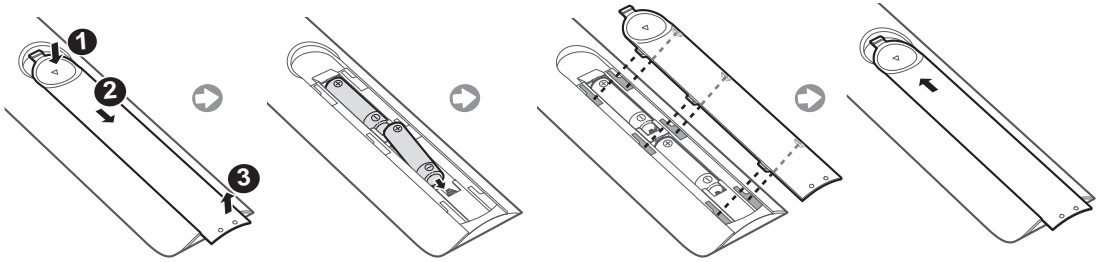

- The colour and shape of the remote may vary depending on the model.
 - Use the remote control within 7 m of the TV.
 - Bright lights may affect the performance of the remote control. Avoid using the remote control near special fluorescent lights or neon signs.
1. Gently pull on the battery cover's notch and then remove the cover completely once it comes loose.
 2. Insert 2 AAA alkaline batteries, making sure to align the positive and negative polarities correctly.
 3. Place the battery cover on the remote control and insert the cover into the remote control.
 4. Slide the battery cover in the order shown so that the cover is completely attached to the remote control.

Installing batteries into the Samsung Smart Control

To install the batteries, push the rear cover open in the direction of the arrow and insert the batteries as shown in the figure. Make sure that the positive and negative ends are facing in the correct direction.

- Alkaline batteries are recommended for longer battery life.

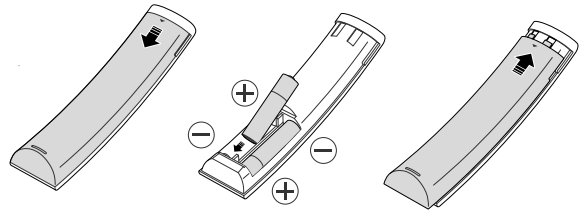

About the Samsung Smart Control

When you start the TV for the first time by pressing the **⏻ (Power)** button on the Samsung Smart Control, the TV automatically pairs with the Samsung Smart Control. Once the TV and Samsung Smart Control have paired, you can use the Samsung Smart Control to operate the TV.

- For more information about On-Screen Remote, see the e-Manual chapter, "Remote Control and Peripherals > Using the Samsung Smart Control > Displaying and using the On-Screen Remote."
- The buttons on the On-Screen Remote may differ from the existing models.
- We recommend using Samsung Smart Control at a distance of less than 6m. A usable distance may differ depending on the wireless environmental conditions.

Pairing the TV to the Samsung Smart Control

If your Samsung Smart Control is not paired to your TV, press and hold the buttons labelled ① and ② simultaneously for 3 seconds or more to pair the Samsung Smart Control to the TV.

- The Samsung Smart Control can only be paired to one TV at a time.

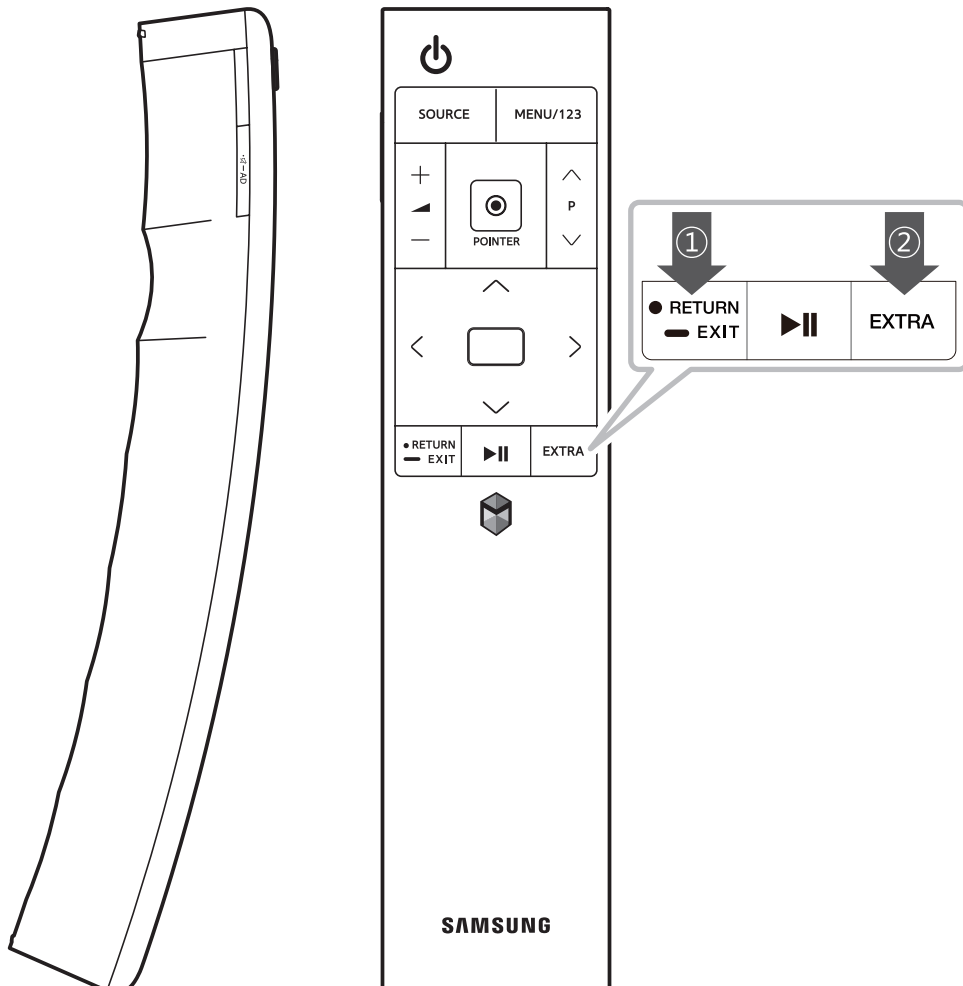

Using the POINTER to operate the TV

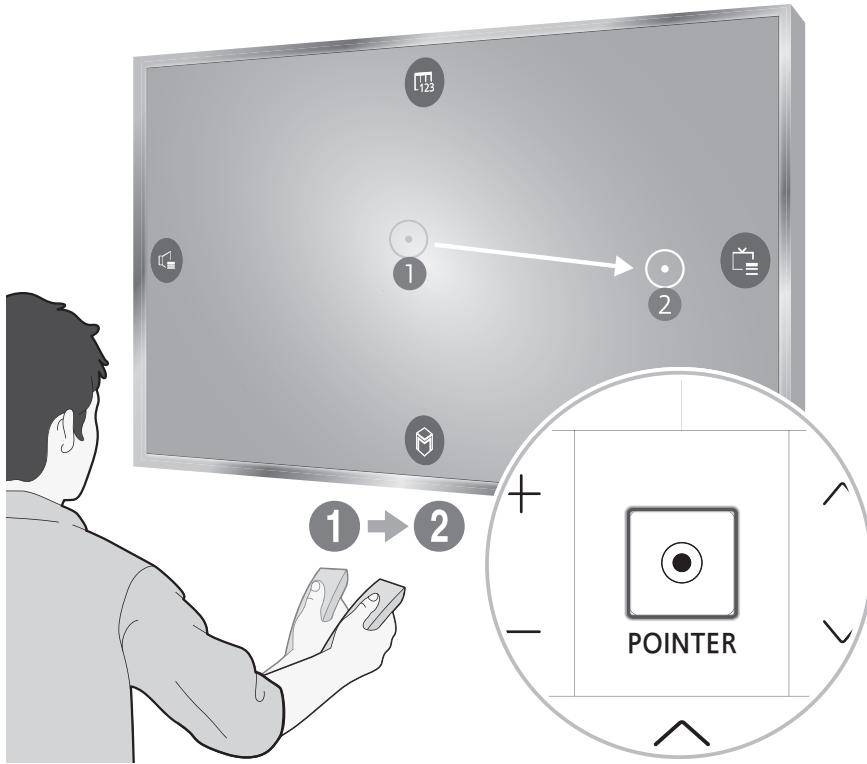

Place a finger on the **POINTER** button of the Samsung Smart Control, and then move the Samsung Smart Control. The pointer on the screen moves in the direction you moved the Samsung Smart Control. Press the **POINTER** to select or run a focused item.

 : Displays the On-Screen Remote.

 : Allows you to adjust the volume or select speakers.

 : Displays the channel list.

 : Launches Smart Hub.

To view a tutorial that shows how to use the **POINTER** button, select **MENU (MENU/123) > Support > Smart Control Tutorial**.

Using the On-Screen Remote

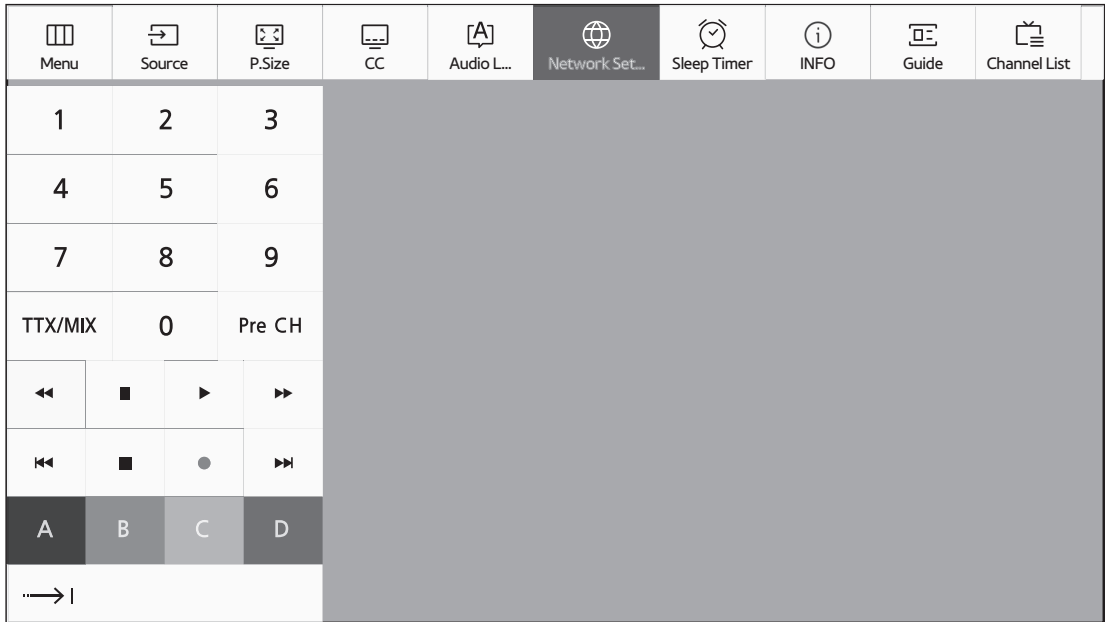

Press the **MENU/123** button on the Samsung Smart Control to display the On-Screen Remote on the TV's screen. Use the On-Screen Remote to enter numbers, control content playback, and use the features and functions of the TV, just like a real remote.

- Place a finger on the **POINTER** button of the Samsung Smart Control, and then move the Samsung Smart Control. The pointer on the screen moves in the direction you moved the Samsung Smart Control. Press the **POINTER** button to select or run a focused item.
- The On-Screen Remote may vary depending on the features or functions you are using.
- For more information about On-Screen Remote, see the e-Manual chapter, "Remote Control and Peripherals > Using the Samsung Smart Control > Displaying and using the On-Screen Remote."

Controlling External Devices with the TV Remote - Using the Universal Remote

System > Universal Remote Setup

You can control external devices connected to the TV using the TV's remote control.

- You can also use the Anynet+ (HDMI-CEC) function to operate external Samsung devices with your TV's remote control without any additional setup. For more information about Anynet+ (HDMI-CEC), see the e-Manual.
- Certain external devices connected to the TV may not support the universal remote feature.

Setting up the universal remote control

1. Turn on the external device you want to control with the universal remote function after connecting a HDMI cable to One Connect Mini's HDMI port.
2. Press the **SOURCE** button on your remote to bring up the **Source** screen.
3. Select the **Universal remote setup**.
4. Follow the directions on the screen to complete the set up and register the device. The directions will be different, depending on the device you want to control.
 - If the external device does not respond after being registered, register it again using its model number.
 - The TV memorises both the external device and the connection (HDMI 1, HDMI 2, etc.) the device is connected to.

05 Performing the initial setup

- The initial setup differs from model to model.
- Turn on the TV using the **⏻** button on the remote control or TV' Control stick.

Initial setup

The initial setup dialogue box appears when the TV is first activated. Follow the on-screen instructions to finish the initial setup process such as selecting the menu language, scanning channels, connecting to the network, and more. During each step, either make a choice or skip the step. You can manually perform this process at a later time in the **System > Setup** menu.

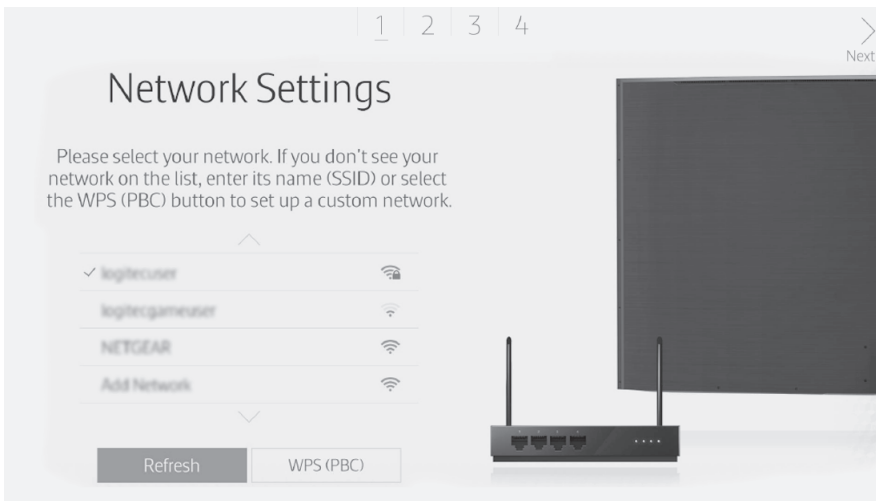

- If you connect any external device to HDMI IN (STB) before starting initial setup, the source of your live TV signal is set to **STB**. After finishing with this process, you will not be able to scan all channels and stores them in the TV's memory.
- If you want to connect aerial cable to your TV, select **Aerial**. In this case, you will be able to scan all channels and stores them in the TV's memory.

Setting up a password

System > Change PIN

You can set a Personal Identification Number (PIN) to lock channels, reset the TV, and change TV settings.

Changing the TV's password.

1. Run **Change PIN** and then enter the current password in the password field. The default password is "0-0-0-0".
2. Enter a new password and then enter it again to confirm it. The password change is complete.
 - If you forgot your PIN code, press the buttons in the following sequence to reset the PIN to "0-0-0-0":
For the Standard Remote Control: In Standby mode: **MUTE** → 8 → 2 → 4 → **POWER** (On)
For the Samsung Smart Control: When the TV turns on: **MUTE** → Volume up → **RETURN** → Volume down → **RETURN** → Volume up → **RETURN**

06 Selecting Connected Devices

Press the **SOURCE** button to switch between external devices connected to the TV.

For example, to switch to a gaming console connected to the second HDMI port, press **SOURCE**. From the **Source** list, select **HDMI2** to change the input signal to HDMI mode. Connector names may vary depending on the model.

- For some compatible devices connected via HDMI ports, the TV may automatically select the correct source when this device is accessed. For this to work, the HDMI Anynet+ system must be switched on (**System > Anynet+ (HDMI-CEC)**). Anynet+ will also automatically power off compatible HDMI devices when the TV is switched off.

The following options are available in the **Source** screen:

Options

To view the Options menu, press the **▼** button. The functions that appear in the Options menu can include any of the following:

- The port names or available options may vary depending on the product.

Edit Device Type

Changes the types of the external devices. Select an external device to change.

Edit Name

You can rename devices connected to the TV to facilitate identifying external sources. For example, you can use an HDMI cable to designate a computer connected to the TV as **PC**. You can also use a HDMI-to-DVI cable to designate an AV devices as **DVI Devices**.

Information

Displays information about the connected devices.

Anynet+ (HDMI-CEC)

Displays a list of Anynet+ (HDMI-CEC)-compliant devices that are connected to the TV.

- This option is only available when **Anynet+ (HDMI-CEC)** is set to **On**.

Remove USB Device

Removes a USB device connected to the TV.

Remove Source Thumbnail

Removes the captured images of the video that you viewed most recently saved on the external device connected to the TV.

Delete Universal Remote

Deletes the external device connected to the TV via the Universal Remote function.

Universal remote setup

You can use your TV remote control to control external devices.

07 The e-Manual



The embedded e-Manual contains information about the key features of your TV.

- You can download and view a printable version of the e-Manual on the Samsung website.



Displaying the e-Manual:

- On the Samsung Smart Control, press the **MENU/123** button, and then select **e-Manual** on the On-Screen Remote. On the Standard Remote Control, press the **E-MANUAL** button.
- On the TV's menu, select **Support > e-Manual**.

Using the buttons available on the main screen of the e-Manual

	Search	Select an item from the search results to load the corresponding page.
A-Z	Index	Select a keyword to navigate to the relevant page.
	Recent pages	Select a topic from the list of recently viewed topics.

Accessing the associated menu screen from an e-Manual topic page

	Try Now	Access the associated menu item and try out the feature directly.
	Link	Access a topic referred to on an e-Manual topic page.

Accessing the associated e-Manual topic from a menu screen

On the Standard Remote Control, press the **E-MANUAL** button on the remote control to read the e-Manual topic about a current screen menu function.

- The e-Manual cannot be accessed from some menu screens.

Updating the e-Manual to the latest version

You can update the e-Manual in the same way you update apps.

08 Troubleshooting and Maintenance

Troubleshooting

If the TV seems to have a problem, first review this list of possible problems and solutions. Alternatively, review the Troubleshooting Section in the e-Manual. If none of these troubleshooting tips apply, please visit “www.samsung.com” and click on Support, or contact the call centre listed on the back cover of this manual.

- This TFT LED panel is made up of sub pixels which require sophisticated technology to produce. There may be, however, a few bright or dark pixels on the screen. These pixels will have no impact on the performance of the product.
- To keep your TV in optimum condition, upgrade to the latest software. Use the **Update now** or **Auto Update** functions on the TV's menu (**MENU > Support > Software Update > Update now** or **MENU > Support > Software Update > Auto Update**).

Issues	Solutions and explanations
The TV is not powered on.	Make sure that the power cord is connected and that the remote has live batteries and is functioning properly. If the power cord is properly connected and the remote control is operating normally, there might arise a problem with the antenna cable connection, or the cable/set-top box might not be turned on. Check the antenna connection or turn on the cable/set-top box.
The TV won't turn on.	Make sure that the AC power cord is securely plugged in to the TV and the wall outlet. Make sure that the wall outlet is working. Try pressing the  button on the TV to make sure that the problem is not with the remote. If the TV turns on, refer to “The remote control does not work” on the next page.

<p>There is no picture/video.</p>	<p>Check the cable connections. Remove and reconnect all cables connected to the TV and external devices.</p> <p>Set the video outputs of your external devices (Cable/set-top box, DVD, Blu-ray etc) to match the TV's input connections. For example, if an external device's output is HDMI, connect it to an HDMI input on the TV.</p> <p>Make sure that your connected devices are powered on.</p> <p>Be sure to select the correct input source.</p> <p>Reboot the connected device by unplugging it and reconnecting the device's power cable.</p>
<p>The remote control does not work.</p>	<p>Replace the remote control batteries. Make sure that the batteries are installed with their poles (+/-) in the correct direction.</p> <p>Clean the sensor's transmission window on the remote.</p> <p>Try pointing the remote directly at the TV from 1.5~1.8 m away.</p>
<p>The Cable or set-top box remote control doesn't turn on/off the TV or adjust the volume.</p>	<p>Programme the cable or set-top box remote control to operate the TV. Refer to the Cable or set-top box user manual for the SAMSUNG TV code.</p>

Eco sensor and screen brightness

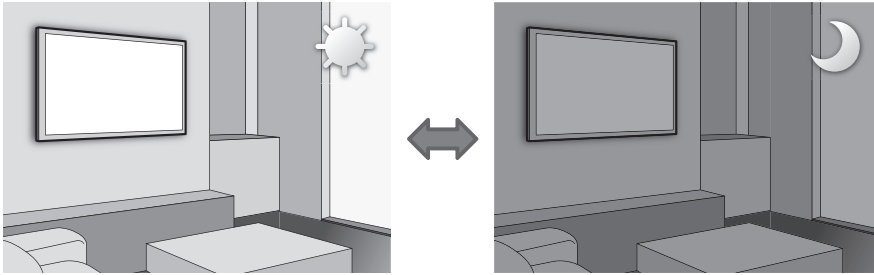

Eco Sensor adjusts the brightness of the TV automatically. This feature measures the light in your room and optimises the brightness of the TV automatically to reduce power consumption. If you want to turn this off, go to **System > Eco Solution > Eco Sensor**.

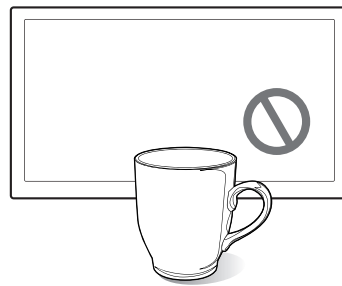
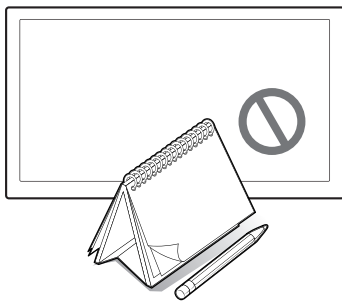

- If the screen is too dark while you are watching TV in a dark environment, it may be due to the **Eco Sensor**.
- Do not block the sensor with any object. This can decrease picture brightness.

Support through Remote Management

Samsung Remote Support service offers you one-on-one support with a Samsung Technician who can remotely.

- **Diagnose** your TV
- **Adjust** the TV settings for you
- **Perform a factory reset** your TV
- Install recommended **firmware updates**

How Does it Work?

Having a Samsung Tech remotely service your TV is easy.



1. Call the Samsung Contact Centre and ask for remote support.



2. Open the menu on your TV and go to the Support section.



3. Select Remote Management, and then read and agree to the service agreements. When the PIN screen appears, **provide the PIN number** to the agent.



4. The agent accesses your TV.

Caring for the TV

- If a sticker was attached to the TV screen, some debris can remain after you remove the sticker. Please clean the debris off before watching TV.
- The exterior and screen of the product can get scratched during cleaning. Be sure to wipe the exterior and screen carefully using a soft cloth to prevent scratches.

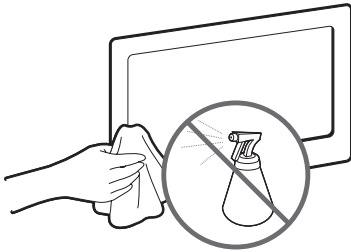

Do not spray water or any liquid directly onto the TV. Any liquid that goes into the product may cause a failure, fire, or electric shock.

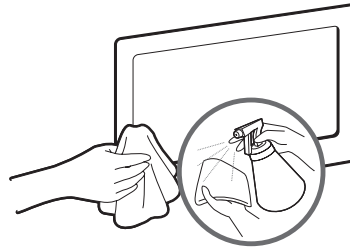

Turn off the TV, then gently wipe away smudges and fingerprints on the screen with a micro-fiber cloth. Clean the body of the TV with a soft cloth dampened with a small amount of water. Do not use flammable liquids (benzene, thinners, etc.) or a cleaning agent. For stubborn smudges, spray a small amount of screen cleaner on the cloth, and then use the cloth to wipe away the smudges.

09 Specifications and other information

TV Specifications

Display Resolution (pixel)	3840 x 2160	
Environmental Considerations		
Operating Temperature	10°C to 40°C (50°F to 104°F)	
Operating Humidity	10% to 80%, non-condensing	
Storage Temperature	-20°C to 45°C (-4°F to 113°F)	
Storage Humidity	5% to 95%, non-condensing	
Stand Swivel (Left / Right)	0°	
Model Name	UE48JS8500	UE55JS8500
Screen Size (Diagonal)	48 inches (121 cm)	55 inches (138 cm)
Screen Curvature	3000R	4200R
Sound (Output)	40 W (L: 10 W, R: 10 W, Woofer: 10 W x 2)	
Dimensions (W x H x D)		
Body	1083.1 x 632.4 x 92.9 mm	1239.3 x 723.7 x 91.5 mm
With stand	1083.1 x 688.8 x 308.4 mm	1239.3 x 776.2 x 308.4 mm
Weight		
Without Stand	16.1 kg	20.9 kg
With Stand	19.0 kg	23.8 kg
Model Name	UE65JS8500	
Screen Size (Diagonal)	65 inches (163 cm)	
Screen Curvature	4200R	
Sound (Output)	40 W (L: 10 W, R: 10 W, Woofer: 10 W x 2)	
Dimensions (W x H x D)		
Body	1453.2 x 835.3 x 106.3 mm	
With stand	1453.2 x 904.0 x 335.2 mm	
Weight		
Without Stand	29.0 kg	
With Stand	33.3 kg	

- The design and specifications are subject to change without prior notice.
- For information about the power supply, and about power consumption, refer to the label attached to the product.
- Typical power consumption is measured according to IEC 62087 Ed.2

Decreasing power consumption

When you shut the TV off, it enters Standby mode. In Standby mode, it continues to draw a small amount of power. To decrease power consumption, unplug the power cord when you don't intend to use the TV for a long time.

Licences

HDMI The terms HDMI and HDMI High-Definition Multimedia Interface, and the HDMI Logo are trademarks or registered trademarks of HDMI Licensing LLC in the United States and other countries.



Still image warning

Avoid displaying still images (such as jpeg picture files), still image elements (such as TV channel logos, stock or news bars at the bottom of the screen etc.), or programmes in panorama or 4:3 image format. Constantly displaying still pictures can cause image burn-in on the LED screen, which will affect the image quality. To reduce risk of this occurring please follow the recommendations below:

- Avoid displaying the still image for long periods.
- Always try to display any image in full screen. Use the TV set's picture format menu for the best possible match.
- Reduce brightness and contrast to avoid the appearance of after-images.
- Use all TV features designed to reduce image retention and screen burn. Refer to the e-Manual for more details.

Recommendation - EU Only



Hereby, Samsung Electronics, declares that this TV is in compliance with the essential requirements and other relevant provisions of Directive 1999/5/EC.

The official Declaration of Conformity may be found at <http://www.samsung.com>, go to Support > Search Product Support and enter the model name.

This equipment may only be used indoors.

This equipment may be operated in all EU countries.



Correct Disposal of This Product (Waste Electrical & Electronic Equipment) **(Applicable in countries with separate collection systems)**

This marking on the product, accessories or literature indicates that the product and its electronic accessories (e.g. charger, headset, USB cable) should not be disposed of with other household waste at the end of their working life. To prevent possible harm to the environment or human health from uncontrolled waste disposal, please separate these items from other types of waste and recycle them responsibly to promote the sustainable reuse of material resources.

Household users should contact either the retailer where they purchased this product, or their local government office, for details of where and how they can take these items for environmentally safe recycling.

Business users should contact their supplier and check the terms and conditions of the purchase contract. This product and its electronic accessories should not be mixed with other commercial wastes for disposal.



Correct disposal of the batteries in this product **(Applicable in countries with separate collection systems)**

This marking on battery, manual or packaging indicates that the batteries in this product should not be disposed of with other household waste at the end of their working life. Where marked, the chemical symbols Hg, Cd or Pb indicate that the battery contains mercury, cadmium or lead above the reference levels in EC Directive 2006/66. If batteries are not properly disposed of, these substances can cause harm to human health or the environment.

To protect natural resources and to promote material reuse, please separate batteries from other types of waste and recycle them through your local, free battery return system.

- **WARNINGS:** Image retention, commonly known as screen burn-in, can occur on most types of television if the same image is displayed continuously. The most common causes of image retention are logos that remain stationary on the TV screen. These logos are common on many programmes received via a Set-top Box. To reduce this risk, avoid displaying still images for long durations and lower the brightness or contrast settings to decrease the intensity of the picture. Extended viewing of movies and programmes in aspect ratios that are different from the aspect ratio of the TV may cause image retention. Always try to avoid black borders at the top or bottom by using the zoom function. This will help eliminate the black borders and fit the picture to the entire area of the screen. Using a video game console may cause image retention and is not recommended. When using a PC input, avoid displaying still images for long durations and reduce the brightness or contrast settings to decrease the intensity of the picture.
- **IMPORTANT:** Image retention issues are not covered by your Samsung® warranty.

Warranty Card



United Kingdom



Republic of Ireland (EIRE)

This Samsung product is warranted for a period of twelve (12) months from the original date of purchase, against defective materials and workmanship. In the event that warranty service is required, you should return the product to the retailer from whom it was purchased. However, Samsung Authorised Dealers and Authorised Service Centres in other EC Countries will comply with the warranty on the terms issued to purchasers in the country concerned. In case of difficulty, details of our Authorised Service Centres are available from:

Samsung Electronics U.K. Ltd
Samsung Customer Support Centre
Selectapost 38, Sheffield, S97 3FJ
United Kingdom

United Kingdom
Tel : 0330 SAMSUNG (7267864)
www.samsung.com/uk/support

EIRE
Tel : 0818 717100
www.samsung.com/ie/support

WARRANTY CONDITIONS

1. The warranty is only valid if, when warranty service is required, the warranty card is fully and properly completed and is presented with the original invoice or sales slip or confirmation, and the serial number on the product has not been defaced.
2. Samsung's obligations are limited to the repair or, at its discretion, replacement of the product or the defective part.
3. Warranty repairs must be carried out by Authorised Samsung Dealers or Authorised Service Centres. No re-imburement will be made for repairs carried out by non Samsung Dealers and, any such repair work and damage to the products caused by such repair work will not be covered by this warranty.
4. This product is not considered to be defective in materials nor workmanship by reason that it requires adaptation in order to conform to national or local technical or safety standards in force in any country other than the one for which the product was originally designed and manufactured.
5. This warranty covers none of the following:
 - a) Periodic check ups, maintenance and repair or replacement of parts due to normal wear and tear.
 - b) Cost relating to transport, removal or installation of the product.
 - c) Misuse, including the failure to use this product for its normal purposes or incorrect installation.
 - d) Damage caused by Lightning, Water, Fire, Acts of God, War, Public Disturbances, incorrect mains voltage, improper ventilation or any other cause beyond the control of Samsung.
 - e) Spillage of food or liquid or use of any other hazardous substances, which may effect the product.
 - f) Performance due to differences in broadcasting method between countries
6. This warranty is valid for any person who legally acquired possession of the product during the warranty period.
7. The consumers statutory rights in any applicable national legislation whether against the retailer arising from the purchase contract or otherwise are not affected by this warranty. Unless there is national legislation to the contrary, the rights under this warranty are the consumers sole rights and Samsung, its subsidiaries and distributors shall not be liable for indirect or consequential loss or any damage to records, compact discs, videos or audio taper or any other related equipment or material.
8. Some products may differ from these guidelines. Please check with your dealer or the local Samsung web-site.



Contact SAMSUNG WORLD WIDE

If you have any questions or comments relating to Samsung products, please contact the SAMSUNG customer care centre.

Country	Customer Care Centre ☎	Web Site
EIRE	0818 717100	www.samsung.com/ie/support
UK	0330 SAMSUNG (7267864)	www.samsung.com/uk/support

'This Nanum Gothic Eco font is provided by NAVER'

© 2015 Samsung Electronics Co., Ltd. All rights reserved.



BN68-07296G-01