

Microwave Oven

User manual

MC32J7055C*



SAMSUNG

Contents

Safety instructions	3		
Important safety instructions	3	Adjusting the cooking time	13
Microwave function only	3	Stopping the cooking	14
Oven function only - optional	5	Setting the energy save mode	14
General safety	6	Using the slim fry cook features	14
Microwave operation precautions	7	Using the sensor cook features	16
Limited warranty	7	Using the healthy cooking features	19
Cooking instructions on food packaging	8	Using the dough proof/yogurt features	21
Cooking instructions	8	Using the power defrost features	22
Product group definition	8	Using the auto reheat/cook features	23
Correct Disposal of This Product (Waste Electrical & Electronic Equipment)	8	Using the crusty plate	24
		Convection	25
Installation	9	Grilling	25
Accessories	9	Choosing the accessories	26
Installation site	9	Combining microwaves and grill	26
Turntable	9	Combining microwaves and convection	27
		Switching the beeper off	28
Maintenance	10	Using the child lock features	28
Cleaning	10	Using the turntable on/off features	29
Replacement (repair)	10	Cookware guide	29
Care against an extended period of disuse	10	Cooking guide	30
		Troubleshooting and information code	40
Oven features	11	Troubleshooting	40
Oven	11	Information code	44
Control panel	11	Technical specifications	44
Oven use	12		
How a microwave oven works	12		
Checking that your oven is operating correctly	12		
Setting the time	12		
Cooking/Reheating	13		
Power levels and time variations	13		

Safety instructions

IMPORTANT SAFETY INSTRUCTIONS

READ CAREFULLY AND KEEP FOR FUTURE REFERENCE.

MICROWAVE FUNCTION ONLY

WARNING: If the door or door seals are damaged, the oven must not be operated until it has been repaired by a competent person.

WARNING: It is hazardous for anyone other than a competent person to carry out any service or repair operation that involves the removal of a cover which gives protection against exposure to microwave energy.

WARNING: Liquids and other foods must not be heated in sealed containers since they are liable to explode.

WARNING: Only allow children to use the oven without supervision when adequate instructions have been given so that the child is able to use the oven in a safe way and understands the hazards of improper use.

This appliance is intended to be used in household only and it is not intended to be used such as:

- staff kitchen areas in shops, offices and other working environments;
- farm houses;

- by clients in hotels, motels and other residential environments;
- bed and breakfast type environments.

Only use utensils that are suitable for use in microwave ovens. When heating food in plastic or paper containers, keep an eye on the oven due to the possibility of ignition.

Metallic containers for food and beverages are not allowed during microwave cooking.

The microwave oven is intended for heating food and beverages. Drying of food or clothing and heating of warming pads, slippers, sponges, damp cloth and similar may lead to risk of injury, ignition or fire.

If smoke is observed (emitted), switch off or unplug the appliance and keep the door closed in order to stifle any flames.

Microwave heating of beverages can result in delayed eruptive boiling, therefore care must be taken when handling the container.

The contents of feeding bottles and baby food jars shall be stirred or shaken and the temperature checked before consumption, in order to avoid burns.

Safety Instructions

Eggs in their shell and whole hard-boiled eggs should not be heated in microwave ovens since they may explode, even after microwave heating has ended.

The oven should be cleaned regularly and any food deposits removed.

Failure to maintain the oven in a clean condition could lead to deterioration of the surface that could adversely affect the life of the appliance and possibly result in a hazardous situation.

The microwave oven is intended to be used on the counter top (freestanding) use only, the microwave oven shall not be placed in a cabinet.

The appliance should not be cleaned with a water jet.

The appliance is not intended for installing in road vehicles, caravans and similar vehicles etc.

This appliance is not intended for use by persons (including children) with reduced physical, sensory or mental capabilities, or lack of experience and knowledge, unless they have been given supervision or instruction concerning use of the appliance by a person responsible for their safety.

Children should be supervised to ensure that they do not play with the appliance.

This appliance can be used by children aged from 8 years and above and persons with reduced physical, sensory or mental capabilities or lack of experience and knowledge if they have been given supervision or instruction concerning use of the appliance in a safe way and understand the hazards involved. Children shall not play with the appliance. Cleaning and user maintenance shall not be made by children without supervision. If the supply cord is damaged, it must be replaced by the manufacturer, its service agent or similarly qualified persons in order to avoid a hazard.

This oven should be positioned proper direction and height permitting easy access to cavity and control area.

Before using the your oven first time, oven should be operated with the water during 10 minute and then used.

If the oven generates a strange noise, a burning smell, or smoke is emitted, unplug the power plug immediately and contact your nearest service center.

The microwave oven has to be positioned so that plug is accessible.

OVEN FUNCTION ONLY - OPTIONAL

WARNING: When the appliance is operated in the combination mode, children should only use the oven under adult supervision due to the temperatures generated.

During use the appliance becomes hot. Care should be taken to avoid touching heating elements inside the oven.

WARNING: Accessible parts may become hot during use. Young children should be kept away.

A steam cleaner is not to be used.

Do not use harsh abrasive cleaners or sharp metal scrapers to clean the oven door glass since they can scratch the surface, which may result in shattering of the glass.

WARNING: Ensure that the appliance is switched off before replacing the lamp to avoid the possibility of electric shock. Do not use harsh abrasive cleaners or sharp metal scrapers to clean the oven door glass since they can scratch the surface, which may result in shattering of the glass.

WARNING: The appliance and its accessible parts become hot during use.

Care should be taken to avoid touching heating elements.

Children less than 8 years of age shall be kept away unless continuously supervised.

This appliance can be used by children aged from 8 years and above and persons with reduced physical, sensory or mental capabilities or lack of experience and knowledge if they have been given supervision or instruction concerning use of the appliance in a safe way and understand the hazards involved. Children shall not play with the appliance. Cleaning and user maintenance shall not be made by children without supervision. The door or the outer surface may get hot when the appliance is operating.

The temperature of accessible surfaces may be high when the appliance is operating.

The appliances are not intended to be operated by means of an external timer or separate remote-control system.

Safety Instructions

This appliance can be used by children aged from 8 years and above and persons with reduced physical, sensory or mental capabilities or lack of experience and knowledge if they have been given supervision or instruction concerning use of the appliance in a safe way and understand the hazards involved. Children shall not play with the appliance. Cleaning and user maintenance shall not be made by children unless they are older than 8 and supervised.

Keep the appliance and its cord out of reach of children less than 8 years.

General safety

Any modifications or repairs must be performed by qualified personnel only.
Do not heat food or liquids sealed in containers for the microwave function.
Do not use benzene, thinner, alcohol, or steam or high-pressure cleaners to clean the oven.
Do not install the oven: near a heater or flammable material; locations that are humid, oily, dusty or exposed to direct sunlight or water; or where gas may leak; or an uneven surface.
This oven must be properly grounded in accordance with local and national codes. Regularly use a dry cloth to remove foreign substances from the power plug terminals and contacts.
Do not pull, excessively bend, or place heavy objects on the power cord.
If there is a gas leak (propane, LP, etc) ventilate immediately. Do not touch the power cord.
Do not touch the power cord with wet hands.
While the oven is operating, do not turn it off by unplugging the power cord.
Do not insert fingers or foreign substances. If foreign substances enter the oven, unplug the power cord and contact a local Samsung service centre.

Do not apply excessive pressure or impact to the oven.
Do not place the oven over fragile objects.
Ensure the power voltage, frequency, and current matches the product specifications.
Firmly plug the power plug into the wall socket. Do not use multiple plug adapters, extension cords, or electric transformers.
Do not hook the power cord on metal objects. Make sure the cord is between objects or behind the oven.
Do not use a damaged power plug, power cord, or loose wall socket. For damaged power plugs or cords, contact a local Samsung service centre.
Do not pour or directly spray water onto the oven.
Do not place objects on the oven, inside, or on the oven door.
Do not spray volatile materials such as insecticide on the oven.
Do not store flammable materials in the oven. Because alcohol vapours can contact hot parts of the oven, use caution when heating food or drinks containing alcohol. Children may bump themselves or catch their fingers on the door. When opening/closing the door, keep children away.

Microwave warning

Microwave heating of beverages may result in delayed eruptive boiling; always use caution when handling the container. Always allow beverages to stand at least 20 seconds before handling. If necessary, stir during heating. Always stir after heating.
In the event of scalding, follow these First Aid instructions:

1. Immerse the scalded area in cold water for at least 10 minutes.
2. Cover with a clean, dry dressing.
3. Do not apply any creams, oils, or lotions.

To avoid damaging the tray or rack, do not put the tray or rack in water shortly after cooking.
Do not use the oven for deep fat frying because the oil temperature cannot be controlled. This could result in a sudden boil over of hot oils.

Microwave oven precautions

Only use microwave-safe utensils. Do not use metallic containers, gold or silver trimmed dinnerware, skewers, etc.

Remove wire twist ties. Electric arcing may occur.

Do not use the oven to dry papers or clothes.

Use shorter times for small amounts of food to prevent overheating or burning.

Keep the power cord and power plug away from water and heat sources.

To avoid the risk of explosion, do not heat eggs with shells or hard-boiled eggs. Do not heat airtight or vacuum-sealed containers, nuts, tomatoes, etc.

Do not cover the ventilation slots with cloth or paper. This is a fire hazard. The oven may overheat and turn off automatically and will remain off until it cools sufficiently.

Always use oven mitts when removing a dish.

Stir liquids halfway during heating or after heating ends and allow the liquid stand at least 20 seconds after heating to prevent eruptive boiling.

Stand at arms length from the oven when opening the door to avoid getting scalded by escaping hot air or steam.

Do not operate the oven when it is empty. The oven will automatically shut down for 30 minutes for safety purposes. We recommend placing a glass of water inside the oven at all times to absorb microwave energy in case the oven is started accidentally.

Install the oven in compliance with the clearances in this manual. (See Installing your microwave oven.)

Use caution when connecting other electrical appliances to sockets near the oven.

Microwave operation precautions

Failure to observe the following safety precautions may result in harmful exposure to microwave energy.

- Do not operate the oven with the door open. Do not tamper with the safety interlocks (door latches). Do not insert anything into the safety interlock holes.
- Do not place any object between the oven door and front face or allow food or cleaner residue to accumulate on sealing surfaces. Keep the door and door sealing surfaces clean by wiping with a damp cloth and then with a soft, dry cloth after each use.

- Do not operate the oven if it is damaged. Only operate after it has been repaired by a qualified technician.

Important: the oven door must close properly. The door must not be bent; the door hinges must not be broken or loose; the door seals and sealing surfaces must not be damaged.

- All adjustments or repairs must be done by a qualified technician.

Limited warranty

Samsung will charge a repair fee for replacing an accessory or repairing a cosmetic defect if the damage to the unit or accessory was caused by the customer. Items this stipulation covers include:

- Door, handles, out-panel, or control panel that are dented, scratched, or broken.
- A broken or missing tray, guide roller, coupler, or wire rack.

Use this oven only for its intended purpose as described in this instruction manual. Warnings and Important Safety Instructions in this manual do not cover all possible conditions and situations that may occur. It is your responsibility to use common sense, caution, and care when installing, maintaining, and operating your oven.

Because these following operating instructions cover various models, the characteristics of your microwave oven may differ slightly from those described in this manual and not all warning signs may be applicable. If you have any questions or concerns, contact a local Samsung service centre or find help and information online at www.samsung.com.

Use this oven for heating food only. It is intended for domestic use only. Do not heat any type of textiles or cushions filled with grains. The manufacturer cannot be held liable for damage caused by improper or incorrect use of the oven. To avoid deterioration of the oven surface and hazardous situations, always keep the oven clean and well maintained.

Safety Instructions

Product group definition

This product is a Group 2 Class B ISM equipment. The definition of group 2 which contains all ISM equipment in which radio-frequency energy is intentionally generated and/or used in the form of electromagnetic radiation for the treatment of material, and EDM and arc welding equipment.

For Class B equipment is equipment suitable for use in domestic establishments and in establishments directly connected to a low voltage power supply network which supplies buildings used for domestic purposes.

Correct Disposal of This Product (Waste Electrical & Electronic Equipment)

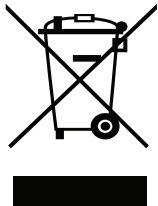

(Applicable in countries with separate collection systems)

This marking on the product, accessories or literature indicates that the product and its electronic accessories (e.g. charger, headset, USB cable) should not be disposed of with other household waste at the end of their working life. To prevent possible harm to the environment or human health from uncontrolled waste disposal, please separate these items from other types of waste and recycle them responsibly to promote the sustainable reuse of material resources.

Household users should contact either the retailer where they purchased this product, or their local government office, for details of where and how they can take these items for environmentally safe recycling.

Business users should contact their supplier and check the terms and conditions of the purchase contract. This product and its electronic accessories should not be mixed with other commercial wastes for disposal.

For information on Samsung's environmental commitments and product specific regulatory obligations e.g. REACH visit: samsung.com/uk/aboutsamsung/samsungelectronics/corporatecitizenship/data_corner.html

Cooking instructions on food packaging

Microwave Symbols

On the front of your oven there is a microwave oven symbol, as shown below.



This symbol has been introduced for your benefit when cooking or reheating packaged food.

Packaged food is also, increasingly, using a microwave symbol similar to the one below. When you see this symbol on food packaging, cooking instructions are based on either the IEC Power Output Rating, or the Reheating Categories A, B, C, D or E.

Cooking instructions

The IEC Power Output rating is an internationally standardised rating, so all microwave manufacturers now use the same method of measuring power output. If food packaging gives cooking instructions based on IEC Power ratings, set cooking times according to the IEC Power of your oven.

For example :

If the cooking instructions are based on a 650 W oven, then you will need to reduce some cooking time for the MC32J7055C* (900 W).

Ready meals are now very convenient and popular. These are meals which are already prepared and cooked by the food manufacturer, and then frozen, chilled or vacuum sealed for long life.

Increasingly, heating times for such ready meals are being based on the Heating Categories A, B, C, D and E.

On this instance, simply match the heating category of your oven to the instructions on the food package, and set your timer accordingly.

For example :

If the heating instructions are 3 minutes on HIGH for a D category oven, then you will need to set your timer for less than 3 minutes on HIGH for the MC32J7055C* (E category).

IMPORTANT: Always remember that cooking instructions are intended only as a guide. If you have followed the instructions and the food is still not piping hot throughout, simply return it to the oven and cook it until it is.

Installation

Accessories

Depending on the model that you have purchased, you are supplied with several accessories that can be used in a variety of ways.

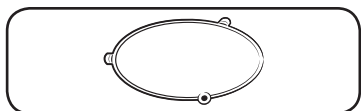

01 Roller ring, to be placed in the centre of the oven.

Purpose: The roller ring supports the turntable.

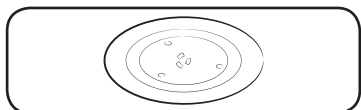

02 Turntable, to be placed on the roller ring with the centre fitting on to the coupler.

Purpose: The turntable serves as the main cooking surface; it can be easily removed for cleaning.

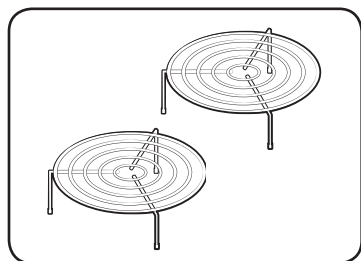

03 High rack, Low rack, to be placed on the turntable.

Purpose: The metal racks can be used to cook two dishes at the same time. A small dish may be placed on the turntable and a second dish on the rack. **The metal racks can be used in grill, convection and combination cooking.**

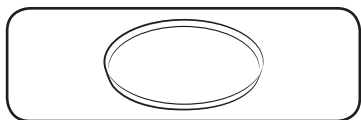

04 Crusty plate, see page 24.

Purpose: The crusty plate is used to brown food better in the microwave or grill combination cooking modes. It helps keep pastry and pizza dough crisp.

⚠ CAUTION

DO NOT operate the microwave oven without the roller ring and turntable.

Installation site

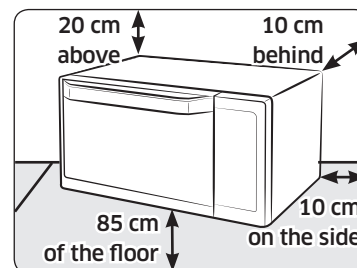

- Select a flat, level surface approx. 85 cm above the floor. The surface must support the weight of the oven.
- Secure room for ventilation, at least 10 cm from the rear wall and both sides, and 20 cm from above.
- Do not install the oven in hot or damp surroundings, such as next to other microwave ovens or radiators.
- Conform to the power supply specifications of this oven. Use only approved extension cables if you need to use.
- Wipe the interior and the door seal with a damp cloth before using your oven for the first time.

Turntable

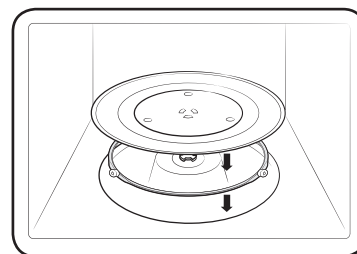

Remove all packing materials inside the oven. Install the roller ring and turntable. Check that the turntable rotates freely.



Maintenance

Cleaning

Clean the oven regularly to prevent impurities from building up on or inside the oven. Also pay special attention to the door, door sealing, and turntable and roller ring (applicable models only).

If the door won't open or close smoothly, first check if the door seals have built up impurities. Use a soft cloth in soapy water to clean both the inner and outer sides of the oven. Rinse and dry well.

To remove stubborn impurities with bad smells from inside the oven

1. With an empty oven, put a cup of diluted lemon juice on the centre of the turntable.
2. Heat the oven for 10 minutes at max power.
3. When the cycle is complete, wait until the oven cools down. Then, open the door and clean the cooking chamber.

To clean inside swing-heater models

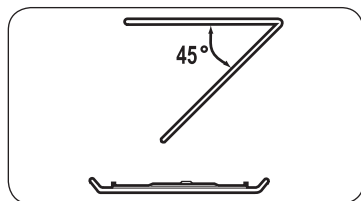

To clean the upper area of the cooking chamber, lower the top heating element by 45° as shown. This will help clean the upper area. When done, reposition the top heating element.

⚠ CAUTION

- Keep the door and door sealing clean and ensure the door opens and closes smoothly. Otherwise, the oven's lifecycle may be shortened.
- Take caution not to spill water into the oven vents.
- Do not use any abrasive or chemical substances for cleaning.
- After each use of the oven, use a mild detergent to clean the cooking chamber after waiting for the oven to cool down.

Replacement (repair)

⚠ WARNING

This oven has no user-removable parts inside. Do not try to replace or repair the oven yourself.

- If you encounter a problem with hinges, sealing, and/or the door, contact a qualified technician or a local Samsung service centre for technical assistance.
- If you want to replace the light bulb, contact a local Samsung service centre. Do not replace it yourself.
- If you encounter a problem with the outer housing of the oven, first unplug the power cord from the power source, and then contact a local Samsung service centre.

Care against an extended period of disuse

If you don't use the oven for an extended period of time, unplug the power cord and move the oven to a dry, dust-free location. Dust and moisture that builds up inside the oven may affect the performance of the oven.



Oven features

Oven

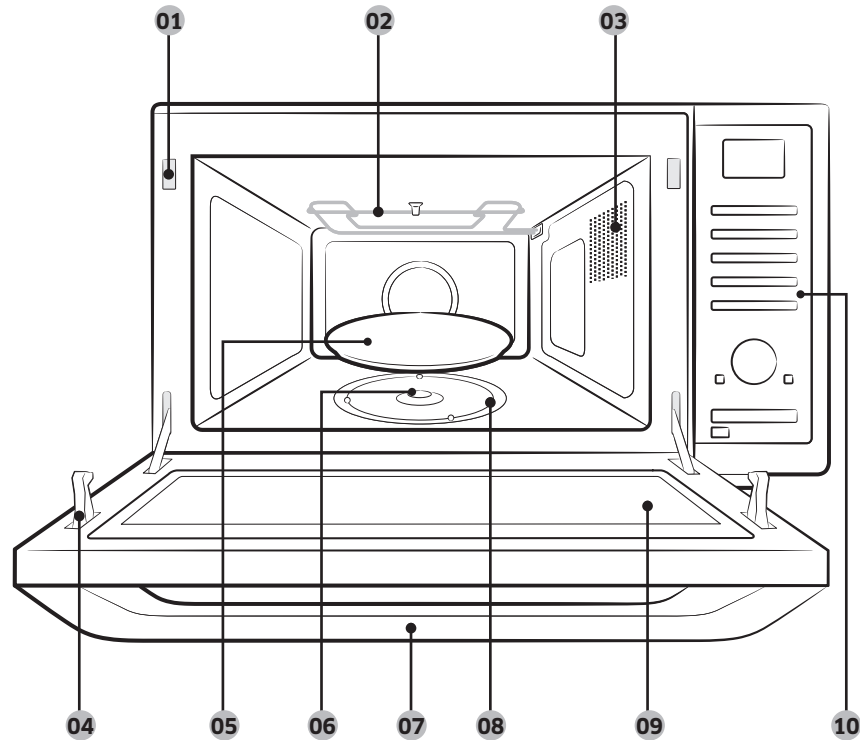

- | | | |
|----------------------------------|---------------------------|-----------------------------|
| 01 Safety interlock holes | 02 Heating element | 03 Ventilation holes |
| 04 Door latches | 05 Turntable | 06 Coupler |
| 07 Door Handle | 08 Roller Ring | 09 Door |
| 10 Control Panel | | |

Control panel

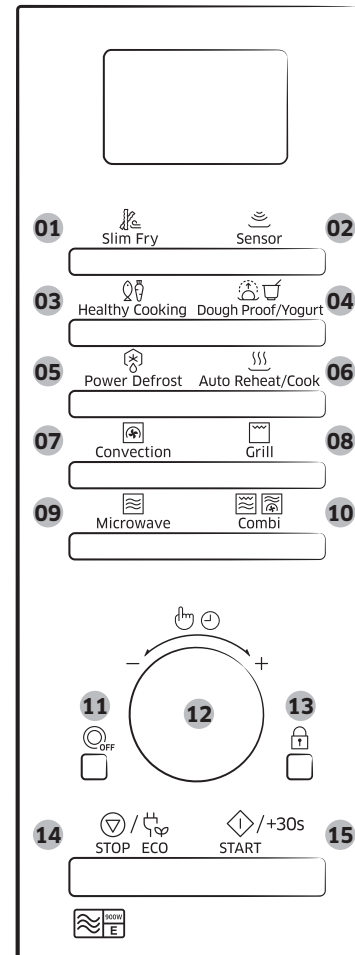

- 01** Slim Fry Button
- 02** Sensor Button
- 03** Healthy Cooking Button
- 04** Dough Proof/Yogurt Button
- 05** Power Defrost Button
- 06** Auto Reheat/Cook Button
- 07** Convection Button
- 08** Grill Button
- 09** Microwave Button
- 10** Combi Button
- 11** Turntable On/Off Button
- 12** Multi Function Selector Dial
- 13** Child Lock Button
- 14** Stop/Eco Button
- 15** Start/+30s Button

Oven use

How a microwave oven works

Microwaves are high-frequency electromagnetic waves; the energy released enables food to be cooked or reheated without changing either the form or the colour.

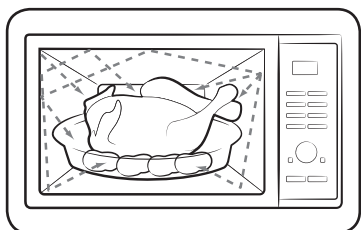

1. The microwaves are reflected at cavity and distributed uniformly as the food rotates on the turntable. The food is cooked evenly.
2. The microwaves are absorbed by the food up to a depth of about 1 inch (2.5 cm).
3. Cooking times can be changed by properties of the food or cookware.
 - Quantity and density
 - Water content
 - Initial temperature (refrigerated or not)

Checking that your oven is operating correctly

The following simple procedure enables you to check that your oven is working correctly.

If you are in doubt, refer to "Troubleshooting" on the page **40** to **43**.

NOTE

The oven must be plugged into an appropriate wall socket. The turntable must be in position in the oven.

Open the oven door. Place a glass of water on the turntable. Close the door.



Press the **START/+30s** button and set the time to 4 or 5 minutes

Result: The oven heats the water for 4 or 5 minutes. The water should then be boiling.

Setting the time

When power is supplied, "12:00" is automatically displayed on the display. Please set the current time. The time can be displayed in either the 24-hour or 12-hour notation. You must set the clock:

- When you first install your microwave oven
- After a power failure

NOTE

Do not forget to reset the clock when you switch to and from summer and winter time.

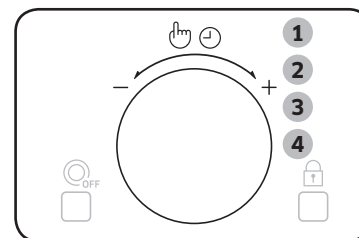

1. Press the **Multi Function Selector Dial**.
2. Turn the **Multi Function Selector Dial** to set time display type. (12H or 24H)
3. Press the **Multi Function Selector Dial** to complete the setup.
4. Turn the **Multi Function Selector Dial** to set the hour.

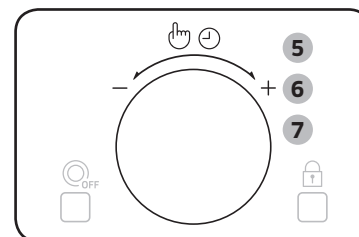

5. Press the **Multi Function Selector Dial**.
6. Turn the **Multi Function Selector Dial** to set the minute.
7. When the right time is displayed, press the **Multi Function Selector Dial** to start the clock.

Result: The time is displayed whenever you are not using the microwave oven.

Cooking/Reheating

The following procedure explains how to cook or reheat food.

⚠ CAUTION

ALWAYS check your cooking settings before leaving the oven unattended. Open the door. Place the food in the centre of the turntable. Close the door. Never switch the microwave oven on when it is empty.

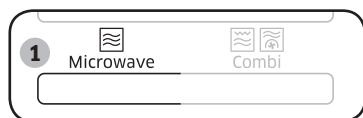

1. Press the **Microwave** button.
Result: The following indications are displayed:
 (microwave mode)

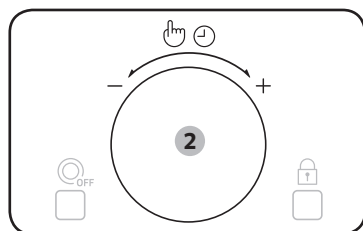

2. Turn the **Multi Function Selector Dial** until the appropriate power level is displayed. At that time, press the **Multi Function Selector Dial** to set the power level.
 - If don't set the power level within 5 seconds, Automatically changes to the cooking time setting stage.

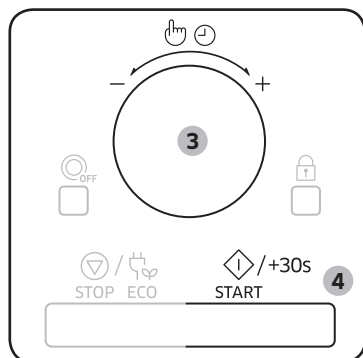

3. Set the cooking time by turning the **Multi Function Selector Dial**.
Result: The cooking time is displayed.
4. Press the **START/+30s** button.
Result: The oven light comes on and the turntable starts rotating. Cooking starts and when it has finished.
 1. The oven beeps 4 times.
 2. The end reminder signal will beep 3 times (once every minute).
 3. The current time is displayed again.

Power levels and time variations

The power level function enables you to adapt the amount of energy dissipated and thus the time required to cook or reheat your food, according to its type and quantity.

You can choose between six power levels.

Power level	Percentage	Output
FULL	100 %	900 W
MEDIUM HIGH	67 %	600 W
MEDIUM	50 %	450 W
MEDIUM LOW	33 %	300 W
DEFROST	20 %	180 W
LOW	11 %	100 W

The cooking times given in recipes and in this booklet correspond to the specific power level indicated.

If you select a...	Then the cooking time must be...
Higher power level	Decreased
Lower power level	Increased

Adjusting the cooking time

You can increase the cooking time by pressing the **START/+30s** button once for each 30 seconds to be added.

- Check how cooking is progressing at any time simply by opening the door
- Increase the remaining cooking time

Oven Use

Oven use

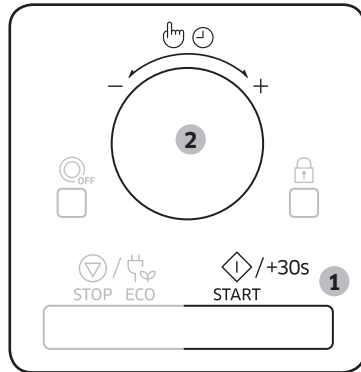

Method 1.

To increase the cooking time of your food during cooking, press the **START/+30s** button once for each 30 seconds that you wish to add.

- Example: To add three minutes, press the **START/+30s** button six times.

Method 2.

Just turning **Multi Function Selector Dial** to adjust cooking time.

- To increase cooking time, turn to right and to decrease cooking time, turn to left.

Stopping the cooking

You can stop cooking at any time so that you can:

- Check the food
- Turn the food over or stir it
- Leave it to stand

To stop the cooking...	Then...
Temporarily	Open the door or press the STOP/ECO button once. Result: Cooking stops. To resume cooking, close the door again and press the START/+30s button.
Completely	Press the STOP/ECO button once. Result: Cooking stops. If you wish to cancel the cooking settings, press the STOP/ECO button again.

Setting the energy save mode

The oven has an energy save mode.



- Press the **STOP/ECO** button.
Result: Display off.
- To remove energy save mode, open the door or press the **STOP/ECO** button and then display shows current time. The oven is ready for use.

NOTE

Auto energy saving function

If you do not select any function when appliance is in the middle of setting or operating with temporary stop condition, function is canceled and clock will be displayed after 25 minutes.

Oven Lamp will be turned off after 5 minutes with door open condition.

Using the slim fry cook features

The 12 **Slim Fry** cook features include/provide pre-programmed cooking times. You do not need to set either the cooking times or the power level.

You can adjust the slim fry cook category by press the **Slim Fry** button.

First, place the food in the centre of the turntable and close the door.

NOTE

- ALWAYS use microwave-safe and oven-proof cookware. Glass or ceramic dishes are ideal as they allow the microwaves to penetrate the food evenly
- ALWAYS use oven gloves when touching the recipients in the oven, as they will be very hot.



1. Press the **Slim Fry** button.

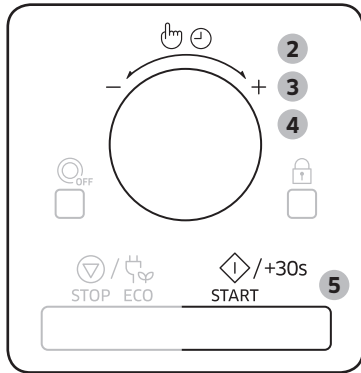

2. Select the category of food by turning the **Multi Function Selector Dial** and press the **Multi Function Selector Dial**.
 1. Potatoes/Vegetables
 2. Seafood
 3. Chicken
4. Select the type of food that you are cooking by turning the **Multi Function Selector Dial**.
Refer to the table on the following page for a description of the various pre-programmed settings.
At that time, press the **Multi Function Selector Dial** to select the type of food.
5. Select the size of the serving by turning the **Multi Function Selector Dial**.
6. Press the **START/+30s** button.

Slim fry guide

The following table presents the 12 **Slim Fry** auto programmes for frying. It contains its quantities and appropriate instructions. You will use less oil compared to frying with oil fryer, while you will get tasty results. Programmes are running with a combination of convection, top heater and microwave energy.

1. Potatoes/Vegetables

Code/Food	Serving Size	Instructions
1-1 Frozen Oven Chips	300-350 g 450-500 g	Distribute frozen oven chips evenly on the crusty plate. Set plate on low rack. Turnover after beep sounds. Press start to continue. (The oven keeps operating if you do not turn over). Stand for 1-2 minutes.

Code/Food	Serving Size	Instructions
1-2 Frozen Potato Croquettes	200-250 g 300-350 g	Distribute frozen potato croquettes evenly on the crusty plate. Set plate on low rack. Stand for 1-2 minutes.
1-3 Homemade French Fries	300-350 g 450-500 g	Use hard to medium type of potatoes and wash them. Peel potatoes and cut into sticks with a thickness of 10 x 10 mm. Soak in cold water (for 30 min.). Dry them with a towel, weigh them and brush with 5 g olive oil. Distribute homemade fries evenly on the crusty plate. Set plate on low rack. Turnover after beep sounds. Press start to continue. (The oven keeps operating if you do not turn over). Stand for 1-2 minutes.
1-4 Potato Wedges	200-250 g 300-350 g 400-450 g	Wash normal sized potatoes and cut them into wedges. Brush with olive oil and spices. Put them with the cut side on the crusty plate. Set plate on high rack. Stand for 1-3 minutes.
1-5 Frozen Onion Rings	100-150 g 200-250 g	Put frozen breaded onion rings or frozen breaded squid rings evenly on the crusty plate. Set plate on low rack. Stand for 1-2 minutes.
1-6 Sliced Courgettes	100-150 g 200-250 g	Rinse and slice courgettes. Brush with 5 g olive oil and add spices. Put slices evenly on the crusty plate and set plate on high rack. Turnover after beep sounds. Press start to continue. (The oven keeps operating if you do not turn over). Stand for 1-2 minutes.



Oven use

2. Seafood

Code/Food	Serving Size	Instructions
2-1 Frozen Prawns	200-250 g 300-350 g	Distribute frozen breaded prawns evenly on the crusty plate. Set plate on low rack. Stand for 1-2 minutes.
2-2 Fish Cutlets	200-250 g 300-350 g	Distribute breaded fish cutlets evenly on the crusty plate. Set plate on low rack. Stand for 1-2 minutes.
2-3 Frozen Fried Squids	100-150 g 200-250 g	Distribute breaded squid rings evenly on the crusty plate. Set plate on low rack. Stand for 1-2 minutes.

3. Chicken

Code/Food	Serving Size	Instructions
3-1 Frozen Chicken Nuggets	200-250 g 300-350 g	Distribute frozen chicken nuggets evenly on the crusty plate. Set plate on low rack. Turnover after beep sounds. Press start to continue. (The oven keeps operating if you do not turn over). Stand for 1-2 minutes.
3-2 Chicken Drumsticks	200-250 g 300-350 g 400-450 g	Weigh drumsticks and brush with oil and spices. Place them evenly on high rack. Turnover after beep sounds, oven will stop process. Press start to continue. Stand for 1-3 minutes.
3-3 Chicken Wings	200-250 g 300-350 g	Weigh chicken wings and brush with oil and spices. Place them evenly on high rack. Turnover after beep sounds, oven will stop process. Press start to continue. Stand for 1-2 minutes.

Using the sensor cook features

The 8 **Sensor Cook** features include/provide pre-programmed cooking times. You do not need to set either the cooking times or the power level. You can adjust the Sensor Cook category by turning the **Multi Function Selector Dial**.

First, place the food in the centre of the turntable and close the door.



1. Press the **Sensor** button.

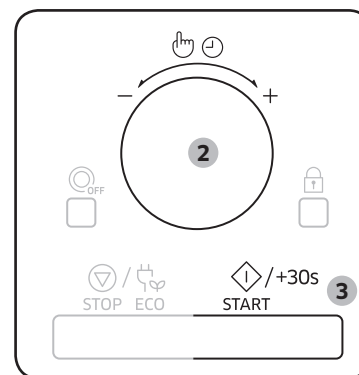

2. Select the type of food that you are cooking by turning the **Multi Function Selector Dial**. Refer to the table on the following page for a description of the various pre-programmed settings.
3. Press the **START/+30s** button.

Result: Cooking starts. When it has finished.

1. The oven beeps 4 times.
2. The end reminder signal will beep 3 times (once every minute).
3. The current time is displayed again.

NOTE

Use only recipients that are microwave-safe.



Sensor cook guide

The following table presents 8 Sensor Cook programmes. It contains its recommended weight range per item after cooking and appropriate instructions. In the beginning of the programme the display shows the sensor period. After this period the cooking time and power level is calculated automatically and the remaining cooking time will be displayed. The cooking process is controlled by the sensor system for your convenience.

⚠ CAUTION

Use oven gloves while taking out!

Code/Food	Serving Size	Instructions
1 Drinks	150-250 g	Pour the liquid (room-temperature) into ceramic cup or mug. Reheat uncovered. Place in the centre of turntable. Leave them to stand in the oven. Stir drinks before and after standing time. Be careful while taking the cup out (see safety instructions for liquids). Stand for 1-2 minutes.
2 Broccoli Florets	200-500 g	Rinse and clean fresh vegetables, such as broccoli and prepare florets. Put them evenly into a glass bowl with lid. Add 30-45 ml water (2-3 tbsp). Put bowl in the centre of turntable. Cook covered. Stir after cooking. This programme is suitable for broccoli as well as sliced courgette, egg plant, pumpkin or pepper. Stand for 1-2 minutes.

Code/Food	Serving Size	Instructions
3 Sliced Carrots	200-500 g	Rinse and clean fresh vegetables, such as carrots and cut into round slices evenly. Put them into a glass bowl with lid. Add 30-45 ml water (2-3 tbsp). Put bowl in the centre of turntable. Cook covered. Stir after cooking. This programme is suitable for sliced carrots as well as cauliflower florets or turnip cabbage. Stand for 1-2 minutes.
4 Cauliflower Florets	200-500 g	Rinse and clean fresh vegetables, such as cauliflower florets and prepare florets. Put them evenly into a glass bowl with lid. Add 30-45 ml water (2-3 tbsp). Put bowl in the centre of turntable. Cook covered. Stir after cooking. This programme is suitable for broccoli as well as sliced courgette, egg plant, pumpkin or pepper. Stand for 1-2 minutes.
5 Jacket Potatoes	200-800 g	Rinse and clean potatoes, each 200 g. Brush with olive oil and pierce skin with a knife. Put in a circle on the turntable. Stand for 2-3 minutes.
6 Boiling Pasta	100-300 g	Use a large glass ovenware dish with lid. Add hot boiling water of 4 times, a pinch of salt and stir well. Cook uncovered. Stir before standing time and drain thoroughly afterwards. Stand for 1-3 minutes.
7 Mini Ravioli	200-400 g	Put mini ravioli in a deep ceramic plate. Put plate in the centre of turntable. Cover with plastic lid. Stand for 2-3 minutes.

Oven use

Code/Food	Serving Size	Instructions
8 Chicken Pieces	400-700 g	Brush chilled chicken pieces with oil and spices. Put skin-side down on the low rack. Turnover, as soon as the oven beeps. Push start button to continue process. Stand for 2-3 minutes.

Auto sensor cooking instructions

The Auto Sensor allows you to cook your food automatically by detecting the amount of gases generated from the food while cooking.

- When cooking food, many kinds of gases are generated. The Auto Sensor determines the proper time and power level by detecting these gases from the food, eliminating the need to set the cooking time and power level.
- When you cover a container with its lid or plastic wrap during Sensor Cooking, the Auto Sensor will detect the gases generated after the container has been saturated with steam.
- Shortly before cooking ends, the remaining cooking time will begin its count down. This will be a good time for you to rotate or stir the food for even cooking if it is necessary.
- Before auto sensor cooking food may be seasoned with herbs, spices or browning sauces. A word of caution though, salt or sugar may cause burn spots on food so these ingredients should be added after cooking.

Utensils & Cover for sensor cooking

- To obtain good cooking results with this function, follow the directions for selecting appropriate containers and covers in the charts in this book.
- Always use microwave-safe containers and cover them with their lids or with plastic wrap. When using plastic wrap, turn back one corner to allow steam to escape at the proper rate.
- Always cover with the lid intended for the utensil being used. If the utensil does not have its own lid, use plastic wrap.
- Fill containers at least half full.

- Foods that require stirring or rotating should be stirred or turned toward the end of the Sensor Cook cycle, after the time has started to count down on the display.

Important

- After installing the oven and plugging into an electrical outlet, do not unplug the power cord. The gas sensor needs time to stabilize in order to cook satisfactorily.
- It is not advisable to use the auto sensor cooking feature on a continuous cooking operation, i.e. one cooking operation immediately after another.
- Install the oven in a well ventilated location for proper cooling and airflow and to ensure the sensor will operate accurately.
- To avoid poor results, do not use the Auto sensor when the room ambient temperature is too high or too low.
- Do not use volatile detergent to clean your oven. Gas resulting from this detergent may affect the sensor.
- Avoid placing the oven near high moisture or gas emitting appliances, since this will interfere with the proper performance of the Auto Sensor.
- Always keep the inside of the oven clean. Wipe all spills with a damp cloth. This oven is designed for household use only.

Using the healthy cooking features

The 15 **Healthy Cooking** features provide pre-programmed cooking times. You do not need to set either the cooking times or the power level. You can adjust the size of the serving by turning the **Multi Function Selector Dial**.

⚠ CAUTION

Use only recipients that are microwave-safe. Open the door. Place the food in the centre of the turntable. Close the door.



- Press the **Healthy Cooking** button.
- Select the category of food by turning the **Multi Function Selector Dial** and press the **Multi Function Selector Dial**.
 - Grain/Pasta
 - Vegetables
 - Poultry/Fish
- Select the type of food that you are cooking by turning the **Multi Function Selector Dial**. Refer to the table on the following page for a description of the various pre-programmed settings. At that time, press the **Multi Function Selector Dial** to select the type of food.
- Select the size of the serving by turning the **Multi Function Selector Dial**.
- Press the **START/+30s** button.

Result: The food is cooked according to the pre-programmed setting selected. When it has finished.

- The oven beeps 4 times.
- The end reminder signal will beep 3 times (once every minute).
- The current time is displayed again.

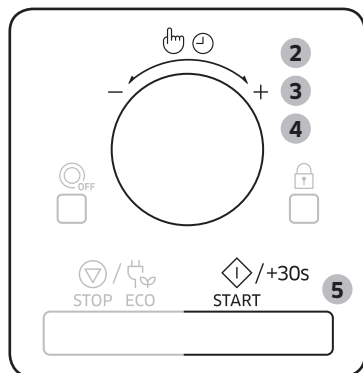

Healthy cooking guide

The following table presents quantities and appropriate instructions about 15 **Healthy Cooking** programmes. This is composed of Grain/Pasta(1), Vegetables(2) and Poultry/Fish(3).

⚠ CAUTION

Use oven gloves when taking out food.

1. Grain/Pasta

Code/Food	Serving Size	Instructions
1-1 Brown Rice	150-200 g 200-250 g	Use a large glass ovenware dish with lid. Add cold water of double quantity. Cook covered. Stir before standing time and add salt and herbs. Stand for 5-10 minutes.
1-2 Quinoa	150-200 g 200-250 g	Use a large glass ovenware dish with lid. Add cold water of double quantity. Cook covered. Stir before standing time and add salt and herbs. Stand for 1-3 minutes.
1-3 Macaroni	100-150 g 200-250 g	Use a large glass ovenware dish with lid. Add hot boiling water of 4 times, a pinch of salt and stir well. Cook uncovered. Stir before standing time and drain thoroughly afterwards. Stand for 1-3 minutes.

2. Vegetables

Code/Food	Serving Size	Instructions
2-1 Green Beans	200-250 g 300-350 g	Rinse and clean green beans. Put them evenly into a glass bowl with lid. Add 30 ml (2 tbsp) water when cooking for 200-250 g and add 45 ml (3 tbsp) for 300-350 g. Put bowl in the centre of turntable. Cook covered. Stir after cooking. Stand for 1-2 minutes.

Oven use

Code/Food	Serving Size	Instructions
2-2 Spinach	100-150 g 200-250 g	Rinse and clean spinach. Put into a glass bowl with lid. Do not add water. Put bowl in the centre of turntable. Cook covered. Stir after cooking. Stand for 1-2 minutes.
2-3 Peeled Potatoes	300-350 g 400-450 g 500-550 g	Wash and peel potatoes, cut into halves and put into a glass bowl with lid. Add 15-30 ml of water (1-2 tbsp). Stir after cooking. When cooking higher quantities stir once during cooking. Stand for 3-5 minutes.
2-4 Potatoes Gratin	400-450 g 800-850 g	Put the fresh potato gratin into a glass pyrex dish. Put the dish on the low rack. Stand for 2-3 minutes.
2-5 Grilled Eggplants	100-150 g 200-250 g	Rinse and slice eggplants. Brush with oil and spices. Put slices evenly on the high rack. Turnover after beep sounds. Press start to continue (The oven keeps operating if you do not turnover). Stand for 1-2 minutes.
2-6 Grilled Tomatoes	400-450 g 600-650 g	Rinse and clean tomatoes. Cut them into halves and put in an ovenware dish. Add grated cheese on top. Put dish on the high rack. Stand for 1-2 minutes.

3. Poultry/Fish

Code/Food	Serving Size	Instructions
3-1 Chicken Breasts	300-350 g 400-450 g	Rinse chicken breast and put on a ceramic plate. Cover with microwave cling film and pierce film. Put dish on the turntable. Stand for 2 minutes.
3-2 Turkey Breasts	300-350 g 400-450 g	Rinse turkey breast and put on deep glass ovenware dish. Cover with microwave cling film and pierce film. Put dish on the turntable. Stand for 2 minutes.

Code/Food	Serving Size	Instructions
3-3 Grilled Chicken Breasts	300-350 g 400-450 g	Rinse chicken breast, marinate and put them on the high rack. Turnover as soon as the beep sounds. Stand for 2 minutes.
3-4 Grilled Fish Fillets	200-300 g 400-500 g	Put fish fillets evenly on the high rack. Turnover as soon as the beep sounds. Stand for 1-2 minutes.
3-5 Grilled Salmon Steaks	200-250 g 300-350 g	Put fish steaks evenly on the high rack. Turnover as soon as the beep sounds. Stand for 2 minutes.
3-6 Roast Fish	300-350 g 400-500 g	Brush skin of whole fish (trout or gilthead) with oil and add herbs and spices. Put fish side by side, head to tail on the high rack. Turnover as soon as the beep sounds. Stand for 3 minutes.

Using the dough proof/yogurt features

The 5 **Dough Proof/Yogurt features** include/provide pre-programmed cooking times. You do not need to set either the cooking times or the power level. You can adjust the dough proof/yogurt category by turning the **Multi Function Selector Dial** after press the **Dough Proof/Yogurt** button.

First, place the food in the centre of the turntable and close the door.



1. Press the **Dough Proof/Yogurt** button.
2. Select the Dough Proof or Yogurt and press the **Multi Function Selector Dial**.

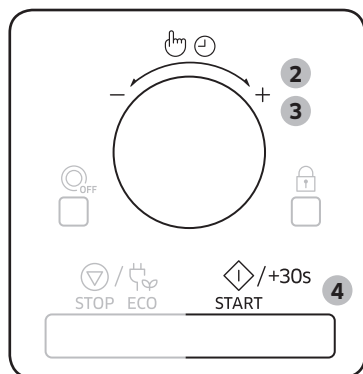

1. Dough proof
2. Yogurt
3. Select the type of food that you are cooking by turning the **Multi Function Selector Dial**. You have to choose the number that you want to use for cooking by turning the **Multi Function Selector Dial**. Refer to the table on the following page for a description of the various pre-programmed settings. At that time, press the **Multi Function Selector Dial** to select the type of food.
4. Press the **START/+30s** button.

⚠ CAUTION

Turntable is not operating during yogurt cooking.

Dough proof/yogurt guide

The following table presents how to use the auto programmes for rising yeast dough or homemade yogurt.

1. Dough Proof

Code/Food	Serving Size	Instructions
1-1 Pizza Dough	300-500 g	Put dough in suitable sized bowl and set on the low rack. Cover with aluminium foil.
1-2 Cake Dough	500-800 g	Put dough in suitable sized bowl and set on the low rack. Cover with aluminium foil.
1-3 Bread Dough	600-900 g	Put dough in suitable sized bowl and set on the low rack. Cover with aluminium foil.

2. Homemade Yogurt

Code/Food	Serving Size	Instructions
2-1 Small Cups	500 g	Distribute 150 g natural yogurt into 5 ceramic cups or small glass jars evenly (30 g each). Add 100 ml milk into each cup. Use long-life milk (room-temperature; 3, 5 % fat). Cover each with cling film and set in a circle on turntable. After finish, keep 6 hours in a refrigerator. For the first time we recommend to use dried yoghurt bacteria ferment.
2-2 Large Bowl	500 g	Mix 150 g natural yogurt with 500 ml long-life milk (room-temperature; 3, 5 % fat). Pour evenly into large glass bowl. Cover with cling film and set on turntable. After finish, keep 6 hours in a refrigerator. For the first time we recommend to use dried yoghurt bacteria ferment.

Oven use

Using the power defrost features

The **Power Defrost** features enable you to defrost meat, poultry, fish, bread, cake and fruit. The defrost time and power level are set automatically. You simply select the programme and the weight.

NOTE

Use only containers that are microwave-safe.

Open the door. Place the frozen food on a ceramic in the centre of the turntable. Close the door.



1. Press the **Power Defrost** button.
2. Select the type of food that you are cooking by turning the **Multi Function Selector Dial**. Refer to the table on the following page for a description of the various pre-programmed settings. At that time, press the **Multi Function Selector Dial** to select the type of food.
3. Select the size of the serving by turning the **Multi Function Selector Dial**.
4. Press the **START/+30s** button.

Result:

- Defrosting begins.
- The oven beeps through defrosting to remind you to turn the food over.

5. Press the **START/+30s** button again to finish defrosting.

Result: When it has finished.

1. The oven beeps 4 times.
2. The end reminder signal will beep 3 times (once every minute).
3. The current time is displayed again.

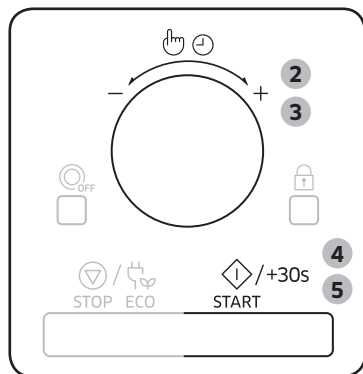

Power defrost guide

The following table presents the various **Power Defrost** programmes, quantities and appropriate instructions. Remove all kind of package material before defrosting.

Place meat, poultry and fish on a flat glass plate or on a ceramic plate, arrange bread, cake and fruit on kitchen paper.

Code/Food	Serving Size	Instructions
1 Meat	200-1500 g	Shield the edges with aluminium foil. Turn the meat over, when the oven beeps. This programme is suitable for beef, lamb, pork, steaks, chops, minced meat. Stand for 20-90 minutes.
2 Poultry	200-1500 g	Shield the leg and wing tips with aluminium foil. Turn the poultry over, when the oven beeps. This programme is suitable for whole chicken as well as for chicken portions. Stand for 20-90 minutes.
3 Fish	200-1500 g	Shield the tail of a whole fish with aluminium foil. Turn the fish over, when the oven beeps. This programme is suitable for whole fishes as well as for fish fillets. Stand for 20-80 minutes.

Code/Food	Serving Size	Instructions
4 Bread/Cake	125-1000 g	<p>Put bread horizontally on a piece of kitchen paper and turn over, as soon as the oven beeps. Place cake on a ceramic plate and if possible, turn over, as soon as the oven beeps. (Oven keeps operating and is stopped, when you open the door.)</p> <p>This programme is suitable for all kinds of bread, sliced or whole, as well as for bread rolls and baguettes.</p> <p>Arrange bread rolls in a circle.</p> <p>This programme is suitable for all kinds of yeast cake, biscuit, cheese cake and puff pastry. It is not suitable for short/crust pastry, fruit and cream cakes as well as for cake with chocolate topping. Stand for 10-60 minutes.</p>
5 Fruit	100-600 g	<p>Spread fruits evenly into a flat glass dish.</p> <p>This programme is suitable for all kind of fruits. Stand for 5-20 minutes.</p>

Using the auto reheat/cook features

The 6 **Auto Reheat/Cook** features include/provide pre-programmed cooking times. You do not need to set either the cooking times or the power level. You can adjust the size of the serving by turning the **Multi Function Selector Dial**.

⚠ CAUTION

Use only recipients that are microwave-safe. Open the door. Place the food in the centre of the turntable. Close the door.



1. Press the **Auto Reheat/Cook** button.

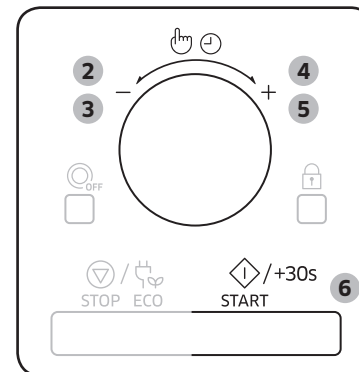

2. Turn the **Multi Function Selector Dial** to select Cook category. (Auto Reheat or Auto Cook)
3. Select the Auto Reheat by pressing the **Multi Function Selector Dial**.
4. Select the type of food that you are cooking by turning the **Multi Function Selector Dial**. Refer to the table on the following page for a description of the various pre-programmed settings. At that time, press the **Multi Function Selector Dial** to select the type of food.
5. Select the size of the serving by turning the **Multi Function Selector Dial**.
6. Press the **START/+30s** button.

Result: The food is cooked according to the pre-programmed setting selected. When it has finished.

 1. The oven beeps 4 times
 2. The end reminder signal will beep 3 times (once every minute).
 3. The current time is displayed again.

Auto reheat/cook guide

The following table presents quantities and appropriate instructions for auto reheat and cook.

⚠ CAUTION

Use oven gloves when taking out food.

Oven use

1. Auto Reheat

Code/Food	Serving Size	Instructions
1-1 Ready Meal (Chilled)	300-350 g 400-450 g	Put on a ceramic plate and cover with microwave cling film. This programme is suitable for meals consisting of 3 components (e.g. meat with sauce, vegetables and a side dish like potatoes, rice or pasta). Stand for 2-3 minutes.
1-2 Frozen Pizza	300-350 g 400-450 g	Put frozen pizza on the low rack.
1-3 Frozen Lasagne	400-450 g 600-650 g	Put frozen lasagne into a suitable sized ovenproof dish. Put dish on low rack. Stand for 3-4 minutes.
1-4 Quiche (Chilled)	600-650 g	This program is suitable for refrigerated quiche. Remove a package and put on the dish. Place on turntable in oven. After cooking, stand for 1-2 minutes.

2. Auto Cook

Code/Food	Serving Size	Instructions
2-1 Roast Chicken	1100-1150 g 1200-1250 g	Brush chilled chicken with oil and spices. Put breast-side-down, in the middle of the low rack. Turnover, as soon as the oven beeps. Push start button to continue process. Stand for 5 minutes.
2-2 Muffins	250-300 g	Pour dough into 6-8 paper or silicone cups for muffins (each 45 g) and set on low rack. Start programme (oven is preheating). After beep sounds insert rack with food.

Using the crusty plate

This crusty plate allows you to brown food not only on the top with the grill, but also the bottom of the food turns crispy and brown due to the high temperature of the crusty plate. Several items which you can prepare on the crusty plate can be found in the chart (see next page). The crusty plate can also be used for bacon, eggs, sausages, etc.

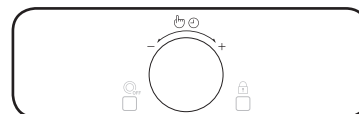
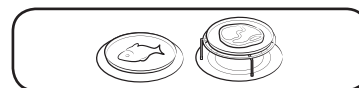
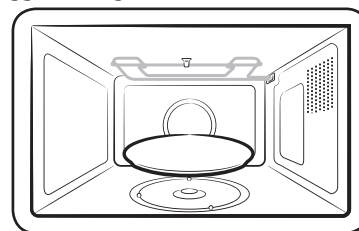

1. Place the crusty plate directly on the turntable and preheat it with highest Microwave-Grill-Combination [600 W + Grill] by following the times and instructions in the chart.
2. Brush the plate with oil if you are cooking food, such as bacon and eggs, in order to brown the food nicely.
3. Place the food on the crusty plate.
4. Place the crusty plate on the metal rack (or turntable) in the microwave.
5. Select the appropriate cooking time and power. (Refer to the table on the side)

⚠ CAUTION

- Always use oven gloves to take out the crusty plate, as will become very hot.
- Do not place any objects on the crusty plate that are not heat-resistant.
- Never place the crusty plate in the oven without turntable.
- Please note that the crust plate is not dishwasher-safe.

📖 NOTE

- Please note that the crusty plate has a teflon layer which is not scratch-resistant. Do not use any sharp objects like a knife to cut on the crusty plate.
- Clean the crusty plate with warm water and detergent and rinse off with clean water.
- Do not use a scrubbing brush or a hard sponge otherwise the top layer will be damaged.

Convection

The convection mode enables you to cook food in the same way as in a traditional oven. The microwave mode is not used. You can set the temperature, as required, in a range varying from 40 °C to 200 °C. The maximum cooking time is 60 minutes.

- Always use oven gloves when touching the recipients in the oven, as they will be very hot.
- You can get better cooking and browning, if you use the low rack.

Check that the heating element is in the horizontal position. Open the door and place the recipient on the low rack and set on turntable.

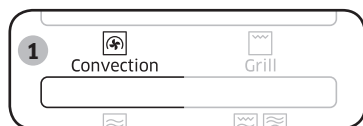

1. Press the **Convection** button.
Result: The following indications are displayed:
 (convection mode)
180 °C (temperature)

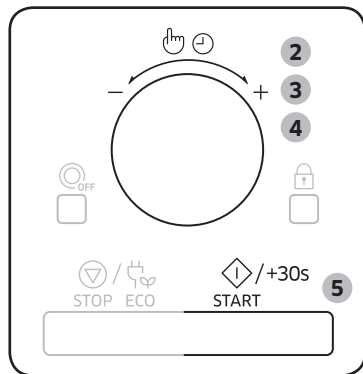

2. Set the temperature by turning the **Multi Function Selector Dial**. (Temperature : 40~200 °C, 10 °C interval)
 - If don't set the temperature within 5 seconds, Automatically changes to the cooking time setting stage.
3. Press the **Multi Function Selector Dial**.
4. Set the cooking time by turning the **Multi Function Selector Dial**. (If you want to preheat the oven, select “ : 0”)
5. Press the **START/+30s** button.
Result: Cooking starts. When it has finished.
 1. The oven beeps 4 times.
 2. The end reminder signal will beep 3 times (once every minute).
 3. The current time is displayed again.

Grilling

The grill enables you to heat and brown food quickly, without using microwaves.

- Always use oven gloves when touching the recipients in the oven, as they will be very hot.
- You can get better cooking and grilling results, if you use the high rack.

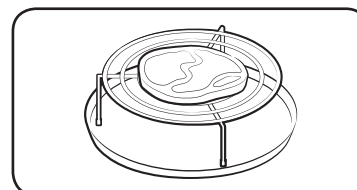

1. Open the door and place the food on the rack.



2. Press the **Grill** button.
Result: The following indications are displayed:
 (grill mode)
 - You cannot set the temperature of the grill.

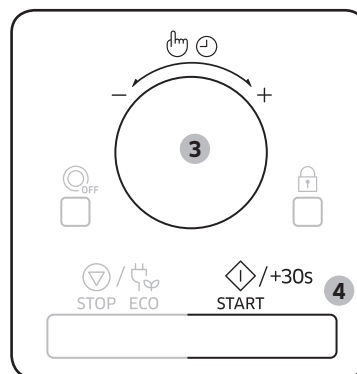

3. Set the grilling time by turning the **Multi Function Selector Dial**.
 - The maximum grilling time is 60 minutes.
4. Press the **START/+30s** button.
Result: Grilling starts. When it has finished.
 1. The oven beeps 4 times.
 2. The end reminder signal will beep 3 times (once every minute).
 3. The current time is displayed again.

Oven use

Choosing the accessories

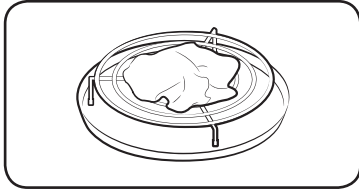

Traditional convection cooking does require cookware. You should, however, use only cookware that you would use in your normal oven.

Microwave-safe containers are not usually suitable for convection cooking; don't use plastic containers, dishes, paper cups, towels, etc.

If you wish to select a combined cooking mode (microwave and grill or convection), use only recipients that are microwave-safe and oven-proof.

⚠ CAUTION

For further details on suitable cookware and utensils, refer to the Cookware Guide on page 29.

Combining microwaves and grill

You can also combine microwave cooking with the grill, to cook quickly and brown at the same time.

⚠ CAUTION

ALWAYS use microwave-safe and oven-proof cookware. Glass or ceramic dishes are ideal as they allow the microwaves to penetrate the food evenly.

⚠ CAUTION

ALWAYS use oven gloves when touching the recipients in the oven, as they will be very hot. You can improve cooking and grilling, if you use the high rack.

Open the door. Place the food in the centre of the turntable. Close the door.

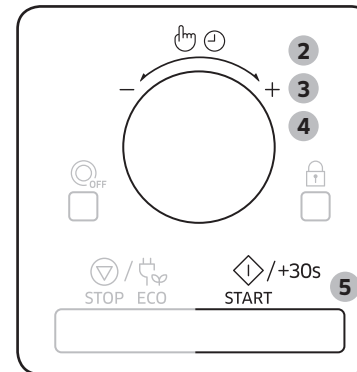

- Press the **Combi** button.
Result: The following indications are displayed:
- Make the display indicating Cb-1, and then press the **Multi Function Selector Dial**.
Result: The following indications are displayed:
 (microwave & grill combi mode)
600 W (output power)
- Select the appropriate power level by turning the **Multi Function Selector Dial** until the corresponding output power is displayed (600, 450, 300 W). At that time, press the **Multi Function Selector Dial** to set the power level.
 - You cannot set the temperature of the grill.
 - If don't set the temperature within 5 seconds, Automatically changes to the cooking time setting stage.
- Set the cooking time by turning the **Multi Function Selector Dial**.
 - The maximum cooking time is 60 minutes.
- Press the **START/+30s** button.
Result: Combination cooking starts. When it has finished.
 - The oven beeps 4 times.
 - The end reminder signal will beep 3 times (once every minute).
 - The current time is displayed again.

Combining microwaves and convection

Combination cooking uses both microwave energy and convection heating. No preheating is required as the microwave energy is immediately available. Many foods can be cooked in combination mode, particularly:

- Roast meats and poultry
- Pies and cakes
- Egg and cheese dishes

⚠ CAUTION

ALWAYS use microwave-safe and oven-proof cookware. Glass or ceramic dishes are ideal as they allow the microwaves to penetrate the food evenly.

⚠ CAUTION

ALWAYS use oven gloves when touching the recipients in the oven, as they will be very hot. You can get better cooking and browning, if you use the low rack.

Open the door. Place the food on the turntable or on the low rack which should then be placed on the turntable. Close the door. The heating element must be in the horizontal position.

1. Press the **Combi** button.

Result: The following indications are displayed:
Cb-1 (Microwave + Grill)

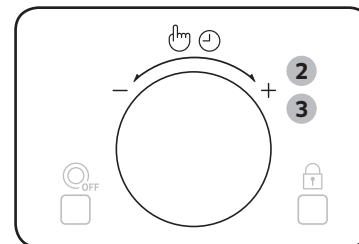

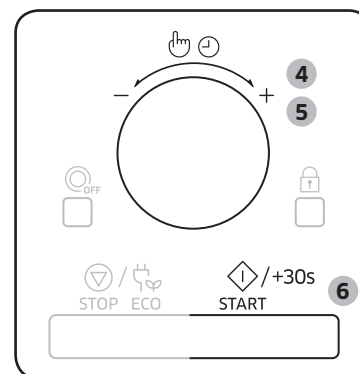

2. Make the display indicating Cb-2 (Microwave + Convection) by turning the **Multi Function Selector Dial**, and then press the **Multi Function Selector Dial**.
3. Select the appropriate power level by turning the **Multi Function Selector Dial** until the corresponding output power is displayed (600, 450, 300, 180, 100 W). At that time, press the **Multi Function Selector Dial** to set the power level.
 - If don't set the power level within 5 seconds, Automatically changes to the cooking time setting stage. (Default : 180 °C)



4. Select the appropriate temperature by turning the **Multi Function Selector Dial** (Temperature : 200~40 °C). At that time, press the **Multi Function Selector Dial** to set the power level.
 - If don't set the temperature within 5 seconds, Automatically changes to the cooking time setting stage.

Result: The following indications are displayed:

  (microwave & convection combi mode)
600 W (output power)
180 °C (temperature)

5. Set the cooking time by turning the **Multi Function Selector Dial**.
 - The maximum cooking time is 60 minutes.

Oven use

6. Press the **START/+30s** button.
Result: Combination cooking starts. The oven is heated to the required temperature and then microwave cooking continues until the cooking time is over. When it has finished.
 1. The oven beeps 4 times.
 2. The end reminder signal will beep 3 times (once every minute).
 3. The current time is displayed again.

Switching the beeper off

You can switch the beeper off whenever you want.

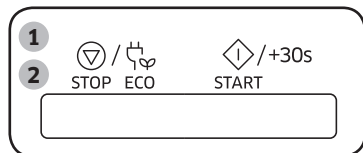

1. Press the **START/+30s** and **STOP/ECO** button at the same time.
Result: The oven does not beep to indicate the end of a function.
2. To switch the beeper back on, press the **START/+30s** and **STOP/ECO** button again at the same time.
Result: The oven operates normally.

Using the child lock features

Your microwave oven is fitted with a special child lock programme, which enables the oven to be “locked” so that children or anyone unfamiliar with it cannot operate it accidentally.

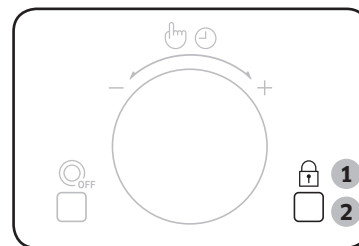

1. Press the **Child Lock** button for 3 second.
Result:
 - The oven is locked (no functions can be selected).
 - The display shows “L”.
2. To unlock the oven, press the **Child Lock** button for 3 second.
Result: The oven can be used normally.

Cookware guide

The following table lists various types of cookware and indicates whether and how they should be used in a microwave oven. If the cookware is marked microwave-safe, you do not need to worry.

Cookware	Microwave-safe	Comments
Glassware		
<ul style="list-style-type: none"> Oven-to tableware 	✓	Can be used without metal trim.
<ul style="list-style-type: none"> Fine glassware 	✓	Can be used to warm foods or liquids. Delicate glass may break or crack if heater suddenly.
<ul style="list-style-type: none"> Glass jars 	✓	Can be used only warm (must remove the lid).
Plastic		
<ul style="list-style-type: none"> Containers 	✓	Can be used heat-resistant thermoplastic.
<ul style="list-style-type: none"> polystyrene cups containers 	✓	Can be used to warm foods.
<ul style="list-style-type: none"> Disposable polyester cardboard dishes 	✓	Can be used to warm foods/frozen foods.
<ul style="list-style-type: none"> Cling film 	✓	Can be used to retain moisture. Take care when removing the film as hot steam will escape.
<ul style="list-style-type: none"> Freezer bags 	✓X	Can be used only boilable or oven-proof.

Cookware	Microwave-safe	Comments
Paper/Metal trim		
<ul style="list-style-type: none"> Wax or grease-proof paper 	✓	Can be used to retain moisture and prevent spattering.
<ul style="list-style-type: none"> Plates, cups, napkins, kitchen paper 	✓X	Can be used to cook and warm short times with moist food.
<ul style="list-style-type: none"> Recycled paper 	X	May cause arcing or fire.
<ul style="list-style-type: none"> Paper bags or newspaper 	X	May cause fire.
Metal/Metal trim		
<ul style="list-style-type: none"> Dishes 	X	May cause arcing or fire.
<ul style="list-style-type: none"> Freezer bag twist ties 	X	
<ul style="list-style-type: none"> Aluminum foil 	X	
China and earthenware	✓	Can be used without metal trim.
Crusty Plate	✓	Do not preheat for more than 8 minutes.

✓ : Recommended ✓X : Use caution X : Unsafe

Cooking guide

Microwaves

Microwave energy actually penetrates food, attracted and absorbed by its water, fat and sugar content.

The microwaves cause the molecules in the food to move rapidly. The rapid movement of these molecules creates friction and the resulting heat cooks the food.

Cooking

Cookware for microwave cooking:

Cookware must allow microwave energy to pass through it for maximum efficiency. Microwaves are reflected by metal, such as stainless steel, aluminium and copper, but they can penetrate through ceramic, glass, porcelain and plastic as well as paper and wood. So food must never be cooked in metal containers.

Food suitable for microwave cooking:

Many kinds of food are suitable for microwave cooking, including fresh or frozen vegetables, fruit, pasta, rice, grains, beans, fish, and meat. Sauces, custard, soups, steamed puddings, preserves, and chutneys can also be cooked in a microwave oven. Generally speaking, microwave cooking is ideal for any food that would normally be prepared on a hob. Melting butter or chocolate, for example (see the chapter with tips, techniques and hints).

Covering during cooking

To cover the food during cooking is very important, as the evaporated water rises as steam and contributes to cooking process. Food can be covered in different ways: e.g. with a ceramic plate, plastic cover or microwave suitable cling film.

Standing times

After cooking is over food the standing time is important to allow the temperature to even out within the food.

Cooking Guide for frozen vegetables

Use a suitable glass pyrex bowl with lid. Cook covered for the minimum time – see table. Continue cooking to get the result you prefer.

Stir twice during cooking and once after cooking. Add salt, herbs or butter after cooking. Cover during standing time.

Food	Serving Size	Power	Time (min.)
Spinach	150 g	600 W	5-6
	Instructions Add 15 ml (1 tbsp) cold water. Serve after 2-3 minutes standing.		
Broccoli	300 g	600 W	8-9
	Instructions Add 30 ml (2 tbsp) cold water. Serve after 2-3 minutes standing.		
Peas	300 g	600 W	7-8
	Instructions Add 15 ml (1 tbsp) cold water. Serve after 2-3 minutes standing.		
Green Beans	300 g	600 W	7½-8½
	Instructions Add 30 ml (2 tbsp) cold water. Serve after 2-3 minutes standing.		
Mixed Vegetables (Carrots/Peas/Corn)	300 g	600 W	7-8
	Instructions Add 15 ml (1 tbsp) cold water. Serve after 2-3 minutes standing.		
Mixed Vegetables (Chinese style)	300 g	600 W	7½-8½
	Instructions Add 15 ml (1 tbsp) cold water. Serve after 2-3 minutes standing.		

Cooking guide for fresh vegetables

Use a suitable glass pyrex bowl with lid. Add 30-45 ml cold water (2-3 tbsp) for every 250 g unless another water quantity is recommended - see table. Cook covered for the minimum time - see table. Continue cooking to get the result you prefer. Stir once during and once after cooking. Add salt, herbs or butter after cooking. Cover during a standing time of 3 minutes.

Hint: Cut the fresh vegetables into even sized pieces. The smaller they are cut, the quicker they will cook.

Food	Serving Size	Power	Time (min.)
Broccoli	250 g	900 W	4½-5
	500 g		7-8
Brussels Sprouts	250 g	900 W	6-6½
	Instructions Add 60-75 ml (5-6 tbsp) water. Serve after 3 minutes standing.		
Carrots	250 g	900 W	5-5½
	Instructions Cut carrots into even sized slices. Serve after 3 minutes standing.		
Cauliflower	250 g	900 W	5-5½
	500 g		7½-8½
Courgettes	250 g	900 W	4-4½
	Instructions Cut courgettes into slices. Add 30 ml (2 tbsp) water or a knob of butter. Cook until just tender. Serve after 3 minutes standing.		
Egg plants	250 g	900 W	3½-4
	Instructions Cut egg plants into small slices and sprinkle with 1 tbsp lemon juice. Serve after 3 minutes standing.		

Food	Serving Size	Power	Time (min.)
Leeks	250 g	900 W	4-4½
	Instructions Cut leeks into thick slices. Serve after 3 minutes standing.		
Mushrooms	125 g	900 W	1½-2
	250 g		2½-3
Onions	250 g	900 W	5-5½
	Instructions Cut onions into slices or halves. Add only 15 ml (1 tbsp) water. Serve after 3 minutes standing.		
Pepper	250 g	900 W	4½-5
	Instructions Cut pepper into small slices. Serve after 3 minutes standing.		
Potatoes	250 g	900 W	4-5
	500 g		7-8
Turnip Cabbage	250 g	900 W	5½-6
	Instructions Cut turnip cabbage into small cubes. Serve after 3 minutes standing.		

Cooking guide

Cooking guide for rice and pasta

Rice: Use a large glass pyrex bowl with lid - rice doubles in volume during cooking. Cook covered. After the cooking time is over, stir before standing time and salt or add herbs and butter. Remark: the rice may not have absorbed all water after the cooking time is finished.

Pasta: Use a large glass pyrex bowl. Add boiling water, a pinch of salt and stir well. Cook uncovered. Stir occasionally during and after cooking. Cover during standing time and drain thoroughly afterwards.

Food	Serving Size	Power	Time (min.)
White Rice (Parboiled)	250 g	900 W	15-16
	375 g		17½-18½
Instructions Add cold water of double quantity. Serve after 5 minutes standing.			
Brown Rice (Parboiled)	250 g	900 W	20-21
	375 g		22-23
Instructions Add cold water of double quantity. Serve after 5 minutes standing.			
Mixed Rice (Rice + Wild Rice)	250 g	900 W	16-17
Instructions Add 500 ml cold water. Serve after 5 minutes standing.			
Mixed Corn (Rice + Grain)	250 g	900 W	17-18
	Instructions Add 400 ml cold water. Serve after 5 minutes standing.		
Pasta	250 g	900 W	10-11
	Instructions Add 1000 ml hot water. Serve after 5 minutes standing.		
Instant Noodle	1 Small pack (80 g)	900 W	7-7½
	1 Big pack (120 g)		9-9½
Instructions Use a glass pyrex bowl. Put the noodle and add room temperature 350 ml water in bowl. Cook covered with wrap and pierce at several times. After cooking, drain water and mix instant noodle spices.			

Reheating

Your microwave oven will reheat food in a fraction of the time that conventional ovens hobs normally take.

Use the power levels and reheating times in the following chart as a guide. The times in the chart consider liquids with a room temperature of about +18 to +20 °C or a chilled food with a temperature of about +5 to +7 °C.

Arranging and covering

Avoid reheating large items such as joint of meat - they tend to overcook and dry out before the centre is piping hot. Reheating small pieces will be more successful.

Power levels and stirring

Some foods can be reheated using 900 W power while others should be reheated using 600 W, 450 W or even 300 W.

Check the tables for guidance.

In general, it is better to reheat food using a lower power level, if the food is delicate, in large quantities, or if it is likely to heat up very quickly (mince pies, for example).

Stir well or turn food over during reheating for best results. When possible, stir again before serving.

Take particular care when heating liquids and baby foods. To prevent eruptive boiling of liquids and possible scalding, stir before, during and after heating. Keep them in the microwave oven during standing time. We recommend putting a plastic spoon or glass stick into the liquids. Avoid overheating (and therefore spoiling) the food. It is preferable to underestimate cooking time and add extra heating time, if necessary.

Heating and standing times

When reheating food for the first time, it is helpful to make a note of the time taken - for future reference.

Always make sure that the reheated food is piping hot throughout.

Allow food to stand for a short time after reheating - to let the temperature even out.

The recommended standing time after reheating is 2-4 minutes, unless another time is recommended in the chart.

Take particular care when heating liquids and baby food. See also the chapter with the safety precautions.

Reheating liquids

Always allow a standing time of at least 20 seconds after the oven has been switched off to allow the temperature to even out. Stir during heating, if necessary, and ALWAYS stir after heating. To prevent eruptive boiling and possible scalding, you should put a spoon or glass stick into the beverages and stir before, during and after heating.

Reheating baby food

Baby food:

Empty into a deep ceramic plate. Cover with plastic lid. Stir well after reheating! Let stand for 2-3 minutes before serving. Stir again and check the temperature. Recommended serving temperature: between 30-40 °C.

Baby milk:

Pour milk into a sterilised glass bottle. Reheat uncovered. Never heat a baby's bottle with teat on, as the bottle may explode if overheated. Shake well before standing time and again before serving ! Always carefully check the temperature of baby milk or food before giving it to the baby. Recommended serving temperature: ca. 37 °C.

Remark:

Baby food particularly needs to be checked carefully before serving to prevent burns. Use the power levels and times in the next table as a guide lines for reheating.

Reheating liquids and food

Use the power levels and times in this table as a guide lines for reheating.

Food	Serving Size	Power	Time (min.)
Drinks (Coffee, Tea and Water)	150 ml (1 cup)	900 W	1-1½
	300 ml (2 cups)		2-2½
	450 ml (3 cups)		3-3½
	600 ml (4 cups)		3½-4
	Instructions Pour into cups and reheat uncovered: 1 cup in the centre, 2 cups opposite of each other, 3 cups in a circle. Keep in microwave oven during standing time and stir well. Serve after 1-2 minutes standing.		
Soup (Chilled)	250 g	900 W	2½-3
	350 g		3-3½
	450 g		3½-4
	550 g		4½-5
	Instructions Pour into a deep ceramic plate or deep ceramic bowl. Cover with plastic lid. Stir well after reheating. Stir again before serving. Serve after 2-3 minutes standing.		
Stew (Chilled)	350 g	600 W	4½-5½
	Instructions Put stew in a deep ceramic plate. Cover with plastic lid. Stir occasionally during reheating and again before standing and serving. Serve after 2-3 minutes standing.		

Cooking guide

Food	Serving Size	Power	Time (min.)
Pasta with Sauce (Chilled)	350 g	600 W	3½-4½
	Instructions Put pasta (e.g. spaghetti or egg noodles) on a flat ceramic plate. Cover with microwave cling film. Stir before serving. Serve after 3 minutes standing.		
Filled Pasta with Sauce (Chilled)	350 g	600 W	4-5
	Instructions Put filled pasta (e.g. ravioli, tortellini) in a deep ceramic plate. Cover with plastic lid. Stir occasionally during reheating and again before standing and serving. Serve after 3 minutes standing.		
Plated Meal (Chilled)	350 g	600 W	4½-5
	450 g		5½-6½
	550 g		6½-7½
Instructions Plate a meal of 2-3 chilled components on a ceramic dish. Cover with microwave cling-film. Serve after 3 minutes standing.			
Cheese Fondue Ready-to-Serve (Chilled)	400 g	600 W	6-7
	Instructions Put the ready-to-serve cheese fondue in a suitable sized glass pyrex bowl with lid. Stir occasionally during and after reheating. Stir well before serving. Serve after 1-2 minutes standing.		

Reheating baby food and milk

Use the power levels and times in this table as guide lines for reheating.

Food	Serving Size	Power	Time (min.)
Baby Food (Vegetables + Meat)	190 g	600 W	30 sec.
	Instructions Empty into ceramic deep plate. Cook covered. Stir after cooking time. Before serving, stir well and check the temperature carefully. Serve after 2-3 minutes standing.		
Baby Porridge (Grain + Milk + Fruit)	190 g	600 W	20 sec.
	Instructions Empty into ceramic deep plate. Cook covered. Stir after cooking time. Before serving, stir well and check the temperature carefully. Serve after 2-3 minutes standing.		
Baby Milk	100 ml	300 W	30-40 sec.
	200 ml		1 min. to 1 min. 10 sec.
Instructions Stir or shake well and pour into a sterilized glass bottle. Place into the centre of turntable. Cook uncovered. Before serving, shake well and check the temperature carefully. Serve after 2-3 minutes standing.			

Defrosting

Microwaves are an excellent way of defrosting frozen food. Microwaves gently defrost frozen food in a short period of time. This can be of great advantage, if unexpected guests suddenly show up.

Frozen poultry must be thoroughly thawed before cooking. Remove any metal ties and take it out of any wrapping to allow thawed liquid to drain away.

Put the frozen food on a dish without cover. Turn over half way, drain off any liquid and remove any giblets as soon as possible. Check the food occasionally to make sure that it does not feel warm.

If smaller and thinner parts of the frozen food start to warm up, they can be shield by wrapping very small strips of aluminium foil around them during defrosting. Should poultry start to warm up on the outer surface, stop thawing and allow it to stand for 20 minutes before continuing.

Leave the fish, meat and poultry to stand in order to complete defrosting. The standing time for complete defrosting will vary depending on the quantity defrosted. Please refer to the table below.

Hint: Flat food defrosts better than thick and smaller quantities need less time than bigger ones. Remember this hint while freezing and defrosting food.

For defrosting of frozen food with a temperature of about -18 to -20 °C, use the following table as a guide.

Food	Serving Size	Power	Time (min.)
Meat			
Minced Meat	250 g	180 W	6-7
	500 g		8-13
Pork Steaks	250 g	180 W	7-8
	Instructions Place the meat on turntable. Shield thinner edges with aluminium foil. Turn over after half of defrosting time! Serve after 15-30 minutes standing.		

Food	Serving Size	Power	Time (min.)
Poultry			
Chicken Pieces	500 g (2 pcs)	180 W	14-15
Whole Chicken	1200 g	180 W	32-34
	Instructions First, put chicken pieces first skin-side down, whole chicken first breast-side-down on a flat ceramic plate. Shield the thinner parts like wings and ends with aluminium foil. Turn over after half of defrosting time! Serve after 15-60 minutes standing.		
Fish			
Fish Fillets	200 g	180 W	6-7
Whole Fish	400 g	180 W	11-13
	Instructions Put frozen fish in the middle of a flat ceramic plate. Arrange the thinner parts under the thicker parts. Shield narrow ends of fillets and tail of whole fish with aluminium foil. Turn over after half of defrosting time! Serve after 10-25 minutes standing.		
Fruits			
Berries	300 g	180 W	6-7
	Instructions Spread fruit on a flat, round glass dish (with a large diameter). Serve after 5-10 minutes standing.		
Bread			
Bread Rolls (each ca. 50 g)	2 pcs	180 W	1-1½
	4 pcs		2½-3
Toast/Sandwich	250 g	180 W	4-4½
German bread (Wheat + Rye Flour)	500 g	180 W	7-9
	Instructions Arrange rolls in a circle or bread horizontally on kitchen paper in the middle of turntable. Turn over after half of defrosting time! Serve after 5-20 minutes standing.		

Cooking guide

Grill

The grill-heating element is located underneath the ceiling of the cavity. It operates while the door is closed and the turntable is rotating. The turntable's rotation makes the food brown more evenly. Preheating the grill for 3-5 minutes will make the food brown more quickly.

Cookware for grilling:

Should be flameproof and may include metal. Do not use any type of plastic cookware, as it can melt.

Food suitable for grilling:

Chops, sausages, steaks, hamburgers, bacon and gammon rashers, thin fish portions, sandwiches and all kinds of toast with toppings.

Important remark:

Whenever the grill only mode is used, please remember that food must be placed on the high rack, unless another instruction is recommended.

Microwave + Grill

This cooking mode combines the radiant heat that is coming from the grill with the speed of microwave cooking. It operates only while the door is closed and the turntable is rotating. Due to the rotation of the turntable, the food browns evenly. Three combination modes are available with this model: 600 W + Grill, 450 W + Grill and 300 W + Grill.

Cookware for cooking with microwave + grill

Please use cookware that microwaves can pass through. Cookware should be flameproof. Do not use metal cookware with combination mode. Do not use any type of plastic cookware, as it can melt.

Food suitable for microwave + grill cooking:

Food suitable for combination mode cooking include all kinds of cooked food which need reheating and browning (e.g. baked pasta), as well as foods which require a short cooking time to brown the top of the food. Also, this mode can be used for thick food portions that benefit from a browned and crispy top (e.g. chicken pieces, turning them over half way through cooking). Please refer to the grill table for further details.

Important remark:

Whenever the combination mode (microwave + grill) is used, the food should be placed on the high rack, unless another instruction is recommended. Please refer to the instructions in the following chart.

The food must be turned over, if it is to be browned on both sides.

Grill guide for fresh food

Preheat the grill with the grill-function for 2-3 minutes.

Use the power levels and times in this table as guide lines for grilling.

Use oven gloves when taking out.

Fresh food	Serving Size	Power	1 step (min.)	2 step (min.)
Toast Slices	4 pcs (each 25 g)	Grill only	4-4½	3-4
	Instructions Put toast slices side by side on the high rack.			
Grilled Tomatoes	400 g (2 pcs)	300 W + Grill	6-8	-
	Instructions Cut tomatoes into halves. Put some cheese on top. Arrange in a circle in a flat glass pyrex dish. Place it on the high rack. Stand for 2-3 minutes.			
Tomato-Cheese Toast	4 pcs (300 g)	300 W + Grill	5½-7½	-
	Instructions Toast the bread slices first. Put the toast with topping on the high rack. Stand for 2-3 minutes.			

Fresh food	Serving Size	Power	1 step (min.)	2 step (min.)
Toast Hawaii (Ham, Pineapple, Cheese slices)	4 pcs (500 g)	300 W + Grill	6-8	-
	Instructions Toast the bread slices first. Put the toast with topping on the high rack. Stand for 2-3 minutes.			
Baked Potatoes	500 g	600 W + Grill	12-14	-
	Instructions Cut potatoes into halves. Put them in a circle on the high rack with the cut side to the grill.			
Gratin Potatoes/ Vegetables (Chilled)	450 g	450 W + Grill	11-13	-
	Instructions Put the fresh gratin into a small glass pyrex dish. Put the dish on the high rack. After cooking stand for 2-3 minutes.			
Baked Apples	2 apples (ca. 400 g)	300 W + Grill	7-8	-
	Instructions Core the apples and fill them with raisins and jam. Put some almond slices on top. Put apples on a flat glass pyrex dish. Place the dish directly on the low rack.			
Chicken Pieces	500 g (2 pcs)	300 W + Grill	10-12	9-11
	Instructions Brush chicken pieces with oil and spices. Put them in a circle on the high rack. After grilling stand for 2-3 minutes.			
Roast Chicken	1200 g	450 W + Grill	22-23	21-22
	Instructions Brush the chicken oil and spices. Put the chicken on the low rack. After grilling stand for 5 minutes.			
Roast Fish	400-500 g	300 W + Grill	6-8	7-8
	Instructions Brush skin of whole fish with oil and add herbs and spices. Put two fishes side by side (head to tail) on the high rack. After grilling stand for 2-3 minutes.			

Fresh food	Serving Size	Power	1 step (min.)	2 step (min.)
Plantain	1 ea (200 g)	1 step 450 W + Grill 2 step Grill	7-7½	4-5
	Instructions peel and slice plantain 1cm thick and put on the crusty plate with grill rack. Brush all sides with oil. If plantain becomes soft, reduce time 1-2 minute soft type. Stand for 1-2 minutes.			
Yam	200 g	450 W + Grill	11-11½	-
	Instructions Peel and slice yam 1.5 cm thick and put on the crusty plate and brush all sides with oil. Put on the high rack and cook. Stand for 1-2 minutes.			

Cooking guide

Convection

Cooking with convection is the traditional and well known method of cooking food in a traditional oven with hot air.

The heating element and the fan position is at the back-wall, so that the hot air is circulating. This mode is supported by the top heating element.

Cookware for convection cooking:

All conventional ovenproof cookware, baking tins and sheets – anything you would normally use in a traditional convection oven – can be used.

Food suitable for convection cooking:

All biscuits, individual scones, rolls and cakes should be made by this mode as well as rich fruit cakes, choux pastry and soufflés.

Microwave + Convection

This mode combines the microwave energy with the hot air and is therefore reducing the cooking time while giving the food a brown and crispy surface. Cooking with convection is the traditional and well known method of cooking food in an oven with hot air circulated by a fan on the back-wall.

Cookware for cooking with microwaves + convection:

Should be able to let the microwaves pass through. Should be ovenproof (like glass, pottery or china without metal trims); similar to the cookware described under Microwave + Grill.

Food suitable for microwave + convection cooking:

All kinds of meats and poultry as well as casseroles and gratin dishes, sponge cakes and light fruit cakes, pies and crumbles, roast vegetables, scones and breads.

Convection guide for fresh and frozen food

Preheat the convection with the auto pre-heat function to the desired temperature. Use the power levels and times in this table as guide lines for convection cooking. Use oven gloves when taking out.

Fresh food	Serving Size	Power	1 step (min.)	2 step (min.)
Pizza				
Frozen Pizza (Ready baked)	300-400 g	1 step 300 W + 200 °C 2 step Conv. 180 °C	7-9	5-6
	Instructions Place the pizza on the low rack. After baking stand for 2-3 minutes.			
Pasta				
Frozen Lasagne	400 g	1 step 450 W + 200 °C 2 step Conv. 200 °C	16-18	3-4
	Instructions Put into a suitable sized glass pyrex dish or leave in the original packaging (take care that this is suitable for microwaves and oven heat). Put frozen pasta gratin on the low rack. After cooking stand for 2-3 minutes.			
Meat				
Roast Beef/ Roast Lamb (Medium)	1200-1300 g	600 W + 180 °C	20-23	10-13
	Instructions Brush beef/lamb with oil and spice it with pepper, salt and paprika. Put it on the low rack, first with the fat side down. After cooking wrap in aluminium foil and stand for 10-15 minutes.			
Roast Chicken	1000-1100 g	1 step 450 W + 200 °C 2 step 450 W + Grill	20-22	22-23½
	Instructions Brush chicken with oil and spices. Put chicken first breast side down, second side breast side up on the low rack. Stand for 5 minutes.			
Bread				
Fresh Bread Rolls	6 pcs (350 g)	100 W + 180 °C	8-10	-
	Instructions Put bread rolls in a circle on the low rack. Stand for 2-3 minutes.			

Fresh food	Serving Size	Power	1 step (min.)	2 step (min.)
Garlic Bread (Chilled, Prebaked)	200 g (1 pc)	180 W + 200 °C	8-10	-
	Instructions Put the chilled baguette on baking paper on the low rack. After baking stand for 2-3 minutes.			
Cake				
Marble Cake (Fresh Dough)	500 g	Only 180 °C	38-43	-
	Instructions Put the fresh dough in a small rectangular black metal baking dish (length 25 cm). Put the cake on the low rack. After baking stand for 5-10 minutes.			
Small Cakes (Fresh Dough)	10 x 28 g	Only 160 °C	31-34	-
	Instructions Fill the fresh dough evenly in paper cups and set on baking tray on the low rack. After baking stand for 5 minutes.			
Cookies (Fresh Dough)	200-250 g	Only 200 °C	15-20	-
	Instructions Put the chilled croissants on baking paper on the low rack.			
Frozen Cake	1000 g	180 W + 180 °C	18-20	-
	Instructions Put the frozen cake directly on the low rack. After defrost and warming stand for 15-20 minutes.			

Tips and tricks

Melting butter

Put 50 g butter into a small deep glass dish. Cover with plastic lid. Heat for 30-40 seconds using 900 W, until butter is melted.

Melting chocolate

Put 100 g chocolate into a small deep glass dish. Heat for 3-5 minutes, using 450 W until chocolate is melted. Stir once or twice during melting. Use oven gloves while taking out!

Melting crystallized honey

Put 20 g crystallized honey into a small deep glass dish. Heat for 20-30 seconds using 300 W, until honey is melted.

Melting gelatine

Lay dry gelatine sheets (10 g) for 5 minutes into cold water. Put drained gelatine into a small glass pyrex bowl. Heat for 1 minute using 300 W. Stir after melting.

Cooking glaze/icing (for cake and gateaux)

Mix instant glaze (approximately 14 g) with 40 g sugar and 250 ml cold water. Cook uncovered in a glass pyrex bowl for 3½ to 4½ minutes using 900 W, until glaze/icing is transparent. Stir twice during cooking.

Cooking jam

Put 600 g fruits (for example mixed berries) in a suitable sized glass pyrex bowl with lid. Add 300 g preserving sugar and stir well. Cook covered for 10-12 minutes using 900 W. Stir several times during cooking. Empty directly into small jam glasses with twist-off lids. Stand on lid for 5 minutes.



Troubleshooting and information code

Cooking pudding

Mix pudding powder with sugar and milk (500 ml) by following the manufacturers instructions and stir well. Use a suitable sized glass pyrex bowl with lid. Cook covered for 6½ to 7½ minutes using 900 W. Stir several times well during cooking.

Browning almond slices

Spread 30 g sliced almonds evenly on a medium sized ceramic plate. Stir several times during browning for 3½ to 4½ minutes using 600 W. Let it stand for 2-3 minutes in the oven. Use oven gloves while taking out!

Troubleshooting

If you have any of the problems listed below try the solutions given.

Problem	Cause	Action
General		
The buttons cannot be pressed properly.	Foreign matter may be caught between the buttons.	Remove the foreign matter and try again.
	For touch models: Moisture is on the exterior.	Wipe the moisture from the exterior.
	Child lock is activated.	Deactivate Child lock.
The time is not displayed.	The Eco (power-saving) function is set.	Turn off the Eco function.
The oven does not work.	Power is not supplied.	Make sure power is supplied.
	The door is open.	Close the door and try again.
	The door open safety mechanisms are covered in foreign matter.	Remove the foreign matter and try again.
The oven stops while in operation.	The user has opened the door to turn food over.	After turning over the food, press the Start button again to start operation.



Problem	Cause	Action
The power turns off during operation.	The oven has been cooking for an extended period of time.	After cooking for an extended period of time, let the oven cool.
	The cooling fan is not working.	Listen for the sound of the cooling fan.
	Trying to operate the oven without food inside.	Put food in the oven.
	There is not sufficient ventilation space for the oven.	There are intake/exhaust outlets on the front and rear of the oven for ventilation. Keep the gaps specified in the product installation guide.
	Several power plugs are being used in the same socket.	Designate only one socket to be used for the oven.
There is a popping sound during operation, and the oven doesn't work.	Cooking sealed food or using a container with a lid may causes popping sounds.	Do not use sealed containers as they may burst during cooking due to expansion of the contents.
The oven exterior is too hot during operation.	There is not sufficient ventilation space for the oven.	There are intake/exhaust outlets on the front and rear of the oven for ventilation. Keep the gaps specified in the product installation guide.
	Objects are on top of the oven.	Remove all objects on the top of the oven.

Problem	Cause	Action
The door cannot be opened properly.	Food residue is stuck between the door and oven interior.	Clean the oven and then open the door.
Heating including the Warm function does not work properly.	The oven may not work, too much food is being cooked, or improper cookware is being used.	Put one cup of water in a microwave-safe container and run the microwave for 1-2 minutes to check whether the water is heated. Reduce the amount of food and start the function again. Use a cooking container with a flat bottom.
The thaw function does not work.	Too much food is being cooked.	Reduce the amount of food and start the function again.
The interior light is dim or does not turn on.	The door has been left open for a long time.	The interior light may automatically turn off when the Eco function operates. Close and reopen the door or press the Cancel button.
	The interior light is covered by foreign matter.	Clean the inside of the oven and check again.
A beeping sound occurs during cooking.	If the Auto Cook function is being used, this beeping sound means it's time to turn over the food during thawing.	After turning over the food, press the Start button again to restart operation.

Troubleshooting and information code

Problem	Cause	Action
The oven is not level.	The oven is installed on an uneven surface.	Make sure the oven is installed on flat, stable surface.
There are sparks during cooking.	Metal containers are used during the oven/thawing functions.	Do not use metal containers.
When power is connected, the oven immediately starts to work.	The door is not properly closed.	Close the door and check again.
There is electricity coming from the oven.	The power or power socket is not properly grounded.	Make sure the power and power socket are properly grounded.
<ol style="list-style-type: none"> 1. Water drips. 2. Steam emits through a door crack. 3. Water remains in the oven. 	There may be water or steam in some cases depending on the food. This is not an oven malfunction.	Let the oven cool and then wipe with a dry dish towel.
The brightness inside the oven varies.	Brightness changes depending on power output changes according to function.	Power output changes during cooking are not malfunctions. This is not an oven malfunction.
Cooking is finished, but the cooling fan is still running.	To ventilate the oven, the cooling fan continues to run for about 3 minutes after cooking is complete.	This is not an oven malfunction.

Problem	Cause	Action
Turntable		
While turning, the turntable comes out of place or stops turning.	There is no roller ring, or the roller ring is not properly in place.	Install the roller ring and then try again.
The turn table drags while turning.	The roller ring is not properly in place, there is too much food, or the container is too large and touches the inside of the microwave.	Adjust the amount of food and do not use containers that are too large.
The turn table rattles while turning and is noisy.	Food residue is stuck to the bottom of the oven.	Remove any food residue stuck to the bottom of the oven.
Grill		
Smoke comes out during operation.	During initial operation, smoke may come from the heating elements when you first use the oven.	This is not a malfunction, and if you run the oven 2-3 times, it should stop.
	Food is on the heating elements.	Let the oven cool and then remove the food from the heating elements.
	Food is too close to the grill.	Put the food a suitable distance away while cooking.
	Food is not properly prepared and/or arranged.	Make sure food is properly prepared and arranged.

Problem	Cause	Action
Oven		
The oven does not heat.	The door is open.	Close the door and try again.
Smoke comes out during preheating.	During initial operation, smoke may come from the heating elements when you first use the oven.	This is not a malfunction, and if you run the oven 2-3 times, it should stop.
	Food is on the heating elements.	Let the oven cool and then remove the food from the heating elements.
There is a burning or plastic smell when using the oven.	Plastic or non heat-resistant cookware is used.	Use glass cookware suitable for high temperatures.
There is a bad smell coming from inside the oven.	Food residue or plastic has melted and stuck to the interior.	Use the steam function and then wipe with a dry cloth. You can put a lemon slice inside and run the oven to remove the odour more quickly.

Problem	Cause	Action
The oven does not cook properly.	The oven door is frequently opened during cooking.	If you open the door often, the interior temperature will be lowered and this may affect the results of your cooking.
	The oven controls are not correctly set.	Correctly set the oven controls and try again.
	The grill or other accessories are not correctly inserted.	Correctly insert the accessories.
	The wrong type or size of cookware is used.	Use suitable cookware with flat bottoms.

NOTE

If the above guidelines do not enable you to solve the problem, then contact your local SAMSUNG customer service centre.

Please have the following information read;

- The model and serial numbers, normally printed on the rear of the oven
- Your warranty details
- A clear description of the problem

Then contact your local dealer or SAMSUNG aftersales service.



Technical specifications

Information code

Check code	Cause	Action
C-10	Cooking sensor is needed to check.	Press the Stop/Cancel button and operate again. If it occurs again, turn off the microwave oven over 30 seconds and try setting again. If it appears again, call your local SAMSUNG Customer Care Centre.
C-20	Temperature sensor is needed to check.	
C-21	Temperature sensor detect higher temperature than setting temperature.	Turn off the microwave oven for cooling the product and then try setting again. If it appears again, call your local SAMSUNG Customer Care Centre.
C-d0	Control buttons are pressed over 10 seconds.	Clean the keys and check if there is water on the surface around key. If it occurs again, turn off the microwave oven over 30 seconds and try setting again. If it appears again, call your local SAMSUNG Customer Care Centre.

NOTE

For any codes not listed above, or if the suggested solution does not solve the problem, contact your local SAMSUNG Customer Care Centre.

SAMSUNG strives to improve its products at all times. Both the design specifications and these user instructions are thus subject to change without notice.

Model	MC32J7055C*
Power source	230 V ~ 50 Hz AC
Power consumption	2900 W 1400 W 1500 W Max. 2100 W
Maximum power	
Microwave	
Grill (heating element) Convection (heating element)	
Output power	100 W / 900 W - 6 levels (IEC-705) 240 V : 900 W 230 V : 850 W
Operating frequency	2450 MHz
Dimensions (W x H x D)	523 x 309 x 506 mm 373 x 233 x 370 mm
Outside (Include Handle) Oven cavity	
Volume	32 liter
Weight	20.0 kg approx.
Net	



Memo

Memo

Memo



SAMSUNG

Please be advised that the Samsung warranty does NOT cover service calls to explain product operation, correct improper installation, or perform normal cleaning or maintenance.

QUESTIONS OR COMMENTS

COUNTRY	CALL	OR VISIT US ONLINE AT
AUSTRIA	0800-SAMSUNG (0800-7267864) [Only for Premium HA] 0800-366661 [Only for Dealers] 0810-112233	www.samsung.com/at/support
BELGIUM	02-201-24-18	www.samsung.com/be/support (Dutch) www.samsung.com/be_fr/support (French)
DENMARK	70 70 19 70	www.samsung.com/dk/support
FINLAND	030-6227 515	www.samsung.com/fi/support
FRANCE	01 48 63 00 00	www.samsung.com/fr/support
GERMANY	0180 6 SAMSUNG bzw. 0180 6 7267864* (*0,20 €/Anruf aus dem dt. Festnetz, aus dem Mobilfunk max. 0,60 €/Anruf)	www.samsung.com/de/support
ITALIA	800-SAMSUNG (800.7267864)	www.samsung.com/it/support
CYPRUS	8009 4000 only from landline, toll free	www.samsung.com/gr/support
GREECE	80111-SAMSUNG (80111 726 7864) only from land line (+30) 210 6897691 from mobile and land line	
LUXEMBURG	261 03 710	www.samsung.com/be_fr/support
NETHERLANDS	0900-SAMSUNG (0900-7267864) (€ 0,10/Min)	www.samsung.com/nl/support
NORWAY	815 56480	www.samsung.com/no/support
PORTUGAL	808 20 7267	www.samsung.com/pt/support
SPAIN	0034902172678	www.samsung.com/es/support
SWEDEN	0771 726 7864 (0771-SAMSUNG)	www.samsung.com/se/support
SWITZERLAND	0800 726 78 64 (0800-SAMSUNG)	www.samsung.com/ch/support (German) www.samsung.com/ch_fr/support (French)
UK	0330 SAMSUNG (7267864)	www.samsung.com/uk/support
EIRE	0818 717100	www.samsung.com/ie/support



DE68-04319E-01