



User Guide

Getting Started	1
Printing	2
Troubleshooting	3
Replenishing and Replacing Consumables	4

For information not in this manual, refer to the HTML/PDF files on the supplied CD-ROM.



Read this manual carefully before you use this machine and keep it handy for future reference. For safe and correct use, be sure to read the Safety Information in "Read This First" before using the machine.

TABLE OF CONTENTS

1. Getting Started

Before You Start.....	5
How to Read the Manuals.....	5
List of Options.....	6
Printer Types.....	7
Model-Specific Information.....	8
Guide to Names and Functions of Components.....	10
Guide to Components.....	10
Guide to the Names and Functions of the Printer's Control Panel.....	13
Using the Screen on the Control Panel.....	16
How to Use the [Home] Screen.....	16
How to Use the Screens on the Control Panel.....	18
Switching Screen Patterns.....	20
Adding Icons to the [Home] Screen.....	21
Logging in the Printer.....	23
User Code Authentication Using the Control Panel.....	23
User Code Authentication Using a Printer Driver.....	23
Logging In Using the Control Panel.....	23
Logging Out Using the Control Panel.....	24
Logging In Using a Printer Driver.....	24
Logging In Using Web Image Monitor.....	25
Logging Out Using Web Image Monitor.....	26
Turning On/Off the Power.....	27
Turning On the Power.....	27
Turning Off the Power.....	27
Saving Energy.....	28
Displaying the Printer Configuration Screens.....	30
Displaying the Printer Driver Properties with Windows.....	30
Displaying the Printer Driver Properties with Mac OS X.....	32

2. Printing

Paper Specification.....	33
Supported Paper for Each Input Tray.....	33
Supported Paper for Each Output Tray.....	39

Notes about Paper Thickness.....	46
Print Area.....	47
Loading Paper.....	49
Precautions for Loading Paper.....	49
Unusable Paper.....	49
Paper Storage.....	50
Loading Paper into Paper Trays.....	51
Loading Paper into the Bypass Tray.....	53
Loading Paper into Tray 3 (LCT).....	54
Loading Paper into the Large Capacity Tray (LCT).....	56
Loading Orientation-Fixed Paper or Two-Sided Paper.....	57
Standard Printing.....	59
Printing with Windows (PCL 6/PostScript 3).....	59
Printing with Windows (PCL 5c/5e).....	60
Printing with Mac OS X.....	61
Printing on Both Sides of Sheets.....	62
Combining Multiple Pages into Single Page.....	63
Printing on Envelopes.....	65
Loading Envelopes.....	65
Printing on Envelopes with Windows (PCL 6/PostScript 3).....	67
Printing on Envelopes with Windows (PCL 5c/5e).....	67
Printing on Envelopes with Mac OS X.....	68
Storing a Document.....	69
Storing a Document with Windows.....	69
Storing a Document with Mac OS X.....	70

3. Troubleshooting

When Indicators Are Displayed.....	73
When a Panel Tone Beeps.....	74
Checking Printer Status and Settings.....	75
When an Indicator for the [Check Status] Key Is Lit.....	77
When You Have Problems Operating the Printer.....	79
When the Color Registration Shifts.....	85
When the Printed Color Changes.....	86

Setting the Gradation Correction Value.....	86
Gradation Correction Sheet.....	87
Resetting the Gradation Correction Value to the Default Value.....	89
If USB Connection Fails.....	90
When Messages Are Displayed.....	91
Status Messages.....	91
Alert Messages (Displayed on the Control Panel).....	92
Alert Messages (Printed on Error Logs and Reports).....	95
Checking the Error Log.....	105
When You Cannot Print.....	106
When the Data In Indicator Does Not Light Up or Flash.....	108
Other Printing Problems.....	109
When PictBridge Printing Does Not Work.....	121
Removing Jammed Paper.....	122
Locating Jammed Paper.....	123
When R1–R4 Is Displayed for the 2000-sheet Booklet Finisher.....	124
When R5–R7 Is Displayed for the 2000-sheet Booklet Finisher.....	125
When R8–R12 Is Displayed for the 2000-sheet Booklet Finisher.....	126
When R1–R4 Is Displayed for the 3000-sheet finisher.....	127
When R5 - R8 Is Displayed for the 3000-sheet finisher.....	128
Removing Jammed Staples.....	129
2000-sheet Booklet Finisher.....	130
2000-sheet Booklet Finisher (Saddle Stitch).....	131
3000-sheet Finisher.....	132
Removing Punch Waste.....	133
4. Replenishing and Replacing Consumables	
Adding Toner.....	135
Replacing Other Consumables.....	138
Adding Staples.....	140
Trademarks.....	141



1. Getting Started

This section describes the symbols used in the manuals supplied with the printer, available options, names and functions of components, and setup procedures.

Before You Start

How to Read the Manuals

Symbols used in the manuals

This manual uses the following symbols:

Important

Indicates points to pay attention to when using the machine, and explanations of likely causes of paper misfeeds, damage to originals, or loss of data. Be sure to read these explanations.

Note

Indicates supplementary explanations of the machine's functions, and instructions on resolving user errors.

Reference

This symbol is located at the end of sections. It indicates where you can find further relevant information.

[]

Indicates the names of keys on the machine's display or control panels.

 **Region A** (mainly Europe and Asia)

 **Region B** (mainly North America)

Differences in the functions of Region A and Region B models are indicated by two symbols. Read the information indicated by the symbol that corresponds to the region of the model you are using. For details about which symbol corresponds to the model you are using, see p.8 "Model-Specific Information".

Disclaimer

Contents of this manual are subject to change without prior notice.

To the maximum extent permitted by applicable laws, in no event will the manufacturer be liable for any damages whatsoever arising out of failures of this machine, losses of the registered data, or the use of this product and operation manuals provided with it.

Make sure that you always copy or have backups of the data registered in this machine. Documents or data might be erased due to your operational errors or malfunctions of the machine.

In no event will the manufacturer be responsible for any documents created by you using this machine or any results from the data executed by you.

Notes

The manufacturer shall not be responsible for any damage or expense that might result from the use of parts other than genuine parts from the manufacturer with your office products.

For good output quality, the manufacturer recommends that you use genuine toner from the manufacturer.

Some illustrations in this manual might be slightly different from the machine.

About IP address





In this manual, "IP address" covers both IPv4 and IPv6 environments. Read the instructions that are relevant to the environment you are using.

List of Options

This section provides a list of options for this printer and the names commonly used in this manual.

The Type 2 model comes equipped with a hard disk. For information about different models, see .p.7 "Printer Types"

Option name	Description
Paper Feed Unit PB3120	500-sheet paper feed unit
Paper Feed Unit PB3130	1000-sheet paper feed unit
LCIT PB3140	2000-sheet paper feed unit
LCIT RT3020	1200-sheet paper feed unit
Mail Box CS3000	Mailbox
Bridge Unit BU3060	Bridge unit
Booklet Finisher SR3110	2000-sheet booklet finisher
Finisher SR3120	3000-sheet finisher

Option name	Description
Punch Unit PU 3030 NA Punch Unit PU 3030 EU Punch Unit PU 3030 SC	Punch unit
Output Jogger Unit Type 9002A	Output jogger unit
Memory Unit Type J 512MB Memory Unit Type O 1GB	SDRAM module
Hard Disk Drive Option Type C830 * ¹	Hard disk
 Region A Gigabit Ethernet Board Type B  Region B Gigabit Ethernet Board Type D	Gigabit Ethernet board
 Region A IEEE802.11 a/g Interface Unit Type M IEEE802.11 Interface Unit Type P  Region B IEEE802.11 a/g Interface Unit Type L	Wireless LAN interface board
IEEE 1284 Interface Board Type A	IEEE 1284 interface board
Camera Direct Print Card Type J	Camera direct print card
SD card for NetWare printing Type O	NetWare card
VM Card Type U	VM card

*¹ Available for the Type 1 model only.

Printer Types

This printer comes in two models that have different printing speeds.

When describing procedures that are model-specific, this manual refers to the different printer models as Type 1 or Type 2. The following table describes the model types.

Model types	Printing speed	Hard disk
Type 1	Maximum 45 pages per minute (A4 \square)	Optional
Type 2	Maximum 55 pages per minute (A4 \square)	Standard

Certain types might not be available in some countries. For details, please contact your local dealer.

Certain options might not be available in some countries. For details, please contact your local dealer.

Depending on which country you are in, certain units may be optional. For details, please contact your local dealer.

Model-Specific Information

This section explains how to identify the region to which your printer belongs.

There is a label on the rear of the printer, located in the position shown below. The label contains details that identify the region to which your printer belongs. Read the label.

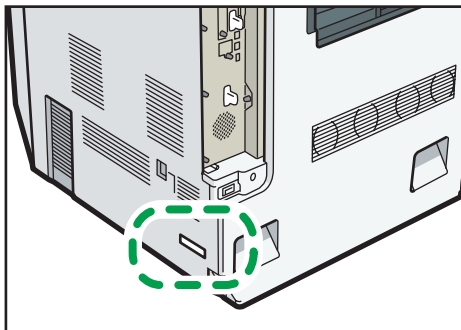

CQT851

The following information is region-specific. Read the information under the symbol that corresponds to the region of your printer.

 **Region A** (mainly Europe and Asia)

If the label contains the following, your printer is a region A model:

- CODE XXXX -22, -27, -29
- 220–240 V

 **Region B** (mainly North America)

If the label contains the following, your printer is a region B model:

- CODE XXXX -17
- 120–127 V

Note

- Dimensions in this manual are given in two units of measure: metric and inch. If your printer is a Region A model, refer to the metric units. If your printer is a Region B model, refer to the inch units.

Guide to Names and Functions of Components

Guide to Components

★ Important

- Do not obstruct the ventilation holes by placing objects near or against them. If the printer overheats, a malfunction might occur.

Front and right view

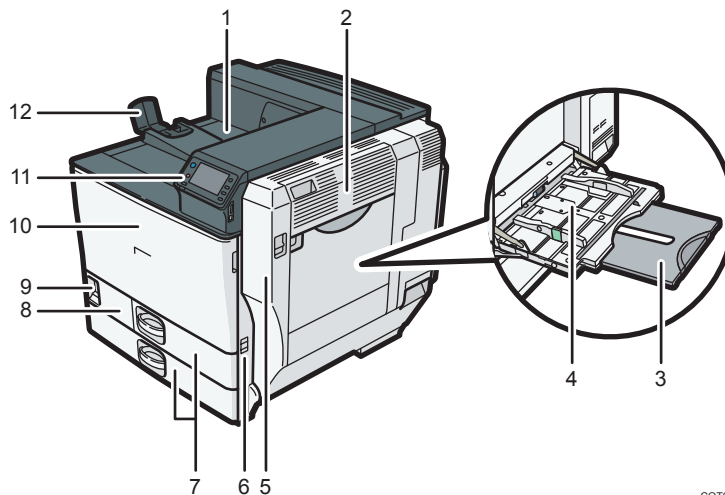

CQT003

1. Standard output tray

Printed pages are output here.

2. Upper right cover

Open this cover to remove jammed paper.

3. Bypass tray extension

When loading paper larger than A4, pull out the bypass tray extension. For details about the sizes and types of paper that can be used, see p.33 "Supported Paper for Each Input Tray".

4. Bypass tray

Up to 100 sheets of plain paper can be loaded.

5. Right cover (Duplex unit)

Open this cover to replace the fusing unit and transfer roller, or to remove jammed paper.

6. Handle

Pull out this handle when lifting the printer.

7. Tray 1, Tray 2

Up to 550 sheets of plain paper can be loaded in each tray.

8. Front lower cover

Open this cover when replacing the waste toner bottle.

If the "Waste Toner Bottle is full." message appears on the display, replace the waste toner bottle.

9. Power switch

Use this switch to turn the power on or off.

Perform the shutdown procedure before turning the power off. For details about how to shut down the printer, see p.27 "Turning Off the Power".

10. Front cover

Open this when replacing the toner, black drum unit/color drum units or transfer unit.

11. Control panel

See p.13 "Guide to the Names and Functions of the Printer's Control Panel".

12. Paper support

Extend the paper support when printing on paper larger than A3.

Rear and left view

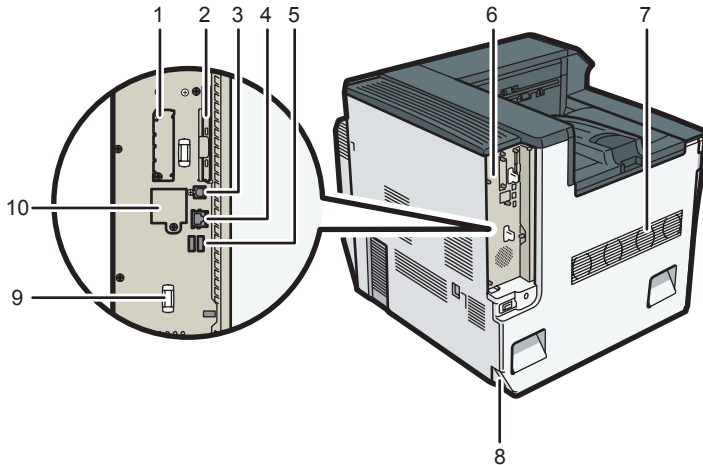

CQT001

1. Optional interface board slot

Optional interface boards can be inserted.

Insert an optional wireless LAN interface board or IEEE 1284 interface board.

2. Expansion card slots

Remove the cover to install SD cards.

3. USB port B

Use a USB cable to connect the printer to a host computer.

4. Ethernet port

Use a network interface cable to connect the printer to a network.

5. USB port A

Connect external devices such as a digital camera, a card authentication device, etc.

6. Controller board

Slide this out to install options such as the SDRAM module, hard disk, or Gigabit Ethernet board.

7. Ventilator

Releases heat from internal components to prevent overheating. Do not place objects against or near these holes. Doing so might result in printer malfunction.

8. Power connector

Connect the power cord to the printer. Insert the other end into an electrical outlet.

9. Handle

Hold this handle when pulling out the controller board.

10. Optional Gigabit Ethernet board port

By removing this cover and installing the optional Gigabit Ethernet board, you can connect an Ethernet cable to the port on the Gigabit Ethernet board.

Interior

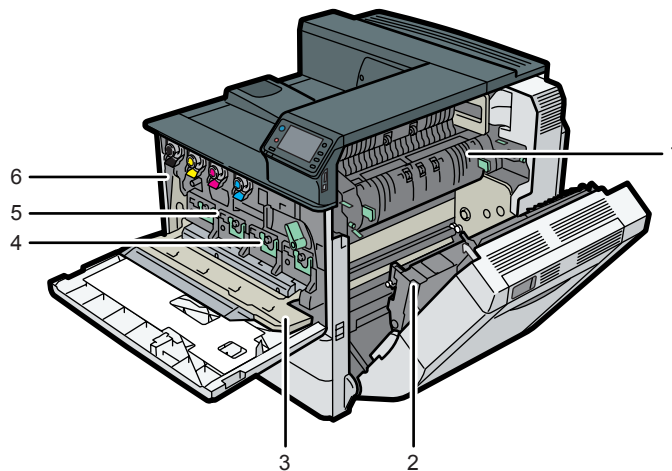

CQT004

1. Fusing unit

Replace the fusing unit when the following message appears:

- "Replacement of Fusing Unit is now necessary. Replace Fusing Unit."

Replace the fusing unit and the transfer roller together.

2. Transfer roller

Replace the transfer roller when the following message appears:

- "Replacement of Fusing Unit is now necessary. Replace Fusing Unit."

Replace the transfer roller and the fusing unit together.

3. Inner cover

Open this cover when replacing the black drum unit/color drum units or transfer unit.

4. Black drum unit / Color drum units

From the left, the drum units are installed in the order of black (K), yellow (Y), magenta (M), and cyan (C). Replace the relevant black drum unit/color drum units when the following message appears:

- "Replacement of Color Photoconductor Unit is now necessary. Replace Color Photoconductor Unit."
- "Replacement of Black Photoconductor Unit is now necessary. Replace Black Photoconductor Unit."

5. Transfer unit

Replace the transfer unit when the following message appears:

- "Replacement of Transfer Unit is now necessary. Replace Transfer Unit."

6. Toner

From the left, the toner is installed in the order of black (K), yellow (Y), magenta (M), and cyan (C).

Replace the relevant toner when the following message appears:

-  No toner. Replace Toner Cartridge."

Guide to the Names and Functions of the Printer's Control Panel

This illustration shows the control panel of the printer with options fully installed.

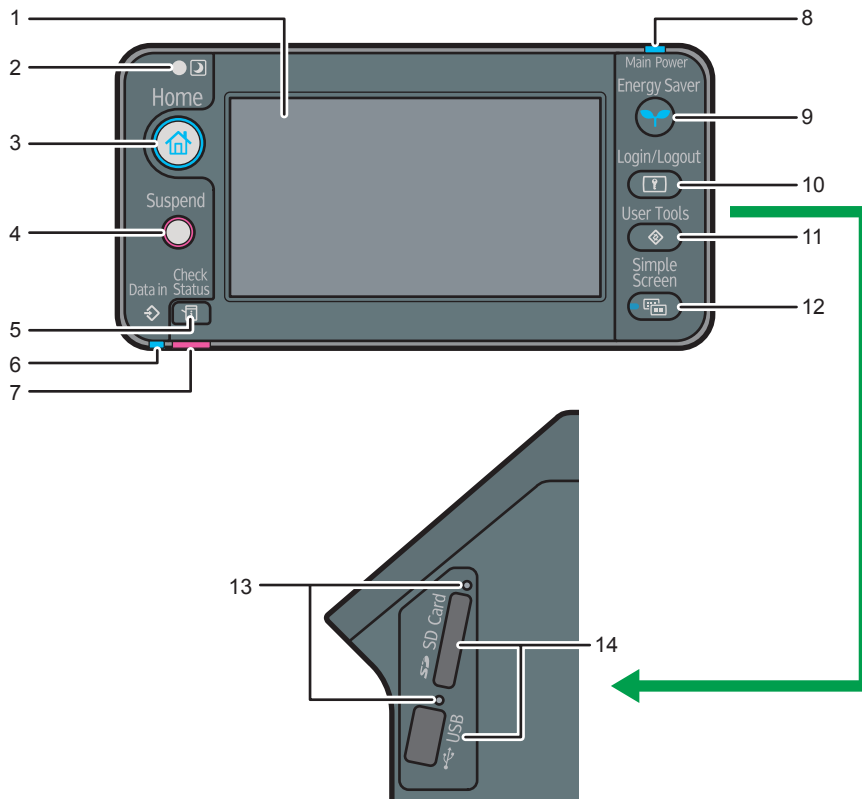

CQT135

1. Display panel

Displays keys for each function, operation status, or messages. See p.18 "How to Use the Screens on the Control Panel".

2. Light Sensor

The sensor that detects the ambient light level when the ECO Night Sensor function is enabled.

3. [Home] key

Press to display the [Home] screen. For details, see p.16 "How to Use the [Home] Screen".

4. [Suspend] key

Press this key to suspend a print job. The key lights up while the job is suspended.

5. [Check Status] key

Press to check the printer's system status, operational status of each function, and current jobs. You can also display the job history and the printer's maintenance information.

6. Data In indicator

Flashes when the printer is receiving print jobs from a computer. The data in indicator is lit if there is data to be printed.

7. Check Status indicator

Lights up or flashes when a printer error occurs.

Steady red: printing is not possible.

Flashing yellow: the printer will soon require maintenance or a replacement consumable such as a print cartridge. Printing is possible, but print quality cannot be ensured.

Follow the instructions that appear on the display.

8. Power indicator

Remains lit while the power is on. It is unlit when the power is off or while the printer is in energy saver mode.

9. [Energy Saver] key

Press to switch to and from Sleep mode. See p.28 "Saving Energy". When the printer is in Sleep mode, the [Energy Saver] key flashes slowly.

10. [Login/Logout] key

Press to log in or log out.

11. [User Tools] key

Press to change the default settings to meet your requirements. See "Displaying the Printer Configuration Screens Using the Control Panel", Operating Instructions.

12. [Simple Screen] key

Press to switch to the simple screen. See p.20 "Switching Screen Patterns".

13. Media access lamp

Lights up when a memory storage device is inserted in the media slot or accessed.

14. Media slots

Use to insert an SD card or a USB flash memory device.

Using the Screen on the Control Panel

This section describes how to use the screen on the control panel.

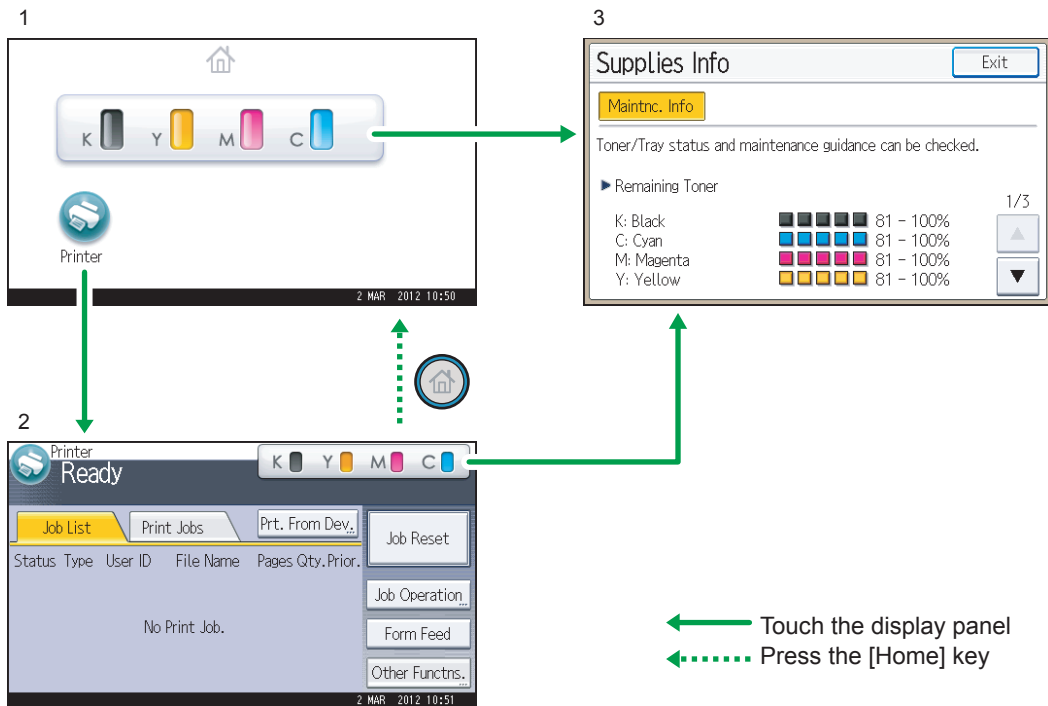

CQT660

1. [Home] screen

Displays function and shortcut icons. For details, see p.16 "How to Use the [Home] Screen".

2. [Printer] screen

Displays operation status, messages, and function menus. For details, see p.18 "How to Use the Screens on the Control Panel".

3. [Supplies Info] screen

Allows you to check the printer status, such as toner, paper, and waste toner levels.

↓ Note

- The [Home] screen is set as the default screen when the printer is turned on. You can change this default setting under Function Priority. See "System Settings", Operating Instructions.

How to Use the [Home] Screen

To display the [Home] screen, press the [Home] key.

The icons of each function are displayed on the [Home] screen.

You can add shortcuts to frequently used embedded software applications to the [Home] screen. The icons of added shortcuts appear on the [Home] screen. The embedded software applications can be recalled easily by pressing the shortcut icons.

★ Important

- Do not apply strong impact or force to the screen. Otherwise, it may be damaged. Maximum force allowable is approx. 30 N (approx. 3 kgf). (N = Newton, kgf = Kilogram force. 1 kgf = 9.8 N.)

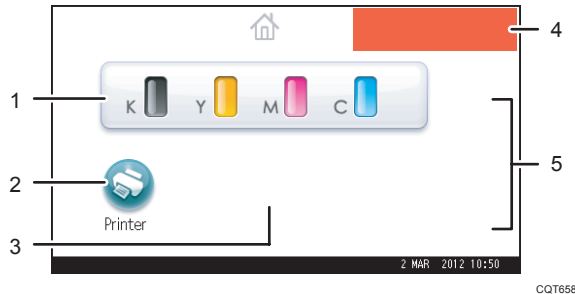

1. Supply Information icon

Press to display the [Supplies Info] screen to check toner, paper, and waste toner levels.

2. [Printer]

Press to display the [Printer] screen.

3. Shortcut icon area

You can add shortcuts to embedded software applications to the [Home] screen. For details about how to register shortcuts, see "Adding icons to the [Home] screen", Operating Instructions.

4. Home screen image

You can display an image such as a corporate logo on the [Home] screen. To change the image, see "Displaying the image on the [Home] screen", Operating Instructions.

5. ▲/▼

Press to switch pages when the icons are not displayed on one page.

↓ Note

- When an embedded software application is installed, a function icon for the application is displayed on the [Home] screen.
- You can change the order of icons. For details, see "Changing the order of icons on the [Home] screen", Operating Instructions.

System Reset

After finishing a job, the printer waits a specified length of time and then restores its settings to the default values specified under Function Priority. This function is called "System Reset". For the procedure for specifying default settings under Function Priority, see "System Settings", Operating Instructions.

To change the length of time that the printer waits before restoring its settings to their default values, use the System Auto Reset Timer setting. See "System Settings", Operating Instructions.

1 How to Use the Screens on the Control Panel

The display panel shows the operation status, messages, and function menus.

The function items displayed serve as selector keys. You can select or specify an item by lightly pressing them.

When you select or specify an item on the display panel, it is highlighted such as **Change**. Keys appearing as **Change** cannot be used.

★ Important

- Do not apply strong impact or force to the screen. Otherwise, it may be damaged. Maximum force allowable is approx. 30N (approx. 3 kgf). (N = Newton, kgf = Kilogram force. 1 kgf = 9.8N.)

The [Home] screen is set as the default screen when the printer is turned on.

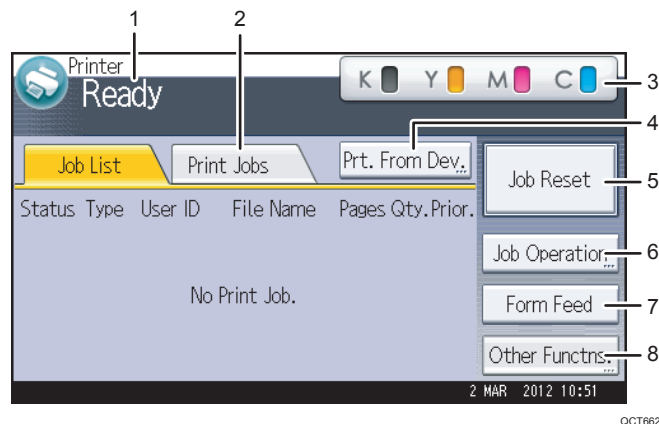

OCT662

1. Operational status or messages

Displays current printer status, such as "Ready", "Offline", and "Printing...". Information about the print job (user ID and document name) appears in this section.

2. [Print Jobs]

Press to display print jobs sent from a computer.

3. Supply Information

You can check the remaining toner. Press to display the [Supplies Info] screen.

4. [Prt. From Dev.]

Press to display the screen for printing files stored on memory storage devices directly.

5. [Job Reset]

Press to cancel the current print job.

If you press it when the Hex Dump is selected, Hex Dump is canceled.

6. [Job Operation]

Press to suspend a job being processed.

7. [Form Feed]

Press to print all the data left in the printer's input buffer.

8. [Other Functns.]

Press to display the error logs and status of spooled jobs.

How to use the [Information] screen

To improve user's environmental consciousness, you can configure the printer to notify users how much they have conserved paper usage by utilizing various paper conserving function of the printer.

The color utilization ratio is also displayed on the [Information] screen.

When user authentication is enabled, the screen is displayed when you log in to the printer. When user authentication is not enabled, the screen is displayed after returning from Sleep mode or after a system reset. The [Information] screen appears when the power is turned on, regardless of the authentication settings.

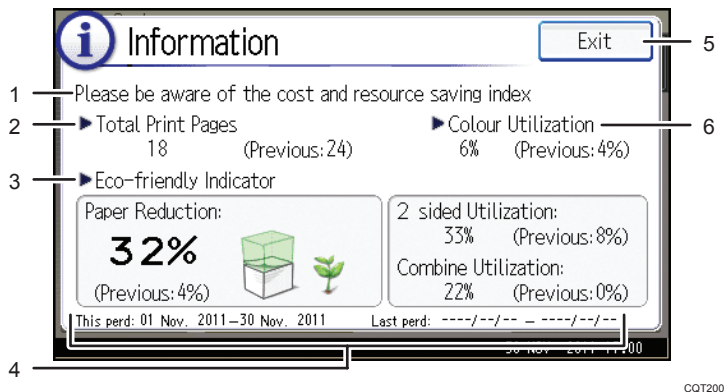

CQT200

1. Message

A message from the administrator is displayed.

2. Total Print Pages

Total number of pages printed in the current count period and the previous count period are displayed.

3. Eco-friendly Indicator

- Paper Reduction:

Shows the amount of paper saved by using the duplex and combine printing functions. The value indicates the percentage of paper saved from the total of all the paper used. As the percentage increases, the stack of paper decreases and the flower grows. When the ratio is 76% or more, the flower starts to bloom.

- 2 sided Utilization:

The ratio of 2-sided prints to the total number of prints is displayed.

- **Combine Utilization:**
The ratio of combined prints to the total number of prints is displayed.

4. **Count periods**

The current and previous count periods are displayed.

5. **[Exit]**

Press this to close the [Information] screen and return to operation.

6. **Color Utilization**

The ratio of color prints to the total number of prints is displayed.

↓ **Note**

- Depending on the printer settings, the [Information] screen may not be displayed. For details, see Security Guide.
- You can also use Web Image Monitor to check the usage status. For details about how to check them, see Web Image Monitor Help.
- Under [Eco-friendly Counter Period/Administrator Message] in [System Settings], you can check "Count Period", "Administrator Message", "Display Information Screen", and "Display Time". Only the administrator can change the settings. For details, see Security Guide.

Switching Screen Patterns

This section explains how to switch to the simple screen and the keys that are displayed.

When you press the [Simple Screen] key, the screen changes from the initial display to the simple screen.

Only the main functions are presented on the simple screen.

Letters and keys are displayed at a larger size, making operations easier.

1. **Press the [Simple Screen] key.**

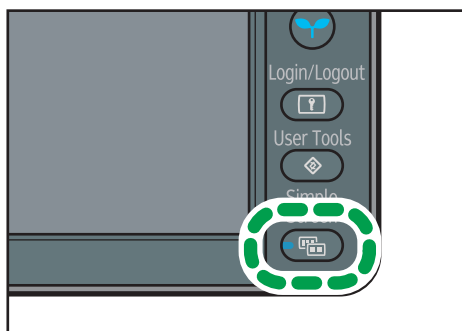

CQT663

This illustration shows the simple display of the [Printer] screen.

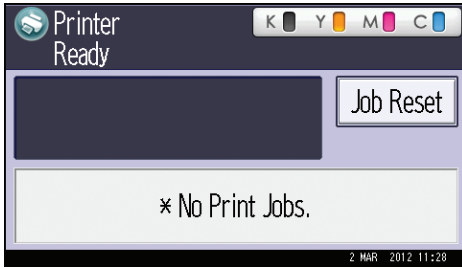

To increase the screen contrast, press the [Simple Screen] key again.

↓ Note

- To return to the initial display from the high contrast screen, press the [Simple Screen] key again.
- Certain keys do not appear on the simple screen.

Adding Icons to the [Home] Screen

You can also review icons of functions and embedded software applications that you deleted from the [Home] screen.

↓ Note

- Shortcut names of up to 32 characters can be displayed in a standard screen. If the name of the shortcut is longer than 32 characters, the 32nd character is replaced with "...". Only 30 characters can be displayed in a simple screen. If the name of the shortcut is longer than 30 characters, the 30th character is replaced with "...".
- You can register up to 72 function and shortcut icons. Delete unused icons if the limit is reached. For details see "Deleting an icon on the [Home] screen", Operating Instructions.
- You can change the position of icons. For details, see "Changing the order of icons on the [Home] screen", Operating Instructions.

In the following procedure, a shortcut to an embedded software application is registered to the [Home] screen.

For using Web Image Monitor

1. Log in to Web Image Monitor as an administrator.

For details, see "Displaying the Printer Configuration Screens Using a Web Browser", Operating Instructions.

2. Point to [Device Management], and then click [Device Home Management].

3. Click [Edit Icons].

4. Point to [+Icon can be added.] of the position that you want to add, and then click [+ Add].

5. Select the function or shortcut icon you want to add.

6. Click [OK] four times.

For using User Tools

1

1. Press [Add Icon] in the [Edit Home] screen.

For details about how to access the [Edit Home] screen, see "Displaying the Printer Configuration Screens Using the Control Panel", Operating Instructions.

2. Press [Select Icon to Add].
3. Press [Application].
4. Select the application you want to add.
5. Press [Select Destination].
6. Specify the position where [Blank] is displayed.
7. Press [Exit].
8. Press the [User Tools] key.

↓ Note

- Press [⋮] on the upper-right corner of the [Select Destination] screen to check the position on the simple screen.

Logging in the Printer

This section describes how to log in to the printer.

If Basic Authentication, Windows Authentication, LDAP Authentication, or Integration Server Authentication is enabled, the authentication screen appears on the display. The printer only becomes operable after entering your own Login User Name and Login Password. If User Code Authentication is enabled, you cannot use the printer until you enter the User Code.

If you can use the printer, you are logged in. When you exit the operable state, you are logged out. Be sure to log out to prevent unauthorized usage.

★ Important

- Ask the user administrator for the Login User Name, Login Password, and User Code. For details about user authentication, see Security Guide.

User Code Authentication Using the Control Panel

This section explains the procedure for logging in to the printer using the control panel while User Code Authentication is enabled.

If User Code Authentication is enabled, a screen prompting you to enter a User Code appears.

1. Enter a User Code (up to eight digits), and then press [OK].

↓ Note

- To log out, press the [Energy Saver] key after jobs are completed.

User Code Authentication Using a Printer Driver

This section explains the procedure for logging in to the printer using a printer driver while User Code Authentication is enabled.

If User Code Authentication is enabled., specify the User Code in the printer properties of the printer driver. For details, see the printer driver Help.

↓ Note

- The PCL printer driver supports User Code Authentication.
- When logged in using User Code Authentication, you do not have to log out.

Logging In Using the Control Panel

This section explains the procedure for logging in when Basic Authentication, Windows Authentication, LDAP Authentication, or Integration Server Authentication is enabled.

1. Press [Login].

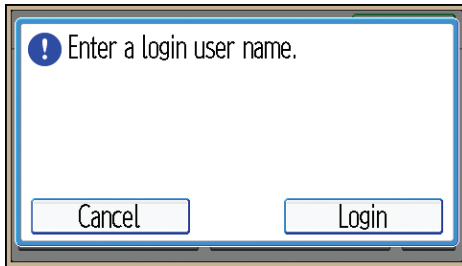

2. Enter a Login User Name, and then press [OK].

3. Enter a Login Password, and then press [OK].

When the user is authenticated, the screen for the function you are using appears.

Logging Out Using the Control Panel

This section explains the procedure for logging out when Basic Authentication, Windows Authentication, LDAP Authentication, or Integration Server Authentication is enabled.

★ Important

- To prevent use of the printer by unauthorized persons, always log out when you have finished using the printer.

1. Press the [Login/Logout] key.

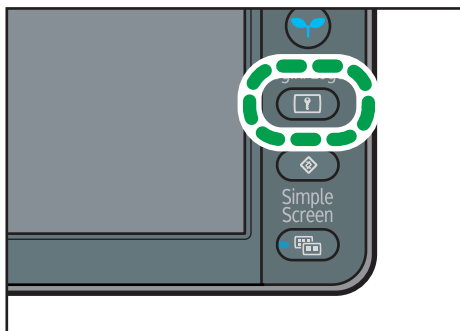

2. Press [Yes].

Logging In Using a Printer Driver

Enter your login user name and password as registered in the printer. You need only do this the first time you access the printer.

The PCL printer driver supports User Code Authentication.

The procedure is explained using Windows 7 as an example.

1. Open the printer properties dialog box, and then click the [Advanced Options] tab.

For details about displaying the printer properties dialog box, see p.30 "Displaying the Printer Driver Properties with Windows".

2. Select the [User Authentication] check box.

3. If you want to encrypt the login password, click [Driver Encryption Key...].

If you do not want to encrypt the password, proceed to step 6.

4. Enter the driver encryption key already set on the printer.

5. Click [OK] to close the [Driver Encryption Key] dialog box.

6. Click [OK] to close the printer properties dialog box.

7. Open the printing preferences dialog box.

8. Specify the user authentication setting.

If you are using the PCL 5c printer driver, click the [Valid Access] tab, and then click [Authentications...].

If you are using the PCL 6 printer driver, click the [Detailed Settings] tab, click [Job Setup], and then click [Authentication...] in the [Job Setup] area.

9. Enter a login user name and login password already set on the printer or the server for user authentication.

Be sure to enter the same login user name and login password that is registered on the printer or server.

If you do not enter a valid login user name and login password, printing will not start.

10. Click [OK] to close the [Authentication] dialog box.

11. Click [OK] to close the printing preferences dialog box.

Note

- Depending on the application in use, the properties specified in this procedure may not take effect.
- If you log in using the printer driver, you do not need to log out when you finish.

Logging In Using Web Image Monitor

For details about how to log in via Web Image Monitor, see "Displaying the Printer Configuration Screens Using a Web Browser", Operating Instructions.

Note

- For User Code Authentication, enter a User Code in the [Login User Name] box, and then click [Login].
- The procedure may differ depending on the Web browser used.

Logging Out Using Web Image Monitor

1

This section explains the procedure for logging out via Web Image Monitor.

1. Click [Logout] to log out.

 **Note**

- Delete the cache memory of the Web browser after logging out.

Turning On/Off the Power

This section describes how to turn on/off the printer.

↓ Note

- This printer automatically enters Sleep mode if you do not use it for a while. To specify the time that the printer waits before it enters Sleep mode, configure the Sleep Mode Timer setting. See "Timer Settings", Operating Instructions.

Turning On the Power

★ Important

- Do not turn off the power switch immediately after turning it on. Doing so may result in damage to the hard disk or memory, leading to malfunctions.

1. Make sure the power cord is firmly plugged into the wall outlet.
2. Turn on the power switch.

The power indicator turns on.

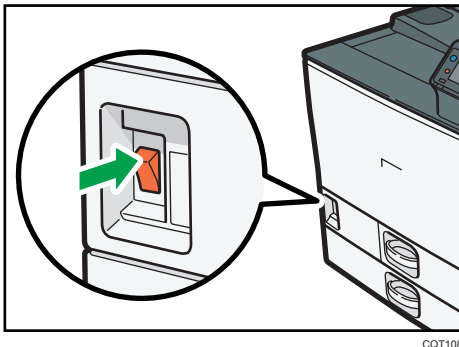

↓ Note

- After you switch the power on, a screen may appear to indicate that the printer is initializing. Do not switch the power off during this process. Initialization takes about three minutes.

Turning Off the Power

⚠ CAUTION

- When disconnecting the power cord from the wall outlet, always pull the plug, not the cord. Pulling the cord can damage the power cord. Use of damaged power cords could result in fire or electric shock.

★ Important

- After turning the printer's power off, wait at least a few seconds before turning it back on. If the message "Turn main Power Switch off" appears, turn the printer's power off, wait 10 seconds or more, and then turn it back on again. Never turn the power back on immediately after turning it off.
- Before unplugging the power cord plug, turn off the power switch and make sure the power switch indicator turns off. Not doing so may result in damage to the hard disk or memory, leading to malfunctions.
- Do not turn off the power while the printer is in operation.

1. Turn off the power switch.

The power indicator goes out.

Saving Energy

This printer has the following energy saving functions.

Low Power mode

If you do not use the printer for a certain period after an operation, the display will turn off and the printer goes into Low Power mode. The printer uses less electricity in Low Power mode.

You can change the amount of time that the printer waits before switching to Low Power mode under [Low Power Mode Timer]. For details, see "Timer Settings", Operating Instructions.

You can change the printer's settings to enter Low Power mode when you press the [Energy Saver] key. For details, see "Administrator Tools", Operating Instructions.

To exit Low Power mode, do one of the following:

- Touch the display panel or press one of the keys on the control panel.
- Load paper in the bypass tray.
- Pull out the paper trays.

Sleep mode

If the printer remains inactive for a specified period after entering Low Power mode, it enters Sleep mode to further reduce power consumption. The printer also enters Sleep mode under the following conditions:

- When the [Energy Saver] key is pressed
- The time the printer waits before entering Sleep mode is set in [Sleep Mode Timer]
- When the ECO Night Sensor detects the ambient light level

For details about setting [Sleep Mode Timer] and [ECO Night Sensor], see "Timer Settings" and "Administrator Tools", Operating Instructions.

To exit Sleep mode, do one of the following:

- Press the [Energy Saver] key
- Press the [Check Status] key

Off mode with Weekly Timer

Specify the time when the printer switches to and from Off mode. This timer can be set for Monday through Sunday. For details about setting [Weekly Timer], see "Timer Settings", Operating Instructions.

Off mode with ECO Night Sensor

The printer detects the ambient light level and enters Off mode at night automatically. For details about setting [ECO Night Sensor], see "Administrator Tools", Operating Instructions.

Note

- When the printer is in Sleep mode, the [Energy Saver] key flashes slowly.
- The energy saving functions will not operate in the following cases:
 - During communication with external equipment
 - When the hard disk is active
 - When a warning message appears
 - When the service call message appears
 - When paper is jammed
 - When the printer's covers are opened
 - When the "No toner. Replace Toner Cartridge." message appears
 - When toner is being replenished
 - When the [User Tools] screen is displayed
 - When fixed warm-up is in progress
 - When data is being processed
 - When operations are suspended during printing
 - When the Data In indicator is on or blinking
 - When the sample print, locked print, hold print, or stored print screen is displayed
 - When the screen of a document that was stored appears
 - When the internal cooling fan is active
- The printer consumes less energy when in Sleep mode, but it takes longer to start printing.
- If two or more energy saving functions are set, the function for which the predetermined conditions to enter energy saving mode are met takes effect first.

Displaying the Printer Configuration Screens

This section explains how to display the configuration screen of the printer.

Displaying the Printer Driver Properties with Windows

This section explains how to open the printer driver properties from [Devices and Printers].

★ Important

- **Manage Printers permission is required to change the printer settings. Log on as an Administrators group member.**
- **You cannot change the printer default settings for individual users. Settings made in the printer properties dialog box are applied to all users.**

1. On the [Start] menu, click [Devices and Printers].
2. Right-click the icon of the printer you want to use.
3. Click [Printer properties].

Displaying the Printing Preferences dialog box from the [Start] menu

This section explains how to open the [Printing Preferences] dialog box from [Devices and Printers].

★ Important

- **When the printer driver is distributed from the print server, the setting values specified by the server are displayed as the default for [Printing Defaults...].**
- **You cannot configure different print settings for each user. The settings configured in this dialog box are used as the default.**

1. On the [Start] menu, click [Devices and Printers].
2. Right-click the icon of the printer you want to use.
3. Click [Printing Preferences].

Displaying the Printing Preferences dialog box in an application

You can make printer settings for a specific application. To make printer settings for a specific application, open the [Printing Preferences] dialog box from that application.

The settings displayed in the [Printing Preference] dialog box opened from the [Devices and Printers] window are applied as the default in the [Printing Preference] dialog box opened in an application. When printing from an application, modify the settings as required.

The screens displayed may differ depending on the application. The following procedure explains how to print documents from an application using WordPad in Windows 7 as an example.

1. Click the WordPad menu button in the upper left corner of the window, and then click [Print].
2. In the [Select Printer] list, select the printer you want to use.
3. Click [Preferences].

↓ Note

- Procedures for opening the [Printing Preferences] dialog box vary depending on the application. For details, see the printer driver Help or the manuals provided with the application.

Using One Click Presets

Some of the frequently used functions are registered under "One Click Preset List:" on the [One Click Presets] tab.

You can apply the relevant setting simply by clicking on the one click preset name. This helps to avoid incorrect settings and misprints.

One click presets can be added, modified, and deleted as required. By using registered one click presets, users without in-depth knowledge of the printer driver can utilize advanced printing functions easily.

Follow the procedure to register one click presets.

1. Open the printing preferences dialog box.
2. Make the settings you require.
3. Click [Register Current Settings...].
4. Enter a name and comment that describe the setting, and then click [OK].
5. Click [OK].

↓ Note

- For details about modifying and deleting one click presets, see the printer driver Help.

Displaying the Printer Driver Help

Displaying the printer driver Help

If you click [Help] in the setting dialog box for the printer driver, the Help contents corresponding to the displayed tab appears.

Displaying the descriptions of the items on the printer driver's settings dialog box

If you click the question mark button in the upper right corner of the setting dialog box for the printer driver, the mouse's pointer changes to a question mark. Move this question mark over the item whose Help information you want to view, and then left-click to display the Help information.

Displaying the Printer Driver Properties with Mac OS X

This section explains how to display the printer driver settings screen on Mac OS X. Displayed screens may differ from those indicated in the following steps depending on the application. In the procedure below, Text Edit provided with Mac OS X 10.6 is used as an example.

- 1. Start System Preferences.**
- 2. Click [Print & Fax].**
- 3. Click the icon of the printer you want to use.**

Displaying the printing preferences screen from an application

You can make printer settings for a specific application. To make printer settings for a specific application, open the printing preferences screen from that application.

- 1. Select [Print] on the [File] menu.**
- 2. Select the printer you are using in the [Printer:] pop-up menu.**

2. Printing

This chapter describes how to set up the printer before use including the procedures for loading paper into the paper trays and configuring printer settings, and how to print documents using various printing functions. Printing procedures using the printer drivers on Windows 7 and Mac OS X 10.6 are shown as an examples.

Paper Specification

This section describes the recommended paper sizes, types, and paper weight for each tray.

Supported Paper for Each Input Tray

The following tables provide details of the sizes, types, feed directions, and maximum number of sheets of paper that can be loaded in each of the printer input trays. It also provides supported paper information when duplex printing is specified.





★ Important

- The paper capacities described in the tables below are examples. The actual paper capacities might be lower, depending on the paper type.





Tray 1

Paper type	Plain Paper, Recycled Paper, Color Paper, Special Paper 1 to 3, Letterhead, Preprinted Paper, Bond Paper, Cardstock, Coated Paper: Gloss Print
Paper sizes	Region A A4 Region B 8 1/2 x 11
Paper weight	52–256 g/m ² (14 lb. Bond–140 lb. Index)
Paper capacity (80 g/m ² , 20 lb. Bond)	550 sheets
Note	<ul style="list-style-type: none">• Custom paper size is not supported.• The paper tray fence is fixed. If you wish to change the size of paper placed in this tray, contact your service representative.





Tray 2

Paper type	Plain Paper, Recycled Paper, Color Paper, Special Paper 1 to 3, Letterhead, Preprinted Paper, Bond Paper, Cardstock, Coated Paper, Coated Paper: Gloss Print, Envelope
Paper sizes selected automatically	<p> Region A A3, A4, A5, B4 JIS, B5 JIS, 8 1/2 × 11</p> <p> Region B 11 × 17, 8 1/2 × 14, 8 1/2 × 11, 7 1/4 × 10 1/2, A4, A5, B5 JIS</p>
Paper sizes requiring manual setting	<p>Standard size:</p> <p> Region A 11 × 17, 8 1/2 × 14, 8 1/2 × 13, 8 1/2 × 11, 8 1/4 × 14, 8 1/4 × 13, 8 × 13, 8 × 10, 7 1/4 × 10 1/2, 8K, 16K, 11 × 15, 10 × 14, 4 1/8 × 9 1/2, C5 Env</p> <p> Region B A3, A4, B4 JIS, B5 JIS, 8 1/2 × 13, 8 1/4 × 14, 8 1/4 × 13, 8 × 13, 8 × 10, 7 1/4 × 10 1/2, 8K, 16K, 11 × 15, 10 × 14, 4 1/8 × 9 1/2, C5 Env</p> <p>Custom size:</p> <ul style="list-style-type: none"> • Vertical: 182.0–297.0 mm (7.17–11.69 inches) • Horizontal: 148.0–432.0 mm (5.83–17.00 inches)
Paper weight	52–256 g/m ² (14 lb. Bond–140 lb. Index)
Paper capacity	80 g/m ² (20 lb. Bond): 550 sheets Envelopes: 50 sheets
Note	<ul style="list-style-type: none"> • Load envelopes with their flaps fully open. • When loading paper with a vertical length of more than 279 mm (11.0 inches) in trays, use paper that has a horizontal width of 420 mm (16.6 inches) or less.



Bypass Tray



Paper type	Plain Paper, Recycled Paper, Color Paper, Special Paper 1 to 3, Letterhead, Preprinted Paper, Bond Paper, Cardstock, Coated Paper, Coated Paper: Gloss Print, OHP (Transparency), Label Paper, Envelope
Paper sizes selected automatically	<p> Region A A3, A4, A5, A6</p> <p> Region B 11 × 17, 8¹/₂ × 11, 5¹/₂ × 8¹/₂</p>
Paper sizes requiring manual setting	<p>Standard size:</p> <p> Region A B4 JIS, B5 JIS, B6 JIS, 11 × 17, 8¹/₂ × 14, 8¹/₂ × 13, 8¹/₂ × 11, 8¹/₄ × 14, 8¹/₄ × 13, 8 × 13,</p> <p>8 × 10, 7¹/₄ × 10¹/₂, 5¹/₂ × 8¹/₂, 4¹/₈ × 9¹/₂, 3⁷/₈ × 7¹/₂, C5 Env, C6 Env, DL Env, 8K, 16K, 12 × 18, 11 × 15, 10 × 14</p> <p> Region B A3, A4, A5, A6, B4 JIS, B5 JIS, B6 JIS, 8¹/₂ × 14, 8¹/₂ × 13, 8¹/₄ × 14, 8¹/₄ × 13, 8 × 13,</p> <p>8 × 10, 7¹/₄ × 10¹/₂, 4¹/₈ × 9¹/₂, 3⁷/₈ × 7¹/₂, C5 Env, C6 Env, DL Env, 8K, 16K, 12 × 18, 11 × 15, 10 × 14</p> <p>Custom size</p> <ul style="list-style-type: none"> • Vertical: 90.0–305.0 mm (3.55–12.00 inches) • Horizontal: 148.0–1,260.0 mm (5.83–49.60 inches)
Paper weight	52–300 g/m ² (14 lb. Bond–110 lb. Cover)
Paper capacity	<ul style="list-style-type: none"> • 80 g/m² (20 lb. Bond) : 100 sheets • Thick Paper 1: 40 sheets • Thick Paper 2, 3: 20 sheets • Thick Paper 4: 16 sheets • OHP (Transparency): 50 sheets • Label Paper: 30 sheets • Envelopes: 10 sheets

500-sheet paper feed unit



Paper type	Plain Paper, Recycled Paper, Color Paper, Special Paper 1 to 3, Letterhead, Preprinted Paper, Bond Paper, Cardstock, Coated Paper, Coated Paper: Gloss Print, Envelope
Paper sizes selected automatically	<p> Region A A3, A4, A5, B4 JIS, B5 JIS, 8 1/2 × 11</p> <p> Region B 11 × 17, 8 1/2 × 14, 8 1/2 × 11, 7 1/4 × 10 1/2, A4, A5, B5 JIS</p>
Paper sizes requiring manual setting	<p>Standard size:</p> <p> Region A 11 × 17, 8 1/2 × 14, 8 1/2 × 13, 8 1/2 × 11, 8 1/4 × 14, 8 1/4 × 13, 8 × 13, 8 × 10, 7 1/4 × 10 1/2, 8K, 16K, 11 × 15, 10 × 14, 4 1/8 × 9 1/2, C5 Env</p> <p> Region B A3, A4, B4 JIS, B5 JIS, 8 1/2 × 13, 8 1/4 × 14, 8 1/4 × 13, 8 × 13, 8 × 10, 7 1/4 × 10 1/2, 8K, 16K, 11 × 15, 10 × 14, 4 1/8 × 9 1/2, C5 Env</p> <p>Custom size:</p> <ul style="list-style-type: none"> • Vertical: 182.0–297.0 mm (7.17–11.69 inches) • Horizontal: 148.0–432.0 mm (5.83–7.00 inches)
Paper weight	52–256 g/m ² (14 lb. Bond–140 lb. Index)
Paper capacity (80 g/m ² , 20 lb. Bond)	550 sheets

1000-sheet paper feed unit





Paper type	Plain Paper, Recycled Paper, Color Paper, Special Paper 1 to 3, Letterhead, Preprinted Paper, Bond Paper, Cardstock, Coated Paper, Coated Paper: Gloss Print, Envelope
Paper sizes selected automatically	<p> Region A A3, A4, A5, B4 JIS, B5 JIS, 8 1/2 × 11</p> <p> Region B 11 × 17, 8 1/2 × 14, 8 1/2 × 11, 7 1/4 × 10 1/2, A4, A5, B5 JIS</p>

Paper sizes requiring manual setting	<p>Standard size:</p> <p> Region A 11 × 17\square, 8$\frac{1}{2}$ × 14\square, 8$\frac{1}{2}$ × 13\square, 8$\frac{1}{2}$ × 11\square, 8$\frac{1}{4}$ × 14\square, 8$\frac{1}{4}$ × 13\square, 8 × 13\square, 8 × 10\square, 7$\frac{1}{4}$ × 10$\frac{1}{2}$$\square$, 8K$\square$, 16K$\square$, 11 × 15$\square$, 10 × 14$\square$, 4$\frac{1}{8}$ × 9$\frac{1}{2}$$\square$, C5 Env$\square$</p> <p> Region B A3\square, A4\square, B4 JIS\square, B5 JIS\square, 8$\frac{1}{2}$ × 13\square, 8$\frac{1}{4}$ × 14\square, 8$\frac{1}{4}$ × 13\square, 8 × 13\square, 8 × 10\square, 7$\frac{1}{4}$ × 10$\frac{1}{2}$$\square$, 8K$\square$, 16K$\square$, 11 × 15$\square$, 10 × 14$\square$, 4$\frac{1}{8}$ × 9$\frac{1}{2}$$\square$, C5 Env$\square$</p> <p>Custom size:</p> <ul style="list-style-type: none"> • Vertical: 182.0–297.0 mm (7.17–11.69 inches) • Horizontal: 148.0–432.0 mm (5.83–17.00 inches)
Paper weight	52–256 g/m ² (14 lb. Bond–140 lb. Index)
Paper capacity (80 g/m ² , 20 lb. Bond)	550 sheets × 2 tray



















2000-sheet paper feed unit

Paper type	Plain Paper, Recycled Paper, Color Paper, Special Paper 1 to 3, Letterhead, Preprinted Paper, Bond Paper, Cardstock, Coated Paper, Coated Paper: Gloss Print
Paper sizes	<p> Region A A4\square</p> <p> Region B 8$\frac{1}{2}$ × 11\square</p>
Paper weight	52–256 g/m ² (14 lb. Bond–140 lb. Index)
Paper capacity (80 g/m ² , 20 lb. Bond)	1,000 sheets × 2 trays
Note	<ul style="list-style-type: none"> • Custom paper size is not supported. • The paper tray fence is fixed. If you wish to change the size of paper placed in this tray, contact your service representative.

1200-sheet paper feed unit

Paper type	Plain Paper, Recycled Paper, Color Paper, Special Paper 1 to 3, Letterhead, Preprinted Paper, Bond Paper, Cardstock, Coated Paper, Coated Paper: Gloss Print
Paper sizes	 Region A A4   Region B 8 1/2 × 11 
Paper weight	60–216 g/m ² (16 lb. Bond–80 lb. Cover)
Paper capacity (80 g/m ² , 20 lb. Bond)	1,200 sheets
Note	<ul style="list-style-type: none"> • Custom paper size is not supported. • The paper tray fence is fixed. If you wish to change the size of paper placed in this tray, contact your service representative.

Duplex printing

Paper type	Plain Paper, Recycled Paper, Color Paper, Special Paper 1 to 3, Letterhead, Preprinted Paper, Bond Paper, Cardstock
Paper sizes	<p>Standard size:</p> <p>A3 , A4 , A5 , A6 , B4 JIS , B5 JIS , B6 JIS , 11 × 17 , 8 1/2 × 14 , 8 1/2 × 13 , 8 1/2 × 11 , 8 1/4 × 14 , 8 1/4 × 13 , 8 × 13 , 8 × 10 , 7 1/4 × 10 1/2 , 5 1/2 × 8 1/2 , 8K , 16K , 11 × 15 , 10 × 14 </p> <p>Custom size:</p> <ul style="list-style-type: none"> • Vertical: 90.0–297.0 mm (3.55–11.69 inches) • Horizontal: 148.0–432.0 mm (5.83–17.00 inches)
Paper weight	52–169 g/m ² (14 lb. Bond–90 lb. Index)

Supported Paper for Each Output Tray

The following tables provide details of the sizes, feed directions, and maximum number of sheets of paper that can be stacked in each of the printer's output trays. They also describe the specifications for the staple function of the optional finisher.

★ Important

- The paper capacities described in the tables below are examples. The actual paper capacities might be lower, depending on the paper type.

Standard output tray

Paper capacity (80 g/m², 20 lb. Bond):

- 500 sheets (A4, 8 1/2 × 11 or smaller)
- 250 sheets (B4 JIS, 8 1/2 × 14 or larger)

Bridge unit

Paper capacity (80 g/m², 20 lb. Bond):

- 250 sheets: A4, 8 1/2 × 11 or smaller
- 125 sheets: B4 JIS, 8 1/2 × 14 or larger

Mailbox

Paper sizes	<p>Standard size: A3, A4, A5, A6, B4 JIS, B5 JIS, B6 JIS, 11 × 17, 8 1/2 × 14, 8 1/2 × 13, 8 1/2 × 11, 8 1/4 × 14, 8 1/4 × 13, 8 × 13, 8 × 10, 7 1/4 × 10 1/2, 5 1/2 × 8 1/2, 4 1/8 × 9 1/2, 3 7/8 × 7 1/2, C5 Env, C6 Env, DL Env, 8K, 16K</p> <p>Custom size: Vertical: 105.0–297.0 mm (4.14–11.69 inches) Horizontal: 139.7–431.8 mm (5.50–17.00 inches)</p>
Paper weight	60–81 g/m ² (16–20 lb. Bond)
Paper capacity (80 g/m ² , 20 lb. Bond)	125 sheets × 4

2000-sheet booklet finisher

The finisher upper tray

Paper sizes	<p>Standard size:</p> <p>A3, B4 JIS, A4, B5 JIS, A5, B6 JIS, A6, 12 × 18, 11 × 17, 11 × 15, 10 × 14, 8¹/₂ × 14, 8¹/₂ × 13, 8¹/₂ × 11, 8¹/₄ × 14, 8¹/₄ × 13, 8 × 13, 8 × 10, 5¹/₂ × 8¹/₂, 7¹/₄ × 10¹/₂, 8K, 16K</p> <p>Custom size:</p> <ul style="list-style-type: none"> Vertical: 100.0–305.0 mm (3.94–12.00 inches) Horizontal: 148.0–600.0 mm (5.83–23.62 inches)
Paper weight	52–163 g/m ² (14 lb. Bond–90 lb. Index)
Stack capacity(80 g/m ² , 20 lb. Bond)	<ul style="list-style-type: none"> A4, 8¹/₂ × 11 or smaller: 250 sheets B4 JIS, 8¹/₂ × 14 or larger: 50 sheets

The finisher shift tray

Paper sizes	<p>A3, B4 JIS, A4, B5 JIS, A5, B6 JIS, A6, 12 × 18, 11 × 17, 11 × 15, 10 × 14, 8¹/₂ × 14, 8¹/₂ × 13, 8¹/₂ × 11, 8¹/₄ × 14, 8¹/₄ × 13, 8 × 13, 8 × 10, 5¹/₂ × 8¹/₂, 7¹/₄ × 10¹/₂, 8K, 16K, custom size</p>
Paper weight	52–256 g/m ² (14 lb. Bond–140 lb. Index)

Paper sizes that can be shifted when delivered to the finisher shift tray	<p>Standard size:</p> <p>A3, A4, A5, B4 JIS, B5 JIS, 12 × 18, 11 × 17, 11 × 15, 10 × 14, 8¹/₂ × 14, 8¹/₂ × 13, 8¹/₂ × 11, 8¹/₄ × 14, 8¹/₄ × 13, 8 × 13,</p> <p>8 × 10, 7¹/₄ × 10¹/₂, 8K, 16K</p> <p>Custom size:</p> <ul style="list-style-type: none"> • Vertical: 148.0–305.0 mm (5.83–12.00 inches) • Horizontal: 148.0–457.2 mm (5.83–18.00 inches)
Paper weight that can be shifted when delivered to the finisher shift tray	60–105 g/m ² (16–28 lb. Bond)
Stack capacity(80 g/m ² , 20 lb. Bond)	<ul style="list-style-type: none"> • 2,000 sheets: A4, 8¹/₂ × 11 • 1,000 sheets: A3, B4 JIS, A4, B5 JIS, 11 × 17, 8¹/₂ × 14, 8¹/₂ × 11, 12 × 18 • 500 sheets: A5 • 100 sheets: A5, B6 JIS, A6, 5¹/₂ × 8¹/₂

Stapling

Paper sizes	<p>A3, B4 JIS, A4, B5 JIS, 11 × 17, 11 × 15, 10 × 14, 8¹/₂ × 14, 8¹/₂ × 11, 7¹/₄ × 10¹/₂, 8 × 13,</p> <p>8¹/₂ × 13, 8¹/₄ × 14, 8¹/₄ × 13, 8 × 10, 8K, 16K</p>
Paper weight	64–90 g/m ² (17–24 lb. Bond)
Staple capacity (80 g/m ² , 20 lb. Bond)	<p>Without Mixed Size:</p> <ul style="list-style-type: none"> • 30 sheets: A3, B4 JIS, 11 × 17, 8¹/₂ × 14, 8 × 13, 8¹/₂ × 13, 8¹/₄ × 14, 8¹/₄ × 13, 11 × 15, 10 × 14, 8K • 50 sheets: A4, B5 JIS, 8¹/₂ × 11, 8 × 10, 7¹/₄ × 10¹/₂, 16K <p>With Mixed Size:</p> <ul style="list-style-type: none"> • 30 sheets (A3/A4, B4 JIS/B5 JIS, 11 × 17/8¹/₂ × 11)

<p>Stack capacity after stapling (80 g/m², 20 lb. Bond)</p>	<p>Without Mixed Size:</p> <ul style="list-style-type: none"> • 2–12 sheets: 150 sets (A4, 8 1/2 × 11) • 13–50 sheets: 150–40 sets (A4, 8 1/2 × 11) • 2–9 sheets: 100 sets (A4, B5 JIS, 8 1/2 × 11) • 10–50 sheets: 100–20 sets (A4, B5 JIS, 8 1/2 × 11) • 2–9 sheets: 100 sets (other size paper) • 10–30 sheets: 100–33 sets (other size paper) <p>With Mixed Size:</p> <ul style="list-style-type: none"> • 2–30 sheets: 50 sets (A3/A4, B4 JIS/B5 JIS, 11 × 17/8 1/2 × 11)
<p>Staple position</p>	<p>4 positions (Top, Top Slant, Bottom, 2 Staples)</p>

Saddle stitch

<p>Paper size</p>	<p>A3, B4 JIS, A4, B5 JIS, 11 × 17, 8 1/2 × 14, 8 1/2 × 11</p>
<p>Paper weight</p>	<p>64–90 g/m² (17–24 lb. Bond)</p>
<p>Saddle stitch capacity (80 g/m², 20 lb. Bond)</p>	<p>1 set (15 sheets)</p>
<p>Stack capacity after saddle stitching (80 g/m², 20 lb. Bond)</p>	<ul style="list-style-type: none"> • 2–5 sheets: approx. 30 sets • 6–10 sheets: approx. 15 sets • 11–15 sheets: approx. 10 sets
<p>Saddle stitch position</p>	<p>Center 2 positions</p>

3000-sheet finisher

The finisher upper tray

Paper sizes*	<p>Standard size:</p> <p>A3, B4 JIS, A4, B5 JIS, A5, B6 JIS, A6, 12 × 18, 11 × 17, 11 × 15, 10 × 14, 8¹/₂ × 14, 8¹/₂ × 13, 8¹/₂ × 11, 8¹/₄ × 14, 8¹/₄ × 13,</p> <p>8 × 13, 8 × 10, 5¹/₂ × 8¹/₂, 7¹/₄ × 10¹/₂, 8K, 16K</p> <p>Custom size:</p> <ul style="list-style-type: none"> Vertical: 100.0–305.0 mm (3.94–12.00 inches) Horizontal: 148.0–600.0 mm (5.83–23.62 inches) <p>When installing the output jogger unit, paper sizes for the finisher upper tray are listed below:</p> <p>A3, B4 JIS, A4, B5 JIS, A5, 11 × 17, 8¹/₂ × 14, 8¹/₂ × 11, 5¹/₂ × 8¹/₂.</p>
Paper weight	52–105 g/m ² (14 lb. Bond–28 lb. Index)
Stack capacity (80 g/m ² , 20 lb. Bond)	<ul style="list-style-type: none"> A4, 8¹/₂ × 11 or smaller: 250 sheets B4 JIS, 8¹/₂ × 14 or larger: 50 sheets

The finisher shift tray

Paper sizes	<p>Standard size:</p> <p>A3, B4 JIS, A4, B5 JIS, A5, B6 JIS, A6, 12 × 18, 11 × 17, 11 × 15, 10 × 14, 8¹/₂ × 14, 8¹/₂ × 13, 8¹/₂ × 11, 8¹/₄ × 14, 8¹/₄ × 13, 8 × 13,</p> <p>8 × 10, 5¹/₂ × 8¹/₂, 7¹/₄ × 10¹/₂, 8K, 16K</p> <p>Custom size:</p> <ul style="list-style-type: none"> Vertical: 100.0–305.0 mm (3.94–12.00 inches) Horizontal: 148.0–600.0 mm (5.83–23.62 inches)
Paper weight	52–256 g/m ² (14 lb. Bond–140 lb. Index)

<p>Paper sizes that can be shifted when delivered to the finisher shift tray</p>	<p>Standard size: A3, A4, A5, B4 JIS, B5 JIS, 12 × 18, 11 × 17, 11 × 15, 10 × 14, 8 1/2 × 14, 8 1/2 × 13, 8 1/2 × 11, 8 1/4 × 14, 8 1/4 × 13, 8 × 13, 8 × 10, 7 1/4 × 10 1/2, 8K, 16K</p> <p>Custom size:</p> <ul style="list-style-type: none"> Vertical: 148.0–305.0 mm (5.83–12.00 inches) Horizontal: 148.0–600.0 mm (5.83–23.62 inches)
<p>Paper weight that can be shifted when delivered to the finisher shift tray</p>	<p>60–105 g/m² (16–28 lb. Bond)</p>
<p>Stack capacity (80 g/m², 20 lb. Bond)</p>	<ul style="list-style-type: none"> 3,000 sheets: A4, 8 1/2 × 11 1,500 sheets: A3, B4 JIS, A4, B5 JIS, 12 × 18, 11 × 17, 8 1/2 × 14, 8 1/2 × 11 500 sheets: A5 100 sheets: A5, B6 JIS, A6, 5 1/2 × 8 1/2

Stapling

<p>Paper sizes</p>	<p>A3, B4 JIS, A4, B5 JIS, 12 × 18, 11 × 17, 11 × 15, 10 × 14, 8 1/2 × 14, 8 1/2 × 11, 7 1/4 × 10 1/2, 8 × 13, 8 1/2 × 13, 8 1/4 × 14, 8 1/4 × 13, 8 × 10, 8K, 16K</p>
<p>Paper weight</p>	<p>75–81 g/m² (20 lb. Bond)</p>
<p>Staple capacity (80 g/m², 20 lb. Bond)</p>	<p>Without Mixed Size:</p> <ul style="list-style-type: none"> 30 sheets: A3, B4 JIS, 11 × 17, 8 1/2 × 14, 8 × 13, 8 1/2 × 13, 8 1/4 × 14, 8 1/4 × 13, 11 × 15, 10 × 14, 8K 50 sheets: A4, B5 JIS, 8 1/2 × 11, 8 × 10, 7 1/4 × 10 1/2, 16K <p>With Mixed Size:</p> <ul style="list-style-type: none"> 30 sheets (A3/A4, B4 JIS/B5 JIS, 11 × 17/8 1/2 × 11)

Stack capacity after stapling (80 g/m ² , 20 lb. Bond)	<p>Without Mixed Size:</p> <ul style="list-style-type: none"> • 2–19 sheets: 150 sets (A4☐, 8¹/₂ × 11☐) • 20–50 sheets: 150–60 sets (A4☐, 8¹/₂ × 11☐) • 2–14 sheets: 100 sets (A4☐, B5 JIS☐☐, 8¹/₂ × 11☐) • 15–50 sheets: 100–30 sets (A4☐, B5 JIS☐☐, 8¹/₂ × 11☐) • 2–14 sheets: 100 sets (other size paper) • 15–30 sheets: 100–33 sets (other size paper) <p>With Mixed Size:</p> <ul style="list-style-type: none"> • 2–30 sheets: 50 sets (A3☐/A4☐, B4 JIS☐/ B5 JIS☐, 11 × 17☐/8¹/₂ × 11☐)
---	---

Punch unit

Paper sizes for 2 & 4 holes type: 2 holes	<p>Standard size:</p> <p>☐: A3, B4 JIS, A4, B5 JIS, A5, 11 × 17, 8¹/₂ × 14, 8¹/₂ × 11, 5¹/₂ × 8¹/₂, 7¹/₄ × 10¹/₂, 8 × 13, 8¹/₂ × 13, 8¹/₄ × 13, 8K, 16K, 8¹/₄ × 14, 8 × 10, 11 × 15, 10 × 14</p> <p>☐: A4, B5 JIS, A5, 8¹/₂ × 11, 7¹/₄ × 10¹/₂, 16K</p> <p>Custom size:</p> <ul style="list-style-type: none"> • Vertical: 100.0–305.0 mm (3.94–12.00 inches) • Horizontal: 148.0–600.0 mm (5.83–23.62 inches)
Paper sizes for 2 & 4 holes type: 4 holes	<p>Standard size:</p> <p>☐: A3, B4 JIS, 11 × 17, 11 × 15, 8K</p> <p>☐: A4, B5 JIS, 8¹/₂ × 11, 7¹/₄ × 10¹/₂, 16K</p> <p>Custom size:</p> <ul style="list-style-type: none"> • Vertical: 255.0–305.0 mm (10.04–12.00 inches) • Horizontal: 148.0–600.0 mm (5.83–23.62 inches)

Paper sizes for 4 holes type: 4 holes	<p>Standard size:</p> <p>☐: A3, B4 JIS, A4, B5 JIS, A5, 11 × 17, 8¹/₂ × 14, 8¹/₂ × 11, 5¹/₂ × 8¹/₂, 7¹/₄ × 10¹/₂, 8 × 13, 8¹/₂ × 13, 8¹/₄ × 13, 8K, 16K, 8¹/₄ × 14, 8 × 10, 11 × 15, 10 × 14</p> <p>☐: A4, B5 JIS, A5, 8¹/₂ × 11, 7¹/₄ × 10¹/₂, 16K</p> <p>Custom size:</p> <ul style="list-style-type: none"> • Vertical: 125.0–305.0 mm (4.93–12.00 inches) • Horizontal: 148.0–600.0 mm (5.83–23.62 inches)
Paper sizes for 2 & 3 holes type: 2 holes	<p>Standard size:</p> <p>☐: A3, B4 JIS, B5 JIS, A5, 11 × 17, 8¹/₂ × 14, 8¹/₂ × 11, 5¹/₂ × 8¹/₂, 7¹/₄ × 10¹/₂, 8 × 13, 8¹/₂ × 13, 8¹/₄ × 13, 8K, 16K, 8¹/₄ × 14, 8 × 10, 11 × 15, 10 × 14</p> <p>☐: A4, B5 JIS, A5, 8¹/₂ × 11, 7¹/₄ × 10¹/₂, 16K</p> <p>Custom size:</p> <ul style="list-style-type: none"> • Vertical: 100.0–305.0 mm (3.94–12.00 inches) • Horizontal: 148.0–600.0 mm (5.83–23.62 inches)
Paper sizes for 2 & 3 holes type: 3 holes	<p>Standard size:</p> <p>☐: A3, B4 JIS, 11 × 17, 11 × 15, 10 × 14, 8K</p> <p>☐: A4, B5 JIS, 8¹/₂ × 11, 7¹/₄ × 10¹/₂, 16K</p> <p>Custom size:</p> <ul style="list-style-type: none"> • Vertical: 230.0–305.0 mm (9.06–12.00 inches) • Horizontal: 148.0–600.0 mm (5.83–23.62 inches)
Paper weight	52–163 g/m ² (14 lb. Bond–90 lb. Index)

Notes about Paper Thickness

The following tables define the paper weight for the paper thickness menu on the control panel.

Paper thickness ^{*1}	Paper weight
Thin Paper ^{*2}	52–59 g/m ² (14–15 lb. Bond)
Plain Paper 1	60–74 g/m ² (16–20 lb. Bond)

Paper thickness ^{*1}	Paper weight
Plain Paper 2	75–81 g/m ² (20 lb. Bond)
Middle Thick	82–105 g/m ² (20–28 lb. Bond)
Thick Paper 1	106–169 g/m ² (28 lb. Bond–90 lb. Index)
Thick Paper 2	170–220 g/m ² (65–80 lb. Cover)
Thick Paper 3	221–256 g/m ² (80 lb. Cover–140 lb. Index)
Thick Paper 4	257–300 g/m ² (140 lb. Index–110 lb. Cover)

^{*1} Print quality will decrease if the paper you are using is close to the minimum or maximum weight. Change the paper weight setting to thinner or thicker.

^{*2} Depending on the type of thin paper, the edges may crease or the paper may be misfed.

Paper thickness for each paper type

The following tables provide the default paper thickness for each paper type. The paper thickness depending on each paper type is displayed Tray Paper Settings in the [User Tools] menu. Configure the appropriate paper thickness for the loaded paper type.

For details how to specify the setting, see "Specifying a Paper Type", Operating Instructions.

Paper type	Default paper thickness
Plain Paper, Recycled Paper, Color Paper, Special Paper 1, Letterhead, Preprinted Paper, Bond Paper, Cardstock, Label Paper	Plain Paper 2
Coated Paper, Special Paper 2,	Thick Paper 1
Envelope, Special Paper 3	Thick Paper 2

If you select OHP (Transparency) or Coated Paper: Gloss Print for the paper type, "Paper Thickness" is not available.

Print Area

The following shows the recommended print area for this printer.

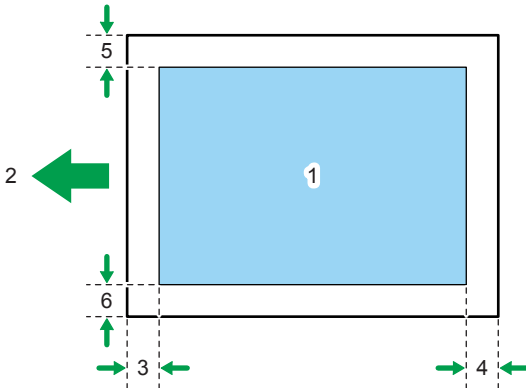

CLD001

1. Print area
2. Feed direction
3. 2.7 to 5.7 mm (0.11 to 0.23 inches)
4. 0.5 to 6.0 mm (0.02 to 0.24 inches)
5. 0.5 to 4.0 mm (0.02 to 0.16 inches)
6. 0.5 to 4.0 mm (0.02 to 0.16 inches)

Note

- The print area may vary depending on the paper size, printed language and printer driver settings.
- Depending on the printer driver settings, you may be able to print outside the recommended print area. However, the actual output may not be as desired, or a paper feed problem may occur.
- If [Edge to Edge Print] under [System] in [Printer Features] is enabled, the margins on the left, right, and bottom edges in relation to the feed direction will become 0 mm. For details about [Edge to Edge Print], see "System", Operating Instructions.

Loading Paper

This section explains how to load paper into the paper trays.

Precautions for Loading Paper

CAUTION

- When loading paper, take care not to trap or injure your fingers.

When loading paper, take care not to trap or injure your fingers.

Important

- Do not stack paper over the limit mark.

Note

- After changing the paper size, be sure to specify the appropriate paper size in the [Tray Paper Settings] menu. If you do not, misfeeds might occur. For details, see "Tray Paper Settings", Operating Instructions.
- To prevent multiple sheets from being fed at once, fan the paper before loading it.
- If you load paper when only a few sheets of paper remain in the tray, multiple sheet feeding may occur. Remove any remaining paper, stack them with the new sheets of paper, and then fan the entire stack before loading it into the tray.
- Straighten curled or warped paper before loading.
- For details about available paper sizes and types for each paper tray, see p.33 "Supported Paper for Each Input Tray".
- Depending on the environment where the printer is being used, you might at times hear a rustling noise from paper moving through the printer. This noise does not indicate a malfunction.

Unusable Paper

CAUTION

- Do not attempt to print on stapled sheets, aluminum foil, carbon paper, or any kind of conductive paper. Doing so risks fire.

Do not attempt to print on stapled sheets, aluminum foil, carbon paper, or any kind of conductive paper. Doing so risks fire.

Important

- To prevent faults, do not use any of the following kinds of treated paper:

- Paper for inkjet printers
- Thermal fax paper
- Art paper
- Aluminum foil
- Carbon paper
- Conductive paper
- Paper with perforated lines
- Hemmed-edge paper
- Window envelopes
- Faults can occur if you print onto sides that are already printed. Take care to print onto unprinted sides only.
- Certain types of OHP transparencies for color printing cannot be used. For details about types that can be used, contact your sales or service representative.

Note

- To prevent misfeeds, do not use the following kinds of paper:
 - Bent, folded, or creased paper
 - Perforated paper
 - Slippery paper
 - Torn paper
 - Rough paper
 - Thin paper with little stiffness
 - Paper with a dusty surface
- Even supported types of paper may cause paper jams or malfunctions if the paper is not in good condition. (Sheets can become jammed if they have been improperly stored.)
- If you print onto rough grain paper, the output image might be blurred.
- Do not load sheets that have already been printed by another printer.

Paper Storage

When storing paper, the following precautions should always be followed:

- Do not store paper where it will be exposed to direct sunlight.
- Avoid storing paper in humid areas (humidity: 70% or less).
- Store on a flat surface.
- Do not store paper vertically.

- Once opened, store paper in plastic bags.

Loading Paper into Paper Trays

In the following example procedure, paper is loaded into Tray 2.

★ Important

- Check the paper edges are aligned at the right side.
- Slide the side fences until they are aligned with the sides of the paper, and then re-lock the side fences. If there is space between the side fences and the paper, it may cause the image to be misaligned or thin paper may wrinkle.
- When loading a low number of sheets, be sure not to squeeze the side fences in too tightly. If the side fences are squeezed too tightly against the paper, the edges may crease, thin paper may wrinkle, or the paper may be misfed.
- If a paper tray is pushed vigorously when putting it back into place, the position of the tray's side fences may slip out of place.

1. Carefully pull out the paper tray until it stops.

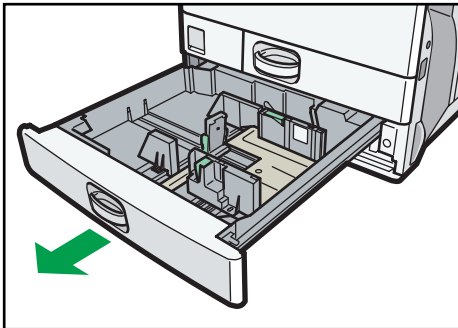

CQT038

2. Release the lock on the side fences.

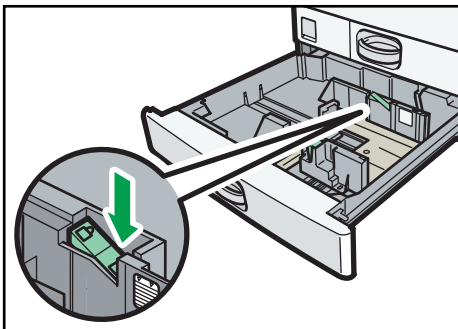

CQT041

3. While pressing down the release lever, slide the side fences outward.

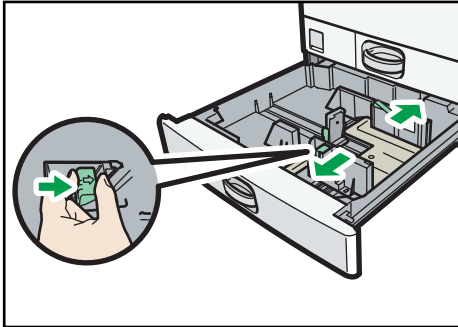

CQT042

4. Slide the end fence outward.

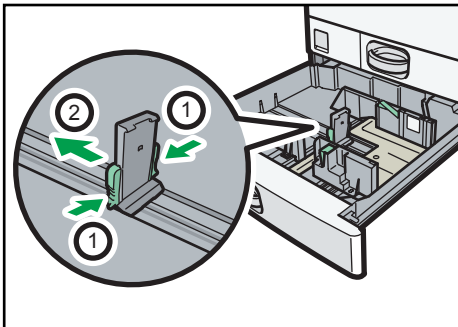

CQT043

1. Pinch the release levers of the end fence.
2. Slide the end fence outward.

5. Square the paper and load it print side up.

Do not stack paper over the limit mark.

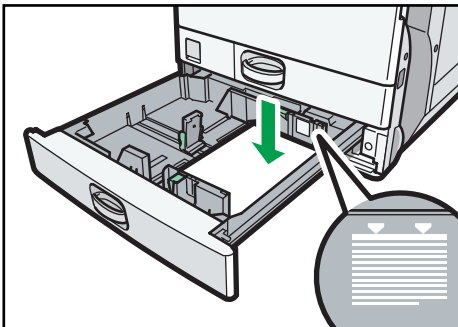

CQT044

- Align the back and side fences gently against the paper you loaded.

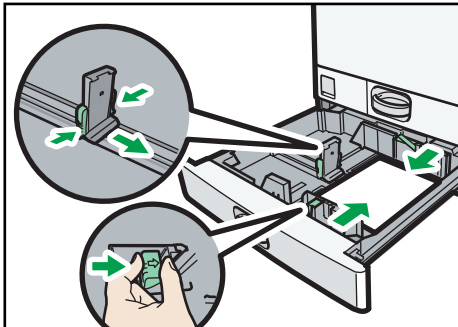

CQT045

- Re-lock the side fences.
- Carefully push the paper tray fully in.
- Check the paper size on the display.

↓ Note

- You can load envelopes in Trays 2–5. Envelopes must be loaded in a specific orientation. For details, see p.65 "Loading Envelopes".

Loading Paper into the Bypass Tray

Use the bypass tray to use OHP transparencies, adhesive labels, translucent paper, and paper that cannot be loaded in the paper trays.

★ Important

- The maximum number of sheets you can load at the same time depends on paper type. Load only as much paper as can be held between the paper guides on the bypass tray. For the maximum number of sheets you can load, see p.33 "Supported Paper for Each Input Tray".

- Open the bypass tray.

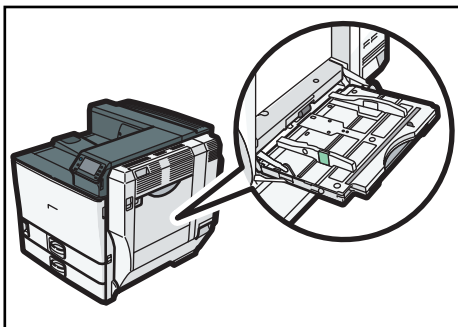

CQT037

- Insert the paper face down until you hear the beep.

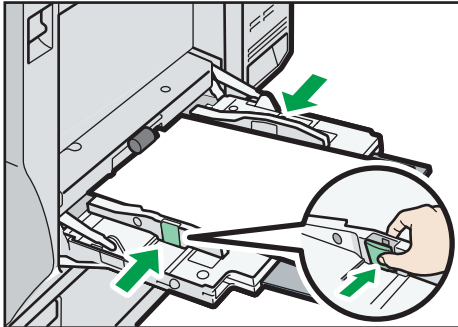

3. While pressing down the release lever, align the paper guides to the paper size.

If the guides are not flush against the paper, images might be skewed or paper misfeeds might occur.



CJW014

↓ Note

- When using the bypass tray, it is recommended that you set the paper direction to .
- Certain types of paper might not be detected properly when placed on the bypass tray. If this happens, remove the paper and place it on the bypass tray again.
- Pull the bypass tray extension out when loading sheets larger than A4 , 8 1/2 × 11  in the bypass tray.
- When the [Panel Key Sound] is turned off, it does not sound if you insert paper into the bypass tray. For details about [Panel Key Sound], see "General Features", Operating Instructions.
- If the printer stops detecting paper sizes while printing, remove the paper and reload it.
- Letterhead paper must be loaded in a specific orientation. For details, see p.57 "Loading Orientation-Fixed Paper or Two-Sided Paper".
- You can load envelopes into the bypass tray. Envelopes must be loaded in a specific orientation. For details, see p.65 "Loading Envelopes".

Loading Paper into Tray 3 (LCT)

★ Important

- When paper loaded in the right side of Tray 3 (LCT) runs out, paper on the left is automatically shifted to the right. Do not pull out Tray 3 (LCT) while the tray is moving paper; wait until sounds stop coming from the tray.
- For the right stack, align the right edge of the paper with the right edge of the tray. For the left stack, align the left edge of the paper to the left edge of the tray.

1. Carefully pull out Tray 3 (LCT) until it stops.

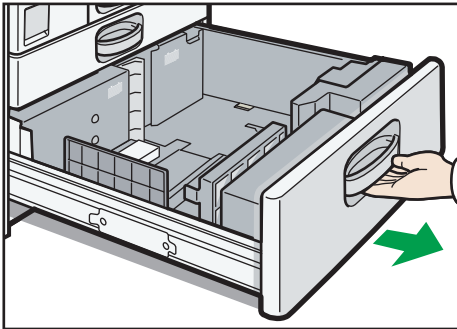

CJW015

2. Square the paper and load it print side up.

Do not stack paper over the limit mark.

- Whole tray pulled out

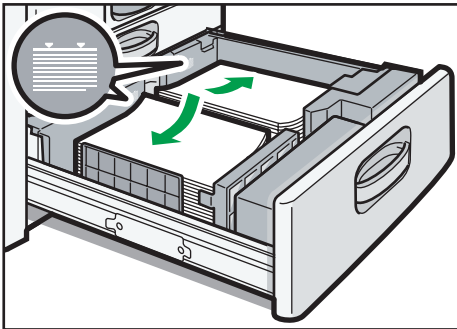

CJW016

- Left half of the tray pulled out

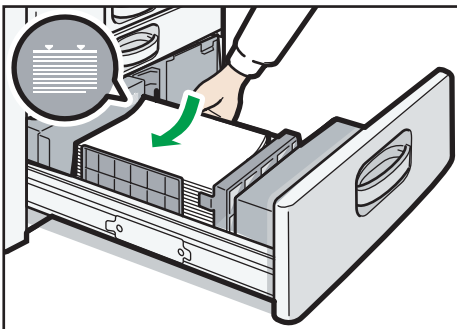

CJW017

3. Carefully push the paper tray fully in.

Note

- You can load paper even if Tray 3 (LCT) is in use. It is okay to pull out the left half of the tray while Tray 3 (LCT) is in use.

Loading Paper into the Large Capacity Tray (LCT)

1. Open the right cover of the large capacity tray (LCT).

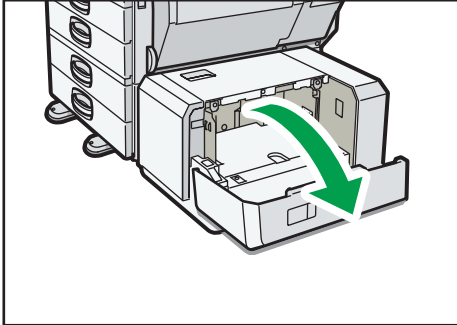

CJW018

2. Load paper into the paper tray with the print side down and place it against the left side of the tray.

Do not stack paper over the limit mark.

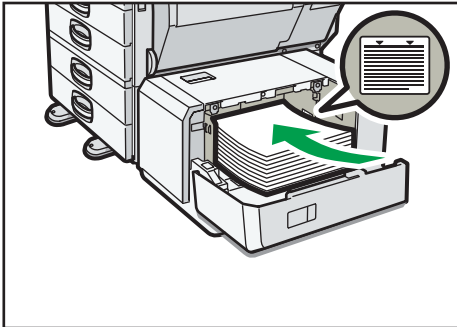

CJW019

3. Press the [Down] key.

The bottom plate moves down.

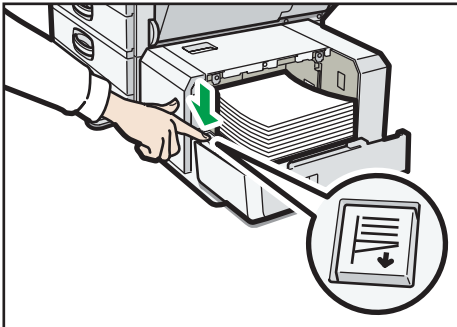

CJW020

4. Load additional paper by repeating steps 2 and 3.
5. Close the right cover of the large capacity tray (LCT).

Loading Orientation-Fixed Paper or Two-Sided Paper

Orientation-fixed (top to bottom) or two-sided paper (for example, letterhead paper, punched paper, or copied paper) might not print correctly, depending on how the paper is placed.



Settings for User Tools













Specify [Auto Detect] or [On (Always)] for [Letterhead Setting] in [System] under the Printer Features menu, and then place the paper as shown below.

For details about the letterhead settings, see "System", Operating Instructions.

Paper orientation

The meanings of the icons are as follows:

Icon	Meaning
	Place or load paper printed side face up.
	Place or load paper printed side face down.

Print side	Tray 1 or Tray 3 (LCT)	Trays 2–5	Large capacity tray (LCT)	Bypass tray
One-sided		 		 
Two-sided		 		 

Note

- To print on letterhead paper when [Auto Detect] is specified for [Letterhead Setting], you must specify [Letterhead] as the paper type in the printer driver's settings.

- If a print job is changed partway through printing from one-sided to two-sided printing, one-sided output after the first copy may be printed facing a different direction. To ensure all paper is output facing the same direction, specify different input trays for one-sided and two-sided printing. Note also that two-sided printing must be disabled for the tray specified for one-sided printing.
- For details about how to make two-sided prints, see p.62 "Printing on Both Sides of Sheets".

Standard Printing

Printing with Windows (PCL 6/PostScript 3)

★ Important

- The default setting is duplex printing. If you want to print on only one side, select [Off] for the duplex setting.
- If you send a print job via USB 2.0 while the printer is in Low Power mode or Sleep mode, an error message might appear when the print job is complete. In this case, check if the document was printed.

1. After creating a document, open the [Printing Preferences] dialog box in the document's native application.

For details about displaying the [Printing Preferences] dialog box, see p.30 "Displaying the Printing Preferences dialog box in an application".

2. In the "Job Type:" list, select [Normal Print].
3. In the "Document Size:" list, select the size of the document to be printed.
4. In the "Orientation:" list, select [Portrait] or [Landscape] for the orientation of the document.
5. In the "Input Tray:" list, select the paper tray that contains the paper to which you want to print.

If you select [Auto Tray Select] in the "Input Tray:" list, the paper tray is automatically selected according to the paper size and type specified.

6. In the "Paper Type:" list, select the type of paper that is loaded in the paper tray.
7. Select [Color] or [Black and White] in the "Color/ Black and White:" list.

Select [Color] for color printing.

Select [Black and White] for black-and-white printing.

8. To print multiple copies, specify the number of sets in the "Copies:" box.
9. Change any other print settings as necessary.

You can set convenient print functions on the [Detailed Settings] tab. For details, see "Convenient Print Functions", Operating Instructions.

10. Click [OK].
11. Start printing from the application's [Print] dialog box.

↓ Note

- If [Color] is selected in the "Color/ Black and White:" list, you can print using special color outputs suitable for color vision impaired users. To use this function, click the [Detailed Settings] tab. Click

the [Print Quality] menu in the "Menu:" box, and then select [On] in the "Barrier-free Color Management:" list.

Black and White printing precautions

Some applications may recognize grayscale or a black-and-white area of a document as a color image. Because of this, it may be printed in four colors (CMYK) and counted on the billing counter as such. To ensure that documents are printed in black and white, select [User Setting] in the "Settings for Image:" list on the [Print Quality] menu, and then select [K (Black)] in the "Gray Reproduction:" list. For details, see the printer driver Help.

Printing with Windows (PCL 5c/5e)

★ Important

- The default setting is duplex printing. If you want to print on only one side, select [Off] for the duplex setting.
 - If you send a print job via USB 2.0 while the printer is in Low Power mode or Sleep mode, an error message might appear when the print job is complete. In this case, check if the document was printed.
1. After creating a document, open the [Printing Preferences] dialog box in the document's native application.
For details about displaying the [Printing Preferences] dialog box, see p.30 "Displaying the Printing Preferences dialog box in an application".
 2. In the "Job Type:" list, select [Normal Print].
 3. To print multiple copies, specify the number of sets in the "Copies:" box.
 4. In the "Orientation:" list, select [Portrait] or [Landscape] for the orientation of the document.
 5. Select [Color] or [Black and White] in the "Color/ Black and White:" list.
Select [Color] for color printing.
Select [Black and White] for black and white printing.
 6. Click the [Paper] tab.
 7. In the "Document Size:" list, select the size of the document to be printed.
 8. In the "Input Tray:" list, select the paper tray that contains the paper to which you want to print.
If you select [Auto Tray Select] in the "Input Tray:" list, the paper tray is automatically selected according to the paper size and type specified.
 9. In the "Type:" list, select the type of paper that is loaded in the paper tray.

10. Change any other print settings as necessary.

You can set convenient print functions on the tabs of the printer driver. For details, see "Convenient Print Functions", Operating Instructions.

11. Click [OK].**12. Start printing from the application's [Print] dialog box.**

Printing with Mac OS X

Follow the procedure below to print using the PostScript 3 printer driver for Mac OS X.

1. After creating a document, open the printing preferences screen in the document's native application.

For details about displaying the printing preferences screen, see p.32 "Displaying the printing preferences screen from an application"

2. In the "Paper Size:" menu, select the size of the document to be printed.**3. In the "Orientation:" menu, select the orientation of the document.****4. Select [Paper Feed] in the pop-up menu.****5. Select the paper tray that contains the paper to which you want to print.**

If you select [Auto Select], the paper tray is automatically selected according to the paper size and type specified.

6. Select [Printer Features] in the pop-up menu.**7. In the "Feature Sets:" menu, select the appropriate set of features to display the "Paper Type:" menu.****8. In the "Paper Type:" menu, select the type of paper that is loaded in the paper tray.****9. In the "Feature Sets:" menu, select the appropriate set of features to display the "Color Mode:" menu.****10. In the "Color Mode:" menu, select the color mode for the print job.**

Select [Color] for color printing.

Select [Black and White] for black and white printing.

11. To print multiple copies, specify the number of sets in the "Copies:" box.**12. Select the [Collated] check box.**

For some versions of Mac OS X, select [Paper Handling] or [Copies & Pages] in the pop-up menu, and then select the [Collate:] check box.

13. Change any other print settings as necessary.

You can set convenient print functions in the pop-up menus of the printer driver. For details, see "Convenient Print Functions", Operating Instructions.

14. Start printing.

↓ Note





- For details about collate function, see "Collate", Operating Instructions.
- If the application has its own collate function, disable the function to use the collate function on this printer.

Printing on Both Sides of Sheets

This section explains how to print on both sides of each page using the printer driver.

Types of duplex printing

You can select which way the bound pages open by specifying which edge to bind.

Orientation	Open to Left	Open to Top
Portrait		
Landscape		

Duplex printing precautions

- The types of paper that can be printed on both sides are as follows:
Plain (60 to 81 g/m²), Recycled, Special 1, Special 2, Special 3, Middle Thick (82 to 105 g/m²), Thick 1 (106 to 169 g/m²), Thin (52 to 59 g/m²), Color, Letterhead, Preprinted, Bond, Cardstock
- If the document contains pages with different original sizes, page breaks may occur.

↓ Note

- For details about setting the duplex printing function using the PCL 6 printer driver or PostScript 3 printer driver for Windows, see "Edit", Operating Instructions.
- For details about setting the duplex printing function using the PCL 5c/5e printer driver, see "Setup", Operating Instructions.
- For details about setting the duplex printing function using the PostScript 3 printer driver for Mac OS X, see "Layout", Operating Instructions.

Combining Multiple Pages into Single Page

This section explains how to print multiple pages onto a single sheet. The combine printing function allows you to economize on paper by printing multiple sheets at reduced size onto a single sheet.

Types of combine printing



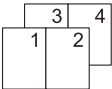
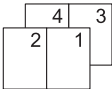
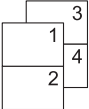
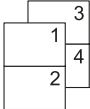

This function allows you to print 2, 4, 6, 9, or 16 pages at reduced size onto a single sheet and to specify a page ordering pattern for the combination. When combining 4 or more pages onto a single sheet of paper, four patterns are available.

The following illustrations show example page ordering patterns for 2- and 4-page combinations.

- 2 Pages per Sheet

Orientation	From Left to Right/Top to Bottom	From Right to Left/Top to Bottom
Portrait		
Landscape		

- 4 Pages per Sheet

Right, then Down	Down, then Right	Left, then Down	Down, then Left
			

Combine printing precautions

- If the document contains pages with different original sizes, page breaks may occur.
- If the application you are using also has a combine function, disable it. If the application's combine function is also enabled when the driver's combine function enabled, incorrect printing may occur.
- By combining the combine printing and booklet printing functions, you can print multiple pages onto a single sheet and bind them to form a booklet. For details about booklet printing, see "Booklet Printing", Operating Instructions.

↓ Note

- For details about setting the combine printing function using the PCL 6 printer driver or PostScript 3 printer driver for Windows, see "Edit", Operating Instructions.

- For details about setting the combine printing function using the PCL 5c/5e printer driver, see "Setup", Operating Instructions.
- For details about setting the combine printing function using the PostScript 3 printer driver for Mac OS X, see "Layout", Operating Instructions.

Printing on Envelopes

Loading Envelopes

This section gives you various details about and recommendations concerning envelopes.

★ Important

- Do not use window envelopes.
- Fan the envelopes before loading them to separate them and prevent the glue on them from causing them to stick together. If fanning does not prevent them sticking together, load them one by one. Note that some types of envelopes cannot be used with this printer.
- Misfeeds might occur depending on the length and shape of the flaps.
- Only envelopes that are at least 148 mm (5.9 inches) wide and whose flaps are open can be loaded in the □ orientation.
- When loading envelopes in the □ orientation, load them with flaps fully open. Otherwise, they might not feed into the printer.
- Before loading envelopes, press down on them to remove any air from inside, flatten out all four edges. If they are bent or curled, flatten their leading edges (the edge going into the printer) by running a pencil or ruler across them.

The method for loading envelopes varies depending on the orientation of the envelopes. Be sure to load envelopes with the correct orientation.

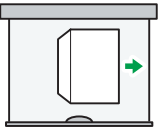
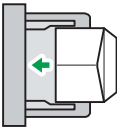
Types of envelopes	Paper trays 2–5	Bypass tray
<p>Side-opening envelopes □</p> 	 <ul style="list-style-type: none"> • Flaps: open • Bottom side of envelopes: toward the right of the printer • Side to be printed: face up 	 <ul style="list-style-type: none"> • Flaps: open • Bottom side of envelopes: toward the left of the printer • Side to be printed: face down

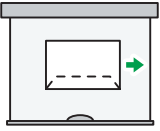
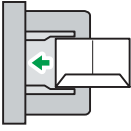
Types of envelopes	Paper trays 2–5	Bypass tray
Side-opening envelopes 	* 1  <ul style="list-style-type: none"> • Flaps: closed • Bottom side of envelopes: toward the back of the printer • Side to be printed: face up 	 <ul style="list-style-type: none"> • Flaps: closed • Bottom side of envelopes: toward the back of the printer • Side to be printed: face down

* 1 You cannot load side-opening envelopes in the landscape orientation in Trays 2–4.

When loading envelopes, use both User Tools and the printer driver to select "Envelope" as the paper type and specify the thickness of the envelopes. For details, see p.65 "Printing on Envelopes", Printer.

To print on envelopes that are loaded with their short edges against the printer body, rotate the print image by 180 degrees using the printer driver.

Recommended envelopes

For information about recommended envelopes, contact your local dealer.

The size of envelopes that you can load depends on the tray in which you load them. For details, see p.33 "Supported Paper for Each Input Tray".

Note

- Load only one size and type of envelope at a time.
- The Duplex function cannot be used with envelopes.
- To achieve better output quality, it is recommended that you set the right, left, top, and bottom print margin to at least 15 mm (0.6 inches) each.
- The output quality on envelopes may be uneven if parts of an envelope have differing thicknesses. Print one or two envelopes to check the print quality.
- When printing onto envelopes, the print speed is slower than usual.
- Printed sheets are delivered to the internal tray even if you specified a different tray.
- Flatten out prints if they are creased or curled.
- Check that the envelopes are not damp.
- High temperature and high humidity conditions can reduce print quality and cause envelopes to become creased.
- Depending on the environment, printing on envelopes may wrinkle them even if they are recommended.

- Certain types of envelopes might be output creased, dirtied, or misprinted. If you are printing a solid color on an envelope, lines may appear where the overlapped edges of the envelope make it thicker.

Printing on Envelopes with Windows (PCL 6/PostScript 3)

1. After creating a document, open the [Printing Preferences] dialog box in the document's native application.

For details about displaying the [Printing Preferences] dialog box, see p.30 "Displaying the Printing Preferences dialog box in an application".

2. In the "Input Tray:" list, select the paper tray where the envelopes are loaded.
3. In the "Document Size:" list, select the envelope size.
4. In the "Paper Type:" list, select [Envelope].
5. Change any other print settings as necessary. For details, see the printer driver Help.
6. Click [OK].
7. Start printing from the application's [Print] dialog box.

Note

- Configure the paper settings appropriately using both the printer driver and the control panel. For details about settings using the control panel, see "Configuring envelope settings using the control panel", Operating Instructions.
- Envelopes must be loaded in a specific orientation. For details, see p.65 "Loading Envelopes".

Printing on Envelopes with Windows (PCL 5c/5e)

1. After creating a document, open the [Printing Preferences] dialog box in the document's native application.

For details about displaying the [Printing Preferences] dialog box, see p.30 "Displaying the Printing Preferences dialog box in an application".

2. Click the [Paper] tab.
3. In the "Input Tray:" list, select the paper tray where the envelopes are loaded.
4. In the "Document Size:" list, select the envelope size.
5. In the "Type:" list, select [Envelope].
6. Change any other print settings as necessary. For details, see the printer driver Help.
7. Click [OK].
8. Start printing from the application's [Print] dialog box.

Note

- Configure the paper settings appropriately using both the printer driver and the control panel. For details about settings using the control panel, see "Configuring envelope settings using the control panel", Operating Instructions.
- Envelopes must be loaded in a specific orientation. For details, see p.65 "Loading Envelopes".

Printing on Envelopes with Mac OS X

1. **After creating a document, open the printing preferences screen in the document's native application.**

For details about displaying the printing preferences screen, see p.30 "Displaying the Printing Preferences dialog box in an application".

2. **Clear the [Two-Sided:] check box to disable duplex printing.**
3. **In the "Paper Size:" menu, select the envelope size.**
4. **In the "Orientation:" menu, select the orientation of the envelope.**
5. **Select [Paper Feed] in the pop-up menu.**
6. **Select the paper tray where the envelopes are loaded.**
7. **Select [Printer Features] in the pop-up menu.**
8. **In the "Feature Sets:" menu, select the appropriate set of features to display the "Paper Type:" menu.**
9. **In the "Paper Type:" menu, select [Envelope].**
10. **Change any other print settings as necessary.**
11. **Start printing.**

Note

- Configure the paper settings appropriately using both the printer driver and the control panel. For details about settings using the control panel, see "Configuring envelope settings using the control panel", Operating Instructions.
- Envelopes must be loaded in a specific orientation. For details, see p.65 "Loading Envelopes".

Storing a Document

Storing a Document with Windows

2

1. After creating a document, open the [Printing Preferences] dialog box in the document's native application.

For details about displaying the [Printing Preferences] dialog box, see p.30 "Displaying the Printing Preferences dialog box in an application".

2. In the "Job Type:" list, select a job type.

- Select [Sample Print] to store the document as a Sample Print file.
- Select [Locked Print] to store the document as a Locked Print file.
- Select [Hold Print] to store the document as a Hold Print file.
- Two options are available when storing a Stored Print file:

Select [Stored Print] to store the document in the printer and print it later using the control panel.

Select [Store and Print] to store and print the document at the same time.

3. Click [Details...].

4. Enter a User ID in the "User ID:" box.

- When storing a Locked Print file, enter a password in the "Password:" box.
- When storing a Hold Print file, specify a file name and print time as necessary.

To specify the time when the document is printed, select the [Set Print Time] check box, and then specify the time.

- When storing a Stored Print file, specify a file name and password as necessary.

5. Click [OK].

6. Change any other print settings as necessary.

7. Click [OK].

8. Start printing from the application's [Print] dialog box.

Note

- The printer might not print a Hold Print file at the specified time under the following conditions:
 - When the specified print time is close to the time in the printer's built-in clock, printing may start immediately.
 - When the main power of the printer is turned off, printing will not start even if it is the specified print time. To print a document whose specified time has already passed, set [Jobs Not Printed As Machn. Was Off] to [On] on [System] under [Printer Features]. For details, see "System", Operating Instructions.

- If an error message is displayed on the control panel, printing will not start even if it is the specified print time.
- If [Stored Print (Shared)] or [Store and Print (Shared)] is selected when a Stored Print file is stored, the user who created the document and all users who have print privileges can print the document using the control panel. This setting is available when User Authentication is enabled using the PCL 6 printer driver. For details, see Security Guide.

Storing a Document with Mac OS X

1. After creating a document, open the printing preferences screen in the document's native application.

For details about displaying the printing preferences screen, see p.32 "Displaying the printing preferences screen from an application".

2. Select [Job Log] in the pop-up menu.

3. Enter the user ID in the "User ID:" box using up to eight alphanumeric characters.

4. In the "Job Type:" pop-up menu, select a job type.

- Select [Sample Print] to store the document as a Sample Print file.
- Select [Locked Print] to store the document as a Locked Print file, and then enter the password in the "Password:" box.

Use four to eight digits for the password.

- Select [Hold Print] to store the document as a Hold Print file.

You can add a name to the document using up to 16 alphanumeric characters.

To print a document on the specified time, select the [Set Print Time] check box.

- Two options are available when storing a Stored Print file:

Select [Stored Print] to store the document in the printer and print it later using the control panel.

Select [Store and Print] to store and print the document at the same time.

You can add a name to the document using up to 16 alphanumeric characters.

You can set a password for the document using four to eight digits.

5. Change any other print settings as necessary.

6. Start printing.

↓ Note

- The printer may not print a Hold Print file at the specified time under the following conditions:
 - When the specified print time is close to the time in the printer's built-in clock, printing may start immediately.









- When the main power of the printer is turned off, printing will not start even if it is the specified print time. To print a document whose specified time has already passed, set [Jobs Not Printed As Machn. Was Off] to [On] on [System] under [Printer Features]. For details, see "System", Operating Instructions.
- If an error message is displayed on the control panel, printing will not start even if it is the specified print time.

3. Troubleshooting

This chapter provides solutions to common problems and it also explains how to correct unwanted print results.

When Indicators Are Displayed

This section describes the indicators that appear when the printer requires user attention such as removing misfed paper, reloading paper, or performing other procedures.

Indicator	Status
 : Paper Misfeed indicator	Appears when a paper misfeed occurs. For details about removing jammed paper, see p.122 "Removing Jammed Paper".
 : Load Paper indicator	Appears when paper runs out. For details about loading paper, see p.49 "Loading Paper".
 : Add Toner indicator	Appears when toner runs out. For details about adding toner, see p.135 "Adding Toner".
 : Add Staple indicator	Appears when staples run out. For details about adding staples, see p.140 "Adding Staples".
 : Waste Toner Full indicator	Appears when the waste toner bottle is full. For details about replacing the waste toner bottle, see p.138 "Replacing Other Consumables".
 : Empty Hole Punch Receptacle indicator	Appears when the hole punch receptacle is full. For details about removing punch waste, see p.133 "Removing Punch Waste".
 : Service Call indicator	Appears when the printer is malfunctioning or requires maintenance.
 : Open Cover indicator	Appears when one or more covers of the printer are open.

When a Panel Tone Beeps

The following table describes various beep patterns that the printer produces to alert users about printer conditions and the meaning of each beep pattern.

Beep pattern	Meaning	Causes
Single short beep	Panel/screen input accepted.	A control panel or screen key was pressed.
Short, then long beep	Panel/screen input rejected.	An invalid key was pressed on the control panel or screen, or the entered password was incorrect.
Two long beeps	Printer has warmed up.	When the power is turned on or the printer exits Sleep mode, the printer has fully warmed up and is ready for use.
Five long beeps repeated four times.	Soft alert	An error message appears on the control panel if there is no tray for the selected paper size or the tray is empty.
Five short beeps repeated five times.	Strong alert	Paper has jammed, the toner needs replenishing, or other problems have occurred.

Note

- The beep alerts cannot be muted. If the printer's covers are opened and closed repeatedly within a short space of time during an alert indicating a paper jam or insufficient toner, the beep alert might continue, even after normal status has resumed.
- You can enable or disable beep alerts. For details about Panel Key Sound, see "General Features", Operating Instructions.

Checking Printer Status and Settings

Maintnc. Info

You can check the following items under [Maintnc. Info]:

- **Remaining Toner**
Displays the amount of remaining toner.
- **No Staples**
Displays whether there are staples remaining or not.
- **Punch Receptcl Full**
Displays whether the hole punch receptacle is full.
- **Paper Tray**
Displays the paper type and size loaded into the paper tray.
- **Output Tray Full**
Displays whether the output tray is overloaded.
- **Paper Misfeed**
Displays the state of and solutions for paper misfeeds.
- **Cover Open**
Indicates whether one or more covers of the printer are open.
- **Waste Tnr Bttl Full**
Displays whether the waste toner bottle is full.

Data Storage

You can check the following items under [Data Storage]:

- **HDD Remaining Mem.**
Displays the amount of available hard disk memory.
- **HDD File(s)**
Displays the total number of jobs stored on the hard disk.
- **Print Job(s)**
Displays the number of jobs for "Hold Print Job(s):", "Stored Print Job(s):", "Locked Print Job(s):", and "Sample Print Job(s):".

Machine Adres Info

You can check the following items under [Machine Adres Info]:

- **Machine IPv4 Address**
Displays the printer's IPv4 address.

- Machine IPv6 Address
Displays the printer's IPv6 address.

1. Press the [Check Status] key.

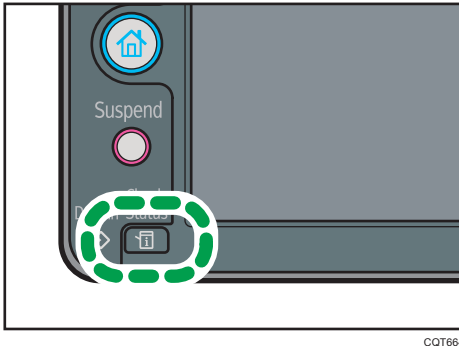

- 2. Press the [Maintnc/MacInfo] tab.**
- 3. Press each key, and then check the contents.**
- 4. After checking the information, press [Exit].**

↓ Note

- [Paper Misfeed], [No Staples], [Punch Receptacle Full], [Output Tray Full], and [Cover Open] appear on [Maintnc. Info] only when these errors occur.
- Depending on the security settings, [Machine Adres Info] might not be displayed.
- For details about how to locate and remove misfeeds, see p.122 "Removing Jammed Paper".

When an Indicator for the [Check Status] Key Is Lit

If an indicator for the [Check Status] key lights up, press the [Check Status] key to display the [Check Status] screen. Check the status of the printer in the [Check Status] screen.

[Check Status] screen

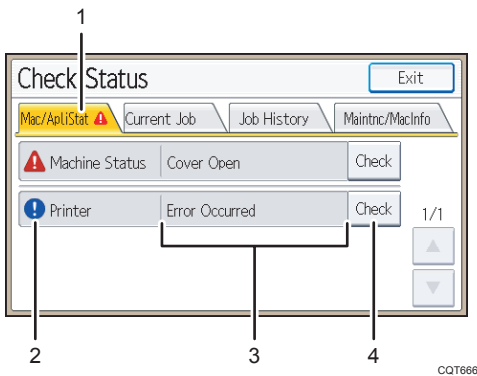

1. [Mac/AplStat] tab

Indicates the status of the printer.

2. Status icons

The icons that can be displayed are described below:

: The printer function is performing a job.

: An error has occurred on the printer.

: An error has occurred in the printer function being used, or the printer function cannot be used because an error has occurred on the printer.

3. Messages

Displays a message that indicates the status of the printer.

4. [Check]

If an error occurs, press [Check] to view details.

Pressing [Check] displays an error message or the printer screen. Check the error message displayed on the printer screen and take the appropriate action. For details about error messages and their solutions, see p. 91 "When Messages Are Displayed".

The following table describes problems that cause the indicator to light:

Problem	Cause	Solution
Documents and reports do not print out.	The paper output tray is full.	Remove the prints from the tray.

Problem	Cause	Solution
Documents and reports do not print out.	There is no paper left.	Load paper. For details about loading paper, see p.49 "Loading Paper".
An error has occurred.	A function that has the status "Error Occurred" in the [Check Status] screen is defective.	Press [Check], and then check the displayed message and take appropriate action. For details about error messages and their solutions, see p.91 "When Messages Are Displayed".
The printer is unable to connect to the network.	A network error has occurred.	<ul style="list-style-type: none"> • Press [Check], and then check the displayed message and take appropriate action. For details about error messages and their solutions, see p.91 "When Messages Are Displayed". • Check that the printer is correctly connected to the network and that the printer is correctly set. For details about how to connect the network, see "Interface Settings", Operating Instructions. • For details about connecting to the network, contact your administrator. • If the indicator is still lit even after trying to solve the problem as described here, contact your service representative.

When You Have Problems Operating the Printer

This section describes common problems and messages. If other messages appear, follow the instructions displayed.

Problem	Cause	Solution
The lamp remains lit and the printer does not enter Sleep mode even though the [Energy Saver] key was pressed.	<ul style="list-style-type: none"> The printer is communicating with external equipment. The hard disk is active. 	<ul style="list-style-type: none"> Check if the printer is communicating with external equipment. Wait a little longer.
The display is off.	The printer is in Low Power mode.	Touch the display panel or press one of the keys on the control panel to cancel Low Power mode.
The display is off.	The printer is in Sleep Mode.	Press the [Energy Saver] key or the [Check Status] key to cancel Sleep Mode.
Nothing happens when the [Check Status] key or the [Energy Saver] key is pressed.	The power switch is turned off.	Turn on the main power switch.
"Please wait." appears.	This message appears when you press the [Energy Saver] key.	Wait for a while. If the printer is not ready in five minutes, contact your service representative.
"Please wait." appears.	This message appears when the printer is warming up.	<ul style="list-style-type: none"> Wait until the message disappears. Do not turn off the power switch while the message is displayed. If the printer is not ready in five minutes, contact your service representative.

Problem	Cause	Solution
"Please wait." appears.	This message appears when you change the toner cartridge.	<ul style="list-style-type: none"> • Wait until the message disappears. Do not turn off the power switch while the message is displayed. • If the message does not disappear in five minutes, contact your service representative.
The machine unexpectedly enters standby mode.	ECO Night Sensor is enabled and the light sensor detected a low ambient light level.	Change the ECO Night Sensor settings. For details about ECO Night Sensor, see "Administrator Tools", Operating Instructions.
"Self checking..." appears.	The printer is performing image adjustment operations.	The printer may perform periodic maintenance during operations. The frequency and duration of maintenance depends on the humidity, temperature, and printing factors such as number of prints, paper size, and paper type. Wait for the printer to be ready.
The user code entry screen is displayed.	Users are restricted by User Code Authentication.	For details about how to log in when User Code Authentication is enabled, see p.23 "Logging in the Printer".
The Authentication screen appears.	Basic Authentication, Windows Authentication, LDAP Authentication or Integration Server Authentication is set.	Enter your Login User Name and Login Password. For details about the Authentication screen, see p.23 "Logging in the Printer".
"Authentication has failed." appears.	The entered Login User Name or Login Password is not correct.	For details about the correct Login User Name and Login Password, see Security Guide.
"Authentication has failed." appears.	The printer cannot perform authentication.	For details about authentication, see Security Guide.

Problem	Cause	Solution
"You do not have the privileges to use this function." continues to be displayed even though you have entered a valid user name.	The logged in user does not have permission for the selected function.	For details about how to set permissions, see Security Guide.
An error message remains, even if misfed paper is removed.	<ul style="list-style-type: none"> • When a misfeed message appears, it remains until you open and close the cover as required. • Paper is still jammed in the tray. 	Remove misfed paper, and then open and close the cover. For details about removing jammed paper, see p.122 "Removing Jammed Paper".
Print images are printed on the reverse side of the paper.	You may have loaded the paper incorrectly.	<ul style="list-style-type: none"> • Load paper into the paper tray or tray 3 (LCT) with the print side up. • Load paper into the Large capacity tray (LCT), or bypass tray with the print side down.
Misfeeds occur frequently.	The tray's side or end fences may not be set properly.	<ul style="list-style-type: none"> • Remove misfed paper. For details about removing jammed paper, see p.122 "Removing Jammed Paper". • Check that the side or end fences are set properly. Also, check that the side fences are locked. For details about setting the side and end fences, see p.49 "Loading Paper".

Problem	Cause	Solution
Misfeeds occur frequently.	Paper size setting is not correct.	<ul style="list-style-type: none"> Remove misfed paper. For details about removing jammed paper, see p.122 "Removing Jammed Paper". If you load a paper size that is not selected automatically, you must specify the paper size with the control panel. For details about specifying paper size with the control panel, see "Changing to a Size That Is Not Automatically Detected", Operating Instructions.
Misfeeds occur frequently.	There is a foreign object on the finisher tray.	<ul style="list-style-type: none"> Remove misfed paper. For details about removing jammed paper, see p.122 "Removing Jammed Paper". Do not place anything on the finisher tray.
Cannot print in duplex mode.	You have selected a paper tray that does not support duplex printing.	Change the setting for "Apply 2 sided" in [System Settings] to enable duplex printing for the paper tray. For details about setting "Apply 2 sided", see "Tray Paper Settings", Operating Instructions.
Cannot print in duplex mode.	You have selected a paper type that cannot be used for duplex printing.	In [Tray Paper Settings], select a paper type that can be used for duplex printing. For details about the paper types that can be used, see "Tray Paper Settings", Operating Instructions.
"Output tray is full. Remove paper." appears.	The output tray is full.	Remove paper from the output tray to resume printing. If paper is to be output to the finisher shift tray, press the [Suspend] key to suspend printing and prevent paper from falling off the tray, and then remove the paper. Press [Continue] on the display panel to resume printing.

Problem	Cause	Solution
"Turn main Power Switch off" appears.	The printer does not shut down normally when the main power switch is turned off and then immediately turned on.	Turn off the main power switch. Wait for ten seconds or more after the printer shuts down, and then turn it on again.
"Shutting down... Please wait. Main power will be turned off automatically." appears.	The shutdown procedure has begun because the main power switch was turned off while the printer was in standby mode or performing an operation.	Follow the message that appears and wait until the printer has shut down. Do not turn on the main power switch while this message is displayed. If the main power switch has been turned on, follow the message that appears. For details about turning the main power switch on and off, see p.27 "Turning On/Off the Power".
An error has occurred when the Address Book is changed from the display panel or Web Image Monitor.	The Address Book cannot be changed while deleting the multiple stored documents.	Wait a while, and then retry the operation.
"Internal cooling fan is active." appears, and the fan is running.	Large print runs will cause the printer's interior to heat up, triggering the cooling fan. The fan will automatically begin running when the print run reaches approximately 3,000 sheets of A4 [□] , or 1,500 sheets of A3 [□] . (Installation environment : 10 °C-32 °C)	The fan will run for about 30 minutes. The fan will emit noise, but this is normal and the printer will be operable while the fan is running.
"Home is in use by another function." appears.	The [Home] screen is being edited by another function.	Wait for a while, and then try to create the shortcut on the [Home] screen again.
"The image data size is not valid. See the manual for required data." appears.	The image data size is not valid.	For details about the file size for the shortcut image, see "Customizing the [Home] Screen", Operating Instructions.

Problem	Cause	Solution
"The format of the image data is not valid." appears.	The file format of the shortcut image to be added is not supported.	The file format of the shortcut image to be added must be JPEG. Specify the image again.

Note

- Using curled paper often causes misfeeds, soiled paper edges, or slipped positions while performing stack printing. When using curled paper, try to flatten the paper or load the paper upside down. Also, lay paper on a flat surface to prevent paper from curling, and do not lean it against a wall.
- If you cannot print as you want because of paper type, paper size, or paper capacity problems, use recommended paper. For details about recommended paper, see p.33 "Paper Specification".

When the Color Registration Shifts

After moving the printer, printing on thick paper, or printing repeatedly for some time, color degradation may occur. By performing automatic color adjustment, you can restore optimum print quality.

1. Press [Color Registration] on the [Maintenance: Image] screen.

For details about how to access the [Maintenance: Image], see "Displaying the Printer Configuration Screens Using the Control Panel", Operating Instructions.

2. Press [Start].

Auto color registration takes about 30 seconds.

3. Press the [User Tools] key.

When the Printed Color Changes

Color gradation during color printing can change slightly, depending on a number of factors. If you print the same file repeatedly or toner was recently replaced, changes may occur in color tones. In such cases, you can obtain optimal print results by correcting the color gradation.

Note

- Color gradation correction is not required under normal circumstances.
- If a printer is not used for some time, changes can occur in color tones.
- If suitable results cannot be obtained after a single correction, repeat the correction several times as needed.
- Corrections to color gradation will be applied to all user jobs.
- Use the same type of paper when printing a run of gradation corrections. If a different type of paper is used, corrections may not be apparent.
- This feature requires the use of the supplied Color Calibration Sample Sheet.
- Corrections to color gradation are performed in the following order:
 1. Print gradation correction sheet 1.
Adjust the parts of highlight colors.
Set the correction value.
Print the gradation correction sheet, and then check the result of the correction.
 3. Print gradation correction sheet 2.
Adjust the parts of middle colors.
Set the correction value.
Print the gradation correction sheet, and then check the result of the correction.
 4. Save the correction value.

Setting the Gradation Correction Value

Correct the gradation in two areas: bright areas (highlights), and medium areas (midtones). [Print Test Pattern 1 for Calibration] is used to set the correction value for highlights, and [Print Test Pattern 2 for Calibration] is used for mid tones.

1. Press [Color Calibration] on the [Maintenance: Image] screen.

For details about how to access the [Maintenance: Image] screen, see "Displaying the Printer Configuration Screens Using the Control Panel", Operating Instructions.

Press [▼] to switch the screen.

2. Press [Adjust Auto Density].

3. Press [Start] to adjust Auto Density.

The confirmation message appears when complete. Press [Exit].

4. Press [Print Test Pattern 1 for Calibration] or [Print Test Pattern 2 for Calibration] to print the selected sheet.**5. Select the color you want to adjust.****6. Press [-] or [+] to adjust the correction value for the selected color, and then press [OK].**

Enter the value between 0 and 6.

7. Press [Print Result] to check the result by printing the calibration sheet.**8. After printing, press [Yes] to save the settings.****9. Press the [User Tools] key.**

Gradation Correction Sheet

The Color Calibration Sample Sheet contains two color sample columns "sample 1" column for adjusting highlights and "sample 2" column for adjusting midtones.

The gradation correction sheet contains "gradation correction sheet 1" for adjusting highlights and "gradation correction sheet 2" for adjusting midtones. Gradation correction sheet 1 is used for correction 1, and gradation correction sheet 2 is used for correction 2.

Color sample and correction values

The following explains how to view the color sample of the Color Calibration Sample Sheet and the correction values of the gradation correction sheet.

This explanation uses setting K (black) as an example. The setting method for M (magenta) is similar. For C/Y (cyan/yellow), the correction value is determined based on a combination of these two colors, although panel settings are configured for each color separately.

Note

- Hold the correction value (0 to 6) for "K" of the correction value setting sheet over the color sample of gradation correction 1 of the Color Calibration Sample Sheet and find the corrected color closest to that of the color sample. Then, enter the corresponding number using the operation panel. The currently set correction value is printed in red.

K correction value



BMW034S

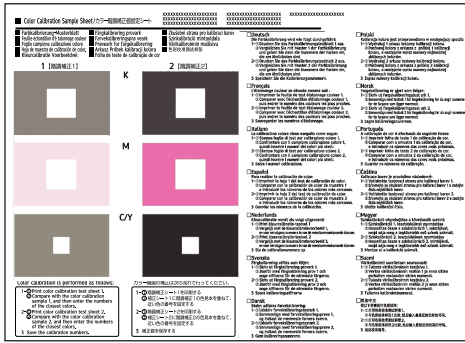

BMV254S

Reading the gradation correction sheet

The printed gradation correction sheet is read as shown below.

Comparing the gradation correction sheet and correction value of each color, K (black), M (magenta), and C (cyan)/Y (yellow) determine the required gradation correction and configure settings using the control panel.

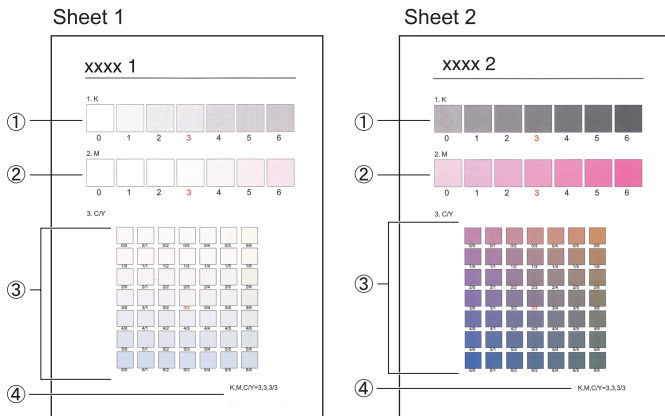

BFL359S

1. K (black) correction values

Used to adjust the color printed when only black toner is used. The currently set correction value is printed in red.

2. M (magenta) correction values

Used to adjust the color printed when only magenta toner is used. The currently set correction value is printed in red.

3. C (cyan)/Y (yellow) correction values

Used to correct the colors printed when cyan and yellow are used. For C/Y (cyan/yellow), the correction value is determined based on combinations of these two colors, although panel settings are configured for each color.

4. Setting value

The value displayed is the one currently set when the gradation correction sheet is printed. This value corresponds to the value set on the control panel.

Resetting the Gradation Correction Value to the Default Value

1. Press [Color Calibration] on the [Maintenance: Image] screen.

For details about how to access the [Maintenance: Image], see "Displaying the Printer Configuration Screens Using the Control Panel", Operating Instructions.

Press [▼] to switch the screen.

2. Press [Reset Setting].

3. Press [OK].

The confirmation message appears when complete. Press [Exit].

4. Press the [User Tools] key.

If USB Connection Fails

Problem	Cause	Solution
The printer is not automatically recognized.	The USB cable is not connected properly.	Disconnect the USB cable, and then turn off the main power switch. Turn on the main power switch again. When the printer has fully booted up, reconnect the USB cable.
Windows has already configured the USB settings.	Check whether the computer has identified the printer as an unsupported device.	Open Windows' Device Manager, and then, under [Universal Serial Bus controllers], remove any conflicting devices. Conflicting devices have a [!] or [?] icon by them. Take care not to accidentally remove required devices. For details, see Windows Help.
The printer does not recognize the USB connection even when a USB cable is inserted.	If the USB cable is connected while the printer is off, the printer might not recognize the USB connection.	Press the [Energy Saver] key, and then disconnect the USB cable. Press the [Energy Saver] key again. When the printer has returned to the ready condition, reconnect the USB cable.

When Messages Are Displayed

This section describes the main messages that appear on the display panel and printed error logs and reports. If other messages appear, follow their instructions.

Status Messages

Message	Status
"Calibrating..."	The printer is calibrating the color. Wait a while.
"Hex Dump Mode"	In Hex Dump mode, the printer receives data in hexadecimal format. Press [Job Reset] to cancel Hex Dump mode.
"Initializing Unit..."	The printer is initializing. Wait a while.
"Job suspended."	Printing was temporarily suspended because [Job Operation] or the [Suspended] key was pressed.
"Loading Toner..."	The printer is loading the toner. Wait a while.
"Offline"	The printer is offline.
"Please wait."	This message might appear for a second or two while the printer is preparing, performing initial adjustments, or adding toner. Wait a while.
"Printing..."	The printer is printing. Wait a while.
"Ready"	This is the default ready message. The printer is ready for use. No action is required.
"Resetting job..."	The printer is resetting the print job. Wait until "Ready" appears on the display panel.
"Setting change..."	The printer is changing settings. You cannot use the control panel while this message is displayed. Wait a while.
"Suspended job exists."	Printing was temporarily stopped by SmartDeviceMonitor for Client. You can resume printing via [My Job List] in SmartDeviceMonitor for Client, or via the Web Image Monitor. To resume printing via Web Image Monitor, ask your system administrator first.
"Updating certif..."	The @Remote certificate is being updated. Wait a while.

Message	Status
"Waitg. for prt.data"	The printer is waiting for the next data to print. Wait a while.

Alert Messages (Displayed on the Control Panel)

Note

- Before turning the main power switch off, see p.27 "Turning On/Off the Power".

Message	Cause	Solution
"Cannot connect with the wireless card. Turn the main power switch off, then check the card."	<ul style="list-style-type: none"> • The wireless LAN board was not inserted when the printer was turned on. • The wireless LAN board was pulled out after the printer was turned on. • The settings are not updated although the unit is detected. 	<ul style="list-style-type: none"> • Turn off the main power switch, and then confirm the wireless LAN board is inserted correctly. For details about installing the board, see "Installing the Interface Units", Operating Instructions. • If the message appears again, contact your service representative.
"Hardware Problem: Ethernet"	An error has occurred in the Ethernet interface.	Turn the main power switch off and then back on again. If the message appears again, contact your service representative.
"Hardware Problem: HDD"	An error has occurred in the hard disk.	<ul style="list-style-type: none"> • Turn the main power switch off and then back on again. If the message appears again, contact your service representative. • The hard disk may have not been installed properly if you have installed it yourself. Check that it is properly installed For details about installing the unit, see "Installing the Memory Expansion Units", Operating Instructions.

Message	Cause	Solution
"Hardware Problem: Parallel I/F"	An error has occurred in the IEEE 1284 interface board.	<ul style="list-style-type: none"> • Turn the main power switch off and then confirm the IEEE 1284 interface board is inserted correctly. For details about installing the board, see "Installing the Interface Units", Operating Instructions. • If the message appears again, contact your service representative.
"Hardware Problem: USB"	An error has occurred in the USB interface.	Turn the main power switch off and then back on again. If the message appears again, contact your service representative.
"Hardware Problem: Wireless Card"	The wireless LAN board can be accessed, but an error was detected.	<ul style="list-style-type: none"> • Turn off the main power switch, and then confirm the wireless LAN board is inserted correctly. For details about installing the board, see "Installing the Interface Units", Operating Instructions. • If the message appears again, contact your service representative.
"Out of paper in n. Load paper of the following size and type. To cancel the current job, press [Job Reset]." ("n" is a figure.)	The printer driver settings are incorrect or the tray does not contain paper of the size selected in the printer driver.	Check that the printer driver settings are correct, and then load paper of the size selected in the printer driver into the input tray. For details about how to change the paper size, see p.49 "Loading Paper".

Message	Cause	Solution
"Tray setg. do not match spcfd siz&typ. Select new tray or use sz&typ below."	The printer driver settings are incorrect or the tray does not contain paper of the size or type selected in the printer driver.	<ul style="list-style-type: none"> • Check that the printer driver settings are correct, and then load paper of the size selected in the printer driver into the input tray. For details about how to load paper, see p.49 "Loading Paper". • Select the tray manually to continue printing, or cancel a print job. For details about how to select the tray manually, or cancel a print job, see "If an Error Occurs with the Specified Paper Size and Type", Operating Instructions.
"n ppr siz msmtch Select new tray or use ppr size below." ("n" is a tray name.)	The size of the paper in the tray does not match the paper size specified in the printer driver.	Select a tray containing paper that is the same size as the specified paper size.
"Problem: Printer Font Error"	An error has occurred in the font settings.	Contact your service representative.
"The selected file(s) contained file(s) without access privileges. Only file(s) with access privileges will be deleted."	You have tried to delete files without the authority to do so.	To check your access permission for stored documents, or to delete a document you do not have permission to delete, see Security Guide.
"The same paper tray cannot be set for the main sheets and slip sheets ([Designate]). Check the setting."	The tray selected for other pages is the same as the one for slip sheets.	Reset the job. Be sure the tray you select for slip sheets is not providing paper for other pages.
"You do not have the privileges to use this function."	The logged in user name does not have permission for the selected function.	For details about how to set permissions, see Security Guide.

Messages during Direct print from a memory storage device

Message	Causes	Solutions
"Unable to access the specified memory storage device."	The memory device used cannot be recognized.	For details about the recommended memory devices for the Direct printing function from memory storage devices, contact your service representative. The USB flash memory device that features password protection or other security features may not work normally.
"Exceeded the limit value for total data size of the selected files. Cannot select more files."	<ul style="list-style-type: none"> The size of the selected file exceeds 1 GB. The total size of the selected files exceeds 1 GB. 	<p>Files or groups of files larger than 1 GB cannot be printed.</p> <ul style="list-style-type: none"> When the total size of the multiple files that are selected exceeds 1 GB, select files separately. When the size of the selected file exceeds 1 GB, print by using a function other than the Direct printing function from memory storage devices. <p>You cannot select files of different formats at the same time.</p>

Alert Messages (Printed on Error Logs and Reports)

This section describes likely causes of and possible solutions for the error messages that are printed on the error logs or reports.

Message	Cause	Solution
"84: Error"	There is no work area available for image processing.	<ul style="list-style-type: none"> In [Printer Features], under [System], set [Memory Usage] to [Font Priority]. Decrease the number of files sent to the printer or install the optional SDRAM module. For details about installing SDRAM module, see "Installing the SDRAM module", Operating Instructions.

Message	Cause	Solution
"85: Error"	The specified graphics library is unavailable.	<ul style="list-style-type: none"> • Check that the data is valid. • Decrease the number of files sent to the printer or install the optional SDRAM module. For details about installing SDRAM module, see "Installing the SDRAM module", Operating Instructions.
"86: Error"	Parameters of the control code are invalid.	Check the print settings.
"91: Error"	Printing was canceled by the auto job cancel function due to a command error.	Check that the data is valid.
"92: Error"	Printing was canceled because [Job Reset] or the [Suspended] key was selected on the printer's control panel.	Perform the print operation again as necessary.
"98: Error"	The printer could not access the hard disk correctly.	Turn the main power switch off and then back on again. If the message appears frequently, contact your service representative.
"Address Book is currently in use by another function. Authentication has failed."	The printer currently cannot perform authentication because the Address Book is being used by another function.	Wait a while, and then retry the operation.
"Auto-registration of user information has failed."	Automatic registration of information for LDAP Authentication or Windows Authentication failed because the Address Book is full.	For details about automatic registration of user information, see Security Guide.
"Classification Code is incorrect."	The classification code has not been entered, or the classification code has been entered incorrectly.	Enter the correct classification code.

Message	Cause	Solution
"Classification Code is incorrect."	The classification code is not supported by the printer driver.	Select Optional for the classification code. For details about how to specify classification code settings, see "Registering Classification Codes", Operating Instructions.
"Collate has been cancelled."	Collate was canceled.	Decrease the number of files sent to the printer or install the optional SDRAM module. For details about installing SDRAM module, see "Installing the SDRAM module", Operating Instructions.
"Command Error"	An RPCS command error occurred.	Check that the communication between a device and the printer is working correctly.
"Compressed Data Error."	The printer detected corrupt compressed data.	<ul style="list-style-type: none"> • Check the connection between the computer and the printer. • Check that the program you used to compress the data is functioning correctly.
"Data storage error."	You tried to print a Sample Print, Locked Print, Hold Print, or Stored Print file while the hard disk was not installed.	<p>The hard disk is required when printing a Sample Print, Locked Print, Hold Print, or Stored Print.</p> <p>If the message appear after installing the hard disk, contact your service representative.</p>

Message	Cause	Solution
"Duplex has been cancelled."	Duplex printing was canceled.	<ul style="list-style-type: none"> • Select the proper paper size for the duplex function. For details about paper size, see p.33 "Supported Paper for Each Input Tray". • Change the setting for "Apply 2 sided" in [System Settings] to enable duplex printing for the paper tray. For details about setting "Apply 2 sided", see "Tray Paper Settings", Operating Instructions.
"Error has occurred."	A syntax error, etc., occurred.	Check that the PDF file is valid.
"Error occurred. Either job was printed with settings changed or it was cancelled."	An error occurred during printing, but it was skipped.	Check that the data is valid.
"Exceeded max. number of files to print for temporary/stored jobs."	While printing a Sample Print, Locked Print, Hold Print, or Stored Print file, the maximum file capacity was exceeded.	Delete unneeded files stored in the printer.
"Exceeded max. number of files. (Auto)"	While using the error job store function to store Normal Print jobs as Hold Print files, the maximum file capacity for file storage or Hold Print file management (automatic) was exceeded.	Delete Hold Print files (automatic) or unneeded files stored in the printer.
"Exceeded max. number of pages to print for temporary/stored jobs."	While printing a Sample Print, Locked Print, Hold Print, or Stored Print file, the maximum page capacity was exceeded.	<ul style="list-style-type: none"> • Delete unneeded files stored in the printer. • Reduce the number of pages to print.

Message	Cause	Solution
"Exceeded max. pages. Collate is incomplete."	The number of pages exceeds the maximum number of sheets that can be used with Collate.	Reduce the number of pages to print.
"Exceeded max. number of pages. (Auto)"	While using the error job store function to store Normal Print jobs as Hold Print files, the maximum page capacity was exceeded.	<ul style="list-style-type: none"> • Delete unneeded files stored in the printer. • Reduce the number of pages to print.
"Exceeded the maximum unit count for Print Volume Use. The job has been cancelled."	The number of pages the user is permitted to print has been exceeded.	For details about Print Volum. Use Limit., see Security Guide.
"Failed to obtain file system."	PDF direct printing could not be performed because the file system could not be obtained.	Turn the main power switch off and then back on again. If the message appears again, contact your service representative.
"File system is full."	The PDF file cannot be printed because the capacity of the file system is full.	Delete all unnecessary files from the hard disk, or decrease the file size sent to the printer.
"HDD is full."	The hard disk became full while printing a Sample Print, Locked Print, Hold Print, or Stored Print file.	<ul style="list-style-type: none"> • Delete unneeded files stored in the printer. • Reduce the data size of the Sample Print, Locked Print, Hold Print, or Stored Print file.
"HDD is full."	When printing with the PostScript 3 printer driver, the hard disk capacity for fonts and forms has been exceeded.	Delete unneeded forms or fonts registered in the printer.

Message	Cause	Solution
"HDD is full. (Auto)"	The hard disk became full while using the error job store function to store Normal Print jobs as Hold Print files.	<ul style="list-style-type: none"> • Delete unneeded files stored in the printer. • Reduce the data size of the Temporary Print file and/or the Stored Print file.
"I/O buffer overflow."	An input buffer overflow occurred.	<ul style="list-style-type: none"> • In [Printer Features], under [System], set [Memory Usage] to [Font Priority]. • In [Printer Features], under [Host Interface], select [I/O Buffer], and then set the maximum buffer size to a larger value. • Reduce the number of files being sent to the printer.
"Information for user authentication is already registered for another user."	The user name for LDAP Authentication or Integration Server Authentication was already registered in a different server with a different ID, and a duplication of the user name occurred due to a switching of domains (servers), etc.	For details about User Authentication, see Security Guide.

Message	Cause	Solution
"Insufficient Memory"	A memory allocation error occurred.	<p>PCL 5/PostScript 3</p> <p>Select a lower resolution on the printer driver. For details about how to change the resolution setting, see the printer driver Help.</p> <p>PCL 6</p> <p>Select a lower resolution on the printer driver. For details about how to change the resolution setting, see the printer driver Help.</p> <p>On the printer driver's [Detailed Settings] tab, click [Print Quality] in "Menu:", and then select [Raster] in the "Vector/Raster:" list. In some cases, it will take a long time to complete a print job.</p> <ul style="list-style-type: none"> • Install the optional SDRAM module. For details about installing SDRAM module, see "Installing the SDRAM module", Operating Instructions.
"Memory Retrieval Error"	A memory allocation error occurred.	Turn the main power switch off and then back on again. If the message appears again, install or replace the RAM. For details about installing SDRAM module, see "Installing the SDRAM module", Operating Instructions.
"No response from the server. Authentication has failed."	A timeout occurred while connecting to the server for LDAP Authentication or Windows Authentication.	Check the status of the server.
"Output tray has been changed."	The output tray was changed because the paper size of the specified output tray is limited.	Specify the proper output tray.

Message	Cause	Solution
"Print overrun."	Images were discarded while printing.	Select a lower resolution on the printer driver. For details about how to change the resolution setting, see the printer driver Help.
"Printing privileges have not been set for this document."	The PDF document you have tried to print has no privileges to print.	Contact the owner of the document.
"Punch has been cancelled."	Punch printing was canceled.	Check the paper orientation, print orientation, and then punch position. Certain settings can produce print results that might not be as expected.
"Receiving data failed."	Data reception was aborted.	Resend the data.
"The selected paper size is not supported. This job has been cancelled."	Job Reset is automatically performed if the specified paper size is incorrect.	Specify the correct paper size, and then print the file again.
"Sending data failed."	The printer received a command to stop transmission from the printer driver.	Check if the computer is working correctly.
"Staple has been cancelled."	Stapling printing was canceled.	Check the paper orientation, paper quantity, print orientation, and staple position. Certain settings can produce print results that might not be as expected.
"The print job has been cancelled because capture file(s) could not be stored: Exceeded max. memory."	The hard disk became full after a file was stored.	Reduce the file size to be sent.
"The selected paper type is not supported. This job has been cancelled."	Job Reset is automatically performed if the specified paper type is incorrect.	Specify the correct paper type, and then print the file again.

Message	Cause	Solution
"Unauthorized Copy Prevention error occurred. Job cancelled."	The [Enter User Text:] field on the [Unauthorized Copy Prevention for Pattern Details] screen is blank.	PCL 6/PostScript 3 On the printer driver's [Detailed Settings] tab, click [Effects] in "Menu:". Select [Unauthorized Copy Prevention], and then click [Details] to display [Unauthorized Copy Prevention for Pattern Details]. Enter text in [Enter User Text:].
"Unauthorized Copy Prevention error occurred. Job cancelled."	The resolution is set to a value less than 600 dpi when [Unauthorized Copy Prevention] is specified.	On the printer driver, set the resolution to 600 dpi or higher, or deselect [Unauthorized Copy Prevention].
"User Paper Type Error"	The printer does not recognize the paper type specified using the printer driver.	Check that the printer is connected to the network correctly and bidirectional communication is enabled. If the problem persists, confirm the user paper type settings of the printer. For details, see "Registering Unique Names to Paper Types", Operating Instructions.
"You do not have a privilege to use this function. This job has been cancelled."	The entered Login User Name or Login Password is not correct.	Check that the Login User Name and Login Password are correct.
"You do not have a privilege to use this function. This job has been cancelled."	The logged in user is not allowed to use the selected function.	For details about how to set permissions, see Security Guide.
"You do not have a privilege to use this function. This operation has been cancelled."	The logged in user does not have the privileges to register programs or change the paper tray settings.	For details about how to set permissions, see Security Guide.

Messages during Direct print from a memory storage device

Message	Causes	Solutions
"99: Error"	This data cannot be printed. The specified data is either corrupt or not supported by the Direct printing function from memory storage devices.	Check that the data is valid. For details about the kinds of data supported by the Direct printing function from memory storage devices, see "Direct Printing from a Memory Storage Device", Operating Instructions.

3

If printing does not start, contact your service representative.

Note

- The contents of errors may be printed on the Configuration Page. Check the Configuration Page in conjunction with the error log. For details about how to print the Configuration Page, see "Test Printing", Operating Instructions.

Checking the Error Log

If files could not be stored due to printing errors, identify the cause of the errors by checking the error log on the control panel.

★ Important

- The most recent 30 errors are stored in the error log. If a new error is added when there are 30 errors already stored, the oldest error is deleted. However, if the oldest error is a Sample Print, Locked Print, Hold Print, or Stored Print error, it is not deleted. The error is stored separately until the number of errors reaches 30.
- If the main power switch is turned off, the log is deleted.
- You cannot view [Error Log] on the Simple Screen.

1. Press the [Printer] icon on the [Home] screen.

For details about how to access the [Home] screen, see p.16 "How to Use the [Home] Screen".

2. Press [Other Functns.].

3. Press [Error Log].

4. Select the error log you want to check, and then press [Details].

When You Cannot Print

Problem	Cause	Solution
Printing does not start.	The power is off.	For details about how to turn on the main power switch, see p.27 "Turning On/Off the Power".
Printing does not start.	The cause is displayed on the screen of the control panel.	Check the error message or warning status on the display panel, and then take the required action. For details about solutions, see p.91 "When Messages Are Displayed".
Printing does not start.	The interface cable is not connected correctly.	For details about how to connect interface cables correctly, see "Connecting the Printer", Operating Instructions.
Printing does not start.	The correct interface cable is not being used.	The type of interface cable to use depends on the computer. Be sure to use the correct one. If the cable is damaged or worn, replace it. For details about interface cable, see "Connecting the Printer", Operating Instructions.
Printing does not start.	The interface cable was connected after the printer was switched on.	Connect the interface cable before turning on the main power switch.
Printing does not start.	If the printer is using wireless LAN, failure to print might result from a weak wireless signal.	<p>Check the radio signal status of the wireless LAN in [System Settings]. If the signal quality is not satisfactory, move the printer to a location where radio waves can pass or remove objects that might cause interference.</p> <p>You can check the signal status only when wireless LAN is used in infrastructure mode. For details about the radio signal status of the wireless LAN, see "Interface Settings", Operating Instructions.</p>

Problem	Cause	Solution
Printing does not start.	If the printer is using wireless LAN (IEEE802.11g/b), when there is a microwave oven, mobile phone, industrial machine, scientific instrument, or medical instrument which uses the same frequency range near the device, radio waves may be interfering with the wireless LAN's communication.	Turn off the microwave oven, mobile phone, industrial machine, scientific instrument, or medical instrument which uses the same frequency range and then try printing again. If printing is successful, move the device to a location where it does not interfere.
Printing does not start.	If the printer is using wireless LAN, SSID settings may be incorrect.	Check that the SSID is correctly set using the printer's display panel. For details about SSID Setting, see "Connecting to the Wireless LAN Interface", Operating Instructions.
Printing does not start.	If the printer is using wireless LAN, the receiver's MAC address may be preventing communication with the access point.	Check the access point settings when using the infrastructure mode. Depending on the access point, client access may be filtered by MAC address. Also, check that there are no transmission problems between the access point and wired clients, and between the access point and wireless clients.
Printing does not start.	The wireless LAN interface is not working.	Make sure the orange LED is lit, and the green LED is lit or flashing during transmission.
Printing does not start.	The Login User Name, Login Password, or Driver Encryption Key is incorrect.	Check the Login User Name, Login Password, and Driver Encryption Key.
Printing does not start.	Advanced encryption has been set using the Extended Security function.	Check the settings of the Extended Security function. For details about Extended Security function settings, see Security Guide.

Problem	Cause	Solution
[List / Test Print] is disabled.	A mechanical error might have occurred.	Contact your service representative.
Printing does not start when using the extended wireless LAN in Ad-hoc Mode.	The correct Communication Mode is not set.	<ul style="list-style-type: none"> • Turn the main power switch off and then back on again. For details about how to turn on/off the main power switch, see p.27 "Turning On/Off the Power". • Change [Communication Mode] in [System Settings] to [802.11 Ad-hoc Mode], and then select [Off] for [Security Method]. For details about Communication Mode, see "Interface Settings", Operating Instructions.

If printing does not start, contact your service representative.

When the Data In Indicator Does Not Light Up or Flash

When the Data In indicator does not light up or flash after starting a print job, data is not being sent to the printer.

When the printer is connected to the computer using the interface cable

Check that the print port setting is correct. When connecting using a parallel interface, connect using LPT1 or LPT2.

1. Open the printer properties dialog box, and then click the [Ports] tab.

For details about displaying the printer properties dialog box, see "Displaying the Printer Driver Properties with Windows".

2. In the [Print to the following port(s)] list, check that the correct port is selected.

Network connection

For details about the network connection, contact your administrator.

Other Printing Problems

This section describes likely causes of and possible solutions for problems that can occur when printing from a computer.

When you cannot print clearly

Problem	Cause	Solution
The printed image is smudged.	Settings for thick paper have not been configured when printing on thick paper in the bypass tray.	<p>PCL 5c</p> <p>On the printer driver's [Paper] tab, select [Bypass Tray] in the "Input Tray:" list. Then in the "Type:" list, select a proper paper type.</p> <p>PCL 6/PostScript 3</p> <p>On the printer driver's [Detailed Settings] tab, click [Paper] in "Menu:", and then select [Bypass Tray] in the "Input Tray:" list. Then in the "Paper Type:" list, select a proper paper type.</p>
Printed images contain blots or are patchy.	The paper is damp.	Use paper that has been stored in the recommended temperature and humidity conditions. For details about the proper way to store paper, see p.50 "Paper Storage".
Printed images contain blots or are patchy.	The printer is not on a level surface.	The printer must be placed on a stable and level surface. Check the printer environment and select an appropriate location. For details about the printer's environment, see "Moving the Printer", Operating Instructions.
Printed images contain blots or are patchy.	The paper is creased, curled, or has blemishes.	Smooth out the wrinkles or replace the paper. For details about paper, see p.33 "Paper Specification".

Problem	Cause	Solution
The printed image is faded over the entire page.	The paper is damp.	Use paper that has been stored in the recommended temperature and humidity conditions. For details about the proper way to store paper, see p.50 "Paper Storage".
The printed image is faded over the entire page.	The paper is unsuitable. Printing on coarse or treated paper might result in faint print image.	Use recommended paper. For details about recommended paper, see p.33 "Paper Specification".
The printed image is faded over the entire page.	If [On] is selected in the "Economy Color" list in the printer driver settings, the entire page will be faded when printed.	PCL 6/PostScript 3 On the printer driver's [Detailed Settings] tab, click [Print Quality] in "Menu:", and then select [Off] in the "Economy Color".
Images smudge when rubbed. (Toner is not fixed.)	The specified paper type and the paper that is actually loaded might be different. For example, thick paper might be loaded but not specified as the paper type.	PCL 5c On the printer driver's [Paper] tab, select a proper paper type in the [Type:] box. PCL 6/PostScript 3 On the printer driver's [Detailed Settings] tab, click [Paper] in "Menu:", and then select a proper paper type in the "Paper Type:" list.
The printed image is different from the image on the computer's display.	Printing will be performed by the printer's graphic processing function.	PCL 6 On the printer driver's [Detailed Settings] tab, click [Print Quality] in "Menu:", and then select [Raster] in the "Vector/Raster:" list.
The image is too dark or too light.	The paper type settings are not configured correctly.	Check that the paper loaded on the paper tray or bypass tray matches the paper type set on the display panel. For details about paper type settings, see p.33 "Paper Specification".

Problem	Cause	Solution
The image is too dark or too light.	The paper is loaded reverse side up. Printing on non-print surfaces reduces print quality and can damage the printer's internal components.	Before printing on special paper, check its surface carefully. For details about special paper, see p.33 "Paper Specification" and p.49 "Unusable Paper".
Image is dirty.	Use of non-recommended toner can result in a loss of print quality and other problems.	Use genuine manufacturer toner. Contact your service representative.
Printed graphics do not match graphics on the screen.	If the printer driver is configured to use the graphics command, the graphics command from the printer is used to print.	If you want to print accurately, set the printer driver to print without using the graphics command. For details about settings for printer driver, see the printer driver Help.
Print result differs from the display.	A non-Windows operating system is being used.	Check that the application supports the printer driver.
Print result differs from the display.	The printer is not selected for printing.	Use the printer's printer driver of the printer and check that the printer is the specified printer. For details about how to open the printer driver settings screen, see p.30 "Displaying the Printing Preferences dialog box from the [Start] menu".
Print result differs from the display.	Data transmission failed or was canceled during printing.	Check whether there is failed or canceled data remaining. For details about how to identify the cause of the error, see p.105 "Checking the Error Log".
Characters differ from the display.	The loaded paper is unsuitable.	Printing on recommended paper produces better resolution. For details about recommended paper, see p.33 "Paper Specification".

Problem	Cause	Solution
Image position differs from the display.	The page layout settings are not configured correctly.	Check the page layout settings configured using the application. For details about page layout settings, see the application's Help.
Image position differs from the display.	The page layout settings are not configured correctly.	<p>PCL 5c</p> <p>On the printer driver's [Paper] tab, select [Print On] box, and then select the desired size.</p> <p>PCL 6 / PostScript 3</p> <p>On the printer driver's [Detailed Settings] tab, click [Basic] in "Menu:", and then select the desired size in the "Print On:" list.</p>
White lines appear.	The dustproof glass is dirty.	Clean the dustproof glass. For details about how to clean the dustproof glass, see "Cleaning the Dustproof Glass", Operating Instructions.
Lines of garbled or unwanted alphanumeric characters appear.	An incorrect printer language might have been selected.	Select the correct printer driver, and then print the file again.
Images are cut off, or excess is printed.	You may be using paper smaller than the size selected in the application.	Use the same size paper as that selected in the application. If you cannot load paper of the correct size, use the reduction function to reduce the image, and then print. For details about the reduction function, see the printer driver Help.
Photo images are grainy.	Some applications print at a lower resolution.	Use the application's or printer driver's settings to specify a higher resolution. For details about printer driver's settings, see the printer driver Help.
A solid line is printed as a dashed line or appears blurred.	Dither patterns do not match.	Change the dithering settings on the printer driver. For details about the dithering settings, see the printer driver Help.

Problem	Cause	Solution
Fine lines are fuzzy with inconsistent thickness or color, or do not appear.	Super fine lines have been specified in the application, or a color that is too light has been specified for the lines.	Change the dithering settings on the printer driver. For details about the dithering settings, see the printer driver Help. If the problem continues after you change the dithering settings, use the settings of the application in which the image was created to change the color and thickness of the lines.
Images appear only partially colored.	The paper is damp.	Use paper that has been stored in the recommended temperature and humidity conditions. For details about the proper way to store paper, see p.50 "Paper Storage".

When paper is not fed properly

Problem	Cause	Solution
Paper is not fed from the selected tray.	When you are using Windows, printer driver settings override those settings using the display panel.	PCL 5 On the printer driver's [Paper] tab, select the desired input tray in the "Input Tray:" list. PCL 6/PostScript 3 On the printer driver's [Detailed Settings] tab, click [Paper] in "Menu:", and then select the desired input tray in the "Input Tray:" list.
Images are printed at a slant.	The tray's side fences might not be locked.	Check that the side fences are locked. For details about how to set the side fences, see p.49 "Loading Paper".
Images are printed at a slant.	The paper is feeding in at a slant.	Load the paper correctly. For details about loading paper, see p.49 "Loading Paper".

Problem	Cause	Solution
Misfeeds occur frequently.	The number of sheets loaded exceeds the capacity of the printer.	Load paper only as high as the upper limit markings on the side fences of the paper tray, or the markings on the paper guides of the bypass tray.
Misfeeds occur frequently.	The paper tray's side fences are set too tightly.	Push the side fences lightly, and then reset them.
Misfeeds occur frequently.	The paper is damp.	Use paper that has been stored in the recommended temperature and humidity conditions. For details about the proper way to store paper, see p.50 "Paper Storage".
Misfeeds occur frequently.	The paper is too thick or too thin.	Use recommended paper. For details about recommended paper, see p.33 "Paper Specification".
Misfeeds occur frequently.	The paper is wrinkled or has been folded/creased.	<ul style="list-style-type: none"> • Use recommended paper. For details about recommended paper, see p.33 "Paper Specification". • Use paper that has been stored in the recommended temperature and humidity conditions. For details about the proper way to store paper, see p.50 "Paper Storage".
Misfeeds occur frequently.	Printed paper is being used.	Do not load sheets that have already been copied or printed by another printer.
Misfeeds occur frequently.	Sheets are sticking together.	Fan the sheets thoroughly before loading them. Alternatively, feed the sheets into the printer one at a time.
Sheets are feeding in together, resulting in jams.	Sheets are sticking together.	Fan the sheets thoroughly before loading them. Alternatively, feed the sheets into the printer one at a time.

Problem	Cause	Solution
Printed paper becomes creased.	The paper is damp.	Use paper that has been stored in the recommended temperature and humidity conditions. For details about the proper way to store paper, see p.50 "Paper Storage".
Printed paper becomes creased.	The paper is too thin.	Use recommended paper. For details about recommended paper, see p.33 "Paper Specification".
Edges of sheets are creased.	The paper is damp.	Use paper that has been stored in the recommended temperature and humidity conditions. For details about the proper way to store paper, see p.50 "Paper Storage".
Edges of sheets are creased.	You are using non-recommended paper.	Use recommended paper. For details about recommended paper, see p.33 "Paper Specification".
Duplex printing is malfunctioning.	You have loaded thick paper heavier than 169 g/m ² (90 lb. Index).	Change the paper.
Duplex printing is malfunctioning.	You have selected a paper tray that is not set for duplex print.	Change the setting for "Apply 2 sided" in [System Settings] to enable duplex printing for the paper tray. For details about setting "Apply 2 sided", see "Tray Paper Settings", Operating Instructions.
Duplex printing is malfunctioning.	You have selected a paper type that cannot be used for duplex printing.	In [Tray Paper Settings], select a paper type that can be used for duplex printing. For details about the paper types that can be used, see p.62 "Printing on Both Sides of Sheets".

Problem	Cause	Solution
The image on the back side of duplex printing has mottled blank patches or is smudged.	Missing patches and smudges are caused by moisture leaking from the paper.	<ul style="list-style-type: none"> Do not install the printer in areas that are susceptible to low temperature. Use paper that has been stored in the recommended temperature and humidity conditions. For details about the proper way to store paper, see p.50 "Paper Storage". Install the optional anti-humidity heater. For details about the anti-humidity heater, contact your service representative.
White stripes appear on the OHP.	Fragments of paper are stuck to the OHP.	Use a dry cloth to wipe any paper fragments off the back of the OHP.

Other printing problems

Problem	Causes	Solutions
It takes a long time to complete a print job.	"Sleep Mode" might be set.	The printer requires time to warm up if it has been in "Sleep Mode". In [System Settings], under [Timer Settings], select [Sleep Mode Timer], and then specify "Sleep Mode".
It takes a long time to complete a print job.	Photographs and other data intensive pages take a long time for the printer to process, so simply wait when printing such data.	<p>If the Data In indicator is flashing, data has been received by the printer. Wait for a moment.</p> <p>Changing the following settings with the printer driver may help speed up printing:</p> <ul style="list-style-type: none"> Select [Speed] in "Print Priority" list. Select a lower resolution. <p>For details about how to change the settings, see the printer driver Help.</p>

Problem	Causes	Solutions
Images are printed in the wrong orientation.	The feed orientation you selected and the feed orientation selected in the printer driver's option setup might not be the same.	Set the printer's feed orientation and the printer driver's feed orientation accordingly. For details about settings for printer driver, see the printer driver Help.
Optional components connected to the printer are not recognized.	Bidirectional communication is not working.	Set up optional devices on the properties of the printer. For details about how to set up optional devices, see the printer driver Help.
Combined printing, booklet printing, or Auto Reduce/Enlarge printing does not come out as expected.	The application or printer driver settings are not configured correctly.	Make sure the application's paper size and orientation settings match those of the printer driver. If a different paper size and orientation are set, select the same size and orientation.
Some types of data, such as graphics data or data from certain applications, do not print.	The printer driver settings are not configured correctly.	<p>PCL 5c</p> <p>On the printer driver's [Print Quality] tab, select [600 dpi] in the "Resolution" area.</p> <p>PCL 6</p> <ul style="list-style-type: none"> • On the printer driver's [Detailed Settings] tab, click [Print Quality] in "Menu:", and then select [Quality] in the "Print Priority:" list. • On the printer driver's [Detailed Settings] tab, click [Print Quality] in "Menu:", and then select [Raster] in the "Vector/Raster:" list. <p>PostScript 3</p> <p>On the printer driver's [Detailed Settings] tab, click [Print Quality] in "Menu:", and then select [Photographic] in the "Dithering:" list.</p> <p>For details about the printer driver settings, see the printer driver Help.</p>

Problem	Causes	Solutions
Some characters are not printed or appear strange.	The printer driver settings are not configured correctly.	<p>PCL 5c</p> <p>On the printer driver's [Print Quality] tab, select [600 dpi] in the "Resolution" area.</p> <p>PCL 6</p> <ul style="list-style-type: none"> On the printer driver's [Detailed Settings] tab, click [Print Quality] in "Menu:", and then select [Quality] in the "Print Priority:" list. On the printer driver's [Detailed Settings] tab, click [Print Quality] in "Menu:", and then select [Raster] in the "Vector/Raster:" list. <p>PostScript 3</p> <p>On the printer driver's [Detailed Settings] tab, click [Print Quality] in "Menu:", and then select [Text] in the "Dithering:" list.</p> <p>For details about the printer driver settings, see the printer driver Help.</p>
Print speed or application relinquishing speed is slow.	The printer driver settings are not configured correctly.	<p>PCL 6</p> <p>On the printer driver's [Detailed Settings] tab, click [Print Quality] in "Menu:", and then select [Speed] in the "Print Priority:" list.</p> <p>For details about the printer driver settings, see the printer driver Help.</p> <p>Quit any other applications.</p>
Print ends mid-job.	An error might have occurred.	Check the printer's display panel to see if an error has occurred.
A print instruction was issued from the computer, but printing did not start.	User Authentication may have been set.	For details about User Authentication, see Security Guide.

Problem	Causes	Solutions
Color originals are printed in black and white.	No color print settings are configured on the printer driver.	Change the "Color/ Black and White:" setting on the printer driver. For details about how to change the "Color/ Black and White:" setting, see the printer driver Help.
PDF files do not print out/ cannot perform PDF direct print.	PDF files are password-protected.	To print password-protected PDF files, enter the password in [PDF Menu] in [Printer Features], or on Web Image Monitor. For details about printing PDF files, see "PDF Menu", Operating Instructions, or Web Image Monitor Help.
PDF files do not print out/ cannot perform PDF direct print.	PDF files cannot be printed if they are print-disabled in PDF file security setting.	Change the PDF file security setting.
PDF direct print produces strange or malformed characters.	Fonts were not embedded.	Embed fonts in the PDF file you want to print, and then print.
"Resetting job..." appears and printing is suspended.	Memory is insufficient.	In [Printer Features], under [System], select [Memory Usage] to [Font Priority].
Printing did not start even though the specified print time has already passed.	[Jobs Not Printed As Machn. Was Off] was set to [Do not Print] in [Printer Features], but at the specified printing time, the main power switch was turned off or the printer was in Low Power Mode.	Set [Jobs Not Printed As Machn. Was Off] to [Prt When Mach On] in [Printer Features].
Printing did not start even though the specified print time has already passed.	The time set on the printer or computer is incorrect.	Set the correct time on the printer or computer.
Printing via wireless LAN is slow.	The number of jobs exceeds the capacity of the printer.	Reduce the number of jobs.

Problem	Causes	Solutions
<p>Printing via wireless LAN is slow.</p>	<ul style="list-style-type: none"> • A communication error might have occurred. • Interference from other wireless LAN devices can reduce the communication speed • If the printer is using a wireless LAN, radio waves may be interfering with the wireless communication. This may occur if there is a microwave oven, cordless telephone, industrial printer, scientific instrument, or medical instrument using the same frequency range near the device. 	<ul style="list-style-type: none"> • Move the printer farther away from the wireless LAN device. • If there are active wireless LAN devices nearby, move the printer or disable those devices. • Turn off other printers or instruments that use the same frequency range, and then try printing again. If printing is successful, move the devices to a location where they do not interfere with the printer.

If the problem cannot be solved, contact your service representative.

When PictBridge Printing Does Not Work

Problem	Causes	Solutions
PictBridge is not available.	There is a problem with the USB connection or the PictBridge settings.	Use the following procedure to check the connection and settings: <ol style="list-style-type: none"> 1. Disconnect, and then reconnect the USB cable. 2. Check that the PictBridge settings are enabled. 3. Disconnect the USB cable, and then turn off the printer. Turn the printer back on. When the printer has fully booted up, reconnect the USB cable.
When two or more digital cameras are connected, the second and subsequent cameras are not recognized.	You have connected multiple digital cameras.	Connect only one digital camera. Do not connect multiple cameras.
Printing is disabled.	The number of originals exceeds the maximum number of pages that can be printed at a time.	The maximum specifiable print quantity at a time is 999. Respecify the quantity to 999 or less, and then retry printing.
Printing is disabled.	There is no paper of the specified size remaining.	There is no paper of the specified size remaining. If you have to use paper that is not of the specified size, perform Form Feed. To cancel printing, perform Job Cancel.
Printing is disabled.	The paper size setting for this tray cannot be printed on the printer.	Select the paper size setting that can be printed on the printer.

Removing Jammed Paper

Remove the jammed paper by following the procedures stated in the animation that appears on the screen and the sticker or sheet inside the front cover. This section describes how to remove jammed paper if the procedure is not displayed on the screen.

CAUTION

- The inside of the machine could be very hot. Do not touch the parts with a label indicating the "hot surface." Otherwise, an injury might occur.

CAUTION

- Some of this machine's internal components get very hot. For this reason, take care when removing misfed paper. Not doing so could result in burns.

CAUTION

- Keep your hands clear of the booklet finisher tray when removing misfed paper, pulling out or pushing in the finisher's staple unit. You can trap and injure your fingers if you do not.

CAUTION

- When removing jammed paper, make sure not to trap or injure your fingers.

Important

- To prevent misfeeds, do not leave any torn scraps of paper inside the printer.
- Contact your service representative if misfeeds occur frequently.
- If the error message remains displayed even after you remove misfed paper, open and close the front cover.
- If the error message "Paper Misfeed (C)" is displayed, pay attention to the following:
 - When removing jammed paper, touch only those areas explicitly indicated in the manual.
 - Do not remove the fusing unit. Doing so will result in loss of print quality.
 - To remove paper that has not been fed into the fixing section correctly, remove the jammed paper through the underside of the fusing unit. If the jammed paper cannot be removed through the underside of the fusing unit, remove it from the top.

Note

- Inside the finisher, or inside the front cover, there are stickers or sheets explaining how to remove misfed paper.
- If a detailed removal instruction appears on the right of the screen, follow it.
- You can also use the procedure indicated in the [Check Status] screen to remove jammed paper.

Locating Jammed Paper

If a misfeed happens, remove the misfed paper or original following the procedures stated on the sticker or sheet inside the finisher or front cover.

The letter displayed on the control panel indicates the location of the misfeed.

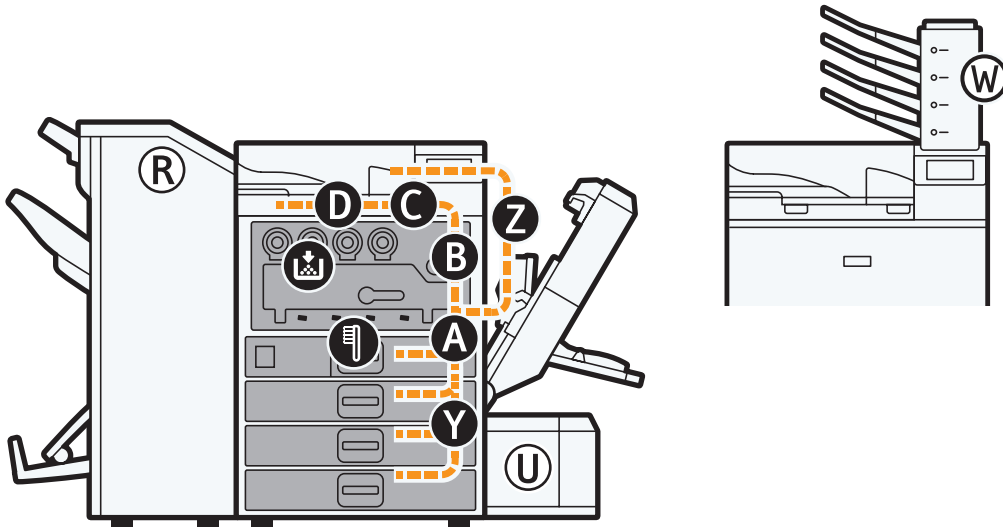

CQT680

1. Press the key of the section from where you want to remove the jammed paper.

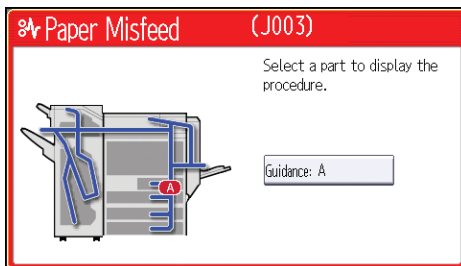

2. After each step is complete, press [Next]. To go back to the previous step, press [Previous].

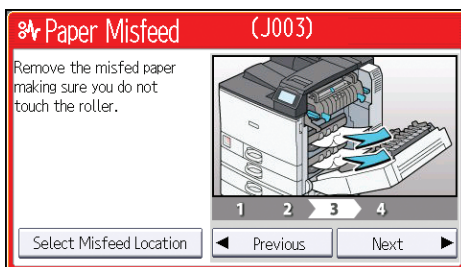

3. When all jammed paper is removed, restore the printer to the original state.

↓ Note

- More than one misfeed may be indicated. When this happens, check all the areas indicated.
- If there is no misfed paper in the first area you check, see the other areas that are indicated.

When R1–R4 Is Displayed for the 2000-sheet Booklet Finisher

3

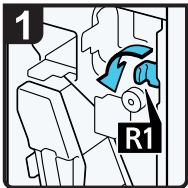

- Open the finisher front cover.
- Pull lever R1 to the left.

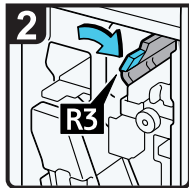

- Raise lever R3 to the right.

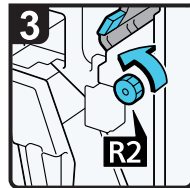

- Turn knob R2 counterclockwise.

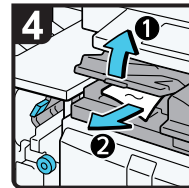

- Open the bridge unit cover (left), and then remove misfed paper.
- Close the bridge unit cover (left).
- Return lever R3 to its original position.

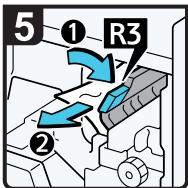

- If you cannot remove misfed paper, raise lever R3 to the right, and then remove it.
- Return lever R3 to its original position.

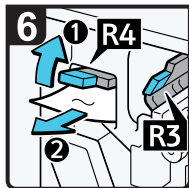

- Raise lever R4, and then remove misfed paper.
- Return lever R4 to its original position.
- Close the finisher front cover.

CJH003

When R5–R7 Is Displayed for the 2000-sheet Booklet Finisher

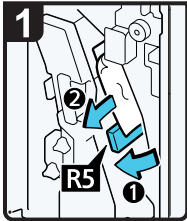

- Open the finisher front cover.
- Lower lever R5, and then remove misfed paper.
 - Return lever R5 to its original position.

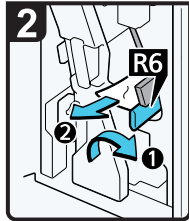

- If you cannot remove misfed paper, raise lever R6, and then remove it.
- Return lever R6 to its original position.

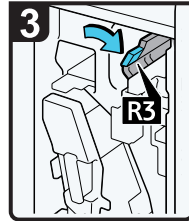

- Raise lever R3 to the right.

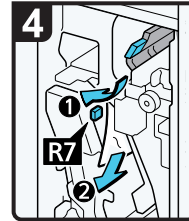

- Raise lever R7, and then remove misfed paper.
- Return lever R3 to its original position.
- Close the finisher front cover.

When R8–R12 Is Displayed for the 2000-sheet Booklet Finisher

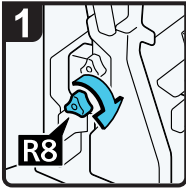

- Open the finisher front cover.
- Turn lower knob R8 clockwise.

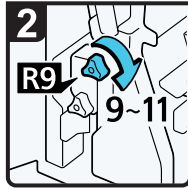

- Turn upper knob R9 nine to eleven times clockwise.

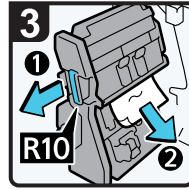

- Pull handle R10, and then pull out the staple unit.
- Remove misfed paper.

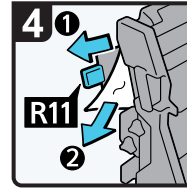

- If you cannot remove misfed paper, pull lever R11, and then remove it.
- Return lever R11 to its original position.

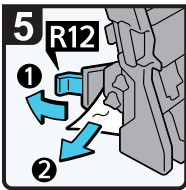

- If you cannot remove misfed paper, pull lever R12, and then remove it.
- Return lever R12 to its original position.
- Return the staple unit to its original position, and then close the finisher front cover.

When R1–R4 Is Displayed for the 3000-sheet finisher

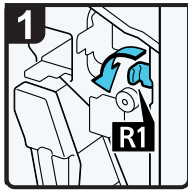

- Open the finisher front cover.
- Pull lever R1 to the left.

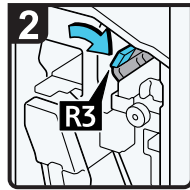

- Raise lever R3 to the right.

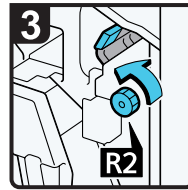

- Turn knob R2 counterclockwise.

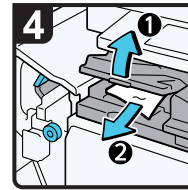

- Open the bridge unit cover (left), and then remove misfed paper.
- Close the bridge unit cover (left).
- Return lever R3 and R1 to their original positions.

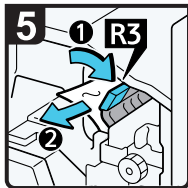

- If you cannot remove misfed paper, raise lever R3 to the right, and then remove it.
- Return lever R3 to its original position.

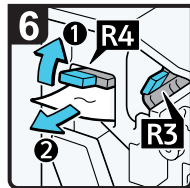

- Raise lever R4, and then remove misfed paper.
- Return lever R4 to its original position.
- Close the finisher front cover.

When R5 - R8 Is Displayed for the 3000-sheet finisher

3

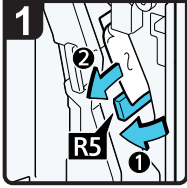

- Open the finisher front cover.
- Lower lever R5, and then remove misfed paper.
- Return lever R5 to its original position.

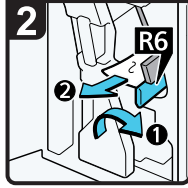

- If you cannot remove misfed paper, raise lever R6, and then remove it.
- Return lever R6 to its original position.

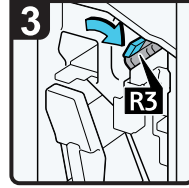

- Raise lever R3 to the right.

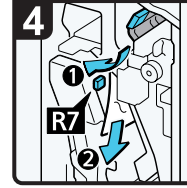

- Raise lever R7, and then remove misfed paper.
- Return lever R3 to its original position.

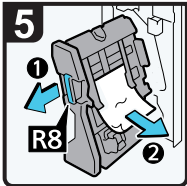

- Pull handle R8, and then pull out the staple unit.
- Remove misfed paper.
- Return the staple unit to its original position, and then close the finisher front cover.

CJH007

Removing Jammed Staples

If a staple jam occurs, remove the jammed staple by following the procedures stated in the animation that appears on the screen. This section describes how to remove jammed staples when the procedure is not displayed on the screen.

CAUTION

- Keep your hands clear of the booklet finisher tray when removing misfed paper, pulling out or pushing in the finisher's staple unit. You can trap and injure your fingers if you do not.

Important

- Curled paper may cause staples to jam. To avoid this, turn paper over in the tray.
- When the finisher is installed, after removing jammed staples, staples will not be ejected the first few times you try to use the stapler.

Note

- Remove the jammed staples according to the finisher type. Check the type if you are unsure. For details about type of finisher, see "Guide to Functions of the Printer's Options", Operating Instructions.

2000-sheet Booklet Finisher

3

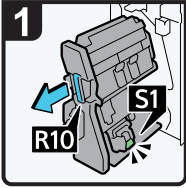

- Open the finisher front cover.
- Pull out the staple unit.

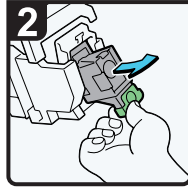

- Pull out the cartridge gently.

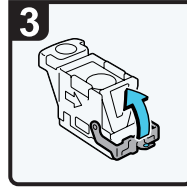

- Open the face plate of the cartridge.

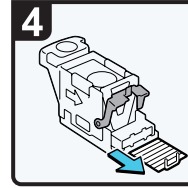

- Remove jammed staples.

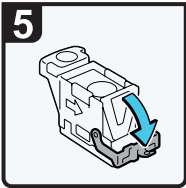

- Pull down the face plate until it clicks.

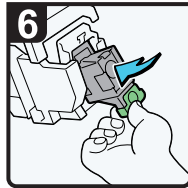

- Pull down the cartridge until it clicks.
- Return the staple unit to its original position, and then close the finisher front cover.

2000-sheet Booklet Finisher (Saddle Stitch)

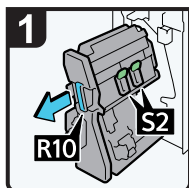

- Open the finisher front cover.
- Pull out the staple unit.

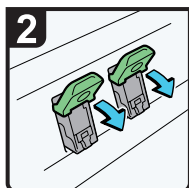

- Pull lever S2.

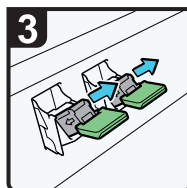

- Pull out the cartridge gently.

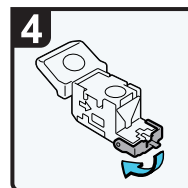

- Open the face plate of the cartridge.

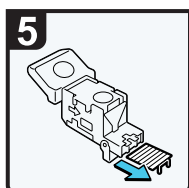

- Remove jammed staples.

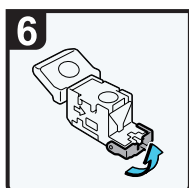

- Pull the face plate until it clicks.

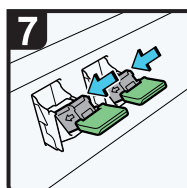

- Push down the cartridge until it clicks.

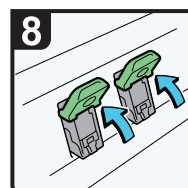

- Return lever S2 to its original position.
- Return the staple unit to its original position, and then close the finisher front cover.

CJH013

3000-sheet Finisher

3

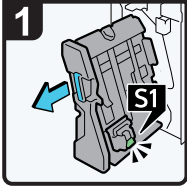

- Open the finisher front cover.
- Pull out the staple unit.

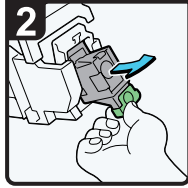

- Pull out the cartridge gently.

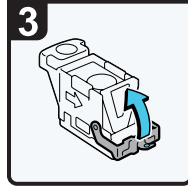

- Open the face plate of the cartridge.

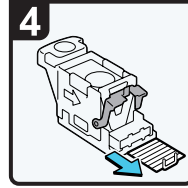

- Remove jammed staples.

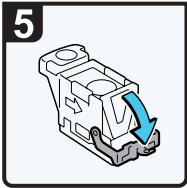

- Pull down the face plate until it clicks.

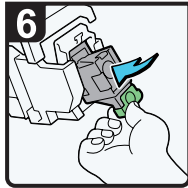

- Pull down the cartridge until it clicks.
- Return the staple unit to its original position, and then close the finisher front cover.

CJH014

Removing Punch Waste

If the punch receptacle is full, remove punch waste by following the procedures stated in the animation that appears on the screen.

↓ Note

- While "🗑️Hole Punch Receptacle is full." is displayed, you cannot use the Punch function.
- "🗑️Hole Punch Receptacle is full." is displayed until the punch waste box is reinstalled.
- If the message is still displayed, reinstall the punch waste box.
- The message "🗑️Hole Punch Receptacle is full." may appear even when the punch waste box is not yet full. If this happens, the position of the punch waste box (indicated by the arrow as shown) may be blocked by punch waste. Remove the punch waste.
 - 3000-sheet finisher:

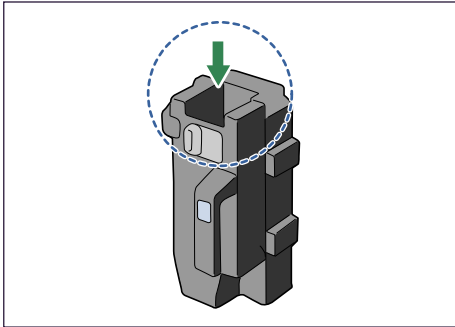

BEK131S

- 2000-sheet booklet finisher:

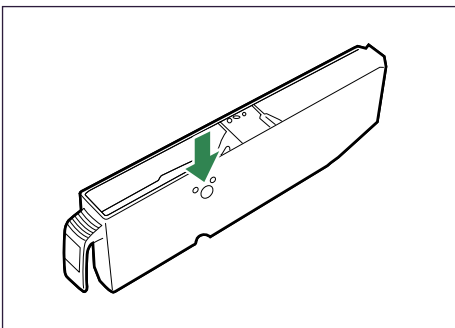

BMV233S

4. Replenishing and Replacing Consumables

This section explains how to replenish consumables and staples when they run out.

Adding Toner

This section explains precautions when adding toner when it has run out, and how to dispose of used toner.

WARNING

- Do not incinerate toner (new or used) or toner containers. Doing so risks burns. Toner will ignite on contact with naked flame.

WARNING

- Do not store toner (new or used) or toner containers anywhere near naked flames. Doing so risks fire and burns. Toner will ignite on contact with naked flame.

WARNING

- Do not use the cleaner to suck spilled toner (including used toner). Sucked toner may cause firing or explosion due to electrical contact flickering inside the cleaner. However, it is possible to use the cleaner designed for dust explosion-proof purpose. If toner is spilled over the floor, sweep up spilled toner slowly and clean remainder with wet cloth.

CAUTION

- Do not crush or squeeze toner containers. Doing so can cause toner spillage, possibly resulting in dirtying of skin, clothing, and floor, and accidental ingestion.

CAUTION

- Store toner (new or used), toner containers, and components that have been in contact with toner out of reach of children.

CAUTION

- If toner or used toner is inhaled, gargle with plenty of water and move into a fresh air environment. Consult a doctor if necessary.

CAUTION

- If toner or used toner gets into your eyes, flush immediately with large amounts of water. Consult a doctor if necessary.

CAUTION

- If toner or used toner is swallowed, dilute by drinking a large amount of water. Consult a doctor if necessary.

CAUTION

- When removing jammed paper or replacing toner, avoid getting toner (new or used) on your clothing. If toner comes into contact with your clothing, wash the stained area with cold water. Hot water will set the toner into the fabric and make removing the stain impossible.

CAUTION

- When removing jammed paper or replacing toner, avoid getting toner (new or used) on your skin. If toner comes into contact with your skin, wash the affected area thoroughly with soap and water.

Important

- Always replace the toner cartridge when a notification appears on the machine.
- Fault may occur if you use toner other than the recommended type.
- When adding toner, do not turn off the main power. Otherwise, settings will be lost.
- Store toner where it will not be exposed to direct sunlight, temperatures above 35 °C (95 °F), or high humidity.
- Store toner on a flat surface.
- Do not shake the toner cartridge with the opening face down after removing it. Residual toner may scatter.
- Do not repeatedly install and remove toner cartridges. This will result in toner leakage.

Replace the toner cartridge when the following messages appear on the display. Follow the instruction on the screen regarding how to replace the toner cartridge.



" No toner. Replace Toner Cartridge."

" No color toner. Color toner is required to print in black & white with the current paper type. Replace the color Print Cartridge or press [Job Reset] to cancel printing."

When the following message appears, the toner has almost run out. Have a replacement toner cartridge at hand.

" Toner Cartridge is almost empty. Replace Toner Cartridge."

Note

- If  appears when there is still toner in the cartridge, hold the cartridge with the opening face up, shake it well, and then reinstall it.
- You can check the name of the required toner and the replacement procedure using the [Add Toner] screen.
- Press the [Check Status] key to check the contact number where you can order supplies. See p.75 "Checking Printer Status and Settings".

Disposing of Used Toner

The following describes what to do with used toner.

Toner cannot be re-used. Pack used toner containers in the container's box or a bag to prevent the toner from leaking out of the container when you dispose of it.

 **Region A** (mainly Europe and Asia)

If you want to discard your used toner container, please contact your local sales office. If you discard it by yourself, treat it as general plastic waste material.

 **Region B** (mainly North America)

Please see our local company website for information on the recycling of supply products, or you can recycle items according to the requirements of your local municipalities or private recyclers.

Replacing Other Consumables

Refer to the maintenance guide provided with the new items for the replacement.

WARNING

- Do not incinerate toner (new or used) or toner containers. Doing so risks burns. Toner will ignite on contact with naked flame.

CAUTION

- Store toner (new or used), toner containers, and components that have been in contact with toner out of reach of children.

CAUTION

- The fusing unit becomes very hot. When installing a new fusing unit, turn off the printer and wait at least an hour after power off before replacing parts. Not allowing the printer to cool may result in burns.

Important

- Exposure to light reduces black drum unit/color drum units performance. Replace the unit as quickly as possible.
- Do not pull out the black drum unit/color drum units quickly or with force as it may fall.
- Take care that nothing comes into contact with the top surface of the black drum unit/color drum units.
- When holding the black drum unit/color drum units, grab the green grip on the left and the handle on the front together. Do not move the black drum unit/color drum units by only grabbing the grip. Doing so may damage the grip.
- Waste toner bottles cannot be reused.
- Purchasing and storing extra waste toner bottles is recommended.
- Before removing the waste toner bottle from the printer, spread paper or some other material around the area to keep toner from dirtying your workspace.

Black Drum Unit/Color Drum Unit

Replace the drum unit when the following messages appear on the display:

"Replacement of Black Photoconductor Unit is now necessary. Replace Black Photoconductor Unit."

"Replacement of Color Photoconductor Unit is now necessary. Replace Color Photoconductor Unit."

When the following message appears on the display, the drum unit should be replaced soon.

"Replacement of Black Photoconductor Unit will soon be necessary. A new Black Photoconductor Unit is required. Please contact your local vendor."

"Replace Black Photoconductor Unit. Press either the Check Status key or the remaining supply display to check information about supplies."

"Replacement of Color Photoconductor Unit will soon be necessary. A new Color Photoconductor Unit is required. Please contact your local vendor."

"Replace Color Photoconductor Unit. Press either the Check Status key the remaining supply display to check information about supplies."

Waste toner bottle

Replace the waste toner bottle when the following message appears on the display:

"Waste Toner Bottle is full. Replace the bottle."

When the following message appears on the display, the waste toner bottle should be replaced soon.

"Waste Toner Bottle is almost full. A new Waste Toner Bottle is required. Please contact your local vendor."

Fusing unit

Replace the fusing unit when the following message appears on the display:

"Replacement of Fusing Unit is now necessary. Replace Fusing Unit."

When the following message appears on the display, the fusing unit should be replaced soon.

"Replace Fusing Unit. Press either the Check Status key or the remaining supply display to check information about supplies."

Transfer unit

Replace the transfer unit when the following message appears on the display:

"Replacement of Transfer Unit is now necessary. Replace Transfer Unit."

When the following message appears on the display, the transfer unit should be replaced soon.

"Replace Intermediate Transfer Unit. Press either the Check Status key or the remaining supply display to check information about supplies."

Adding Staples

CAUTION

- Keep your hands clear of the booklet finisher tray when removing misfed paper, pulling out or pushing in the finisher's staple unit. You can trap and injure your fingers if you do not.

Important

- **Stapling failures or jams may occur if you use a staple cartridge other than that recommended.**

Replace the staple cartridge when the following message appears on the display. Follow the instruction on the screen regarding how to replace the staple cartridge.

"Add staples"

Note

- If you cannot pull out the upper unit of the staple cartridge, there are staples remaining inside the cartridge. Use all the staples, and do not add more.
- Refill the stapler according to the finisher type. Check the type if you are unsure. For details about type of finisher, see "Consumables", Operating Instructions.

Trademarks

Adobe, Acrobat, PageMaker, PostScript, PostScript 3, and Reader are either registered trademarks or trademarks of Adobe Systems Incorporated in the United States and/or other countries.

Citrix, Citrix Presentation Server and Citrix XenApp are either registered trademarks or trademarks of Citrix Systems, Inc.

Firefox® is a registered trademark of the Mozilla Foundation.

IPS is a trademark or registered trademark of Zoran Corporation and/or its subsidiaries in the United States or other countries.

Java is a registered trademark of Oracle and/or its affiliates.

JAWS® is a registered trademark of Freedom Scientific, Inc., St. Petersburg, Florida and/or other countries.

Macintosh, Mac OS, Bonjour, and Safari are trademarks of Apple Inc., registered in the United States and other countries.

Microsoft®, Windows®, Windows Server®, Windows Vista®, and Internet Explorer® are either registered trademarks or trademarks of Microsoft Corporation in the United States and/or other countries.

Monotype is a registered trademark of Monotype Imaging Inc.

NetWare, IPX, IPX/SPX, NCP, and NDS are either registered trademarks or trademarks of Novell, Inc.

OpenLDAP is a registered trademark of the OpenLDAP Foundation.

PCL® is a registered trademark of Hewlett-Packard Company.

PictBridge is a trademark.

UNIX is a registered trademark of the Open Group.

UPnP™ is a trademark of the UPnP™ Implementers Corporation.

The proper name of Internet Explorer 6 is Microsoft® Internet Explorer® 6.

The proper name of Internet Explorer 8 is Windows® Internet Explorer® 8.

The proper names of the Windows operating systems are as follows:

- The product names of Windows XP are as follows:

Microsoft® Windows® XP Professional Edition

Microsoft® Windows® XP Home Edition

Microsoft® Windows® XP Media Center Edition

Microsoft® Windows® XP Tablet PC Edition

- The product names of Windows Vista are as follows:

Microsoft® Windows Vista® Ultimate

Microsoft® Windows Vista® Business

Microsoft® Windows Vista® Home Premium

Microsoft® Windows Vista® Home Basic

Microsoft® Windows Vista® Enterprise

- The product names of Windows 7 are as follows:

Microsoft® Windows® 7 Home Premium

Microsoft® Windows® 7 Professional

Microsoft® Windows® 7 Ultimate

Microsoft® Windows® 7 Enterprise

- The product names of Windows Server 2003 are as follows:

Microsoft® Windows Server® 2003 Standard Edition

Microsoft® Windows Server® 2003 Enterprise Edition

- The product names of Windows Server 2003 R2 are as follows:

Microsoft® Windows Server® 2003 R2 Standard Edition

Microsoft® Windows Server® 2003 R2 Enterprise Edition

- The product names of Windows Server 2008 are as follows:

Microsoft® Windows Server® 2008 Standard

Microsoft® Windows Server® 2008 Enterprise

- The product names of Windows Server 2008 R2 are as follows:

Microsoft® Windows Server® 2008 R2 Standard

Microsoft® Windows Server® 2008 R2 Enterprise

Other product names used herein are for identification purposes only and might be trademarks of their respective companies. We disclaim any and all rights to those marks.

Microsoft product screen shots reprinted with permission from Microsoft Corporation.

MEMO

MEMO

