



# Moltio

## USER MANUAL

Type HD8766 - HD8767

Read carefully before using the machine.



EN  
02



Register your product and get support at  
[www.philips.com/welcome](http://www.philips.com/welcome)

# IMPORTANT SAFEGUARDS

When using electrical appliances, basic safety precautions should always be followed, including the following:

1. Read all instructions.
2. Do not touch hot surfaces. Use handles or knobs.
3. To protect against fire, electric shock and injury to persons do not immerse cord, plugs, or appliance in water or other liquid.
4. Close supervision is necessary when the appliance is used by or near children.
5. Unplug from outlet when not in use and before cleaning. Allow to cool before putting on or taking off parts, and before cleaning the appliance.
6. Do not operate any appliance with a damaged cord or plug or after the appliance malfunctions, or has been damaged in any manner. Return appliance to the nearest authorized service facility for examination, repair or adjustment.
7. The use of accessory attachments not recommended by the appliance manufacturer may result in fire, electric shock or injury to persons.
8. Do not use outdoors.
9. Do not let cord hang over edge of table or counter, or touch hot surfaces.
10. Do not place on or near a hot gas or electric burner, or in a heated oven.
11. Always attach plug to appliance first, then plug cord into wall outlet. To disconnect, turn any control to "off", then remove plug from wall outlet.
12. Do not use appliance for other than intended use.
13. Save these instructions.

## SAVE THESE INSTRUCTIONS

# CAUTION

This appliance is for household use only. Any servicing, other than cleaning and user maintenance, should be performed by an authorized service center. Do not immerse machine in water. To reduce the risk of fire or electric shock, do not disassemble the machine. There are no parts inside the machine serviceable by the user. Repair should be done by authorized service personnel only.

1. Check voltage to be sure that the voltage indicated on the nameplate corresponds with your voltage.
2. Never use warm or hot water to fill the water tank. Use cold water only.
3. Keep your hands and the cord away from hot parts of the appliance during operation.
4. Never clean with scrubbing powders or harsh cleaners. Simply use a soft cloth dampened with water.
5. For optimal taste of your coffee, use purified or bottled water. Periodic descaling is still recommended every 2-3 months.
6. Do not use caramelized or flavored coffee beans.

## INSTRUCTIONS FOR THE POWER SUPPLY CORD

- A. A short power-supply cord (or detachable power-supply cord) is to be provided to reduce risks resulting from becoming entangled in or tripping over a longer cord.
- B. Longer detachable power-supply cords or extension cords are available and may be used if care is exercised in their use.
- C. If a long detachable power-supply cord or extension cord is used,
  1. The marked electrical rating of the detachable power-supply cord or extension cord should be at least as great as the electrical rating of the appliance
  2. If the appliance is of the grounded type, the extension cord should be a grounding-type 3-wire cord, and
  3. The longer cord should be arranged so that it will not drape over the counter top or table top where it can be pulled on by children or tripped over.

*Congratulations on your purchase of a Saeco Moltio Classic Milk Frother full automatic espresso machine!*  
*To fully benefit from the support that Saeco offers, please register your product at [www.philips.com/welcome](http://www.philips.com/welcome).*  
*This user manual applies to HD8766 and HD8767.*  
*The machine is suitable for preparing espresso coffees using whole coffee beans. It can also dispense steam and hot water. In this user manual you will find all the information you need to install, use, clean and descale your machine.*

## CONTENTS

<b>IMPORTANT</b> .....	<b>4</b>
Safety instructions .....	4
Warning .....	4
Caution .....	5
Compliance with standards .....	7
<b>INSTALLATION</b> .....	<b>8</b>
Product overview .....	8
General description .....	9
<b>PREPARING FOR USE</b> .....	<b>10</b>
Machine Packaging .....	10
Machine Installation .....	10
<b>USING THE MACHINE FOR THE FIRST TIME</b> .....	<b>13</b>
Circuit priming .....	13
Automatic rinse/self-cleaning cycle .....	14
Manual rinse cycle.....	14
Measuring and Programming Water Hardness.....	17
"INTENZA+" water filter installation .....	18
Replacing the "INTENZA+" water filter.....	20
<b>CHANGING COFFEE BEANS</b> .....	<b>21</b>
Removing the coffee bean hopper .....	21
Inserting the coffee bean hopper.....	22
Coffee bean selection .....	24
Coffee emptying cycle.....	25
<b>ADJUSTMENTS</b> .....	<b>26</b>
Saeco Adapting System.....	26
Adjusting the Ceramic Coffee Grinder .....	26
Adjusting the aroma (coffee strength) .....	27
Adjusting the coffee dispensing spout .....	28
Adjusting the Coffee Length .....	29

<b>ESPRESSO AND COFFEE BREWING .....</b>	<b>30</b>
Espresso and coffee brewing using coffee beans .....	30
Espresso and coffee brewing using pre-ground coffee .....	31
<b>STEAM DISPENSING/CAPPUCCINO BREWING .....</b>	<b>32</b>
<b>HOT WATER DISPENSING .....</b>	<b>34</b>
<b>CLEANING AND MAINTENANCE .....</b>	<b>35</b>
Daily Cleaning of the Machine.....	35
Daily cleaning of the water tank.....	37
Daily Cleaning of the Classic Milk Frother.....	37
Weekly Cleaning of the Machine .....	37
Weekly Cleaning of the Classic Milk Frother .....	38
Weekly Cleaning of the Brew Group.....	38
Weekly cleaning of the coffee bean hopper, the tray and the compartment .....	41
Monthly Lubrication of the Brew Group .....	42
Monthly Cleaning of the Brew Group with "Coffee Oil Remover" .....	43
<b>DESCALING.....</b>	<b>45</b>
<b>PROGRAMMING.....</b>	<b>50</b>
The following parameters can be adjusted.....	50
How to program your machine.....	51
<b>MEANING OF THE DISPLAY SYMBOLS .....</b>	<b>53</b>
<b>TROUBLESHOOTING .....</b>	<b>57</b>
<b>ENERGY SAVING.....</b>	<b>59</b>
Stand-by .....	59
Disposal .....	59
<b>TECHNICAL SPECIFICATION.....</b>	<b>60</b>
<b>GUARANTEE AND SERVICE .....</b>	<b>60</b>
Warranty.....	60
Service .....	60
<b>ORDERING MAINTENANCE PRODUCTS .....</b>	<b>61</b>
<b>MACHINE ACCESSORIES .....</b>	<b>62</b>

## IMPORTANT

### Safety instructions

---

This machine is equipped with safety features. Nevertheless read the safety instructions carefully and only use the machine as described in these instructions to avoid accidental injury or damage.

Keep this user manual for future reference.



The term **WARNING** and this sign warn against possible severe injuries, danger to life and/or damage to the machine.



The term **CAUTION** and this sign warn against slight injuries and/or damage to the machine.

### Warning

---

- Connect the machine to a wall socket which is properly wired. Its main voltage should comply with the technical data of the appliance.
- Do not let the mains cord hang over the edge of a table or counter, or touch hot surfaces.
- Never immerse the machine, mains plug or mains cord in water (danger of electrical shock).
- Never direct the hot water jet towards body parts (danger of burning).
- Do not touch hot surfaces. Use handles and knobs.

- Remove the mains plug from the wall socket:
  - If a disturbance occurs.
  - If the machine will not be used for a long time.
  - Before cleaning the machine.

Pull on the plug, not on the mains cord. Do not touch the mains plug with wet hands.

- Do not use the machine if the mains plug, the mains cord or the machine itself is damaged.
- Do not make any modifications to the machine or its mains cord. Only have repairs carried out by a service centre authorized by Philips to avoid a hazard.
- This machine is not intended for use by persons (including children) with reduced physical, sensory or mental capabilities, or lack of experience and knowledge, unless they have been given supervision or instruction concerning use of the machine by a person responsible for their safety.
- Children should be supervised to ensure that they do not play with the machine.
- Never insert fingers or other objects into the coffee grinder.

---

### **Caution**

- The machine is for household use only. It is not intended for use in environments such as staff kitchens of shops, offices, farms or other work environments.
- Always put the machine on a flat and stable surface.

- Do not place the machine on a hot plate, directly next to a hot oven, heater or similar source of heat.
- Only put coffee beans into the coffee bean hopper. If ground coffee, instant coffee or any other substance is put in, it may damage the machine.
- Allow the machine to cool before putting on or taking off.
- Never use warm or hot water to fill the water tank. Use cold water only.
- Never clean with scrubbing powders or harsh cleaners. Simply use a soft cloth dampened with water.
- Descal your machine regularly. The machine indicates when descaling is needed. Not doing this will make your appliance stop working properly. In this case repair is not covered under your warranty!
- Do not keep the machine at temperature below 0 degree Celsius. Residue water in the heating system may freeze and cause damage.
- Do not leave water in the water tank when the machine is not used over a longer period of time. The water can become contaminated. Use fresh water every time you use the machine.



## **Compliance with standards**

---

The machine complies with art.13 of the Italian Legislative Decree dated 25 July 2005, no. 151 "Implementation of the directives 2005/95/EC, 2002/96/EC and 2003/108/EC on the restriction of the use of certain hazardous substances in electrical and electronic equipment, as well as waste disposal".

This machine complies with EU directive 2002/96/EC.

# INSTALLATION

## Product overview

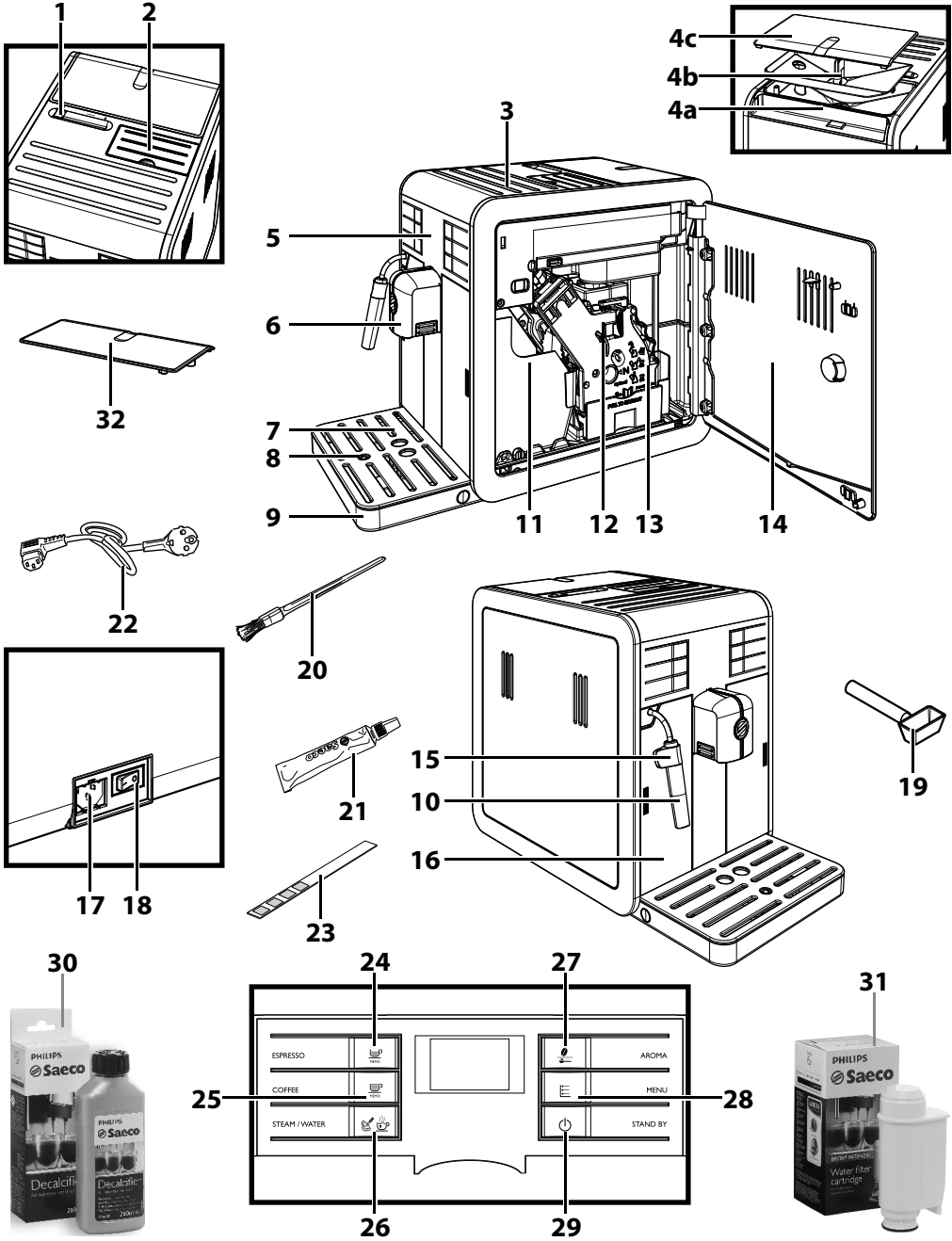

---

**General description**

1. Coffee bean hopper locking/removal selector
2. Pre-ground coffee compartment
3. Storage area for cups
- 4a. Coffee bean hopper
- 4b. Coffee bean hopper tray
- 4c. Coffee bean hopper lid
5. Control Panel
6. Coffee dispensing spout
7. Cup holder grill
8. Full drip tray indicator
9. Drip tray
10. Classic Milk Frother (for hot water/steam)
11. Coffee grounds drawer
12. Brew group
13. Coffee residues drawer
14. Service door
15. Wand protective gripper
16. Water Tank
17. Power cord socket
18. Power button
19. Coffee grinder adjustment key + Pre-ground coffee scoop
20. Cleaning brush
21. Grease for the brew group
22. Power cord
23. Water hardness test strip
24. Espresso brew button
25. Coffee brew button
26. Steam / hot water button
27. "Aroma" - Pre-ground coffee button
28. "MENU" button
29. ON/OFF button
30. Descaling solution (to be purchased separately)
31. Filter (INTENZA+) (to be purchased separately)
32. Protection cover.

## PREPARING FOR USE

### Machine Packaging

The original packaging has been designed and constructed to protect the machine during transport. We recommend keeping the packaging material for possible future transport.

### Machine Installation

**1** Remove the drip tray with grill from the packaging.

**2** Remove the machine from the packaging.

**3** For best use, it is recommended to:

- Choose a safe, level surface, where there is no danger of overturning the machine or being injured.
- Choose a location that is sufficiently well-lit, clean and near an easily reachable socket;
- Allow for a minimum distance from the sides of the machine as shown in the illustration.

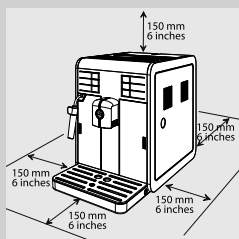

**4** Insert the drip tray with grill into the machine. Make sure it is fully inserted.

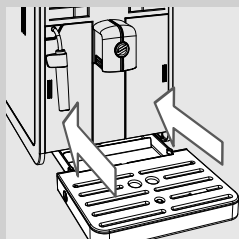

#### Note:

The drip tray collects the water that comes out of the dispensing spout during each rinse/self-cleaning cycle, as well as coffee that might be spilled during beverage preparation. Empty and wash the drip tray daily and each time the full drip tray indicator is raised.



#### Caution:

**NEVER** remove the drip tray when the machine has just been turned on. Wait a couple of minutes for the machine to carry out a rinse/self-cleaning cycle.

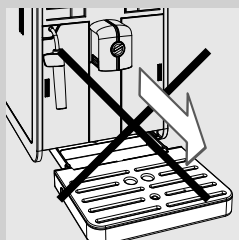



- 5 Push gently on the edge of the water tank door to release the handgrip.

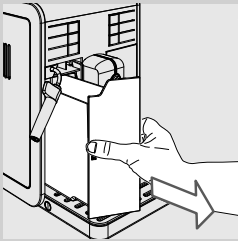

- 6 Remove the water tank by pulling the handgrip.

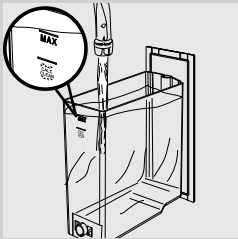

- 7 Rinse the water tank with fresh water.

- 8 Fill the water tank with fresh water up to the MAX level and slide it back into the machine. Make sure it is fully inserted.



**Caution:**

**Never fill the water tank with warm, hot, sparkling water or any other liquid as this may cause damage to the water tank and the machine.**

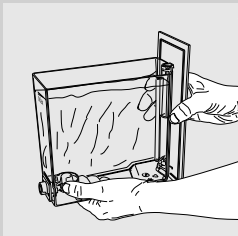

**Note:**

Always carry the full water tank as shown in the picture.

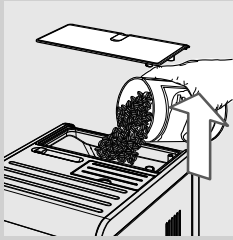

- 9 Remove the coffee bean hopper lid. Slowly pour the coffee beans into the coffee bean hopper.

**Note:**

The coffee bean hopper contains a tray which vibrates during grinding. This supports the flow of beans into the grinder.

**Caution:**

**Only coffee beans must be put into the coffee bean hopper. Ground coffee, instant coffee, caramelized coffee or any other object may damage the machine.**

- 10 Put back the coffee bean hopper lid on the coffee bean hopper.

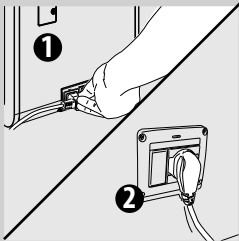

- 11 Insert the plug into the socket located on the back of the machine.

- 12 Insert the plug of the other end of the power cord into a wall socket with suitable power voltage.

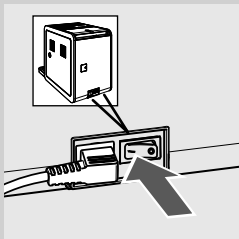

- 13 Switch the power button to "I" to turn on the machine. The red led next to the "I" button blinks.

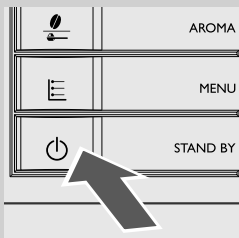

- 14 To turn on the machine, simply press the "I" button. The control panel indicates that the circuit must be primed.

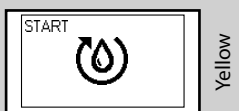

## USING THE MACHINE FOR THE FIRST TIME

When using the machine for the first time, the following activities need to happen:

- 1) You need to prime the circuit;
- 2) The machine will perform an automatic rinse/ self-cleaning cycle;
- 3) You need to initiate a manual rinse cycle.

### Circuit priming

During this process fresh water flows through the internal circuit of the machine and the machine warms up. This takes a few minutes.

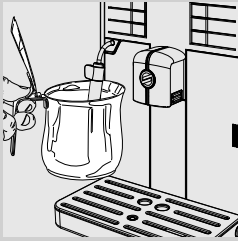

- 1 Place a container under the Classic Milk Frother.

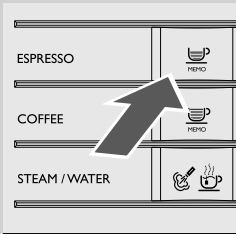

- 2 Press the "MEMO" button to start the cycle. The machine starts the automatic priming of the circuit by dispensing some water through the Classic Milk Frother.



Yellow

- 3 The bar under the icon shows the operation progress. When the process is completed, the machine stops dispensing automatically.

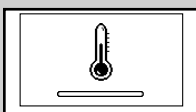

Yellow

- 4 Then the control panel shows the machine warm-up icon.

### Automatic rinse/self-cleaning cycle

When warm-up is completed, the machine automatically performs a rinse/self-cleaning cycle of the internal circuit with fresh water. This takes less than a minute.



- 1 Place a container under the coffee dispensing spout to catch the small amount of water which will be dispensed.



Yellow

- 2 The machine shows this display. Wait for the cycle to finish automatically.



**Note:**

You can stop dispensing by pressing the "☕" button.

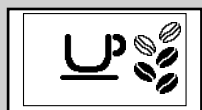

Green

- 3 When the above steps have been completed, the machine shows this display. You can now proceed with the manual rinse cycle.

### Manual rinse cycle

During this process you activate the coffee brewing cycle and fresh water flows through the water circuit. This takes a few minutes.

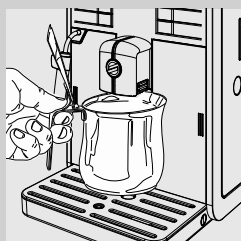

- 1 Place a container under the coffee dispensing spout.





Green

2 Check that the machine shows this display.



Green

3 Select the pre-ground coffee brewing function by pressing the “☕” button. The machine shows this display.



**Note:**

Do not add pre-ground coffee into the compartment.

4 Press the “☕” button. The machine starts dispensing water.

5 When the dispensing has finished, empty the container. Repeat the operations from step 1 to step 4 twice, then continue with step 6.

6 Place a container under the Classic Milk Frother.

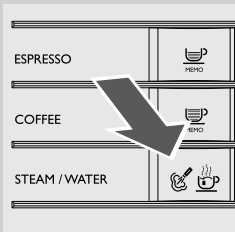

7 Press the “☕” button. The machine shows this display.



Green

8 Press the “☰” MENU button to start dispensing hot water.

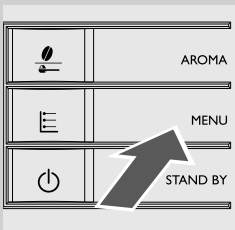



**9** Once the water has been dispensed, remove and empty the container.



Red

**10** Repeat step 7 to 9 until the water tank is empty and the no water icon appears.



**Note:**

You can stop the manual rinsing by pressing the “” button.

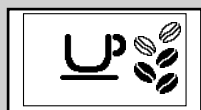
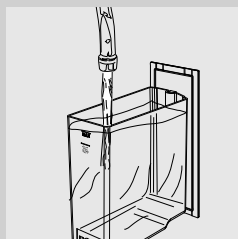

Green

**11** At the end, fill the water tank again up to the MAX level. Now the machine is ready for brewing coffee.  
You will see the display as shown at the left.



**Note:**

When you haven't used the machine for 2 or more weeks, the machine will automatically perform an automatic rinse/self-cleaning cycle after you switch it on. Thereafter you need to initiate the manual rinse cycle as described above.

The automatic rinse/self-cleaning cycle is also initiated when the machine has been in stand-by mode, or switched off, for more than 15 minutes. After this cycle has been completed, you can brew a coffee.

### Measuring and Programming Water Hardness

Measuring water hardness is very important for defining the frequency in which the machine has to be descaled and to install the "INTENZA+" water filter (for more detail on the water filter see next chapter).

To measure the water hardness follow the steps below:

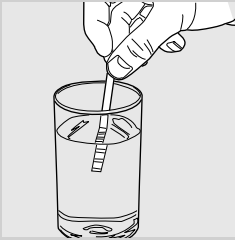

- 1 Immerse the water hardness test strip (supplied with the machine) in water for 1 second.



**Note:**

The test strip can only be used for one measurement.

- 2 Wait for one minute.

- 3 Check how many squares have changed the colour to red and then consult the table.



**Note:**

The numbers on the water hardness test strip correspond to the water hardness adjustment settings.

More precisely:

- 1 = 1 (very soft water)
- 2 = 2 (soft water)
- 3 = 3 (hard water)
- 4 = 4 (very hard water)

The letters correspond to the references that are located at the base of the "INTENZA+" water filter (see next chapter).

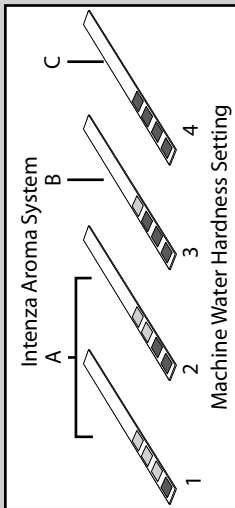

Green

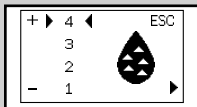

Yellow

- 4 Press the "MENU" button and scroll the pages by pressing the "MENU" button until the following icon is displayed.



**Note:**

The machine is supplied with standard water hardness setting, suitable for most types of water.

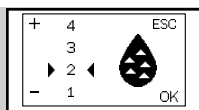

Yellow



Green

**5** Press the “☕” button to increase the value or the “☕” button to decrease the value.

**6** Press the “☰” **MENU** button to confirm the setting.

**7** Press the “☕” button to exit the programming menu. Now the machine is ready to brew.

### “INTENZA+” water filter installation

We recommend you to install the “INTENZA+” water filter as this prevents limescale to build up in your machine and preserves a more intense aroma to your coffee.

You can purchase separately the “INTENZA+” water filter. Please refer to the maintenance products page in this user manual for further details.

Water is a crucial part of every coffee, so it's most important to always have it professionally filtered. Using the “INTENZA+” water filter will prevent mineral deposits from building up and improve your water quality.

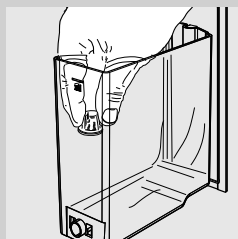

**1** Remove the small white filter from the water tank and store it in a dry place.



- 2** Remove the “INTENZA+” water filter from its packaging, immerse it vertically (with the opening positioned upwards) in cold water and gently press the sides so as to let the air bubbles out.

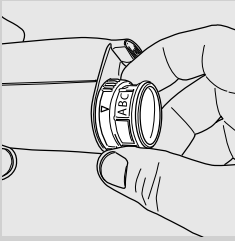

- 3** Set the “INTENZA+” water filter according to the measurements performed (see previous chapter) and indicated on the base of the filter:  
 A = soft water – equals 1 or 2 on the test strip  
 B = hard water (standard) – equals 3 on the test strip  
 C = very hard water – equals 4 on the test strip

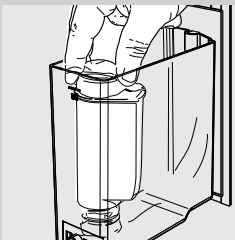

- 4** Insert the “INTENZA+” water filter into the empty water tank. Press it until it cannot move further down.

- 5** Fill the water tank with fresh water and reinsert it into the machine.

- 6** Dispense all the water of the tank by using the hot water function (see chapter “Hot water dispensing”).

- 7** Fill the water tank again.

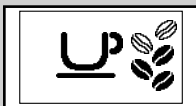

Green

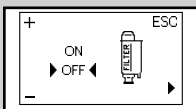

Yellow

- 8** Press the “☰” **MENU** button and scroll the pages by pressing the “▶” **MENU** button until the following icon is displayed.

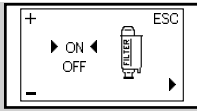

Yellow

**9** Press the “☕” button to select “ON” and press the “☰” **MENU** button to confirm.



Green

**10** To exit, press the “☕” button. Now the machine is ready to brew.

In this way the machine has been programmed to inform the user of the need to replace the “INTENZA+” water filter.

### Replacing the “INTENZA+” water filter

When the “INTENZA+” water filter needs to be replaced with a new one, the following icon is displayed.



Yellow

**1** Replace the “INTENZA+” water filter as described in the previous chapter.

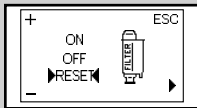

Yellow

**2** Press the “☰” **MENU** button and scroll the pages by pressing the “☰” **MENU** button until the following icon is displayed.

**3** Select the “RESET” option. Press the “☰” button to confirm.



Green

**4** To exit, press the “☕” button. Now the machine is ready to brew.

The machine is now programmed to manage a new filter.

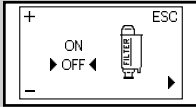

Yellow

**Note:**

If the “INTENZA+” water filter is already installed and you want to remove but not replace it, select the “OFF” option instead.

If there is no “INTENZA+” water filter installed, insert the small white filter previously removed into the water tank.

## CHANGING COFFEE BEANS

The machine comes with a removable coffee bean hopper so you can switch easily from one type of coffee bean to another and enjoy a different coffee taste.

**Note:**

You can buy an additional coffee bean hopper as accessory (CA6803). To preserve its taste you can store coffee beans in the bean hopper in the refrigerator.

### Removing the coffee bean hopper

To remove the coffee bean hopper follow the steps below:

**1** Turn the selector to the “☑” position.

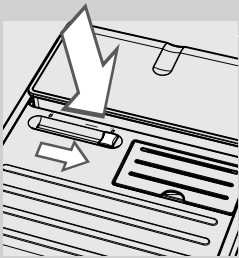
**Caution:**

**it may happen that the selector can not be switched as it is blocked by coffee beans. In this case move the selector back and forth until the beans are released.**

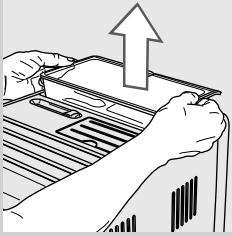

**2** Lift the sides of the coffee bean hopper with both hands as shown in the image.



**Caution:**

**Do not remove the bean hopper in a different way to avoid spilling coffee beans.**

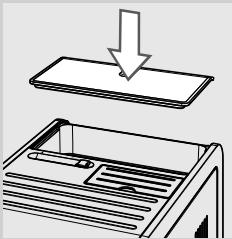

**3** After removal put the protection cover on the machine to prevent dust.

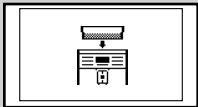

Red



**Note:**

if you turn on the machine while the coffee bean hopper has not been inserted, the following icon appears. You need to insert the bean hopper first.

---

### Inserting the coffee bean hopper

To insert the coffee bean hopper follow the steps below:

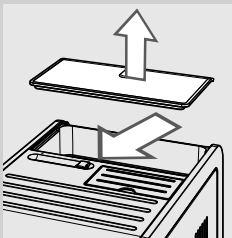

**1** Remove the protection cover from the machine.

**2** Switch the selector to the “” position.



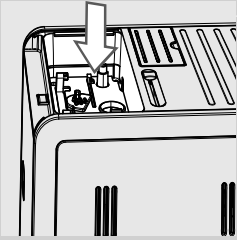

**3** Remove any beans from the coffee bean hopper compartment.

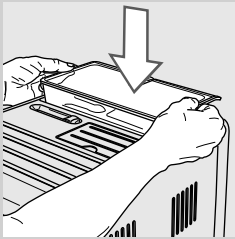

**4** Insert the coffee bean hopper into the compartment as shown on the image.

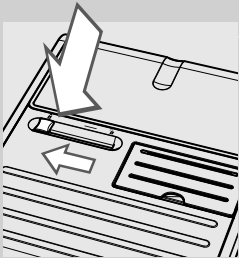

**5** Switch the selector to the "0" position.



**Warning:**

**Please be aware that when you change coffee blend and switch to decaffeinated coffee, still some caffeine traces might be present even after having run the emptying cycle.**

## Coffee bean selection

This function allows you to optimize the grinding for selected type of coffee beans.

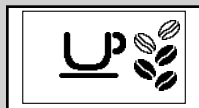

Green



Yellow

- 1 Press the "☰" **MENU** button and scroll the pages by pressing the "☰" **MENU** button until the following icon is displayed.

- 2 Press the "☺" button or the "☺" button to select the type of coffee beans in the coffee bean hopper.

- 3 Press the "☰" **MENU** button to confirm the setting.

- 4 To exit, press the "☺" button.

The machine is now programmed to optimise the grinding of your coffee beans.

The display shows the type of coffee beans chosen when the machine is ready for brewing.

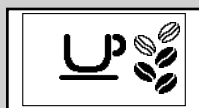

Green

- for "ARABICA" coffee beans

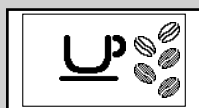

Green

- for "ROBUSTA" coffee beans

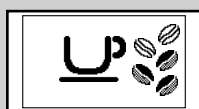

Green

- for a "MIX" of coffee beans.

## Coffee emptying cycle

If you want to change coffee beans, we recommend that you empty the coffee duct and grinder. In this way you will taste the full aroma of the new coffee beans. For this follow the steps below.

**1** Insert the coffee bean hopper with the new coffee beans.



Green

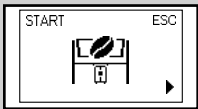

Yellow

**2** Press the “☰” **MENU** button and scroll the pages by pressing the “☰” **MENU** button until the following icon is displayed.

**3** Press the “☺” button.



Yellow

**4** The machine performs two grinding cycles without brewing coffee.

 **Note:**

You can stop the grinding cycle early by pressing the “☺” button between the first and second grinding cycle.

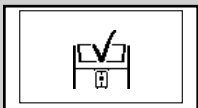

Green

**5** When the grinding cycles have been finished, the following icon is displayed.

 **Note:**

If you have not emptied the coffee duct and grinder, you need to brew at least two coffees before you can taste the new coffee beans.

 **Warning:**

**Please be aware that when you change coffee blend and switch to decaffeinated coffee, still some caffeine traces might be present even after having run the emptying cycle.**

## ADJUSTMENTS

The machine allows for certain adjustments so that you can brew the best possible coffee tasting.

### Saeco Adapting System

Coffee is a natural product and its characteristics may change according to its origin, blend and roast. The machine is equipped with a self-adjusting system that allows the use of all types of coffee beans available on the market apart from caramelized and flavored coffee beans.

The machine automatically adjusts itself after brewing several cups of coffee to optimize the extraction of the coffee .

### Adjusting the Ceramic Coffee Grinder

Ceramic coffee grinders always guarantee accurate and perfect grinding and coarseness for every coffee specialty.

This provides for full aroma preservation, delivering the truly Italian taste in every cup.



#### **Warning:**

**The ceramic coffee grinder contains moving parts that may be dangerous. Therefore, do not insert fingers and/or other objects. Only adjust the ceramic coffee grinder using the grinder adjustment key.**

You can adjust the ceramic grinders to set the coffee grinding to your personal taste.

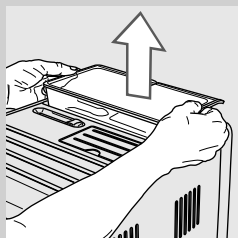

- 1 Remove the coffee bean hopper as shown in the section "Removing the coffee bean hopper".

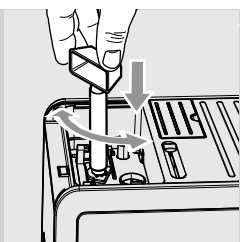

2 Press and turn the grinder adjustment knob under the coffee bean hopper one notch at a time. Use the coffee grinder adjustment key provided with the machine. You will taste the difference after brewing 2-3 cups of coffee.

 **Warning:**

**Do not turn the grinder more than 1 notch at the time to prevent damage.**

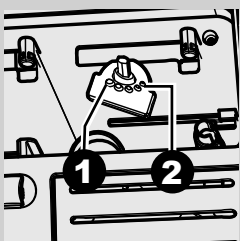

3 The reference marks in the compartment for the coffee bean hopper indicate the grind setting. There are 5 different grind settings to choose from position 1 for coarse grind - lighter taste to position 2 for fine grind - bolder taste.

When you adjust the ceramic coffee grinder to a finer setting, your coffee will taste stronger. For a milder coffee taste, adjust the ceramic coffee grinder to a coarser setting.

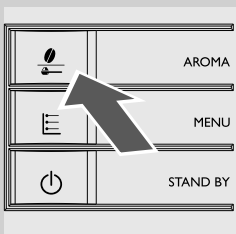

### Adjusting the aroma (coffee strength)

Choose your favourite coffee blend and adjust the amount of coffee to be ground until they meet your personal taste. You can also select the pre-ground coffee function.



 **Note:**

Selection must be made prior to selecting coffee.



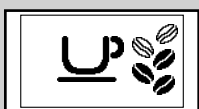

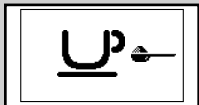

Five choices are possible by pressing the "" button. Each time the "" button is pressed, the aroma changes by one degree, according to the selected amount:



Green



Green

 = extra mild aroma  
 = mild aroma  
 = medium aroma  
 = strong aroma  
 = extra strong aroma  
 = pre-ground coffee

### Adjusting the coffee dispensing spout

The height of the dispensing spout can be adjusted to better fit the dimensions of the cups that you wish to use.

Move the dispensing spout up or down with your fingers to adjust its height as shown in the image.

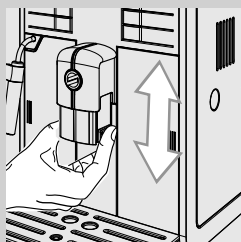

The recommended positions are:  
For the use of small cups.

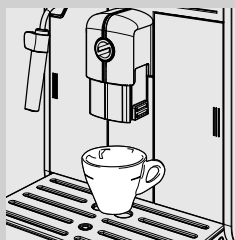

For the use of large cups.



For the use of glasses for the Latte Macchiato.

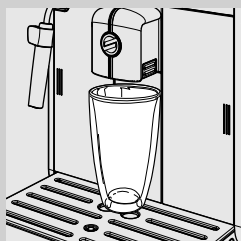

Two cups can be placed under the dispensing spout to brew two coffees at the same time.

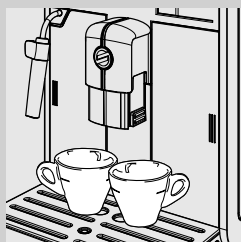

## Adjusting the Coffee Length

The machine allows you to adjust the amount of brewed coffee according to your taste and/or the size of your cups.

Each time the “MEMO” or “MEMO” button is pressed, the machine brews a pre-set amount of coffee. Each button may be individually programmed for a specific brew setting.

The following procedure describes the programming of the “MEMO” button.



- 1 Place a cup under the dispensing spout.



Green

- 2 Press and hold the “MEMO” button until the “MEMO” icon is displayed. Then release the button. The machine is now programming. The machine starts brewing coffee.



Green

- 3 Press the “MEMO” button as soon as the desired amount of coffee is reached.

Now the “MEMO” button is programmed; each time it is pressed, the machine will brew the same amount of espresso that was just programmed.



### Note:

To program the coffee “MEMO” button, the same steps should be followed. You should always use the “MEMO” button to stop brewing coffee when the desired amount of coffee is reached even when you are programming the coffee “MEMO” button.

## ESPRESSO AND COFFEE BREWING

Before brewing the coffee, make sure that there are no warnings shown on the control panel, and that the water tank and coffee bean hopper are filled.

### Espresso and coffee brewing using coffee beans

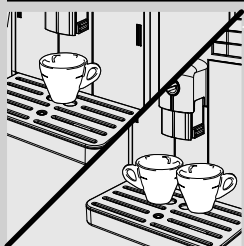

- 1 Place 1 or 2 cups under the dispensing spout.

- 2 To brew an espresso or a coffee, press the “☕” button to select the desired aroma.

- 3 Press the “☕” button for an espresso or “☕” button for a coffee.

- 4 To brew 1 cup of espresso or coffee, press the desired button once. This icon will be displayed.

- 5 To brew 2 cups of espresso or coffee, press the desired button twice consecutively. This icon will be displayed.

#### Note:

In this operating mode, the machine automatically grinds and doses the correct amount of coffee. Brewing two espressos or two coffees requires two grinding and brewing cycles, automatically carried out by the machine.

- 6 After the pre-brewing cycle, coffee begins to pour out of the dispensing spout.

- 7 Coffee brewing automatically stops when the pre-programmed level is reached; press the “☕” button to stop it earlier.



Green



Green



### Espresso and coffee brewing using pre-ground coffee

This function allows you to use pre-ground and decaffeinated coffee.

With the pre-ground coffee function you can only brew one coffee at a time.



Green





**1** Press the “” button to select the pre-ground coffee function.

**2** Lift the pre-ground coffee compartment lid and add one scoop of pre-ground coffee to the compartment. Use only the measuring scoop supplied with the machine. Then close the pre-ground coffee compartment lid.



**Warning:**

**Add only pre-ground coffee to the pre-ground coffee compartment. Other substances and objects may cause severe damages to the machine. Such damages will not be covered by warranty.**

**3** Press the “” button for an espresso or “” button for a coffee. The brewing cycle starts.

**4** After the pre-brewing cycle, coffee begins to pour out of the dispensing spout.

**5** Coffee brewing automatically stops when the preset level is reached; press the “” button to stop it earlier.

After brewing, the machine returns to the main menu.

Repeat the steps described above to brew more coffees using pre-ground coffee.



**Note:**

If no pre-ground coffee is poured into the pre-ground coffee compartment, only water will be dispensed.

If more scoops have been added, the machine will not brew the product and any ground coffee will be discharged into the coffee grounds drawer.

## STEAM DISPENSING/CAPPUCCINO BREWING

**Warning:**

**Danger of scalding! Dispensing may be preceded by small jets of hot water. The Classic Milk Frother may reach high temperatures: Never touch it with bare hands. Use the appropriate protective handle only.**

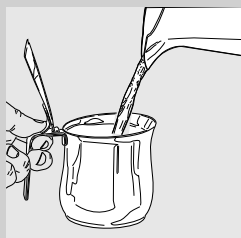

- 1 Fill 1/3 of a container with cold milk.

**Note:**

Use cold (~5°C / 41°F) milk with a protein content of at least 3% to ensure optimum results when preparing a cappuccino. You can use whole milk or low-fat milk depending on your personal taste.

**Note:**

When you plan to dispense steam right after switching on the machine or after brewing a coffee, some water still present in the circuit may need to be dispensed first.

For this press the “☞☕” button and then the “☕” button to dispense steam for a few seconds. Thereafter press the “☕” button to stop. Proceed with step 2.



- 2 Immerse the Classic Milk Frother in the milk.

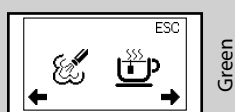
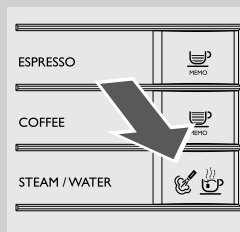

- 3 Press the “☞☕” button. The machine shows this display.

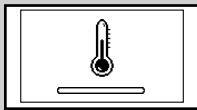
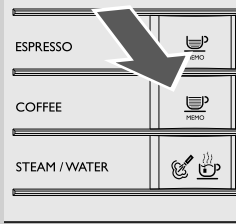

Yellow



Green

4 Press the “☕” button to start dispensing steam.

5 The following icon is displayed during pre-heating time required by the machine.

6 Froth the milk by gently swirling the container and moving it up and down.

7 When the milk froth has the desired consistency, press the “☕” button to stop dispensing steam.

**Note:**

After having pressed the “☕” button it will take a few seconds before the machine stops dispensing completely.

8 To prepare a cappuccino place your cup with frothed milk under the coffee dispensing spout and brew an espresso. See chapter “Espresso and coffee brewing” for detailed instructions.

**Caution:**

**Each time after frothing the milk you need to dispense a small amount of hot water into a container. Remove the external part of the Classic Milk Frother and wash it with lukewarm water.**

## HOT WATER DISPENSING

**Warning:**

**Danger of scalding! Dispensing may be preceded by small jets of hot water. The Classic Milk Frother may reach high temperatures: never touch it with bare hands. Use the appropriate protective handle only.**

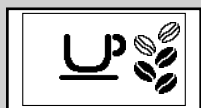

Green

Before dispensing hot water, check that the machine is ready to use and the water tank is filled.



- 1 Place a container under the Classic Milk Frother.



- 2 Press the “☕” button. The machine shows this display.



Green

- 3 Press the “☰” MENU button to start dispensing hot water.

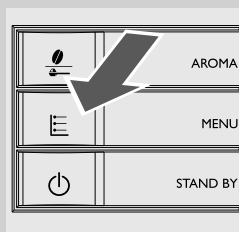

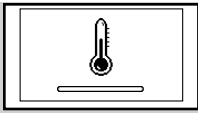

Yellow

- 4 The following icon is displayed during pre-heating time required by the machine.



Green

- 5 Pour the desired amount of hot water. To stop the hot water dispensing, press the “” button.

## CLEANING AND MAINTENANCE

### Daily Cleaning of the Machine



#### Caution:

**Timely cleaning and maintenance of your machine is very important as it prolongs the life of your machine. Your machine gets exposed to moist, coffee and lime scale continuously!**

**In this chapter it is described in detail which activities you need to perform at which frequency. Not doing this will ultimately make your machine stop working properly. This repair is NOT covered by your warranty.**



#### Note:

- Use a soft, dampened cloth to clean the machine.
- You may only wash the cup holder grill in the washing machine; the other parts need to be washed in lukewarm water.
- Do not immerse the machine in water.
- Do not use alcohol, solvents, and/or abrasive objects to clean the machine.
- Do not dry the machine and/or its components using a microwave and/or standard oven.

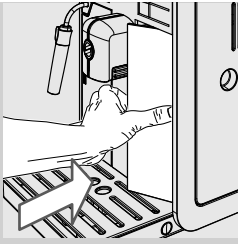

- 1 Empty and clean the coffee grounds drawer daily with the machine turned on.
  - Push gently on the edge of the door of the coffee grounds drawer to release the handgrip.
  - Remove the coffee grounds drawer by pulling the handgrip.

Other maintenance operations can only be carried out when the machine is turned off and unplugged.

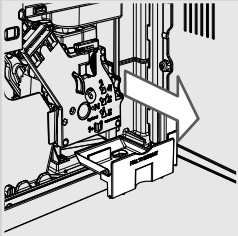
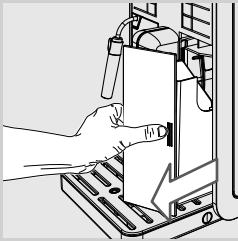

- 2 Empty and clean the coffee residues drawer located inside of the machine. Open the service door, remove the drawer and empty it.

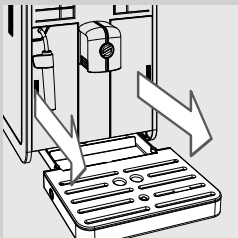

- 3 Remove the drip tray. Empty and clean the drip tray.

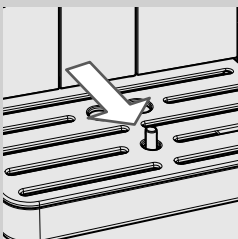

 **Note:**  
Empty the drip tray also when the full drip tray indicator is raised.

### Daily cleaning of the water tank

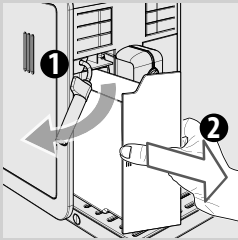

- 1** Remove the small white filter or the INTENZA+ water filter (if installed) from the water tank and wash it with fresh water.
- 2** Put the small white filter back or the INTENZA+ water filter (if installed) in its housing by gently pressing and turning it at the same time.
- 3** Fill the water tank with fresh water.

### Daily Cleaning of the Classic Milk Frother

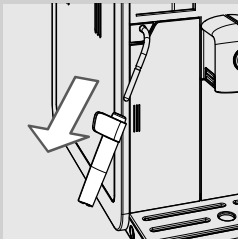

It is important that you clean the Classic Milk Frother daily or after each use as it preserves hygiene and ensures perfect milk froth consistency.

Each time after frothing the milk you need to dispense a small amount of hot water into a container.

Remove the external part of the Classic Milk Frother and wash it with lukewarm water.

### Weekly Cleaning of the Machine

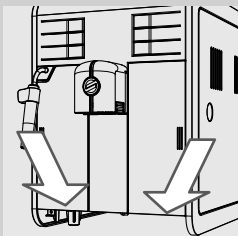

- 1** Clean the seat of the drip tray.

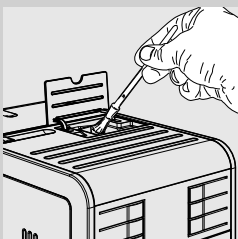

- 2** Clean the pre-ground coffee compartment with the cleaning brush.

### Weekly Cleaning of the Classic Milk Frother

The weekly cleaning is more thorough, since you need to disassemble all the Classic Milk Frother components.

The following cleaning operations are required:

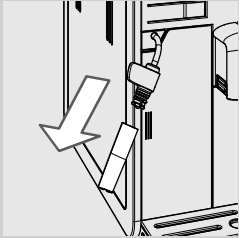

- 1 Remove the external part of the Classic Milk Frother. Wash it with luke-warm water.

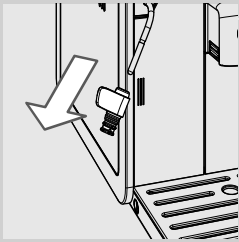

- 2 Remove the upper part of the Classic Milk Frother from the hot water/steam wand.

- 3 Wash the upper part of the Classic Milk Frother with fresh water.

- 4 Clean the hot water/steam wand of the Classic Milk Frother with a wet cloth to remove milk residues.

- 5 Put the upper part back into the steam/hot water wand (make sure it is completely inserted).

- 6 Reassemble the external part of the Classic Milk Frother.



#### Note:

You can also clean these parts in the dishwasher.

### Weekly Cleaning of the Brew Group

The brew group should be cleaned every time the coffee bean hopper is filled or at least once a week.

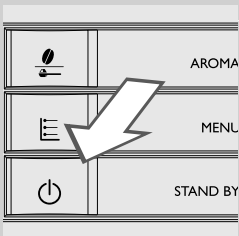

- 1 Turn off the machine by pressing the "⏻" button and unplug the power cord.



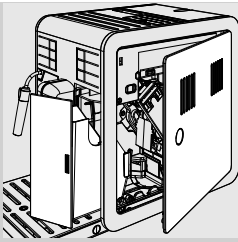

**2** Remove the coffee grounds drawer. Open the service door.

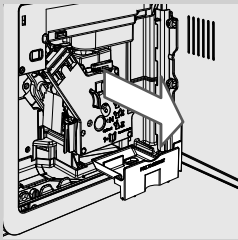

**3** Remove and clean the coffee residues drawer.

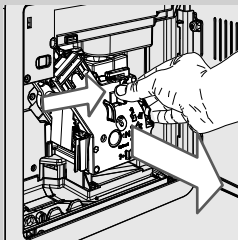

**4** To remove the brew group, press the «PUSH» button and pull it by the handle.

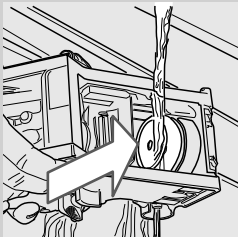

**5** Thoroughly wash the brew group with fresh, lukewarm water and carefully clean the upper filter.



**Caution:**

**Do not use detergent/soap to clean the brew group.**

**6** Let the brew group air-dry thoroughly.

**7** Thoroughly clean the inside of the machine using a soft, dampened cloth.

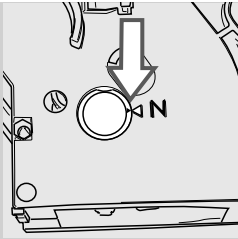

- 8** Make sure the brew group is in the rest position; the two reference signs must match. If they do not match, proceed as described in step (9).

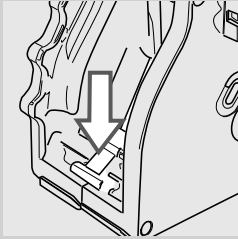

- 9** Gently pull down the lever until it touches the brew group base and the two reference signs on the side of the brew group do match.

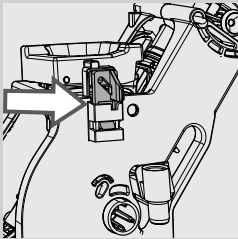

- 10** Make sure the hook to lock the brew group is in the correct position by firmly pressing the "PUSH" button until it locks into place. Check if the hook is at the top end position. If it is not, please try again.

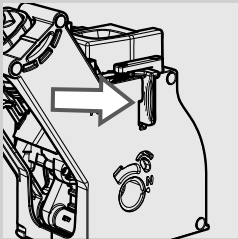

- 11** Insert the brew group in its seat again until it locks into place without pressing the "PUSH" button.

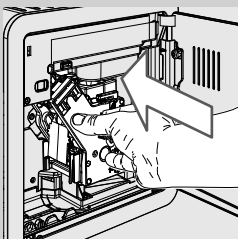

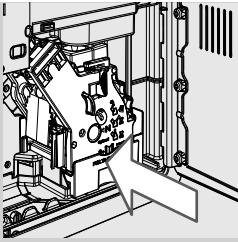

**12** Insert the coffee residues drawer and close the service door.

**13** Insert the coffee grounds drawer.

---

### **Weekly cleaning of the coffee bean hopper, the tray and the compartment**

Clean the coffee bean hopper, the tray and the coffee bean hopper compartment once a week with a cloth to remove any coffee residuals or dust.

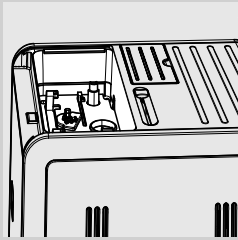

To remove the tray push the hooks on the bottom of the coffee bean hopper. This is shown in the picture on the left.

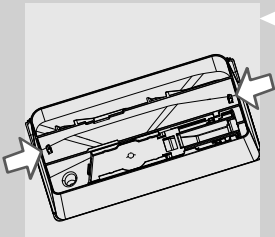

After cleaning put the tray back into the coffee bean hopper.

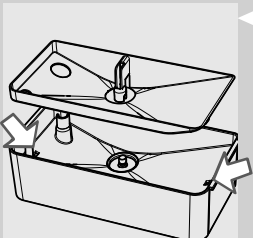

### Monthly Lubrication of the Brew Group

Lubricate the brew group after approximately 500 cups of coffee or once a month.

You can purchase separately the Saeco grease to lubricate the brew group. For further details, please refer to the maintenance products page in this manual.

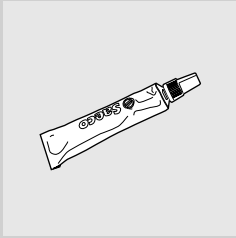

**!** **Caution:**

**Before lubricating the brew group, clean it with fresh water and dry it as described in the “Weekly Cleaning of the Brew Group” chapter.**

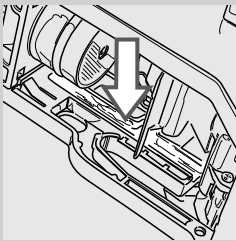

- 1 Apply the grease evenly on both side guides.

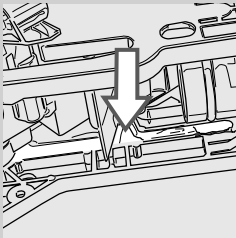

- 2 Lubricate the shaft too.

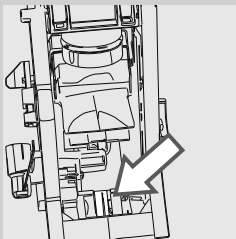
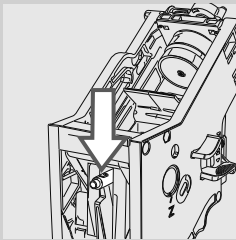

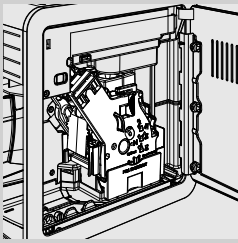

**3** Insert the brew group in its seat until it locks into place (see “Weekly Cleaning of the Brew Group” chapter). Insert the coffee residues drawer.

**4** Close the service door. Insert the coffee grounds drawer.

### Monthly Cleaning of the Brew Group with “Coffee Oil Remover”



Besides weekly cleaning, we recommend running the cleaning cycle with “Coffee Oil Remover” after approximately 500 cups of coffee or once a month. This operation completes the maintenance process of the brew group.

You can purchase separately the “Coffee Oil Remover”. For further details, please refer to the maintenance products page in this manual.



#### Caution:

**The “Coffee Oil Remover” tablets are to be used for cleaning only and do not have a descaling function. For the descaling procedure use the Saeco descaling solution and follow the procedure described in the “Descaling” chapter.**

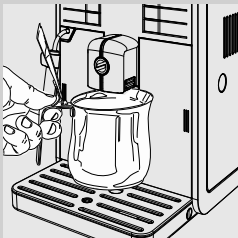

**1** Place a container under the coffee dispensing spout.

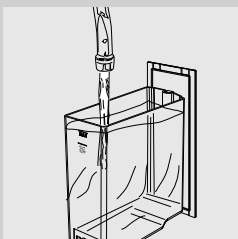

**2** Make sure the water tank is filled with fresh water up to the “MAX” level.

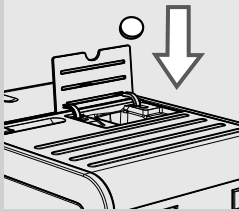

Green

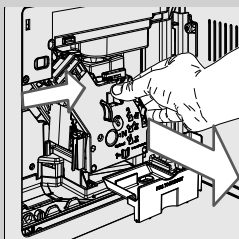
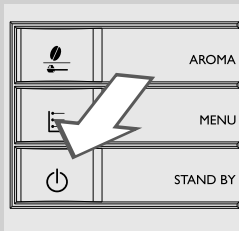
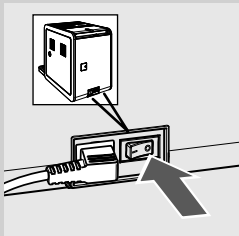

**3** Put a “Coffee Oil Remover” tablet in the pre-ground coffee compartment.

**4** Press the “” button one or more times to select the pre-ground coffee function. Do not add ground coffee.

**5** Press the “” button to start a coffee brewing cycle.

**6** Wait until the machine has dispensed half a cup of water.

**7** Switch the power button on the back of the machine to “0”.

**8** Let the solution take effect for approximately 15 minutes. Make sure you discard the dispensed water.

**9** Switch the power button on the back of the machine to “I”. To turn on the machine press the “” button. Wait until the automatic rinse cycle has been completed.

**10** Remove the coffee grounds drawer and open the service door. Remove the coffee residues drawer and then the brew group.

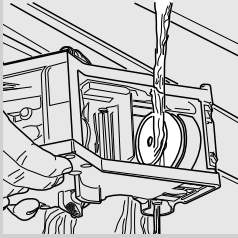

**11** Wash the brew group thoroughly with fresh water.

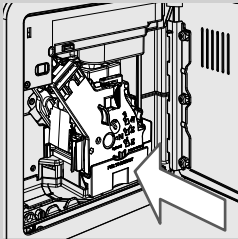

**12** After rinsing the brew group, insert it again in its seat until it locks into place (see the "Weekly Cleaning of the Brew Group" chapter). Insert the coffee residues drawer and the coffee grounds drawer. Close the service door.



Green

**13** Press the "☕" button to select the pre-ground coffee function. Do not add coffee to the pre-ground coffee compartment.

**14** Press the "☕" button to start a coffee brewing cycle.

**15** Repeat steps 13 to 14 twice. Empty the container.

**16** To clean the drip tray, place "Coffee Oil Remover" tablet inside and fill it 2/3rds full with hot water. Let the cleaning solution take effect for about 30 minutes, then rinse thoroughly.

## DESCALING

The descaling process takes approx. 35 minutes.

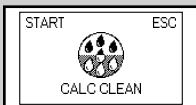

Yellow

Limescale builds up inside the machine during use. It needs to be removed regularly as it may clog the water and coffee circuit of your machine. The machine tells you when descaling is needed. If the machine display shows the CALC CLEAN icon, it means that you need to descale.



### Caution:

**Not doing this will ultimately make your machine stop working properly, and in this case repairing is NOT covered by your warranty.**



Use the Descaling solution only. Its formula has been designed to ensure better machine performance.

You can purchase separately the Descaling solution. Please refer to the maintenance products page in this user manual for further details.



**Warning:**

**Never drink the descaling solution or any products dispensed until the cycle has been carried out to the end. Never use vinegar as a decalcifier.**



**Note:**

During the descaling cycle do not switch off the machine. If this has happened you have to restart the descaling cycle to fully complete it. It will restart from the point the descaling cycle had previously been left.

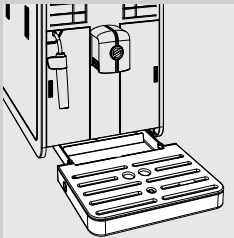

To perform the descaling cycle, follow the steps below:

Before descaling:

**1** Empty the drip tray.

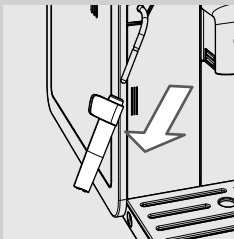

**2** Remove the Classic Milk Frother from the steam/hot water wand.

**3** Remove the "INTENZA+" water filter from the water tank if it was installed and replace it with the small white original one. Place the water tank back into the machine.



Green

**4** Press the "U" **MENU** button and scroll the pages by pressing the "U" **MENU** button until the following icon is displayed.

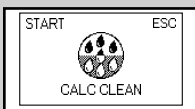

Yellow

**5** Press the "U" button to start the descaling process.



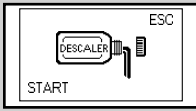

Yellow

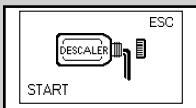
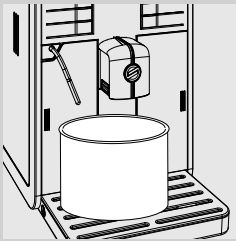
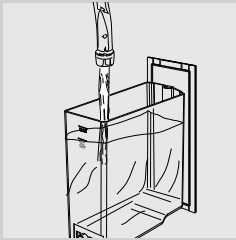
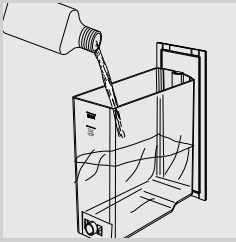

Yellow

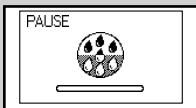

Yellow



**Note:**

If you press the “☺” button by mistake, press the “☺” button to quit.

**6** Remove the water tank and pour the entire content of the descaling solution. Then fill the water tank with fresh water up to the CALC CLEAN level.

**7** Place the water tank back into the machine.

**8** Place a large container (1.5 l) under both the steam/hot water wand and the dispensing spout.

**9** Press the “☺” button to start the descaling cycle.

**10** The machine will start dispensing the descaling solution at intervals. . The bar on the display shows the cycle progress.

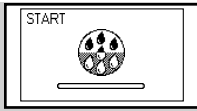

Yellow



**Note:**

The descaling cycle may be paused by pressing the “☕” button. To resume the cycle, press the “☕” button again. This allows you to empty the container or to stay away from the machine for a brief period of time.



Red

**11** When this icon is displayed, the water tank is empty.

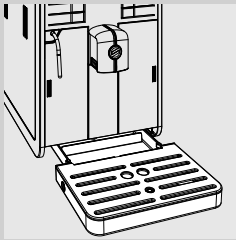

**12** Remove and empty the container.

**13** Empty the drip tray and place it back.

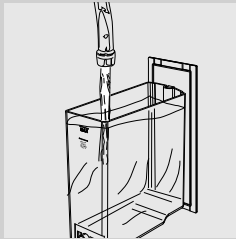

Yellow

**14** Remove the water tank, rinse it and fill it up to the MAX level with fresh water. Place it back into the machine. When inserting the water tank into the machine, the display on the left is shown.

**15** Put the container back under both the steam/hot water wand and the dispensing spout.

**16** Press the “☕” button to start the rinsing cycle.



Red

**17** When this icon is displayed, the water tank is empty. Repeat steps 12 to 16. Then go to step 18.

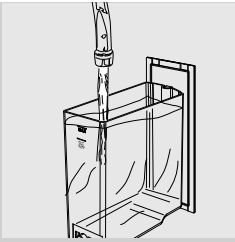

**18** When the water tank is empty, remove the water tank, rinse it and fill it up to the MAX level with fresh water. Place it back into the machine.

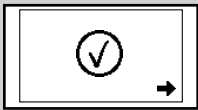

Green

**19** Empty the container and place it back under under both the steam/hot water wand and the dispensing spout.

**20** When the amount of water needed for the rinse cycle has been completely dispensed, this icon on the side is displayed. Press the "☰" **MENU** button to quit the descaling cycle.



Yellow

**21** Press the "☕" button to prime the circuit.

**22** The machine now carries out the warm-up and automatic rinse cycle to prepare for product brewing.

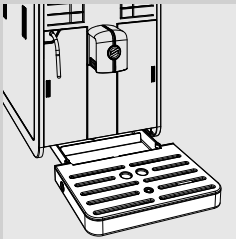

**23** Remove and empty the container

**24** Empty the drip tray and place it back.

**25** The descaling cycle is now complete.

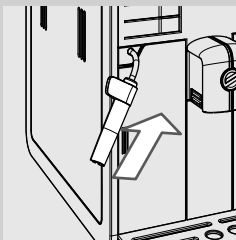

**26** Remove the small white water filter and place back the "INTENZA+" water filter into the water tank if it was installed and the Classic Milk Frother.

**Note:**

At the end of the descaling cycle, wash the brew group as described in the "Weekly Cleaning of the Brew Group" chapter.

The two rinse cycles are performed in order to have the circuit cleaned with a preset amount of water and ensure proper machine operation. If the water tank is not filled up to MAX level, the machine might require three or more cycles.

## PROGRAMMING

You can adjust the machine functions to your personal preference by accessing the program menu.

### The following parameters can be adjusted

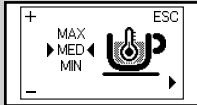

Yellow

#### Coffee temperature

This function allows you to adjust the coffee brewing temperature.



Yellow

#### Coffee bean selection

This function allows you to optimize the grinding for selected type of coffee bean.

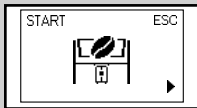

Yellow

#### Coffee duct emptying cycle.

This function allows you to empty the coffee duct and grinder before changing coffee beans.

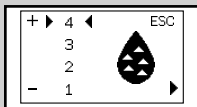

Yellow

#### Water hardness

This function allows you to adjust the water hardness setting according to the area where you live.

- 1 = very soft water
- 2 = soft water
- 3 = hard water
- 4 = very hard water

For more details please see the "Measuring and Programming Water Hardness" chapter.

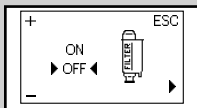

Yellow

#### "INTENZA+" Water Filter

This function allows you to manage the "INTENZA+" water filter. For more details, see the chapter related to filter handling.

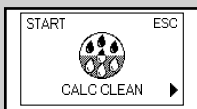

Yellow

#### Descaling cycle

This function allows you to run the descaling cycle.

## How to program your machine

In this example, it is shown how to program the coffee temperature. Proceed in the same way to program the other functions. The programming menu can only be accessed when the machine is on and shows this display.



Green

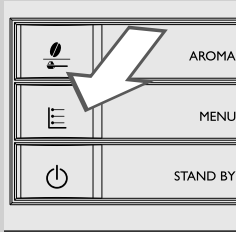

**1** Press the "☰" **MENU** button to enter the menu.

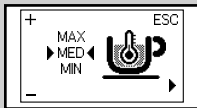

Yellow

**2** The first page is displayed.

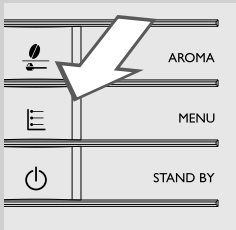

**3** Press the "☰" **MENU** button to scroll the functions until displaying the coffee temperature management function.

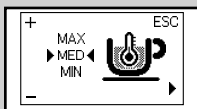

Yellow

**4** Press the "☺" and "☹" buttons to increase or decrease the value of the function.

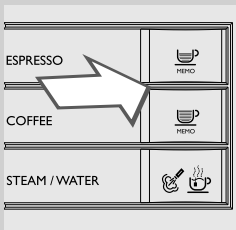



Yellow

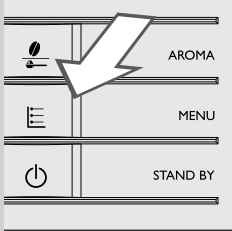

- 5 When the display value is changed, the "OK" message appears. Press the "☰" **MENU** button to confirm the change.

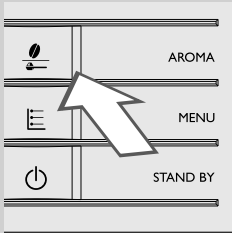

- 6 Press the "☕" button to exit the programming menu.

 **Note:**

The machine will automatically exit the programming menu if you do not push any button for 3 minutes. The values that have been changed but not confirmed won't be saved.

**MEANING OF THE DISPLAY SYMBOLS**

This machine is equipped with a colour-coded system to make the user's understanding of the display signals easier. The icons are colour-coded according to the traffic light principle.

**Ready Signals (Green Colour)**

	The machine is ready to brew coffee with Arabica coffee beans
	The machine is ready to brew coffee with Robusta coffee beans
	The machine is ready to brew coffee with a mix of coffee beans
	The machine is ready to brew pre-ground coffee.
	Steam or hot water selection.
	Hot water dispensing.
	Steam dispensing
	The machine is brewing one cup of espresso.
	The machine is brewing one cup of coffee.
	The machine is brewing two cups of espresso.

**Ready Signals (Green Colour)**

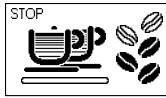

The machine is brewing two cups of coffee.

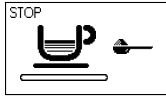

Coffee brewing using pre-ground coffee in progress.



The machine is programming the amount of coffee to brew.



**Warning Signals (Yellow Colour)**

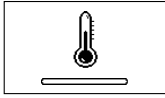

The machine is heating up to brew beverages or dispense hot water.



The machine is performing the rinse cycle. Wait until the machine has completed the cycle.



The machine needs the "INTENZA+" water filter to be replaced.



The brew group is being reset due to machine reset.



Refill the coffee bean hopper with coffee beans and restart the cycle.

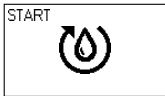

Prime the circuit.

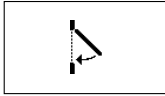

The machine needs to be descaled. Press the "☺" button to start the descaling process. Follow the steps described in the descaling chapter of this manual.  
 If you want to descale later, press the "☺" button to continue using the machine.  
Please note that not descaling your machine will ultimately make it stop working properly. In this case repair is NOT covered under your warranty.

**Warning Signals (Red Colour)**

Close the service door.



Fill the coffee bean hopper.

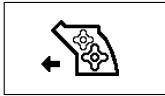

The brew group must be inserted into the machine.

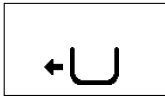

Insert the coffee grounds drawer.

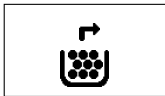

Empty the coffee grounds drawer and the coffee residues drawer.

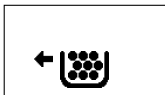

Fully insert the coffee grounds drawer before turning the machine off.

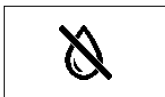

Fill the water tank.

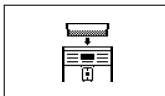

Insert the coffee bean hopper.

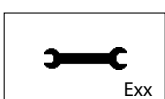



Turn off the machine. After 30-seconds, turn it back on. Try this 2 or 3 times. If the machine does not start, contact the Philips SAECO hotline in your country and communicate the Error-code which you see on the display. You can find its contact details in the warranty booklet by-packed separately or on [www.philips.com/support](http://www.philips.com/support).

## TROUBLESHOOTING

This chapter summarizes the most common problems you could encounter with your machine.

If you are unable to solve the problem with the information below, visit [www.philips.com/support](http://www.philips.com/support) for a list of frequently asked questions or contact the Philips Saeco hotline in your country.

The contact details can be found in the warranty booklet packed separately or on [www.philips.com/support](http://www.philips.com/support).

Machine actions	Causes	Solutions
The machine does not switch on.	The machine is not connected to the electric network. The power button is on position "0".	Connect the machine to the electric network. Check that the power button is set to "I".
The drip tray gets filled although no water is drained.	Sometimes water is drained automatically by the machine into the drip tray to manage the rinsing of the circuits and ensure optimum machine performance.	This is seen as normal machine behavior.
The red  icon is always displayed on the machine.	The coffee grounds drawer has been emptied with the machine off.	The coffee grounds drawer must always be emptied with the machine on. Wait until the  icon is displayed before refitting the drawer.
Coffee is not hot enough.	The cups are cold.	Preheat the cups with hot water.
No hot water or steam is dispensed.	The hole of the hot water / steam wand is clogged.  Classic Milk Frother is dirty.	Clean the hole of the steam wand using a pin. <b>Make sure that the machine is off and cold before performing this operation.</b> Clean the Classic Milk Frother.
Coffee does not have enough crema (see note).	The blend is unsuitable, coffee is not freshly roasted or the grind is too coarse.	Change coffee blend or adjust the grind as explained in chapter "Adjusting the Ceramic Coffee Grinder".
The machine takes a long time to warm up or the amount of water dispensed from the wand is too little.	The machine circuit is clogged by limescale.	Descalc the machine.
The brew group cannot be removed.	The brew group is out of place.  The coffee grounds drawer is inserted.	Turn on the machine. Close the service door. The brew group automatically returns to the initial position. Remove the coffee grounds drawer before removing the brew group.
There is a lot of ground coffee under the brew group.	Coffee is not suitable for automatic machines.	It may be necessary to change the type of coffee or the coffee grinder settings.
The machine grinds the coffee beans but no coffee comes out. (see note).	There is no water.  The brew group is dirty.  This might occur when the machine is automatically adjusting the dose. The dispensing spout is dirty. The circuit is not primed.	Fill the water tank and prime the circuit (chapter "Using the Machine for the First Time"). Clean the brew group ("Weekly Cleaning of the Brew Group" chapter). Brew a few coffees as described in chapter "Saeco Adapting System". Clean the dispensing spout. Prime the circuit (chapter "Using the machine for the first time").

Machine actions	Causes	Solutions
Coffee is too weak (see note).	This might occur when the machine is automatically adjusting the dose.	Brew a few coffees as described in chapter "Saeco Adapting System".
	The coffee is too coarse.	Change coffee blend or adjust the grind as explained in chapter "Adjusting the Ceramic Coffee Grinder".
	The coffee bean hopper selector has been shifted.	Switch the selector to the "☰" position.
Coffee is brewed slowly (see note).	The coffee grind is too fine.	Change coffee blend or adjust the grind as explained in chapter "Adjusting the Ceramic Coffee Grinder".
	Circuits clogged.	Perform a descaling cycle.
	The brew group is dirty.	Clean the brew group ("Weekly Cleaning of the Brew Group" chapter).
	The circuit is not primed.	Prime the circuit (chapter "Using the machine for the first time").
Coffee leaks out of the dispensing spout.	The dispensing spout is clogged.	Clean the dispensing spout and its holes.
The selector is locked.	Some coffee beans may have got stuck.	Move the selector and repeat this movement until the bean is released.
The coffee bean hopper cannot be inserted.	The blade placed under the coffee bean hopper has been shifted.	Shift the blade to the end of its guide covering the hole.
	There may be some coffee beans left in the coffee bean hopper compartment.	Remove the beans.
	The selector is not in the correct position.	Put the selector in the open position.
Coffee does not taste according to the new beans.	You have not emptied the coffee duct and grinder.	You need to brew at least two coffees before you can taste the new coffee beans.
The ☒ is displayed.	The coffee bean hopper selector has been shifted.	Switch the selector to the "☰" position.
	The coffee bean hopper and tray are dirty.	Clean the coffee bean hopper and tray from any coffee residuals. (Chapter "Weekly cleaning of the coffee bean hopper, the tray and the compartment")

**Note:**

These problems can be considered normal if the coffee blend has been changed or if the machine has just been installed. In this case wait until the machine performs a self-adjusting operation as described in section "Saeco Adapting System".

## ENERGY SAVING

### Stand-by

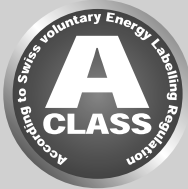

The Saeco full automatic espresso machine is designed for energy saving, as stated by the Class A energy label.

After 30 minutes of inactivity, the machine turns off automatically. If a product has been brewed, the machine performs a rinse cycle.

In stand-by mode, the energy consumption is below 1Wh.

To turn on the machine, press the "⏻" button (if the power button on the back of the machine is set to "I"). If the boiler is cold, the machine performs a rinse cycle.

### Disposal



Do not throw away the machine with the normal household waste at the end of its life, but hand it in at an official waste collection centre for recycling. By doing this, you help to preserve the environment.

- The packing materials can be recycled.
- Machine: unplug the machine and cut the power cord.
- Deliver the appliance and the power cord to a service centre or public waste disposal facility.

This product complies with EU Directive 2002/96/EC.

The symbol on the product or on its packaging indicates that this product may not be treated as household waste. Instead it shall be handed over to the applicable waste collection centre for the recycling of electrical and electronic equipment.

By ensuring this product is disposed of correctly, you will help prevent potential negative consequences for the environment and human health, which could otherwise be caused by inappropriate waste handling of this product. For more detailed information about recycling of this product, please contact your local city office, your household waste disposal service or the shop where you purchased the product.

## TECHNICAL SPECIFICATION

The manufacturer reserves the right to make changes to the technical specifications of the product.

Nominal Voltage - Power Rating - Power Supply	See label on the inside of the service door
Housing Material	ABS - Thermoplastic
Size (w x h x d)	256 x 350 x 470 mm
Weight	8.5 kg
Power Cord Length	1.2 m
Control Panel	On the front
Cup Size	142
Water Tank	1.9 litres - Removable type
Coffee Bean Hopper Capacity	300 g
Coffee Grounds Drawer Capacity	14
Pump Pressure	15 bar
Boiler	Stainless Steel
Safety Devices	Thermal Fuse

## GUARANTEE AND SERVICE

### Warranty

For detailed information on your warranty and related conditions, please read the warranty booklet by-packed separately.

### Service

We want to ensure that you remain satisfied with your machine. If not done already, please register your product at **www.philips.com/welcome**. By doing so, we can stay in contact with you and send you cleaning and descaling reminders.

If you need service or support, please visit the Philips website at [www.philips.com/support](http://www.philips.com/support) or contact the Philips Saeco hotline in your country. The contact details can be found in the warranty booklet by-packed separately or on **www.philips.com/support**.

## ORDERING MAINTENANCE PRODUCTS

For cleaning and descaling, use Saeco maintenance products only. You can purchase these at the Philips online shop at [www.shop.philips.com/service](http://www.shop.philips.com/service), your local dealer or at authorised service centres.

If you have any difficulties obtaining maintenance products for your machine, please contact the Philips Saeco hotline in your country.

The contact details can be found in the warranty booklet by-packed separately or on [www.philips.com/support](http://www.philips.com/support).

Overview of Maintenance Products



- Decalcifier CA6700



- INTENZA+ Water Filter CA6702

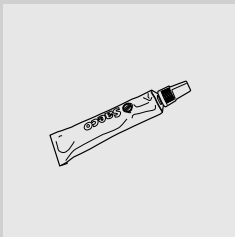

- Grease HD5061



- Coffee Oil Remover CA6704



- Maintenance Kit CA 6706

### MACHINE ACCESSORIES

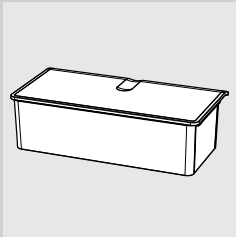

- Removable coffee bean hopper CA6803



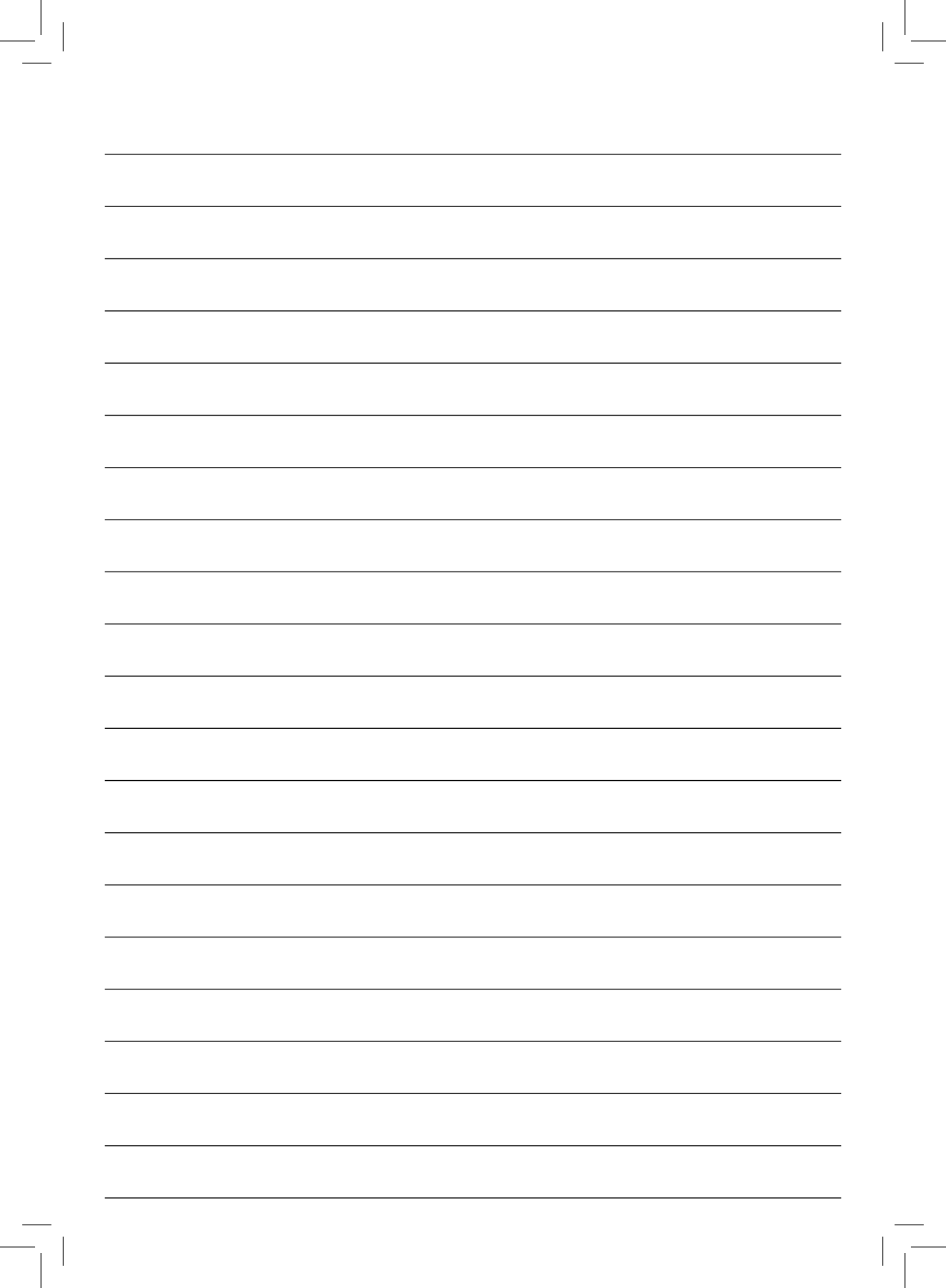

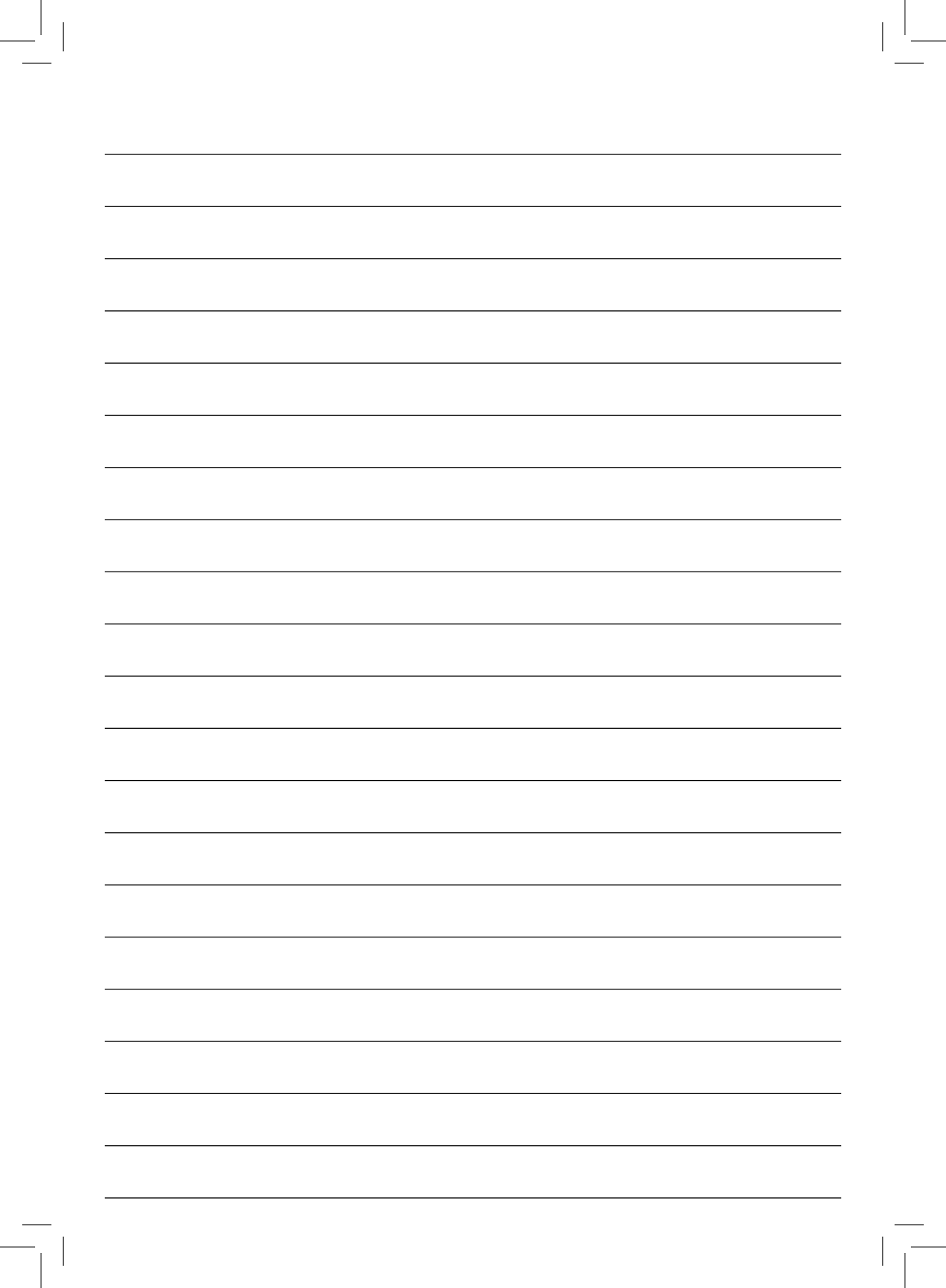





[www.philips.com/saeco](http://www.philips.com/saeco)

The manufacturer reserves the right to make changes without prior notice.



421940436471

Rev.00 del 05-02-13