



www.philips.com/welcome

| | | |
|----|----------------------------|----|
| EN | User manual | 1 |
| | Customer care and warranty | 30 |
| | Troubleshooting & FAQs | 35 |

Table of Contents

| | |
|--|-----------|
| 1. Important | 1 |
| 1.1 Safety precautions and maintenance | .1 |
| 1.2 Notational Descriptions | 2 |
| 1.3 Disposal of product and packing material | 3 |
| 2. Setting up the Display | 4 |
| 2.1 Installation | 4 |
| 2.2 Operating the Display | 6 |
| 2.3 MultiView | 9 |
| 2.4 Remove the Base Assembly for VESA Mounting | 11 |
| 2.5 MHL (Mobile High-Definition Link) introduction | 12 |
| 2.6 RS-232C | 13 |
| 3. Image Optimization | 17 |
| 3.1 SmartImage | 17 |
| 3.2 SmartContrast | 18 |
| 4. Technical Specifications | 19 |
| 4.1 Resolution & Preset Modes | 22 |
| 5. Power Management | 23 |
| 6. Regulatory Information | 24 |
| 7. Customer care and warranty | 30 |
| 7.1 Philips' Flat Panel Displays Pixel Defect Policy | 30 |
| 7.2 Customer Care & Warranty | 32 |
| 8. Troubleshooting & FAQs | 35 |
| 8.1 Troubleshooting | 35 |
| 8.2 General FAQs | 36 |
| 8.3 Multiview FAQs | 39 |

1. Important

This electronic user's guide is intended for anyone who uses the Philips Display. Take time to read this user manual before you use your Display. It contains important information and notes regarding operating your Display.

The Philips guarantee applies provided the product is handled properly for its intended use, in accordance with its operating instructions and upon presentation of the original invoice or cash receipt, indicating the date of purchase, dealer's name and model and production number of the product.

1.1 Safety precautions and maintenance

Warnings

Use of controls, adjustments or procedures other than those specified in this documentation may result in exposure to shock, electrical hazards and/or mechanical hazards.

Read and follow these instructions when connecting and using your computer Display.

Operation

- Please Keep the Display out of direct sunlight, very strong bright lights and away from any other heat source. Lengthy exposure to this type of environment may result in discoloration and damage to the Display.
- Remove any object that could fall into ventilation holes or prevent proper cooling of the Display's electronics.
- Do not block the ventilation holes on the cabinet.
- When positioning the Display, make sure the power plug and outlet are easily accessible.
- If turning off the Display by detaching the power cable or DC power cord, wait for 6 seconds before attaching the power cable or DC power cord for normal operation.

- Please use approved power cord provided by Philips at all time. If your power cord is missing, please contact your local service center. (Please refer to Customer Care Consumer Information Center)
- Do not subject the Display to severe vibration or high impact conditions during operation.
- Do not knock or drop the Display during operation or transportation.

Maintenance

- To protect your Display from possible damage, do not put excessive pressure on the LCD panel. When moving your Display, grasp the frame to lift; do not lift the Display by placing your hand or fingers on the LCD panel.
- Unplug the Display if you are not going to use it for an extensive period of time.
- Unplug the Display if you need to clean it with a slightly damp cloth. The screen may be wiped with a dry cloth when the power is off. However; never use organic solvent, such as, alcohol, or ammonia-based liquids to clean your Display.
- To avoid the risk of shock or permanent damage to the set, do not expose the Display to dust, rain, water, or excessive moisture environment.
- If your Display gets wet, wipe it with dry cloth as soon as possible.
- If foreign substance or water gets in your Display, please turn the power off immediately and disconnect the power cord. Then, remove the foreign substance or water; and send it to the maintenance center.
- Do not store or use the Display in locations exposed to heat, direct sunlight or extreme cold.
- In order to maintain the best performance of your Display and use it for a longer lifetime, please use the Display in a location that falls within the following temperature and humidity ranges.

1. Important

- Temperature: 0-40°C 32-104°F
- Humidity: 20-80% RH

Important information for Burn-in/Ghost image

- Always activate a moving screen saver program when you leave your Display unattended. Always activate a periodic screen refresh application if your Display will display unchanging static content. Uninterrupted display of still or static images over an extended period may cause “burn in”, also known as “after-imaging” or “ghost imaging”, on your screen.
- “Burn-in”, “after-imaging”, or “ghost imaging” is a well-known phenomenon in LCD panel technology. In most cases, the “burned in” or “after-imaging” or “ghost imaging” will disappear gradually over a period of time after the power has been switched off.

Warning

Failure to activate a screen saver, or a periodic screen refresh application may result in severe “burn-in” or “after-image” or “ghost image” symptoms that will not disappear and cannot be repaired. The damage mentioned above is not covered under your warranty.

Service

- The casing cover should be opened only by qualified service personnel.
- If there is any need for any document for repair or integration, please contact with your local service center. (please refer to the chapter of “Consumer Information Center”)
- For transportation information, please refer to “Technical Specifications”.
- Do not leave your Display in a car/trunk under direct sun light.

Note

Consult a service technician if the Display does not operate normally, or you are not sure what procedure to take when the operating instructions given in this manual have been followed.

1.2 Notational Descriptions

The following subsections describe notational conventions used in this document.

Notes, Cautions and Warnings

Throughout this guide, blocks of text may be accompanied by an icon and printed in bold or italic type. These blocks contain notes, cautions or warnings. They are used as follows:

Note

This icon indicates important information and tips that help you make better use of your computer system.

Caution

This icon indicates information that tells you how to avoid either potential damage to hardware or loss of data.

Warning

This icon indicates the potential for bodily harm and tells you how to avoid the problem.

Some warnings may appear in alternate formats and may not be accompanied by an icon. In such cases, the specific presentation of the warning is mandated by the relevant regulatory authority.

1.3 Disposal of product and packing material

Waste Electrical and Electronic Equipment- WEEE



This marking on the product or on its packaging illustrates that, under European Directive 2012/19/EU governing used electrical and electronic appliances, this product may not be disposed of with normal household waste. You are responsible for disposal of this equipment through a designated waste electrical and electronic equipment collection. To determine the locations for dropping off such waste electrical and electronic, contact your local government office, the waste disposal organization that serves your household or the store at which you purchased the product.

Your new Display contains materials that can be recycled and reused. Specialized companies can recycle your product to increase the amount of reusable materials and to minimize the amount to be disposed of.

All redundant packing material has been omitted. We have done our utmost to make the packaging easily separable into mono materials.

Please find out about the local regulations on how to dispose of your old Display and packing from your sales representative.

Taking back/Recycling Information for Customers

Philips establishes technically and economically viable objectives to optimize the environmental performance of the organization's product, service and activities.

From the planning, design and production stages, Philips emphasizes the important of

making products that can easily be recycled. At Philips, end-of-life management primarily entails participation in national take-back initiatives and recycling programs whenever possible, preferably in cooperation with competitors, which recycle all materials (products and related packaging material) in accordance with all Environmental Laws and taking back program with the contractor company.

Your display is manufactured with high quality materials and components which can be recycled and reused.

To learn more about our recycling program please visit

<http://www.philips.com/about/sustainability/ourenvironmentalapproach/productrecyclingservices/index.page>

2. Setting up the Display

2.1 Installation

1 Package contents

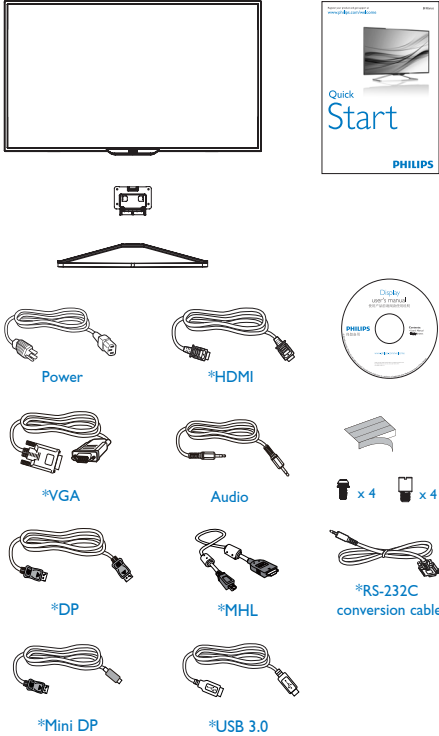

*Different according to region.

2 Install the base

1. Place the Display face down on soft and smooth surface taking care to avoid scratching or damaging the screen.

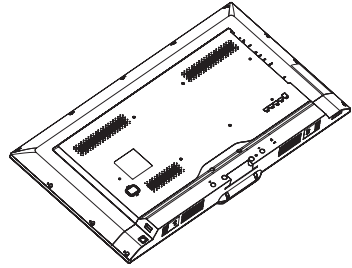

2. After inserting the base column in the guide block, tighten the screws. insert the base into the base column and secure the base to the column tightly.

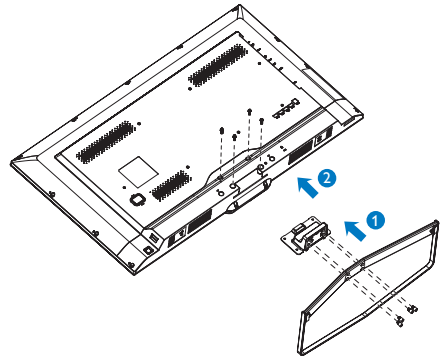

2. Setting up the Display

3 Connecting to your PC

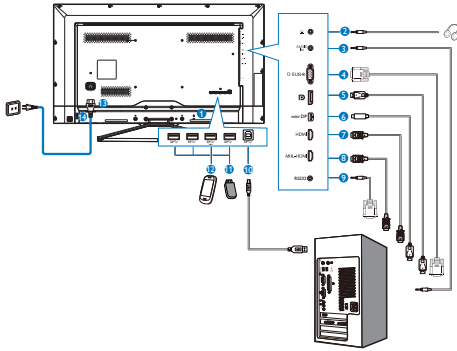

- ❶ Kensington anti-theft lock
- ❷ Earphone jack
- ❸ Audio input
- ❹ VGA input
- ❺ Display port input
- ❻ mini DP input
- ❼ HDMI input
- ❽ MHL-HDMI input
- ❾ RS232
- ❿ USB upstream
- ⓫ USB downstream
- ⓬ USB fast charger
- ⓭ AC Power input
- ⓮ AC Power Switch

Connect to PC

1. Connect the power cord to the back of the Display firmly.
2. Turn off your computer and unplug its power cable.
3. Connect the Display signal cable to the video connector on the back of your computer.
4. Plug the power cord of your computer and your Display into a nearby outlet.
5. Turn on your computer and Display. If the Display displays an image, installation is complete.

2.2 Operating the Display

1 Description of the control buttons

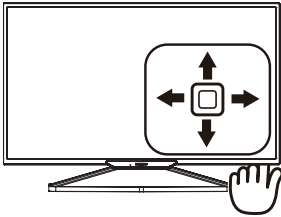
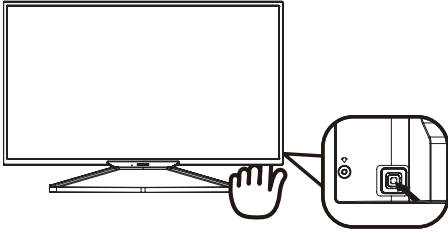

| | | |
|---|--|---|
| 1 | | Press more than 3 seconds to switch display power ON or OFF. |
| 2 | | Access the OSD menu. Confirm the OSD adjustment. |
| 3 | | User preference key. Customize your own preference function from OSD to become the "user key". |
| | | Adjust the OSD menu. |
| 4 | | PIP/PBP 2Win/PBP 3Win/PBP 4Win/Swap/Off |
| | | Adjust the OSD menu. |
| 5 | | SmartImage hot key. There are 7 modes to select: Office, Photo, Movie, Game, Economy, SmartUniformity, Off. |
| | | Return to previous OSD level. |

2 Customize your own "USER" key

"USER" allows you to setup your favorite function buttons.

1. Toggle to the right to enter OSD menu screen.

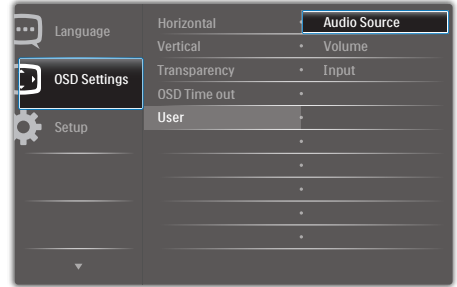

2. Toggle to the up or down to select main menu **[OSD Settings]**, then toggle to the right to confirm.
3. Toggle to the up or down to select **[User]**, then toggle to the right to confirm.
4. Toggle to the up or down to select your preferred function : **[Audio Source]**, **[Volume]**, **[Input]**.
5. Toggle to the right to confirm your selection.

Now you can toggle the button to the down **[User]** directly on the rear cover. Only your pre-selected function will appear for quick access.

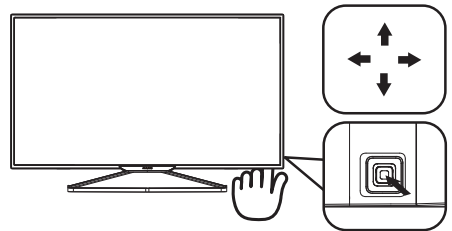

2. Setting up the Display

For example, if you selected **[Audio Source]** as the function, toggle down, the **[Audio Source]** menu appears.



3 Independent audio playback, regardless of video input

Your Philips Display can play the audio source independently under PIP / PBP mode, regardless of which video input. For example, you can play your MP3 player from the audio source connected to the **[Audio In]** port of this Display, and still watch your video source connected from **[HDMI]**, **[DisplayPort]** or **[Mini DisplayPort]**.

1. Toggle to the right to enter OSD menu screen.

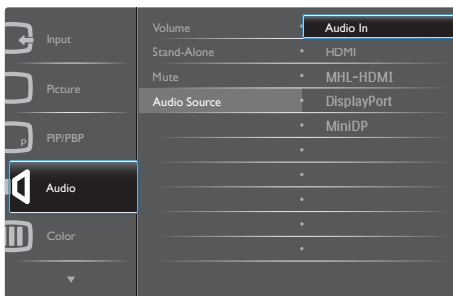

2. Toggle to the up and down to select main menu **[Audio]**, then toggle to the right to confirm.
3. Toggle to the up and down to select **[Audio Source]**, then toggle to the right to confirm.
4. Toggle to the up and down to select your preferred audio source: **[Audio In]**, **[HDMI]**, **[MHL-HDMI]**, **[DisplayPort]** or **[Mini DP]**.
5. Toggle to the right to confirm your selection.

Note

The next time you turn on this Display, it will by default select the audio source you previously selected. In case you want to change it, you will have to go through the selection steps again to select your new preferred audio source as the default.

4 Description of the On Screen Display

What is On-Screen Display (OSD)?

On-Screen Display (OSD) is a feature in all Philips LCD Displays. It allows an end user to adjust screen performance or select functions of the Displays directly through an on-screen instruction window. A user friendly on screen display interface is shown as below:

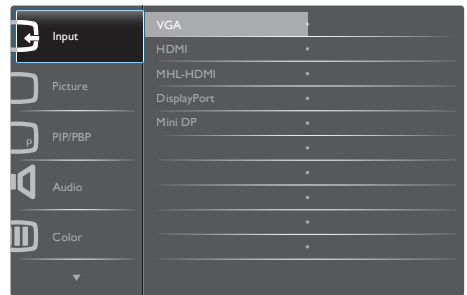

Basic and simple instruction on the control keys

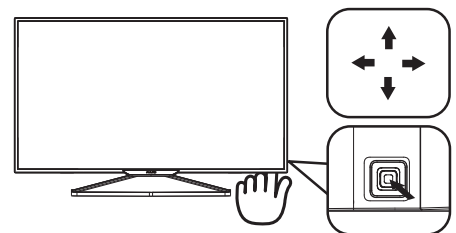

To access the OSD menu on this Philips Display simply use the single toggle button on the backside of the Display bezel. The single button operates like a joystick. To move the cursor; simply toggle the button in four directions. Press the button to select desired option.

2. Setting up the Display

The OSD Menu

Below is an overall view of the structure of the On-Screen Display. You can use this as a reference when you want to work your way around the different adjustments later on.

| Main menu | Sub menu | | |
|----------------|---|--|---|
| Input | VGA | | |
| | HDMI | | |
| | MHL-HDMI | | |
| | DisplayPort | | |
| | Mini DP | | |
| Picture | Picture Format | Wide screen, 4:3, 1:1 | |
| | Brightness | 0-100 | |
| | Contrast | 0-100 | |
| | Sharpness | 0-100 | |
| | SmartResponse | Off, Fast, Faster, Fastest | |
| | SmartContrast | On, Off | |
| | Gamma | 1.8, 2.0, 2.2, 2.4, 2.6 | |
| | Pixel Orbiting | On, Off | |
| | Over Scan | On, Off | |
| | PIP/PBP | PIP/PBP Mode | Off, PIP, PBP 2Win, PBP 3Win, PBP 4Win |
| | | Sub Win1 Input | VGA, HDMI, MHL-HDMI, DisplayPort, Mini DP |
| Sub Win2 Input | | VGA, HDMI, MHL-HDMI, DisplayPort, Mini DP | |
| Sub Win3 Input | | VGA, HDMI, MHL-HDMI, DisplayPort, Mini DP | |
| PIP Size | | Small, Middle, Large | |
| PIP Position | | Top-Right, Top-Left, Bottom-Right, Bottom-Left | |
| Swap | | | |
| Audio | Volume | 0-100 | |
| | Stand-Alone | On, Off | |
| | Mute | On, Off | |
| | Audio Source | Audio In, HDMI, MHL-HDMI, DisplayPort, Mini DP | |
| Color | Color Temperature | 5000K, 6500K, 7500K, 8200K, 9300K, 11500K | |
| | sRGB | | |
| | User Define | Red: 0-100 Green: 0-100 Blue: 0-100 | |
| Language | English, Deutsch, Español, Ελληνικά, Français, Italiano, Magyar, Nederlands, Português, Português do Brasil, Polski, Русский, Svenska, Suomi, Türkçe, Čeština, Українська, 简体中文, 繁體中文, 日本語, 한국어 | | |
| OSD Settings | Horizontal | 0-100 | |
| | Vertical | 0-100 | |
| | Transparency | Off, 1, 2, 3, 4 | |
| | OSD Time Out | 5, 10, 20, 30, 60 | |
| | User key | Audio Source, Volume, Input | |
| Setup | Auto | | |
| | H. Position | 0-100 | |
| | V. Position | 0-100 | |
| | Phase | 0-100 | |
| | Clock | 0-100 | |
| | Resolution Notification | On, Off | |
| | RS232 | On, Off | |
| | DisplayPort | 1.1, 1.2 | |
| | Reset | Yes, No | |
| | Information | | |

5 Resolution notification

This Display is designed for optimal performance at its native resolution, 3840 x 2160 @ 60 Hz. When the Display is powered on at a different resolution, an alert is displayed on screen: Use 3840 x 2160 @ 60 Hz for best results.

Display of the native resolution alert can be switched off from Setup in the OSD (On Screen Display) menu.

2.3 MultiView

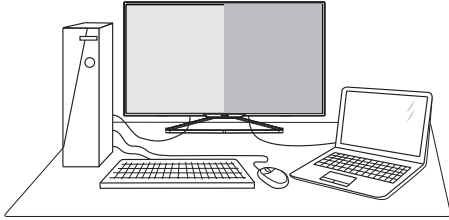

1 What is it?

Multiview enables active variety connect and view so that you can work with multiple devices like PC and Notebook side-by-side simultaneously, making complex multi-tasking work a breeze.

2 Why do I need it?

With the ultra high resolution Philips MultiView display, you can experience a world of connectivity in a comfortable way in the office or at home. With this display, you can conveniently enjoy multiple content sources at one screen. For example: You may want to keep an eye on the live news video feed with audio in the small window, while working on your latest blog, or you may want to edit an Excel file from your Ultrabook, while logged into secured company intranet to access files from a desktop.

3 How to enable MultiView by hotkey?

1. Toggle the button to up on the back cover:

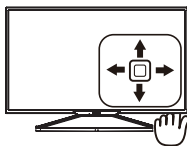
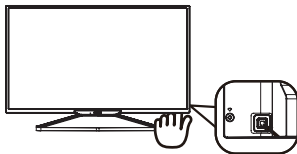

2. The MultiView selection menu appears. Toggle up or down to select.



3. Toggle to the right to confirm your selection.

4 How to enable MultiView by OSD menu?

MultiView function can also be selected in OSD menu.

1. Toggle to the right to enter OSD Menu Screen.

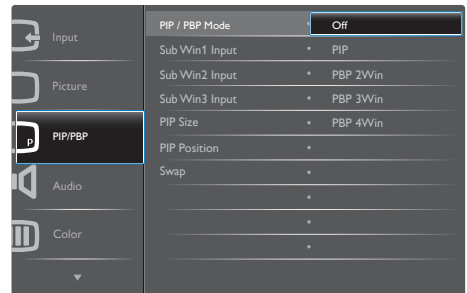

2. Toggle to the up or down to select main menu [PIP / PBP], then toggle to the right to confirm.
3. Toggle to the up or down to select [PIP / PBP Mode], then toggle to the right.
4. Toggle to the up or down to select [Off], [PIP], [PBP 2Win], [PBP 3Win] or [PBP 4Win], then toggle to the right.
5. Now you can move backward to set the [Off], [PIP], [PBP 2Win], [PBP 3Win] or [PBP 4Win].
6. Toggle to the right to confirm your selection.

2. Setting up the Display

5 MultiView in OSD menu

- **PIP / PBP Mode:** There are five modes for MultiView: [Off], [PIP], [PBP 2Win], [PBP 3Win] and [PBP 4Win].

[PIP]: Picture in Picture

Open up a sub-window side-by-side of other signal source.

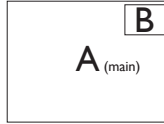

When the sub source is not detected:

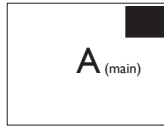

[PBP 2Win]: Picture by Picture

Open up a sub-window side-by-side of other signal sources.

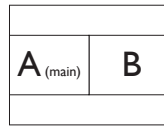

When the sub source is not detected.

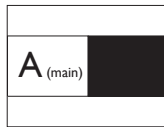

[PBP 3Win]: Picture by Picture

Open up two sub-windows of other sources.

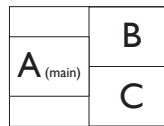

When the sub sources are not detected.

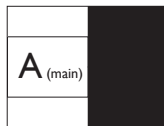

[PBP 4Win]: Picture by Picture

Open up three sub-windows of other signal sources.

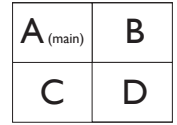

When the sub sources are not detected.



Note

The black strip shows on the top and the bottom of the screen for the correct aspect ratio when in the PBP mode.

- **PIP Size:** When PIP is activated, there are three sub-window sizes to choose: [Small], [Middle], [Large].

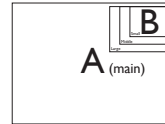

- **PIP Position:** When PIP is activated, there are four sub-window positions to choose.

Top-Right

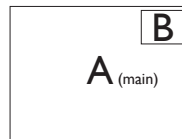

Bottom-Right

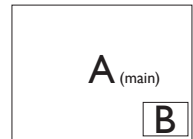

Top-Left

Bottom-Left

2. Setting up the Display

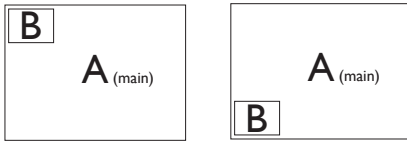

- **Swap:** The main picture source and the sub picture source swapped on the display.

Swap A and B source in [PIP] mode:



- **Off:** Stop MultiView function.

Note

When you do the SWAP function, the video and its audio source will swap at the same time. (Refer to page <7> "Independent audio playback, regardless of video input" for more detail.)

2.4 Remove the Base Assembly for VESA Mounting

Before you start disassembling the Display base, please follow the instructions below to avoid any possible damage or injury.

1. Place the Display face down on a smooth surface. Pay attention not to scratch or damage the screen.

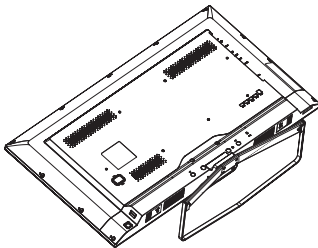

2. Loosen the assembly screws, then detach the neck from the Display.

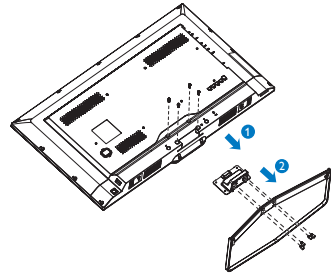

3. Loosen the 4 screws from the rear cover.

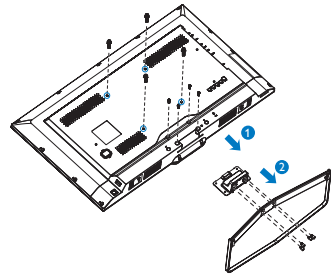

Note

This Display accepts a 200mm x 200mm VESA-Compliant mounting interface.

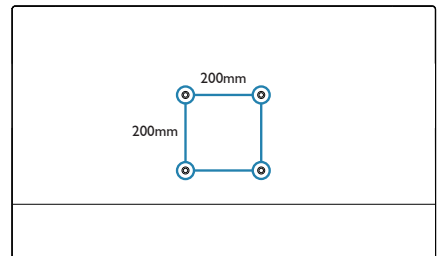

2.5 MHL (Mobile High-Definition Link) introduction

1 What is it?

Mobile High Definition Link (MHL) is a mobile audio/video interface for directly connecting mobile phones and other portable devices to high-definition displays.

An optional MHL cable allows you to simply connect your MHL capable mobile device to this large Philips MHL display, and watch your HD videos come to life with full digital sound. Now not only you can enjoy your mobile games, photos, movies, or other apps on its big screen, you can simultaneously charge your mobile device so you never run out of power half way.

2 How do I use the MHL function?

To use the MHL function, you need an MHL-Certified mobile device. To find a list of MHL-certified devices, visit the official MHL website (<http://www.mhlconsortium.org>)

You also need a optional MHL certified special cable in order to use this function.

3 How does it work? (how do I connect?)

Connect the Optional MHL cable to the mini USB port on the mobile device side, and the [MHL-HDMI] marked port on the Display side. You are now ready to view the images on your big screen display and operate all function on you the mobile device such as internet surfing, game playing, photo browsing...etc. if your Display has speaker function, then you will be able to hear accompanying sound too. When the MHL cable is disconnected or the mobile device is turned off, the MHL function will be automatically disabled.

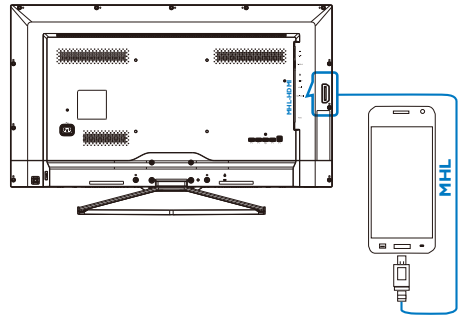

Note

- The port marked [MHL-HDMI] is the only port on the Display that supports the MHL function when the MHL cable is used. Note that the MHL certified cable is different than a standard HDMI cable.
- A mobile device with MHL certification must be purchased separately
- You may have to manually switch the Display to MHL-HDMI mode in order to activate the Display, if you have other devices already working and connected to available inputs
- Standby/Off energy saving of ErP is not applicable for the MHL charging functionality
- This Philips display is MHL certified. However, in case your MHL device does not connect or work correctly, check with your MHL device FAQ or vendor directly for direction. The policy of your device manufacturer may require you to purchase their brand specific MHL cable or adapter in order to work with other brand MHL devices. Note that this is not a fault of this Philips display.

2.6 RS-232C

1 Purpose

This section is to explain in detail the commands and steps that can be used to control this Display via the RS-232C conversion cable and a commercially available RS-232 straight cable.

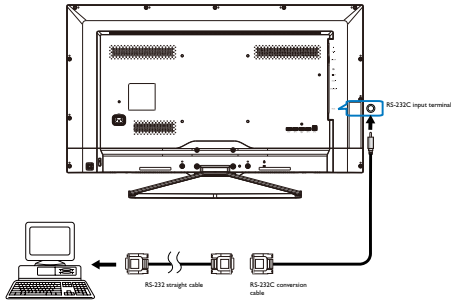

2 Command Packet Format

- Physical Specifications
 - Baud Rate:1200, 2400, 4800, 9600 (default), 19200, 38400, 57600
 - Data bits: 8
 - Parity: None
 - Stop Bit: 1
 - Flow Control: None

- Communication Procedure

Control commands can be sent from a host controller via the RS-232C connection. A new command should not be sent until the previous command is acknowledged. The Display operates according to the received command. If the command is a valid "Get" command, the

2. Setting up the Display

Display responds with the requested info. If the command is valid "Set" command allowed, the Display performs the requested operation.

3 Command Format

- Control (from Host to Display)

| | | | | | | | |
|---------|---------|----------|----------|----------|-----|----------|----------|
| MsgSize | Control | Data [0] | Data [1] | Data [2] | ... | Data [N] | Checksum |
|---------|---------|----------|----------|----------|-----|----------|----------|

| Name of Filed | Item | Value |
|---------------|------------|--|
| MsgSize | Header | 0xA6 |
| | Display ID | 0xXX (=0~255) |
| | Category | 0x00(fixed) |
| | Page | 0x00(fixed) |
| | Function | 0x00(fixed) |
| | Length | 0xXX(=0~255) (it will be the total bytes from header to checksum subtract 6 byte and should be more than or equal to 1 byte.) |
| Control | Control | 0x01(fixed) |
| Data[0] | Data[0] | 0xXX (=0~255) |
| Data[1] | Data[1] | 0xXX (=0~255) |
| . | . | 0xXX (=0~255) |
| . | . | |
| . | . | |
| Data[N] | Data[N] | 0xXX (=0~255) |
| Checksum | Checksum | 0xXX (=0~255) Algorithm: The EXCLUSIVE-OR (XOR) of all bytes in the message except the checksum itself. Checksum= [MsgSize] XOR[Control] XOR Data[0]...XOR Data[N] |

Example:

Set Power off in Display #1.

| | | | | |
|---------|---------|---------|---------|----------|
| MsgSize | Control | Data[0] | Data[1] | Checksum |
|---------|---------|---------|---------|----------|

2. Setting up the Display

| Header | ID | Category | Page | Function | Length | Control | Data[0] | Data[1] | Checksum |
|--------|------|----------|------|----------|--------|---------|---------|---------|----------|
| 0xA6 | 0x01 | 0x00 | 0x00 | 0x00 | 0x04 | 0x01 | 0x18 | 0x01 | BB |

- Response the data (From Display to Host)

| MsgSize | Control | Command | Data [0] | Data [1] | ... | Data [N] | Checksum |
|---------|---------|---------|----------|----------|-----|----------|----------|
|---------|---------|---------|----------|----------|-----|----------|----------|

| Name of Filed | Item | Value |
|---------------|------------|---|
| MsgSize | Header | 0x21 |
| | Display ID | 0xXX (=0~255) |
| | Category | 0x00(fixed) |
| | Page | 0x00(fixed) |
| | Length | 0xXX(=0~255) |
| | Control | 0x01(fixed) |
| Command | Command | 0xXX (=0~255) |
| Data[0] | Data[0] | 0xXX (=0~255) |
| Data[1] | Data[1] | 0xXX (=0~255) |
| . | . | 0xXX (=0~255) |
| . | . | . |
| . | . | . |
| Data[N] | Data[N] | 0xXX (=0~255) |
| Checksum | Checksum | 0xXX Algorithm: The EXCLUSIVE-OR (XOR) of all bytes in the message except the checksum itself. Checksum= [MsgSize] XOR[Control] XOR Data[0]...XOR Data[N] |

Example:

Display #1 response to host after received the command of user input control.

| MsgSize | Control | Command | Data[0] | Checksum |
|---------|---------|---------|---------|----------|
|---------|---------|---------|---------|----------|

2. Setting up the Display

| Header | ID | Category | Page | Length | Control | Command | Data[0] | Checksum |
|--------|------|----------|------|--------|---------|---------|---------|----------|
| 0x21 | 0x01 | 0x00 | 0x00 | 0x04 | 0x01 | 0x1D | 0x03 | 38 |

- Response the status (From Display to Host)

| MsgSize | Control | Data [0] | Status | Checksum |
|---------|---------|----------|--------|----------|
|---------|---------|----------|--------|----------|

| Name of Filed | Item | Value |
|---------------|------------|---|
| MsgSize | Header | 0x21 |
| | Display ID | 0xXX (=0~255) |
| | Category | 0x00(fixed) |
| | Page | 0x00(fixed) |
| | Length | 0xXX(=0~255) |
| | Control | 0x01(fixed) |
| Data[0] | Data[0] | 0x00 (Fixed) |
| Status | Status | 0x00: Completed 0x01: Limit Over 0x02: Limit Over 0x03: Command canceled 0x04: Parse Error |
| Checksum | Checksum | 0xXX Algorithm: The EXCLUSIVE-OR (XOR) of all bytes in the message except the checksum itself. Checksum= [MsgSize] XOR[Control] XOR Data[0]...XOR Data[N] |

Example:

Display #1 response to host after received the command (status: completed).

| MsgSize | | | | | Control | Data[0] | Status | Checksum |
|---------|------|----------|------|--------|---------|---------|--------|----------|
| Header | ID | Category | Page | Length | Control | Data[0] | Status | Checksum |
| 0x21 | 0x01 | 0x00 | 0x00 | 0x04 | 0x01 | 0x00 | 0x00 | 25 |

3. Image Optimization

3.1 SmartImage

1 What is it?

SmartImage provides presets that optimize display for different types of content, dynamically adjusting brightness, contrast, color and sharpness in real time. Whether you're working with text applications, displaying images or watching a video, Philips SmartImage delivers great optimized Display performance.

2 Why do I need it?

You want a Display that delivers optimized display all your favorite types of content, SmartImage software dynamically adjust brightness, contrast, color and sharpness in real time to enhance your Display viewing experience.

3 How does it work?

SmartImage is an exclusive, leading edge Philips technology that analyzes the content displayed on your screen. Based on a scenario you select, SmartImage dynamically enhances the contrast, color saturation and sharpness of images to enhance the contents being displayed - all in real time with the press of a single button.

4 How to enable SmartImage?

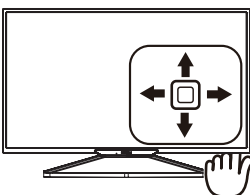
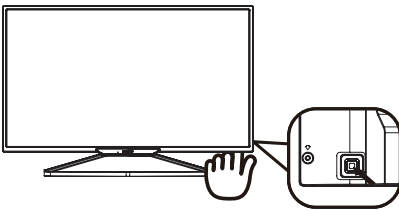

1. Toggle to the left to launch the SmartImage on screen display.
2. Toggle to the up or down to select between Office, photo, Movie, Game, Economy, SmartUniformity and Off.
3. The SmartImage on screen display will remain on screen for 5 seconds or you can also toggle to the left to make confirmation.

There are seven modes to select: Office, Photo, Movie, Game, Economy, SmartUniformity and Off.

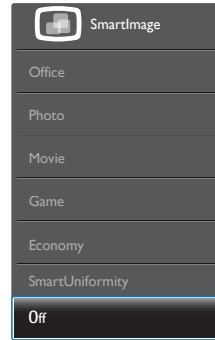

- **Office:** Enhances text and dampens brightness to increase readability and reduce eye strain. This mode significantly enhances readability and productivity when you're working with spreadsheets, PDF files, scanned articles or other general office applications.
- **Photo:** This profile combines color saturation, dynamic contrast and sharpness enhancement to display photos and other images with outstanding clarity in vibrant colors - all without artifacts and faded colors.
- **Movie:** Ramped up luminance, deepened color saturation, dynamic contrast and razor sharpness displays every details in darker areas of your videos without color washout in brighter areas maintaining a dynamic natural values for the ultimate video display.
- **Game:** Turn on over drive circuit for best response time, reduce jaggy edges for fast moving objects on screen, enhance contrast ratio for bright and dark scheme, this profile delivers the best gaming experience for gamers.

3. Image Optimization

- **Economy:** Under this profile, brightness, contrast are adjusted and backlighting finetuned for just right display of everyday office applications and lower power consumption.
- **SmartUniformity:** Fluctuations in brightness on different parts of a screen are a common phenomenon among LCD Displays. Typical uniformity is measured around 75-80%. By enabling Philips SmartUniformity feature, display uniformity is increased to above 95%. This produces more consistent and true images.
- **Off:** No optimization by SmartImage.

3.2 SmartContrast

1 What is it?

Unique technology that dynamically analyzes displayed content and automatically optimizes a Display's contrast ratio for maximum visual clarity and viewing enjoyment, stepping up backlighting for clearer, crisper and brighter images or dimming backlighting for clear display of images on dark backgrounds.

2 Why do I need it?

You want the very best visual clarity and viewing comfort for every type of content. SmartContrast dynamically controls contrast and adjusts backlighting for clear, crisp, bright gaming and video images or displays clear, readable text for office work. By reducing your Display's power consumption, you save on energy costs and extend the lifetime of your Display.

3 How does it work?

When you activate SmartContrast, it will analyse the content you are displaying in real time to adjust colors and control backlight intensity. This function will dynamically enhance contrast for a great entertainment experience when viewing videos or playing games.

4. Technical Specifications

| Picture/Display | |
|---------------------------|--|
| Display Panel Type | VA LCD |
| Backlight | W-LED system |
| Panel Size | 39.56" (100.5 cm) |
| Aspect Ratio | 16:9 |
| SmartContrast (typ.) | 50,000,000:1 |
| Response Time (typ.) | 8.5 ms (GtG) |
| SmartResponse (typ.) | 3 ms (GtG) |
| Optimum Resolution | VGA: 1920 × 1080 @ 60Hz HDMI: 3840 × 2160 @ 30Hz, 2560 × 1440 @ 60Hz DisplayPort: 3840 × 2160 @ 60Hz, |
| Viewing Angle | 176° (H) / 176° (V) @ C/R > 20 |
| Picture Enhancement | SmartImage |
| Display Colors | 1.07G |
| Vertical Refresh Rate | 56-80Hz (VGA) 23-80Hz (HDMI/DisplayPort) |
| Horizontal Frequency | 30-99KHz (VGA/HDMI) 30-160KHz (DisplayPort) |
| sRGB | YES |
| Connectivity | |
| Signal Input | VGA (Analog), DisplayPort, MHL-HDMI, Mini DisplayPort, HDMI, RS232 |
| USB | USB 3.0×4 including 1×fast charging |
| Input Signal | Separate Sync, Sync on Green |
| Audio In/Out | PC audio-in,headphone out |
| Convenience | |
| Built-in speaker | 7 W × 2 |
| MultiView | PIP (2 × devices), PBP(4 × devices) |
| OSD Languages | English, German, Spanish, Greek, French, Italian, Hungarian, Dutch, Portuguese, Brazil Portuguese, Polish, Russian, Swedish, Finnish, Turkish, Czech, Ukrainian, Simplified Chinese, Traditional Chinese, Japanese, Korean |
| Other Convenience | VESA mount(200 × 200 mm), Kensington Lock |
| Plug & Play Compatibility | DDC/CI, sRGB, Windows 8.1/8/7, Mac OSX |
| Power | |
| On Mode | 95 W (typ.), 150 W (max.) |
| Sleep (Standby) | <0.5 W (typ.) |
| Off | <0.3 W (typ.) |
| Off (AC switch) | 0 W |
| On Mode(ECO mode) | 46.5 W (typ.) |

4. Technical Specifications

| Power(EnergyStar test method) | | | |
|-------------------------------|--|-----------------------------------|-----------------------------------|
| Energy Consumption | AC Input Voltage at 100VAC , 50Hz | AC Input Voltage at 115VAC , 60Hz | AC Input Voltage at 230VAC, 50Hz |
| Normal Operation | 71.4 W (typ.) | 71.5 W (typ.) | 72.8 W (typ.) |
| Sleep (Standby) | <0.5 W (typ.) | <0.5 W (typ.) | <0.5 W (typ.) |
| Off | <0.3 W (typ.) | <0.3 W (typ.) | <0.3 W (typ.) |
| Off (AC switch) | 0 W | | |
| Heat Dissipation* | AC Input Voltage at 100VAC , 50Hz | AC Input Voltage at 115VAC , 60Hz | AC Input Voltage at 230VAC , 50Hz |
| Normal Operation | 243.69 BTU/hr (typ.) | 244.03 BTU/hr (typ.) | 248.47 BTU/hr (typ.) |
| Sleep (Standby) | <1.71 BTU/hr (typ.) | <1.71 BTU/hr (typ.) | <1.71 BTU/hr (typ.) |
| Off | <1.02 BTU/hr (typ.) | <1.02 BTU/hr (typ.) | <1.02 BTU/hr (typ.) |
| Off (AC switch) | 0 BTU/hr | | |
| Power LED indicator | On mode:White, Standby/Sleep mode:White (blinking) | | |
| Power Supply | Built-in, 100-240VAC, 50-60Hz | | |

| Dimensions | |
|-------------------------------|--------------------|
| Product with stand (WxHxD) | 904 × 589 × 213 mm |
| Product without stand (WxHxD) | 904 × 512 × 88 mm |
| Weight | |
| Product with stand | 9.7 kg |
| Product without stand | 8.5 kg |
| Product with packaging | 13.509 kg |

| Operating Condition | |
|-----------------------------------|---------------|
| Temperature range (operation) | 0°C to 40 °C |
| Temperature range (Non-operation) | -20°C to 60°C |
| Relative humidity (operation) | 20% to 80% |

| Environmental and energy | |
|--------------------------|---|
| ROHS | YES |
| EPEAT | Gold (www.epeat.net) |
| Packaging | 100% recyclable |
| Specific Substances | 100% PVC BFR free housing |
| EnergyStar | YES |

| Compliance and standards | |
|--------------------------|---|
| Regulatory Approvals | CE Mark, FCC Class B, SEMKO, cETLus, CU-EAC, EPA, PSB, WEEE, CCC, CECP, PSE, KC |

| Cabinet | |
|---------|--------------------|
| Color | Black/Silver |
| Finish | glossy and texture |

Note

1. EPEAT Gold or Silver is valid only where Philips registers the product. Please visit www.epeat.net for registration status in your country.
2. This data is subject to change without notice. Go to www.philips.com/support to download the latest version of leaflet.
3. Smart response time is the optimum value from either GtG or GtG (BW) tests.

4.1 Resolution & Preset Modes

1 Maximum Resolution

1920 × 1080 @ 60 Hz (analog input)
3840 × 2160 @ 60 Hz (digital input)

2 Recommended Resolution

3840 × 2160 @ 60 Hz (digital input)

| H. freq (kHz) | Resolution | V. freq (Hz) |
|---------------|-------------|--------------|
| 31.47 | 720 × 400 | 70.09 |
| 31.47 | 640 × 480 | 59.94 |
| 35.00 | 640 × 480 | 66.67 |
| 37.86 | 640 × 480 | 72.81 |
| 37.50 | 640 × 480 | 75.00 |
| 37.88 | 800 × 600 | 60.32 |
| 46.88 | 800 × 600 | 75.00 |
| 48.36 | 1024 × 768 | 60.00 |
| 60.02 | 1024 × 768 | 75.03 |
| 44.77 | 1280 × 720 | 59.86 |
| 63.89 | 1280 × 1024 | 60.02 |
| 79.98 | 1280 × 1024 | 75.03 |
| 55.94 | 1440 × 900 | 59.89 |
| 70.64 | 1440 × 900 | 74.98 |
| 65.29 | 1680 × 1050 | 59.95 |
| 67.50 | 1920 × 1080 | 60.00 |
| 88.79 | 2560 × 1440 | 59.95 |
| 67.50 | 3840 × 2160 | 30.00 |
| 135.00 | 3840 × 2160 | 60.00 |

Note

- Please notice that your display works best at native resolution of 3840 × 2160 @ 60Hz. For best display quality, please follow this resolution recommendation.

Recommended resolution

VGA: 1920 × 1080 @ 60Hz

HDMI: 3840 × 2160 @ 30Hz,

2560 × 1440 @ 60Hz

DP v1.1: 3840 × 2160 @ 30Hz,

DP v1.2: 3840 × 2160 @ 60Hz,

MHL 2.0: 1920 × 1080 @ 60Hz,

- The factory default setting DisplayPort v1.1 supports to the resolution 3840 × 2160 @ 30Hz.

For optimized resolution 3840 × 2160 @ 60Hz, please enter to OSD menu and change the setting to DisplayPort v1.2, also please make sure your graphic card supports DisplayPort v1.2.

Setting path: [OSD] / [Setup] / [DisplayPort] / [1.1, 1.2].

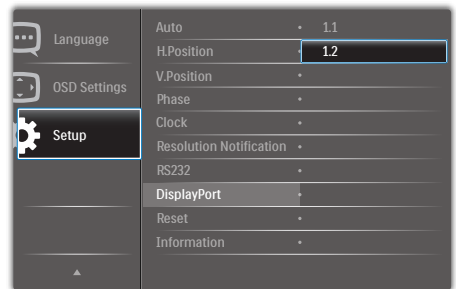

5. Power Management

If you have VESA DPM compliance display card or software installed in your PC, the Display can automatically reduce its power consumption when not in use. If an input from a keyboard, mouse or other input device is detected, the Display will 'wake up' automatically. The following table shows the power consumption and signaling of this automatic power saving feature:

| Power Management Definition | | | | | |
|-----------------------------|-------|--------|--------|-----------------------------|------------------|
| VESA Mode | Video | H-sync | V-sync | Power Used | LED Color |
| Active | ON | Yes | Yes | 95 W (typ.) 150 W (max.) | White |
| Sleep (Standby) | OFF | No | No | 0.5 W (typ.) | White (blink) |
| Off (AC switch) | OFF | - | - | 0 W (typ.) | OFF |

The following setup is used to measure power consumption on this Display.

- Native resolution: 3840 × 2160
- Contrast: 50%
- Brightness: 100%
- Color temperature: 6500k with full white pattern

Note

This data is subject to change without notice.

6. Regulatory Information

Lead-free Product



Lead free display promotes environmentally sound recovery and disposal of waste from electrical and electronic equipment. Toxic substances like Lead has been eliminated and compliance with European community's stringent RoHs directive mandating restrictions on hazardous substances in electrical and electronic equipment have been adhered to in order to make Philips Displays safe to use throughout its life cycle.

EPEAT

(www.epeat.net)



The EPEAT (Electronic Product Environmental Assessment Tool) program evaluates computer desktops, laptops, and Displays based on 51 environmental criteria developed through an extensive stakeholder consensus process supported by US EPA.

EPEAT system helps purchasers in the public and private sectors evaluate, compare and select desktop computers, notebooks and Displays based on their environmental attributes. EPEAT also provides a clear and consistent set of performance criteria for the design of products, and provides an opportunity for manufacturers to secure market recognition for efforts to reduce the environmental impact of its products.

Benefits of EPEAT

Reduce use of primary materials
Reduce use of toxic materials

Avoid the disposal of hazardous waste EPEAT'S requirement that all registered products meet ENERGY STAR's energy efficiency specifications, means that these products will consume less energy throughout their life.

CE Declaration of Conformity

This product is in conformity with the following standards

- EN60950-1:2006+A11:2009+A1:2010+A12:2011+A2:2013 (Safety requirement of Information Technology Equipment).
 - EN55022:2010(Radio Disturbance requirement of Information Technology Equipment).
 - EN55024:2010 (Immunity requirement of Information Technology Equipment).
 - EN61000-3-2:2006+A1:2009+A2:2009 (Limits for Harmonic Current Emission).
 - EN61000-3-3:2008 (Limitation of Voltage Fluctuation and Flicker).
 - EN50581:2012 (Technical documentation for the assessment of electrical and electronic products with respect to the restriction of hazardous substances)
 - EN 50564:2011 (Electrical and electronic household and office equipment — Measurement of low power consumption) following provisions of directives applicable
 - 2006/95/EC (Low Voltage Directive).
 - 2004/108/EC (EMC Directive).
 - 2009/125/EC (ErP, Energy-related Product Directive, EC No. 1275/2008 and 642/2009 Implementing)
 - 2011/65/EU (RoHS Directive) and is produced by a manufacturing organization on ISO9000 level
- And is produced by a manufacturing organization on ISO9000 level.
- ISO9241-307:2008 (Ergonomic requirement, Analysis and compliance test methods for electronic visual displays).

Energy Star Declaration

(www.energystar.gov)



As an ENERGY STAR® Partner, we have determined that this product meets the ENERGY STAR® guidelines for energy efficiency.

ⓘ Note

We recommend you switch off the Display when it is not in use for a long time.

Federal Communications Commission (FCC) Notice (U.S. Only)

ⓘ This equipment has been tested and found to comply with the limits for a Class B digital device, pursuant to Part 15 of the FCC Rules. These limits are designed to provide reasonable protection against harmful interference in a residential installation. This equipment generates, uses and can radiate radio frequency energy and, if not installed and used in accordance with the instructions, may cause harmful interference to radio communications.

However, there is no guarantee that interference will not occur in a particular installation. If this equipment does cause harmful interference to radio or television reception, which can be determined by turning the equipment off and on, the user is encouraged to try to correct the interference by one or more of the following measures:

- Reorient or relocate the receiving antenna.
- Increase the separation between the equipment and receiver.
- Connect the equipment into an outlet on a circuit different from that to which the receiver is connected.
- Consult the dealer or an experienced radio/TV technician for help.

ⓘ Changes or modifications not expressly approved by the party responsible for compliance could void the user's authority to operate the equipment.

Use only RF shielded cable that was supplied with the Display when connecting this Display to a computer device.

To prevent damage which may result in fire or shock hazard, do not expose this appliance to rain or excessive moisture.

THIS CLASS B DIGITAL APPARATUS MEETS ALL REQUIREMENTS OF THE CANADIAN INTERFERENCE-CAUSING EQUIPMENT REGULATIONS.

FCC Declaration of Conformity

Declaration of Conformity for Products Marked with FCC Logo,

United States Only



This device complies with Part 15 of the FCC Rules. Operation is subject to the following two conditions: (1) this device may not cause harmful interference, and (2) this device must accept any interference received, including interference that may cause undesired operation.

Commission Federale de la Communication (FCC Declaration)

ⓘ Cet équipement a été testé et déclaré conforme aux limites des appareils numériques de class B, aux termes de l'article 15 Des règles de la FCC. Ces limites sont conçues de façon à fournir une protection raisonnable contre les interférences nuisibles dans le cadre d'une installation résidentielle.

CET appareil produit, utilise et peut émettre des hyperfréquences qui, si l'appareil n'est pas installé et utilisé selon les consignes données, peuvent causer des interférences nuisibles aux communications radio.

6. Regulatory Information

Cependant, rien ne peut garantir l'absence d'interférences dans le cadre d'une installation particulière. Si cet appareil est la cause d'interférences nuisibles pour la réception des signaux de radio ou de télévision, ce qui peut être décelé en fermant l'équipement, puis en le remettant en fonction, l'utilisateur pourrait essayer de corriger la situation en prenant les mesures suivantes:

- Réorienter ou déplacer l'antenne de réception.
 - Augmenter la distance entre l'équipement et le récepteur.
 - Brancher l'équipement sur un autre circuit que celui utilisé par le récepteur.
 - Demander l'aide du marchand ou d'un technicien chevronné en radio/télévision.
- ⚠ Toutes modifications n'ayant pas reçu l'approbation des services compétents en matière de conformité est susceptible d'interdire à l'utilisateur l'usage du présent équipement.

N'utiliser que des câbles RF armés pour les connections avec des ordinateurs ou périphériques.

CET APPAREIL NUMERIQUE DE LA CLASSE B RESPECTE TOUTES LES EXIGENCES DU REGLEMENT SUR LE MATERIEL BROUILLEUR DU CANADA.

EN 55022 Compliance (Czech Republic Only)

This device belongs to category B devices as described in EN 55022, unless it is specifically stated that it is a Class A device on the specification label. The following applies to devices in Class A of EN 55022 (radius of protection up to 30 meters). The user of the device is obliged to take all steps necessary to remove sources of interference to telecommunication or other devices.

Pokud není na typovém štítku požadováno uvedeno, že spadá do třídy A podle EN 55022, spadá automaticky do třídy B podle EN 55022. Pro zařízení zařazená do třídy A (chranné pásmo 30m) podle EN 55022 platí následující. Dojde-li k rušení telekomunikačních nebo jiných zařízení je uživatel povinen provést taková opatření, aby rušení odstranil.

Polish Center for Testing and Certification Notice

The equipment should draw power from a socket with an attached protection circuit (a three-prong socket). All equipment that works

together (computer, Display, printer, and so on) should have the same power supply source.

The phasing conductor of the room's electrical installation should have a reserve short-circuit protection device in the form of a fuse with a nominal value no larger than 16 amperes (A).

To completely switch off the equipment, the power supply cable must be removed from the power supply socket, which should be located near the equipment and easily accessible.

A protection mark "B" confirms that the equipment is in compliance with the protection usage requirements of standards PN-93/T-42107 and PN-89/E-06251.

Wymagania Polskiego Centrum Badań i Certyfikacji

Urządzenie powinno być zasilane z gniazda z przyłączonym obwodem ochronnym (gniazdo z kolkiem). Współpracujące ze sobą urządzenia (komputer, monitor, drukarka) powinny być zasilane z tego samego gniazda.

Instalacja elektryczna pomieszczenia powinna zawierać w przewodzie fazowym rezerwową ochronę przed zwarciami, w postaci bezpiecznika o wartości znamionowej nie większej niż 16A (amperów). W celu całkowitego wyłączenia urządzenia zasilania, należy wyjąć wtyczkę kabla zasilającego z gniazda, które powinno znajdować się w pobliżu urządzenia i być łatwo dostępne. Znak bezpieczeństwa "B" potwierdza zgodność urządzenia z wymaganiami bezpieczeństwa użytkowania zawartymi w PN-93/T-42107 i PN-89/E-06251.

Pozostałe instrukcje bezpieczeństwa

- Nie należy używać wtyczek adapterowych lub usuwać kołka obwodu ochronnego z wtyczki. Jeżeli konieczne jest użycie przedłużacza to należy użyć przedłużacza 3-żyłowego z prawidłowo połączonym przewodem ochronnym.
- System komputerowy należy zabezpieczyć przed nagłymi, chwilowymi wzrostami lub spadkami napięcia, używając eliminatora przepięć, urządzenia doposażającego lub bezaktywnego źródła zasilania.
- Należy upewnić się, aby nic nie leżało na kablach systemu komputerowego, oraz aby kable nie były umieszczone w miejscu, gdzie można byłoby na nie nadsypywać lub potykać się o nie.
- Nie należy rozłączać napojów ani innych płynów na system komputerowy.
- Nie należy wpychać żadnych przedmiotów do otworów systemu komputerowego, gdyż może to spowodować pożar lub porażenie prądem, poprzez zwarcie elementów wewnętrznych.
- System komputerowy powinien znajdować się z dala od grzejników i źródeł ciepła. Ponadto, nie należy blokować otworów wentylacyjnych. Należy unikać kładzenia luznych papierów pod komputer oraz umieszczania komputera w ciasnym miejscu bez możliwości cyrkulacji powietrza wokół niego.

North Europe (Nordic Countries) Information

Placering/Ventilation
VARNING:
FÖRSÄKRA DIG OM ATT HUVUDBRYTARE
OCH UTTAG ÄR LÄTÅTKOMLIGA, NÄR
DU STÄLLER DIN UTRUSTNING PÅPLATS.

Placering/Ventilation
ADVARSEL:
SØRG VED PLACERINGEN FOR, AT
NETLEDNINGENS STIK OG STIKKONTAKT
ER NEMT TILGÆENGLIGE.

Paikka/Ilmankierto
VAROITUS:
SIJOITA LAITE SITEN, ETTÄ VERKKOJOHTO
VOIDAAN TARVITTAESSA HELPOSTI
IRROTTAA PISTORASIASTA.

Plassering/Ventilasjon
ADVARSEL:
NÅR DETTE UTSTYRET PLASSERES, MÅ
DU PASSE PÅ AT KONTAKTENE FOR
STØMTILFØRSEL ER LETTE Å NÅ.

Ergonomie Hinweis (nur Deutschland)

Der von uns gelieferte Farb Display entspricht den in der "Verordnung über den Schutz vor Schäden durch Röntgenstrahlen" festgelegten Vorschriften.

Auf der Rückwand des Gerätes befindet sich ein Aufkleber, der auf die Unbedenklichkeit der Inbetriebnahme hinweist, da die Vorschriften über die Bauart von Störstrahlern nach Anlage III α 5 Abs. 4 der Röntgenverordnung erfüllt sind.

Damit Ihr Display immer den in der Zulassung geforderten Werten entspricht, ist darauf zu achten, daß

1. Reparaturen nur durch Fachpersonal durchgeführt werden.
2. nur original-Ersatzteile verwendet werden.
3. bei Ersatz der Bildröhre nur eine bauartgleiche eingebaut wird.

Aus ergonomischen Gründen wird empfohlen, die Grundfarben Blau und Rot nicht auf dunklem Untergrund zu verwenden (schlechte Lesbarkeit und erhöhte Augenbelastung bei zu geringem Zeichenkontrast wären die Folge). Der arbeitsplatzbezogene Schalldruckpegel nach DIN 45 635 beträgt 70dB (A) oder weniger.

! ACHTUNG: BEIM AUFSTELLEN DIESES GERÄTES DARAUFG ACHTEN, DAß NETZSTECKER UND NETZKABELANSCHLUß LEICHT ZUGÄNGLICH SIND.

EU Energy Label



The European Energy Label informs you on the energy efficiency class of this product. The greener the energy efficiency class of this product is the lower the energy it consumes.

On the label, you can find the energy efficiency class, the average power consumption of this product in use and the average energy consumption for 1 year:

Note

The EU Energy Label will be ONLY applied on the models bundling with HDMI and TV tuners.

6. Regulatory Information

Restriction on Hazardous Substances statement (India)

This product complies with the "India E-waste Rule 2011" and prohibits use of lead, mercury, hexavalent chromium, polybrominated biphenyls or polybrominated diphenyl ethers in concentrations exceeding 0.1 weight % and 0.01 weight % for cadmium, except for the exemptions set in Schedule 2 of the Rule.

E-Waste Declaration for India



This symbol on the product or on its packaging indicates that this product must not be disposed of with your other household waste. Instead it is your responsibility to dispose of your waste equipment by handing it over to a designated collection point for the recycling of waste electrical and electronic equipment. The separate collection and recycling of your waste equipment at the time of disposal will help to conserve natural resources and ensure that it is recycled in a manner that protects human health and the environment. For more information about where you can drop off your waste equipment for recycling in India please visit the below web link.

<http://www.india.philips.com/about/sustainability/recycling/index.page>

Information for U.K. only

WARNING - THIS APPLIANCE MUST BE EARTHED.

Important:

This apparatus is supplied with an approved moulded 13A plug. To change a fuse in this type of plug proceed as follows:

1. Remove fuse cover and fuse.
2. Fit new fuse which should be a BS 1362 5A, A.S.T.A. or BSI approved type.
3. Retit the fuse cover.

If the fitted plug is not suitable for your socket outlets, it should be cut off and an appropriate 3-pin plug fitted in its place.

If the mains plug contains a fuse, this should have a value of 5A. If a plug without a fuse is used, the fuse at the distribution board should not be greater than 5A.

NOTE: The severed plug must be destroyed to avoid a possible shock hazard should it be inserted into a 13A socket elsewhere.

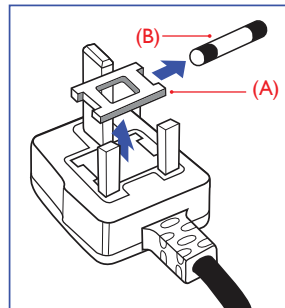

How to connect a plug

The wires in the mains lead are coloured in accordance with the following code:

BLUE - "NEUTRAL" ("N")

BROWN - "LIVE" ("L")

GREEN&YELLOW - "EARTH" ("E")

1. The GREEN&YELLOW wire must be connected to the terminal in the plug which is marked with the letter "E" or by the Earth symbol or coloured GREEN or GREEN&YELLOW.
2. The BLUE wire must be connected to the terminal which is marked with the letter "N" or coloured BLACK.
3. The BROWN wire must be connected to the terminal which is marked with the letter "L" or coloured RED.

Before replacing the plug cover, make certain that the cord grip is clamped over the sheath of the lead - not simply over the three wires.

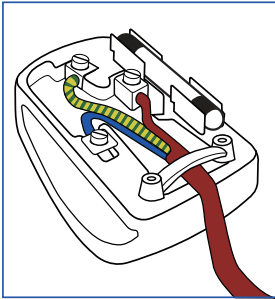

China RoHS

The People's Republic of China released a regulation called "Management Methods for Controlling Pollution by Electronic Information Products" or commonly referred to as China RoHS. All products produced and sold for China market have to meet China RoHS request.

根据中国大陆《电子电气产品有害物质限制使用标识要求》（也称为中国大陆 RoHS），以下部分列出了本产品中可能包含的有害物质的名称和含量。

| 部件名称 | 有害物质 | | | | | |
|----------|--------|--------|--------|--------------|------------|--------------|
| | 铅 (Pb) | 汞 (Hg) | 镉 (Cd) | 六价铬 (Cr(VI)) | 多溴联苯 (PBB) | 多溴二苯醚 (PBDE) |
| 外壳 | ○ | ○ | ○ | ○ | ○ | ○ |
| 液晶显示屏 | × | ○ | ○ | ○ | ○ | ○ |
| 电路板组件 | × | ○ | ○ | ○ | ○ | ○ |
| * 电源适配器 | × | ○ | ○ | ○ | ○ | ○ |
| 电源线 / 连线 | × | ○ | ○ | ○ | ○ | ○ |
| 接线 | | | | | | |

本表格依据 SJ/T 11364 的规定编制。
 *：电路板组件包括印刷电路板及其构成的零部件，如电阻、电容、集成电路、连接器等。
 ○：表示该有害物质在该部件所有均质材料中的含量均在 GB/T 26572 规定的限量要求以下。
 ×：表示该有害物质至少在该部件的某一均质材料中的含量超出 GB/T 26572 规定的限量要求。
 备注：以上“×”的部件中，部分含有有害物质超过是由于目前行业技术水平所限，暂时无法实现替代或减量。

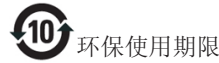

电子电气产品有害物质限制使用标识要求说明：该电子电气产品含有某些有害物质，在环保使用期限内可以放心使用，超过环保使用期限之后应该进入回收循环系统。

中国能源效率标识

根据中国大陆《能源效率标识管理办法》本显示器符合以下要求：

| | |
|-------------|---------------|
| 能源效率 (cd/W) | > 1.05 |
| 能效等级 | 1 级 |
| 能效标准 | GB 21520-2008 |

详细有关信息请查阅中国能效标识网：<http://www.energylabel.gov.cn/>

《废弃电器电子产品回收处理管理条例》提示性说明

为了更好地关爱及保护地球，当用户不再需要此产品或产品寿命终止时，请遵守国家废弃电器电子产品回收处理相关法律法规，将其交给当地具有国家认可的回收处理资质的厂商进行回收处理。

7. Customer care and warranty

7.1 Philips' Flat Panel Displays Pixel Defect Policy

Philips strives to deliver the highest quality products. We use some of the industry's most advanced manufacturing processes and practice stringent quality control. However, pixel or sub pixel defects on the TFT Display panels used in flat panel Displays are sometimes unavoidable. No manufacturer can guarantee that all panels will be free from pixel defects, but Philips guarantees that any Display with an unacceptable number of defects will be repaired or replaced under warranty. This notice explains the different types of pixel defects and defines acceptable defect levels for each type. In order to qualify for repair or replacement under warranty, the number of pixel defects on a TFT Display panel must exceed these acceptable levels. For example, no more than 0.0004% of the sub pixels on a Display may be defective. Furthermore, Philips sets even higher quality standards for certain types or combinations of pixel defects that are more noticeable than others. This policy is valid worldwide.

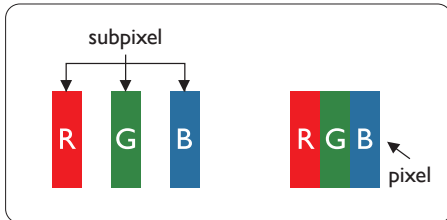

Pixels and Sub pixels

A pixel, or picture element, is composed of three sub pixels in the primary colors of red, green and blue. Many pixels together form an image. When all sub pixels of a pixel are lit, the three colored sub pixels together appear as a single white pixel. When all are dark, the three

colored sub pixels together appear as a single black pixel. Other combinations of lit and dark sub pixels appear as single pixels of other colors.

Types of Pixel Defects

Pixel and sub pixel defects appear on the screen in different ways. There are two categories of pixel defects and several types of sub pixel defects within each category.

Bright Dot Defects

Bright dot defects appear as pixels or sub pixels that are always lit or 'on'. That is, a bright dot is a sub-pixel that stands out on the screen when the Display displays a dark pattern. There are the types of bright dot defects.

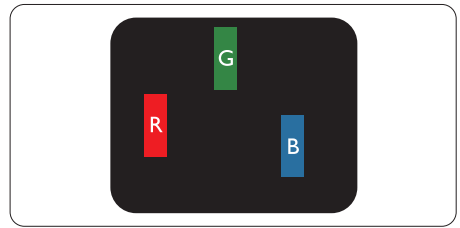

One lit red, green or blue sub pixel.

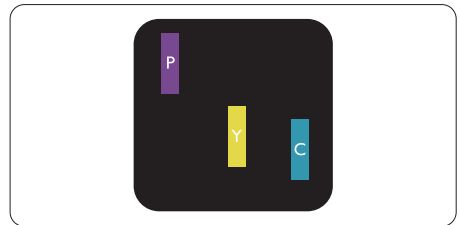

Two adjacent lit sub pixels:

- Red + Blue = Purple
- Red + Green = Yellow
- Green + Blue = Cyan (Light Blue)



Three adjacent lit sub pixels (one white pixel).

Note

A red or blue bright dot must be more than 50 percent brighter than neighboring dots while a green bright dot is 30 percent brighter than neighboring dots.

Black Dot Defects

Black dot defects appear as pixels or sub pixels that are always dark or 'off'. That is, a dark dot is a sub-pixel that stands out on the screen when the Display displays a light pattern. These are the types of black dot defects.

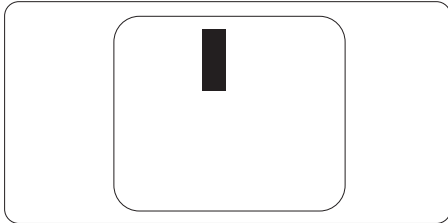

Proximity of Pixel Defects

Because pixel and sub pixels defects of the same type that are near to one another may be more noticeable, Philips also specifies tolerances for the proximity of pixel defects.

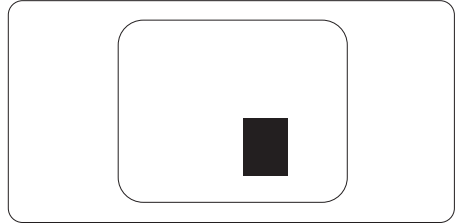

Pixel Defect Tolerances

In order to qualify for repair or replacement due to pixel defects during the warranty period, a TFT Display panel in a Philips flat panel Display must have pixel or sub pixel defects exceeding the tolerances listed in the following tables.

| BRIGHT DOT DEFECTS | ACCEPTABLE LEVEL |
|--|------------------|
| 1 lit subpixel | 3 |
| 2 adjacent lit subpixels | 1 |
| 3 adjacent lit subpixels (one white pixel) | 0 |
| Distance between two bright dot defects* | >15mm |
| Total bright dot defects of all types | 3 |
| BLACK DOT DEFECTS | ACCEPTABLE LEVEL |
| 1 dark subpixel | 5 or fewer |
| 2 adjacent dark subpixels | 2 or fewer |
| 3 adjacent dark subpixels | 0 |
| Distance between two black dot defects* | >15mm |
| Total black dot defects of all types | 5 or fewer |
| TOTAL DOT DEFECTS | ACCEPTABLE LEVEL |
| Total bright or black dot defects of all types | 5 or fewer |

Note

- 1 or 2 adjacent sub pixel defects = 1 dot defect
- This Display is ISO9241-307 compliant (ISO9241-307: Ergonomic requirement, analysis and compliance test methods for electronic visual displays)
- ISO9241-307 is the successor of formerly known ISO13406 standard, which is withdrawn by the International Organisation for Standardisation (ISO) per: 2008-11-13.

7.2 Customer Care & Warranty

For warranty coverage information and additional support requirement valid for your region, please visit www.philips.com/support website for details. You may also contact your local Philips Customer Care Center number listed below.

Contact Information for WESTERN EUROPE region:

| Country | CSP | Hotline Number | Price | Opening Hours |
|----------------|-------------|---------------------|-------------------|------------------------|
| Austria | RTS | +43 0810 000206 | € 0.07 | Mon to Fri : 9am - 6pm |
| Belgium | Ecare | +32 078 250851 | € 0.06 | Mon to Fri : 9am - 6pm |
| Cyprus | Alman | 800 92 256 | Free of charge | Mon to Fri : 9am - 6pm |
| Denmark | Infocare | +45 3525 8761 | Local call tariff | Mon to Fri : 9am - 6pm |
| Finland | Infocare | +358 09 2290 1908 | Local call tariff | Mon to Fri : 9am - 6pm |
| France | Mainteq | +33 082161 1658 | € 0.09 | Mon to Fri : 9am - 6pm |
| Germany | RTS | +49 01803 386 853 | € 0.09 | Mon to Fri : 9am - 6pm |
| Greece | Alman | +30 00800 3122 1223 | Free of charge | Mon to Fri : 9am - 6pm |
| Ireland | Celestica | +353 01 601 1161 | Local call tariff | Mon to Fri : 8am - 5pm |
| Italy | Anovo Italy | +39 840 320 041 | € 0.08 | Mon to Fri : 9am - 6pm |
| Luxembourg | Ecare | +352 26 84 30 00 | Local call tariff | Mon to Fri : 9am - 6pm |
| Netherlands | Ecare | +31 0900 0400 063 | € 0.10 | Mon to Fri : 9am - 6pm |
| Norway | Infocare | +47 2270 8250 | Local call tariff | Mon to Fri : 9am - 6pm |
| Poland | MSI | +48 0223491505 | Local call tariff | Mon to Fri : 9am - 6pm |
| Portugal | Mainteq | 800 780 902 | Free of charge | Mon to Fri : 8am - 5pm |
| Spain | Mainteq | +34 902 888 785 | € 0.10 | Mon to Fri : 9am - 6pm |
| Sweden | Infocare | +46 08 632 0016 | Local call tariff | Mon to Fri : 9am - 6pm |
| Switzerland | ANOVO CH | +41 02 2310 2116 | Local call tariff | Mon to Fri : 9am - 6pm |
| United Kingdom | Celestica | +44 0207 949 0069 | Local call tariff | Mon to Fri : 8am - 5pm |

Contact Information for China:

| Country | Call center | Consumer care number |
|---------|--------------|----------------------|
| China | PCCW Limited | 4008 800 008 |

Contact Information for NORTH AMERICA :

| Country | Call center | Consumer care number |
|---------|--------------|----------------------|
| U.S.A. | EPI-e-center | (877) 835-1838 |
| Canada | EPI-e-center | (800)479-6696 |

7. Customer care and warranty

Contact Information for CENTRAL AND EASTERN EUROPE region:

| Country | Call center | CSP | Consumer care number |
|-------------------------|-------------|------------------------|--|
| Belarus | NA | IBA | +375 17 217 3386 +375 17 217 3389 |
| Bulgaria | NA | LAN Service | +359 2 960 2360 |
| Croatia | NA | MR Service Ltd | +385 (01) 640 1111 |
| Czech Rep. | NA | Asupport | 420 272 188 300 |
| Estonia | NA | FUJITSU | +372 6519900(General) +372 6519972(workshop) |
| Georgia | NA | Esabi | +995 322 91 34 71 |
| Hungary | NA | Profi Service | +36 1 814 8080(General) +36 1814 8565(For AOC&Philips only) |
| Kazakhstan | NA | Classic Service I.l.c. | +7 727 3097515 |
| Latvia | NA | ServiceNet LV | +371 67460399 +371 27260399 |
| Lithuania | NA | UAB Servicenet | +370 37 400160(general) +370 7400088 (for Philips) |
| Macedonia | NA | AMC | +389 2 3125097 |
| Moldova | NA | Comel | +37322224035 |
| Romania | NA | Skin | +40 21 2101969 |
| Russia | NA | CPS | +7 (495) 645 6746 |
| Serbia&Montenegro | NA | Kim Tec d.o.o. | +381 11 20 70 684 |
| Slovakia | NA | Datalan Service | +421 2 49207155 |
| Slovenia | NA | PC H.and | +386 1 530 08 24 |
| the republic of Belarus | NA | ServiceBy | + 375 17 284 0203 |
| Turkey | NA | Tecpro | +90 212 444 4 832 |
| Ukraine | NA | Topaz | +38044 525 64 95 |
| Ukraine | NA | Comel | +380 5627444225 |

Contact Information for LATIN AMERICA region:

| Country | Call center | Consumer care number |
|-----------|-------------|----------------------|
| Brazil | Vermont | 0800-7254101 |
| Argentina | | 0800 3330 856 |

Contact Information for APMEA region:

| Country | ASP | Consumer care number | Opening hours |
|--|--|--|--|
| Australia | AGOS NETWORK PTY LTD | 1300 360 386 | Mon.~Fri. 9:00am-5:30pm |
| New Zealand | Visual Group Ltd. | 0800 657447 | Mon.~Fri. 8:30am-5:30pm |
| Hong Kong Macau | Company: Smart Pixels Technology Ltd. | Hong Kong: Tel: +852 2619 9639 Macau:Tel: (853)-0800-987 | Mon.~Fri. 9:00am-6:00pm Sat. 9:00am-1:00pm |
| India | REDINGTON INDIA LTD | Tel: 1 800 425 6396 SMS: PHILIPS to 56677 | Mon.~Fri. 9:00am-5:30pm |
| Indonesia | PT. CORMIC SERVISINDO PERKASA | +62-21-4080-9086 (Customer Hotline) +62-8888-01-9086 (Customer Hotline) | Mon.~Thu. 08:30-12:00; 13:00-17:30 Fri. 08:30-11:30; 13:00-17:30 |
| Korea | Alphascan Displays, Inc | 1661-5003 | Mon.~Fri. 9:00am-5:30pm Sat. 9:00am-1:00pm |
| Malaysia | R-Logic Sdn Bhd | +603 5102 3336 | Mon.~Fri. 8:15am-5:00pm Sat. 8:30am-12:30am |
| Pakistan | TVONICS Pakistan | +92-213-6030100 | Sun.~Thu. 10:00am-6:00pm |
| Singapore | Philips Electronics Singapore Pte Ltd (Philips Consumer Care Center) | (65) 6882 3966 | Mon.~Fri. 9:00am-6:00pm Sat. 9:00am-1:00pm |
| Taiwan | FETEC.CO | 0800-231-099 | Mon.~Fri. 09:00 - 18:00 |
| Thailand | Axis Computer System Co., Ltd. | (662) 934-5498 | Mon.~Fri. 8:30am~05:30pm |
| South Africa | Computer Repair Technologies | 011 262 3586 | Mon.~Fri. 8:00am~05:00pm |
| Israel | Eastronics LTD | 1-800-567000 | Sun.~Thu. 08:00-18:00 |
| Vietnam | FPT Service Informatic Company Ltd. - Ho Chi Minh City Branch | +84 8 38248007 Ho Chi Minh City +84 5113.562666 Danang City +84 5113.562666 Can tho Province | Mon.~Fri. 8:00-12:00, 13:30- 17:30,Sat. 8:00-12:00 |
| Philippines | EA Global Supply Chain Solutions ,Inc. | (02) 655-7777; 6359456 | Mon.~Fri. 8:30am~5:30pm |
| Armenia Azerbaijan Georgia Kyrgyzstan Tajikistan | Firebird service centre | +97 14 8837911 | Sun.~Thu. 09:00 - 18:00 |
| Uzbekistan | Soniko Plus Private Enterprise Ltd | +99871 2784650 | Mon.~Fri. 09:00 - 18:00 |
| Turkmenistan | Technostar Service Centre | +(99312) 460733, 460957 | Mon.~Fri. 09:00 - 18:00 |
| Japan | フィリップスモニター・サ ポートセンター | 0120-060-530 | Mon.~Fri. 10:00 - 17:00 |

8. Troubleshooting & FAQs

8.1 Troubleshooting

This page deals with problems that can be corrected by a user. If the problem still persists after you have tried these solutions, contact Philips customer service representative.

1 Common Problems

No Picture (Power LED not lit)

- Make sure the power cord is plugged into the power outlet and into the back of the Display.
- First, ensure that the power button on the front of the Display is in the OFF position, then press it to the ON position.

No Picture (Power LED is White)

- Make sure the computer is turned on.
- Make sure the signal cable is properly connected to your computer.
- Make sure the Display cable has no bent pins on the connect side. If yes, repair or replace the cable.
- The Energy Saving feature may be activated

Screen says

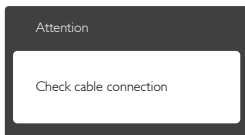

- Make sure the Display cable is properly connected to your computer: (Also refer to the Quick Start Guide).
- Check to see if the Display cable has bent pins.
- Make sure the computer is turned on.

AUTO button doesn't function

- The auto function is applicable only in VGA-Analog mode. If the result is not

satisfactory, you can do manual adjustments via the OSD menu.

Note

The Auto Function is not applicable in DVI-Digital mode as it is not necessary.

Visible signs of smoke or sparks

- Do not perform any troubleshooting steps
- Disconnect the Display from mains power source immediately for safety
- Contact with Philips customer service representative immediately.

2 Imaging Problems

Image is not centered

- Adjust the image position using the "Auto" function in OSD Main Controls.
- Adjust the image position using the Phase/Clock of Setup in OSD Main Controls. It is valid only in VGA mode.

Image vibrates on the screen

- Check that the signal cable is properly securedly connected to the graphics board or PC.

Vertical flicker appears



- Adjust the image using the "Auto" function in OSD Main Controls.
- Eliminate the vertical bars using the Phase/Clock of Setup in OSD Main Controls. It is valid only in VGA mode.

Horizontal flicker appears



- Adjust the image using the "Auto" function in OSD Main Controls.

8. Troubleshooting & FAQs

- Eliminate the vertical bars using the Phase/Clock of Setup in OSD Main Controls. It is valid only in VGA mode.

Image appears blurred, indistinct or too dark

- Adjust the contrast and brightness on On-Screen Display.

An "after-image", "burn-in" or "ghost image" remains after the power has been turned off.

- Uninterrupted display of still or static images over an extended period may cause "burn in", also known as "after-imaging" or "ghost imaging", on your screen. "Burn-in", "after-imaging", or "ghost imaging" is a well-known phenomenon in LCD panel technology. In most cases, the "burned in" or "after-imaging" or "ghost imaging" will disappear gradually over a period of time after the power has been switched off.
- Always activate a moving screen saver program when you leave your Display unattended.
- Always activate a periodic screen refresh application if your LCD Display will display unchanging static content.
- Failure to activate a screen saver, or a periodic screen refresh application may result in severe "burn-in" or "after-image" or "ghost image" symptoms that will not disappear and cannot be repaired. The damage mentioned above is not covered under your warranty.

Image appears distorted. Text is fuzzy or blurred.

- Set the PC's display resolution to the same mode as Display's recommended screen native resolution.

Green, red, blue, dark, and white dots appears on the screen

- The remaining dots are normal characteristic of the liquid crystal used in today's technology, Please refer the pixel policy for more detail.

The "power on" light is too strong and is disturbing

- You can adjust "power on" light using the power LED Setup in OSD main Controls.

For further assistance, refer to the Consumer Information Centers list and contact Philips customer service representative.

8.2 General FAQs

Q1: When I install my Display what should I do if the screen shows 'Cannot display this video mode'?

Ans.: Recommended resolution for this Display: 3840 x 2160 @ 60 Hz.

- Unplug all cables, then connect your PC to the Display that you used previously.
- In the Windows Start Menu, select Settings/Control Panel. In the Control Panel Window, select the Display icon. Inside the Display Control Panel, select the 'Settings' tab. Under the setting tab, in box labelled 'desktop area', move the sidebar to 3840 x 2160 pixels.
- Open 'Advanced Properties' and set the Refresh Rate to 60 Hz, then click OK.
- Restart your computer and repeat step 2 and 3 to verify that your PC is set at 3840 x 2160 @ 60 Hz.
- Shut down your computer; disconnect your old Display and reconnect your Philips LCD Display.
- Turn on your Display and then turn on your PC.

Q2: What is the recommended refresh rate for LCD Display?

Ans.: Recommended refresh rate in LCD Displays is 60 Hz, In case of any disturbance on screen, you can set it up to 75 Hz to see if that removes the disturbance.

Q3: What are the .inf and .icm files on the CD-ROM? How do I install the drivers (.inf and .icm)?

Ans.: These are the driver files for your Display. Follow the instructions in your user manual to install the drivers. Your computer may ask you for Display drivers (.inf and .icm files) or a driver disk when you first install your Display. Follow the instructions to insert the companion CD-ROM included in this package. Display drivers (.inf and .icm files) will be installed automatically.

Q4: How do I adjust the resolution?

Ans.: Your video card/graphic driver and Display together determine the available resolutions. You can select the desired resolution under Windows® Control Panel with the "Display properties".

Q5: What if I get lost when I am making Display adjustments via OSD?

Ans.: Simply press the **OK** button, then select 'Reset' to recall all of the original factory settings.

Q6: Is the LCD screen resistant to scratches?

Ans.: In general it is recommended that the panel surface is not subjected to excessive shocks and is protected from sharp or blunt objects. When handling the Display, make sure that there is no pressure or force applied to the panel surface side. This may affect your warranty conditions.

Q7: How should I clean the LCD surface?

Ans.: For normal cleaning, use a clean, soft cloth. For extensive cleaning, please use isopropyl alcohol. Do not use other solvents such as ethyl alcohol, ethanol, acetone, hexane, etc.

Q8: Can I change the color setting of my Display?

Ans.: Yes, you can change your color setting through OSD control as the following procedures,

- Press "OK" to show the OSD (On Screen Display) menu
- Press "Down Arrow" to select the option "Color" then press "OK" to enter color setting, there are three settings as below.
 1. Color Temperature: The six settings are 5000K, 6500K, 7500K, 8200K, 9300K and 11500K. With settings in the 5000K range the panel appears "warm, with a red-white color tone", while a 11500K temperature yields "cool, bluewhite toning".
 2. sRGB: This is a standard setting for ensuring correct exchange of colors between different device (e.g. digital cameras, Displays, printers, scanners, etc).
 3. User Define: The user can choose his/her preference color setting by adjusting red, green blue color.

Note

A measurement of the color of light radiated by an object while it is being heated. This measurement is expressed in terms of absolute scale, (degrees Kelvin). Lower Kelvin temperatures such as 2004K are red; higher temperatures such as 9300K are blue. Neutral temperature is white, at 6504K.

Q9: Can I connect my LCD Display to any PC, workstation or Mac?

Ans.: Yes. All Philips LCD Displays are fully compatible with standard PCs, Macs and workstations. You may need a cable adapter to connect the Display to your Mac system. Please contact your Philips sales representative for more information.

Q10: Are Philips LCD Displays Plug-and-Play?

Ans.: Yes, the Displays are Plug-and-Play compatible with Windows 8.1/8/7.

Q11: What is Image Sticking, or Image Burn-in, or After Image, or Ghost Image in LCD panels?

Ans.: Uninterrupted display of still or static images over an extended period may cause "burn in", also known as "after-imaging" or "ghost imaging", on your screen. "Burn-in", "after-imaging", or "ghost imaging" is a well-known phenomenon in LCD panel technology. In most cases, the "burned in" or "after-imaging" or "ghost imaging" will disappear gradually over a period of time after the power has been switched off.

Always activate a moving screen saver program when you leave your Display unattended.

Always activate a periodic screen refresh application if your LCD Display will display unchanging static content.

 **Warning**

Failure to activate a screen saver, or a periodic screen refresh application may result in severe "burn-in" or "after-image" or "ghost image" symptoms that will not disappear and cannot be repaired. The damage mentioned above is not covered under your warranty.

Q12: Why is my Display not showing sharp text, and is displaying jagged characters?

Ans.: Your LCD Display works best at its native resolution of 3840 x 2160 @ 60 Hz. For best display, please use this resolution.

Q13: How to unlock/lock my hot key?

Ans.: Please press /OK for 10 seconds to unlock/lock the hot key, by doing so, your Display pops out "Attention" to show the unlock/lock status as shown below illustrators.

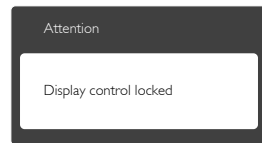
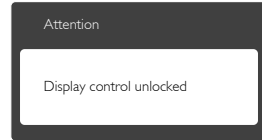

8.3 Multiview FAQs

Q1: Can I enlarge the PIP sub window ?

Ans.: Yes, there are 3 sizes to select: [**Small**], [**Middle**], [**Large**]. You can press  to enter OSD menu. Select your preferred [**PIP Size**] option from the [**PIP / PBP**] main menu.

Q2: How to listen to Audio, independent of video?

Ans.: Normally the audio source is linked to the main picture source. If you want to change audio-source input (for example: listen to your MP3 player independently regardless of the video source input), you can press  to enter OSD menu. Select your preferred [**Audio Source**] option from the [**Audio**] main menu.

Please note that the next time you turn on your Display, the Display will by default select the audio source you chose last time. In case you want to change it again, you need to go through the above steps to select your new preferred audio source, which then will become the "default" mode.

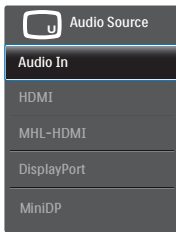



© 2015 Koninklijke Philips N.V. All rights reserved.

Philips and the Philips Shield Emblem are registered trademarks of Koninklijke Philips N.V. and are used under license from Koninklijke Philips N.V.

Specifications are subject to change without notice.

Version: BDM4065E1T