

Always there to help you

Register your product and get support at
www.philips.com/support



HTL3110B



Quick start guide

PHILIPS



Before using your product, read all accompanying safety information

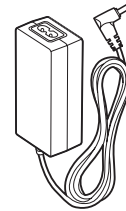
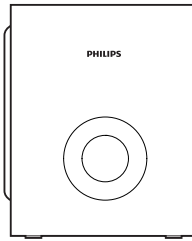

Power Adapter

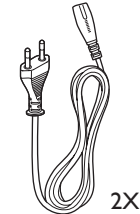

Power Cord

2X



Cable Tie

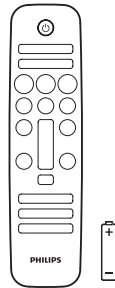

4 X

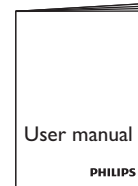

1

Assemble your SoundBar
Position the SoundBar

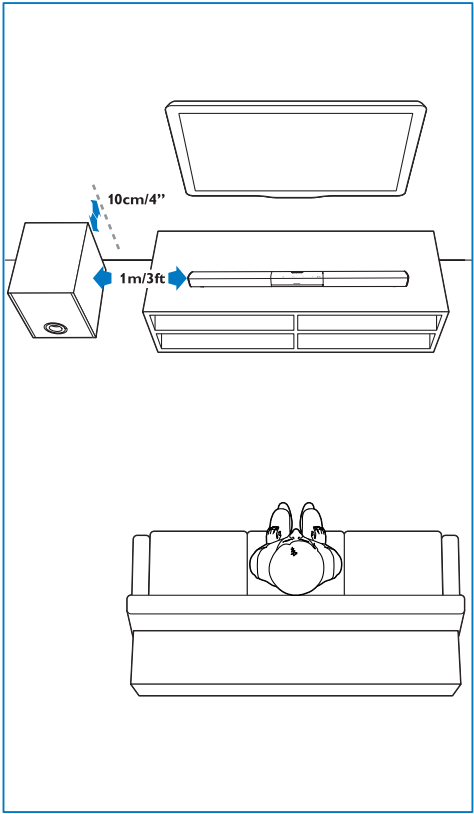
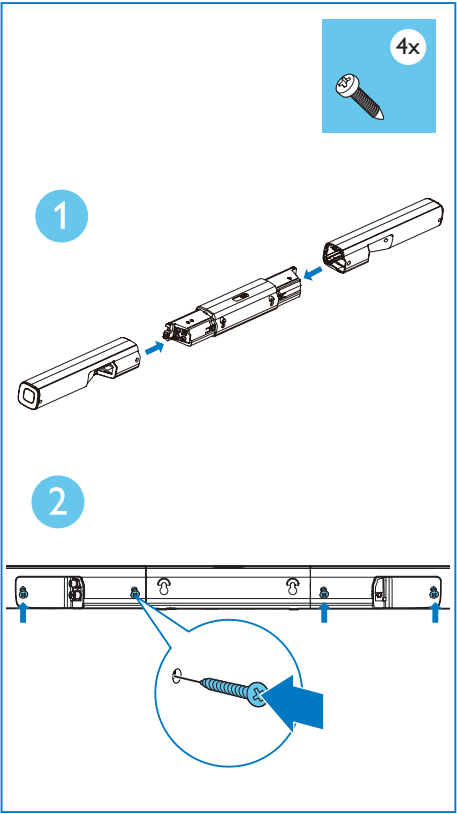

Wall mount the SoundBar (optional)

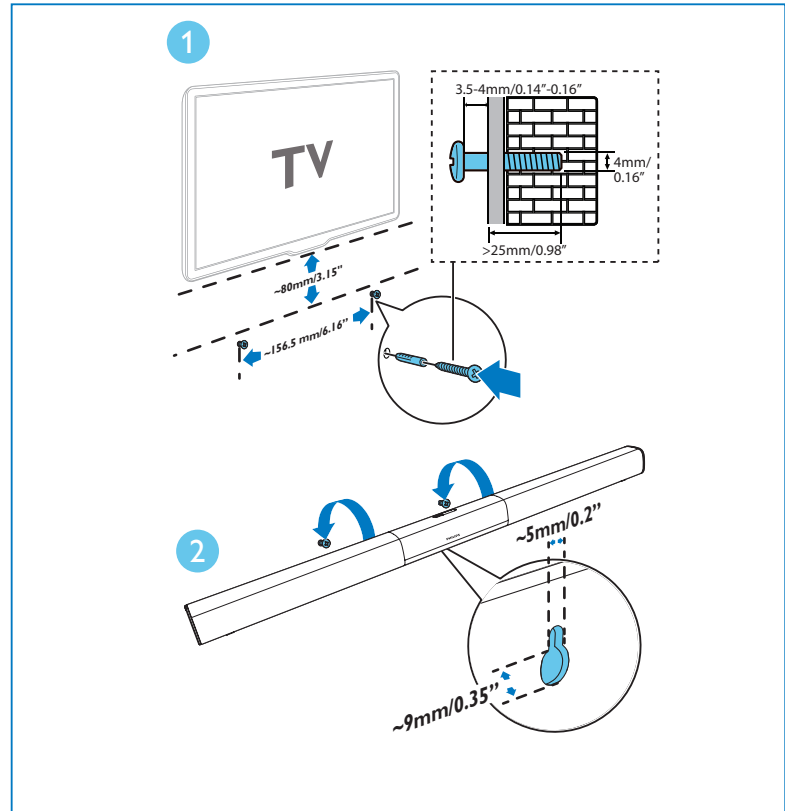

2

Connect the SoundBar

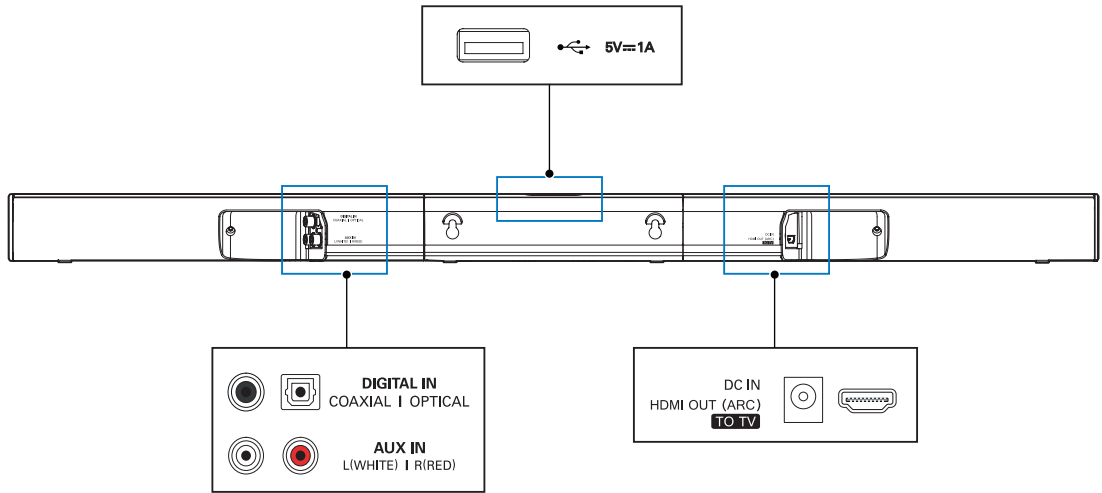

3

Hear audio from TV in one of the following ways.

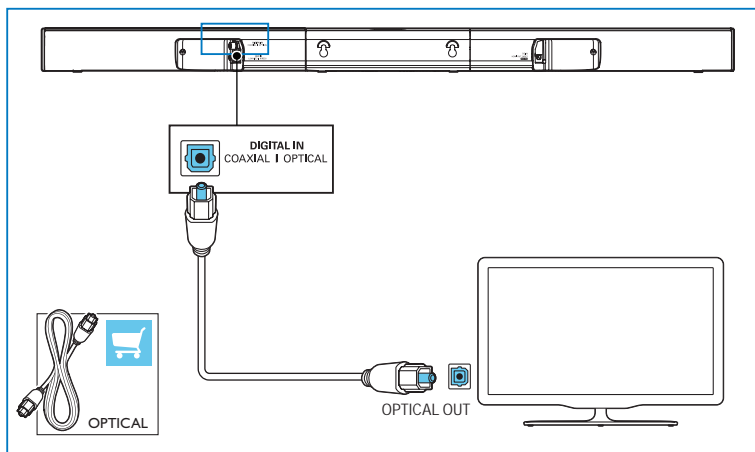
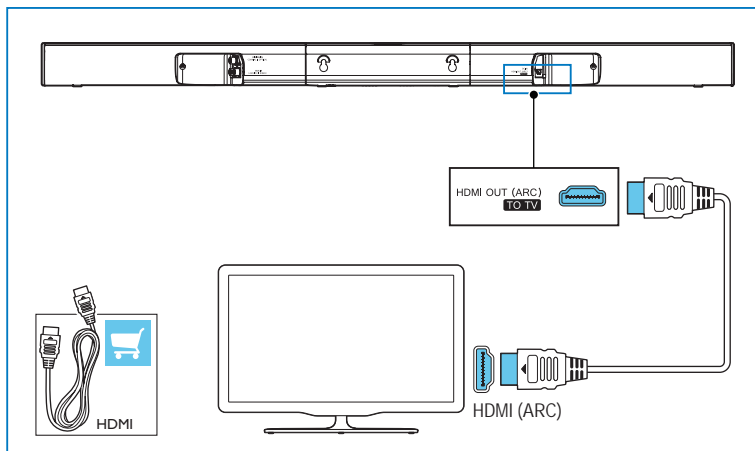

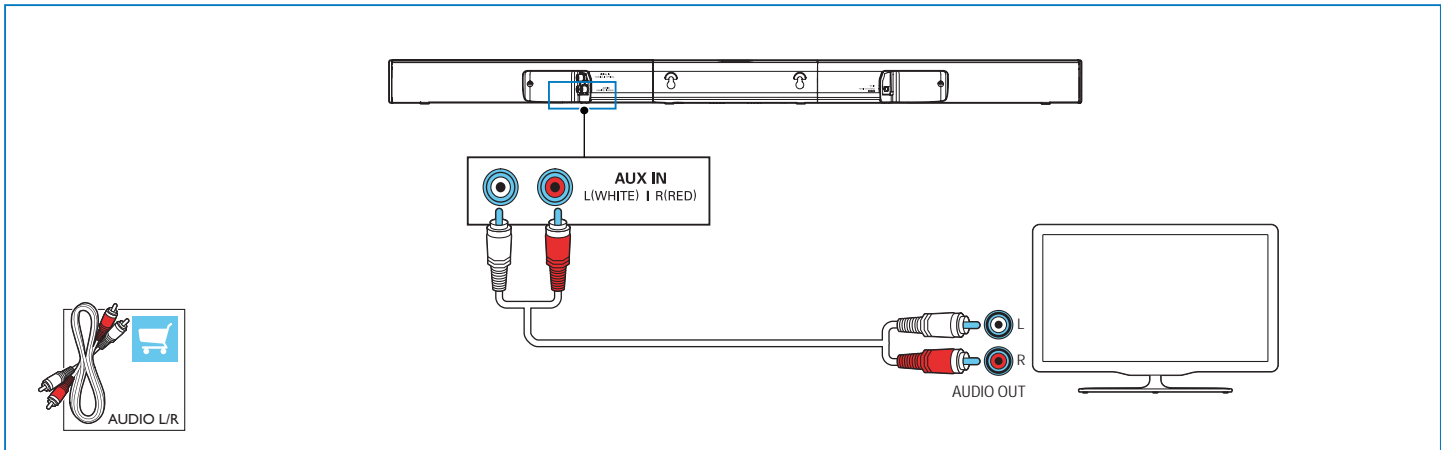
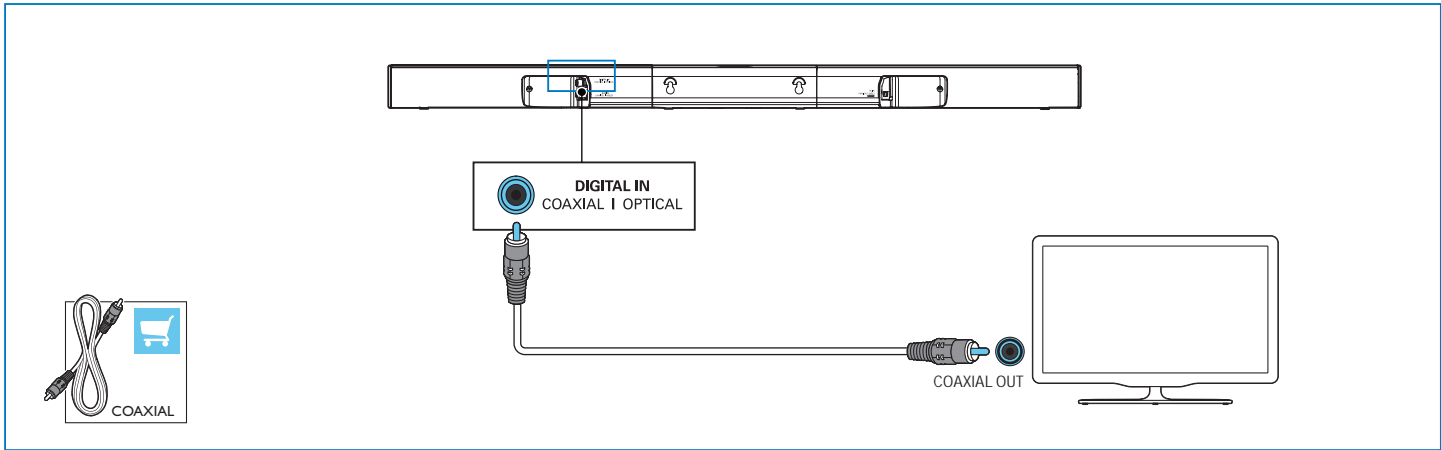

4

Switch on the SoundBar

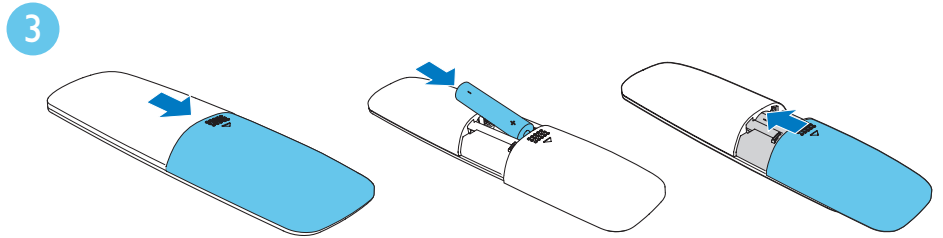
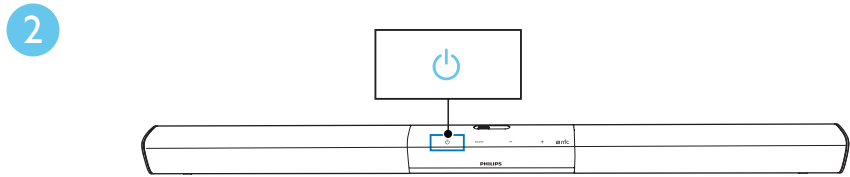
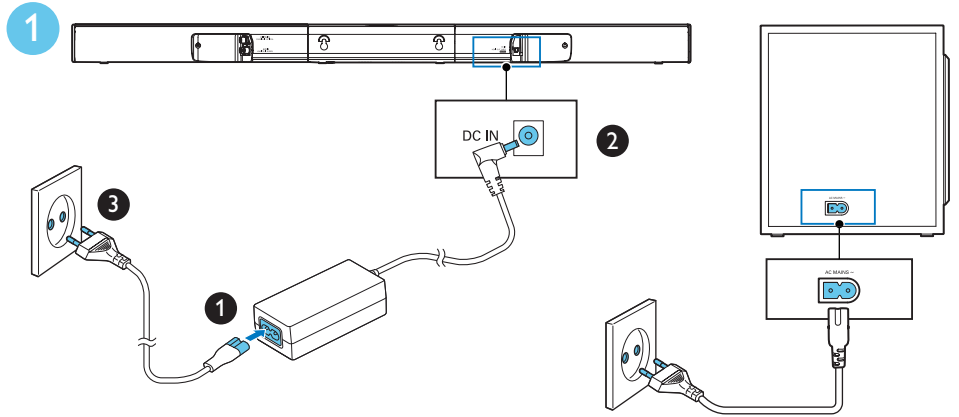

5

Select the correct audio source

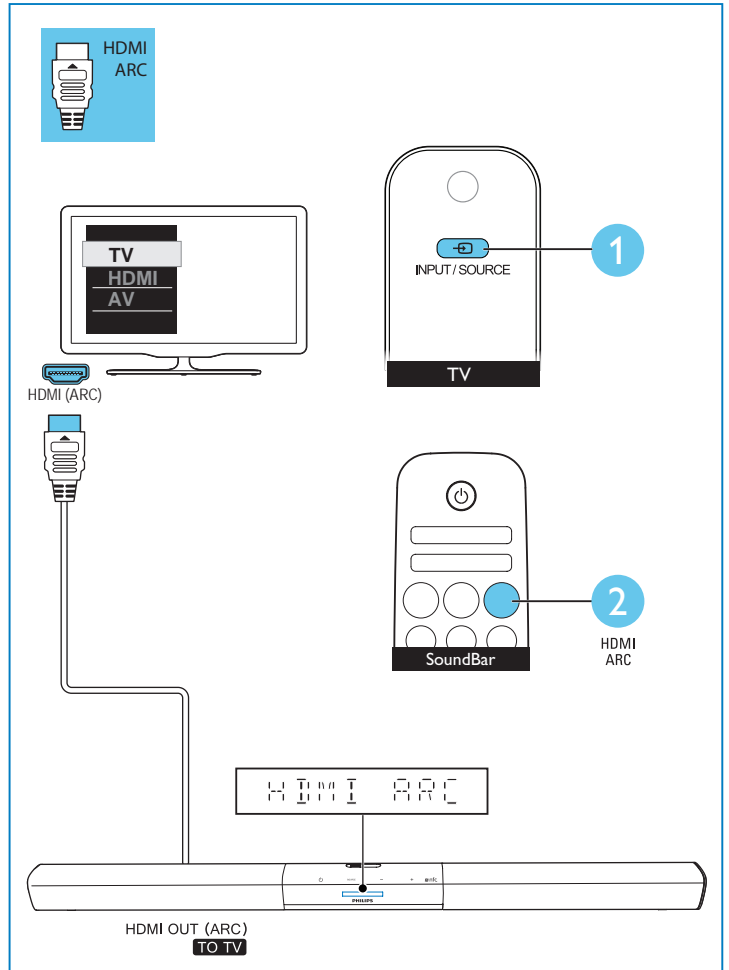

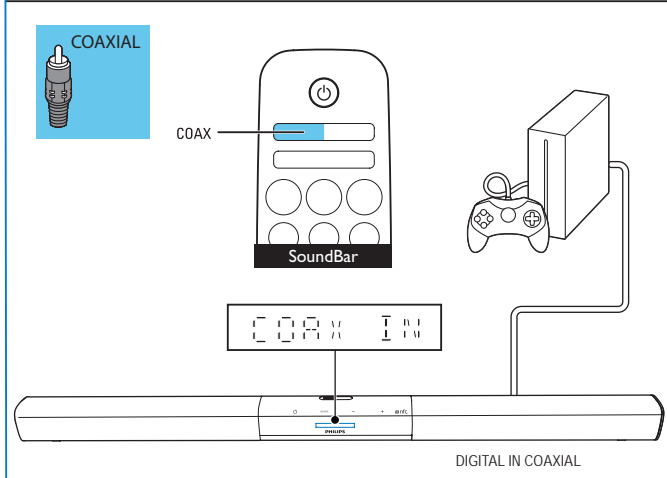
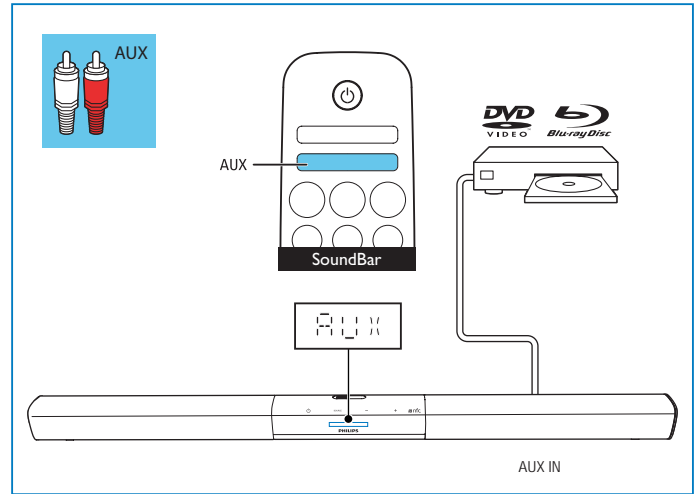
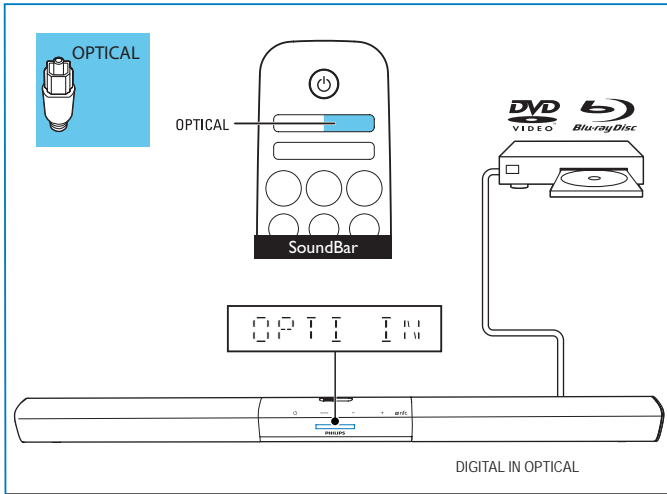

6

Play audio on a USB storage device

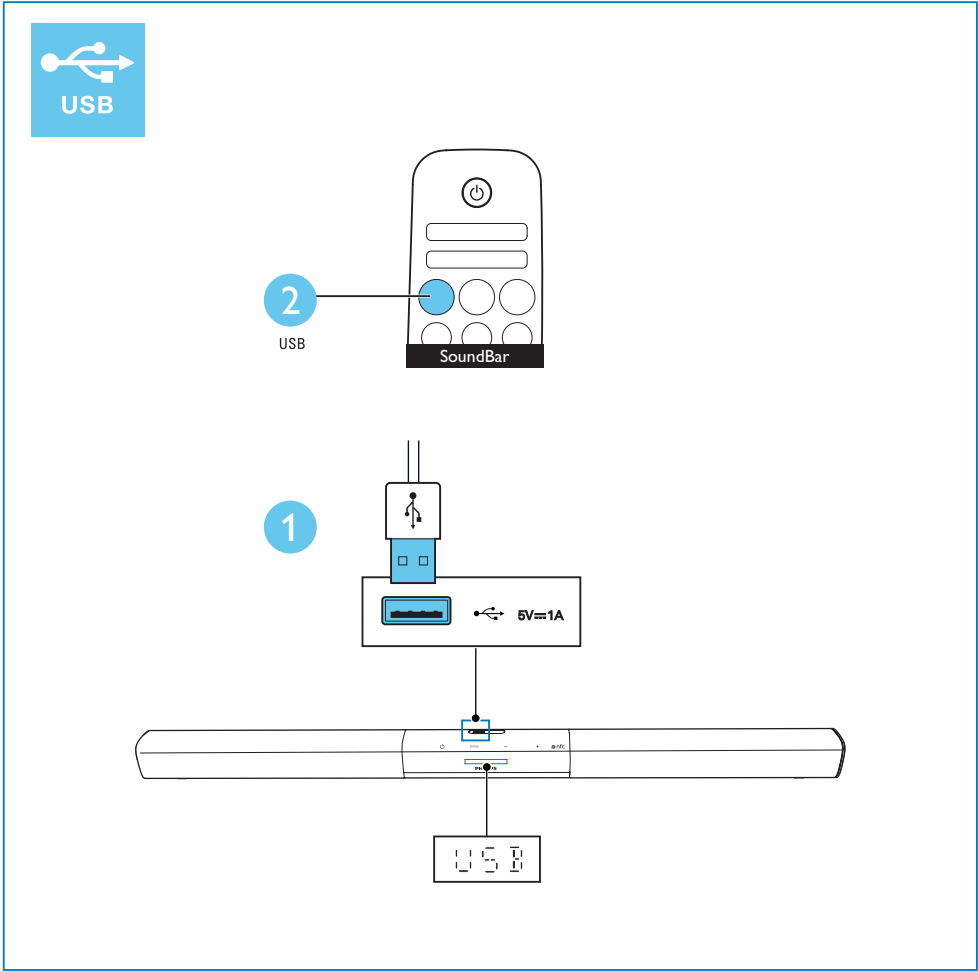

7

Play audio through Bluetooth or connect Bluetooth via NFC

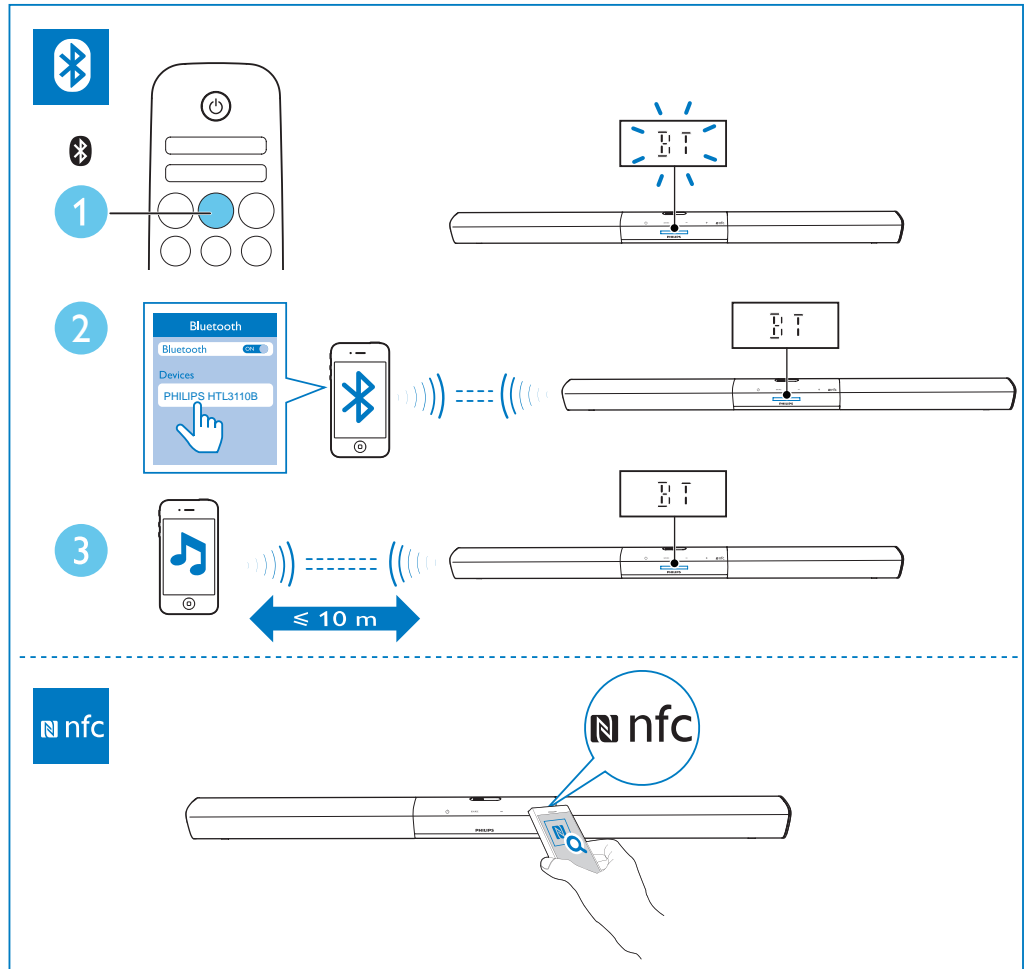

Cable management

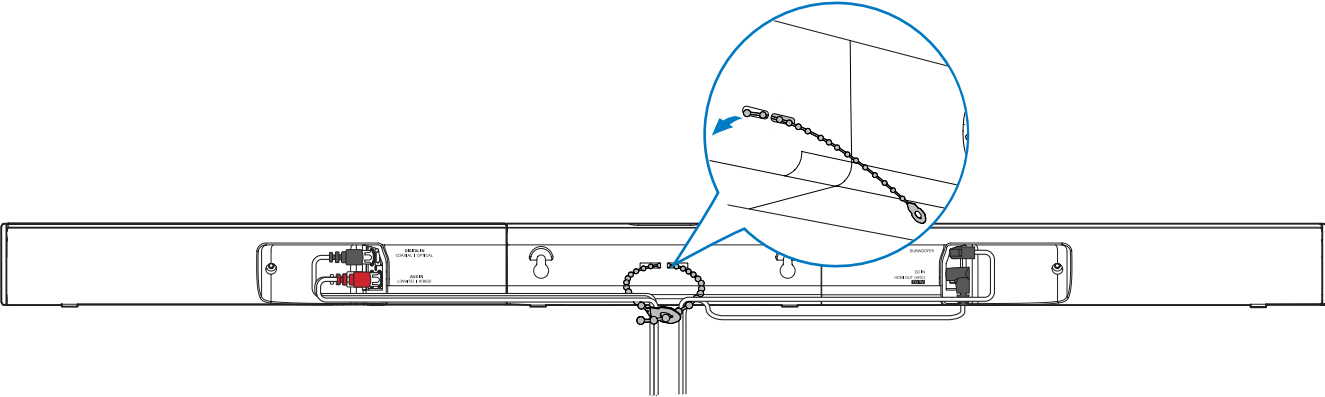



For more information about using this product, visit www.philips.com/support



www.philips.com/support



Specifications are subject to change without notice
2015 © Gibson Innovations Limited. All rights reserved.

This product has been manufactured by, and is sold under the responsibility of Gibson Innovations Ltd., and Gibson Innovations Ltd. is the warrantor in relation to this product. Philips and the Philips Shield Emblem are registered trademarks of Koninklijke Philips N.V. and are used under license from Koninklijke Philips N.V.

HTL3110B_79_QSG_V2.0

