

Register your product and get support at  
[www.philips.com/TVsupport](http://www.philips.com/TVsupport)

**8601 series**

# User Manual

55PUS8601

**PHILIPS**

---

# Contents

<b>1 What's new</b>	<b>4</b>
1.1 Home and channels	4
1.2 Apps and Philips TV Collection	4
<b>2 Setting Up</b>	<b>5</b>
2.1 Read Safety	5
2.2 TV Stand and Wall Mounting	5
2.3 Tips on Placement	5
2.4 Power Cable	5
2.5 Antenna Cable	6
2.6 Satellite Dish	6
2.7 Side Speakers	7
<b>3 Remote Control</b>	<b>8</b>
3.1 Key Overview	8
3.2 Pairing the Remote Control	9
3.3 Voice Search	9
3.4 Touch Pad	9
3.5 Keyboard	10
3.6 Remote Control Sensor	11
3.7 Batteries	11
3.8 Cleaning	11
<b>4 Switching On and Off</b>	<b>12</b>
4.1 On or Standby	12
4.2 Keys on TV	12
<b>5 Channels</b>	<b>13</b>
5.1 Satellite Installation	13
5.2 Antenna/Cable Installation	15
5.3 Channel List Copy	17
5.4 About Channels	18
5.5 Filter a Channel List	23
<b>6 Connect Devices</b>	<b>25</b>
6.1 About Connections	25
6.2 HDMI Ports	25
6.3 Y Pb Pr - Component	26
6.4 Scart	27
6.5 Audio Out - Optical	27
6.6 CAM with Smart Card - CI+	27
6.7 Home Theatre System - HTS	28
6.8 Smartphones and Tablets	29
6.9 Blu-ray Disc Player	30
6.10 DVD Player	30
6.11 Bluetooth - Speakers and Gamepads	30
6.12 Headphones	31
6.13 Game Console	31
6.14 Gamepad	32
6.15 USB Hard Drive	32
6.16 USB Keyboard	33
6.17 USB Flash Drive	34
6.18 Photo Camera	34
6.19 Camcorder	34
6.20 Computer	35
6.21 PTA860 Wireless Speaker Stands	35
<b>7 Connect your Android TV</b>	<b>37</b>
7.1 Network and Internet	37
7.2 Google Account	39
7.3 Philips TV Collection app	40
7.4 Android Settings	40
7.5 Home Screen	41
<b>8 Apps</b>	<b>42</b>
8.1 About Apps	42
8.2 Google Play	42
8.3 Start or Stop an App	43
8.4 Lock Apps	43
8.5 Manage Apps	44
8.6 Storage	45
<b>9 Internet</b>	<b>46</b>
9.1 Start Internet	46
9.2 Options on Internet	46
<b>10 TV Menu</b>	<b>47</b>
10.1 About TV Menu	47
10.2 Open TV Menu	47
<b>11 Sources</b>	<b>48</b>
11.1 Switch to a device	48
11.2 Options for a TV Input	48
11.3 Device Name and Type	48
11.4 Computer	48
<b>12 Settings</b>	<b>50</b>
12.1 Frequent Settings	50
12.2 Picture	50
12.3 Sound	55
12.4 Ambilight Settings	57
12.5 Eco Settings	60
12.6 General Settings	60
12.7 Clock, Region and Language	63
12.8 Universal Access	65
12.9 Child Lock	66
<b>13 Videos, Photos and Music</b>	<b>68</b>
13.1 From a USB Connection	68
13.2 From a Computer or NAS	68
13.3 From a Cloud Storage Service	68
13.4 Favourites, Most Popular, Last Played menu	68
13.5 Play your Videos	68
13.6 View your Photos	69
13.7 Play your Music	69
<b>14 TV Guide</b>	<b>71</b>
14.1 What You Need	71
14.2 TV Guide Data	71
14.3 Using the TV Guide	71
<b>15 Recording and Pause TV</b>	<b>73</b>
15.1 Recording	73
15.2 Pause TV	74
<b>16 Smartphones and Tablets</b>	<b>76</b>
16.1 Philips TV Remote App	76
16.2 Google Cast	76
16.3 AirPlay	76
16.4 MHL	76
<b>17 Games</b>	<b>77</b>
17.1 What You Need	77
17.2 Play a Game	77
<b>18 Ambilight</b>	<b>78</b>
18.1 Ambilight Style	78
18.2 Ambilight Off	78
18.3 Ambilight Settings	78
18.4 Lounge Light Mode	79
<b>19 Top Picks</b>	<b>80</b>
19.1 About Top Picks	80

19.2	Now on TV	80
19.3	TV on Demand	80
19.4	Video on Demand	80
<b>20</b>	<b>Netflix</b>	<b>82</b>
<b>21</b>	<b>Multi View</b>	<b>83</b>
21.1	TV and TV	83
21.2	Text and TV	83
21.3	HDMI and TV	83
21.4	Nettv and TV	83
21.5	Nettv and HDMI	83
<b>22</b>	<b>Software</b>	<b>84</b>
22.1	Update Software	84
22.2	Software Version	84
22.3	Automatic software update	84
22.4	Open Source Software	85
22.5	Open Source License	85
22.6	Announcements	85
<b>23</b>	<b>Specifications</b>	<b>86</b>
23.1	Environmental	86
23.2	Power	86
23.3	Operating System	86
23.4	Reception	86
23.5	Display Type	87
23.6	Display Input Resolution	87
23.7	Dimensions and Weights	87
23.8	Connectivity	87
23.9	Sound	87
23.10	Multimedia	87
<b>24</b>	<b>Help and Support</b>	<b>89</b>
24.1	Register your TV	89
24.2	Using Help	89
24.3	Troubleshooting	89
24.4	Online Help	91
24.5	Support and Repair	91
<b>25</b>	<b>Safety and Care</b>	<b>93</b>
25.1	Safety	93
25.2	Cleaning	94
25.3	Screen Care	94
<b>26</b>	<b>Terms of Use</b>	<b>95</b>
26.1	Terms of Use - TV	95
26.2	Terms of Use - Philips TV Collection	95
<b>27</b>	<b>Copyrights</b>	<b>96</b>
27.1	MHL	96
27.2	HDMI	96
27.3	Dolby Digital Plus	96
27.4	DTS Premium Sound™	96
27.5	Microsoft	96
27.6	Wi-Fi Alliance	96
27.7	Kensington	96
27.8	Other Trademarks	97
<b>28</b>	<b>Disclaimer regarding services and/or software offered by third parties</b>	<b>98</b>
<b>Index</b>		<b>99</b>

# What's new

## Home and channels

### The new Home launcher

Press  HOME on your remote control to get your new Android Home screen. From here you can decide what to watch by browsing entertainment options from app and live TV. Your Home has channels to let you discover great contents from your favourite apps. You can also add additional channels or find new apps to get more contents.

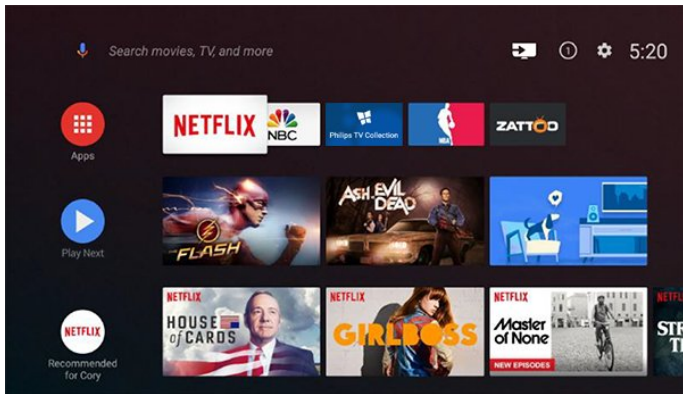

### “Play Next” channel

You can always know what to watch next from Play Next channel on the Home screen. Start watching from where you left off and get notifications about new episodes in the Play Next channel. Press and hold Select on a movie or TV show to add it directly to the Play Next channel.

### Accessing settings from Home

You can access All Settings menu via the icon at the top right corner. You can also find the Frequent settings menu and common menu items in the Philips TV Menu, which can be invoked directly from the remote control.

### System bar on Home screen

The System bar on the top of Home screen contains following features.

- Search button: to trigger Google search with voice or text input.
- Input source: to launch the input source list and switch to any of the connected devices.
- Notifications: to provide you the messages about your Smart TV system.
- Settings: to access all setting menu and adjust the TV settings.
- Clock: to indicate the system clock.

# Apps and Philips TV Collection

### Favourite Apps on the first row

You can find more apps in the Apps page which can be opened by clicking the Apps icon at the left end of the Favourite apps row. You can also add more apps as favourite from the Apps page.

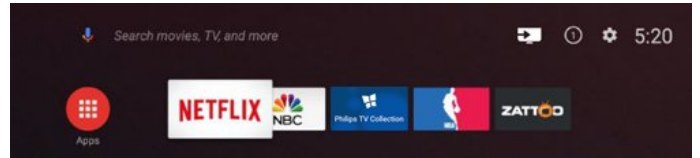

### Philips TV Collection

All your premium apps are available within the Philips TV Collection app. Launch it using the banner on the Favourite apps row. The Philips TV Collection app will also contain recommendations for new Apps and more.

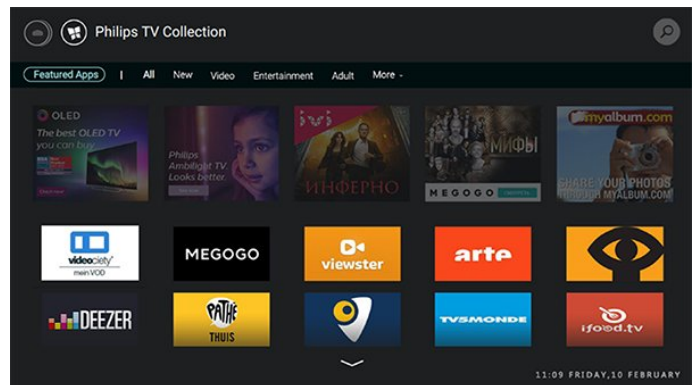

# Setting Up

## 2.1

### Read Safety

Read the safety instructions first before you use the TV.

For more information, in **Help**, select **Keywords** and look up **Safety Instructions**.

## 2.2

### TV Stand and Wall Mounting

#### TV Stand

You can find the instructions for mounting the TV stand in the Quick Start Guide that came with the TV. In case you lost this guide, you can download it from [www.philips.com](http://www.philips.com).

Use the model number of the TV to look for the **Quick Start Guide** to download.

#### Wall Mounting

##### Caution

Wall mounting the TV requires special skills and should only be performed by qualified personnel. The TV wall mounting should meet safety standards according to the TV's weight. Also read the safety precautions before positioning the TV. TP Vision Europe B.V. bears no responsibility for improper mounting or any mounting that results in accident or injury.

Your TV is prepared for a VESA-compliant wall mount bracket (sold separately).

Use the following VESA code when purchasing the wall mount . . .

- 55PUS8601  
VESA MIS-F 200x200, M6
- 65PUS8601  
VESA MIS-F 200x200, M6

##### Preparation

First remove the 4 plastic screw caps out of the threaded bushes on the back of the TV.

Make sure that the metal screws, to mount the TV to the VESA-compliant bracket, go about 10mm deep inside the threaded bushes of the TV.

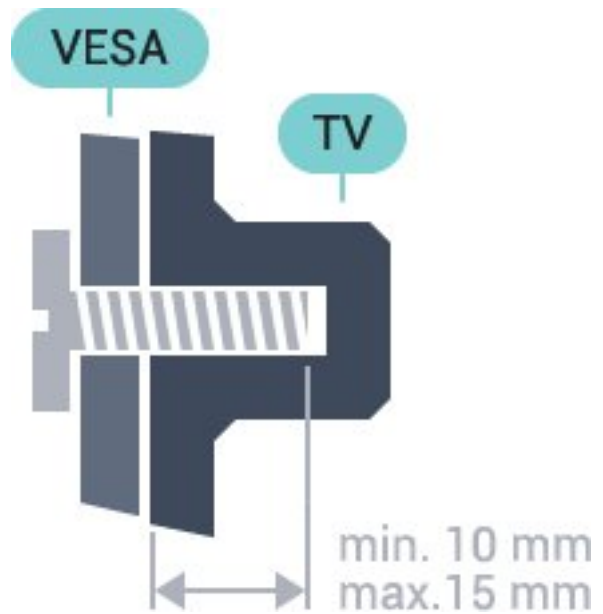

## 2.3

### Tips on Placement

- Position the TV where light does not shine directly on the screen.
- Position the TV up to 15 cm away from the wall.
- The ideal distance to watch TV is 3 times its diagonal screen size. When seated, your eyes should be level with the centre of the screen.

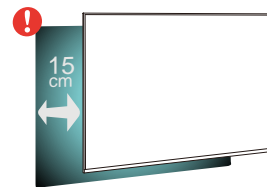

## 2.4

### Power Cable

- Insert the power cable into the **POWER** connector on the back of the TV.
- Make sure the power cable is securely inserted in the connector.
- Make sure that the power plug, in the wall socket, is accessible at all times.
- When you unplug the power cable, always pull the plug, never pull the cable.

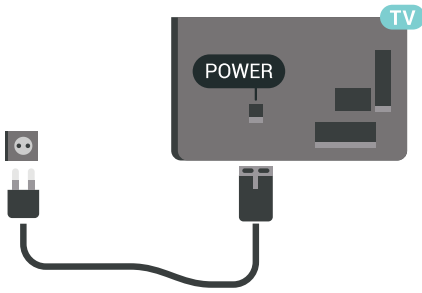

Although this TV has a very low standby power consumption, unplug the power cable to save energy if you do not use the TV for a long period of time.

2.5

## Antenna Cable

Insert the antenna plug firmly into the **Antenna** socket at the back of the TV.

You can connect your own antenna or an antenna signal from an antenna distribution system. Use an IEC Coax 75 Ohm RF antenna connector.

Use this antenna connection for DVB-T and DVB-C input signals.

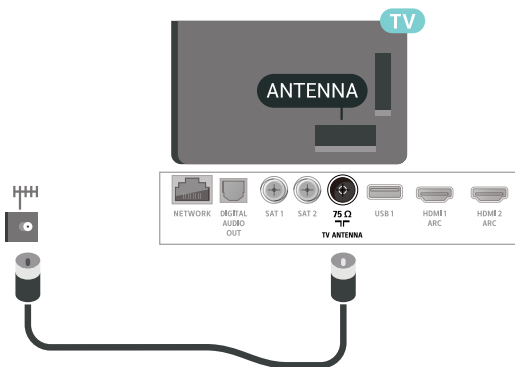

2.6

## Satellite Dish

### Expert Help

Consider asking for expert help when you are setting up a satellite dish system. An existing but unknown setup or local conditions of the satellite reception may complicate the setup of your satellite system. Improper installation may damage the TV electrically.

### Warning

When you have a Universal LNB on your satellite dish, do not use coaxial cable splitters unless you are using a Unicable setup.

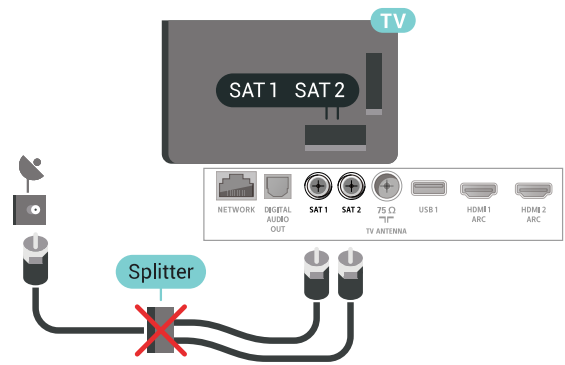

## One Tuner

To watch a satellite channel and to record another channel at the same time, you must connect 2 identical cables from your satellite dish to the TV. If you only have 1 cable available, the channel you are recording is the only channel you can watch.

Connect the cable from the satellite dish directly to the **SAT 1** connection. Use a coaxial cable fit for connecting a satellite antenna dish. Make sure your satellite dish is perfectly aligned before you start the installation.

During the satellite installation, select **One Tuner**.

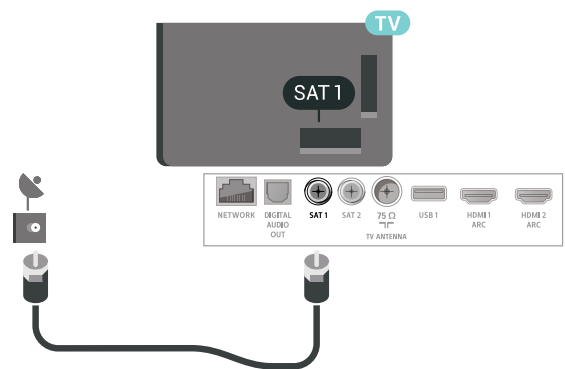

## Two Tuners

To watch a satellite channel and to record another channel at the same time, you must connect 2 identical cables from your satellite dish to the TV.

Connect the first cable from the satellite dish directly to the **SAT 1** connection and connect the second cable to **SAT 2**. Use a coaxial cable fit for connecting a satellite antenna dish. Make sure your satellite dish is perfectly aligned before you start the installation.

During the satellite installation, select **Two Tuners**.

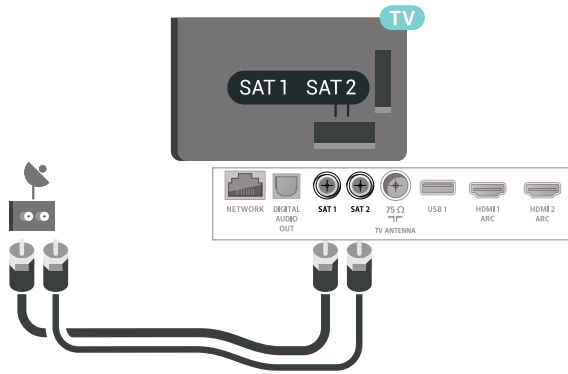

will pull the speaker against the screen and hold it in place. You can slide the speaker up or down slightly to level the top with the TV screen. The speaker grill should be directing to the front.

- 2 - Connect the short cable to the connector marked as , on each bottom corner of the TV screen.
- 3 - Mount the other speaker in the same way.

To disconnect, simply unplug the connectors.

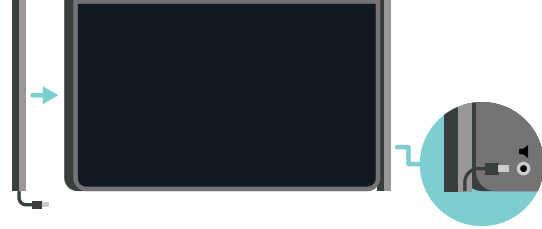

---

## Unicable or MDU

If you use a Unicable system, connect the cable to the **SAT 1** connection. Use a coaxial cable fit for connecting a satellite antenna dish and only use Unicable compliant cable splitters. Make sure your satellite dish is perfectly aligned before you start the installation.

During the satellite installation, select **Two Tuners** and later **Unicable**.

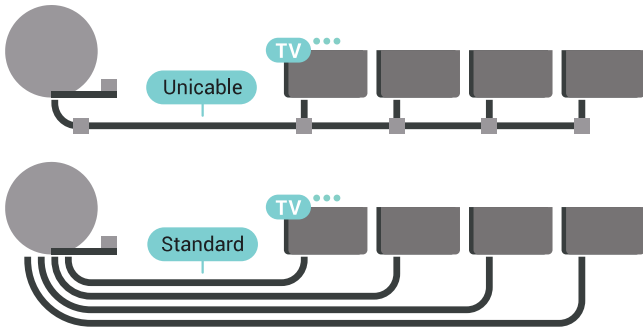

---

## Speaker Stands PTA860

With the **Philips PTA860 Wireless Detachable Speaker Stands\*** you can position your side speakers further away from your TV screen. The sound will be more spacious and will better fit the large screen viewing experience.

\* The PTA860 is sold separately.

---

2.7

## Side Speakers

---

### Connect the Side Speakers

Your TV comes with 2 detachable side speakers. These 2 speakers are separately packed in the TV box.

Mount and connect the supplied side speakers to your TV. The TV sound is incomplete without these speakers.

To mount the side speakers ...

- 1 - Hold the slim speaker with the short connector cable at the bottom and bring it close to the side of the TV screen. The built in magnets in the speaker

# Remote Control

## Key Overview

### Top

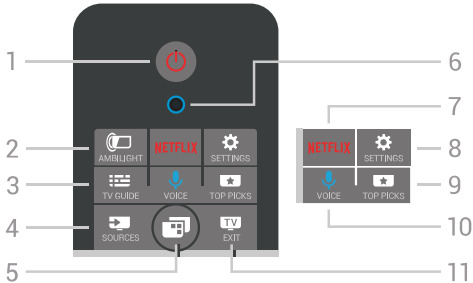

- 1 - Standby / On  
To switch the TV on or back to Standby.
- 2 - AMBILIGHT  
To switch Ambilight on or off and to switch Ambilight on from Standby.
- 3 - TV GUIDE  
To open or close the TV Guide.
- 4 - SOURCES  
To open or close the Sources menu.
- 5 - TV Menu  
To open the TV Menu with typical TV functions.
- 6 - VOICE microphone
- 7 - **NETFLIX**  
To open the Netflix App (if available) directly. With the TV switched on or from standby.
- 8 - SETTINGS  
To open the Frequent Settings menu.
- 9 - TOP PICKS  
To open the menu with recommended programmes, Video on Demand (Rental Videos) or Online TV (Catch Up TV). If available.
- 10 - VOICE  
To start speaking your voice search.
- 11 - EXIT  
To switch back to watch TV. To stop an interactive TV application (like HbbTV).

### Middle



- 1 - INFO  
To open or close programme info.
- 2 - Touch pad / Navigation keys  
To navigate up, down, left or right. To swipe through a list.
- 3 - BACK  
To switch back to the previous channel you selected. To close a menu without changing a setting. To go back to the previous App/Internet page.
- 4 - Colour keys  
Direct selection of options. Blue key , opens Help.
- 5 - Volume  
To adjust the volume level.
- 6 - Mute  
To mute the sound or to restore it.
- 7 - OPTIONS  
To open or close the Options menu.
- 8 - OK key  
To confirm a selection or setting. To open the channel list while watching TV.
- 9 - HOME  
To open or close the Home menu.
- 10 - Channel  
To switch to the next or previous channel in the channel list. To open the next or previous page in Text (Teletext). To start the next or previous chapter on a disc.
- 11 - Multi View  
To open a small screen in the big screen.

### Bottom





#### 1 – Number keys

To select a channel directly.

#### 2 – SUBTITLE

To switch subtitles on, off or to show automatically.

#### 3 – Playback and Record

- Play ►, to playback.
- Pause II, to pause playback
- Stop ■, to stop playback
- Rewind ◀◀, to rewind
- Fast forward ▶▶, to go fast forward
- Record ●, to start recording

#### 4 – TEXT

To switch on Text/Teletext.

### 3.2

## Pairing the Remote Control

This remote control uses Bluetooth to send its commands to the TV. Contrary to remote controls using infrared signals, you don't have to point the remote control at the TV. For the remote control to communicate with the TV, both TV and remote control should be paired (linked) with each other. Once paired, you cannot use the remote control to control another TV.



#### Pairing

When you started the initial TV installation, the TV invited you to press the OK key, and by doing so, the pairing was done. If the TV does not react on any remote control key press, pairing was unsuccessful.

#### Pair again

If the pairing with the remote control was lost, you can pair the TV with the remote control again.

To start pairing...

- 1 – On the back of the TV, standing in front of the TV at the right, press the joystick power key  in for 3 seconds. A message will show that the TV is ready to pair.
- 2 – Press the colour keys  (red) and  (blue) simultaneously for 1 second. A message appears when the pairing is successful.

When you switch off the TV, the pairing is stored.

This TV can be paired with one remote control only.



To unpair the remote control from this TV, you must pair it with another TV.

### 3.3





## Voice Search

You can search for videos, music or anything else on the Internet by simply using your voice. You can speak into the microphone on the remote control. Alternatively, you can use the remote control keyboard to enter text.

To use Voice...

- 1 – Press  VOICE. The blue light on the remote control lights up and the search field opens. As long as the  icon is red on screen, the microphone is active.
- 2 – Speak out clearly what you are looking for. You can speak for 10 seconds before the microphone switches off. It might take some time for the results to appear.
- 3 – In the list of search results, you can select the item you want.
- 4 – Press  BACK to close the search results if necessary.

To use the remote control keyboard to search...





- 1 – Press  VOICE to open the search field.
- 2 – Press  (right) to highlight the text field.
- 3 – Turn the remote control keyboard facing upwards and type what you are looking for.
- 4 – Press  BACK to hide the onscreen keyboard.
- 5 – In the list of search results, you can select the item you want.
- 6 – Press  BACK to close the search results if necessary.

See also [www.support.google.com/androidtv](http://www.support.google.com/androidtv)

#### Voice Settings

You can set the language you like to use with Voice.

To set the language for Voice Search...

- 1 – Press , select All Settings and press OK.
- 2 – Select Android Settings and press OK.
- 3 – Select Preferences >  Speech and press OK.
- 4 – Select the language you want to use and press OK.
- 5 – Press  BACK to go back one step or press  EXIT to close the menu.

## Touch Pad

The diamond shaped area of the navigation keys on the remote control – the keys for up, down, left and right – is also a small touch pad. You can use this touch pad to swipe through long lists or to go through a list step by step.

How to use the touch pad...

- 1 - Open any kind of TV menu with a list, e.g. the Home menu or Channel list.
- 2 - Use your thumb to swipe across the touch pad and towards the direction the list must scroll. Up or down, or left to right. If you swipe the touch pad, the highlight will move 1 step. If you swipe and then hold your thumb on the touch pad (no need to press), the highlight will scroll through the list until you lift your thumb from the touch pad.

Take some time to learn this swipe or swipe and hold gesture. It's really helpful to go through long lists.

You cannot switch off the touch pad.

## Keyboard

### Overview

#### Qwerty and Azerty

Overview of a Qwerty/Azerty keyboard.\*

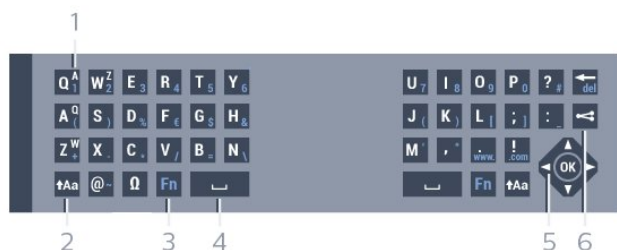

- 1 - Azerty character  
Character position if the keyboard layout is set to Azerty.
- 2 - ↑Aa Shift  
To type uppercase characters.
- 3 - Fn key  
To type a number or punctuation character.
- 4 - ␣ Spacebar
- 5 - Navigation and OK
- 6 - ↻ Share this  
To share online what you are watching at the moment.

\* Your remote control has a Qwerty / Azerty or a Qwerty / Cyrillic keyboard, depending on your region.

### Qwerty and Cyrillic

Overview of a Qwerty/Cyrillic keyboard.\*

- 1 - Cyrillic characters  
Characters available when the keyboard is switched to Cyrillic.
- 2 - 🇷🇺 Cyrillic keyboard switch  
To switch the keyboard to the Cyrillic characters or back to Qwerty.
- 3 - ↑Aa Shift  
To type uppercase characters.
- 4 - Fn key  
To type a number or punctuation character
- 5 - ␣ Spacebar
- 6 - ↻ Share this  
To share online what you are watching at the moment.
- 7 - Navigation and OK

\* Your remote control has a Qwerty/Azerty or a Qwerty/Cyrillic keyboard, depending on your region.

## Writing Text

With the keyboard on the back of the remote control, you can write text in any text field on screen.

To write text...

- 1 - Select a text field if it is not yet selected.
- 2 - Turn the remote control keyboard facing upwards to activate the keyboard keys. Hold the remote control with two hands and type with both thumbs.
- 3 - To hide the on screen keyboard, press ← BACK. Press OK to confirm the text.

#### On-screen Keyboard

If you use the on-screen keyboard to enter text, you can configure the keyboard layout to a layout you are used to.

To open these settings...

- Press 🏠 HOME, select All Settings and press OK.
  - 5 - Select Android Settings and press OK.
  - 6 - Select Preferences > 🇷🇺 Keyboard and press OK.
  - 7 - Select Configure > Language and press OK. You can set your language keyboard layout here.
  - 8 - Press ← BACK to close the menu to go back one step.
- Best distance to operate remote control with the TV is less than 5 m.
  - When using remote control keyboard, best to hold the remote control with the angle less than 50 degree.
  - Do not block the IR ray of the remote control.

---

## Qwerty, Azerty and Cyrillic keyboard

The standard layout of the Remote Control Keyboard is Qwerty.

### Azerty keyboard

Depending on your region, the Remote Control Keyboard can be set to Azerty. The Azerty characters are shown at the top right of the relevant keys.



To set the keyboard layout to Azerty...

- 1 - Press , select **All Settings** and press **OK**.
- 2 - Select **Region and Language** and press **➤** (right) to enter the menu.
- 3 - Select **Remote Control Keyboard** and press **OK**.
- 4 - Select **AZERTY** or **QWERTY** and press **OK**.
- 5 - Press **◀** (left) repeatedly if necessary, to close the menu.

### Cyrillic keyboard

Depending on your region, the Remote Control Keyboard can be switched to Cyrillic characters. The Cyrillic characters are shown at the top right of the keyboard keys.

To write Cyrillic characters...

- 1 - Press  on the remote control.
- 2 - Press  again to switch back to Qwerty.

---

3.6

## Remote Control Sensor

The remote control of the TV uses Bluetooth to send its commands to the TV. With Bluetooth, you do not need to point the remote control at the TV.

However, the TV can also receive commands from a remote control that uses IR (infrared) to send commands. If you use such a remote control, always make sure you point the remote control at the infrared sensor on the front of the TV.

---

3.7

## Batteries

The TV will notify you when the battery power of the remote control is low.

To replace the batteries, open the battery compartment on the keyboard side of the remote control.

- 1 - Use a small coin or other small, blunt object and press the rectangular shaped release button to open the battery lid.
- 2 - Slide the battery in the direction of the metal spring and pull the opposite end of the battery out.

- 3 - Replace the old batteries with 2 type **AA-LR6-1.5V** alkaline batteries. Make sure the + and the - ends of the batteries line up correctly.
- 4 - Reposition the battery door and push it down until it clicks.

Remove the batteries if you are not using the remote control for a long time.

Safely dispose of your old batteries according to the end of use directions.

For more information, in **Help**, select **Keywords** and look up **End of use**.

---

3.8

## Cleaning

Your remote control is treated with a scratch-resistant coating.



To clean the remote control, use a soft damp cloth. Never use substances such as alcohol, chemicals or household cleaners on the remote control.

# Switching On and Off

## On or Standby

Make sure the TV is connected to the mains AC power. Connect the supplied power cord to the AC in connector at the back of the TV. The indicator light at the bottom of the TV lights up.

### Switch on

Press  on the remote control to switch the TV on. Alternatively, press  HOME. You can also press the small joystick key on the back of the TV to switch the TV on in case you can't find the remote control or its batteries are empty.

### Switch to standby

To switch the TV to standby, press  on the remote control. You can also press the small joystick key on the back of the TV.



In standby mode, the TV is still connected to the mains power but consumes very little energy.

To switch off the TV completely, disconnect the power plug.





When disconnecting the power plug, always pull the power plug, never the cord. Ensure that you have full access to the power plug, power cord and outlet socket at all times.

## Keys on TV

If you lost the remote control or its batteries are empty, you can still do some basic TV operations.

To open the basic menu...

1 - With the TV switched on, press the joystick key on the back of the TV to bring up the basic menu.

2 - Press left or right to select  Volume,  Channel or  Sources. Select  Demo, to start a demo movie.

3 - Press up or down to adjust the volume or tune to the next or previous channel. Press up or down to go through the list of sources, including the tuner selection. Press the joystick key to start the demo

movie.

4 - The menu will disappear automatically.

To switch the TV on standby, select  and press the joystick key.



---

# Channels

---

## Satellite Installation

---

### About Installing Satellites

Up to 4 Satellites

You can install up to 4 satellites (4 LNBS) on this TV. Select the exact number of satellites you wish to install at the start of the installation. This will speed up the installation.

#### Unicable

You can use a Unicable system to connect the antenna dish to the TV. You can select Unicable for 1 or for 2 satellites at the start of the installation.

---

### Start the Installation

Make sure your satellite dish is connected correctly and is perfectly aligned before you start the installation.

To start the satellite installation...

- 1 - Press , select **All Settings** and press **OK**.
  - 2 - Select **Channels > Satellite Installation**. Enter your PIN code if necessary.
  - 3 - Select **Search for Satellite**.
  - 4 - Select **Search**. TV will search for satellites.
  - 5 - Select **Configure**. The TV shows the current satellite installation setup.
- If you want to change this setup, select **Settings**.  
If you don't want to change the setup, select **Search**.  
Go to step 7.

6 - In **Installation System**, select the number of satellites you want to install or select one of the Unicable systems. When you select Unicable, you can choose the User Band Numbers and enter the User Band Frequencies for each tuner. You can find user band in unicable router. In some countries, you can adjust some expert settings for each LNB in **More Settings**.

7 - The TV will search for the satellites available on the alignment of your antenna dish. This may take a few minutes. If a satellite is found, its name and reception strength are shown on screen.

8 - When the TV found the satellites you need, select **Install**.

9 - If a satellite offers **Channel Packages**, the TV will show the available packages for that satellite. Select the package you need.

10 - To store the satellite setup and installed channels and radio stations, select **Done**.

---

## Satellite Installation Settings

The satellite installation settings are preset according your country. These settings determine how the TV searches and installs satellites and its channels. You can always change these settings.

To change the satellite installation settings...

- 1 - Start the satellite installation.
- 2 - On the screen where you can start searching for satellites, select **Settings** and press **OK**.
- 3 - Select the number of satellites you want to install or select one of the Unicable systems. When you select Unicable, you can choose the User Band Numbers and enter the User Band Frequencies for each tuner.
- 4 - When you're done, select **Next** and press **OK**.
- 5 - On the Settings menu, press **OK** to return to the screen to start searching for satellites.

#### Homing Transponder and LNB

In some countries, you can adjust the expert settings for homing transponder and each LNB. Only use or change these settings when a normal installation fails. If you have non-standard satellite equipment, you can use these settings to overrule the standard settings. Some providers might give you some transponder or LNB values which you can enter here.

---

## Satellite CAMs

If you use a CAM – a Conditional Access Module with a smart card – to watch satellite channels, we recommend to do the satellite installation with the CAM inserted in the TV.

Most CAMs are used to descramble channels.

Newest generation CAMs (CI+ 1.3 with Operator Profile), can install all the satellite channels by themselves on your TV. The CAM will invite you to install its satellite(s) and channels. These CAMs not only install and descramble the channels but also handle regular channel updates.

---

## Channel Packages

Satellite operators can offer channel packages that bundle free channels (free-to-air) and offer a sorting that suits a country. Some satellites offer subscription packages – a collection of channels you pay for.

---

## Unicable Setup

### The Unicable System

You can use a Single Cable system, MDU or Unicable system to connect the antenna dish to the TV. A Single Cable system uses one cable to connect the satellite dish to all satellite tuners in its system. A Single Cable system is typically used in apartment buildings. If you use a Unicable system, the TV will ask you to assign a user band number and corresponding frequency during the installation. You can install 1 or 2 satellites with Unicable on this TV.

If you notice some missing channels after a Unicable installation, another installation might have been done at the same moment on the Unicable system. Do the installation again to install the missing channels.

### User Band Number

In a Unicable system, each connected satellite tuner must be numbered (e.g. 0, 1, 2 or 3 etc.).

You can find the available user bands and their number on the Unicable switchbox. User band is sometimes shortened as UB. There are Unicable switchboxes that offer 4 or 8 user bands. If you select Unicable in the settings, the TV will ask you to assign the unique user band number for each built-in satellite tuners. A satellite tuner cannot have the same user band number as another satellite tuner in the Unicable system.

### User Band Frequency

Next to the unique user band number, the built-in satellite receiver needs the frequency of the selected user band number. These frequencies are mostly shown next to the user band number on a Unicable switchbox.

---

## Manual Channel Update

You can always start an channel update yourself.

To start a channel update manually...

- 1 - Press , select **All Settings** and press **OK**.
- 2 - Select **Channels > Satellite Installation**.
- 3 - Select **Search for Channels**.
- 4 - Select **Update Channels**. The TV will start updating. The update may take a few minutes.
- 5 - Follow the instructions on screen. The update may take a few minutes.
- 6 - Select **Finish** and press **OK**.

---

## Add a Satellite

You can add an additional satellite to your current satellite installation. The installed satellites and their channels remain untouched. Some satellite operators do not allow adding a satellite.

The additional satellite should be seen as an extra, it is not your main satellite subscription or not the main satellite of which you use its channel package. Typically, you would add a 4th satellite when you have 3 satellites already installed. If you have 4 satellites installed, you might consider removing one first to be able to add a new satellite.

### Setup

If you currently have only 1 or 2 satellites installed, the current installation settings might not allow adding an extra satellite. If you need to change the installation settings, you must redo the complete satellite installation. You cannot use **Add satellite** if a change of settings is needed.

To add a satellite...

- 1 - Press , select **All Settings** and press **OK**.
- 2 - Select **Channels > Satellite Installation**.
- 3 - Select **Search for satellite**.
- 4 - Select **Add Satellite**. The current satellites are shown.
- 5 - Select **Search**. The TV will search for new satellites.
- 6 - If the TV has found one or more satellites, select **Install**. The TV installs the channels of the found satellites.
- 7 - Select **Finish** and press **OK** to store the channels and radio stations.

---

## Remove a Satellite

You can remove one or more satellites from your current satellite installation. You remove the satellite and its channels. Some satellite operators do not allow removing a satellite.

To remove satellites...

- 1 - Press , select **All Settings** and press **OK**.
- 2 - Select **Channels > Satellite Installation**.
- 3 - Select **Search for satellite**.
- 4 - Select **Remove Satellite**. The current satellites are shown.
- 5 - Select a satellite and press **OK** to mark or unmark them to remove.
- 6 - Press **<** (left) repeatedly if necessary, to close the menu.

---

## Manual Installation

Manual Installation is intended for expert users.

You can use Manual Installation to quickly add new channels from a satellite transponder. You need to know the frequency and polarization of the transponder. The TV will install all channels of that transponder. If the transponder was installed before, all its channels – the former and the new ones – are moved to the end of the channel list All.

You cannot use Manual installation if you need to change the number of satellites. If this is needed, you have to do a complete installation with Install Satellites.

To install a transponder...

- 1 - Press **⚙️**, select **All Settings** and press **OK**.
- 2 - Select **Channels > Satellite Installation**.
- 3 - Select **Manual Installation** and press **➤** (right) to enter the menu.
- 4 - If you have more than 1 satellite installed, select **LNB** for which you want to add channels.
- 5 - Set the **Polarisation** you need. If you set the **Symbol Rate Mode** to **Manual**, you can enter the symbol rate in **Symbol Rate** manually.
- 6 - Press the arrows **▲** (up) or **▼** (down) to adjust the frequency, and select **Done**.
- 7 - Select **Search** and press **OK**. The signal strength is shown on screen.
- 8 - If you want to store the channels of a new transponder, select **Store** and press **OK**.
- 9 - Press **◀** (left) repeatedly if necessary, to close the menu.

---

## Homing Transponder and LNB

In some countries, you can adjust the expert settings for homing transponder and each LNB. Only use or change these settings when a normal installation fails. If you have non-standard satellite equipment, you can use these settings to overrule the standard settings. Some providers might give you some transponder or LNB values which you can enter here.

### LNB Power

By default, LNB Power is set to On.

### 22 kHz Tone

By default, the Tone is set to Auto.

### Low LO Frequency / High LO Frequency

The local oscillator frequencies are set to standard values. Adjust the values only in case of exceptional equipment that needs different values.

---

## Problems

The TV cannot find the satellites I want or the TV installs the same satellite twice

- Make sure that the correct number of satellites is set in Settings at the start of the installation. You can set the TV to search for One, Two or 3/4 satellites.

A dual head LNB cannot find a second satellite

- If the TV finds one satellite but cannot find a second one, turn the dish a few degrees. Align the dish to get the strongest signal on the first satellite. Check the signal strength indicator of the first satellite on screen. With the first satellite set at the strongest signal, select Search again to find the second satellite.
- Make sure the settings are set to Two Satellites.

Changing the installation settings did not solve my problem

- All settings, satellites and channels are only stored at the end of the installation when you finish.

All satellite channels are gone

- If you use a Unicable system, make sure you assigned two unique user band numbers for both built-in tuners in the Unicable settings. It might be that another satellite receiver in your Unicable system is using the same user band number.

Some satellite channels seem to have disappeared from the channel list

- If some channels seem to be gone or displaced, the broadcaster might have changed the transponder location of these channels. To restore the channel positions in the channel list, you can try an update of the channel package.

I cannot remove a satellite

- Subscription packages do not allow removing a satellite. To remove the satellite, you have to do a complete installation again and select another package.

Sometimes the reception is poor

- Check if the satellite dish is solidly mounted. Strong winds can move the dish.
- Snow and rain can degrade the reception.

---

5.2

## Antenna/Cable Installation

---

## Update or reinstall

---

### Update digital channels

You can always start an channel update yourself.

To start a channel update manually...

- 1 - Press **⚙️**, select **All Settings** and press **OK**.
- 2 - Select **Channels > Antenna/Cable Installation**.
- 3 - Enter your PIN code if necessary.
- 4 - Select **Search for Channels**.
- 5 - Select **Start**.
- 6 - Select **Update digital channels**.
- 7 - Press **OK** to update the digital channels. This can take a few minutes.
- 8 - Press **← BACK** to close the menu.

---

### Quick reinstall

Select Quick reinstall to install all channels again with default settings.

To start Quick reinstall...

- 1 - Press **⚙️**, select **All Settings** and press **OK**.
- 2 - Select **Channels > Antenna/Cable Installation**.
- 3 - Enter your PIN code if necessary.
- 4 - Select **Search for Channels**.
- 5 - Select **Start**.
- 6 - Select **Quick reinstall**.
- 7 - Press **OK** to update the digital channels. This can take a few minutes.
- 8 - Press **← BACK** to close the menu.

---

### Advanced reinstall

You can reinstall all channels and leave all other TV settings untouched.

If a PIN code is set, you will need to enter this code before you can reinstall channels.

To reinstall channels...

- 1 - Press **⚙️**, select **All Settings** and press **OK**.
- 2 - Select **Channels > Antenna/Cable Installation**.
- 3 - Enter your PIN code if necessary.
- 4 - Select **Search for Channels**.
- 5 - Select **Start** and press **OK**.
- 6 - Select **Advanced reinstall** and press **OK**.
- 7 - Select the country where you are now and press **OK**.
- 8 - Select the type of installation you want, **Antenna (DVB-T)** or **Cable (DVB-C)** and press **OK**.
- 9 - Select the type of channels you want, **Digital and Analogue Channels** or **Only Digital Channels** and press **OK**.
- 10 - Press **OK** to update the digital channels. This can take a few minutes.
- 11 - Press **← BACK** to close the menu.

---

## Automatic Channel Update

If you receive digital channels, you can set the TV to automatically update these channels.

Once a day, at 6 AM, the TV updates the channels and stores new channels. New channels are stored in the Channels List and are marked with a **★**. Channels without a signal are removed. The TV must be in standby to automatically update channels. You can switch off Automatic Channel Update.

To switch off the automatic update...

- 1 - Press **⚙️**, select **All Settings** and press **OK**.
- 2 - Select **Channels > Antenna/Cable Installation**.
- 3 - Enter your PIN code if necessary.
- 4 - Select **Automatic Channel Update**.
- 5 - Select **Off**.
- 6 - Press **← (left)** to go back one step or press **← BACK** to close the menu.

When new channels are found or if channels are updated or removed, a message is shown at TV start up. To avoid this message to appear after every channel update, you can switch it off.

To switch off the message...

- 1 - Press **⚙️**, select **All Settings** and press **OK**.
- 2 - Select **Channels > Antenna/Cable Installation**.
- 3 - Enter your PIN code if necessary.
- 4 - Select **Channel Update Message**.
- 5 - Select **Off**.
- 6 - Press **← (left)** to go back one step or press **← BACK** to close the menu.

In certain countries, the Automatic channel update is done while watching TV or on any moment when the TV is in standby.

---

## DVB-T or DVB-C

---

### DVB Settings

---

#### Network Frequency Mode

If you intend to use the fast **Quick Scan** method in **Frequency Scan** to search for channels, select **Automatic**. The TV will use 1 of the predefined network frequencies (or HC - homing channel) as used by most cable operator in your country.

If you received a specific network frequency value to search for channels, select **Manual**.

---

#### Network Frequency

With the **Network Frequency Mode** set to **Manual**, you can enter the network frequency value received from your cable operator here. To enter the value, use the number keys.



---

## Frequency Scan

Select the method of searching for channels. You can select the faster **Quick Scan** method and use the predefined settings used by most cable operator in your country.

If this results in having no channels installed or if some channels are missing, you can select the extended **Full Scan** method. This method will take more time to search for and install channels.

---

## Frequency Step Size

The TV searches for channels in steps of **8MHz**.

If this results in having no channels installed or if some channels are missing, you can search in smaller steps of **1MHz**. Using the 1MHz steps will take more time to search for and install channels.

---

## Digital Channels

If you know your cable operator is not offering digital channels, you can skip searching for digital channels.

---

## Analogue Channels

If you know your cable operator is not offering analogue channels, you can skip searching for analogue channels.

---

## Free / Scrambled

If you have a subscription and a CAM - Conditional Access Module for pay TV services, select **Free + Scrambled**. If you did not subscribe to pay TV channels or services, you can select **Free Channels Only**.

---

## Reception Quality

You can check the quality and signal strength of a digital channel. If you have your own antenna, you can reposition the antenna to try and improve the reception.

To check the reception quality of a digital channel...

- 1 - Tune to the channel.
- 2 - Press **⚙**, select **All Settings** and press **OK**.
- 3 - Select **Channels > Antenna/Cable Installation**. Enter your PIN code if necessary.
- 4 - Select **Digital: Reception Test**.
- 5 - Select **Search**. The digital frequency is shown for this channel.
- 6 - Select **Search** again and press **OK** to check the

signal quality of this frequency. The test result is shown on screen. You can reposition the antenna or check the connections to possibly improve the reception.

7 - You can also change the frequency yourself. Select the frequency number one by one and use the **▲** (up) or **▼** (down) keys to change the value. Select **Search** and press **OK** to test the reception again.

8 - Press **◀** (left) repeatedly if necessary, to close the menu.

---

## Manual Installation

Analogue TV channels can be manually installed, channel by channel.

To install analogue channels manually...

- 1 - Press **⚙**, select **All Settings** and press **OK**.
- 2 - Select **Channels > Antenna/Cable Installation**. Enter your PIN code if necessary.
- 3 - Select **Analogue: Manual Installation**.

- **System**

To set up the TV system, select **System**. Select your country or the part of the world where you are now and press **OK**.

- **Search Channel**

To find a channel, select **Search Channel**. You can enter a frequency yourself to find a channel or let the TV search for a channel. Press **▶** (right) to select **Search** to search for a channel automatically. The found channel is shown on screen and if the reception is poor, press **Search** again. If you want to store the channel, select **Done** and press **OK**.

- **Store**

You can store the channel on the current channel number or as a new channel number. Select **Store Current Channel** or **Store as New Channel**. The new channel number is shown briefly.

You can redo these steps until you have found all available analogue TV channels.

---

## 5.3

# Channel List Copy

---

## Copy a Channel List

To copy a channel list...

- 1 - Switch on the TV. This TV should have channels installed.
- 2 - Plug in a USB flash drive.
- 3 - Press **⚙**, select **All Settings** and press **OK**.
- 4 - Select **Channels > Channel List Copy**.
- 5 - Select **Copy to USB**. You might be asked to enter

the Child Lock PIN code to copy the channel list.  
6 - When copying is done, unplug the USB flash drive.  
7 - Press **◀** (left) repeatedly if necessary, to close the menu.

Now you can upload the copied channel list onto another Philips TV.

---

## Channel List version

Check the current version of the channel list...

1 - Press **⚙**, select **All Settings** and press **OK**.  
2 - Select **Channels** and press **▶** (right) to enter the menu.  
3 - Select **Channel List Copy** and select **Current Version**, then press **OK**.  
4 - Press **◀** (left) repeatedly if necessary, to close the menu.

---

## Upload a Channel List

### To not Installed TVs

Depending on whether your TV is already installed or not, you must use a different method to upload a channel list.

### To a TV that is not yet installed

1 - Plug in the power plug to start the installation and select language and country. You can skip the channel search. Finish the installation.  
2 - Plug in the USB flash drive that holds the channel list of the other TV.  
3 - To start the channel list upload, press **⚙**, select **All Settings** and press **OK**.  
4 - Select **Channels > Channel List Copy > Copy to TV**. Enter your PIN code if necessary.  
5 - The TV notifies you if the channel list is copied to the TV successfully. Unplug the USB flash drive.

---

### To Installed TVs

Depending on whether your TV is already installed or not, you must use a different method to upload a channel list.

### To an already installed TV

1 - Verify the country setting of the TV. (To verify this setting, see chapter Reinstall All Channels. Start this procedure until you reach the country setting. Press **◀ BACK** to cancel the installation.)  
If the country is correct continue with step 2.  
If the country is not correct, you need to start a reinstallation. See chapter Reinstall All Channels and start the installation. Select the correct country and skip the channels search. Finish the installation. When

done, continue with step 2.

2 - Plug in the USB flash drive that holds the channel list of the other TV.

3 - To start the channel list upload, press **⚙**, select **All Settings** and press **OK**.

4 - Select **Channels > Channel List Copy > Copy to TV**. Enter your PIN code if necessary.

5 - The TV notifies you if the channel list is copied to the TV successfully. Unplug the USB flash drive.

---

5.4

## About Channels

---

### Channel Lists

#### About Channel Lists

After a channel installation, all channels appear on the channel list. Channels are shown with their name and logo if this information is available.

For each type of tuner - Antenna/Cable (DVB-T/C) or Satellite (DVB-S) - there is a channel list with all installed channels. You can only filter this list to show TV or only Radio channels. Or when you have several satellites installed, you can filter the channels per satellite.

With a channel list selected, press the arrows **▲** (up) or **▼** (down) to select a channel, then press **OK** to watch the selected channel. You only tune to the channels in that list when using **≡ +** or **≡ -** keys.

#### Channel icons

After an Automatic Channel Update of the channel list, newly found channels are marked with a **★** (star).

If you lock a channel, it will be marked with a **🔒** (lock).

The 3 most popular channels being watched by others at this moment are marked with a **1**, **2** or **3**.

#### Radio stations

If digital broadcasting is available, digital radio stations are installed during installation. Switch to a radio channel just like you switch to a TV channel. A Cable (DVB-C) channel installation usually places radio stations from channel number 1001 onwards.

This TV can receive digital television standard DVB . TV may not work properly with some operators of digital television , non-compliance with requirements of the standard in full.

---

## Open a Channel List

Next to the list with all channels for each tuner, Antenna/Cable or Satellite tuner, you can select a filtered list or you can select one of the favourite lists you created.

To open the current channel list...

- 1 - Press **TV**, to switch to TV.
- 2 - Press **≡ LIST\*** or **OK** to open the current channel list.
- 3 - Press **← BACK** to close the channel list.

To select one of the channel lists...

- 1 - With a channel list open on screen.
- 2 - Select the list name at the top of the channel list and press **OK** to open the list menu.
- 3 - In the list menu, select one of the available channel lists and press **OK**.

### Tip

You can easily switch between the two tuners in the **Sources** menu.

Press **SOURCES** and select **Watch TV** to switch to the Antenna/Cable tuner. Select **Watch Satellite** to switch to the satellite tuner.

The TV will always open the last selected channel list for the selected tuner.

\* If **≡ LIST** key is available on your remote control

---

## Search for a Channel

You can search for a channel to find it in a long list of channels.

The TV can search for a channel within one of the 3 main channel lists - the Antenna, Cable or Satellite channel list.

To search for a channel...

- 1 - Press **TV**.
- 2 - Press **OK** to open the current channel list.
- 3 - Select **⋮** at the upper right corner and press **OK**.
- 4 - Select **Search Channel** and press **OK** to open a text field. You can use the remote control keyboard (if available) or the onscreen keyboard to enter text.
- 5 - Enter a number, a name or part of a name and select **Apply** and press **OK**. The TV will search for matching channel names in the list you selected.

Search results are listed as a channel list - see the list name at the top. The search results disappear once you select another channel list or close the list with search results.

---

## Watching Channels

### Tune to a Channel

To start watching TV channels, press **TV**. The TV tunes to the channel you last watched.

### Switch Channels

To switch channels, press **≡ +** or **≡ -**.

If you know the channel number, type in the number with the number keys. Press **OK** after you entered the number to switch immediately.

If the information is available from the Internet, the TV shows the current programme name and details followed by the next programme name and details.

### Previous channel

To switch back to the previously tuned channel, press **← BACK**.

You can also tune to channels from a **Channel List**.

---

## Lock a Channel

### Lock and Unlock a Channel

To prevent children from watching a channel, you can lock a channel. To watch a locked channel, you must enter the 4 digit **Child Lock PIN** code first. You cannot lock programmes from connected devices.

To lock a channel...

- 1 - Press **TV**.
- 2 - Press **OK** to open the channel list. If necessary change the channel list.
- 3 - Select **⋮** at the upper right corner and press **OK**.
- 4 - Select **Lock/UnLock** and press **OK**.
- 5 - Enter your 4 digit PIN code if the TV asks for it.
- 6 - Select the channel you want to lock and press **OK**. A locked channel is marked with a **🔒** (lock).
- 7 - Press **←** (left) to go back one step or press **← BACK** to close the menu.

To unlock a channel...

- 1 - Press **TV**.
- 2 - Press **OK** to open the channel list. If necessary change the channel list.
- 3 - Select **⋮** at the upper right corner and press **OK**.
- 4 - Select **Lock/UnLock** and press **OK**.
- 5 - Enter your 4 digit PIN code if the TV asks for it.
- 6 - Press **←** (left) to go back one step or press **← BACK** to close the menu.

If you lock or unlock channels in a channel list, you only have to enter the PIN code just once until you close the channel list.

---

## Parental Rating

To prevent children from watching a programme not suitable for their age, you can set an age rating.

Digital channels can have their programmes age rated. When the age rating of a programme is equal to or higher than the age you have set as age rating for your child, the programme will be locked. To watch a locked programme, you must enter the **Parental Rating** code first.

To set an age rating...

- 1 - Press , select **All Settings** and press **OK**.
- 2 - Select **Child Lock > Parental Rating**.
- 3 - Enter a 4-digit Child lock code. If you did not set a code yet, select **Set Code** in **Child Lock**. Enter a 4-digit Child lock code and confirm. Now you can set an age rating.
- 4 - Back in **Parental Rating**, select the age.
- 5 - Press **<** (left) repeatedly if necessary, to close the menu.

To switch off the parental age rating, select **None**. However, in some countries you must set an age rating.

For some broadcasters/operators, the TV only locks programmes with a higher rating. The parental age rating is set for all channels.

---

## Channel Options

### Open Options

While watching a channel, you can set some options.

Depending on the type of channel you are watching or depending on the TV settings you made, some options are available.

To open the options menu...

- 1 - While watching a channel, press **+ OPTIONS >  Preferences**.
- 2 - Press **+ OPTIONS** again to close.

---

### Rename Channel

While watching a channel, you can rename channel.

To rename a channel...



- 1 - While watching a channel, press **+ OPTIONS**.
- 2 - Select ** Preferences > Rename Channel**.
- 3 - Use the keyboard on the back of the remote control to delete the current name and enter a new name.

---

## Common Interface

If you installed a CAM in one of the Common Interface slots, you can view the CAM and operator information or do some CAM related settings.

To view the CAM information...

- 1 - Press  **SOURCES**.
- 2 - Select the channel type you are using the CAM for, **Watch TV** or **Watch Satellite**.
- 3 - Press **+ OPTIONS** and select ** Preferences > Common Interface**.
- 4 - Select the appropriate Common Interface slot and press **>** (right).
- 5 - Select the TV operator of the CAM and press **OK**. The following screens come from the TV operator.

---

### HbbTV on this Channel

If you want to avoid access to HbbTV pages on a specific channel, you can block the HbbTV pages for this channel only.

- 1 - Tune to the channel of which you want to block the HbbTV pages.
- 2 - Press **+ OPTIONS**, select **Preferences > HbbTV on this Channel** and press **>** (right).
- 3 - Select **Off** and press **OK**.
- 4 - Press **<** (left) to go back one step or press **<** **BACK** to close the menu.

To block HbbTV on TV completely...

- 1 - Press , select **All Settings** and press **OK**.
- 2 - Select **General Settings > Advanced > HbbTV**.
- 3 - Select **Off** and press **OK**.
- 4 - Press **<** (left) to go back one step or press **<** **BACK** to close the menu.

---

## Channel Info

You can view the technical characteristics of a particular channel, like digital or sound type, etc.

To view the technical information on a channel...

- 1 - Tune to the channel.
- 2 - Press **+ OPTIONS**, select ** Preferences** and press **OK**.
- 3 - Select **Channel Info** and press **OK**.
- 4 - To close this screen, press **OK**.

---

## Programme Info

### View programme details

To call up the details of the selected programme...

- 1 - Tune to the channel.
- 2 - Press **+ OPTIONS**, select ** Preferences** and

press **OK**.

3 - Select **Programme Info** and press **OK**, you can see programme information.

4 - Press **← BACK** to close.

---

## Mono / Stereo

You can switch the sound of an analogue channel to Mono or Stereo.

To switch to Mono or Stereo...

1 - Tune to an analogue channel.

2 - Press **+ OPTIONS**, and select **≡ Preferences > Mono/Stereo** and press **➤** (right).

3 - Select **Mono** or **Stereo** and press **OK**.

4 - Press **◀** (left) to go back one step or press **← BACK** to close the menu.

---

## Video Selection

Digital TV channels can offer multi video signals (multi-feed broadcast), different camera viewpoints or angles of the same event or different programmes on one TV channel. The TV shows a message if any such TV channels are available.

---

## Dual I-II

If an audio signal contains two audio languages but one language or both has no language indication, this option is available.

---

## Map Channel

If there is no programme information in the beginning, you can do map channel to get more programme information.

1 - Press **≡ TV GUIDE**, and use navigation keys to select **⋮** at the middle and press **OK**.

2 - Select **TV Guide > From the Internet** and press **OK**.

3 - Select one of channels in TV guide, then press **OK** to watch the selected channel.

4 - While watching a channel, press **+ OPTIONS**.

5 - Select **≡ Preferences > Map Channel**.

6 - Select one item in the list and press **OK**.

7 - Select **Map Channel**.

8 - Once completed, you will see the mapped channel information in the programme.

---

## Change Logo

If there is no programme information in the beginning, you can get more programme information using below steps.

1 - Press **≡ TV GUIDE**, and use navigation keys to select **⋮** at the middle and press **OK**.

2 - Select **TV Guide > From the Broadcaster** and press **OK**.

3 - Select one of channels in TV guide, then press **OK** to watch the selected channel.

4 - While watching a channel, press **+ OPTIONS**.

5 - Select **≡ Preferences > Change Logo**.

6 - Select one item in the list and press **OK**.

7 - Select **Change Logo**.

8 - Once completed, you will see the mapped channel information in the programme.

---

## Favourite Channels

---

### About Favourite Channels

In a favourite channel list, you can collect the channels you like.

You can create 8 lists of favourite channels for easy channel zapping. You can name each Favourites List individually. Only in a Favourites List you can reorder channels.

With a Favourites List selected, press the arrows **▲** (up) or **▼** (down) to select a channel, then press **OK** to watch the selected channel. You only tune to the channels in that list when using **≡ +** or **≡ -** keys.

---

### Create a Favourites List

To create a favourite channels list from channel list...

1 - Press **TV**, to switch to TV.

2 - Press **≡ LIST** (if available) or **OK** to open the current channel list.

3 - Select **⋮** at the upper right corner and press **OK**.

4 - Select **Create Favourites list** and press **OK**.

5 - In the list at the left, select a channel you want as a favourite and press **+ OPTIONS**. Channels come in the list at the right in the order you add them. To undo, select the channel in the list at the left and press **+ OPTIONS** again. You can also select a range of channels by pressing **▼** (down) to select the last channel of the range you want to add and then press **OK**.

6 - To finish adding channels, press **← BACK**.

7 - The TV will ask to rename the **Favourites List**. You can use the on-screen keyboard or press **← BACK** to hide the on-screen keyboard, then use the keyboard on the back of the remote control (if available) to enter new name.

If the channel list is long, alternatively, you can select any channel, then press **+ OPTIONS** to open option menu, then select **Create Favourites list** and press **OK**.

To create a new favourite channels list by copying existing favourite channel list...

- 1 - Press **TV**, to switch to TV.
- 2 - Press **≡ LIST** (if available) or **OK** to open the current channel list.
- 3 - Select **⋮** at the upper right corner and press **OK**.
- 4 - Select **Duplicate Favourites list** and press **OK**.
- 5 - In the list at the left, select a channel you want as a favourite and press **+ OPTIONS**. Channels come in the list at the right in the order you add them. To undo, select the channel in the list at the left and press **+ OPTIONS** again. You can also select a range of channels by pressing **▼** (down) to select the last channel of the range you want to add and then press **OK**.
- 6 - To finish adding channels, press **← BACK**.
- 7 - The TV will ask to rename the **Favourites List**. You can use the on-screen keyboard or press **← BACK** to hide the on-screen keyboard, then use the keyboard on the back of the remote control (if available) to enter new name.

You can add a range of channels in one go or start a **Favourites List** by duplicating the channel list with all channels and removing the channels you do not want.

---

## Add a Range of Channels

To add a consecutive range of channels to a **Favourites List** in one go, you can use **Select Range**.

To add a range of channels...

- 1 - Press **➤ SOURCE**.
- 2 - Select **Favourites**.
- 3 - Open the **Favourites List** where you want to add a range of channels.
- 4 - Select **⋮** at the upper right corner and press **OK**.
- 5 - Select **Edit Favourites List** and press **OK**.
- 6 - In the list at the left select the first channel of the range you want to add and press **OK**.
- 7 - Press **▼** (down) to select the last channel of the range you want to add and then press **OK**.
- 8 - Select **Add** and press **OK**. The channels are marked at the left.

---

## Rename a Favourites List

You can only rename a **Favourites List**.

To rename a **Favourites List**...

- 1 - Press **➤ SOURCE**.

- 2 - Select **Favourites**.
- 3 - Select **⋮** at the upper right corner and press **OK**.
- 4 - Select **Rename Favourite List** and press **OK**.
- 5 - Use the on-screen keyboard or press **← BACK** to hide the on-screen keyboard, then use the keyboard on the back of the remote control (if available) to enter new name.
- 6 - When done, turn the remote control, select **Close** and press **OK**.
- 7 - Press **← BACK** to close the channel list.

---

## Remove a Favourites List

You can only remove a **Favourites List**.

To remove a **Favourites List**...

- 1 - Press **➤ SOURCE**.
- 2 - Select **Favourites**.
- 3 - Select **⋮** at the upper right corner and press **OK**.
- 4 - Select **Remove Favourite List** and press **OK**.

---

## Reorder Channels

Only in a **Favourites List** you can change the sequence of channels (reorder).

To change the sequence of channels...

- 1 - Press **➤ SOURCES**, and select **Favourites**.
- 2 - Open the **Favourites List** you want to reorder.
- 3 - Select **⋮** at the upper right corner and press **OK**.
- 4 - Select **Reorder Channels** and press **OK**.
- 5 - In the **Favourites List**, select the channel you want to reorder and press **OK**. (The channel will be marked with grey box)
- 6 - With the **▲** (up) or **▼** (down) keys move the channel where you want it.
- 7 - Press **OK** to confirm the new location.
- 8 - You can reorder channels with the same method until you close the **Favourites List** with the **← BACK** key.

---

## Text / Teletext

### Text Pages

To open Text/Teletext press **TEXT**, while you are watching TV channels.

To close Text, press **TEXT** again.

### Select a Text page

To select a page . . .

- 1 - Enter the page number with the number keys.
- 2 - Use the arrow keys to navigate.
- 3 - Press a colour key to select a colour-coded subject at the bottom of the screen.

### Text sub-pages

A Text page number can hold several subpages. The subpage numbers are shown on a bar next to the main page number.

To select a subpage, press **<** or **>**.

### T.O.P. Text pages

Some broadcasters offer T.O.P. Text.

To open T.O.P. Text pages within Text,

press **+ OPTIONS** and select **T.O.P. Overview**.

### Favourite pages

The TV makes a list of the last 10 Text pages you opened. You can easily reopen them again in the Favourite Text pages column.

1 - In Text, select **♥** (heart) in the top left corner of the screen to show the column of favourite pages.

2 - Press **▼** (down) or **▲** (up) to select a page number and press **OK** to open the page.

You can clear the list with the option **Clear Favourite Pages**.

### Search Text

You can select a word and scan Text for all occurrences of this word.

1 - Open a Text page and press **OK**.

2 - Select a word or number with the arrow keys.

3 - Press **OK** again to jump immediately to the next occurrence of this word or number.

4 - Press **OK** again to jump to the subsequent occurrence.

5 - To stop searching, press **▲** (up) until nothing is selected.

### Text from a connected device

Some devices that receive TV channels can also offer Text.

To open Text from a connected device . . .

1 - Press **📺 SOURCES** select the device and press **OK**.

2 - While watching a channel on the device, press **+ OPTIONS**, select **Show Device Keys** and select the **📺** key and press **OK**.

3 - Press **← BACK** to hide the device keys.

4 - To close Text, press **← BACK** again.

### Digital Text (UK only)

Some digital broadcasters offer dedicated Digital Text or interactive TV on their digital TV channels. This includes normal Text using the number, colour and arrow keys to select and navigate.

To close Digital Text, press **← BACK**.

\* The teletext can only be reached when the channels are installed directly on the TV's internal tuner and the set is on TV mode. If a set-top box is being used, the teletext will be unavailable via TV. In that case, the set-top box's teletext can be used instead.

---

## Text Options

In Text/Teletext, press **+ OPTIONS** to select the following...

- **Freeze page**

To stop the automatic rotation of subpages.

- **Dual screen / Full screen**

To show the TV channel and Text alongside each other.

- **T.O.P. overview**

To open T.O.P. Text.

- **Enlarge**

To enlarge the Text page for comfortable reading.

- **Reveal**

To unhide hidden information on a page.

- **Cycle subpages**

To cycle subpages when these are available.

- **Hide/Show Favourite Pages**

To hide or show the list of favourite pages.

- **Clear Favourite Pages**

To clear the list of favourite pages.

- **Language**

To switch the group of characters that Text uses to display correctly.

- **Text 2.5**

To activate the Text 2.5 for more colours and better graphics.

---

## Text Setup

### Text language

Some digital TV broadcasters have several Text languages available.

To set your primary and secondary Text language . . .

1 - Press **⚙️**, select **All Settings** and press **OK**.

2 - Select **Region and Language** and press **>** (right) to enter the menu.

3 - Select **Language > Primary Text** or **Secondary Text**.

4 - Select your preferred Text languages.

5 - Press **<** (left) repeatedly if necessary, to close the menu.

### Text 2.5

If available, Text 2.5 offers more colours and better graphics. Text 2.5 is activated as a standard factory setting.

To switch off Text 2.5...

1 - Press **TEXT**.

2 - With Text/Teletext open on screen, press **+ OPTIONS**.

3 - Select **Text 2.5 > Off** and press **OK**.

4 - Press **<** (left) repeatedly if necessary, to close the menu.

---

## Filter a Channel List

You can filter a list with all channels. You can set the channel list to show only TV channels or only Radio stations. For Antenna/Cable channels you can set the list to show the Free-to-Air or the Scrambled channels. When you have several satellites installed, you can filter the satellite channel list per satellite.

To set a filter on a list with all channels...

- 1 - Press **TV**.
- 2 - Press **OK** to open the current channel list.
- 3 - With a channel list open on screen, select the list name at the top of the channel list and press **OK** to open the list menu.
- 4 - In the list menu, select the list you want to filter.
- 5 - Press **←** (left) to go back one step or press **←** to close the menu.



# Connect Devices

## About Connections

### Connectivity Guide

Always connect a device to the TV with the highest quality connection available. Also, use good quality cables to ensure a good transfer of picture and sound.

When you connect a device, the TV recognizes its type and gives each device a correct type name. You can change the type name if you wish. If a correct type name for a device is set, the TV automatically switches to the ideal TV settings when you switch to this device in the Sources menu.

If you need help to connect several devices to the TV, you can visit the Philips TV connectivity guide. The guide offers information on how to connect and which cables to use.

Go to [www.connectivityguide.philips.com](http://www.connectivityguide.philips.com)

### Antenna Port

If you have a Set-top box (a digital receiver) or Recorder, connect the antenna cables to run the antenna signal through the Set-top box and/or Recorder first before it enters the TV. In this way, the antenna and the Set-top box can send possible additional channels to the Recorder to record.

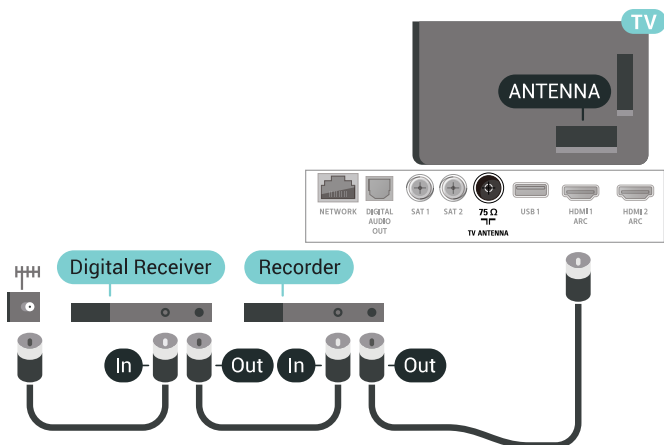

## HDMI Ports

### HDMI Quality

An HDMI connection has the best picture and sound quality. One HDMI cable combines video and audio signals. Use an HDMI cable for TV signal.

For best signal quality transfer, use a High speed HDMI cable and do not use an HDMI cable longer than 5 m.

If a device connected with HDMI is not working correctly, check if a different HDMI Ultra HD setting can solve this problem. For more information, in Help, select Keywords and look up HDMI Ultra HD.

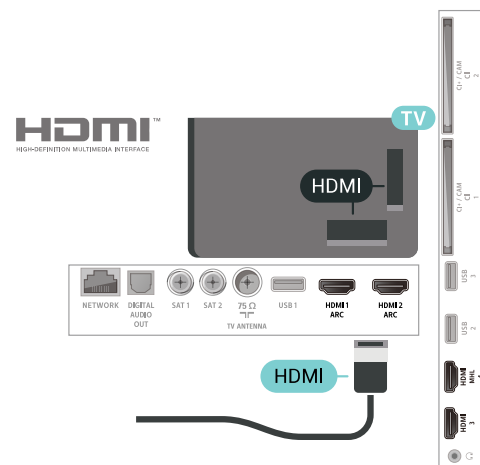

### Copy protection

HDMI cables support HDCP 2.2 (High-bandwidth Digital Content Protection). HDCP is a copy protection signal that prevents copying content from a DVD disc or Blu-ray Disc. Also referred to as DRM (Digital Rights Management).

### HDMI ARC

All of the HDMI connections on the TV have HDMI ARC (Audio Return Channel).

If the device, typically a Home Theatre System (HTS), also has the HDMI ARC connection, connect it to any of the HDMI connections on this TV. With the HDMI ARC connection, you do not need to connect the extra audio cable that sends the sound of the TV picture to the HTS. The HDMI ARC connection combines both signals.

You can use any HDMI connection on this TV to connect the HTS but ARC is only available for 1 device/connection at a time.

---

## HDMI MHL

With **HDMI MHL**, you can send what you see on your Android smartphone or tablet to a TV screen.

The **HDMI 4** connection on this TV incorporates **MHL 2.0** (Mobile High-Definition Link).

This wired connection offers great stability and bandwidth, low latency, no wireless interference and good quality sound reproduction. On top of that, the MHL connection will charge the battery of your smartphone or tablet. Although connected, your mobile device will not be charging when the TV is on standby.

Inform yourself about what passive MHL cable is suited for your mobile device. In particular, with the HDMI connector for the TV on one side, the type of connector you need to connect to your smartphone or tablet.

MHL, Mobile High-Definition Link and the MHL Logo are trademarks or registered trademarks of the MHL, LLC.



---

## HDMI CEC - EasyLink

An HDMI connection has the best picture and sound quality. One HDMI cable combines video and audio signals. Use an HDMI cable for High Definition (HD) TV signals. For best signal quality transfer, use a High speed HDMI cable and do not use an HDMI cable longer than 5 m.

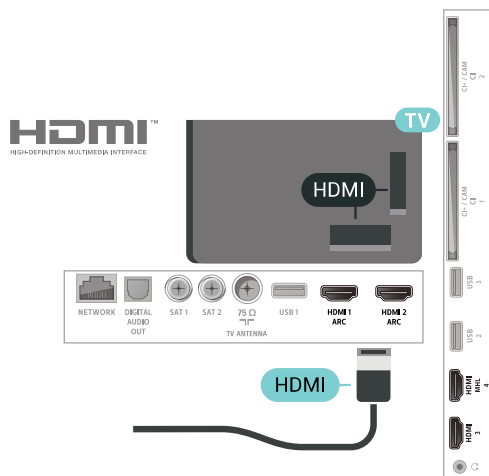

### EasyLink HDMI CEC

If your devices are connected with HDMI and have EasyLink, you can operate them with the TV remote control. EasyLink HDMI CEC must be switched On on

the TV and the connected device.

With EasyLink you can operate a connected device with the TV remote control. EasyLink uses HDMI CEC (Consumer Electronics Control) to communicate with the connected devices. Devices must support HDMI CEC and must be connected with an HDMI connection.

### EasyLink setup

The TV comes with EasyLink switched on. Make sure that all HDMI CEC settings are properly set up on the connected EasyLink devices. EasyLink might not work with devices from other brands.

### HDMI CEC on other brands

The HDMI CEC functionality has different names on different brands. Some examples are: Anynet, Aquos Link, Bravia Theatre Sync, Kuro Link, Simplink and Viera Link. Not all brands are fully compatible with EasyLink.

Example HDMI CEC branding names are property of their respective owners.

---

## DVI to HDMI

If you still own a device that only has a DVI connection, you can connect the device to any of the **HDMI** connection with a DVI to HDMI adapter.

Connect the audio L/R cable to the **AUDIO IN** connector (mini-jack 3.5mm).

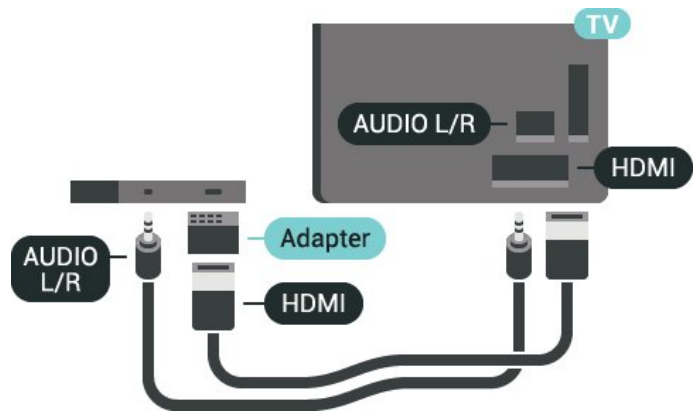

---

## Copy Protection

DVI and HDMI cables support HDCP (High-bandwidth Digital Content Protection). HDCP is a copy protection signal that prevents copying content from a DVD disc or Blu-ray Disc. Also referred to as DRM (Digital Rights Management).

## Y Pb Pr - Component

Y Pb Pr - Component Video is a high quality connection.

The YPbPr connection can be used for High Definition (HD) TV signals. Next to the Y, Pb and Pr signals add the Audio Left and Right signals for sound.

Match the YPbPr (green, blue, red) connector colours with the cable plugs when you connect. Use an Audio L/R cinch cable if your device also has sound.

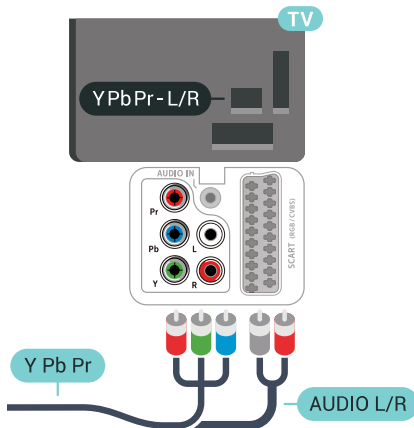

## Audio Out - Optical

Audio Out - Optical is a high quality sound connection.

This optical connection can carry 5.1 audio channels. If your device, typically a Home Theatre System (HTS), has no HDMI ARC connection, you can use this connection with the Audio In - Optical connection on the HTS. The Audio Out - Optical connection sends the sound from the TV to the HTS.

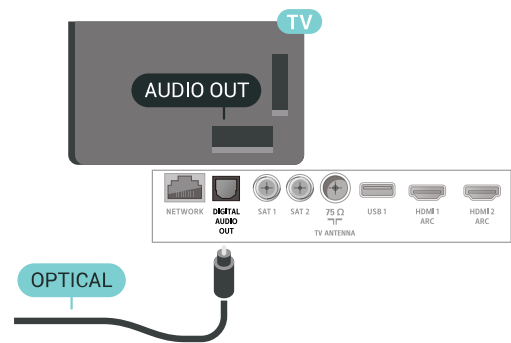

## Scart

SCART is a good quality connection.

The SCART connection can be used for CVBS and RGB video signals but cannot be used for High Definition (HD) TV signals. The SCART connection combines video and audio signals. The SCART connection also supports NTSC playback.

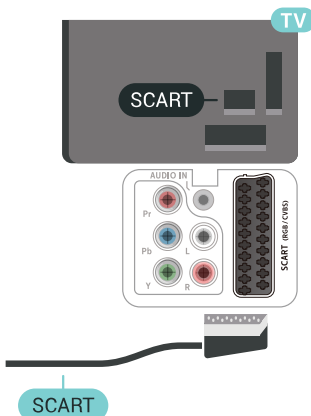

## CAM with Smart Card - CI+

### About CI+

Note: Not support for countries in Asia Pacific, Middle East, and Africa.

### CI+

This TV is ready for the CI+ Conditional Access .

With CI+ you can watch premium HD programmes, like movies and sports, offered by digital TV operators in your region. These programmes are scrambled by the TV operator and descrambled with a prepaid CI+ module.

Digital TV operators provide a CI+ module (Conditional Access Module - CAM) and an accompanying smart card, when you subscribe to their premium programmes. These programmes have a high level of copy protection.

Contact a digital TV operator for more information on terms & conditions.



## One Smart Card

Digital TV operators provide a CI+ module (Conditional Access Module - CAM) and an accompanying smart card, when you subscribe to their premium programmes.

Insert the smart card into the CAM module. See the instruction you received from the operator.

To insert the CAM in the TV...

- 1 - Look on the CAM for the correct method of insertion. Incorrect insertion can damage the CAM and TV.
- 2 - While looking at the back of the TV, with the front of the CAM facing towards you, gently insert the CAM into the slot **COMMON INTERFACE 1**.
- 3 - Push the CAM in as far as it will go. Leave it in the slot permanently.

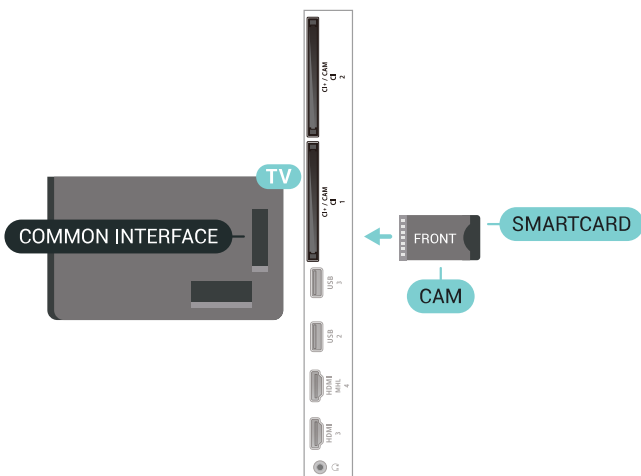

When you switch on the TV, it may take a few minutes before the CAM is activated. If a CAM is inserted and subscription fees are paid (subscription methods can differ), you can watch the scrambled channels supported by the CAM smart card.

The CAM and smart card are exclusively for your TV. If you remove the CAM, you will no longer be able to watch the scrambled channels supported by the CAM.

## Two Smart Cards

Some Digital TV operators can provide a second CI+ module (CAM) and smart card. A second CAM and smart card is needed when you want to watch one channel while recording another channel from the same TV operator.

If you can watch the same amount of channels with each card, both cards have identical viewing rights. If you can watch less channels with one of the cards, the cards have non-identical viewing rights.

If your smart cards have identical viewing rights, it does not matter which card you put in which slot. If one of the cards has more viewing rights than the other one, insert the card with the most viewing rights in the slot **COMMON INTERFACE 1**. Insert the card with less rights in **COMMON INTERFACE 2**.

Insert the smart cards into the CAM modules. See the instruction you received from the operator.

To insert the CAM in the TV...

- 1 - Look on the CAM for the correct method of insertion. Incorrect insertion can damage the CAM and TV.
- 2 - While looking at the back of the TV, with the front of the CAM facing towards you, gently insert the CAM into the slot.
- 3 - Push the CAM in as far as it will go. Leave it in the slot permanently.

When you switch on the TV, it may take a few minutes before the CAM is activated. If a CAM is inserted and subscription fees are paid (subscription methods can differ), you can watch the scrambled channels supported by the CAM smart card.

The CAM and smart card are exclusively for your TV. If you remove the CAM, you will no longer be able to watch the scrambled channels supported by the CAM.

## Passwords and PIN codes

For some CAMs, you must enter a PIN code to watch its channels. When you set the PIN code for the CAM, we recommend you to use the same code you are using to unlock the TV.

To set the PIN code for the CAM...

- 1 - Press **SOURCES**.
- 2 - Select the channel type you are using the CAM for **Watch TV**.
- 3 - Press **+ OPTIONS** and select **Common Interface**.
- 4 - Select the TV operator of the CAM. The following screens come from the TV operator. Follow the on-screen instruction to look up the PIN code setting.

# Home Theatre System - HTS

## Connect with HDMI ARC

Use an HDMI cable to connect a Home Theatre System (HTS) to the TV. You can connect a Philips Soundbar or an HTS with a built-in disc player.

### HDMI ARC

If your Home Theatre System has an HDMI ARC connection, you can use any HDMI connection on the TV to connect. With HDMI ARC, you do not need to connect the extra audio cable. The HDMI ARC connection combines both signals.

All HDMI connections on the TV can offer the Audio Return Channel (ARC) signal. But once you have connected the Home Theatre System, the TV can only send the ARC signal to this HDMI connection.

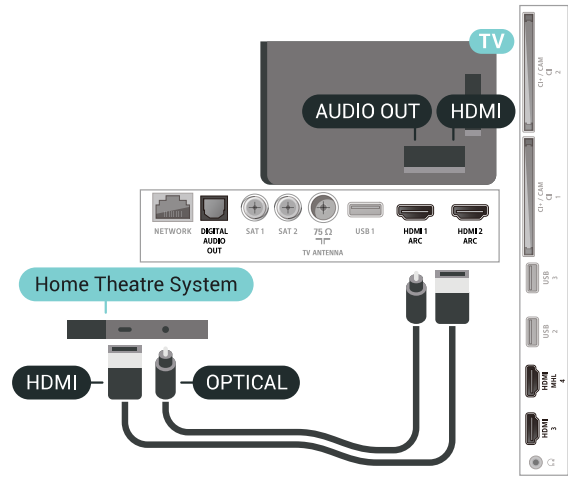

### Audio to video synchronisation (sync)

If the sound does not match the video on screen, you can set a delay on most Home Theatre Systems with a disc player to match the sound with the video.

## Problems with HTS sound

### Sound with loud noise

If you watch a video from a plugged in USB flash drive or connected computer, the sound from your Home Theatre System might be distorted. This noise is heard when the audio or video file has DTS sound but the Home Theatre System has no DTS sound processing. You can fix this by setting the **Audio Out Format** of the TV to **Stereo (uncompressed)**.

Press  for **All**

**Settings > Sound > Advanced > Audio Out Format.**

### No sound

If you cannot hear the sound from the TV on your Home Theatre System, check if you connected the HDMI cable to an **HDMI ARC** connection on the Home Theatre System. All HDMI connections on the TV are HDMI ARC connections.

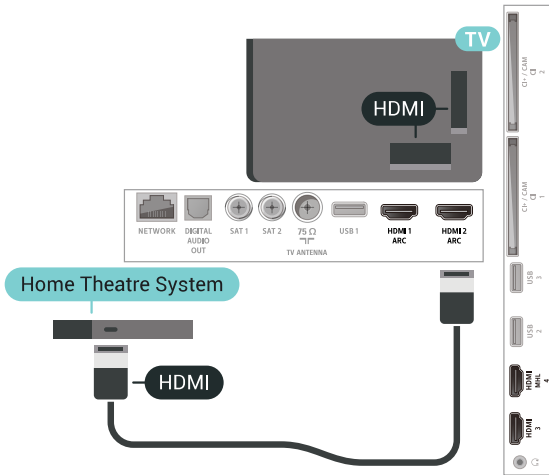

### Audio to video synchronisation (sync)

If the sound does not match the video on screen, you can set a delay on most Home Theatre Systems with a disc player to match the sound with the video.

## Connect with HDMI

Use an HDMI cable to connect a Home Theatre System (HTS) to the TV. You can connect a Philips Soundbar or an HTS with a built-in disc player.

If the Home Theatre System has no HDMI ARC connection, add an optical audio cable (Toslink) to send the sound of the TV picture to the Home Theatre System.

## Smartphones and Tablets

To connect a smartphone or tablet to the TV, you can use a wireless or wired connection.

### Wireless

For a wireless connection, on your smartphone or tablet download the Philips TV Remote App from your favourite app store.

### Wired

For a wired connection, use the HDMI 4 MHL

connection on the back of the TV. For more information, in **Help**, select **Keywords** and look up **HDMI MHL** for more information.

6.9

## Blu-ray Disc Player

Use a **High speed HDMI** cable to connect the Blu-ray Disc player to the TV.

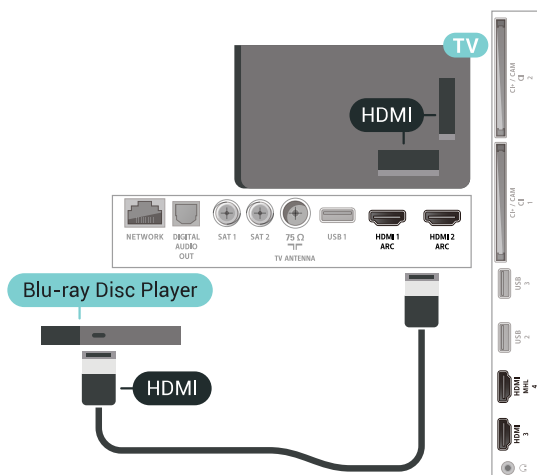

If the Blu-ray Disc player has EasyLink HDMI CEC, you can operate the player with the TV remote control.

6.10

## DVD Player

Use an **HDMI** cable to connect the DVD player to the TV.

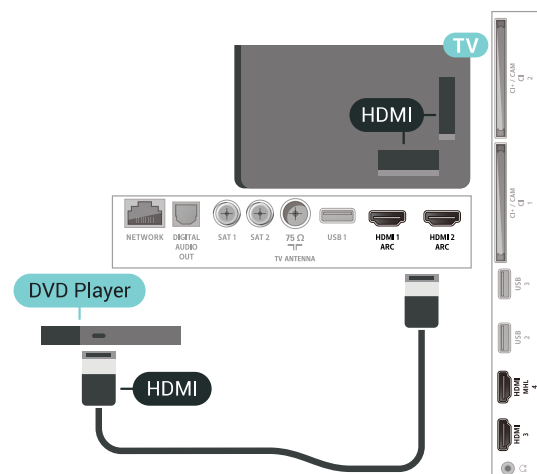

If the DVD player is connected with HDMI and has EasyLink CEC, you can operate the player with the TV remote control.

6.11

## Bluetooth – Speakers and Gamepads

### What You Need

You can connect a wireless device with Bluetooth® to this TV – a wireless speaker, a subwoofer, a sound bar or headphones. You can also connect a wireless gamepad with Bluetooth LE.

To play the TV sound on a wireless speaker, you must pair the wireless speaker with the TV. You can pair some wireless speakers and a maximum of 4 Bluetooth LE (low energy) devices. The TV can only play the sound on one speaker at a time. If you connect a subwoofer, the sound is played on the TV and the subwoofer. If you connect a sound bar the sound is played on the sound bar only.

### Attention - Audio to Video synchronisation

Many Bluetooth speaker systems have a high, so called, 'latency'. High latency means that the audio lags behind the video, causing unsynchronised 'lip sync'. Before you purchase a wireless Bluetooth speaker system, inform yourself about the newest models and look for a device with a low latency rating. Ask your dealer for advice.

### Pairing a Device

Position the wireless speaker within a distance of 5 meters from the TV. Read the user manual of the device for specific information on pairing and on wireless range. Make sure the Bluetooth setting on TV is switched on.

Once a wireless gamepad is paired, you can use it. When a wireless speaker is paired, you can select it to play the TV sound. When a device is paired, you do not need to pair it again unless you remove the device.

To pair a wireless speaker with the TV...

- 1 - Switch on the wireless speaker and place it within range of the TV.
- 2 - Press **⚙️**, select **All Settings** and press **OK**.
- 3 - Select **Wireless and Networks** and press **➤** (right) to enter the menu.
- 4 - Select **Bluetooth > Search Bluetooth Device**.
- 5 - Select **Start** and press **OK**. Follow the instructions on screen. You will pair the device with the TV and the TV will store the connection. You might need to unpair a paired device first if the maximum number of paired devices was reached.
- 6 - Select the type of device (headphone, subwoofer, ...).
- 7 - Press **⬅️** (left) repeatedly if necessary, to close

the menu.

\* Your TV doesn't support Bluetooth subwoofer and Bluetooth speakers if they are not Bluetooth LE compatible.

\*\* HDMI connection is required for sound bar, speaker and other audio device if they are not Bluetooth LE compatible.

---

## Select a Device

Once a wireless Bluetooth speaker is paired, you can select it to play the TV sound.

To select a speaker to play the TV sound...

- 1 - Press **⚙️**, select **Speakers** and press **OK**.
- 2 - Select the loudspeaker system you want.
- 3 - Press **⬅️** (left) repeatedly if necessary, to close the menu.

---

## Remove a Device

You can connect or disconnect a wireless Bluetooth device. When a Bluetooth device is connected, you can use the gamepad or hear the TV sound through the wireless speaker. You can also remove a wireless Bluetooth device. If you remove a Bluetooth device, the device will be unpaired.

To remove or disconnect a wireless device...

- 1 - Press **⚙️**, select **All Settings** and press **OK**.
- 2 - Select **Wireless and Networks**.
- 3 - Select **Bluetooth > Remove Device**.
- 4 - In the list, select the wireless device.
- 5 - Select **Disconnect** or **Remove**.
- 6 - Select **OK**.
- 7 - Press **⬅️** (left) repeatedly if necessary, to close the menu.

---

6.12

## Headphones

You can connect a set of headphones to the **🎧** connection on the back of the TV. The connection is a mini-jack 3.5mm. You can adjust the volume of the headphones separately.

To adjust the volume...

- 1 - Press **⚙️**, select **Headphone Volume**.
- 2 - Press the arrows **⬆️** (up) or **⬇️** (down) to adjust the value.
- 3 - Press **⬅️** (left) repeatedly if necessary, to close the menu.

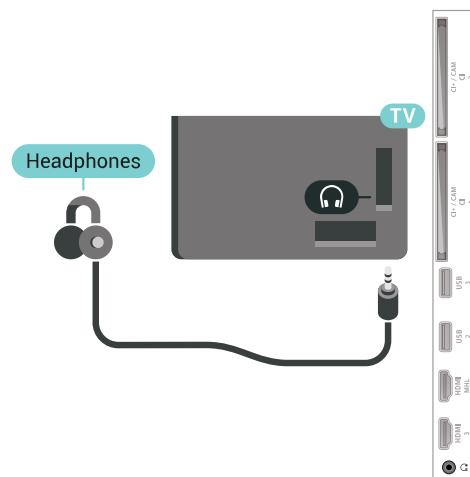

---

6.13

## Game Console

---

### HDMI

For best quality, connect the game console with a High speed HDMI cable to the TV.

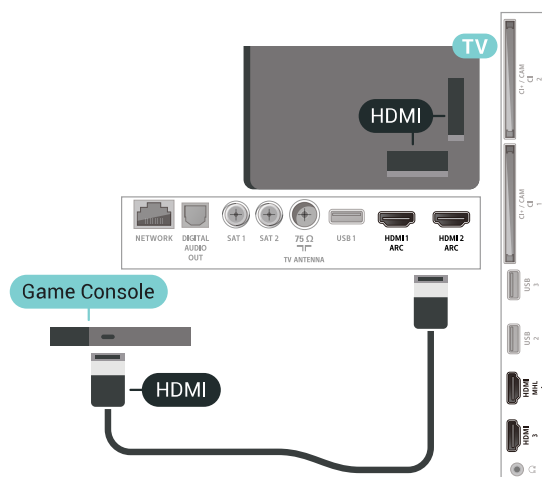

---

### Y Pb Pr

Connect the game console with a component video cable (Y Pb Pr) and an audio L/R cable to the TV.

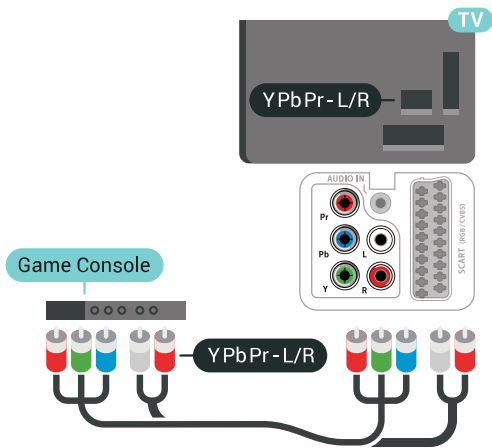

## Scart

Connect the game console to the TV with a composite cable (CVBS) and an audio L/R cable to the TV.

If your game console only has Video (CVBS) and Audio L/R output, use a Video Audio L/R to SCART adapter (sold separately) to connect to the SCART connection.

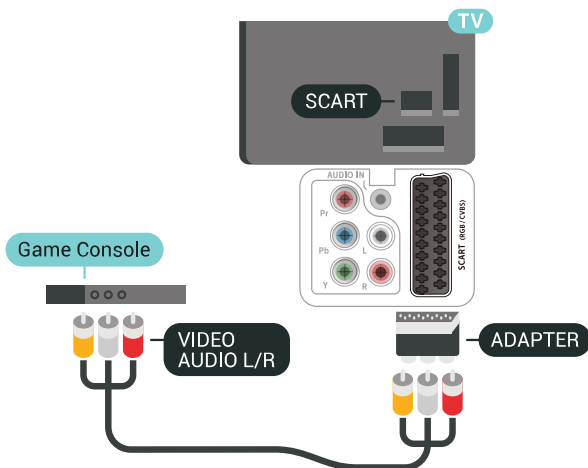

## Best Setting

Before you start playing a game from a connected game console, we advice you to set the TV in the ideal setting **Game**.

To set the TV to the ideal setting...

- 1 - Press **⚙️**, select **All Settings** and press **OK**.
- 2 - Select **Picture** and press **➡️** (right) to enter the menu.
- 3 - Select **Picture Style > Game**.
- 4 - Press **⬅️** (left) repeatedly if necessary, to close the menu.

6.14

## Gamepad

### Connect a Gamepad

To play games from the Internet on this TV, you can connect a selected range of wireless Gamepads. You can use Gamepads with a USB nano receiver or gamepads with Bluetooth.

To connect a Gamepad with a USB nano receiver...

- 1 - Plug in the small nano receiver in one of the USB connections on the side of the TV. The wireless nano receiver comes with the Gamepad.
- 2 - If the Gamepad is switched on, you can use the Gamepad.

You can connect a second Gamepad in the second USB connection on the side of the TV.

### Problems

To solve possible interference with other wireless devices on TV...

- Use a USB extension cord and move the nano receiver about 1 meter away from the TV.
- Alternatively, you can use a powered USB hub connected to the TV and plug in the nano receivers in the USB hub.

6.15

## USB Hard Drive

### What You Need

If you connect a USB Hard Drive, you can pause or record digital TV broadcasts (DVB broadcasts or similar).

#### Minimum Disk Space

- To Pause

To pause a broadcast, you need a USB 2.0 compatible Hard Drive with a minimum of 4GB disk space.

- To Record

To pause and record a broadcast, you need a minimum of 250GB disk space.



---

## Installation

Before you can pause or record a broadcast, you must connect and format a USB Hard Drive. Formatting removes all files from the USB Hard Drive.

- 1 - Connect the USB Hard Drive to one of the **USB** connections on the TV. Do not connect another USB device to the other USB ports when formatting.
- 2 - Switch on the USB Hard Drive and the TV.
- 3 - When the TV is tuned to a digital TV channel, press **||** (Pause). Trying to pause will start the formatting.

Follow the instructions on screen.

When the USB Hard Drive is formatted, leave it connected permanently.

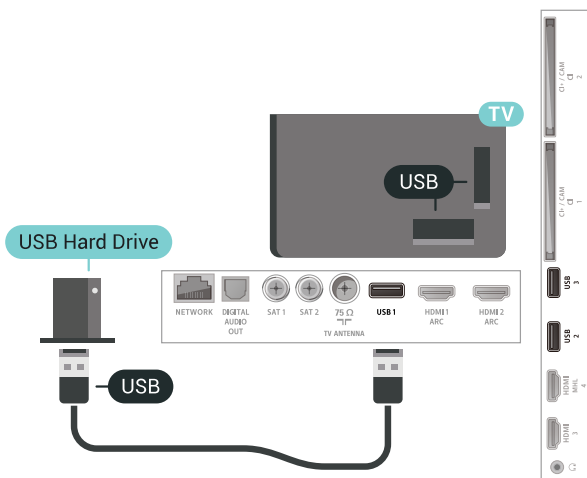

corrupt your recordings. When you format another USB Hard Drive, the content on the former will be lost. A USB Hard Drive installed on your TV will need reformatting for use with a computer.

To format a USB Hard Drive...

- 1 - Connect the USB Hard Drive to one of the **USB** connections on the TV. Do not connect another USB device to the other USB ports when formatting.
- 2 - Switch on the USB Hard Drive and the TV.
- 3 - When the TV is tuned to a digital TV channel, press **||** (Pause). Trying to pause will start the formatting. Follow the instructions on screen.
- 4 - The TV will ask if you want to use the USB Hard Drive to store apps, agree to the question if you do.
- 5 - When the USB Hard Drive is formatted, leave it connected permanently.

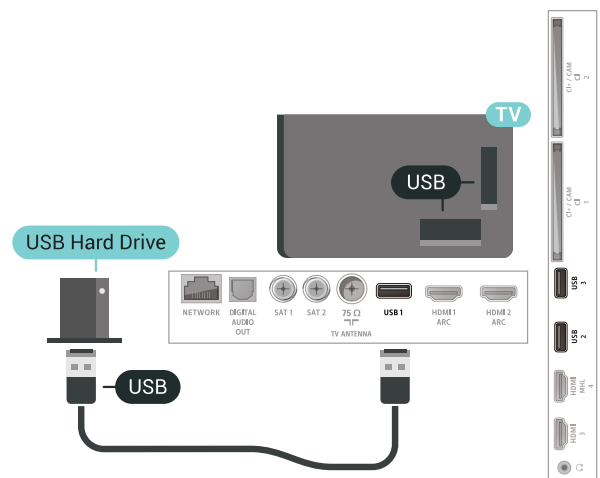

### Warning

The USB Hard Drive is formatted exclusively for this TV, you cannot use the stored recordings on another TV or PC. Do not copy or change recording files on the USB Hard Drive with any PC application. This will corrupt your recordings. When you format another USB Hard Drive, the content on the former will be lost. A USB Hard Drive installed on your TV will need reformatting for use with a computer.

---

## Formatting

Before you can pause or record a broadcast, or store apps, you must connect and format a USB Hard Drive. Formatting removes all files from the USB Hard Drive. If you want to record broadcasts with TV Guide data from the Internet, you must setup the Internet connection first before you install the USB Hard Drive.

### Warning

The USB Hard Drive is formatted exclusively for this TV, you cannot use the stored recordings on another TV or PC. Do not copy or change recording files on the USB Hard Drive with any PC application. This will

---

6.16

## USB Keyboard

---

### Connect

Connect a USB keyboard (USB-HID type) to enter text on your TV.

Use one of the **USB** connections to connect.



---

## Configure

### Install the keyboard

To install the USB keyboard, switch on the TV and connect the USB keyboard to one of the USB connections on the TV. When the TV detects the keyboard for the first time, you can select your keyboard lay-out and test your selection. If you select a Cyrillic or Greek keyboard layout first, you can select a secondary Latin keyboard layout.

To change the keyboard layout setting when a layout was selected...

- 1 - Press **⚙**, select **All Settings** and press **OK**.
- 2 - Select **General Settings** and press **➤** (right) to enter the menu.
- 3 - Select **USB Keyboard Settings** to start the keyboard setup.

---

## Special Keys

### Keys for entering text

- Enter key = OK
- Backspace = delete character before cursor
- Arrow keys = navigate within a text field
- To switch between keyboard layouts, if a secondary layout is set, press the **Ctrl + Spacebar** keys simultaneously.

### Keys for apps and Internet pages

- Tab and Shift + Tab = Next and Previous
- Home = scroll to the top of the page
- End = scroll to the bottom of the page
- Page Up = jump one page up
- Page Down = jump one page down
- + = zoom in one step
- - = zoom out one step
- \* = fit the web page to the screen width

---

6.17

## USB Flash Drive

You can view photos or play your music and videos from a connected USB flash drive.

Insert a USB flash drive in one of the USB connections on the TV while the TV is switched on.

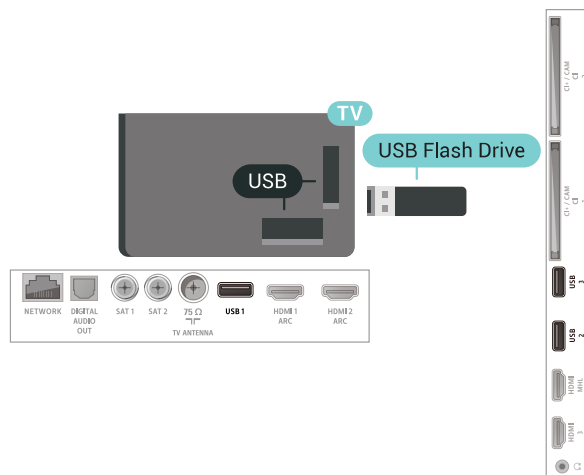

The TV detects the flash drive and opens a list showing its content.

If the contents list does not appear automatically, press **➤ SOURCES** and select **USB**.

To stop watching the USB flash drive content, press **TV EXIT** or select another activity.

To disconnect the USB flash drive, you can pull out the flash drive anytime.

For more information on watching or playing content from a USB flash drive, in **Help**, select **Keywords** and look up **Photos, Videos and Music**.

---

6.18

## Photo Camera

To view photos stored on your digital photo camera, you can connect the camera directly to the TV.

Use one of the USB connections on the TV to connect. Switch on the camera after you made the connection.

If the contents list does not appear automatically, press **➤ SOURCES**, and select **USB**.

Your camera might need to be set to transfer its content with PTP (Picture Transfer Protocol). Read the user manual of the digital photo camera.

For more information on viewing photos, in **Help**, select **Keywords** and look up **Photos, Videos and Music**.

---

6.19

## Camcorder

## HDMI

For best quality, use an HDMI cable to connect the camcorder to the TV.

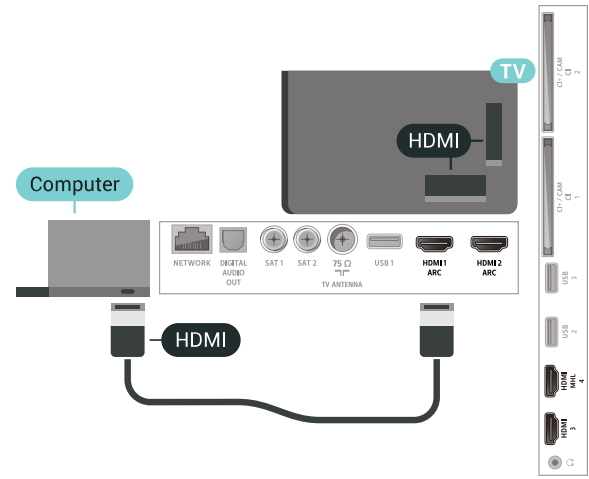
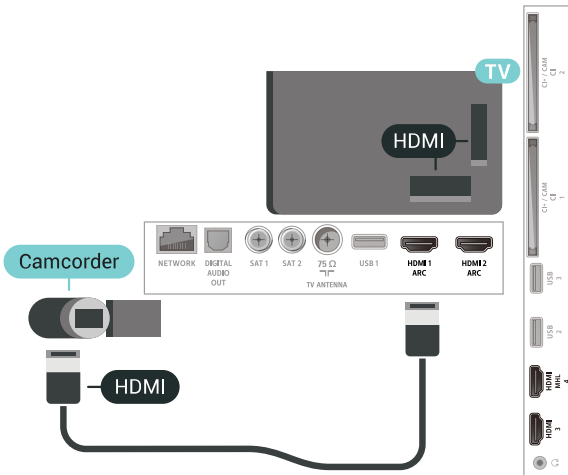

## Audio Video LR / Scart

You can use an HDMI, YPbPr or SCART connection to connect your camcorder. If your camcorder only has Video (CVBS) and Audio L/R output, use a Video Audio L/R to SCART adapter (sold separately) to connect to the SCART connection.

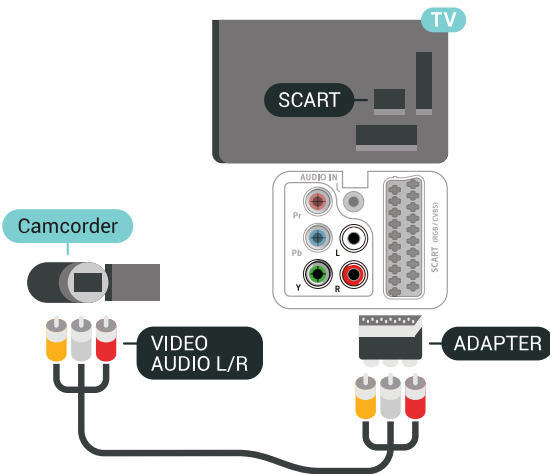

6.20

## Computer

### Connect

You can connect your computer to the TV and use the TV as a PC monitor.

#### With HDMI

Use an HDMI cable to connect the computer to the TV.

## Ideal Setting

If you connect a computer, we advise you to give the connection, on which the computer is connected, the correct device type name in the Source menu. If you then switch to **Computer** in the Source menu, the TV is set to the ideal Computer setting automatically.

To set the TV to the ideal setting...

- 1 - Press **⚙**, select **All Settings** and press **OK**.
- 2 - Select **Picture** and press **➤** (right) to enter the menu.
- 3 - Select **Advanced > Computer**.
- 4 - Select **On** or **Off**.
- 5 - Press **⬅** (left) repeatedly if necessary, to close the menu.

6.21

## PTA860 Wireless Speaker Stands

### About the PTA860

With the Philips PTA860 Wireless Detachable Speaker Stands\* you can position your side speakers further away from your TV screen. The sound will be more spacious and will better fit the large screen viewing experience. The minimalistic design of the stands match the design of the slim speakers perfectly. On these stands, the speakers are connected wirelessly to the TV.



You can use the PTA860 together with the wireless SUB100 Subwoofer \* for a rich, deeper and spatial sound.

\* The PTA860 and SUB100 are sold separately.

---

## Setting Up

Before you start setting up both PTA860 speaker stands, make sure you have 2 spare power outlets available. One for each stand.

For an ideal sound reproduction, place the speaker stands not more than 1 meter away from the TV. Make sure you position the Left speaker at the left and the Right speaker at the right side of the TV. The speakers stands are marked on the bottom.

To mount the speakers on the speaker stands...

- 1 - With the TV switched off, disconnect the speaker plugs from the connectors on the back of the TV.
- 2 - Pull the speaker away from the side of the TV. The speakers are attached magnetically.
- 3 - To detach the cable and cap from the speaker, take the speaker in one hand and the small cable in the other and gently, but with some force, pull the cable away in line with the loudspeaker. You will detach the internal connector pin from the speaker.
- 4 - Slide the bottom opening of the loudspeaker over the connector pin of the stand column. Make sure you turn the speaker with the small notch at one side on the bottom to fit the tab on the stand column. Gently push the speaker down on the column until both units match perfectly.
- 5 - Plug in the PTA860 USB dongle in one of the **USB** connectors on the back of the TV and connect the green mini-jack connector to the **WIRELESS AUDIO** connection.
- 6 - Connect the power cords to both speaker stands and plug them in both power outlets.

For your convenience, the PTA860 USB dongle and both speaker stands are already paired in the factory.

You can use the adjustable feet of the speaker stand to correct the column if it is tilted or to fix its stability.

---

## Pairing



For your convenience, the PTA860 USB dongle and both speaker stands are already paired in the factory. When you set up the stands there's no need to pair them. The LED light, on the USB dongle and both the stands, light up white to indicate that all 3 are powered and connected.

### Pairing or pairing again

If for any reason the USB dongle and speaker stands

do not connect and one or all LEDs blink red, you need to pair again.

To pair again...

- 1 - Press the small pairing button  on the USB dongle for 5 seconds and do the same on each speaker stand to start the pairing process. You have the time to do this one after the other. All LEDs will slowly blink white.
- 2 - The system will try to pair the USB dongle to both speaker stands.
- 3 - If the USB dongle and both speaker stands are paired, their LEDs light up white.
- 4 - If a LED on one of the speaker stands keeps blinking red, press the pairing button  on the USB dongle again for 5 seconds and do the same on this one speaker stand. The system will try to connect again.

When you switch the TV to standby, both detachable speaker stands will also go to standby. Their LEDs will light up red.

# Connect your Android TV

## Network and Internet

### Home Network

To enjoy the full capabilities of your Philips Android TV, your TV must be connected to the Internet.

Connect the TV to a home network with a high-speed Internet connection. You can connect your TV wirelessly or wired to your network router.

### Connect to Network

#### Wireless Connection

##### What You Need

To connect the TV to the Internet wirelessly, you need a Wi-Fi router with a connection to the Internet.

Use a high-speed (broadband) connection to the Internet.



To make a wireless connection...

- 1 - Press **⚙️**, select **All Settings** and press **OK**.
- 2 - Select **Wireless and Networks** and press **➤** (right) to enter the menu.
- 3 - Select **Wired or Wi-Fi > Connect to Network**.
- 4 - Select **Wireless**.
- 5 - In the list of found networks, select on your wireless network. If your network is not in the list because the network name is hidden (you switched off the SSID broadcast of the router), select **Add New Network** to enter the network name yourself.
- 6 - Depending on the type of router, enter your encryption key - WEP, WPA or WPA2. If you entered the encryption key for this network before, you can select **OK** to make the connection immediately.
- 7 - A message will be shown when the connection is successful.

#### Wi-Fi On/Off

Make sure Wi-Fi is switched on before you try to make the connection...

- 1 - Press **⚙️**, select **All Settings** and press **OK**.
- 2 - Select **Wireless and Networks** and press **➤** (right).
- 3 - Select **Wired or Wi-Fi > Wi-Fi On/Off**.
- 4 - If it is switched off, select **On** and press **O**.

#### WPS

If your router has WPS, you can directly connect to the router without scanning for networks. If you have devices in your wireless network that use the WEP security encryption system, you cannot use WPS.

- 1 - Press **⚙️**, select **All Settings** and press **OK**.
- 2 - Select **Wireless and Networks** and press **➤** (right) to enter the menu.
- 3 - Select **Wired or Wi-Fi > Connect to Network**.
- 4 - Select **WPS**.
- 5 - Go to the router, press the WPS button and return to the TV within 2 minutes.
- 6 - Select **Connect** to make the connection.
- 7 - A message will be shown when the connection is successful.

#### WPS with PIN Code

If your router has WPS with a PIN code, you can directly connect to the router without scanning for networks. If you have devices in your wireless network that use the WEP security encryption system, you cannot use WPS.

- 1 - Press **⚙️**, select **All Settings** and press **OK**.
- 2 - Select **Wireless and Networks** and press **➤** (right) to enter the menu.
- 3 - Select **Wired or Wi-Fi > Connect to Network**.
- 4 - Select **WPS with PIN code**.
- 5 - Write down the 8-digit PIN code shown on screen and enter it in the router software on your PC. Consult the router manual on where to enter the PIN code in the router software.
- 6 - Select **Connect** to make the connection.
- 7 - A message will be shown when the connection is successful.

#### Problems

##### Wireless network not found or distorted

- Microwave ovens, DECT phones or other Wi-Fi 802.11b/g/n devices in your proximity might disturb the wireless network.
- Make sure that the firewalls in your network allow access to the TV's wireless connection.
- If the wireless network does not work properly in your home, try the wired network installation.

## Internet does not work

· If the connection to the router is OK, check the router connection to the Internet.

## The PC and Internet connection are slow

- Look in your wireless router's user manual for information on indoor range, transfer rate and other factors of signal quality.
- Use a high-speed (broadband) Internet connection for your router.

## DHCP

· If the connection fails, you can check the DHCP (Dynamic Host Configuration Protocol) setting of the router. DHCP should be switched on.

---

## Wired Connection

### What You Need

To connect the TV to the Internet, you need a network router with a connection to the Internet. Use a high-speed (broadband) connection to the Internet.

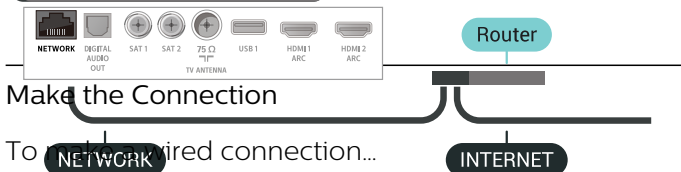
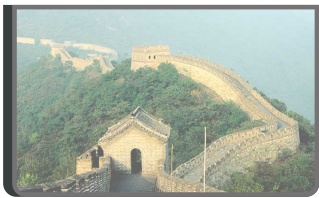

### Make the Connection

To make a wired connection...

- 1 - Connect the router to the TV with a network cable (Ethernet cable\*\*).
- 2 - Make sure that the router is switched on.
- 3 - Press **⚙**, select **All Settings** and press **OK**.
- 4 - Select **Wireless and Networks** and press **➤** (right) to enter the menu.
- 5 - Select **Wired or Wi-Fi > Connect to Network**.
- 6 - Select **Wired**. The TV constantly searches for the network connection.
- 7 - A message will be shown when the connection is successful.

If the connection fails, you can check the DHCP setting of the router. DHCP should be switched on.

\*\*To fulfill EMC regulations, use a shielded FTP Cat. 5E Ethernet cable.

---

## Network Settings

### View Network Settings

You can view all current network settings here. The IP and MAC address, signal strength, speed, encryption method, etc.

To view the current network settings...

- 1 - Press **⚙**, select **All Settings** and press **OK**.
- 2 - Select **Wireless and Networks** and press **➤** (right) to enter the menu.
- 3 - Select **Wired or Wi-Fi > View Network Settings**.
- 4 - Press **◀** (left) repeatedly if necessary, to close the menu.

---

### Network Configuration

If you are an advanced user and want to install your network with Static IP addressing, set the TV to **Static IP**.

To set the TV to Static IP...

- 1 - Press **⚙**, select **All Settings** and press **OK**.
- 2 - Select **Wireless and Networks** and press **➤** (right) to enter the menu.
- 3 - Select **Wired or Wi-Fi > Network Configuration** and press **OK**.
- 4 - Select **Static IP** and press **OK** to enable **Static IP Configuration**.
- 5 - Select **Static IP Configuration** and configure the connection.
- 6 - You can set the number for **IP Address**, **Netmask**, **Gateway**, **DNS 1**, or **DNS 2**.
- 7 - Press **◀** (left) repeatedly if necessary, to close the menu.

---

### Switch On with Wi-Fi (WoWLAN)

You can switch this TV on from your smartphone or tablet if the TV is in Standby. The setting **Switch On with Wi-Fi (WoWLAN)** must be switched on.

To switch on WoWLAN...

- 1 - Press **⚙**, select **All Settings** and press **OK**.
- 2 - Select **Wireless and Networks** and press **➤** (right) to enter the menu.
- 3 - Select **Wired or Wi-Fi > Switch On with Wi-Fi (WoWLAN)**.
- 4 - Select **On**.
- 5 - Press **◀** (left) repeatedly if necessary, to close the menu.

---

## Switch on Wi-Fi connection

You can switch on or off Wi-Fi connection on your TV.

To switch on Wi-Fi...

- 1 - Press , select **All Settings** and press **OK**.
- 2 - Select **Wireless and Networks** and press **➤** (right) to enter the menu.
- 3 - Select **Wired or Wi-Fi > Wi-Fi On/Off**.
- 4 - Select **On**.
- 5 - Press **◀** (left) repeatedly if necessary, to close the menu.

---

## Digital Media Renderer - DMR

If your media files do not play on your TV, make sure that the Digital Media Renderer is switched on. As a factory setting, DMR is switched on.

To switch on DMR...

- 1 - Press , select **All Settings** and press **OK**.
- 2 - Select **Wireless and Networks** and press **➤** (right) to enter the menu.
- 3 - Select **Wired or Wi-Fi > Digital Media Renderer - DMR**.
- 4 - Select **On**.
- 5 - Press **◀** (left) repeatedly if necessary, to close the menu.

---

## Wi-Fi Smart Screen

To watch digital TV channels on your smartphone or tablet with the Philips TV Remote App, you must switch on Wi-Fi Smart Screen. Some scrambled channels might not be available on your mobile device.

To switch on Wi-Fi Smart Screen...

- 1 - Press , select **All Settings** and press **OK**.
- 2 - Select **Wireless and Networks** and press **➤** (right) to enter the menu.
- 3 - Select **Wired or Wi-Fi > Wi-Fi Smart Screen**.
- 4 - Select **On**.
- 5 - Press **◀** (left) repeatedly if necessary, to close the menu.

---

## TV Network Name

If you have more than one TV in your home network, you can give the TV a unique name.

To change the TV name...

- 1 - Press , select **All Settings** and press **OK**.
- 2 - Select **Wireless and Networks** and press **➤** (right) to enter the menu.
- 3 - Select **Wired or Wi-Fi > TV Network Name**.

4 - Enter the name with the remote control keyboard.

5 - To finish, select **✓**.

6 - Press **◀** (left) repeatedly if necessary, to close the menu.

---

## Clear Internet Memory

With Clear Internet Memory you clear your Philips server registration and parental rating settings, your video store app logins, all Philips apps favourites, Internet bookmarks and history. Interactive MHEG applications can also save so-called 'cookies', on your TV. These files will also be cleared.

To clear the Internet memory...

- 1 - Press , select **All Settings** and press **OK**.
- 2 - Select **Wireless and Networks** and press **➤** (right) to enter the menu.
- 3 - Select **Wired or Wi-Fi > Clear Internet Memory**.
- 4 - Select **OK** to confirm.
- 5 - Press **◀** (left) repeatedly if necessary, to close the menu.

---

## File Sharing

The TV can connect to other devices in your wireless network, like your computer or smartphone. You can use a computer with Microsoft Windows or Apple OS X.

On this TV, you can open photos, music and videos stored on your computer. Use any recent DLNA certified media server software.

---

7.2

## Google Account

---

### Sign In

To enjoy the full capabilities of your Philips Android TV, you can sign in to Google with your Google Account.



By signing in you'll be able to play your favourite games across phone, tablet and TV. You'll also get customised video and music recommendations on your TV home screen as well as access to YouTube, Google Play and other apps.

### Sign In

Use your existing **Google Account** to sign in to Google on your TV. A Google Account consists of an email address and a password. If you don't have a Google Account yet, use your computer or tablet to create one (accounts.google.com). To play games with Google Play, you need a Google+ profile. If you

did not sign in during the first TV installation, you can always sign in later.

To sign in after you did the TV installation...



- 1 - Press , select **All Settings** and press **OK**.
- 2 - Select **Android Settings** and press **OK**.
- 3 - Press  (down) and select **Personal** > **Add account** and press **OK**.
- 4 - Press **OK** on **SIGN IN**.
- 5 - With the remote control keyboard, enter your email address and press the small **OK** key at the right of the keyboard.
- 6 - Enter your password and press the same small **OK** key to sign in.
- 7 - Press  (left) repeatedly if necessary, to close the menu.

---

## Android Settings

You can set or view several Android specific settings or information. You can find the list of apps installed on your TV and the storage space they need. You can set the language you like to use with Voice Search. You can configure the onscreen keyboard or allow apps to use your location. Explore the different Android settings. You can go to [www.support.google.com/androidtv](http://www.support.google.com/androidtv) for more information on these settings.

To open these settings...

- 1 - Press , select **All Settings** and press **OK**.
- 2 - Select **Android Settings**.
- 3 - Explore the different Android settings.
- 4 - Press  **BACK** if necessary, to close the menu.

---

7.3

## Philips TV Collection app

---



### Featured Apps page

All your premium apps are available within the Philips TV Collection app, under Featured apps section. Launch it using the banner on the Favourite apps channel.

Philips TV Collection apps are made specially for TV. Downloading and installing Philips TV Collection apps are free of charge. The Philips TV Collection of apps can differ per country or region. The Philips TV Collection will also contain recommendations for new Apps and more.

Some Philips TV Collection apps are pre-installed on your TV. To install other apps from Philips TV Collection, you will be asked to agree to the Terms of Use. You can set the Privacy Settings according to your preference.

To install an app from the Philips TV Collection...

- 1 - Press  **HOME**.
- 2 - Select  **Philips TV Collection** and press **OK**. It will open the Featured apps section.
- 3 - Select the "All" tab and press **OK**. It will display all the apps that are available to the user, including the installed ones.
- 4 - Browse through the apps and select the app icon that you want to install, and press **OK**. It will open the App info page.
- 5 - Select the **Add** button and press **OK** to install the app.



The installed app found in the Apps page, which can be opened from the Android Home screen by pressing the Apps icon at the left end of the Favourite Apps row.

---

## Terms of Use

To install and use the Philips TV Collection apps, you must agree to the Terms of Use. If you did not agree to these terms during the first TV installation, you can always agree to them later. The moment you agree to the Terms of Use, some apps will be available immediately and you can browse the Philips TV Collection to install other apps.

To agree on the Terms of Use after you did the TV installation...

- 1 - Press  **HOME**, select  **Philips TV Collection** and press **OK**. Press the **Options** key to open the Options menu.
- 2 - You can select **Terms of Use**, then press **OK** to read.
- 3 - Select **Accept** and press **OK**. You cannot undo this approval.
- 4 - Press  **BACK** to close the menu.



---

## Privacy Settings

You can set some privacy settings for the Philips TV Collection apps.

- You can allow technical statistics to be send to Philips.
- You can allow personal recommendations.
- You can allow cookies.
- You can switch on the Child Lock for 18+ rated apps.

To set the Philips TV Collection privacy settings...



- 1 - Press  **HOME**, select  **Philips TV Collection** and press **OK**. Press the **Options** key to open the Options menu.
- 2 - You can select **Privacy Policy**, then press **OK**.
- 3 - Select each setting and press **OK** to allow or disallow. You can read about each setting in detail.
- 4 - Press  **BACK** to close the menu.



## Android Settings

You can set or view several Android specific settings or information. You can find the list of apps installed on your TV and the storage space they need. You can set the language you like to use with Voice Search. You can configure the onscreen keyboard or allow apps to use your location. Explore the different Android settings. You can go to [www.support.google.com/androidtv](http://www.support.google.com/androidtv) for more information on these settings.

To open these settings...

- 1 - Press , select **All Settings** and press **OK**.
- 2 - Select **Android Settings**.
- 3 - Explore the different Android settings.
- 4 - Press  **BACK** if necessary, to close the menu.

## Home Screen

### About the Home Screen

To enjoy the benefits of your Android TV, connect the TV to the Internet.

Like on your Android smartphone or tablet, the Home screen is the centre of your TV. From the Home screen you can decide what to watch by browsing entertainment options from app and live TV. Your Home has channels to let you discover great contents from your favourite apps. You can also add additional channels or find new apps to get more contents.

The Home screen is organised in channels...

#### Apps

Your favourite Apps are placed on the first row. In this row you will also find the Apps for TV, like **Philips TV Collection**, **Watch TV**, **TV Guide**, **Media** and others. You can find more apps in the Apps page which can be opened by clicking the **Apps** icon at the left end of the Favourite apps row. You can also add more apps as favourite from the Apps page.

The Apps page contains all installed Apps that come with the TV and the Apps you install from **Philips TV Collection** or **Google Play™ Store** yourself.

#### Play Next channel

You can always know what to watch next from **Play Next** channel on the Home screen. Start watching from where you left off and get notifications about new episodes in the **Play Next** channel. Press and hold **Select** on a movie or TV show to add it directly to the **Play Next** channel.

#### Google Play Movies & TV channel

Rent movies or TV shows on this channel from **Google Play Movies & TV**.

#### Help channel

This channel contains "How to..." tutorial videos to let you know how to unbox, how to connect external devices, how to install channel, etc.

#### YouTube channel

This channel contains your Recommended, Subscriptions or Trending YouTube videos.



#### Customize channels

Click the **CUSTOMIZE CHANNELS** button to add and remove channels from your Home screen.

See also [www.support.google.com/androidtv](http://www.support.google.com/androidtv)

## Open the Home Screen

To open the Home screen and open an item...

- 1 - Press  **HOME**.
- 2 - Select an item and press **OK** to open or start it.
- 3 - Press  **BACK** continuously or press  **HOME** can go back to Home screen.

When opening the Home screen, the background application/content playback will stop. You have to select the application or content from the Home screen to resume.

---

# Apps

---

## About Apps

You can find your favourite Apps on Apps row in the Home menu.

Like apps on your smartphone or tablet, the apps on your TV offer specific functions for an enriched TV experience. Apps like YouTube, games, video stores or weather forecasts (a.o.). You can use the Internet Browser app to surf the Internet.

Apps can come from the **Philips TV Collection** or the **Google Play™ Store**. To get you started, some practical apps are pre-installed on your TV.

To install apps from the **Philips TV Collection** or the **Google Play™ Store**, the TV must be connected to the Internet. You must agree to the Terms of Use to use apps from the **Philips TV Collection**. You must sign in with a Google Account to use the Google Play apps and Google Play™ Store.

---

## Google Play

---

### Movies and TV

With **Google Play Movies & TV**, you can rent or buy movies and TV shows to watch on TV.







#### What You Need

- your TV must be connected with the Internet
- you must sign in with your Google Account on TV
- add a credit card to your Google Account to purchase movies and TV shows

To rent or buy a movie or TV show...

- 1 - Press  HOME.
- 2 - Select **Google Play Movies & TV**.
- 3 - Select a movie or TV show and press **OK**.
- 4 - Select the purchase you want and press **OK**. You will be taken through the purchase procedure.

To watch a rented or bought movie or TV show...

- 1 - Press  HOME.
- 2 - Select **Google Play Movies & TV**.
- 3 - Select the movie or TV show from your library in the app, select the title and press **OK**.
- 4 - You can use the  (stop),  (pause),  (rewind) or  (fast forward) keys on the remote control.
- 5 - To stop the Movies & TV app, press  **BACK** repeatedly or press  **EXIT**.

If the App is not on your Home screen, you can add

via the Apps page or by the **Add app to favourites** item on the **Favourite apps** row. Some Google Play products and features aren't available in all countries.

Find more information on [support.google.com/androidtv](http://support.google.com/androidtv)

---

## Music



With Google Play Music, you can play your favourite music on TV.

With Google Play Music you can buy new music on your computer or mobile device. Or, on your TV, you can sign up for All Access, the Google Play Music subscription. Alternatively, you can play the music you already own, stored on your computer.

#### What You Need

- your TV must be connected with the Internet
- you must sign in with your Google Account on TV
- add a credit card to your Google Account to take a music subscription

To start Google Play Music...

- 1 - Press  HOME.
- 2 - Select **Google Play Music**.
- 3 - Select the music you want and press **OK**.
- 4 - To stop the Music app, press  **BACK** repeatedly or press  **EXIT**.

If the App is not on your Home screen, you can add via the Apps page or by the **Add app to favourites** item on the **Favourite apps** row. Some Google Play products and features aren't available in all countries.

Find more information on [support.google.com/androidtv](http://support.google.com/androidtv)

---

## Games

With Google Play Games, you can play games on TV. Online or offline.

You can see what your friends are playing currently or you can join the game and compete. You can track your achievements or start wherever you left off.

#### What You Need

- your TV must be connected with the Internet
- you must sign in with your Google Account on TV
- add a credit card to your Google Account to purchase new games

Start the Google Play Games app to select and install new game apps on your TV. Some games are free of charge. A message appears if a particular game needs a gamepad to play the game.

To start or stop a Google Play Game...

- 1 - Press  HOME.

- 2 - Select **Google Play Games**.
- 3 - Select a game to play or select a new game to install and press **OK**.
- 4 - When done, press **← BACK** repeatedly or press **TV EXIT** or stop the app with its dedicated exit/stop button.

If the App is not on your Home screen, you can add via the Apps page or by the **Add app to favourites** item on the **Favourite apps** row. Some Google Play products and features aren't available in all countries.

Find more information on [support.google.com/androidtv](https://support.google.com/androidtv)

---

## Google Play Store

From the **Google Play™ Store** you can download and install new apps. Some apps are free of charge.

### What You Need

- your TV must be connected with the Internet
- you must sign in with your Google Account on TV
- add a credit card to your Google Account to purchase apps

To install a new app...

- 1 - Press **HOME**.
- 2 - Select **Google Play Store** and press **OK**.
- 3 - Select the app you want to install and press **OK**.
- 4 - To close the **Google Play Store**, press **← BACK** repeatedly or press **TV EXIT**.

### Parental controls

In the **Google Play™ Store**, you can hide apps according to users/buyers maturity. You need to enter a PIN code to select or change the level of maturity.

To set the parental control...

- 1 - Press **HOME**.
- 2 - Select **Google Play Store** and press **OK**.
- 3 - Select **Settings > Parental controls**.
- 4 - Select the level of maturity you want.
- 5 - On request, enter the PIN code.
- 6 - To close the **Google Play Store**, press **← BACK** repeatedly or press **TV EXIT**.

If the App is not on your Home screen, you can add via the Apps page or by the **Add app to favourites** item on the **Favourite apps** row. Some Google Play products and features aren't available in all countries.

Find more information on [support.google.com/androidtv](https://support.google.com/androidtv)

---

## Payments

To make a payment on Google Play on TV, you must add a form of payment - a credit card (outside the United States) - to your Google Account. When you purchase a movie or TV show, you will be charged on this credit card.

To add a credit card ...

- 1 - On your computer, go to [accounts.google.com](https://accounts.google.com) and sign in with the Google Account you will use with Google Play on TV.
- 2 - Go to [wallet.google.com](https://wallet.google.com) to add a card to your Google Account.
- 3 - Enter your credit card data and accept the terms and conditions.

---

8.3

## Start or Stop an App

You can start an app from the Home screen.

To start an app...

- 1 - Press **HOME**.
- 2 - Move to **Favourite apps** row, select the app you want and press **OK**.
- 3 - To stop an app, press **← BACK** or press **TV EXIT** or stop the app with its dedicated exit/stop button.

When opening the Home screen, the background application/content playback will stop. You have to select the application or content from the Home screen to resume.

---

8.4

## Lock Apps

---

### About App Locks

You can lock apps unsuited for children. You can lock 18+ rated apps from the Philips TV Collection or set up a restricted profile in the Home menu.

#### 18+

The 18+ app lock will ask for a PIN code when you try to start an 18+ rated app. This lock is only valid for 18+ rated apps from the Philips TV Collection.

#### Restricted profile

You can set up a restricted profile for the Home menu where only the apps you allow are available. You need to enter a PIN code to set up and switch on the restricted profile.

#### Google Play Store - Maturity

In the **Google Play™ Store**, you can hide apps

according to users/buyers maturity. You need to enter a PIN code to select or change the level of maturity. The level of maturity will determine which apps are available for installation.

For more information, in **Help**, select **Keywords** and look up **Google Play Store** for more information.

---

## Lock 18+ rated apps

You can lock 18+ rated apps from the Philips TV Collection. This setting controls the 18+ setting in the Philips TV Collection Privacy Settings.

To lock 18+ rated apps...

- 1 - Press , select **All Settings** and press **OK**.
- 2 - Select **Child Lock**, select **App Lock**.
- 3 - Select **On**.
- 4 - Press **←** (left) repeatedly if necessary, to close the menu.

---

## Restricted Profile

### About Restricted Profile

You can restrict the use of certain apps by switching the TV to a restricted profile. The Home menu will only show the apps you allowed. You need a PIN code to switch out of the restricted profile.

With the TV switched to a restricted profile you cannot...

- Find or open apps which are marked as Not allowed
- Access the **Google Play™ Store**
- Purchase through Google Play Movies & TV, nor Google Play Games
- Use third-party apps that don't use the Google sign-in

With the TV switched to a restricted profile you can...

- Watch content already rented or purchased from Google Play Movies & TV
- Play games already purchased and installed from Google Play Games
- Access the following settings: Wi-Fi network, Speech and Accessibility
- Add Bluetooth accessories

The Google Account on TV will stay logged in. Using a restricted profile doesn't change the Google Account.

---

### Set Up

To set up the restricted profile...

- 1 - Press , select **All Settings** and press **OK**.
- 2 - Select **Android Settings** and press **OK**.
- 3 - Press **▼** (down) and

select **Personal > Security & restrictions** and press **OK**.

4 - Select **Restricted Profile** and press **OK**.

5 - Select **Settings** and press **OK**.

6 - Enter a PIN code with the remote control.

7 - Select **Allowed apps** and press **OK**.

8 - In the list of available apps, select an app and press **OK** to allow or not allow this app.

9 - Press **← BACK** to go back one step or

press  **EXIT** to close the menu.

Now you can enter the restricted profile.

With the PIN code, you can always change the PIN code or edit the list of allowed or not allowed apps.

---

### Enter

To enter (switch to) the restricted profile...

1 - Press , select **All Settings** and press **OK**.

2 - Select **Android Settings** and press **OK**.

3 - Press **▼** (down) and

select **Personal > Security & restrictions** and press **OK**.

4 - Select **Enter restricted profile** and press **OK**.

5 - Enter a PIN code with the remote control.

6 - Press **← BACK** to go back one step or

press  **EXIT** to close the menu.

You can see when a restricted profile is entered if an icon appears in the Home screen. Scroll down to  **Settings** and scroll to the far right.

---

### Delete

To delete the restricted profile...

1 - Press , select **All Settings** and press **OK**.

2 - Select **Android Settings** and press **OK**.

3 - Press **▼** (down) and

select **Personal > Security & restrictions** and press **OK**

4 - Select **Delete restricted profile** and press **OK**.

5 - Enter the PIN code. The TV will delete the restricted profile.

---



## 8.5

## Manage Apps

If you stop an app and return to the Home menu, the app is not really stopped. The app is still running in the background to be readily available when you start it again. To run fluently, most apps need to save some data in the cache memory of the TV. It might be good to stop an app completely or clear the cache data of a particular app to optimise the overall performance of apps and to keep memory usage low on your Android TV. Also, it is best to uninstall apps that you

are not using anymore.

To open the list of downloaded and system apps...

- 1 - Press , select **All Settings** and press **OK**.
- 2 - Select **Android Settings** and press **OK**.
- 3 - Select **Device > Apps** and press **OK**.
- 4 - Select an app and press **OK**. If the app is still running, you can force it to stop or you can clear the cache data. You can uninstall apps you downloaded.
- 5 - Press  **BACK** to go back one step or press  **EXIT** to close the menu.

If you are using a USB Hard Drive to store apps, you can move the app from the USB Hard Drive to the TV memory or vice versa.



---

8.6

## Storage

You can see how much storage space - the internal TV memory - you are using for your apps, videos, music, etc. You can see how much free space you still have available for installing new apps. Check your storage if apps start to run slow or in case of app trouble.

To see how much storage you are using...

- 1 - Press , select **All Settings** and press **OK**.
- 2 - Select **Android Settings** and press **OK**.
- 3 - Select **Device > Storage & reset** and press **OK**.
- 4 - View the storage usage of the TV memory.
- 5 - Press  **BACK** to go back one step or press  **EXIT** to close the menu.

### USB Hard Drive

If you connect a USB Hard Drive, you can use the drive to extend the TV memory to store more apps. The TV will try to store new apps on the USB Hard Drive first. Some apps do not allow to be stored on a USB Hard Drive.

### Free up storage space

When the TV shows "Storage space is low..." message, please go to  **HOME > Settings > Manage apps** to free up the storage space by removing some apps or by storing apps on an external storage.

---

# Internet

---





## 9.1

### Start Internet

You can browse the Internet on your TV. You can view any Internet website but most of them are not prepared for a TV screen.

- Some plug-ins (e.g. to view pages or videos) are not available on your TV.
- You cannot send or download files.
- Internet pages are shown one page at a time and full screen.

To start the Internet browser...

- 1 - Press  HOME.
- 2 - Select **Apps > Internet Browser** and press **OK**.
- 3 - Enter an Internet address and select , press **OK**.
- 4 - To close Internet, press  HOME or  EXIT.

\* Note: If **Internet Browser** is not on your **Favourite apps row**, you can press **+** icon on the end of channel to add the app.

---

## 9.2

### Options on Internet

Some extras are available for the Internet.

To open the extras...

- 1 - With the website open, press **+** **OPTIONS**.
- 2 - Select one of the items and press **OK**.
- 3 - Press **◀** (left) repeatedly if necessary, to close the menu.

#### Enter Address

To enter a new Internet address.

#### Show Favourites

To view the pages you marked as favourites.

#### Reload Page

To load the Internet page again.

#### Zoom Page

Use the slider bar to set the zoom percentage.

#### Security Info

To view the security level of the current page.

#### Mark as Favourite

To mark the current page as a favourite.

#### Subtitles

# TV Menu

---

## About TV Menu

If the TV cannot be connected with the Internet, you can use the **TV Menu** as your Home menu.

In the TV Menu, you will find every TV function.

---

## Open TV Menu

To open TV Menu and open an item...

- 1 - Press  to open TV Menu.
- 2 - Select an item and press **OK** to open or start it.
- 3 - Press **← BACK** to close TV Menu without starting anything.



# Sources

## 11.1

### Switch to a device

From the list of Sources, you can switch to any of the connected devices. You can switch to a tuner to watch TV, open the content of a connected USB Flash Drive or see the recordings you made on a connected USB Hard Drive. You can switch to your connected devices to watch their programme, a digital receiver or a Blu-ray Disc player.

To switch to a connected device...

- 1 - Press  **SOURCES** to open the Sources menu.
- 2 - Select one of the item in the source list and press **OK**. The TV will show the programme or content of the device.
- 3 - Press  **SOURCES** again to close the menu.

#### One Touch Play

With the TV in standby, you can switch on a disc player with your TV remote control.

To switch on both disc player and TV from standby and start playing the disc immediately, press  (play) on the TV remote control. The device must be connected with an HDMI cable and both TV and device must have HDMI CEC switched on.

## 11.2

### Options for a TV Input

Some TV input devices offer specific settings.

To set the options for a specific TV input...

- 1 - Press  **SOURCES**.
- 2 - Select the TV input in the list and press **OK**.
- 3 - Press **+ OPTIONS**. You can set the options for the selected TV input here.
- 4 - Press **+ OPTIONS** again to close the Options menu.

Possible options...

#### Controls

With this option you can operate the connected device with the TV remote control. The device must be connected with an HDMI cable and both TV and device must have HDMI CEC switched on.

#### Device Info

Open this option to view information on the connected device.

### Device Name and Type

When you connect a new device to the TV and the TV detects the device, you can assign an icon that fits the device type. If you connect a device with an HDMI cable and HDMI CEC, the TV detects the device type automatically and the device gets an appropriate icon.

The device type determines picture and sound styles, resolution values, specific settings or the position within the Sources menu. You don't have to worry about the ideal settings.

#### Rename or Change Type

You can always change the name or change the type of a connected device. Look for the **+** icon at the right of the device name in the Sources menu. Some TV input sources do not allow a name change.

#### To change the device type...

- 1 - Select the device in the Sources menu.
- 2 - Press **+ OPTIONS**.
- 3 - Press **← BACK** to hide the onscreen keyboard.
- 4 - Press **▼ (down)** to find all available device types. Select the type you want and press **OK**.
- 5 - If you want to reset the type of the device to the original connector type, select **Reset** and press **OK**.
- 6 - Select **Close** and press **OK** to close this menu.

#### To change the device name...

- 1 - Select the device in the Sources menu.
- 2 - Press **+ OPTIONS**.
- 3 - Press **← BACK** to hide the on-screen keyboard.
- 4 - Use the keyboard on the back of the remote control to delete the current name and enter a new one.
- 5 - If you want to reset the name of the device to the original connector name, select **Reset** and press **OK**.
- 6 - Select **Close** and press **OK** to close this menu.

## 11.4

### Computer

If you connect a computer, we advice you to give the connection, on which the computer is connected, the correct device type name in the Source menu. If you then switch to **Computer** in the Source menu, the TV is set to the ideal Computer setting automatically.

To set the TV to the ideal setting...

- 1 - Press , select **All Settings** and press **OK**.
- 2 - Select **Picture** and press **➤ (right)** to enter the menu.
- 3 - Select **Advanced > Computer**.



4 - Select On or Off.

5 - Press ◀ (left) repeatedly if necessary, to close the menu.



# Settings

## 12.1

### Frequent Settings

The most frequently used settings are bundled in the **Frequent Settings** menu.

To open the menu...

- 1 - Press .
- 2 - Select the setting you want to adjust and press **OK**.
- 3 - Press  **BACK**, if you do not want to change anything.



## 12.2

### Picture

#### Picture Style

##### Select a Style

For easy picture adjustment, you can select a preset Picture Style.

- 1 - While watching a TV channel, press .
- 2 - Select **Picture Style**, and select one of the styles in the list.
- 3 - Press  (left) repeatedly if necessary, to close the menu.

The available styles are...

- **Personal** - The picture preferences you set during the first start up.
- **Vivid** - Ideal for daylight viewing
- **Natural** - Natural picture settings
- **Standard** - Most energy conscious setting - Factory setting
- **Movie** - Ideal for watching movies
- **Photo** - Ideal for viewing photos
- **Game** - Ideal for gaming
- **ISF Day** - For ISF Calibration
- **ISF Night** - For ISF Calibration

The styles for HDR content are...

- HDR Personal
- HDR Vivid
- HDR Natural
- HDR Standard
- HDR Movie
- HDR Photo
- ISF Day
- ISF Night
- HDR Game

#### Customise a Style

Any picture setting you adjust, like Colour or Contrast, is stored in the currently selected **Picture Style**. It allows you to customise each style.



Only the style **Personal** can save its settings for each source in the Sources menu.

#### Restore a Style

With a Picture Style selected, you can adjust any picture setting in **All Settings > Picture...**

The selected style will store the changes you made. We recommend to adjust the picture settings for the style **Personal** only. The Picture Style - Personal can save its settings for each individual source in Sources menu.



To restore the style to its original setting...

- 1 - While watching a TV channel, press .
- 2 - Select **Picture Style**, and select the Picture Style you want to restore.
- 3 - Press the colour key  **Restore style**, and select **OK**. The style is restored.
- 4 - Press  (left) repeatedly if necessary, to close the menu.

#### Home or Shop

If the **Picture Style** is switched back to **Vivid** every time you switch on the TV, the TV location is set to **Shop**. A setting meant for in-store promotion.

To set the TV for Home use...







- 1 - Press , select **All Settings** and press **OK**.
- 2 - Select **General Settings** and press  (right) to enter the menu.
- 3 - Select **Location > Home**.
- 4 - Press  (left) repeatedly if necessary, to close the menu.

#### Picture Settings

##### Colour

With **Colour**, you can adjust the colour saturation of the picture.

To adjust the colour...

- 1 - Press , select **All Settings** and press **OK**.
- 2 - Select **Picture** and press  (right) to enter the menu.
- 3 - Select **Colour** and press  (right).
- 4 - Press the arrows  (up) or  (down) to adjust the value.
- 5 - Press  (left) repeatedly if necessary, to close the menu.

---

## Contrast

With **Contrast**, you can adjust the contrast of the picture.

To adjust the contrast...

- 1 - Press , select **All Settings** and press **OK**.
- 2 - Select **Picture** and press **➤** (right) to enter the menu.
- 3 - Select **Contrast** and press **➤** (right).
- 4 - Press the arrows **▲** (up) or **▼** (down) to adjust the value.
- 5 - Press **◀** (left) repeatedly if necessary, to close the menu.

---

## Sharpness

With **Sharpness**, you can adjust the level of sharpness in fine detail of the picture.

To adjust the sharpness...

- 1 - Press , select **All Settings** and press **OK**.
- 2 - Select **Picture** and press **➤** (right) to enter the menu.
- 3 - Select **Sharpness** and press **➤** (right).
- 4 - Press the arrows **▲** (up) or **▼** (down) to adjust the value.
- 5 - Press **◀** (left) repeatedly if necessary, to close the menu.

---

## Brightness

With **Brightness**, you can set the level of brightness of the picture signal.

To adjust the sharpness...

- 1 - Press , select **All Settings** and press **OK**.
- 2 - Select **Picture** and press **➤** (right) to enter the menu.
- 3 - Select **Brightness** and press **➤** (right).
- 4 - Press the arrows **▲** (up) or **▼** (down) to adjust the value.
- 5 - Press **◀** (left) repeatedly if necessary, to close the menu.

---

## Advanced Picture Settings

---

### Computer

If you connect a computer, we advise you to give the connection, on which the computer is connected, the correct device type name in the Source menu. If you then switch to **Computer** in the Source menu, the TV is set to the ideal Computer setting automatically.

To set the TV to the ideal setting...

- 1 - Press , select **All Settings** and press **OK**.

2 - Select **Picture** and press **➤** (right) to enter the menu.

3 - Select **Advanced > Computer**.

4 - Select **On** or **Off**.

5 - Press **◀** (left) repeatedly if necessary, to close the menu.

---

## Colour Settings

---

### Colour Enhancement

With **Colour Enhancement**, you can enhance the colour intensity and the details in bright colours.

To adjust the level...

- 1 - Press , select **All Settings** and press **OK**.
- 2 - Select **Picture** and press **➤** (right) to enter the menu.
- 3 - Select **Advanced > Colour > Colour Enhancement**.
- 4 - Select **Maximum**, **Medium**, **Minimum** or **Off**.
- 5 - Press **◀** (left) repeatedly if necessary, to close the menu.

---

### Colour Temperature

With **Colour Temperature**, you can set the picture to a preset colour temperature or select **Custom** to set a temperature setting yourself with **Custom Colour Temperature**. Colour Temperature and Custom Colour Temperature are settings intended for expert users.

To select a preset...

- 1 - Press , select **All Settings** and press **OK**.
- 2 - Select **Picture** and press **➤** (right) to enter the menu.
- 3 - Select **Advanced > Colour > Colour Temperature**.
- 4 - Select **Normal**, **Warm** or **Cool**. Or select **Custom** if you want to customise a colour temperature yourself.
- 5 - Press **◀** (left) repeatedly if necessary, to close the menu.

---

### Custom Colour Temperature

With **Custom Colour Temperature**, you can set a colour temperature yourself. To set a custom colour temperature, first select **Custom** in the Colour Temperature menu. Custom Colour Temperature is a setting intended for expert users.

To set a custom colour temperature...

- 1 - Press , select **All Settings** and press **OK**.
- 2 - Select **Picture** and press **➤** (right) to enter the menu.

- 3 - Select **Advanced > Colour > Custom Colour Temperature**.
- 4 - Press the arrows **▲** (up) or **▼** (down) to adjust the value. WP is white point and BL is black level. You can also select one of the presets in this menu.
- 5 - Press **◀** (left) repeatedly if necessary, to close the menu.

---

## Colour Control Settings

---

### ISF Colour Control

With **ISF Colour Control**, an ISF expert can calibrate the colour reproduction of the TV. Colour Control is an ISF expert setting.

Get the most out of your TV display with **ISF® Calibration**. Ask a ISF calibration expert to come to your home and set the TV to the most optimal picture setting. Additionally the expert can set an ISF Calibration for Ambientlight.  
Ask your dealer for an ISF Calibration.

Calibration benefits are...

- better picture clarity and sharpness
- better detail in bright and dark parts
- deeper and darker blacks
- better colour purity and quality
- reduced energy consumption

The ISF Calibration expert stores and locks the ISF settings as 2 picture styles.

When the ISF Calibration is done, press **⚙** and select **Picture Style** and select **ISF Day** or **ISF Night**. Select **ISF Day** to watch TV during bright light conditions or select **ISF Night** when it's dark.

---

## Hue

To adjust **Hue** value...

- 1 - Press **⚙**, select **All Settings** and press **OK**.
- 2 - Select **Picture** and press **▶** (right) to enter the menu.
- 3 - Select **Advanced > Colour > Colour control**.
- 4 - Select **Hue**, and press **▶** (right).
- 5 - Press the arrows **▲** (up) or **▼** (down) to adjust the value.
- 6 - Press **◀** (left) repeatedly if necessary, to close the menu.

---

## Saturation

To adjust **Saturation** value...

- 1 - Press **⚙**, select **All Settings** and press **OK**.
- 2 - Select **Picture** and press **▶** (right) to enter the menu.

- 3 - Select **Advanced > Colour > Colour control**.
- 4 - Select **Saturation**, and press **▶** (right).
- 5 - Press the arrows **▲** (up) or **▼** (down) to adjust the value.
- 6 - Press **◀** (left) repeatedly if necessary, to close the menu.

---

## Reset All

With **Reset All**, you can reset all value to default.

To reset all value in **Colour Control** menu...

- 1 - Press **⚙**, select **All Settings** and press **OK**.
- 2 - Select **Picture** and press **▶** (right) to enter the menu.
- 3 - Select **Advanced > Colour > Colour control**.
- 4 - Select **Reset All**.
- 5 - Press **◀** (left) repeatedly if necessary, to close the menu.

---

## ISF RGB Only Mode

**RGB Only Mode** is an ISF expert setting to switch to RGB colours. To adjust values in **RGB Only Mode** menu, first set **ISF Day** or **ISF Night** in the **Picture Style** menu.

To adjust **RGB Only Mode** value...

- 1 - Press **⚙**, select **All Settings** and press **OK**.
- 2 - Select **Picture** and press **▶** (right) to enter the menu.
- 3 - Select **Advanced > Colour > RGB Only Mode**.
- 4 - Select **Red**, **Green**, **Blue**, or **Off** to turn off RGB mode.
- 5 - Press **◀** (left) repeatedly if necessary, to close the menu.

---

## Contrast Settings

### Contrast Modes

With **Contrast Mode**, you can set the level at which power consumption can be reduced by dimming the intensity of the screen. Choose for the best power consumption or for the picture with the best intensity.

To adjust the level...

- 1 - Press **⚙**, select **All Settings** and press **OK**.
- 2 - Select **Picture** and press **▶** (right) to enter the menu.
- 3 - Select **Advanced > Contrast > Contrast Mode**.
- 4 - Select **Standard**, **Best Power**, **Best Picture**, or **Off**.
- 5 - Press **◀** (left) repeatedly if necessary, to close the menu.

---

## HDR Upscaling

With **HDR upscaling** you can boost the brightness and contrast of the picture. The picture is much brighter and has a higher level of contrast between lighter and darker parts. **HDR upscaling** keeps colours rich and saturated. You can switch **HDR upscaling** on or off.

If you are watching HDR programmes – programmes recorded in HDR – there is no need to upscale to HDR and the setting **HDR upscaling** is unavailable. The TV can play HDR programmes from a HDMI connection, from an Internet source or from a connected USB memory device.

To switch HDR upscaling on or off...

- 1 - Press , select **All Settings** and press **OK**.
- 2 - Select **Picture** and press **➤** (right) to enter the menu.
- 3 - Select **Advanced > Contrast > HDR Upscaling**.
- 4 - Select **On** or **Off**.
- 5 - Press **◀** (left) repeatedly if necessary, to close the menu.

---

## Perfect Contrast

With **Perfect Contrast**, you can set the level at which the TV automatically enhances the details in the dark, middle and light areas of the picture.

To adjust the level...

- 1 - Press , select **All Settings** and press **OK**.
- 2 - Select **Picture** and press **➤** (right) to enter the menu.
- 3 - Select **Advanced > Contrast > Perfect Contrast**.
- 4 - Select **Maximum**, **Medium**, **Minimum** or **Off**.
- 5 - Press **◀** (left) repeatedly if necessary, to close the menu.

---

## Video Contrast

With **Video Contrast**, you can decrease the range of the video contrast.

To adjust the level...

- 1 - Press , select **All Settings** and press **OK**.
- 2 - Select **Picture** and press **➤** (right) to enter the menu.
- 3 - Select **Advanced > Contrast > Video Contrast**.
- 4 - Press the arrows **▲** (up) or **▼** (down) to adjust the value.
- 5 - Press **◀** (left) repeatedly if necessary, to close the menu.

---

## Light Sensor

The **Light Sensor** adjusts the picture settings automatically to the lighting conditions of the room. You can switch **Light Sensor** on or off.

To switch on or off...

- 1 - Press , select **All Settings** and press **OK**.
- 2 - Select **Picture** and press **➤** (right) to enter the menu.
- 3 - Select **Advanced > Contrast > Light Sensor**.
- 4 - Select **On** or **Off**.
- 5 - Press **◀** (left) repeatedly if necessary, to close the menu.

---

## Gamma

With **Gamma**, you can set a non-linear setting for picture luminance and contrast. Gamma is a setting intended for expert users.

To adjust the level...

- 1 - Press , select **All Settings** and press **OK**.
- 2 - Select **Picture** and press **➤** (right) to enter the menu.
- 3 - Select **Advanced > Contrast > Gamma**.
- 4 - Press the arrows **▲** (up) or **▼** (down) to adjust the value.
- 5 - Press **◀** (left) repeatedly if necessary, to close the menu.

---

## Sharpness Settings

---

### Ultra Resolution

With **Ultra Resolution**, you switch on a superior sharpness in line edges and contours.

To switch on or off...

- 1 - Press , select **All Settings** and press **OK**.
- 2 - Select **Picture** and press **➤** (right) to enter the menu.
- 3 - Select **Advanced > Sharpness > Ultra Resolution**.
- 4 - Select **On** or **Off**.
- 5 - Press **◀** (left) repeatedly if necessary, to close the menu.

---

### Noise Reduction

With **Noise Reduction**, you can filter out and reduce the level of image noise.

To adjust the noise reduction...

- 1 - Press , select **All Settings** and press **OK**.
- 2 - Select **Picture** and press **➤** (right) to enter the menu.

3 - Select **Advanced > Sharpness > Noise Reduction**.

4 - Select **Maximum, Medium, Minimum or Off**.

5 - Press **◀** (left) repeatedly if necessary, to close the menu.

---

## MPEG Artefact Reduction

With **MPEG Artefact Reduction**, you can smoothen the digital transitions in the picture. MPEG artefacts are mostly visible as small blocks or jagged edges in images.

To reduce the MPEG artefacts...

1 - Press **⚙**, select **All Settings** and press **OK**.

2 - Select **Picture** and press **▶** (right) to enter the menu.

3 - Select **Advanced > Sharpness > MPEG Artefact Reduction**.

4 - Select **Maximum, Medium, Minimum or Off**.

5 - Press **◀** (left) repeatedly if necessary, to close the menu.

---

## Motion Settings

### Perfect Natural Motion

With **Perfect Natural Motion**, you can reduce the motion judder, visible in movies on TV. Perfect Natural Motion makes any movement smooth and fluent.

To adjust the motion judder...

1 - Press **⚙**, select **All Settings** and press **OK**.

2 - Select **Picture** and press **▶** (right) to enter the menu.

3 - Select **Advanced > Motion > Perfect Natural Motion**.

4 - Select **Maximum, Medium, Minimum or Off**.

5 - Press **◀** (left) repeatedly if necessary, to close the menu.

---

### Clear LCD

With **Clear LCD**, you switch on a superior motion sharpness, better black level, high contrast with a flicker-free, quiet image and a larger viewing angle.

To switch on or off...

1 - Press **⚙**, select **All Settings** and press **OK**.

2 - Select **Picture** and press **▶** (right) to enter the menu.

3 - Select **Advanced > Motion > Clear LCD**.

4 - Select **On or Off**.

5 - Press **◀** (left) repeatedly if necessary, to close the menu.

---

## Picture Format

---

### Basic

If the picture is not filling the whole screen, if black bars are showing on the top or bottom or at both sides, you can adjust the picture to fill the screen completely.

To select one of the basic settings to fill the screen...

1 - While watching a TV channel, press **⏏** (if available on your remote control) or press **⚙**.

2 - Select **Picture Format > Fill Screen, Fit to Screen or Wide Screen**.

3 - Press **◀** (left) repeatedly if necessary, to close the menu.

- **Fill Screen** – automatically enlarges the picture to fill the screen. Picture distortion is minimal, subtitles remain visible. Not suitable for PC input. Some extreme picture formats can still show black bars.

- **Fit to Screen** – automatically zooms in the picture to fill the screen without distortion. Black bars may be visible. Not suitable for PC input.

- **Wide Screen** – automatically zooms in the picture to wide screen.

---

### Advanced

If the two basic settings are inadequate to format the picture you want, you can use the advanced settings. With the advanced settings you manually format the picture on your screen.

You can zoom, stretch and shift the picture until it shows what you need – e.g. missing subtitles or scrolling text banners. If you format the picture for a specific Source – like a connected game console – you can return to this setting the next time you use the game console. The TV stores the last setting you did for each connection.

To format the picture manually...

1 - While watching a TV channel, press **⏏** (if available on your remote control) or press **⚙**.

2 - Select **Advanced** and press **OK**.

3 - Use **Shift, Zoom, Stretch or Original** to adjust the picture.

4 - Alternatively, select **Last Setting** and

press **OK** to switch to the format you stored before.

5 - Or select **Undo** to return to the setting the picture had when you opened **Picture Format**.

- **Shift** – Select on the arrows to shift the picture. You can only shift the picture when it is zoomed in.

- **Zoom** – Select on the arrows to zoom in.

- **Stretch** – Select on the arrows to stretch the picture vertically or horizontally.

- **Undo** – Select to return to the picture format you started with.

- **Original** – Shows the original format of the

incoming picture. This is a 1:1 pixel on pixel format. Expert mode for HD and PC input.

---

## Quick Picture Setting

During the first installation, you did some picture settings in a few easy steps. You can redo these steps with **Quick Picture Setting**. To do these steps, make sure the TV can tune to a TV channel or can show a programme from a connected device.

To set the picture in a few easy steps...

- 1 - Press **⚙️**, select **All Settings** and press **OK**.
- 2 - Select **Picture** and press **➤** (right) to enter the menu.
- 3 - Select **Quick Picture Setting**.
- 4 - Select **Start**. Use the navigation keys to select your choice.
- 5 - Finally, select **Finish**.
- 6 - Press **◀** (left) repeatedly if necessary, to close the menu.

---

12.3

## Sound

---

### Sound Style

#### Select a Style

For easy sound adjustment, you can select a preset setting with Sound Style.

- 1 - While watching a TV channel, press **⚙️**.
- 2 - Select **Sound** and press **➤** (right) to enter the menu.
- 3 - Select **Sound Style**, and select one of the styles in the list.
- 4 - Press **◀** (left) repeatedly if necessary, to close the menu.

The available styles are...

- **Personal** - The sound preferences you set during the first start up.
- **Original** - Most neutral sound setting
- **Movie** - Ideal for watching movies
- **Music** - Ideal for listening to music
- **Game** - Ideal for gaming
  
- **News** - Ideal for speech

---

#### Restore a Style

With a Sound Style selected, you can adjust any sound setting in **Setup > Sound...**

The selected style will store the changes you made. We recommend to adjust the sound settings for the

style **Personal** only. The Sound Style - Personal can save its settings for each individual source in Sources menu.

To restore the style to its original setting...

- 1 - While watching a TV channel, press **⚙️**.
- 2 - Select **Sound** and press **➤** (right) to enter the menu.
- 3 - Select **Sound Style**, and select the Sound Style you want to restore.
- 4 - Select **Restore Style**. The style is restored.
- 5 - Press **◀** (left) repeatedly if necessary, to close the menu.

---

## Sound Settings

### Bass

With **Bass**, you can adjust the level of low tones in the sound.

To adjust the level...

- 1 - Press **⚙️**, select **All Settings** and press **OK**.
- 2 - Select **Sound** and press **➤** (right) to enter the menu.
- 3 - Select **Bass** and press **➤** (right).
- 4 - Press the arrows **▲** (up) or **▼** (down) to adjust the value.
- 5 - Press **◀** (left) repeatedly if necessary, to close the menu.

---

### Treble

With **Treble**, you can adjust the level of high tones in the sound.

To adjust the level...

- 1 - Press **⚙️**, select **All Settings** and press **OK**.
- 2 - Select **Sound** and press **➤** (right) to enter the menu.
- 3 - Select **Treble** and press **➤** (right).
- 4 - Press the arrows **▲** (up) or **▼** (down) to adjust the value.
- 5 - Press **◀** (left) repeatedly if necessary, to close the menu.

---

### Headphone Volume

With **Headphones Volume**, you can set the volume of a connected headphone separately.

To adjust the volume...

- 1 - Press **⚙️**, select **All Settings** and press **OK**.
- 2 - Select **Sound** and press **➤** (right) to enter the menu.
- 3 - Select **Headphones Volume**.
- 4 - Press the arrows **▲** (up) or **▼** (down) to adjust

the value.

5 - Press **◀** (left) repeatedly if necessary, to close the menu.

---

### Subwoofer Volume

If you connect a wireless Bluetooth subwoofer, you can slightly increase or decrease the volume of the subwoofer.

To adjust the volume a little...

- 1 - Press **⚙️**, select **All Settings** and press **OK**.
  - 2 - Select **Sound** and press **▶** (right) to enter the menu.
  - 3 - Select **Subwoofer Volume**.
  - 4 - Press **▲** (up) or **▼** (down) to adjust the value.
  - 5 - Press **◀** (left) repeatedly if necessary, to close the menu.
- 

### Surround Mode

With **Surround Mode**, you can set the sound effect of the TV speakers.

To set the surround mode...

- 1 - Press **⚙️**, select **All Settings** and press **OK**.
  - 2 - Select **Sound** and press **▶** (right) to enter the menu.
  - 3 - Select **Surround Mode**.
  - 4 - Select **Stereo** or **Incredible Surround**.
  - 5 - Press **◀** (left) repeatedly if necessary, to close the menu.
- 

### TV Placement

As part of the first installation, this setting is set to either **On a TV stand** or **On the Wall**. If you have changed the placement of the TV since then, adjust this setting accordingly for best sound reproduction.

- 1 - Press **⚙️**, select **All Settings** and press **OK**.
  - 2 - Select **Sound** and press **▶** (right) to enter the menu.
  - 3 - Select **TV Placement**.
  - 4 - Select **On a TV stand** or **On the Wall**.
  - 5 - Press **◀** (left) repeatedly if necessary, to close the menu.
- 

## Advanced Sound Settings

### Auto Volume Levelling

With **Auto Volume Levelling**, you can set the TV to automatically level out sudden volume differences. Typically at the beginning of adverts or when you are switching channels.

To switch on or off...

- 1 - Press **⚙️**, select **All Settings** and press **OK**.
  - 2 - Select **Sound** and press **▶** (right) to enter the menu.
  - 3 - Select **Advanced** and press **▶** (right) to enter the menu.
  - 4 - Select **Auto Volume Levelling** and press **▶** (right) to enter the menu.
  - 5 - Select **On** or **Off**.
  - 6 - Press **◀** (left) repeatedly if necessary, to close the menu.
- 

### Clear Sound

With **Clear Sound**, you improve the sound for speech. Ideal for news programmes. You can switch the speech improvement on or off.

To switch on or off...

- 1 - Press **⚙️**, select **All Settings** and press **OK**.
  - 2 - Select **Sound** and press **▶** (right) to enter the menu.
  - 3 - Select **Advanced** > **Clear Sound**.
  - 4 - Select **On** or **Off**.
  - 5 - Press **◀** (left) repeatedly if necessary, to close the menu.
- 

### Audio Out Format

If you have a Home Theatre System (HTS) with multichannel sound processing capabilities like Dolby Digital, DTS® or similar, set the Audio Out Format to Multichannel. With Multichannel, the TV can send the compressed multichannel sound signal from a TV channel or connected player to the Home Theatre System. If you have a Home Theatre System without multichannel sound processing, select Stereo.

To set the Audio Out Format...

- 1 - Press **⚙️**, select **All Settings** and press **OK**.
  - 2 - Select **Sound** and press **▶** (right) to enter the menu.
  - 3 - Select **Advanced** > **Audio Out Format**.
  - 4 - Select **Multichannel** or **Stereo**.
  - 5 - Press **◀** (left) repeatedly if necessary, to close the menu.
- 

### Audio Out Levelling

Use the Audio Out Levelling setting to level the volume (loudness) of the TV and the Home Theatre System when you switch over from one to another. Volume differences can be caused by differences in sound processing.

To level the difference in volume...

- 1 - Press **⚙️**, select **All Settings** and press **OK**.



- 2 - Select **Sound** and press **➤** (right) to enter the menu.
- 3 - Select **Advanced > Audio Out Levelling**.
- 4 - If the volume difference is large, select **More**. If the volume difference is small, select **Less**.
- 5 - Press **◀** (left) repeatedly if necessary, to close the menu.

Audio Out Levelling affects both the Audio Out - Optical and HDMI ARC sound signals.

---

### Audio Out Delay

If you set an Audio sync delay on your Home Theatre System, to synchronise the sound with the picture, you must switch off **Audio Out Delay** on the TV.

To switch off Audio Out Delay...

- 1 - Press **⚙️**, select **All Settings** and press **OK**.
- 2 - Select **Sound** and press **➤** (right) to enter the menu.
- 3 - Select **Advanced > Audio Out Delay**.
- 4 - Select **Off**.
- 5 - Press **◀** (left) repeatedly if necessary, to close the menu.

---

### Audio Out Offset

If you cannot set a delay on the Home Theatre System, you can set a delay on the TV with **Audio Out Offset**.

To synchronise the sound on the TV...

- 1 - Press **⚙️**, select **All Settings** and press **OK**.
- 2 - Select **Sound** and press **➤** (right) to enter the menu.
- 3 - Select **Advanced > Audio Out Offset**.
- 4 - Use the slider bar to set the sound offset.
- 5 - Press **◀** (left) repeatedly if necessary, to close the menu.

---

### Speakers

---

#### Select your Speakers

In this menu you can switch the TV speakers on or off. If you connect a Home Theatre System or a wireless Bluetooth speaker, you can select which device is playing the TV sound. All available loudspeaker systems are shown in this list.

If you use an HDMI CEC connection for an audio device (like a Home Theatre System), you can select EasyLink Autostart. The TV will switch on the audio device, send the TV sound to the device and switch off the TV speakers.

To set the TV speakers...

- 1 - Press **⚙️**, select **All Settings** and press **OK**.
- 2 - Select **Sound** and press **➤** (right) to enter the menu.
- 3 - Select **Advanced** and press **➤** (right) to enter the menu.
- 4 - Select **Speakers** and press **➤** (right) to enter the menu.
- 5 - Select **On, Off, or EasyLink Autostart**.
- 6 - Press **◀** (left) repeatedly if necessary, to close the menu.

---

12.4

## Ambilight Settings

---

### Ambilight Style

For more information, in **Help**, select **Keywords** and look up **Ambilight Style**.

---

### Ambilight Settings

---

#### Ambilight Brightness

With Ambilight **Brightness**, you can set the level of brightness of the Ambilight.

To adjust the level...

- 1 - Press **⚙️**, select **All Settings** and press **OK**.
- 2 - Select **Ambilight** and press **➤** (right) to enter the menu.
- 3 - Select **Brightness**.
- 4 - Press the arrows **▲** (up) or **▼** (down) to adjust the value.
- 5 - Press **◀** (left) repeatedly if necessary, to close the menu.

---

#### Brightness Bottom Side

You can set the level of brightness of the Ambilight at the bottom of the TV. A white table surface might reflect the Ambilight too much.

To adjust the level...

- 1 - Press **⚙️**, select **All Settings** and press **OK**.
- 2 - Select **Ambilight** and press **➤** (right) to enter the menu.
- 3 - Select **Brightness Bottom Side**.
- 4 - Press the arrows **▲** (up) or **▼** (down) to adjust the value.
- 5 - Press **◀** (left) repeatedly if necessary, to close the menu.

---

## Ambilight Saturation

With **Ambilight Saturation**, you can set the level of colour saturation of the Ambilight.

To adjust the level...

- 1 - Press **⚙️**, select **All Settings** and press **OK**.
- 2 - Select **Ambilight** and press **➤** (right) to enter the menu.
- 3 - Select **Saturation**.
- 4 - Press the arrows **▲** (up) or **▼** (down) to adjust the value.
- 5 - Press **◀** (left) repeatedly if necessary, to close the menu.

---

## Advanced Ambilight Settings

### Wall Colour

With **Wall Colour**, you can neutralise the influence of a coloured wall on the Ambilight colours. Select the colour of the wall behind the TV and the TV will modify the Ambilight colours to appear as they are intended.

To select the colour of the wall . . .

- 1 - Press **⚙️**, select **All Settings** and press **OK**.
- 2 - Select **Ambilight** and press **➤** (right) to enter the menu.
- 3 - Select **Advanced > Wall Colour**.
- 4 - In the colour palette, select the colour that matches the colour of the wall behind the TV.
- 5 - Press **◀** (left) repeatedly if necessary, to close the menu.

---

### TV Switch Off

With **TV Switch Off**, you can set Ambilight to switch off immediately or slowly fade out when you switch off the TV. The slow fade out gives you some time to switch on the lights in your living room.

To select the way how Ambilight switches off...

- 1 - Press **⚙️**, select **All Settings** and press **OK**.
- 2 - Select **Ambilight** and press **➤** (right) to enter the menu.
- 3 - Select **Advanced > TV Switch Off**.
- 4 - Select **Fade Out to Off** or **Immediate Switch Off**.
- 5 - Press **◀** (left) repeatedly if necessary, to close the menu.

---

### ISF Tuning

When an ISF expert calibrates the TV, a static Ambilight colour can be calibrated. You can select any colour you want to calibrate. With the ISF

Calibration done, you can select the static ISF colour.

To select the ISF static colour...

Press **Ⓞ** (Ambilight) and select **ISF** and press **OK**.

To adjust the ISF tuning...

- 1 - Press **⚙️**, select **All Settings** and press **OK**.
- 2 - Select **Ambilight** and press **➤** (right) to enter the menu.
- 3 - Select **Advanced > ISF Tuning**.
- 4 - Press **◀** (left) repeatedly if necessary, to close the menu.

To reset the ISF tuning...

- 1 - Press **⚙️**, select **All Settings** and press **OK**.
- 2 - Select **Ambilight** and press **➤** (right) to enter the menu.
- 3 - Select **Advanced > Reset ISF Settings**.
- 4 - Press **◀** (left) repeatedly if necessary, to close the menu.

---

## Ambilight + Hue

---

### Configure

#### Step 1 - Network

In this first step, you will prepare the TV to find the **Philips Hue Bridge**. The TV and the Philips Hue Bridge must use the same network.

Setting up...

- 1 - Connect the Philips Hue Bridge to the power outlet.
- 2 - Connect the Philips Hue Bridge to the same router you are using for the TV — use an Ethernet cable to connect.
- 3 - Switch on the Hue bulbs.

To start the configuration...

- 1 - Press **⚙️**, select **All Settings** and press **OK**.
- 2 - Select **Ambilight > Ambilight+hue**.
- 3 - Select **Configure**.
- 4 - Select **Start** and press **OK**. The TV will search for the Philips Hue Bridge. If the TV is not yet connected to your network, the TV will start the network setup first. If the Philips Hue Bridge appears in the list ...

go to Step 2 - Hue Bridge.

For more info on connecting the TV to your home network, in **Help**, select **Keywords** and look up **Network, wireless**.

---

## Step 2 - Hue Bridge

In the next step, you will link up the TV with the **Philips Hue Bridge**. The TV can only be linked up to one Hue Bridge.

To link the Hue Bridge...

1 - With the TV connected to your home network, it will show the available Hue Bridges. If the TV did not find your Hue Bridge yet, you can select **Scan again** and press **OK**.

If the TV found the only Hue Bridge you have, select the Hue Bridge name and press **OK**.

If you have more than one Hue Bridge available, select the Hue Bridge you want to use and press **OK**.

2 - Select **Start** and press **OK**.

3 - Now go to the **Philips Hue Bridge** and press the link button in the middle of the device. This will link the Hue Bridge with the TV. Do this within 30 seconds. The TV will confirm if a Hue Bridge is now linked to the TV.

4 - Select **OK** and press **OK**.

With the Philips Hue bridge linked to the TV, go to page **Hue bulbs**.

---

## Step 3 - Hue Bulbs

In the next step, you will select the **Philips Hue bulbs** that have to follow the Ambilight. You can select a maximum of 9 Philips Hue bulbs for Ambilight+hue.

To select the bulbs for Ambilight+hue...

1 - In the list, mark the bulbs that have to follow the Ambilight. To mark a bulb, select the bulb name and press **OK**. When you mark a bulb, the bulb will blink once.

2 - When you're done, select **OK** and press **OK**.

---

## Step 4 - Configure Bulb

In the following step, you will configure each **Philips Hue bulb**.

To configure each Hue bulb...

1 - Select a bulb to configure and press **OK**. The bulb you selected is flashing.

2 - Select **Start** and press **OK**.

3 - First indicate where you placed the bulb relative to the TV. A correct setting of the **Angle** will send the correct Ambilight colour to the bulb. Select the slider bar to adjust the position.

4 - Secondly, indicate the **Distance** between the bulb and the TV. The further away from the TV, the weaker the Ambilight colour. Select the slider bar to adjust the distance.

5 - Finally, set the **Brightness** of the bulb. Select the slider bar to adjust the brightness.

6 - To stop configuring this bulb, select **OK** and press **OK**.

7 - In the **Configure Ambilight+hue** menu, you can do the same for each bulb.

8 - When all Ambilight+hue bulbs are configured, select **Finish** and press **OK**.

Ambilight+hue is ready for use.

---

## Switch Off

To switch off Ambilight+hue...

1 - Press **⚙️**, select **All Settings** and press **OK**.

2 - Select **Ambilight** and press **➤** (right) to enter the menu.

3 - Select **Ambilight+hue**.

4 - Select **Off** or **On**.

5 - Press **⬅** (left) repeatedly if necessary, to close the menu.

---

## Immersion

With **Immersion**, you can adjust how accurate the Hue bulbs follow the Ambilight.

To adjust Ambilight+hue immersion...

1 - Press **⚙️**, select **All Settings** and press **OK**.

2 - Select **Ambilight** and press **➤** (right) to enter the menu.

3 - Select **Ambilight+hue > Immersion**.

4 - Press the arrows **⬆** (up) or **⬇** (down) to adjust the value.

5 - Press **⬅** (left) repeatedly if necessary, to close the menu.

---

## Lounge Light+hue

If you installed Ambilight+hue, you can let the hue bulbs follow Lounge Light from Ambilight. The Philips hue lamps will expand the Lounge Light effect across the room. The hue bulbs are switched on and automatically set to follow Lounge Light when you configure Ambilight+hue. If you do not want the hue bulbs to follow Lounge Light, you can switch the bulbs off.

To switch the hue bulbs off...

1 - Press **⚙️**, select **All Settings** and press **OK**.

2 - Select **Ambilight** and press **➤** (right) to enter the menu.

3 - Select **Ambilight+hue > Lounge Light+hue**.

4 - Select **Off**.

5 - Press **⬅** (left) repeatedly if necessary, to close the menu.

---

## View Configuration

With **View Configuration**, you can view current setup of the Ambilight+hue, network, the Bridge and bulbs.

To view Ambilight+hue configuration...

- 1 - Press , select **All Settings** and press **OK**.
- 2 - Select **Ambilight** and press **➤** (right) to enter the menu.
- 3 - Select **Ambilight+hue > View Configuration**.
- 4 - Press **◀** (left) repeatedly if necessary, to close the menu.

---

## Reset Configuration

To reset Ambilight+hue...

- 1 - Press , select **All Settings** and press **OK**.
- 2 - Select **Ambilight** and press **➤** (right) to enter the menu.
- 3 - Select **Ambilight+hue > Reset Configuration**. The configuration is reset.
- 4 - Press **◀** (left) repeatedly if necessary, to close the menu

---

12.5

## Eco Settings

---

### Energy Saving

**Eco settings**  bundles the settings that help the environment.

#### Energy Saving

If you select **Energy Saving**, the TV switches to **Picture Style - Standard** automatically, the most ideal energy conscious setting for the picture.

To set the TV in **Energy Saving**...

- 1 - Press , select **All Settings** and press **OK**.
- 2 - Select **Eco Settings** and press **➤** (right) to enter the menu.
- 3 - Select **Energy Saving**, the **Picture Style** is set to **Standard** automatically.
- 4 - Press **◀** (left) repeatedly if necessary, to close the menu.

---

## Screen Off

If you only listen to music, you can switch off the TV screen to save energy.

To only switch off the TV screen...

- 1 - Press , select **All Settings** and press **OK**.
- 2 - Select **Eco Settings** and press **➤** (right) to enter the menu.

- 3 - Select **Screen Off**. The screen will switch off.
- 4 - Press **◀** (left) repeatedly if necessary, to close the menu.



To switch the screen back on, press any key on the remote control.

---

## Light Sensor

To save energy, the built-in ambient light sensor lowers the brightness of the TV screen when the surrounding light darkens. The built-in light sensor automatically adjusts the picture, together with Ambilight, to the lighting conditions of the room.

To activate the light sensor...

- 1 - Press , select **All Settings** and press **OK**.
- 2 - Select **Eco Settings** and press **➤** (right) to enter the menu.
- 3 - Select **Light Sensor**. The icon  is shown in front of **Light Sensor** when it is active.
- 4 - Press **◀** (left) repeatedly if necessary, to close the menu.

---

## Switch Off Timer

If the TV receives a TV signal but you don't press a key on the remote control during a 4 hour period, the TV switches off automatically to save energy. Also, if the TV does not receive a TV signal nor a remote control command for 10 minutes, the TV switches off automatically.

If you use the TV as a monitor or use a digital receiver to watch TV (a Set-Top Box - STB) and you do not use the remote control of the TV, you should deactivate this automatic switch off.

To deactivate the **Switch Off Timer** ...

- 1 - Press , select **All Settings** and press **OK**.
- 2 - Select **Eco Settings** and press **➤** (right) to enter the menu.
- 3 - Select **Switch Off Timer**.
- 4 - Press the arrows **▲** (up) or **▼** (down) to adjust the value. The value **0** deactivates the automatic switch off.
- 5 - Press **◀** (left) repeatedly if necessary, to close the menu.

---

12.6

## General Settings

---

## USB Hard Drive

To set up and format a USB Hard Drive...

- 1 - Press **⚙️**, select **All Settings** and press **OK**.
- 2 - Select **General Settings** and press **➤** (right) to enter the menu.
- 3 - Select **USB Hard Drive**.
- 4 - Select **Start**, then follow the instructions on screen.
- 5 - Press **◀** (left) repeatedly if necessary, to close the menu.

For more information on how to install a USB Hard Drive, in **Help**, select **Keywords** and look up **USB Hard Drive, installation** or **Installation, USB Hard Drive**.

---

## USB Keyboard Settings

To install the USB keyboard, switch on the TV and connect the USB keyboard to one of the **USB** connections on the TV. When the TV detects the keyboard for the first time, you can select your keyboard lay-out and test your selection. If you select a Cyrillic or Greek keyboard layout first, you can select a secondary Latin keyboard layout.

To change the keyboard layout setting when a layout was selected...

- 1 - Press **⚙️**, select **All Settings** and press **OK**.
- 2 - Select **General Settings** and press **➤** (right) to enter the menu.
- 3 - Select **USB Keyboard Settings** to start the keyboard setup.

---

## Philips Logo Brightness

You can switch off or adjust the brightness of the Philips logo on the front of the TV.

To adjust or switch off...

- 1 - Press **⚙️**, select **All Settings** and press **OK**.
- 2 - Select **General Settings** and press **➤** (right) to enter the menu.
- 3 - Select **Philips Logo Brightness**, and press **➤** (right) to enter the menu.
- 4 - Select **Minimum**, **Medium**, **Maximum**, or **Off** to switch off the lighting of the logo.
- 5 - Press **◀** (left) repeatedly if necessary, to close the menu.

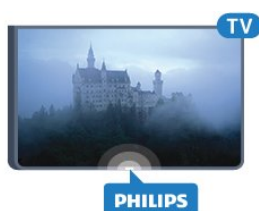

---

## Home or Shop

If the TV is installed in a shop, you can set the TV to display an in store promotion banner. **Picture Style** is set to **Vivid** automatically. **Switch Off Timer** is switched off.

To set the TV to Shop location...

- 1 - Press **⚙️**, select **All Settings** and press **OK**.
- 2 - Select **General Settings** and press **➤** (right) to enter the menu.
- 3 - Select **Location > Shop**.
- 4 - Press **◀** (left) repeatedly if necessary, to close the menu.

If you use the TV at home, set the TV in Home location.

---

## Shop Setup

If the TV is set to **Shop**, you can set the availability of a specific demo for in store use.

- 1 - Press **⚙️**, select **All Settings** and press **OK**.
- 2 - Select **General Settings** and press **➤** (right) to enter the menu.
- 3 - Select **Shop Setup** and press **➤** (right) to enter the menu.
- 4 - Change the settings according to your preference.
- 5 - Press **◀** (left) repeatedly if necessary, to close the menu.

---

## EasyLink

### EasyLink

To switch off EasyLink completely...

- 1 - Press **⚙️**, select **All Settings** and press **OK**.
- 2 - Select **General Settings** and press **➤** (right) to enter the menu.
- 3 - Select **EasyLink**, press **➤** (right) and select **EasyLink** one step further.
- 4 - Select **Off**.
- 5 - Press **◀** (left) repeatedly if necessary, to close the menu.

---

### EasyLink Remote Control

To switch off EasyLink remote control...

- 1 - Press **⚙️**, select **All Settings** and press **OK**.
- 2 - Select **General Settings** and press **➤** (right) to enter the menu.
- 3 - Select **EasyLink > Easylink Remote Control**.
- 4 - Select **Off**.
- 5 - Press **◀** (left) repeatedly if necessary, to close

the menu.

---

## HDMI Ultra HD

This TV can display Ultra HD signals. Some devices - connected with HDMI - do not recognise a TV with Ultra HD and might not work correctly or show distorted picture or sound. To avoid the malfunctioning of such a device, you can set the signal quality to a level the device can handle. If the device is not using Ultra HD signals, you can switch off Ultra HD for this HDMI connection.

The setting **UHD 4:4:4/4:2:2** allows UHD YCbCr 4:4:4 / 4:2:2 signals. The setting **UHD 4:2:0** allows UHD YCbCr 4:2:0 signals.

To set the signal quality...

- 1 - Press **⚙**, select **All Settings** and press **OK**.
- 2 - Select **General Settings** and press **➤** (right) to enter the menu.
- 3 - Select **HDMI Ultra HD**.
- 4 - Select **UHD 4:4:4/4:2:2**, **UHD 4:2:0** or **UHD Off**.
- 5 - Press **◀** (left) repeatedly if necessary, to close the menu.

If the picture and sound of a device connected to **HDMI 1** or **HDMI 2** is distorted, connect the device to **HDMI 3** or **HDMI 4** on this TV.

For more information, in **Help**, select **Keywords** and look up **Problems, HDMI** or **Problems, HDMI Connection**.

---

## Advanced Settings

### TV Guide

The TV Guide receives information (data) from broadcasters or from the Internet. In some regions and for some channels, TV Guide information might not be available. The TV can collect TV Guide information for the channels that are installed on the TV. The TV cannot collect the TV Guide information from channels viewed from a digital receiver or decoder.

The TV comes with the information set to **From the Broadcaster**.

If TV Guide information comes from the Internet, the TV Guide can also list analogue channels next to the digital channels. The TV Guide menu also shows a small screen with the current channel.

### From the Internet

If the TV is connected to the Internet, you can set the TV to receive the TV Guide information from the Internet.

To set the TV Guide information...

- 1 - Press **⚙**, select **All Settings** and press **OK**.
- 2 - Select **General Settings** and press **➤** (right) to enter the menu.
- 3 - Select **Advanced > TV Guide > From the Internet**.
- 4 - Press **◀** (left) repeatedly if necessary, to close the menu.

---

### Channel Logos

In some countries, the TV can show the channel logos.

If you do not want these logos to appear, you can switch them off.

To switch off the logos...

- 1 - Press **⚙**, select **All Settings** and press **OK**.
- 2 - Select **General Settings** and press **➤** (right) to enter the menu.
- 3 - Select **Advanced > Channel Logos** and press **➤** (right) to enter the menu.
- 4 - Select **Off**.
- 5 - Press **◀** (left) repeatedly if necessary, to close the menu.

---

### HbbTV

If a TV channel offers HbbTV pages, you must first switch on HbbTV in the TV settings to view the pages.

- 1 - Press **⚙**, select **All Settings** and press **OK**.
- 2 - Select **General Settings** and press **➤** (right) to enter the menu.
- 3 - Select **Advanced > HbbTV**.
- 4 - Select **On** or **Off**.
- 5 - Press **◀** (left) repeatedly if necessary, to close the menu.

If you want to avoid access to HbbTV pages on a specific channel, you can block the HbbTV pages for this channel only.

- 1 - Tune to the channel of which you want to block the HbbTV pages.
- 2 - Press **+** **OPTIONS**, select **Preferences > HbbTV on this Channel**.
- 3 - Select **Off**.

---

## Factory Settings

You can set the TV back to the original TV settings (the factory settings).

To switch back to the original settings...

- 1 - Press **⚙**, select **All Settings** and press **OK**.
- 2 - Select **General Settings** and press **➤** (right) to enter the menu.

- 3 - Select **Factory Settings**.
- 4 - Select **OK**.
- 5 - Press **◀** (left) repeatedly if necessary, to close the menu.

---

## Reinstall TV

You can redo a full TV installation. The TV is completely reinstalled.

To redo a full TV installation...

- 1 - Press **⚙️**, select **All Settings** and press **OK**.
- 2 - Select **General Settings** and select **Reinstall TV**.
- 3 - Follow the instructions on screen. The installation may take a few minutes.

---

12.7

## Clock, Region and Language

---

### Menu Language

To change the language of the TV menus and messages...

- 1 - Press **⚙️**, select **All Settings** and press **OK**.
- 2 - Select **Region and Language** and press **▶** (right) to enter the menu.
- 3 - Select **Language > Menu Language**.
- 4 - Select on the language you need and press **OK**.
- 5 - Press **◀** (left) repeatedly if necessary, to close the menu.

---

## Language preferences

---

### Audio Language Settings

Digital TV channels can broadcast audio with several spoken languages for a programme. You can set a preferred primary and secondary audio language. If audio in one of these languages is available, the TV will switch to this audio.

If none of the preferred audio languages is available, you can select another audio language which is available.

To set the primary and secondary audio language...

- 1 - Press **⚙️**, select **All Settings** and press **OK**.
- 2 - Select **Region and Language** and press **▶** (right) to enter the menu.
- 3 - Select **Languages > Primary Audio** or **Secondary Audio**.
- 4 - Select on the language you need.
- 5 - Press **◀** (left) repeatedly if necessary, to close the menu.

---

## Subtitles

---

### Switch On

To switch on Subtitles, press **SUBTITLE**.

You can switch subtitles **On**, **Off** or **On During Mute**.

Or to show subtitles automatically when the broadcasted programme is not in language – the language set for the TV – select **Automatic**. This setting will also show Subtitles automatically when you mute the sound.

---

### Subtitle Language Settings

Digital channels can offer several subtitle languages for a programme. You can set a preferred primary and secondary subtitle language. If subtitles in one of these languages are available, the TV will show the subtitles you selected.

If none of the preferred subtitle languages are available, you can select another subtitle language which is available.

To set the primary and secondary subtitle language...

- 1 - Press **⚙️**, select **All Settings** and press **OK**.
- 2 - Select **Region and Language** and press **▶** (right) to enter the menu.
- 3 - Select **Languages > Primary Subtitles** or **Secondary Subtitles**.
- 4 - Select on the language you need.
- 5 - Press **◀** (left) repeatedly if necessary, to close the menu.

---

### Subtitles from Text

If you tune to an analogue channel, you need to make the subtitles available for each channel manually.

- 1 - Switch to a channel and press **TEXT** to open Text.
- 2 - Enter the page number for subtitles, usually **888**.
- 3 - Press **TEXT** again, to close Text.

If you select **On** in the Subtitle menu when watching this analogue channel, subtitles will be shown if available.

---

### Text / Teletext Languages

---

#### Text Pages

To open Text/Teletext press **TEXT**, while you are watching TV channels.

To close Text, press **TEXT** again.

#### Select a Text page

To select a page . . .

- 1 - Enter the page number with the number keys.
- 2 - Use the arrow keys to navigate.
- 3 - Press a colour key to select a colour-coded subject at the bottom of the screen.

#### Text sub-pages

A Text page number can hold several subpages. The subpage numbers are shown on a bar next to the main page number.

To select a subpage, press **◀** or **▶**.

#### T.O.P. Text pages

Some broadcasters offer T.O.P. Text.

To open T.O.P. Text pages within Text, press **+** **OPTIONS** and select **T.O.P. overview**.

#### Favourite pages

The TV makes a list of the last 10 Text pages you opened. You can easily reopen them again in the Favourite Text pages column.

- 1 - In Text, select the star in the top left corner of the screen to show the column of favourite pages.
  - 2 - Press **▼** (down) or **▲** (up) to select a page number and press **OK** to open the page.
- You can clear the list with the option **Clear favourite pages**.

#### Search Text

You can select a word and scan Text for all occurrences of this word.

- 1 - Open a Text page and press **OK**.
- 2 - Select a word or number with the arrow keys.
- 3 - Press **OK** again to jump immediately to the next occurrence of this word or number.
- 4 - Press **OK** again to jump to the subsequent occurrence.
- 5 - To stop searching, press **▲** (up) until nothing is selected.

#### Text from a connected device

Some devices that receive TV channels can also offer Text.

To open Text from a connected device . . .

- 1 - Press **📺** select the device and press **OK**.
- 2 - While watching a channel on the device, press **+** **OPTIONS**, select **Show device keys** and select the **📺** key and press **OK**.
- 3 - Press **←** **BACK** to hide the device keys.
- 4 - To close Text, press **←** **BACK** again.

#### Digital Text (UK only)

Some digital broadcasters offer dedicated Digital Text or interactive TV on their digital TV channels. This includes normal Text using the number, colour and arrow keys to select and navigate.

To close Digital Text, press **←** **BACK**.

---

## Text Options

In Text/Teletext, press **+** **OPTIONS** to select the following...

- **Freeze page**

To stop the automatic rotation of subpages.

- **Dual screen / Full screen**

To show the TV channel and Text alongside each other.

- **T.O.P. overview**

To open T.O.P. Text.

- **Enlarge**

To enlarge the Text page for comfortable reading.

- **Reveal**

To unhide hidden information on a page.

- **Cycle subpages**

To cycle subpages when these are available.

- **Language**

To switch the group of characters that Text uses to display correctly.

- **Text 2.5**

To activate the Text 2.5 for more colours and better graphics.

---

## Text Setup

### Text language

Some digital TV broadcasters have several Text languages available.

To set your primary and secondary Text language . . .

- 1 - Press **⚙️**, select **All Settings** and press **OK**.
- 2 - Select **Region and Language** and press **▶** (right) to enter the menu.
- 3 - Select **Language > Primary Text** or **Secondary Text**.
- 4 - Select your preferred Text languages.
- 5 - Press **◀** (left) repeatedly if necessary, to close the menu.

### Text 2.5

If available, Text 2.5 offers more colours and better graphics. Text 2.5 is activated as a standard factory setting.

To switch off Text 2.5...

- 1 - Press **TEXT**.
- 2 - With Text/Teletext open on screen, press **+** **OPTIONS**.
- 3 - Select **Text 2.5 > Off**.
- 4 - Press **◀** (left) repeatedly if necessary, to close the menu.



---

## Clock

---

### Date and Time

---

#### Automatic

The standard setting for the TV clock is **Automatic**. The time information comes from the broadcasted UTC - Coordinated Universal Time information.

If the clock is not correct, you can set the TV clock to **Country Dependent**. For some countries, you can select a specific time zone or set a time offset. In some countries, for some network operators, the clock settings are hidden to avoid an incorrect clock setting.

To set the TV clock...

- 1 - Press **⚙**, select **All Settings** and press **OK**.
- 2 - Select **Region and Language** and select **Clock > Auto Clock Mode**.
- 3 - Select **Automatic** or **Country Dependent**.
- 4 - Press **⬅** (left) to go back one step.

---

#### Manual

If none of the automatic settings display the time correctly, you can set the time manually.

However, if you schedule recordings from the TV Guide, we recommend not to change the time and date manually. In some countries, for some network operators, the clock settings are hidden to avoid an incorrect clock setting.

To set the TV clock manually (if available)...

- 1 - Press **⚙**, select **All Settings** and press **OK**.
- 2 - Select **Region and Language** and select **Clock > Auto Clock Mode** and press **OK**.
- 3 - Select **Manual** and press **OK**.
- 4 - Press **⬅** (left) and select **Date** or **Time**.
- 5 - Press **⬆** (up) or **⬇** (down) to adjust the value.
- 6 - Press **⬅** (left) to go back one step.

---

#### Time Zone

For some countries, you can select specific time zones to set the TV clock correctly.

To set the time zone (if available)...

- 1 - Press **⚙**, select **All Settings** and press **OK**.
- 2 - Select **Region and Language** and press **➤** (right) to enter the menu.
- 3 - Select **Clock > Time Zone**.
- 4 - According to your country, you can select a time zone or set a time offset to correct the TV clock.
- 5 - Press **⬅** (left) repeatedly if necessary, to close the menu.

---

## Sleep Timer

With the **Sleep Timer**, you can set the TV to switch to Standby automatically after a preset time.

To set the Sleep Timer...

- 1 - Press **⚙**, select **All Settings** and press **OK**.
- 2 - Select **Region and Language** and press **➤** (right) to enter the menu.
- 3 - Select **Clock > Sleep Timer**.
- 4 - With the slider bar you can set the time to up to 180 minutes in increments of 5 minutes. If set to 0 minutes, the Sleep Timer is switched off. You can always switch off your TV earlier or reset the time during the countdown.
- 5 - Press **⬅** (left) repeatedly if necessary, to close the menu.

---

## Remote Control Keyboard

To set the keyboard layout to Azerty...

- 1 - Press **⚙**, select **All Settings** and press **OK**.
- 2 - Select **Region and Language** and press **➤** (right) to enter the menu.
- 3 - Select **Remote Control Keyboard**.
- 4 - Select **Azerty** or **Qwerty**.
- 5 - Press **⬅** (left) repeatedly if necessary, to close the menu.

---

12.8

## Universal Access

---

### Switch On

With **Universal Access** switched on, the TV is prepared for use for the deaf, hard of hearing, blind or partially sighted people.

#### Switch on

If you did not switch on **Universal Access** during the installation, you can still switch it on in **Universal Access** menu.

To switch on Accessibility...

- 1 - Press **⚙**, select **All Settings** and press **OK**.
- 2 - Select **Universal Access** and press **➤** (right) to enter the menu.
- 3 - Select **Universal Access** one step further.
- 4 - Select **On**.
- 5 - Press **⬅** (left) repeatedly if necessary, to close the menu.

---

## Hard of Hearing

Some digital TV channels broadcast special audio and subtitles adapted for the hard of hearing or deaf people. With **Hearing impaired** switched on, the TV automatically switches to the adapted audio and subtitles, if available. Before you can switch on **Hearing impaired**, you have to switch on **Universal Access**.

To switch on **Hearing impaired**...

- 1 - Press **⚙**, select **All Settings** and press **OK**.
- 2 - Select **Universal Access** and press **➤** (right) to enter the menu.
- 3 - Select **Hearing impaired** and press **➤** (right) to enter the menu.
- 4 - Select **On**.
- 5 - Press **⬅** (left) repeatedly if necessary, to close the menu.

---

## Audio Description

### Switch On

Digital TV channels can broadcast special audio commentary describing what is happening on screen.

To be able to set the visually impaired audio and effects, you have to switch on **Audio Description** first.

Also, before you can switch on **Audio Description**, you have to switch on **Universal Access** in setup menu.

With **Audio Description**, a narrator's commentary is added to the normal audio.

To switch on the commentary (if available)...

To switch on **Audio Description**...

- 1 - Press **⚙**, select **All Settings** and press **OK**.
- 2 - Select **Universal Access** and press **➤** (right) to enter the menu.
- 3 - Select **Audio Description** and press **➤** (right) to enter the menu.
- 4 - Select **Audio Description** one step further.
- 5 - Select **On**.
- 6 - Press **⬅** (left) repeatedly if necessary, to close the menu.

---

### Mixed Volume

You can mix the volume of the normal audio with the audio commentary.

To mix the volume...

- 1 - Press **⚙**, select **All Settings** and press **OK**.
- 2 - Select **Universal Access** and press **➤** (right) to enter the menu.

- 3 - Select **Audio Description > Mixed Volume**.
- 4 - Press the arrows **▲** (up) or **▼** (down) to adjust the value.
- 5 - Press **⬅** (left) repeatedly if necessary, to close the menu.

---

### Audio Effect

Some audio commentary can hold extra audio effects, like stereo or fading sound.

To switch on **Audio effects** (if available)...

- 1 - Press **⚙**, select **All Settings** and press **OK**.
- 2 - Select **Universal Access** and press **➤** (right) to enter the menu.
- 3 - Select **Audio Description > Audio Effects**.
- 4 - Select **On**.
- 5 - Press **⬅** (left) repeatedly if necessary, to close the menu.

---

### Speech

The audio commentary can also hold subtitles for the words which are spoken.

To switch on these subtitles (if available) . . .

- 1 - Press **⚙**, select **All Settings** and press **OK**.
- 2 - Select **Universal Access** and press **➤** (right) to enter the menu.
- 3 - Select **Audio Description > Speech**.
- 4 - Select **Descriptive** or **Subtitles**.
- 5 - Press **⬅** (left) repeatedly if necessary, to close the menu.

---

## 12.9

## Child Lock

---

### Parental Rating

To set a minimum age to watch rated programmes...

- 1 - Press **⚙**, select **All Settings** and press **OK**.
- 2 - Select **Child Lock** and press **➤** (right) to enter the menu.
- 3 - Select **Parental Rating**, and select one of the age in the list.
- 4 - Press **⬅** (left) repeatedly if necessary, to close the menu.

---

## App Lock

For more information, in **Help**, select **Keywords** and look up **APP lock** for more information.

---

## Set Code / Change Code

The Child Lock PIN code is used to lock or unlock channels or programmes.

To set the lock code or to change the current code...

- 1 - Press , select **All Settings** and press **OK**.
- 2 - Select **Child Lock** and press **➤** (right) to enter the menu.
- 3 - Select **Set Code** or **Change Code** .
- 4 - Enter a 4 digit code of your choice. If a code is set already, enter the current Child Lock code and then enter the new code twice.
- 5 - Press **◀** (left) repeatedly if necessary, to close the menu.

The new code is set.

### Forgotten your Child Lock PIN code?

If you forgot your PIN code, you can override the current code and enter a new code.

- 1 - Press , select **All Settings** and press **OK**.
- 2 - Select **Child Lock** and press **➤** (right) to enter the menu.
- 3 - Select **Change Code**.
- 4 - Enter the overriding code **8888**.
- 5 - Now enter a new Child Lock PIN code and enter it again to confirm.
- 6 - Press **◀** (left) repeatedly if necessary, to close the menu.

The new code is set.

# Videos, Photos and Music





## 13.1

### From a USB Connection

You can view your photos or play your music and videos from a connected USB flash drive or USB Hard Drive.

With the TV switched on, plug in a USB flash drive or a USB Hard Drive to one of the USB connections. The TV detects the device and will list your media files.

If the list of files does not appear automatically...

- 1 - Press  SOURCES, select  USB and press OK.
- 2 - Select  USB Devices and press  (right) to browse your files in the folder structure you have organised on the drive.
- 3 - To stop playing videos, photos and music, press  EXIT.

#### Warning

If you try to pause or record a programme with a USB Hard Drive connected, the TV will ask you to format the USB Hard Drive. This formatting will delete all current files on the USB Hard Drive.

## 13.2

### From a Computer or NAS



You can view your photos or play your music and videos from a computer or a NAS (Network Attached Storage) in your home network.

The TV and computer or NAS must be in the same home network. On your computer or NAS, you need to install Media Server Software. Your Media Server must be set to share your files with the TV. The TV shows your files and folders as they are organised by the Media Server or as they are structured on your computer or NAS.

The TV does not support subtitles on video streams from a computer or NAS.

If the Media Server supports searching for files, a search field is available.

To browse and play the files on your computer...

- 1 - Press  SOURCES, select  Network and press OK.
- 2 - Once a SimplyShare device is connected, the SimplyShare Devices item will be replaced by connected device name.





- 3 - You can browse and play your files.
- 4 - To stop playing videos, photos and music, press  EXIT.

## 13.3

### From a Cloud Storage Service

You can view photos or play music and videos you uploaded on a storage service in the online cloud\*.

With the  Cloud Explorer app you can connect to Cloud Hosting Services. You can use your login and password to connect.





- 1 - Press  HOME.
- 2 - Scroll down and select  Apps >  Cloud Explorer and press OK.
- 3 - Select the hosting service you need.
- 4 - Connect and sign in to the hosting service with your login and password.
- 5 - Select the photo or video you want to play and press OK.
- 6 - Press  (left) to go back one step or press  BACK to close the menu.

\* A storage service like Dropbox™.





## 13.4

### Favourites, Most Popular, Last Played menu





#### View favourite files

- 1 - Press  SOURCES, select  USB and press OK.
- 2 - Select  USB Devices and select  Favourites.
- 3 - You can view all favourite files in the list.

#### View most popular files

- 1 - Press  SOURCES, select  USB and press OK.
- 2 - Select  USB Devices and select  Most popular.
- 3 - Press OK to view files in the list or press  OPTIONS to clear the list of most popular.

#### View last played files

- 1 - Press  SOURCES, select  USB and press OK.
- 2 - Select  USB Devices and select  Last played.
- 3 - Press OK to view files in the list or press  OPTIONS to clear the list of last played.

## Play your Videos

### Control Bar

To show or hide the control bar when a video is playing, press **i** INFO\*.

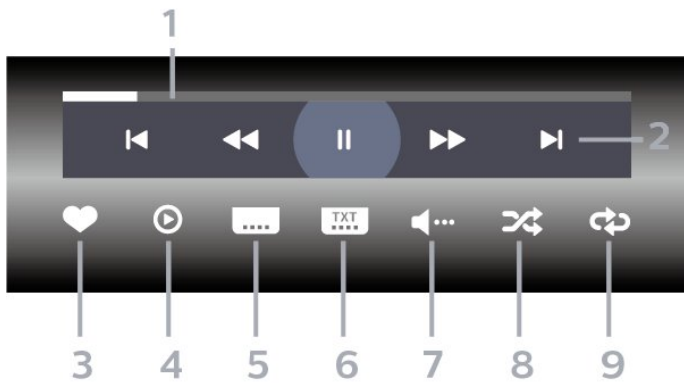

1 - Progress bar

2 - Playback control bar

- ◀: Jump to the previous video in a folder
- ▶: Jump to the next video in a folder
- ◀◀: Rewind
- ▶▶: Fast forward
- ⏸: Pause the playback

3 - Mark as favourites

4 - Play all videos

5 - Subtitle: switch subtitles On, Off or On During Mute.

6 - Subtitle language: select a Subtitle Language

7 - Audio language: select an audio language

8 - Shuffle: play your files in a random order

9 - Repeat: plays all videos in this folder once or continuously

\* If **i** INFO key is available on your remote control

## View your Photos

### Control Bar

To show or hide the control bar when a slideshow is playing, press **i** INFO\*.



1 - Playback control bar

- ◀: Jump to the previous photo in a folder
- ▶: Jump to the next photo in a folder
- ⏸: Pause the slideshow playback

2 - Mark as favourites

3 - Start a slideshow

4 - Rotate the photo

5 - Shuffle: play your files in a random order

6 - Repeat: plays all photos in this folder once or continuously

7 - Stop the music playing in the background

8 - Set the speed of the slide show

\* If **i** INFO key is available on your remote control

## Play your Music

### Control Bar

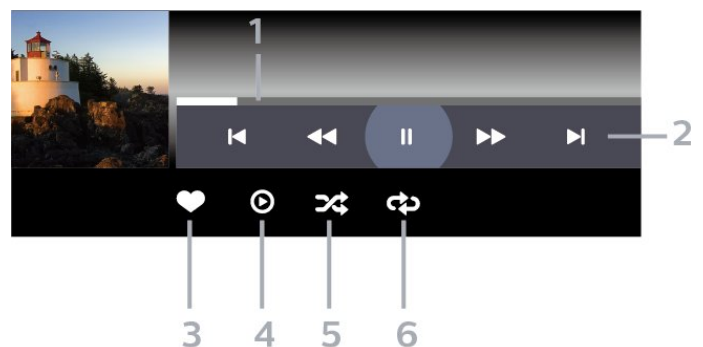

1 - Progress bar

2 - Playback control bar

- ◀: Jump to the previous music in a folder
- ▶: Jump to the next music in a folder
- ◀◀: Rewind
- ▶▶: Fast forward
- ⏸: Pause the playback

3 - Mark as favourites

4 - Play all music

5 - Shuffle: play your files in a random order

6 - Repeat: plays all music in this folder once or

continuously

---

# TV Guide

---

## 14.1

### What You Need

With the TV Guide you can view a list of the current and scheduled TV programmes of your channels. Depending on where the TV guide information (data) is coming from, analogue and digital channels or only digital channels are shown. Not all channels offer TV Guide information.

The TV can collect TV Guide information for the channels that are installed on the TV. The TV cannot collect the TV Guide information for channels viewed from a digital receiver or decoder.

---

## 14.2

### TV Guide Data

The TV Guide receives information (data) from broadcasters or from the Internet. In some regions and for some channels, TV Guide information might not be available. The TV can collect TV Guide information for the channels that are installed on the TV. The TV cannot collect the TV Guide information from channels viewed from a digital receiver or decoder.

The TV comes with the information set to **From the Broadcaster**.

If TV Guide information comes from the Internet, the TV Guide can also list analogue channels next to the digital channels. The TV Guide menu also shows a small screen with the current channel.

#### From the Internet

If the TV is connected to the Internet, you can set the TV to receive the TV Guide information from the Internet.

To set the TV Guide information...

- 1 - Press , select **All Settings** and press **OK**.
- 2 - Select **General Settings** and press **➤** (right) to enter the menu.
- 3 - Select **Advanced > TV Guide > From the Internet** and press **OK**.
- 4 - Press **◀** (left) repeatedly if necessary, to close the menu.

#### Missing recordings

When some recordings seem to have disappeared from the list of recordings, the TV Guide info (data) might have changed. Recordings made with the setting **From the Broadcaster** become invisible in the list if you switch the setting to **From the**

**Internet** or vice versa. The TV might have switched to **From the Internet** automatically.

To make the recordings available in the list of recordings, switch to the setting that was selected when the recordings were made.

---

## 14.3

### Using the TV Guide

---

#### Open the TV Guide

To open the TV Guide, press  **TV GUIDE**. The TV Guide shows the channels of the selected tuner.

Press  **TV GUIDE** again to close.

The first time you open the TV Guide, the TV scans all TV channels for programme information. This may take several minutes. TV Guide data is stored on TV.

---

#### Tune to a Programme

From the TV Guide, you can tune to a current programme.

To switch to the programme (channel), select the programme and press **OK**.

#### View programme details

To call up the details of the selected programme...

- 1 - Press **+** **OPTIONS**, and select **Preferences**.
- 2 - Select **Channel Info**, and press **OK**.
- 3 - Press **←** **BACK** to close.

---

#### Change Day

The TV Guide can show the scheduled programmes for the upcoming days (maximum up to 8 days).

- 1 - Press  **TV GUIDE**.
- 2 - Select **Now** and press **OK**.
- 3 - Select the day you need.

---

#### Set a Reminder

You can set a reminder for a programme. A message will alert you at the start of the programme. You can tune to this channel immediately.

In the TV Guide a programme with a reminder is marked with a  (clock).

To set a reminder...

- 1 - Press  **TV GUIDE** and select an upcoming programme.
- 2 - Press **+** **OPTIONS**.

- 3 - Select **Set Reminder** and press **OK**.
- 4 - Press **← BACK** to close the menu.

To clear a reminder...

- 1 - Press **≡ TV GUIDE** and select a programme with the reminder.
- 2 - Press **+ OPTIONS**.
- 3 - Select **Clear Reminder** and press **OK**.
- 4 - Press **← BACK** to close the menu.

---

## Search by Genre

If the information is available, you can look up scheduled programmes by genre like movies, sports, etc.

To search for programmes by genre...

- 1 - Press **≡ TV GUIDE**.
- 2 - Use navigation keys to select **⋮** at the middle and press **OK**.
- 3 - Select **Search by Genre** and press **OK**.
- 4 - Select the genre you want and press **OK**. A list with the found programmes appears.
- 5 - Press **← BACK** to close the menu.

---

## Set a Recording

You can set a recording in the TV Guide\*.

In the TV Guide, a programme set to be recorded is marked with **📺**.

To record a programme...

- 1 - Press **≡ TV GUIDE** and select a future or ongoing programme.
- 2 - Press **+ OPTIONS**, select **Record**.
- 3 - Press **← BACK** to close the menu.

\* See chapter **Recording and Pause TV** for more information.



# Recording and Pause TV

15.1

## Recording

### What You Need

You can record a digital TV broadcast and watch it later.

To record a TV programme you need...

- a connected USB Hard Drive formatted on this TV
- digital TV channels installed on this TV
- to receive channel information for the on screen TV Guide
- a reliable TV clock setting. If you reset the TV clock manually, recordings may fail.

You cannot record when you are using Pause TV.

In terms enforcement of copyright legislation, some DVB providers can apply different restriction by means of DRM (Digital Right Management) technology. In case of broadcasting protected channels, recording, record validity or number of views may be restricted. Recording may be completely prohibited. In case of trying to record a protected broadcasting or play back an expired recording, an error message can appear.

#### Note:

Recording function is only for digital TV broadcast. It is not possible to record content from external devices (e.g. HDMI).

## Record a Programme

### Record Now

To record the programme you are watching right now, press **●** (Record) on the remote control. The recording will start immediately.

To stop the recording, press **■** (Stop).

When TV Guide data is available, the programme you are watching will be recorded from the moment you pressed the recording key until the programme ends. If no TV Guide data is available, the recording will only last 30 minutes. You can adjust the end time of the recording in the list of **Recordings**.

## Schedule a Recording

You can schedule a recording of an upcoming programme for today or a few days from today (maximum of 8 days away). The TV will use the data from the TV Guide to start and end the recording.

To record a programme...

- 1 - Press **≡** TV GUIDE.
- 2 - Use navigation keys to select **Now**, and press **OK**.
- 3 - Select **Now**, **Later**, **Tomorrow** or the day you need, and press **OK** or **←** BACK to close the menu.
- 4 - Select the programme you wish to record, press **+** OPTIONS, select **●** Record, and press **OK**. The programme is scheduled for recording. A warning will show automatically when overlapping recordings are scheduled. If you plan to record a programme in your absence, remember to leave the TV switched to Standby and the USB Hard Drive switched on.
- 5 - Press **←** BACK to close the menu.

## Recording Conflicts

When two scheduled recordings are overlapping in time, there is a recording conflict. To solve a recording conflict, you can adjust the start and end time of one or both scheduled recordings.

To adjust the start or end time of a scheduled recording...

- 1 - Press **→** SOURCES, and select **●** Recordings.
- 2 - At the top of the screen, select **⌚** Scheduled and press **OK**.
- 3 - In the list of scheduled recordings and reminders, select **Recordings** and press **OK** to view the scheduled recordings only.
- 4 - Select the scheduled recording that conflicts with another scheduled recording and press **+** OPTIONS.
- 5 - Select **Adjust Time**, and press **OK**.
- 6 - Select the start or end time and change the time with the **▲** (up) or **▼** (down) keys. Select **Apply** and press **OK**.
- 7 - Press **←** BACK to close the menu.

## Auto End Margin

You can set the time margin that the TV will add automatically at the end of each scheduled recording.

To set the automatic end time margin...

- 1 - Press **→** SOURCES, and select **●** Recordings.
- 2 - Use navigation keys to select **⌚** at the upper right corner and press **OK**.
- 3 - Select **Auto End Margin** and press **OK**.
- 4 - Press **▲** (up) or **▼** (down) and press **OK** to

set the time margin added to a recording automatically. You can add up to 45 minutes to a recording.

5 - Press **←** BACK to close the menu.

---

## Manual Recording

You can schedule a recording that is not linked to a TV programme. You set the tuner type, channel and the start and end time yourself.

To schedule a recording manually...

- 1 - Press **SOURCES**, and select **Recordings**.
- 2 - At the top of the screen, select **Scheduled**.
- 3 - Use navigation keys to select **⋮** at the upper right corner, and press **OK**.
- 4 - Select **Schedule** and press **OK**.
- 5 - Select the tuner from where you want to record and press **OK**.
- 6 - Select the channel to record from and press **OK**.
- 7 - Select the day of the recording and press **OK**.
- 8 - Set the start and end time of the recording. Select a button and use the **▲** (up) or **▼** (down) keys to set the hours and minutes.
- 9 - Select **Schedule** and press **OK** to schedule the manual recording.

The recording will appear in the list of scheduled recordings and reminders.

---

## Watch a Recording

To watch a recording...

- 1 - Press **SOURCES**, and select **Recordings**.
- 2 - In the list of recordings, select the recording you need and press **OK** to start watching.
- 3 - You can use the keys **⏸** (pause), **▶** (play), **⏮** (rewind), **⏭** (fast forward) or **■** (stop).
- 4 - To switch back to watch TV, press **TV** EXIT.

---

## Remove or rename a Recording

To rename or remove a recording...

- 1 - Press **SOURCES**, and select **Recordings**.
- 2 - In the list of recordings, select the recording you need and press **ⓘ** INFO / **+** OPTIONS.
- 3 - You can select **Rename** to change the name of recording or select **Remove** to remove this recording.
- 4 - To switch back to watch TV, press **TV** EXIT.

15.2

---

## Pause TV

---

### What You Need

You can pause a digital TV broadcast and resume watching it a bit later.

To pause a TV programme you need...

- a connected USB Hard Drive formatted on this TV
- digital TV channels installed on this TV
- to receive channel information for the on screen TV Guide

With the USB Hard Drive connected and formatted, the TV continuously stores the TV broadcast you are watching. When you switch to another channel, the broadcast of the former channel is cleared. Also when you switch the TV to standby the broadcast is cleared.

You cannot use Pause TV when you are recording.

For more information, in **Help**, select **Keywords** and look up **USB Hard Drive, installation or Installation, USB Hard Drive**.

---

## Pause a Programme

To pause and resume a broadcast...

- To pause a broadcast, press **⏸** (Pause).
- To resume watching, press **▶** (Play).

With the progress bar on screen, press **⏮** (Rewind) or press **⏭** (Forward) to select from where you want to start viewing the paused broadcast. Press these keys repeatedly to change speed.

You can pause a broadcast for a maximum time span of 90 minutes.

To switch back to the live TV broadcast, press **■** (Stop).

---

## Replay

Since the TV stores the broadcast you are watching, you can mostly replay the broadcast for a few seconds.

To replay a current broadcast...

- 1 - Press **⏸** (Pause)
- 2 - Press **⏮** (Rewind). You can press **⏮** repeatedly to select from where you want to start viewing the paused broadcast. Press these keys repeatedly to change speed. At one point you will reach the start of the broadcast storage or the maximum time span.
- 3 - Press **▶** (Play) to watch the broadcast again.

4 - Press ■ (Stop) to watch the broadcast live.

---

# Smartphones and Tablets

---

16.1

## Philips TV Remote App

The new Philips TV Remote App on your smartphone or tablet is your new TV buddy.

With the TV Remote App, you master your media around you. Send photos, music or videos to your big TV screen or watch any of your TV channels live on your tablet or phone. Look up what you want to watch on the TV Guide and watch it on your phone or TV. With the TV Remote App you can use your phone as a remote control.

Download the Philips TV Remote App from your favourite app store today.

The Philips TV Remote App is available for iOS and Android and is free of charge.

16.2

---

## Google Cast

---

### What You Need

If an app on your mobile device has Google Cast, you can cast your app on this TV. On the mobile app, look for the Google Cast icon. You can use your mobile device to control what's on TV. Google Cast works on Android and iOS.

Your mobile device must be connected to the same Wi-Fi home network as your TV.

### Apps with Google Cast

New Google Cast apps come available every day. You can already try it with YouTube, Chrome, Netflix, Photowall ... or Big Web Quiz for Chromecast. See also [google.com/cast](http://google.com/cast)

Some Google Play products and features aren't available in all countries.

Find more information on [support.google.com/androidtv](http://support.google.com/androidtv)

---

## Cast to Your TV

To cast an app to the TV screen...

- 1 - On your smartphone or tablet, open an app that supports Google Cast.
- 2 - Tab the Google Cast icon.
- 3 - Select the TV you would like to cast to.
- 4 - Press play on your smartphone or tablet. What you selected should start playing on TV.

16.3

---

## AirPlay

To add the AirPlay functionality to your Android TV, you can download and install one of the several Android apps that do just that. You can find several of these apps in the [Google Play™ Store](https://play.google.com/store) .

16.4

---

## MHL

This TV is MHL™ compliant.

If your mobile device is also MHL compliant, you can connect your mobile device with a MHL cable to the TV. With the MHL cable connected you can share what's on your mobile device on the TV screen. Your mobile device charges its battery at the same time. The MHL connection is ideal for watching movies or playing games from your mobile device on TV for a longer time.

### Charging

With the MHL cable connected, your device will charge while the TV is switched on (not in standby).

### MHL Cable

You need a passive MHL cable (HDMI to Micro USB) to connect your mobile device to the TV. You might need an extra adapter to connect to your mobile device. To connect the MHL cable to the TV use the **HDMI 4 MHL** connection.



MHL, Mobile High-Definition Link and the MHL Logo are trademarks or registered trademarks of the MHL, LLC.

# Games

---

## 17.1

### What You Need

On this TV, you can play games...

- from the Apps in the Home menu
- from the **Google Play™ Store** in the Home menu
- from a connected Game Console

Games apps must be downloaded and installed on TV before you can play them. Some games need a gamepad to play.

To install game apps, the TV must be connected to the Internet. You must agree to the Terms of Use to use apps. You must sign in with a Google Account to use the Google Play apps and **Google Play™ Store**.

---

## 17.2

### Play a Game

---

#### From a Game Console

To start a game from a Game Console...

- 1 - Switch on the Game Console.
- 2 - Press **SOURCES** and select a game console or the name of the connection.
- 3 - Start the game.
- 4 - Press **BACK** repeatedly or press **EXIT** or stop the app with its dedicated exit/stop button.

For more information, in **Help**, select **Keywords** and look up **Game Console, connect**.

---

# Ambilight

---

## Ambilight Style

---

### Follow Video

You can set Ambilight to follow the video or the audio dynamics of a TV programme. Alternatively, you can set Ambilight to show a preset colour style or you can switch Ambilight off.

If you select **Follow Video**, you can select one of the styles that follow the dynamics of the picture on your TV screen.

To set the Ambilight Style...

- 1 - Press  **AMBILIGHT**.
- 2 - Select **Follow Video**.
- 3 - Select the style you want.
- 4 - Press **<** (left) to go back one step or press **←** **BACK** to close the menu.

The available **Follow Video** styles are...

- **Standard** - Ideal for day to day TV watching
- **Natural** - Follows the picture or sound as truthful as possible
- **Immersive** - Ideal for action movies
- **Vivid** - Ideal for daylight conditions
  
- **Game** - Ideal for gaming
- **Comfort** - Ideal for a quiet evening
- **Relax** - Ideal for a lounge feeling

---

### Follow Audio

You can set Ambilight to follow the video or the audio dynamics of a TV programme. Alternatively, you can set Ambilight to show a preset colour style or you can switch Ambilight off.

If you select **Follow Audio**, you can select one of the styles that follow the dynamics of the sound.

To set the Ambilight Style...

- 1 - Press  **AMBILIGHT**.
- 2 - Select **Follow Audio**.
- 3 - Select the style you want.
- 4 - Press **<** (left) to go back one step or press **←** **BACK** to close the menu.

The available **Follow Audio** styles are...

- **Lumina** - Mixes audio dynamics with video colours
- **Colora** - Based on audio dynamics
- **Retro** - Based on audio dynamics
- **Spectrum** - Based on audio dynamics
- **Scanner** - Based on audio dynamics

- **Rhythm** - Based on audio dynamics
- **Party** - A mix of all Follow Audio styles, one after the other

---

### Follow Colour

You can set Ambilight to follow the video or the audio dynamics of a TV programme. Alternatively, you can set Ambilight to show a preset colour style or you can switch Ambilight off.

If you select **Follow Colour**, you can select one of the preset colour styles.

To set the Ambilight Style...

- 1 - Press  **AMBILIGHT**.
- 2 - Select **Follow Colour**.
- 3 - Select the style you want.
- 4 - Press **<** (left) to go back one step or press **←** **BACK** to close the menu.

The available **Follow Colour** styles are...

- **Hot Lava** - Red colour variations
- **Deep Water** - Blue colour variations
- **Fresh Nature** - Green colour variations
- **ISF Warm White** - Static colour
- **Cool White** - Static colour

---

### Follow App

This function is available when you control Ambilight with an app.

To set the Ambilight Style...

- 1 - Press  **AMBILIGHT**.
- 2 - Select **Follow App**.
- 3 - Follow the on-screen instruction.
- 4 - Press **<** (left) to go back one step or press **←** **BACK** to close the menu.

## Ambilight Off

To switch off Ambilight...

- 1 - Press  **AMBILIGHT**.
- 2 - Select **Off**.
- 3 - Press **<** (left) to go back one step or press **←** **BACK** to close the menu.

## Ambilight Settings





For more information, in **Help**, select **Keywords** and look up **Ambilight, Settings** for more information.

---

## Lounge Light Mode

The lounge light mode of your TV allows you to switch on the Ambilight when the TV is in standby. So you can light up your room with Ambilight.

After you have switched your TV to standby and wish to switch on the Ambilight lounge light, follow these steps:

- 1 - Press  **AMBILIGHT**.
- 2 - After you have pressed the  **AMBILIGHT**, the Ambilight lounge light will be switched on.
- 3 - Press  **AMBILIGHT** again if you wish to change to a different light effect.
- 4 - To switch off the Ambilight lounge light, press  **AMBILIGHT** until you see the lights are turned off. You may need to press  **AMBILIGHT** a few times.

---

# Top Picks

---

19.1

## About Top Picks

With  Top Picks your TV recommends...



- current TV programmes in  Now on TV
- the latest rental videos in  Video on Demand
- online TV services (Catch Up TV) in  TV on Demand

To enjoy Top Picks, connect your TV to the Internet. Make sure you agree to the Terms of Use. The Top Picks information and services are only available in selected countries.

### Terms of Use

To allow the TV to make these recommendations, you must agree to the Terms of Use. To get personalised recommendations based on your viewing habits, make sure you checked the box for **Serving your personalized viewing recommendations**.

To open the Terms of Use...

- 1 - Press  TOP PICKS.
- 2 - Use navigation keys to select  at the upper right corner, select **Terms of Use** and press **OK**.

19.2

---

## Now on TV

---

### About Now on TV

With  Now on TV, the TV recommends the most popular programmes to watch at this moment.

The recommended programmes are selected from the channels you installed. The selection is made from channels of your country. Also, you can let **Now on TV** do some personalised recommendations for you, based on programmes you watch regularly.



To make the Now on TV information available...

- the Now on TV information must be available in your country.
- the TV must have channels installed.
- the TV must be connected to the Internet.
- the TV Clock must be set to Automatic or Country Dependent.
- you must accept the Terms of Use (You might have accepted already when you connected to the Internet.).

---

## Using Now on TV

To open Now on TV...

- 1 - Press  TOP PICKS to open the Top Picks menu.
- 2 - Select  Now on TV at the top of the screen and press **OK**.
- 3 - Select **More** to open TV guide.

When you open **Now on TV**, the TV may need a few seconds to refresh the page information.

19.3

---

## TV on Demand

---

### About TV on Demand

With  TV on Demand, you can watch TV programmes you missed or watch your favourite programmes whenever it suits you best. This service is also called Catch Up TV, Replay TV or Online TV. Programmes available on TV on Demand are free to watch.



You can let TV on Demand do some personalised recommendations of programmes, based on the TV installation and the programmes you watch regularly.

The icon  will only appear at the top of the screen when TV on Demand is available.

---

## Using TV on Demand

To open TV on Demand...

- 1 - Press  TOP PICKS to open the Top Picks menu.
- 2 - Select  TV on Demand at the top of the screen and press **OK**.
- 3 - Select **All Broadcast** and press **OK**. You can select a specific broadcaster if more than one is available.
- 4 - Press  BACK to close.

When you open **TV on Demand**, the TV may need a few seconds to refresh the page information.

Once a programme started, you can use the  (Play) and  (Pause) keys.

19.4

---

## Video on Demand



---

## About Video on Demand

With  Video on Demand , you can rent movies from an online rental video store.

You can let Video on Demand do some personalised recommendations of movies, based on your country, the TV installation and the programmes you watch regularly.

The icon  will only appear at the top of the screen when Video on Demand is available.

### Payment

When you rent or buy a movie, you can pay the video store securely with your credit card. Most video stores ask you to create a login account the first time you rent a movie.



### Internet Traffic

Streaming a lot of videos may cause you to exceed your monthly Internet traffic limit.

---

## Using Video on Demand



To open Video on Demand...

- 1 - Press  TOP PICKS to open the Top Picks menu.
- 2 - Select  Video on Demand at the top of the screen and press OK.
- 3 - Select All Stores, Recommended, or Popular for your preference.
- 4 - Press  BACK to close.

When you open Video on Demand, the TV may need a few seconds to refresh the page information.

You can select a specific video store if more than one is available.

To rent a movie...

- 1 - Navigate the highlight on a movie poster. Limited info will show after some seconds.
- 2 - Press OK to open the movie page of the video store for a synopsis of the movie.
- 3 - Confirm your order.
- 4 - Make the payment on TV.
- 5 - Start watching. You can use the  (Play) and  (Pause) keys.

# Netflix

If you have a Netflix membership subscription, you can enjoy Netflix on this TV. Your TV must be connected to the Internet. In your region, Netflix might only come available with future software updates.

Press **NETFLIX** key on your remote control to open the Netflix App. You can open Netflix immediately from a TV in standby.

[www.netflix.com](http://www.netflix.com)



# Multi View

## 21.1

### TV and TV

With Multi View, you can watch a second programme in a small screen.

To open the Multi View screen...

- 1 - Press  **Multi View** \* or press  to open **TV Menu**.
- 2 - Select **Multi View**, and press **OK**.
- 3 - Select **Multi View: On** on screen. The channel you were watching appears in the small screen.

#### Conditions

- Multi View can only show digital TV channels.
- While the TV is recording, Multi View is not available.
- To use Multi View with satellite TV channels, you must connect the 2 satellite tuners **SAT 1** and **SAT 2** to your satellite dish.
- If both TV channels need a CAM to decode, you must install 2 CAMs to use Multi View.



\* If  **Multi View** key is available on your remote control

## 21.2

### Text and TV

You can watch a TV channel in the small screen of Multi View when you're watching Text.

To watch a TV channel while watching Text...

- 1 - Press  **Multi View** \* or press  to open **TV Menu**.
- 2 - Select **Multi View**, and press **OK**.
- 3 - Select **Multi View: On** on screen. The channel you were watching appears in the small screen.

To hide the small screen, select **Multi View: Off** on screen.

\* If  **Multi View** key is available on your remote control

## 21.3

### HDMI and TV

You can watch a TV channel in the small screen of Multi View when you're watching video from a connected HDMI device.

To watch a TV channel while watching video from connected HDMI device\*...

- 1 - Press  **Multi View** \* or press  to open **TV**

**Menu**.

2 - Select **Multi View**, and press **OK**.

3 - Select **Multi View: On** on screen. The channel you were watching appears in the small screen.

To hide the small screen, select **Multi View: Off** on screen.

Note: You can only watch TV channel image in Multi view mode, the audio of TV channel will be mute.





\* If  **Multi View** key is available on your remote control

## 21.4

### Nettv and TV

You can watch a TV channel in the small screen of Multi View when you're watching a Nettv app.

To watch a TV channel while watching a Nettv app...

- 1 - Press  **Multi View** \* or press  to open **TV Menu**.
- 2 - Select **Multi View**, and press **OK**.
- 3 - Select **Multi View: On** on screen. The channel you were watching appears in the small screen.
- 4 - Press  **+** or  **-** to switch channels in the small screen

To hide the small screen, select **Multi View: Off** on screen.



Note: Not every Nettv app can support Multi View with a TV channel, if the app cannot support Multi View, then TV will show a message: **Multi View is not supported**.

\* If  **Multi View** key is available on your remote control

## 21.5

### Nettv and HDMI

You can watch a Nettv app in the small screen of Multi View when you're watching video from a connected HDMI device.

- 1 - Press  **Multi View** \* or press  to open **TV Menu**.
- 2 - Select **Multi View**, and press **OK**.
- 3 - Select **Multi View: On** on screen.

To hide the small screen, select **Multi View: Off** on screen.

Note: Not every Nettv app can support Multi View with a TV channel, if the app cannot support Multi View, then TV will show a message: **Multi View is not supported**.

\* If  **Multi View** key is available on your remote control

---

# Software

---

## 22.1

## Update Software

---

### Update from Internet

If the TV is connected to the Internet, you may receive a message to update the TV software. You need a high-speed (broadband) Internet connection. If you receive this message, we recommend you to carry out the update.

With the message on screen, select **Update** and follow the instructions on-screen.

You can also look for a software update yourself.

During the software update, there is no picture and the TV will switch off and on again. This might happen several times. The update can take a few minutes. Wait until the TV picture comes back up. Do not press the power switch **⏻** on the TV or on the remote control during the software update.

To look for a software update yourself...

- 1 - Press **⚙️**, select **All Settings** and press **OK**.
- 2 - Select **Update Software > Search for Updates**.
- 3 - Select **Internet**.
- 4 - The TV will look for an update on the Internet.
- 5 - If an update is available, you can update the software right away.
- 6 - A software update can take several minutes. Do not press the **⏻** key on the TV or remote control.
- 7 - When the update is done, the TV will return to the channel you were watching.

---

### Update from USB

It might be necessary to update the TV software.

You need a computer with an high-speed Internet connection and a USB flash drive to upload the software on the TV. Use a USB flash drive with at least 500MB free space. Make sure that write protection is switched off.

To update the TV software...

- 1 - Press **⚙️**, select **All Settings** and press **OK**.
- 2 - Select **Update Software > Search for Updates**.
- 3 - Select **USB > Local updates** and press **OK**.

#### Identify the TV

- 1 - Insert the USB flash drive into one of the USB connections of the TV.
- 2 - Select **Start** and press **OK**. An identification file is written on the USB flash drive.

#### Download the software

- 1 - Insert the USB flash drive into your computer.
- 2 - On the USB flash drive, locate the file **update.htm** and double click it.
- 3 - Click **Send ID**.
- 4 - If new software is available, download the .zip file.
- 5 - After the download, unzip the file and copy the file **autorun.upg** onto the USB flash drive. Do not place this file in a folder.

#### Update the TV software

- 1 - Insert the USB flash drive into the TV again. The update starts automatically.
- 2 - A software update can take several minutes. Do not press the **⏻** key on the TV or remote control. Do not remove the USB flash drive.
- 3 - When the update is done, the TV will return to the channel you were watching.

If a power cut occurs during the update, never remove the USB flash drive from the TV. When the power returns, the update will continue.

To prevent an accidental update of the TV software, delete the **autorun.upg** file from the USB flash drive.

---

### Look for OAD Updates

Scan to search for an OAD (Over-the-air Download) software update.

To look for OAD updates...

- 1 - Press **⚙️**, select **All Settings** and press **OK**.
- 2 - Select **Update Software > Look for OAD updates**.
- 3 - Follow the instructions on screen.

\* Note: The OAD software update is only available in selected countries.

---

### 22.2

## Software Version

To view the current TV software version...

- 1 - Press **⚙️**, select **All Settings** and press **OK**.
- 2 - Select **Update Software > Current Software Info** and press **OK**.
- 3 - The version, release notes and creation date are shown. Also, the Netflix ESN Number is shown if available.
- 4 - Press **⬅** (left) repeatedly if necessary, to close the menu.

## Automatic software update

Switch on Automatic software update to update your TV software automatically. Leave the TV in standby when not in use.

- 1 - Press , select **All Settings** and press **OK**.
- 2 - Select **Update Software > Automatic Software Update** and press **On/Off**.
- 3 - Press **◀** (left) repeatedly if necessary, to close the menu.

## Open Source Software

This television contains open source software. TP Vision Europe B.V. hereby offers to deliver, upon request, a copy of the complete corresponding source code for the copyrighted open source software packages used in this product for which such offer is requested by the respective licences.

This offer is valid up to three years after product purchase to anyone in receipt of this information. To obtain the source code, please write in English to .

open.source@tpvision.com

## Open Source License

### About Open Source License

README for the source code of the parts of TP Vision Netherlands B.V. TV software that fall under open source licenses.

This is a document describing the distribution of the source code used on the TP Vision Netherlands B.V. TV, which fall either under the GNU General Public License (the GPL), or the GNU Lesser General Public License (the LGPL), or any other open source license. Instructions to obtain copies of this software can be found in the Directions For Use.

TP Vision Netherlands B.V. MAKES NO WARRANTIES WHATSOEVER, EITHER EXPRESS OR IMPLIED, INCLUDING ANY WARRANTIES OF MERCHANTABILITY OR FITNESS FOR A PARTICULAR PURPOSE, REGARDING THIS SOFTWARE. TP Vision Netherlands B.V. offers no support for this software. The preceding does not affect your warranties and statutory rights regarding any TP Vision Netherlands B.V. product(s) you purchased. It only applies to this source code made available to you.

## Announcements

You can receive an announcement on new TV software available for download or other software related issues.

To read these announcements...

- 1 - Press , select **All Settings** and press **OK**.
- 2 - Select **Update Software > Announcements**.
- 3 - If there is an announcement, you can read it or select one of the announcements available.
- 4 - Press **◀** (left) repeatedly if necessary, to close the menu.

# Specifications

## 23.1

### Environmental

#### Product Fiche

##### 55PUS8601

- Energy Efficiency Class : A
- Visible Screen Size : 139cm / 55 inch
- On Mode Power Consumption (W) : 115W
- Annual Energy Consumption (kWh) \* : 160kWh
- Standby Power Consumption (W) : 0.5W
- Display Resolution (Pixels) : 3840 x 2160p

##### 65PUS8601

- Energy Efficiency Class : A+
- Visible Screen Size : 164cm / 65 inch
- On Mode Power Consumption (W) : 118W
- Annual Energy Consumption (kWh) \* : 164kWh
- Standby Power Consumption (W) : 0.5W
- Display Resolution (Pixels) : 3840 x 2160p

\* Energy consumption kWh per year, based on the power consumption of the television operating 4 hours per day for 365 days. The actual energy consumption depends on how the television is used.

#### End of Use

##### Disposal of your old product and batteries

Your product is designed and manufactured with high quality materials and components, which can be recycled and reused.



When this crossed-out wheeled bin symbol is attached to a product it means that the product is covered by the European Directive 2012/19/EU.



Please inform yourself about the local separate collection system for electrical and electronic products.

Please act according to your local rules and do not dispose of your old products with your normal household waste. Correct disposal of your old product helps to prevent potential negative

consequences for the environment and human health.

Your product contains batteries covered by the European Directive 2006/66/EC, which cannot be disposed with normal household waste.



Please find out for yourself about the local rules on separate collection of batteries because correct disposal will help to prevent negative consequences for the environment and human health.

## 23.2

### Power

Product specifications are subject to change without notice. For more specification details of this product, see [www.philips.com/TVsupport](http://www.philips.com/TVsupport)

#### Power

- Mains power : AC 220–240V +/-10%
- Ambient temperature : 5°C to 35°C
- Power saving features : Eco mode, Picture mute (for radio), Auto switch-off timer, Eco settings menu.

For power consumption information, see chapter **Product Fiche**.

The power rating stated on the product typeplate is the power consumption for this product during normal household use (IEC 62087 Ed.2). The maximum power rating, stated between brackets, is used for electrical safety (IEC 60065 Ed. 7.2).

## 23.3

### Operating System

Android OS :

Android Oreo 8

## 23.4

### Reception

- Aerial input : 75 ohm coaxial (IEC75)
- Tuner bands : Hyperband, S-Channel, UHF, VHF
- DVB : DVB-T2 (support HEVC), DVB-C (cable) QAM
- Analogue video playback : SECAM, PAL
- Digital video playback : MPEG2 SD/HD (ISO/IEC 13818-2), MPEG4 SD/HD (ISO/IEC 14496-10)
- Digital audio playback (ISO/IEC 13818-3)
- Satellite aerial input : 75 ohm F-type
- Input frequency range : 950 to 2150MHz
- Input level range : 25 to 65 dBm
- DVB-S/S2 QPSK, symbol rate 2 to 45M symbols,

## SCPC and MCPC

- LNB : DiSEqC 1.0, 1 to 4 LNBs supported, Polarity selection 14/18V, Band selection 22kHz, Tone burst mode, LNB current 300mA max

---

23.5

## Display Type

### Diagonal screen size

- 55PUS8601 : 139 cm / 55 inch
- 65PUS8601 : 164 cm / 65 inch

### Display resolution

- 3840 x 2160p

---

23.6

## Display Input Resolution

### Video formats

#### Resolution — Refresh rate

- 480i - 60 Hz
- 480p - 60 Hz
- 576i - 50 Hz
- 576p - 50 Hz
- 720p - 50 Hz, 60 Hz
- 1080i - 50 Hz, 60 Hz
- 1080p - 24 Hz, 25 Hz, 30 Hz
- 2160p - 24 Hz, 25 Hz, 30 Hz, 50 Hz, 60 Hz

### Computer formats

#### Resolutions (amongst others)

- 640 x 480p - 60 Hz
- 800 x 600p - 60 Hz
- 1024 x 768p - 60 Hz
- 1280 x 768p - 60 Hz
- 1360 x 765p - 60 Hz
- 1360 x 768p - 60 Hz
- 1280 x 1024p - 60 Hz
- 1920 x 1080p - 60 Hz
- 3840 x 2160p - 24 Hz, 25 Hz, 30 Hz, 50 Hz, 60 Hz

---

23.7

## Dimensions and Weights

### 55PUS8601

#### 55PUS8601

- with TV stand and side speakers:  
Width 1317 mm - Height 758 mm - Depth 227 mm - Weight ±21.5 kg
- with side speakers only:  
Width 1260 mm - Height 709 mm - Depth 41 mm - Weight ±20 kg
- with TV stand only:

Width 1317 mm - Height 758 mm - Depth 227 mm - Weight ±20.5 kg

- without TV stand and side speakers:

Width 1227 mm - Height 709 mm - Depth 41 mm - Weight ±19 kg

#### Philips PTS840 - Central TV Stand\*

In combination with 55PUS8600 and side speakers  
Width 1260 mm - Height 763 mm - Depth 202 mm - Weight ±24 kg

#### Philips PTA860 - Wireless Speaker Stands\*

One speaker stand in combination with 55PUS8600 side speaker.

Height 1262 mm - Base width 160 mm - Base depth (with connections) 210 mm - Weight ±2 kg (1 stand + speaker)

\* Sold separately

---

23.8

## Connectivity

### TV Side

- HDMI 3 in - ARC - HDCP 2.2 - 4K 50/60Hz
- HDMI 4 in - MHL - ARC - HDCP 2.2 - 4K 50/60Hz
- USB 2 - USB 2.0
- USB 3 - USB 3.0 (blue)
- 2x Common Interface slot: CI+/CAM
- Headphones - Stereo mini-jack 3.5mm

### TV Rear

- Audio In (DVI to HDMI) - Stereo mini-jack 3.5mm
- SCART: Audio L/R, CVBS in, RGB
- YPbPr : Y Pb Pr, Audio L/R

### TV Bottom

- HDMI 1 in - ARC - HDCP 2.2 - 4K 50/60Hz
- HDMI 2 in - ARC - HDCP 2.2 - 4K 50/60Hz
- USB 1 - USB 2.0
- Digital Audio Out - Optical Toslink
- Network LAN - RJ45
- Antenna (75Ω), dual tuner
- Satellite tuner 1
- Satellite tuner 2
- For 8601 Series only - Wireless Audio, for Philips PTA860

---

23.9

## Sound

- 3D wOOx
- HD Stereo
- Output power (RMS) : 50W
- Dolby Digital Plus®
- DTS Premium Sound™

# Multimedia

## Connections

- USB 2.0 / USB 3.0
- Ethernet LAN RJ-45
- Wi-Fi 802.11a/b/g/n/ac (built-in)
- BT2.1 with EDR & BT4.0 with BLE

## Supported USB file systems

- FAT 16, FAT 32, NTFS

## Playback formats

- Containers : 3GP, AVCHD, AVI, MPEG-PS, MPEG-TS, MPEG-4, Matroska (MKV), Quicktime (MOV, M4V, M4A), Windows Media (ASF/WMV/WMA)
- Video Codecs : MPEG-1, MPEG-2, MPEG-4 Part 2, MPEG-4 Part 10 AVC (H264), H.265 (HEVC), VC-1, WMV9
- Audio Codecs : AAC, HE-AAC (v1/v2), AMR-NB, Dolby Digital, Dolby Digital Plus, DTS Premium Sound™, MPEG-1/2/2.5 Layer I/II/III (includes MP3), WMA (v2 to v9.2), WMA Pro (v9/v10)
- Subtitles :
  - Formats : SAMI, SubRip (SRT), SubViewer (SUB), MicroDVD (TXT), mplayer2 (TXT), TMPlayer (TXT)
  - Character encodings : UTF-8, Central Europe and Eastern Europe (Windows-1250), Cyrillic (Windows-1251), Greek (Windows-1253), Turkish (Windows-1254), Western Europe (Windows-1252)
- Image Codecs : JPEG, PNG, BMP
- Limitations :
  - Maximum supported total bit rate for a media file is 30Mbps.
  - Maximum supported video bit rate for a media file is 20Mbps.
  - MPEG-4 AVC (H.264) is supported up to High Profile @ L5.1.
  - H.265 (HEVC) is supported upto Main / Main 10 Profile up to Level 5.1
  - VC-1 is supported up to Advanced Profile @ L3.

## Supported media server software (DMS)

- You can use any DLNA V1.5 certified media server software (DMS class).
- You can use the Philips TV Remote app (iOS and Android) on mobile devices.

Performance may vary, depending on the capabilities of the mobile device and the software used.



# Help and Support

## 24.1

### Register your TV

Register your TV and enjoy a range of benefits including full support (including downloads), privileged access to information about new products, exclusive offers and discounts, the chance to win prizes and even participate in special surveys about new releases.

Go to [www.philips.com/TVsupport](http://www.philips.com/TVsupport).

## 24.2

### Using Help

This TV offers help on screen .

#### Open Help

Press  Help OK.

To read the Help as a book, select **Book**. To search for a keyword, select **Keyword**.

You can also open  **Help** in the TV menu.

Before you execute the Help instructions, close Help.

For some activities, like Text (Teletext), the colour keys have specific functions and cannot open Help.

#### TV Help on your tablet, smartphone or computer

To carry out extended sequences of instructions more easily, you can download the TV Help in PDF format to read on your smartphone, tablet or computer. Alternatively, you can print the relevant Help page from your computer.

To download the Help (user manual) go to [www.philips.com/TVsupport](http://www.philips.com/TVsupport).

## 24.3

### Troubleshooting

#### Switch On and Remote Control

The TV does not switch on

- Disconnect the power cable from the power outlet. Wait for one minute then reconnect it.
- Make sure that the power cable is securely connected.

#### Creaking sound at startup or switch off

When you are switching the TV on, off or to standby, you hear a creaking sound from the TV chassis. The creaking sound is due to the normal expansion and

contraction of the TV as it cools and warms up. This does not affect performance.

#### TV does not respond to the remote control

The TV requires some time to start up. During this time, the TV does not respond to the remote control or TV controls. This is normal behaviour.

If the TV continues to be unresponsive to the remote control, you can check if the remote control is working by means of a mobile phone camera. Put the phone in camera mode and point the remote control to the camera lens. If you press any key on the remote control and you notice the infra red LED flicker through the camera, the remote control is working. The TV needs to be checked.

If you do not notice the flickering, the remote control might be broken or its batteries are low.

This method of checking the remote control is not possible with remote controls which are wirelessly paired with the TV.

#### The TV goes back to standby after showing the Philips startup screen

When the TV is disconnected and reconnected to the power supply in standby mode, the startup screen is displayed and then the TV returns to standby mode. This is normal behaviour. To switch on the TV from standby mode again, press  on the remote control or on the TV.

#### The standby light keeps on blinking

Disconnect the power cable from the power outlet. Wait 5 minutes before you reconnect the power cable. If the blinking reoccurs, contact Philips TV Consumer Care.

## Channels

#### No digital channels found during the installation

See the technical specifications to make sure that your TV supports DVB-T or DVB-C in your country. Make sure that all cables are properly connected and that the correct network is selected.

#### Previously installed channels are not in the channel list

Make sure that the correct channel list is selected.

#### DVB-T2 HEVC channel

See the technical specifications to make sure that your TV supports DVB-T2 HEVC in your country and reinstall DVB-T channel.

---

## Picture

### No picture / distorted picture

- Make sure that the antenna is properly connected to the TV.
- Make sure that the correct device is selected as the display source.
- Make sure that the external device or source is properly connected.

### Sound but no picture

- Make sure that the picture settings are set correctly.

### Poor antenna reception

- Make sure that the antenna is properly connected to the TV.
- Loud speakers, unearthed audio devices, neon lights, high buildings and other large objects can influence reception quality. If possible, try to improve the reception quality by changing the antenna direction or moving devices away from the TV.
- If reception on only one channel is poor, fine-tune this channel with Manual Installation.

### Poor picture from a device

- Make sure that the device is connected properly.
- Make sure that the picture settings are set correctly.

### Picture settings change after a while

Make sure that **Location** is set to **Home**. You can change and save settings in this mode.

### A commercial banner appears

Make sure that **Location** is set to **Home**.

### Picture does not fit the screen

Change to a different picture format.

### Picture format keeps changing with different channels

Select a non 'Auto' picture format.

### Picture position is incorrect

Picture signals from some devices may not fit the screen correctly. Check the signal output of the connected device.

### Computer picture is not stable

Make sure that your PC uses the supported resolution and refresh rate.

---

## Sound

### No sound or poor sound quality

If no audio signal is detected, the TV automatically switches the audio output off — this does not indicate malfunction.

- Make sure that the sound settings are correctly set.
- Make sure that all cables are properly connected.

- Make sure that the volume is not muted or set to zero.
- Make sure that the TV audio output is connected to the audio input on the Home Theatre System. Sound should be heard from the HTS speakers.
- Some devices may require you to manually enable HDMI audio output. If HDMI audio is already enabled, but you still do not hear audio, try changing the digital audio format of the device to PCM (Pulse Code Modulation). Refer to the documentation accompanying your device for instructions.

---

## HDMI and USB

### HDMI

- Note that HDCP (High-bandwidth Digital Content Protection) support can delay the time taken for a TV to display content from an HDMI device.
- If the TV does not recognise the HDMI device and no picture is displayed, switch the source from one device to another and back again.
- If the picture and sound of a device connected to **HDMI 1** or **HDMI 2** is distorted, connect the device to **HDMI 3** or **HDMI 4** on this TV.
- If the picture and sound of a device connected with HDMI is distorted, check if a different **HDMI Ultra HD** setting can solve this problem. For more information, in **Help**, select **Keywords** and look up **HDMI Ultra HD**.
- If there are intermittent sound disruptions, make sure that output settings from the HDMI device are correct.
- If you use an HDMI-to-DVI adapter or HDMI-to-DVI cable, make sure that an additional audio cable is connected to AUDIO IN (mini-jack only), if available.

### HDMI EasyLink does not work

- Make sure that your HDMI devices are HDMI-CEC compatible. EasyLink features only work with devices that are HDMI-CEC compatible.

### No volume icon shown

- When an HDMI-CEC audio device is connected and you use the TV Remote Control to adjust the volume level from the device, this behaviour is normal.

### Photos, videos and music from a USB device do not show

- Make sure that the USB storage device is set to Mass Storage Class compliant, as described in the storage device's documentation.
- Make sure that the USB storage device is compatible with the TV.
- Make sure that the audio and picture file formats are supported by the TV.

### Choppy playback of USB files

- The transfer performance of the USB storage device may limit the data transfer rate to the TV which causes poor playback.

---

## Wi-Fi

### Wi-Fi network not found or distorted

- Microwave ovens, DECT phones or other Wi-Fi 802.11b/g/n devices in your proximity might disturb the wireless network.
- We recommend using the 5 GHz frequency (802.11ac) on your router when your TV is placed in the neighborhood of many other wireless routers (apartments, etc.).
- Make sure that the firewalls in your network allow access to the TV's wireless connection.
- For easy installation of your wireless network, do not hide the name of your router by switching off the SSID broadcast.
- If the wireless network does not work properly in your home, you can use the wired network installation.

### Wi-Fi network connection is slow

- Use a high-speed (broadband) Internet connection for your router.
- Limit the amount of devices that use the same router.
- Look in your wireless router's user manual for information on indoor range, transfer rate and other factors of signal quality.

### DHCP

- If the connection fails, you can check the DHCP (Dynamic Host Configuration Protocol) setting of the router. DHCP should be switched on.

---

## Bluetooth

### Unable to pair

- Make sure the device is in pairing mode. Read the user manual of the device.
- Keep the router and wireless speaker as close to the TV as possible.
- Places with a high amount of wireless activity - apartments with lots of wireless routers - can hamper the wireless connection.
- Trying to pair several devices with the TV at the same time, may not work.

### Bluetooth lost connection

- Always position the wireless speaker within a range of 5 meters from the TV.

### Bluetooth Audio and Video synchronisation

- Before you purchase a wireless Bluetooth speaker, inform yourself about its quality of Audio to Video synchronisation, commonly called 'lip sync'. Not all Bluetooth devices perform correctly. Ask your dealer for advice.

---

## Internet

### Internet does not work





- If the connection with the router is OK, check the router connection to the Internet.

---

## Wrong Menu Language

### Wrong menu language

Change the language back to your language.

- 1 - Press  HOME to go to Home screen .
- 2 - Select the  icon (Settings) from System bar on the top of Home screen and press OK.
- 3 - Press 5 times  (down).
- 4 - Press 3 times  (right), select your language and press OK.
- 5 - Press  BACK to close the menu.

---

24.4

## Online Help

To solve any Philips TV related problem, you can consult our online support. You can select your language and enter your product model number.

Go to [www.philips.com/TVsupport](http://www.philips.com/TVsupport).

On the support site you can find your country's telephone number to contact us as well as answers to frequently asked questions (FAQs). In some countries, you can chat with one of our collaborators and ask your question directly or send a question by email. You can download new TV software or the manual to read on your computer.

---

24.5

## Support and Repair

For support and repair, call the Consumer Care hotline in your country. Our service engineers will take care of a repair, if necessary.

Find the telephone number in the printed documentation that came with the TV. Or consult our website [www.philips.com/TVsupport](http://www.philips.com/TVsupport) and select your country if needed.

### TV model number and serial number

You might be asked to provide the TV product model number and serial number. Find these numbers on the packaging label or on the type label on the back or bottom of the TV.

### Warning

Do not attempt to repair the TV yourself. This may

cause severe injury, irreparable damage to your TV or void your warranty.

---

# Safety and Care

---

## 25.1

### Safety

---

#### Important

Read and understand all safety instructions before you use the TV. If damage is caused by failure to follow instructions, the warranty does not apply.

---

#### Risk of Electric Shock or Fire

- Never expose the TV to rain or water. Never place liquid containers, such as vases, near the TV. If liquids are spilt on or into the TV, disconnect the TV from the power outlet immediately. Contact Philips TV Consumer Care to have the TV checked before use.
- Never expose the TV, remote control or batteries to excessive heat. Never place them near burning candles, naked flames or other heat sources, including direct sunlight.
- Never insert objects into the ventilation slots or other openings on the TV.
- Never place heavy objects on the power cord.
- Avoid force coming onto power plugs. Loose power plugs can cause arcing or fire. Ensure that no strain is exerted on the power cord when you swivel the TV screen.
- To disconnect the TV from the mains power, the power plug of the TV must be disconnected. When disconnecting the power, always pull the power plug, never the cord. Ensure that you have full access to the power plug, power cord and outlet socket at all times.

---

#### Risk of Injury or Damage to the TV

- Two people are required to lift and carry a TV that weighs more than 25 kg or 55 lbs.
- If you mount the TV on a stand, only use the supplied stand. Secure the stand to the TV tightly. Place the TV on a flat, level surface that can support the weight of the TV and the stand.
- When wall mounted, ensure that the wall mount can safely bear the weight of the TV set. TP Vision bears no responsibility for improper wall mounting that results in accident, injury or damage.
- Parts of this product are made of glass. Handle with care to avoid injury or damage.

#### Risk of damage to the TV !

Before you connect the TV to the power outlet,

ensure that the power voltage matches the value printed on the back of the TV. Never connect the TV to the power outlet if the voltage is different.

---

#### Risk of Injury to Children

Follow these precautions to prevent the TV from toppling over and causing injury to children:

- Never place the TV on a surface covered by a cloth or other material that can be pulled away.
- Ensure that no part of the TV hangs over the edge of the mounting surface.
- Never place the TV on tall furniture, such as a bookcase, without anchoring both the furniture and TV to the wall or a suitable support.
- Teach children about the dangers of climbing on furniture to reach the TV.

#### Risk of swallowing batteries !

The remote control may contain coin-type batteries which can easily be swallowed by small children. Keep these batteries out of reach of children at all times.

---

#### Risk of Overheating

Never install the TV in a confined space. Always leave a space of at least 10 cm or 4 inches around the TV for ventilation. Ensure curtains or other objects never cover the ventilation slots on the TV.

---

#### Lightning Storms

Disconnect the TV from the power outlet and antenna before lightning storms. During lightning storms, never touch any part of the TV, power cord or antenna cable.

---

#### Risk of Hearing Damage

Avoid using earphones or headphones at high volumes or for prolonged periods of time.

---

#### Low Temperatures

If the TV is transported in temperatures below 5°C or 41°F, unpack the TV and wait until the TV temperature reaches room temperature before connecting the TV to the power outlet.

---

## Humidity

In rare occasions, depending on temperature and humidity, minor condensation can occur on the inside of the TV glass front (on some models). To prevent this, do not expose the TV to direct sunlight, heat or extreme humidity. If condensation occurs, it will disappear spontaneously while the TV is playing for a few hours.

The condensation moisture will not harm the TV or cause malfunction.

---

25.2

## Cleaning

- Never touch, push, rub or strike the screen with any object.
- Unplug the TV before cleaning.
- Clean the TV and frame with a soft damp cloth and wipe gently. Avoid touching the Ambilight LEDs on the backside of the TV. Never use substances such as alcohol, chemicals or household cleaners on the TV.
- To avoid deformations and colour fading, wipe off water drops as quickly as possible.
- Avoid stationary images as much as possible.

Stationary images are images that remain onscreen for extended periods of time. Stationary images include onscreen menus, black bars, time displays, etc. If you must use stationary images, reduce screen contrast and brightness to avoid screen damage.

---

25.3

## Screen Care

- Never touch, push, rub or strike the screen with any object.
- Unplug the TV before cleaning.
- Clean the TV and frame with a soft damp cloth and wipe gently. Avoid touching the Ambilight LEDs on the backside of the TV. Never use substances such as alcohol, chemicals or household cleaners on the TV.
- To avoid deformations and colour fading, wipe off water drops as quickly as possible.
- Avoid stationary images as much as possible.

Stationary images are images that remain onscreen for extended periods of time. Stationary images include onscreen menus, black bars, time displays, etc. If you must use stationary images, reduce screen contrast and brightness to avoid screen damage.

---

# Terms of Use

---

## 26.1

## Terms of Use – TV

2016 © TP Vision Europe B.V. All rights reserved.

This product was brought to the market by TP Vision Europe B.V. or one of its affiliates, hereinafter referred to as TP Vision, which is the manufacturer of the product. TP Vision is the warrantor in relation to the TV with which this booklet was packaged. Philips and the Philips Shield Emblem are registered trademarks of Koninklijke Philips N.V.

Specifications are subject to change without notice. Trademarks are the property of Koninklijke Philips N.V or their respective owners. TP Vision reserves the right to change products at any time without being obliged to adjust earlier supplies accordingly.

The written material packaged with the TV and the manual stored in the memory of the TV or downloaded from the Philips website [www.philips.com/support](http://www.philips.com/support) are believed to be adequate for the intended use of the system.

The material in this manual is believed adequate for the intended use of the system. If the product, or its individual modules or procedures, are used for purposes other than those specified herein, confirmation of their validity and suitability must be obtained. TP Vision warrants that the material itself does not infringe any United States patents. No further warranty is expressed or implied. TP Vision cannot be held responsible neither for any errors in the content of this document nor for any problems as a result of the content in this document. Errors reported to Philips will be adapted and published on the Philips support website as soon as possible.

Terms of warranty – Risk of injury, damage to TV or void of warranty!

Never attempt to repair the TV yourself. Use the TV and accessories only as intended by the manufacturer. The caution sign printed on the back of the TV indicates risk of electric shock. Never remove the TV cover. Always contact Philips TV Customer Care for service or repairs. Find the telephone number in the printed documentation that came with the TV. Or consult our website [www.philips.com/support](http://www.philips.com/support) and select your country if needed. Any operation expressly prohibited in this manual, or any adjustments and assembly procedures not recommended or authorised in this manual, shall void the warranty.

Pixel characteristics

This TV product has a high number of colour pixels. Although it has effective pixels of 99.999% or more,

black dots or bright points of light (red, green or blue) may appear constantly on the screen. This is a structural property of the display (within common industry standards) and is not a malfunction.

CE compliance

Hereby, TP Vision Europe B.V. declares that this television is in compliance with the essential requirements and other relevant provisions of Directives 2014/53/EU (RED), 2009/125/EC (Eco Design), 2010/30/ EU (Energy Labelling) and 2011/65/EC (RoHS).

Compliance with EMF

TP Vision manufactures and sells many products targeted at consumers which, like any electronic apparatus, in general have the ability to emit and receive electromagnetic signals. One of TP Vision's leading business principles is to take all necessary health and safety measures for our products, to comply with all applicable legal requirements and to stay well within the Electro Magnetic Field (EMF) standards applicable at the time of producing the products.

TP Vision is committed to developing, producing and marketing products that cause no adverse health effects. TP Vision confirms that, as long as its products are handled properly for their intended use, they are safe to use according to scientific evidence available today. TP Vision plays an active role in the development of international EMF and safety standards, enabling TP Vision to anticipate further developments in standardisation for early integration in its products.

## 26.2

---

## Terms of Use – Philips TV Collection

For more information, in **Help**, select **Keywords** and look up **Terms of Use, Philips TV Collection** for more information.

---

# Copyrights

---

27.1

## MHL

MHL, Mobile High-Definition Link and the MHL Logo are trademarks or registered trademarks of the MHL, LLC.



27.2

## HDMI

The terms HDMI and HDMI High-Definition Multimedia Interface, and the HDMI Logo are trademarks or registered trademarks of HDMI Licensing LLC in the United States and other countries.



27.3

## Dolby Digital Plus

Manufactured under license from Dolby Laboratories. Dolby and the double-D symbol are trademarks of Dolby Laboratories.



27.4

## DTS Premium Sound™

For DTS patents, see <http://patents.dts.com>. Manufactured under license from DTS Licensing Limited. DTS, the Symbol, & DTS and the Symbol together are registered trademarks, and DTS Premium Sound is a trademark of DTS, Inc. © DTS, Inc. All Rights Reserved.



27.5

## Microsoft

### Windows Media

Windows Media is either a registered trademark or trademark of Microsoft Corporation in the United States and/or other countries.



### Microsoft PlayReady

Content owners use Microsoft PlayReady™ content access technology to protect their intellectual property, including copyrighted content. This device uses PlayReady technology to access PlayReady-protected content and/or WMDRM-protected content. If the device fails to properly enforce restrictions on content usage, content owners may require Microsoft to revoke the device's ability to consume PlayReady-protected content. Revocation should not affect unprotected content or content protected by other content access technologies. Content owners may require you to upgrade PlayReady to access their content. If you decline an upgrade, you will not be able to access content that requires the upgrade.

27.6

## Wi-Fi Alliance

Wi-Fi®, the Wi-Fi CERTIFIED logo, the Wi-Fi logo are registered trademarks of the Wi-Fi Alliance.





## Kensington

(If applicable)

Kensington and Micro Saver are registered US trademarks of ACCO World Corporation with issued registrations and pending applications in other countries throughout the world.



## Other Trademarks

All other registered and unregistered trademarks are the property of their respective owners.

# Disclaimer regarding services and/or software offered by third parties

Services and/or software offered by third parties may be changed, suspended, or terminated without prior notice. TP Vision does not bear any responsibility in these sorts of situations.

---

# Index

## A

- Age Rating 20
- Ambilight, Settings 57
- Android Settings 40
- Announcements 85
- Antenna, Antenna Connection 6
- APP locks 43
- Apps 42
- Audio Description 66
- Auto Volume Levelling 56

## B

- Bass 55
- Batteries, Bluetooth Remote Control 11
- Bluetooth 30
- Bluetooth, Pairing 30
- Bluetooth, Remove device 31
- Bluetooth, Select device 31
- Brightness 51

## C

- Camcorder, connect 34
- Care of the Screen 94
- Channel 18
- Channel List Copy 17
- Channel List Copy, copy 17
- Channel List Copy, current version 18
- Channel List Copy, upload 18
- Channel, age rating 20
- Channel, Channel List, about 18
- Channel, Channel List, filter 24
- Channel, Channel List, open 19
- Channel, Channel List, search 19
- Channel, Satellite Installation 13
- Channel, switch to a channel 19
- Clear Internet Memory 39
- Colour 50
- Colour Enhancement 51
- Colour Temperature 51
- Colour, colour control 52
- Computer, connect 35
- Connect, Headphones 31
- Connection, Power Cable 5
- Connectivity Guide 25
- Consumer Care 91
- Contrast 51
- Contrast Mode 52
- Contrast, Perfect Contrast 53
- Contrast, Video Contrast 53
- Custom Colour Temperature 51

## D

- Disposal of TV or Batteries 86
- DMR, Digital Media Renderer 39

## E

- EasyLink, HDMI-CEC 26
- Eco Settings 60
- End of use 86

## G

- Game Console, connect 31
- Gamepad, connect 32

- Gamma 53

## H

- Hard of Hearing 65
- HDMI MHL 26
- HDMI Ultra HD 62
- HDMI, ARC 25
- HDR Programmes 53
- HDR Upscaling 53
- Headphone Volume 55
- Hearing impaired 66
- Home Screen 41
- Hue 52

## I

- Installation, USB Hard Drive 33
- Internet memory, clear 38

## L

- Light Sensor 53

## M

- Media Files, from a Cloud Storage 68
- Media Files, from a Computer or NAS 68
- Media Files, from a USB Drive 68
- Motion, Clear LCD 54
- Motion, Perfect Natural Motion 54
- MPEG Artefact Reduction 54
- Multi View 83

## N

- Network Installation 37
- Network, connect 37
- Network, settings 38
- Network, Static IP 38
- Network, Switch on Wi-Fi 39
- Network, TV Network Name 39
- Network, View Settings 38
- Network, Wi-Fi Smart Screen 39
- Network, Wired 38
- Network, Wireless 37
- Network, WoWLAN 38
- Network, WPS 37
- Network, WPS with PIN code 37
- Noise Reduction 53
- Now on TV 80

## O

- Online support 91

## P

- Parental Rating 20
- Partially Sighted 65
- Pause TV 74
- Perfect Natural Motion 54
- Philips Logo, Brightness 61
- Photo camera, connect 34
- Photos, Videos and Music 68
- Picture Format 54
- Picture Style 50
- Placement, TV placement 5
- Placement, Viewing distance 5
- Power Off 12

- Power On 12
- Problems, HDMI Connection 90
- Problems, Picture 90
- Problems, Remote Control 89
- Problems, Sound 90
- Problems, USB Connection 90
- Programmes, Recommendations 80

## Q

- Quick Picture Setting 55

## R

- Remote Control Keyboard 10
- Remote Control, Overview 8
- Remote Control, Receiver 11
- Remote Control, Voice Search 9

## S

- Safety Instructions 93
- Satellite CAMs 13
- Satellite Connection, Satellite Dish 6
- Satellite Installation 13
- Satellite, Add Satellite 14
- Satellite, Channel packages 13
- Satellite, Manual Channel Update 14
- Satellite, Manual Installation 15
- Satellite, Remove Satellite 14
- Satellite, Unicable 14
- Saturation 52
- Screen Care 94
- Sharpness 51
- Sleep Timer 65
- Sound Style 55
- Sound, Auto Volume Levelling 56
- Standby Mode 12
- Switch Off Timer 60

## T

- Teletext 22
- Terms of Use 95
- Terms of Use, Philips TV Collection 40
- Treble 55
- TV Guide Data 71
- TV on Demand 80

## U

- Ultra Resolution 53
- Unicable 14
- Universal Access 65
- Update Software 84
- USB Flash Drive, connect 34
- USB Keyboard 33

## V

- Video on Demand 80
- Video Selection 21
- Visually impaired 66
- Voice Search, Remote Control 9

## W

- Watch TV 19
- Wi-Fi 37
- Wired Network 38
- Wireless Network 37

## Y

- YPbPr Connection 27



All registered and unregistered trademarks are property of their respective owners.  
Specifications are subject to change without notice.  
Philips and the Philips' shield emblem are trademarks of Koninklijke Philips N.V.  
and are used under license from Koninklijke Philips N.V.  
2017 © TP Vision Europe B.V. All rights reserved.

[philips.com](http://philips.com)