



OWNER'S MANUAL

LG Digital Signage

(MONITOR SIGNAGE)

Please read this manual carefully before operating your set and retain it for future reference. This product is primarily designed for the display and reception of audio-visual signals.

10SM3TB

Table of contents

3 SAFETY PRECAUTIONS

- 3 Precautions When Installing the Product
- 6 Precautions to the AC Adapter and Power
- 8 Precautions When Moving the Product
- 9 Precautions When Using the Product
- 11 Precautions When Cleaning the Product
- 12 Precautions When Experiencing Image Sticking

13 ASSEMBLY AND PREPARATION

- 14 Parts and Buttons
- 14 Installing in Portrait Position
- 15 Installing the Wall Mount Plate
- 15 Installing on the Wall

17 CONNECT A USB/MICRO SD STORAGE DEVICE

- 19 Supported Multimedia Files

20 TROUBLESHOOTING

23 PRODUCT SPECIFICATIONS

Safety precautions

The following precautions exist to prevent accidental damage or personal injury by helping users to handle the product safely and correctly.

Precautions are given in two forms, i.e. 'WARNING' and 'CAUTION'; as explained below.

⚠ WARNING: Failure to follow the instructions may cause serious injury and even death.

⚠ CAUTION: Failure to follow the instructions may cause injury to persons or damage to the product.

⊘ Prohibited: This symbol describes behaviors or actions which are not permitted.

⚠ WARNING

- Indoor use only.

Precautions When Installing the Product

⚠ WARNING

Failure to observe these instructions may result in serious injury or death.



Do not place the product close to heat sources such as radiators, fires, stoves, etc.

- There is risk of fire.



Do not allow children to hang from or climb on the product.

- Instruct children to be careful not to drop or tip the product over. This may cause personal injury or damage to the product.



Do not install the product in a damp or dusty area.

- This may create a fire hazard or result in electric shock or damage to the product.



If the product has been dropped or its case is damaged, turn off the power and unplug the power cord from the power outlet.

- This may create a fire hazard or result in electric shock. Contact the service center.



Do not drop or apply a shock to the product; do not throw any objects on the panel, such as toys.

- Otherwise, this may result in damage to the product, malfunction or personal injury.

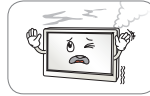

When there is smoke or a strange smell or sound emitting from the product, disconnect the power cord and then contact the service center.

- This may create a fire hazard or result in electric shock.



Do not leave the power or signal cable, etc. in walkways.

- If you step on or fall over the cable, it may cause fire, electric shock, product damage, or personal injury.



Keep the anti-moisture material or vinyl film used for packaging the product out of reach of children.

- If swallowed by mistake, force it to be vomited and visit the nearest hospital.

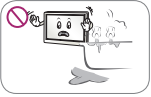

Do not use the product in a damp place such as a bathroom where it is likely to get wet.

- This may create a fire hazard or result in electric shock or malfunction.



Do not insert pieces of metal, such as coins, hairpins and metal debris, or flammable materials, such as paper or matches, into the product. Instruct the children to follow the instructions.

- This may create a fire hazard or result in electric shock. If foreign materials fall into the Device, disconnect the power cord and then contact the service center.



Do not install the product on the wall by yourself. The product should be installed by a qualified professional specified by the retail store.

- Installing the product without a qualified professional is dangerous and may cause injury.



Do not install the product onto a wall that is close to sources of oil or oil mist.

- Otherwise, it may result in damage to the product and cause the product to fall.

⚠ CAUTION

Failure to observe these instructions may result in minor injury or damage to the product.

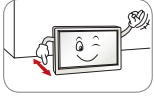

Ensure that the product is installed a certain distance (at least 10 cm) away from the wall for good ventilation.

- Failure to do so may result in the deformation of the product or a fire due to the increase in the internal temperature.

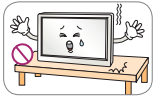

When placing the product on a table or shelf, be careful not to put it near the edge.

- The product may fall, causing personal injury or damage to the product. Make sure you use a TV cabinet or stand that fits the TV.

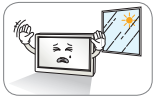

Keep the product away from direct sunlight.

- Failure to do so may result in fire or damage to the product.



Do not place the Device close to sources of steam or oil, such as humidifiers and kitchen counters.

- This may result in electric shock or fire.



If you are using an outdoor antenna, please install it away from electrical wires to make sure it does not touch any nearby wires even if it falls down due to heavy wind.

- This may cause an electric shock.

(Only applicable to products supporting the TV function.)

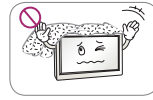

Make sure the air vent is not blocked by a tablecloth or curtain.

- Failure to do so may result in the deformation of the product or a fire due to the increase in the internal temperature.

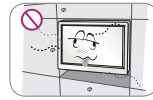

Do not install the product in an area with poor ventilation (e.g. on a bookshelf, in a closet) or outside, and avoid placing on cushions or carpets.

- This could result in fire due to increased internal temperature.



Do not place the product on an unstable or vibrating surface such as a vibrating shelf or tilted surface.

- The product may fall or flip over and cause injury.



Because the handling of antennas requires skill and experience, please make sure you consult your dealer or service center.

- This may cause an electric shock.

(Only applicable to products supporting the TV function.)



Do not install the product in a place with electromagnetic interference. (Only applicable to products supporting the TV function.)

- Do not install the product in an area with poor ventilation (e.g. on a bookshelf or in a closet) or outside, and avoid placing on cushions or carpets.
- In addition, do not install it in close proximity to hot objects, such as lights.

If you install the product in a place that does not meet the general conditions, this may cause serious damage to the product's picture quality, life cycle and appearance. Please check with our service engineer before installing in such a place.

Unusual places: * Places or conditions where much fine dust is generated, many sources of oil or oil mist are generated, many chemical substances are used, the temperature is too high or low, the humidity is too high, and the product is likely to be used for a long period of time (airport and train station).

Precautions to the AC Adapter and Power

⚠ WARNING

Failure to observe these instructions may result in serious injury or death.



If water or any foreign substance goes inside the product (TV, Device, power cord, or AC adapter), disconnect the power cord immediately and contact the service center.

- Otherwise, this may cause a fire or electric shock due to damage to the product.

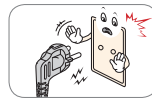

Always connect the power cord to a grounded outlet.

- Failure to do so may result in electric shock or personal injury.



Do not touch the power cord or the signal cable in the event of thunder and lightning.

- There is risk of electric shock. (Only applicable to products supporting the TV function.)



Do not touch the power plug or AC adapter with wet hands. If the pins of the plug are wet or dusty, wipe and dry them before use.

- Otherwise, this may cause a fire or electric shock.



Insert the power plug securely so that it does not come loose. Do not use the product if the power outlet is loose.

- A bad connection may cause a fire or electric shock.

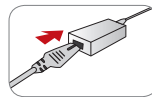

Make sure to completely insert the power cord into the AC adapter.

- If loosely connected, the poor connection may cause a fire or electric shock.



Do not insert a conductor such as a chopstick into the other side of the wall outlet while the power cord is inserted into the wall outlet. Also, avoid touching the power plug immediately after pulling it out of the wall outlet.

- This may cause electric shock.



Be sure to use power cords and AC adapters provided or approved by LG Electronics, Inc.

- The use of non-approved products may cause a fire or electric shock.

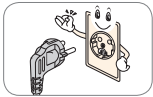

Use the product at the rated voltage only.

- Failure to do so may result in damage to the product or electric shock.

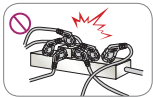

Do not use a multi-tap outlet shared with many devices. Use a dedicated multi-tap outlet with a ground terminal.

- Otherwise, this may result in fire due to excessive heat.



Disconnect the power cable when the product will not be used for a long period of time.

- Dust that accumulates may result in electrical short circuits, electric shock or fire due to overheating, ignition or insulation degradation.

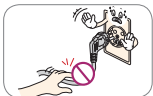

When unplugging the power cord, always pull it by the plug. Do not bend the power cord with excessive force.

- This may cause a fire or electric shock.

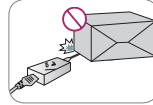

Be careful not to step or place heavy objects (electronic appliances, clothing, etc.) on the power cord or AC adapter. Be careful not to damage the power cord or AC adapter with sharp objects.

- Damaged power cords may cause a fire or electric shock.



Never disassemble, repair or modify the power cord or AC adapter.

- This may cause a fire or electric shock.

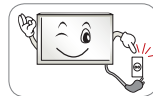

To turn off the main power, remove the power cord, which should be positioned so it is easy to access for operation.

- If the product is connected to the AC wall outlet, it is not disconnected from the AC power source even if you turn off the switch.
- Remove the power to reduce energy usage to '0'.

⚠ CAUTION

Failure to observe these instructions may result in minor injury or damage to the product.



Do not remove the power cord when the product is in use.

- Otherwise, the product may be damaged due to the sudden loss of power.



Be sure to keep the outlet, AC adapter, and pins of the power plug clean from dust and etc.

- This may cause a fire.



Do not turn the Device on or off by plugging in the power plug or unplugging it from the power outlet. (Do not use the power plug as a switch.)

- This may create a fire hazard or result in electric shock.



Keep the power cord away from any heating devices.

- The cord coating may melt and cause fire or electric shock.

- You can use PoE (Power over Ethernet) through the power-sourcing equipment by using a LAN cable. Removing the AC adapter while it is being used with PoE may cause a malfunction.

Precautions When Moving the Product**⚠ WARNING**

Failure to observe these instructions may result in serious injury or death.

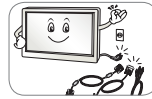

Before moving the product, disconnect the power cord and all other cables connected.

- Otherwise, this may cause a fire or electric shock.

- When carrying the product, make sure the screen faces forward and hold it firmly in both hands.

⚠ CAUTION

Failure to observe these instructions may result in minor injury or damage to the product.

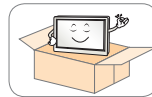

Do not discard the delivery box with the original packaging.

- Put the product in the box when carrying it.

Precautions When Using the Product

⚠ WARNING

Failure to observe these instructions may result in serious injury or death.



Do not disassemble, repair or modify the product by yourself.

- Otherwise, this may cause a fire or electric shock. If the product needs to be checked, reset or repaired, contact the service center.



Do not allow water to get into the product and do not let the product get wet.

- Failure to do so may result in fire, electric shock, malfunction or deformation.

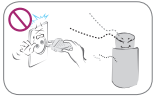

If there is a gas leak, do not touch the power outlet, and open the windows for ventilation..

- This may create a fire hazard or result in electric shock.



Do not impact the front or sides of the screen with a hard object, such as a metal object, and do not scratch the screen.

- This can result in damage to the screen.



In the event that liquid or a foreign object falls into the product, please switch it off and unplug it from the wall outlet and contact the service center.

- This may create a fire hazard or result in electric shock.



In the event that no image appears on the screen or no sound is heard, stop using the product. Switch it off immediately, unplug it from the power outlet and contact the service center.

- This may create a fire hazard or result in electric shock.
- Do not use the product in any environment with too high temperature or high humidity.
- Do not use high-voltage electrical goods near the Device. This may result in Device malfunction due to an electric shock. (e.g. electric mosquito swatter)

⚠ CAUTION

Failure to observe these instructions may result in minor injury or damage to the product.

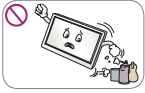

Do not use or store the product near inflammables.

- This may result in fire or explosion.



Take a break to protect your health and vision when using the product for a long period.



Displaying a still image for a prolonged time may cause damage to the screen, resulting in the retention of the image.

- Damage incurred as a result of this is not covered by the product warranty.



Do not push hard or scratch the screen surface with your hands or sharp objects, such as a nail, pencil or pen.

- This may result in the damage to the screen surface and cause it to malfunction.

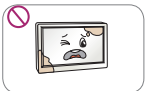

Keep the product clean.



Set up the product with suitable resolution and frequency in accordance with the owner's manual. (Available for PC-supported model only)

- You may experience blurred vision.



Since the LCD requires high technology consisting of hundreds of pixels, when using the product, pixilated spots (red, green, white or black) may appear on the screen depending on the circumstances.

- This is normal for an LCD screen and not an error, nor is it related to the Device's performance.



Do not leave the product in places where it is likely to get wet and do not place anything containing liquid on top of the product such as a flower vase.

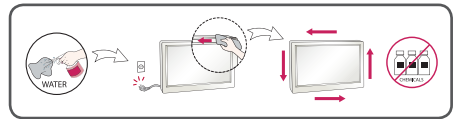

Spray water onto a soft cloth 2 to 4 times, and use it to clean the front frame; wipe in one direction only.

- Too much moisture may cause staining.

Precautions When Cleaning the Product

⚠ WARNING

Failure to observe these instructions may result in serious injury or death.



Do not spray water directly onto the product and do not use inflammable materials such as thinner or benzene to wipe the product.

- This may create a fire hazard or result in electric shock.



Contact the sales representative or service center for internal cleaning of the product approximately once a year.

- If you do not clean the product, dust will accumulate inside and may create a fire hazard or malfunction.

⚠ CAUTION

Failure to observe these instructions may result in minor injury or damage to the product.



To clean the product, unplug the power cord and wipe it gently with a soft cloth. Do not spray with water or wipe with a wet cloth.

When cleaning the product or the screen, do not use cleanser, automobile or industrial shiner, abrasive or wax, benzene, alcohol, etc., as this may damage the product.

- This may create a fire hazard, and result in electric shock or product damage (deformation, corrosion or breakage).

Precautions When Experiencing Image Sticking

- Displaying a still image for a prolonged time may cause damage to the screen, resulting in the retention of the image.
- Most third-party products have the same issue. Damage resulting from long-term static images is not covered by product warranty.

ASSEMBLY AND PREPARATION

CAUTION

- Always use genuine components to ensure safety and product performance.
- The product warranty will not cover damage or injury caused by the use of counterfeit components.



NOTE

- The warranty will not cover any damages caused by using the product in an excessively dusty environment.

Parts and Buttons

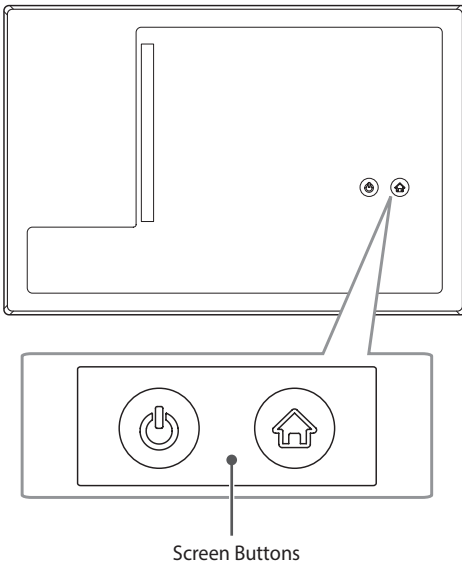
- The image may differ depending on the model.



- : Turns on/off.
- : Go to the Home screen.

Installing in Portrait Position

- The Device can be installed in portrait position.

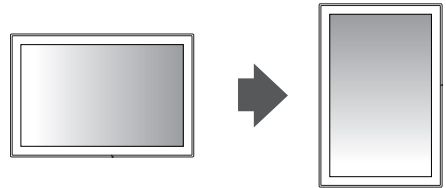

Using the Kensington lock

(This feature is available only on certain models.)

The Kensington security system connector is located on the back of the Device. For more information on installation and usage, refer to the Kensington lock owner's manual or visit the website: <http://www.kensington.com>.

Connect the Kensington security system cable between the Device set and a table.

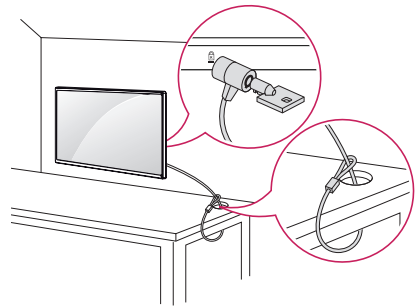

NOTE

- The Kensington security system is optional. You can obtain additional accessories from most electronics stores.
- The illustration shows a general installation and may differ from the actual product.

Installing the Wall Mount Plate

This Device meets the specifications for the wall mount plate or other compatible devices.

- 1 Place the screen face down. To protect the screen from scratches, cover the surface with a soft cloth.
- 2 Place the wall mount plate onto the Device and align it with the screw holes.
- 3 Using a screwdriver, tighten the four screws to fix the plate onto the Device.

! NOTE

- The wall mount plate is sold separately.
- For more information on installation, refer to the wall mount plate's installation guide.
- Be careful not to apply too much force while mounting the wall mount plate as it may cause damage to the screen.

Installing on the Wall

Install the Device at least 100 mm away from the wall on each side of the Device to ensure sufficient ventilation.

Detailed installation instructions can be obtained from your local retail store. Please refer to the manual to install and set up a tilting wall mounting bracket.

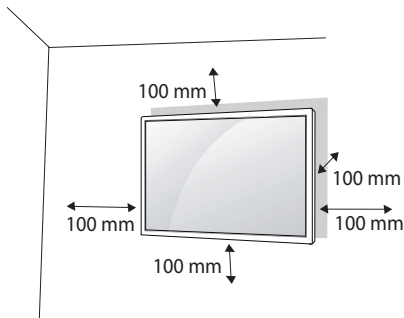

To install the Device to a wall, attach a wall mounting bracket (optional) to the back of the Device.

Make sure that the wall mounting bracket is securely

- 1 If you use longer screws than the standard length, it may damage the inside of the Device.
- 2 A non-VESA standard screw may damage the product and cause the Device to fall. LG Electronics is not liable for any accidents relating to the use of non-standard screws.

Wall Mount (A x B)	50 x 50
Screw specifications	M4 x L10
Number of screws required	4

- Wall Mount (A x B)

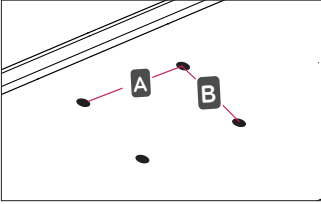

! NOTE

- Use the screws specified by VESA standards.
- The wall mount kit includes the installation guide and all necessary parts.
- The wall mounting bracket is optional.
- The length of the screw may differ for each wall mounting bracket. Be sure to use the proper length.
- For more information, please refer to the user manual for the wall mounting bracket.

! CAUTION

- Unplug the power cord before moving or installing the Device to avoid electric shock.
- Installing the Device on the ceiling or on a slanted wall may result in the Device falling off, which could lead to injury.
- Applying excessive force when tightening screws may cause damage to the Device. Damage caused in this way will not be covered by the product warranty.
- Use the wall mounting bracket and screws that conform to VESA standards. Damage caused by the use or misuse of inappropriate components will not be covered by the product warranty.
- To prevent injury, this apparatus must be securely attached to the wall in accordance with the installation instructions. (This pertains only to Australia and New Zealand.)
- When measured from the back of the Device, the length of each installed screw must be 8 mm or less.

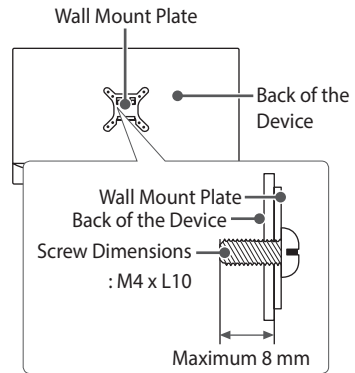

Connect a USB/Micro SD storage device

Connect a USB storage device, such as a USB flash memory, Micro SD storage device, to the display device to use multimedia features.

CAUTION

- Do not turn the Device off or remove the USB storage device when the multimedia screen is activated. This may cause the loss of a file or damage to a USB storage device.
- Back up your files saved on a USB storage device frequently, as you may lose or damage the files and this may be not covered by the warranty.
- Devices using a power source such as a USB HDD are not supported.
- USB HIDs such as mice and keyboards are not supported.
- For USB 3.0 devices, compatibility is not guaranteed.

Tips for Using USB/Micro SD Storage Devices

- Only USB storage devices are recognized.
- The USB may not work properly when it is connected through a USB hub.
- A USB storage device using an automatic recognition program may not be recognized.
- A USB storage device which uses its own driver may not be recognized.
- The recognition speed of a USB storage device may depend on each device.
- Please do not turn off the display or unplug the USB device when the connected USB storage device is working. When such a device is suddenly disconnected or unplugged, the stored files or the USB storage device may be damaged.
- Please do not connect USB storage devices which were artificially created on the PC. The device may cause the product to malfunction or fail to play. Remember to use only a USB storage device which has normal music files, image files or movie files.
- Storage devices formatted with utility programs that are not supported by Windows may not be recognized.
- Please connect power to a USB storage device (over 0.5 A) which requires an external power supply. Otherwise, the device may not be recognized.
- Please connect a USB storage device with the cable offered by the device maker.
- Some USB storage devices may not be supported or operated smoothly.
- The file arrangement method for USB storage devices is similar to that of Windows, and file names can be recognized up to 100 English characters.
- Be sure to back up important files since data stored in a USB memory device may be damaged. We will not be responsible for any data loss.
- If your USB storage device has multiple partitions, or if you use a USB multi-card reader, you can use up to four partitions or USB memory devices.
- If a USB storage device is connected to a USB multi-card reader, its volume data may not be detected.
- If the USB storage device does not work properly, remove it and connect it again.
- The speed at which a USB storage device is detected differs from device to device.
- The recommended capacity is 32 GB or less for a USB memory drive.
- Any device with more than the recommended capacity may not work properly.
- USB storage devices (USB 2.0 or below) are also supported. However, they may not work properly in the videos list.
- Micro SD supports SDHC type. To use an SDXC card, format it to the NTFS file system first.
- The exFAT file system may not work properly for Micro SD and USB storage devices.

Supported Multimedia Files

CAUTION

- Some files may not be played if there is no supporting codec.

Supported Video Codecs

- H.263, H.264 AVC, MPEG-4 SP, VP8

Supported Music Codecs

- AAC LC/LTP, HE-AACv1 (AAC+), HE-AACv2 (enhanced AAC+), AAC ELD (enhanced low delay AAC), AMR-NB, AMR-WB, FLAC, MP3, MIDI, Ogg Vorbis, PCM/WAVE

Supported Video Codecs

- JPEG, GIF, PNG, BMP, WebP

TROUBLESHOOTING

No image is displayed.

Problem	Action
Is the product power cord connected?	<ul style="list-style-type: none"> • Check if the power cord is correctly plugged into the power outlet.
The screen will not turn on.	<ul style="list-style-type: none"> • Press and hold the power button for more than a second.

Image sticking occurs on the product.

Problem	Action
Image sticking occurs when the product is turned off.	<ul style="list-style-type: none"> • If you display a fixed image for a long time, the pixels may be damaged quickly. Use the screen saver function. • When a dark image is displayed on the screen after an image with high contrast (black and white or gray), this may cause image sticking. This is normal for LCD screen products.

The audio function does not work.

Problem	Action
No sound is heard and only the LED or the screen is turned on.	<ul style="list-style-type: none"> • Adjust the volume. • See if the audio is set properly.
Sound is too low.	<ul style="list-style-type: none"> • Adjusts the volume level.

Screen color is abnormal.

Problem	Action
Do black spots appear on the screen?	<ul style="list-style-type: none"> • Several pixels (red, green, white or black color) may appear on the screen, which may be attributable to the unique characteristics of the LCD panel. It is not a malfunction of the LCD.

The operation does not work normally.

Problem	Action
The power suddenly turned off.	<ul style="list-style-type: none"> • Has the Timer been set? • Check the power control settings. Power supply is interrupted.
Touch does not work at all.	<ul style="list-style-type: none"> • This may happen when using an uncertified AC adapter. Make sure you use the adapter provided at the time of purchasing the product.
The Device will not turn on.	<ul style="list-style-type: none"> • Try turning the power on after disconnecting the AC adapter and cleaning the contacting port.
Photo/video or multimedia content is not played.	<ul style="list-style-type: none"> • An additional service provider supports the content officially provided. Other content (sound, video or background) distributed via Internet may not be played.

Others

Problem	Action
The product generates heat.	<ul style="list-style-type: none"> • It is normal that the product generates heat when it is used for games or the Internet for a long time. It does not affect the product's life and performance.
Data you saved has been deleted.	<ul style="list-style-type: none"> • In the event the data is damaged due to a Device reset or malfunction, it cannot be restored if you have not backed up your data. It is recommended that you back up data in advance. The manufacturer bears no responsibility for any data loss.
I want to upgrade the memory.	<ul style="list-style-type: none"> • Memory upgrade is not available for this device.

⚠ CAUTION

- Displaying a still image for a long time may cause damage to the screen, resulting in a ghost image. Damage incurred as a result of this is not covered by the product warranty.
- Image sticking does not occur when displaying constantly changing images but may occur when displaying a fixed image for an extended period of time. Therefore, it is recommended that you use the instructions below to decrease the likelihood of image sticking occurring when using a fixed image. It is recommended that you change the screen at least once every 12 hours at the minimum; if done more frequently, the prevention of image sticking is more effective.

Recommended operating conditions

- 1 Change the background and the character colors at the same time interval.



When changing colors, using complementary colors helps to prevent image sticking.

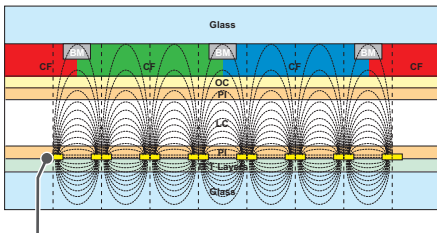

ITO or MoTi Pixel Layer

- 2 Change the image at the same time interval.

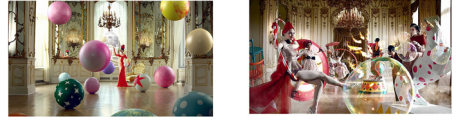

Make sure that the characters or images before changing the image remain in the same location after changing the image.

What is image sticking?

When the LCD panel displays a static image for an extended period of time, it can cause a voltage difference between the electrodes that operate the liquid crystals. When the voltage difference between the electrodes builds up over time, liquid crystals have a tendency to remain aligned in one direction. During this process, a previously displayed image remains visible. This phenomenon is referred to as the "image sticking".

PRODUCT SPECIFICATIONS

Specifications are subject to change without notice.

LCD screen	Screen Type	Thin Film Transistor (TFT) Liquid Crystal Display (LCD) Screen 1280 x 800 @ 60 Hz
Input/output ports		LAN/PoE (802.3at Type 1), DC-IN (Adaptor 19 V ) , USB IN, Micro SD
Environmental Conditions	Operating Temperature	0 °C to 40 °C
	Operating Humidity	10 % to 80 %
	Storage Temperature	-20 °C to 60 °C
	Storage Humidity	5 % to 95 %

~ refers to alternating current (AC), and  refers to direct current (DC).

10SM3TB

LCD screen	Pixel pitch	0.1695 mm (H) x 0.1695 mm (V)
Power	Power consumption	On Mode: 10 W (Typ.) Off Mode: ≤ 1.0 W
Dimensions (Width x Height x Depth) / Weight	Head	245.6 mm x 164.2 mm x 29.7 mm / 0.69 kg
AC/DC adapter	ADS-40SG-19-3 19025G type, manufactured by SHENZHEN HONOR ELECTRONIC or ADS-40FSG-19 19025GPG-1 type, manufactured by SHENZHEN HONOR ELECTRONIC or ADS-40FSG-19 19025GPI-1 type, manufactured by SHENZHEN HONOR ELECTRONIC or ADS-40FSG-19 19025GPCU-1 type, manufactured by SHENZHEN HONOR ELECTRONIC or ADS-40FSG-19 19025GPB-2 type, manufactured by SHENZHEN HONOR ELECTRONIC	
	19 V  1.3 A	

Wireless module(LGSBW41)Specifications			
Wireless LAN		Bluetooth	
Standard	IEEE 802.11a/b/g/n	Standard	Bluetooth Version 4.0
Frequency range (MHz)	2400 to 2483.5 5150 to 5250 5725 to 5850 (for Non EU)	Frequency range (MHz)	2400 to 2483.5
<ul style="list-style-type: none"> • Because band channel used by the country could be different, the user can not change or adjust the operating frequency and this product is set for the regional frequency table. • This device should be installed and operated with minimum distance 20 cm between the device and your body. And this phrase is for the general statement for consideration of user environment. 			
			

(Only HongKong)

Wireless module(LGSBW41)Specifications			
Wireless LAN		Bluetooth	
Standard	IEEE 802.11a/b/g/n	Standard	Bluetooth Version 4.0
Frequency range	2400 to 2483.5 MHz 5150 to 5250 MHz 5725 to 5850 MHz	Frequency range	2400 to 2483.5 MHz
<ul style="list-style-type: none"> • Because band channel used by the country could be different, the user can not change or adjust the operating frequency and this product is set for the regional frequency table. • This device should be installed and operated with minimum distance 20 cm between the device and your body. And this phrase is for the general statement for consideration of user environment. 			



WARNING -This is a class A product. In a domestic environment this product may cause radio interference in which case the user may be required to take adequate measures.

The product label contains necessary information for after-service.

Model _____

Serial No. _____

Please note that a momentary noise during power on/off is not abnormal and does not mean a device malfunction.